

PRACTICAL APPROACH
IN CHEMISTRY

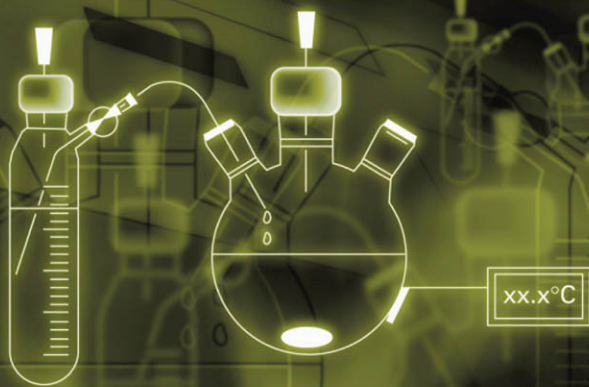

Polymer Chemistry

Edited by
Fred J. Davis



The Practical Approach in Chemistry Series

SERIES EDITORS

L. M. Harwood

*Department of Chemistry
University of Reading*

C. J. Moody

*Department of Chemistry
University of Exeter*

The Practical Approach in Chemistry Series

Organocopper reagents

Edited by Richard J. K. Taylor

Macrocyclic synthesis

Edited by David Parker

High-pressure techniques in chemistry and physics

Edited by Wilfried B. Holzapfel and Neil S. Isaacs

Preparation of alkenes

Edited by Jonathan M. J. Williams

Transition metals in organic synthesis

Edited By Susan E. Gibson (née Thomas)

Matrix-isolation techniques

Ian R. Dunkin

Lewis acid reagents

Edited by Hisashi Yamamoto

Organozinc acid reagents

Edited by Paul Knochel and Philip Jones

Amino acid derivatives

Edited by Graham C. Barrett

Asymmetric oxidation reactions

Edited by Tsutomu Katsuki

Nitrogen, oxygen and sulfur ylide chemistry

Edited by J. Stephen Clark

Organophosphorus reagents

Edited by Patrick J. Murphy

Polymer chemistry

Edited by Fred J. Davis

Polymer Chemistry

A Practical Approach

Edited by

FRED J. DAVIS

*The School of Chemistry,
The University of Reading, UK*

OXFORD
UNIVERSITY PRESS

OXFORD

UNIVERSITY PRESS

Great Clarendon Street, Oxford OX2 6DP

Oxford University Press is a department of the University of Oxford.
It furthers the University's objective of excellence in research, scholarship,
and education by publishing worldwide in
Oxford New York

Auckland Bangkok Buenos Aires Cape Town Chennai
Dar es Salaam Delhi Hong Kong Istanbul Karachi Kolkata
Kuala Lumpur Madrid Melbourne Mexico City Mumbai Nairobi
São Paulo Shanghai Taipei Tokyo Toronto

Oxford is a registered trade mark of Oxford University Press
in the UK and in certain other countries

Published in the United States
by Oxford University Press Inc., New York

© Oxford University Press 2004

The moral rights of the author have been asserted
Database right Oxford University Press (maker)

First published 2004

All rights reserved. No part of this publication may be reproduced,
stored in a retrieval system, or transmitted, in any form or by any means,
without the prior permission in writing of Oxford University Press,
or as expressly permitted by law, or under terms agreed with the appropriate
reprographics rights organization. Enquiries concerning reproduction
outside the scope of the above should be sent to the Rights Department,
Oxford University Press, at the address above

You must not circulate this book in any other binding or cover
and you must impose this same condition on any acquirer

A catalogue record for this title is available from the British Library
Library of Congress Cataloging in Publication Data
(Data available)

ISBN 0 19 850309 1 (Hbk)

10 9 8 7 6 5 4 3 2 1

Typeset by Newgen Imaging Systems (P) Ltd., Chennai, India
Printed in Great Britain
on acid-free paper by
Biddles Ltd, King's Lynn

*To my wife Jacqueline, my children Charlie, William, Gracie, and
Briony, and to my late mother Mrs Josephine P. Davis*

This page intentionally left blank

Preface

It is some time since Laurence Harwood suggested to me the idea of this volume of the *Practical Approach in Organic Chemistry* series, and whilst initially I could see the value of such a contribution, as the subsequent delay in production testifies, I have had some difficulty in transposing this topic to a relatively small text. There are many scientific publications devoted entirely to the area of polymer synthesis, with tens of thousand pages devoted to the topic in the scientific literature every year I have focused on those aspects of the topic which I find interesting, and consequently there are certainly many omissions. I hope, however, that the examples I have included will give a flavour of what can be achieved (generally without recourse to highly specialized equipment) in terms of the development of novel macromolecular systems. As with all the volumes in the Practical Approach Series, this book aims to provide a detailed and accessible laboratory guide suitable for those new to the area of polymer synthesis. The protocols contained within this manuscript provide information about solvent purification, equipment and reaction conditions, and list some potential problems and hazards. The latter point is particularly important and in most instances I have referred to the manufacturers' safety data sheet (MSDS, which companies such as Merck and Aldrich provide on-line); however, often these vary in detail from source-to-source and from time-to-time, and of course local rules always must take precedence.

I am particularly indebted to the contributors to this work for their excellent efforts and prompt responses to my requests. I am also grateful to my postgraduate students, particularly Dario Castiglione and Vidhu Mahendra for checking some of the experimental details, and to my colleague at Reading Dr Wayne Hayes for his constant enthusiasm and advice.

Fred J. Davis
Reading
December 2003

This page intentionally left blank

Contents

<i>Contributors</i>	xiii
<i>Abbreviations</i>	xvii
1. Polymer characterization	1
<i>Ian L. Hosier, Alun S. Vaughan, Geoffrey R. Mitchell, Jintana Siripitayananon, and Fred J. Davis</i>	
1. Introduction	1
2. Synthetic routes to polymers	2
3. Molecular weight determination	4
4. Composition and microstructure	7
5. Optical microscopy	9
6. Electron microscopy	11
7. Analytical microscopy	14
8. Scanning probe microscopy	16
9. Thermal analysis	18
10. Molecular relaxation spectroscopy	21
11. X-ray and neutron scattering methods	24
12. Conclusions	32
References	33
2. General procedures in chain-growth polymerization	43
<i>Najib Aragra, Dario C. Castiglione, Paul R. Davies, Fred J. Davis, and Sangdil I. Patel</i>	
1. Introduction	43
2. Free-radical chain polymerization	44
3. Anionic polymerization	67
4. Ring-opening polymerizations initiated by anionic reagents	83
5. Coordination polymers	90
6. Conclusions	95
References	95

Contents

3. Controlled/‘living’ polymerization methods	99
<i>Wayne Hayes and Steve Rannard</i>	
1. Introduction	99
2. Covalent ‘living’ polymerization: group transfer polymerization	101
3. Controlled free-radical polymerizations mediated by nitroxides	109
4. Controlled free-radical polymerizations: atom transfer free-radical polymerizations (ATRP) and aqueous ATRP	116
References	123
4. Step-growth polymerization—basics and development of new materials	126
<i>Zhiqun He, Eric A. Whale, and Fred J. Davis</i>	
1. Introduction	126
2. The synthesis of an aromatic polyamide	127
3. Preparation of a main-chain liquid crystalline poly(ester ether) with a flexible side-chain	130
4. Non-periodic crystallization from a side-chain bearing copolyester	135
5. A comparison of melt polymerization of an aromatic di-acid containing an ethyleneglycol spacer with polymerization in a solvent and dispersion in an inorganic medium	138
References	143
5. The formation of cyclic oligomers during step-growth polymerization	145
<i>Abderrazak Ben Haida, Philip Hodge, and Howard M. Colquhoun</i>	
1. Introduction	145
2. Synthesis and extraction of cyclic oligomers of poly(ether ketone)	146
3. Synthesis of some sulfone-linked paracyclophanes from macrocyclic thioethers	152
4. Summary	156
References	156

Contents

6. The synthesis of conducting polymers based on heterocyclic compounds	158
<i>David J. Walton, Fred J. Davis, and Philip J. Langley</i>	
1. Introduction	158
2. Electrochemical synthesis	159
3. Synthesis of polypyrrole	163
4. Synthesis of polyaniline	178
5. Synthesis of polythiophene	181
6. Conclusions	186
References	186
7. Some examples of dendrimer synthesis	188
<i>Donald A. Tomalia</i>	
1. Introduction	188
2. Excess reagent method	190
3. Protection–deprotection method	193
References	199
8. New methodologies in the preparation of imprinted polymers	201
<i>Cameron Alexander, Nicole Kirsch, and Michael Whitcombe</i>	
1. Introduction	201
2. Sacrificial spacer approach	203
3. Preparation of bacteria-imprinted polymers	210
References	214
9. Liquid crystalline polymers	215
<i>Sangdil I. Patel, Fred J. Davis, Philip M. S. Roberts, Craig D. Hasson, David Lacey, Alan W. Hall, Andreas Greve, and Heino Finkelmann</i>	
1. Introduction	215
2. Synthesis of an acrylate-based liquid crystal polymer	217
3. The hydrosilylation reaction: a useful procedure for the preparation of a variety of side-chain polymers	225

Contents

4. Photochemical preparation of liquid crystalline elastomers with a memory of the aligned cholesteric phase	229
5. Defining permanent memory of macroscopic global alignment in liquid crystal elastomers	234
6. Summary	244
References	244
Index	246

Contributors

CAMERON ALEXANDER

School of Pharmacy and Biomedical Sciences, University of Portsmouth, White Swan Road, Portsmouth, PO1 2DT, UK

NAJIB ARAGRAG

The Department of Chemistry, The University of Reading, Whiteknights, Reading, Berkshire, RG6 6AD, UK

ABDERRAZAK BEN HAIDA

Department of Chemistry, University of Manchester, Oxford Road, Manchester, M13 9PL, UK

DARIO C. CASTILIGLIONE

The Department of Chemistry, The University of Reading, Whiteknights, Reading, Berkshire RG6 6AD, UK

HOWARD COLQUHOUN

The Department of Chemistry, The University of Reading, Whiteknights, Reading, Berkshire RG6 6AD, UK

PAUL R. DAVIES

School of Chemistry, The University of Reading, Whiteknights, Reading, Berkshire RG6 6AD, UK

FRED J. DAVIS

School of Chemistry, The University of Reading, Whiteknights, Reading, Berkshire RG6 6AD, UK

HEINO FINKELMANN

Institut für Makromolekulare Chemie, Universität Freiburg, Stefan-Meier-Strasse 31, Freiburg D-79104, Germany

ANDREAS GREVE

Institut für Makromolekulare Chemie, Universität Freiburg, Stefan-Meier-Strasse 31, Freiburg D-79104, Germany

ALAN W. HALL

The Department of Chemistry, The University of Hull, Kingston-upon-Hull, Cottingham Road, Hull HU6 7RX, UK

CRAIG D. HASSON

JJ Thomson Physical Laboratory, PO Box 220, Whiteknights, Reading RG6 6AF, UK

Contributors

WAYNE HAYES

The Department of Chemistry, The University of Reading, Whiteknights, Reading, Berkshire RG6 6AD, UK

ZHIQUN HE

Institute of Optoelectronic Technology, Beijing Jiaotong University, Beijing 100044, China

PHILIP HODGE

Department of Chemistry, University of Manchester, Oxford Road, Manchester, M13 9PL, UK

IAN L. HOSIER

School of Electronics and Computer Science, University of Southampton, SO17 1BJ, UK

NICOLE KIRSCH

Bioorganic and Biophysical Chemistry Laboratory, Department of Chemistry and Biomedical Sciences, University of Kalmar, SE-391 82 Kalmar, Sweden

GEOFFREY R. MITCHELL

JJ Thomson Physical Laboratory, PO Box 220, Whiteknights, Reading RG6 6AF, UK

PHILIP J. LANGLEY

School of Chemistry, The University of Reading, Whiteknights, Reading, Berkshire RG6 6AD, UK

SANGDIL I. PATEL

School of Chemistry, The University of Reading, Whiteknights, Reading, Berkshire RG6 6AD, UK

PHILIP M. S. ROBERTS

JJ Thomson Physical Laboratory, PO Box 220, Whiteknights, Reading RG6 6AF, UK

DAVID LACEY

The Department of Chemistry, The University of Hull, Kingston-upon-Hull, Cottingham Road, Hull HU6 7RX, UK

STEVE RANNARD

Unilever Research Port Sunlight Laboratory, Quarry Road East, Bebington, Wirral, CH63 3JW, UK

JINTANA SIRPITAYANANON

Biopolymers Research Unit, Department of Chemistry, Faculty of Science, Chiang Mai University, 50200, Thailand

Contributors

DONALD A. TOMALIA

Michigan Molecular Institute, 1910 West St. Andrews Road, Midland,
MI 48640-2696, USA

ALUN S. VAUGHAN

School of Electronics and Computer Science, University of Southampton, SO17
1BJ, UK

DAVID J. WALTON

School of Science and the Environment, Coventry University, Priory Street,
Coventry CV1 5FB, UK

ERIC A. WHALE

JRA Technology Ltd, JRA House, Taylors Close, Marlow, Buckinghamshire
SL7 1PR, UK

MICHAEL J. WHITCOMBE

Institute of Food Research, Norwich Research Park, Colney, Norwich, NR4
7UA, UK

This page intentionally left blank

Abbreviations

AFM	atomic force microscopy
AIBN	2,2'-Azobisisobutyronitrile
ATRP	atom transfer free-radical polymerization
BHT	2,6-Di- <i>t</i> -butylphenol
CCD	charge coupled device
CFI	contact force imaging
CLSM	confocal laser scanning microscopy
DBE	dibutyl ether
DIC	differential interference contrast
DMF	dimethylformamide
DMSO	dimethylsulfoxide
DMTA	dynamic mechanical thermal analysis
DP	degree of polymerization
DSC	differential scanning calorimetry
DTA	differential thermal analysis
DVB	divinylbenzene
EELS	electron energy loss spectroscopy
EGDMA	ethyleneglycol dimethacrylate
FTIR+A28	Fourier transform infra-red.
GPC	gel permeation chromatography
GTP	group transfer polymerization
HPLC	high performance liquid chromatography
IR	infra-red
LCST	lower critical solution temperature
LED	Light emitting diode
LSCE	Liquid single crystalline elastomer
LSM	Laser scanning microscope
MALDI-TOF	matrix-assisted laser desorption ionization—time of flight
MAO	methylaluminumoxane
MBPI	methylene bis(phenyl isocyanate)
MDSC	Modulated DSC
MHTBO	1-methyl-4-hydroxymethyl-2,6,7-trioxabicyclo-[2,2,2]-octane
MIP	Molecularly imprinted polymers
MOPS	(3-[<i>N</i>]-morpholino)propylsulfonic acid
NIPA	<i>N</i> -Isopropyl acrylamide
NMP	<i>N</i> -methyl pyrrolidone
NMR	nuclear magnetic resonance

Abbreviations

PAA	poly(allylamine)
PAMAM	poly(amidoamine)
PEEK	poly(ether ether ketone)
PEK	poly(ether ketone)
PET	Polyethylene terephthalate
PHB	poly(hydroxybutyrate)
PMMA	polymethylmethacrylate
PPV	poly(phenylenevinylene)
PPTS	Pyridine- <i>p</i> -toluenesulfonate
PTFE	poly(tetrafluoroethylene)
PVC	polyvinylchloride
PVF ₂	poly(vinylidene fluoride)
RAFT	reversible addition fragmentation chain transfer
ROMP	ring-opening metathesis polymerization
SCE	standard calomel electrode
SEC	size exclusion chromatography (=GPC)
SEM	scanning electron microscopy
SPM	scanning probe microscopy
STEM	scanning transmission electron microscopy
STM	scanning tunnelling microscopy
TASHF ₂	tris(dimethylamino) sulfonium bifluoride
TBABB	tetra- <i>n</i> -butyl ammonium bibenzoate
TEM	transmission electro microscopy
TEMPO	2,2,6,6-Tetramethylpiperidiny-1-oxyl
THF	tetrahydrofuran
TLC	thin layer chromatography
UV-Vis	Ultraviolet-Visible

Polymer characterization

IAN L. HOSIER, ALUN S. VAUGHAN, GEOFFREY R. MITCHELL,
JINTANA SIRIPITAYANANON, and FRED J. DAVIS

1. Introduction

Polymer science is, of course, driven by the desire to produce new materials for new applications. The success of materials such as polyethylene, polypropylene, and polystyrene is such that these materials are manufactured on a huge scale and are indeed ubiquitous. There is still a massive drive to understand these materials and improve their properties in order to meet material requirements; however, increasingly polymers are being applied to a wide range of problems, and certainly in terms of developing new materials there is much more emphasis on control. Such control can be control of molecular weight, for example, the production of polymers with a highly narrow molecular weight distribution by anionic polymerization.¹ The control of polymer architecture extends from block copolymers to other novel architectures such as ladder polymers and dendrimers (see Chapter 7).^{2,3} Cyclic systems can also be prepared^{4,5} (see Chapter 5), usually these are lower molecular weight systems, although these also might be expected to be the natural consequence of step-growth polymerization at high conversion.⁶

Polymers are used in a wide range of applications, as coatings, as adhesives, as engineering and structural materials, for packaging, and for clothing to name a few. A key feature of the success and versatility of these materials is that it is possible to build in properties by careful design of the (largely) organic molecules from which the chains are built up. For example, rigid aromatic molecules can be used to make high-strength fibres, the most high-profile example of this being Kevlar[®]; rigid molecules of this type are often made by simple step-growth polymerization⁷ and offer particular synthetic challenges as outlined in Chapter 4. There is now an increasing demand for highly specialized materials for use in for example optical and electronic applications and polymers have been singled out as having particular potential in this regard. For example, there is considerable interest in the development of polymers with targeted optical properties such as second-order optical non-linearity,⁸ and in conducting polymers (see Chapter 6) as electrode materials,⁹

as a route towards supercapacitors¹⁰ and as electroluminescent materials.¹¹ Polymeric materials can also be used as an electrolyte in the design of compact batteries.¹²

A particular feature of polymers is the possibility of linking together separate chains to form networks. Such cross-links can be introduced by copolymerization of a monofunctional monomer such as styrene with a difunctional monomer such as divinylbenzene.¹³ If the degree of cross-linking is high, the resulting network becomes rather rigid and intractable. A particularly important feature of this is that the network produced interacts only slightly with solvents; as a consequence the material can be readily separated from organic solutions. Such materials are increasingly important in a range of areas: these include polymer-supported reactions, such as those in peptide synthesis,¹⁴ combinatorial chemistry,¹⁵ and catalysis;¹⁶ and molecular separation where imprinted polymers offer a powerful route to highly specific separation.¹⁷ Examples of routes to imprinted polymers are included in Chapter 8. Lightly cross-linked materials have also attracted considerable interest, since the potential for reversible deformation introduces the possibility of a number of novel properties. Such materials include solvent swollen systems (wet gels)^{18,19} and liquid crystalline elastomers;²⁰ the former systems are often rather simple to prepare, while the latter may be formed from quite complex monomers²¹ (as outlined in Chapter 9).

2. Synthetic routes to polymers

With the vast commercial importance of polymers it is perhaps not surprising that there have been huge developments in synthetic methodology. The scope of the field is such that it is impossible to provide a comprehensive review of all these developments here, but a few examples might serve to illustrate the area. Free-radical polymerization remains a popular synthetic method, but even within the simplicity of this system there have been major developments, for example, the use of supercritical CO₂ as a solvent²² has huge potential. The development of polymer-supported reagents has necessitated a tailoring of suspension polymerizations,^{13,23} to suit particular needs, for example, to produce macroporous resins, i.e. resins which have a well-defined structure even in the dry state. Emulsion polymerizations have even been undertaken in space²⁴ to produce extremely uniform 10 μm spheres. Perhaps the most exciting development in the area of free-radical polymer chemistry is the introduction of control into free-radical polymerization; initially Moad²⁵ and later others²⁶ have developed a way of controlling free-radical polymerizations using stable nitroxide radicals.²⁷ Atom Transfer Free Radical Polymerization (ATRP)²⁸ is a more recent²⁹ analogous method involving stable radical intermediates. A particularly interesting feature of this latter technique is its adaptation to hydrophilic monomers in aqueous systems, thus providing living polymers with the ability to tolerate the presence of water.³⁰

The development of ATRP has supplemented rather than superseded anionic polymers in terms of control of polymer structure; anionic polymerization is still the method of choice for preparing polymers with narrow molecular weight distribution and controlled structures. This is largely because the way in which polymeric chains may be produced that do not undergo termination is well understood.³¹ There is, however, clearly a complex relationship between the solvent, the monomer, and the counterions present and a number of techniques such as ligated anionic polymerization have developed, in this case to ensure the growing chains are living.³² Block copolymers are particularly important,³³ for example, triblock copolymers may act as thermoplastic elastomers. The styrene-butadiene-styrene copolymer is commercially important, but other systems include liquid crystalline thermoplastic elastomers.³⁴ Star-shaped polymers can be made by coupling the anionic chain ends with another reactive unit³⁵ (e.g. SiCl_4); alternatively polymers with functional end groups can be made by reacting the anion with simple molecules such as CO_2 to form an acid terminated chain.³⁶ Other popular methods of producing living polymers include cationic polymerization³⁷ and group-transfer polymerization.^{38,39}

Organometallic chemistry has played an important role in improving synthetic methodology in polymer science,⁴⁰ given the success of classical Ziegler-Natta catalytic systems,^{41,42} it might have been thought that at least for bulk polymers the synthetic problems had been largely solved. However, the development of metallocene catalysts⁴³ has clearly shown that this is not the case.⁴⁴ The application of these catalysts to systems such as polyethylene and polypropylene has proved of immense importance, allowing the formation of new materials⁴⁵ such as a form of polypropylene, which acts as a thermoplastic elastomer.⁴⁶ Of course, metallocenes are not the only inorganic polymerization catalysts under investigation⁴⁷ and this is proving a particularly fruitful area for organometallic chemists. Another well-known organometallic-catalysed polymerization is the ring-opening metathesis polymerization (ROMP).^{48,49} One particularly attractive feature of this is that the catalysts (often ruthenium-based)⁵⁰ are not only highly active but also compatible with most functional groups and easy to use.⁵¹ ROMP has found application in a number of areas, but a particularly interesting one is the preparation of polyacetylene by a precursor route referred to as the 'Durham route'.⁵²

In the organometallic examples cited above, polymerization occurs by a chain-growth mechanism. Increasingly, highly efficient organometallic coupling reactions such as the Stille reaction,⁵³ the Suzuki reaction,^{54,55} and others⁵⁶ are being used for C-C bond formation in polymeric reactions. These polycondensations have been used particularly to form highly conjugated aromatic polymers, for example, the Suzuki reaction can be used to form polyphenylene.⁵⁷ There are various organometallic routes to form polythiophenes.^{58,59} These are particularly useful for unsymmetrical thiophenes since they provide far greater control of the regiochemistry than electrochemical or simple chemical oxidation.

This book is largely concerned with polymer synthesis, and in the following chapters a range of both common and more specialized synthetic methods used to produce macromolecular systems is given. However, it must be noted that polymers are unlike simple low molecular weight materials in that they are not built-up from a single structure, but rather a mixture of similar materials differing, for example, in the number of monomer units attached to the chain, or the stereochemistry around a stereogenic carbon atom. Thus, characterization is often something of a statistical exercise. In addition, because of the huge interest in polymers as materials, often more detailed information about properties such as orientation, thermal characteristics, and morphology are required. In the following sections some of the methods used to characterize polymers are described.

3. Molecular weight determination

It is important that the molecular weight characteristics of polymers can be accurately determined.⁶⁰ Of course, the precise molecular weight determined will depend on the technique used, thus techniques that rely on the measurement of colligative properties, such as osmotic pressure, count the number of molecules in solution and, therefore, give the number average molecular weight M_n (Eqn (1)), while other techniques, most notably, light scattering provide an average value based on the weight fractions of molecules of a given mass, to give the weight average molecular mass M_w (Eqn (2)). A simple and commonly used technique for assessing the molecular weight of a polymer is viscometry. In this technique, the time is measured for a dilute solution of polymer to flow through a capillary. Through measuring the times at various polymer concentrations and comparing with the time obtained for the neat solvent, it is possible to obtain a value for the intrinsic viscosity (or limiting viscosity number) $[\eta]$, which can be related to the molecular weight using the Mark–Houwink–Sakurada relationship (Eqn (3)); where M is the viscosity average molecular weight (eqn (4)) and K and a are constants. Interestingly, the value for a is determined directly by polymer–solvent interactions, for example, in a theta solvent⁶¹ a is 0.5, for rod-like polymers the value can be close to 1.0; thus, like gel permeation chromatography (GPC) the measured molecular weight is related to the hydrodynamic volume of the molecules⁶².

$$M_n = \frac{\sum_{i=0}^{\infty} N_i M_i}{\sum_{i=0}^{\infty} N_i} \quad (1)$$

$$M_n = \frac{\sum_{i=0}^{\infty} N_i M_i^2}{\sum_{i=0}^{\infty} N_i M_i} \quad (2)$$

1: Polymer characterization

$$[\eta] = KM^a \quad (3)$$

$$\left[M_n = \frac{\sum_{i=0}^{\infty} N_i M_i^{1+a}}{\sum_{i=0}^{\infty} N_i M_i} \right]^{1/a} \quad (4)$$

There is a range of techniques used to determine the molecular weight, including the two cited above,^{63,64} but the most common method is GPC (or size-exclusion chromatography, SEC).^{65,66} This chromatographic technique is based upon size-exclusion phenomena and enables the separation and assessment of polydisperse systems, such as polymers and multi-component biological samples.⁶⁷ In this method, polymers are separated by virtue of their hydrodynamic volume. The technique involves passing a solution of the polymer through a column packed with a porous solid phase (often polystyrene cross-linked with divinylbenzene); small molecules can access these pores rather more easily than larger molecules, as a consequence, these larger molecules are eluted first. The technique does not give absolute values, but rather gives relative ones; and therefore requires calibration with a series of polymers of known molecular weight. Since the technique relies on the size of the polymer in solution, both the solvent and the type of polymer are important. Thus data obtained for polystyrene in chloroform does not exactly match data for polystyrene dissolved in tetra hydrofuran (THF). Similarly a sample of poly(methyl methacrylate) in THF should not strictly be compared with polystyrene standards. Of course, when synthesizing novel polymers it is not possible to have matching standards, and considerable effort has been spent finding solutions to this problem. One solution that is particularly popular is the use of GPC in conjunction with a viscosity detector, a method known as universal calibration.⁶⁸ This technique makes use of a broadly linear relationship between the elution volume and the product of the intrinsic viscosity and molecular weight. More recently GPC systems fitted with light scattering detectors have become more popular.⁶⁹ One particularly important feature of this method is that it provides a good indication of the distribution of molecular weights within the sample. Figures 1.1 and 1.2 illustrate this. The former shows traces obtained from first- and second-generation dendrimer samples,⁷⁰ which are essentially monodisperse by Matrix-assisted laser desorption ionization-time of flight (MALDI-TOF) (in fact the GPC has insufficient resolution to provide an accurate picture of the molecular weight distribution in these samples). Figure 1.2, in contrast, shows the molecular weight distribution obtained from an attempt to form a styrene-acrylate diblock copolymer using anionic polymerization (see Chapter 2). Not only is the polydispersity index rather large (at 2.96), but also the shape of the curve is not what might be expected from a homogeneous sample; clearly there has been some problem in the preparation here.

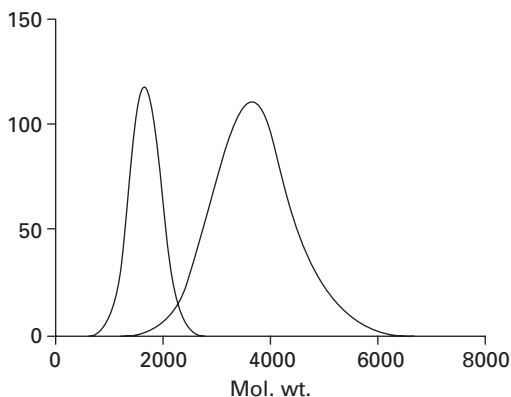

Fig. 1.1 GPC data obtained from polyaromatic dendrimers possessing a repetitive amide-ester coupling sequence.

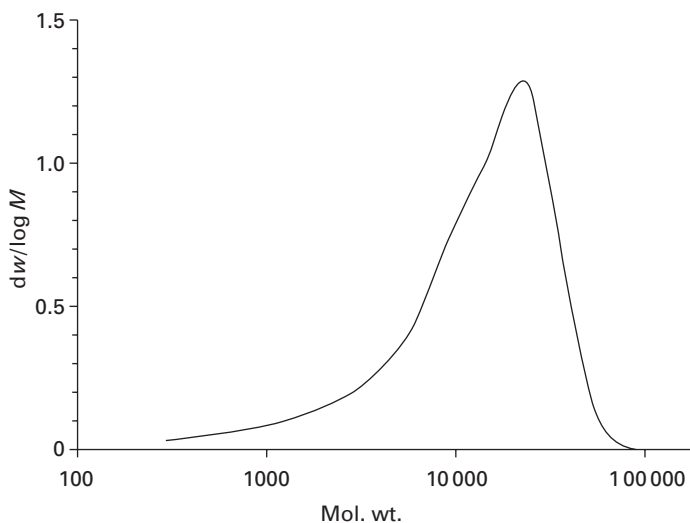

Fig. 1.2 GPC data obtained from an attempt to form a styrene-acrylate diblock copolymer using anionic polymerization. Both the polydispersity index (2.96) and the shape of the curve suggest that the desired homogeneous product has not been formed.

MALDI-TOF^{71,72} mass spectral analysis is becoming increasingly important as a method for the determination of molecular weights of synthetic polymers, since in comparison to traditional methods (such as GPC), the results can be obtained in a few minutes. In the simplest terms, the macromolecule is dispersed in a UV-absorbing matrix, and becomes volatilized when subjected to a pulse of laser energy; the volatile particles are then ionized and subsequently

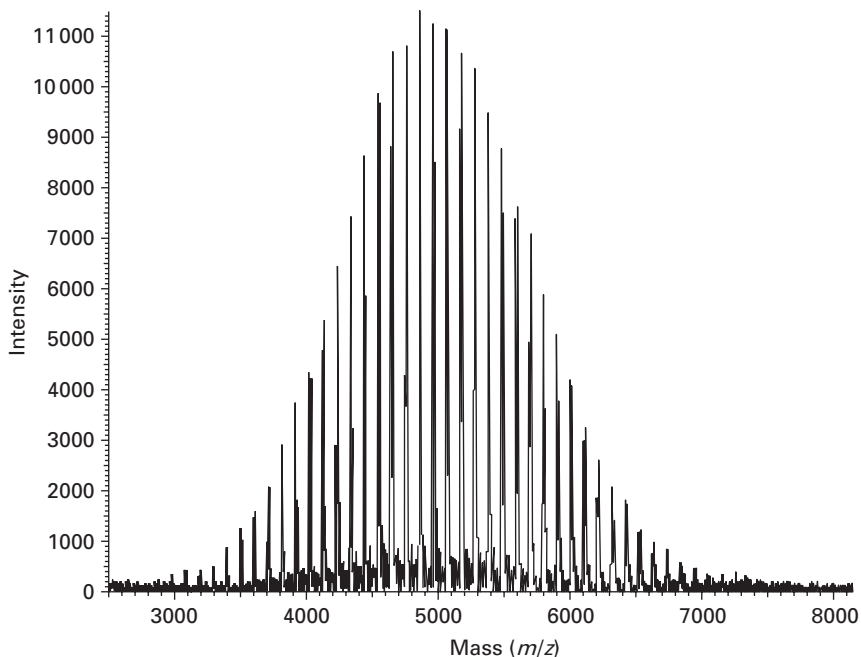

Fig. 1.3 Spectrum obtained using MALDI-TOF of a sample of polystyrene using a dithranol matrix with silver trifluoroacetate added. (The peak masses are from the polymer chains combined with a silver ion.)

accelerated by an electric field to the detector. The masses are determined by the time of flight. Thus, this technique is a very powerful analytical tool, allowing chemists access to molecular weight data in ‘real time’ rather than providing routine post-polymerization characterization.⁷³ In addition, the technique provides direct access to molecular weight data rather than average values that need to be compared with suitable standards (as is the case for GPC). The soft-ionization may also allow the direct observation of different end groups. However, sample preparation has proven to be the key step to the success of the analyses⁷⁴ and particular care needs to be taken in the choice of matrix. However, excellent results can be obtained as can be seen in Figure 1.3.

4. Composition and microstructure

¹H and ¹³C NMR are vital tools for the characterization of polymeric materials. Solid-state NMR is frequently used to study such systems, but the brief discussion here will be confined to NMR in solution.⁷⁵ ¹H NMR provides information relating to composition. This is particularly important for copolymers where such information may, for example, be used to determine reactivity ratios⁷⁶ and, for vinyl polymers, can give an immediate indication of the presence of unreacted monomer. In some cases, for example,

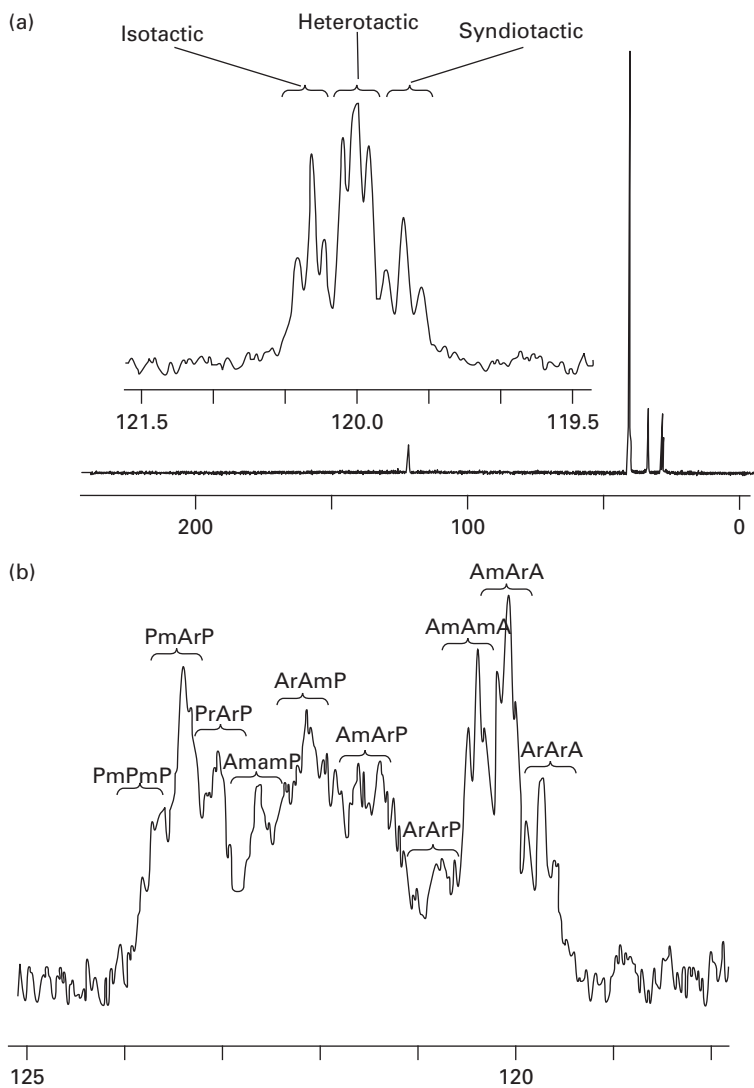

Fig. 1.4 (a) NMR spectra of poly(acrylonitrile) showing the nitrile region. The complex pattern arises as a consequence of the various configurations around the nitrile group. Thus the polymer tacticity can be ascertained. (b) NMR spectrum in the ^{13}C region of acrylonitrile(A)/2-vinyl pyridine (P) copolymer (70 : 30 feedstock concentration). The signals at low field correspond to AAA triads, those at slightly higher field correspond to AAP triads, and those at even higher field correspond to PAP triads.

poly(methyl methacrylate), the tacticity of the polymer can be readily established from the ^1H NMR alone.⁷⁷ However, it is often found that line widths in the ^1H spectrum are relatively large compared with differences in chemical shift for different structural features. In such cases, details about tacticity may be obtained from the ^{13}C NMR spectrum. Thus, Figure 1.4(a) shows the nitrile resonance from a sample of polyacrylonitrile; the various stereochemical arrangements can be resolved and assigned to various pentad sequences. In contrast, features from the polymer backbone of a polyacrylate may not be so apparent.⁷⁸

For copolymer systems NMR is used not only to determine compositions and thus the relative reactivity of the two monomers,⁷⁶ but also to determine monomer sequences within the chains.⁷⁹ This enables one to distinguish between, for example, a block and an alternating copolymer and may be readily related to the reactivity ratios.⁸⁰ Figure 1.4(b) shows the nitrile region of the ^{13}C NMR spectrum obtained from a copolymer of acrylonitrile and 2-vinyl pyridine (see Chapter 2, Protocol 4). Quantification of such microstructural features requires particular care since integrated intensities in ^{13}C NMR depend not only on the number of molecules containing a particular arrangement, but also on the nature of the environment. That being said, the similarity of most of the environments present in such microstructural variations are such that integrated intensities can be used to establish the presence of various sequences of comonomer units.^{81,82}

NMR is not, of course, the only analytical technique used to establish the composition and microstructure of polymeric materials. Others include^{75,66} ultraviolet–visible spectroscopy (UV–Vis), Raman spectroscopy, and infrared (IR) spectroscopy. IR and Raman spectroscopy are particularly useful, when by virtue of cross-linking (see, e.g. Chapter 9), or the presence of rigid aromatic units (see Chapter 4), the material neither melts nor dissolves in any solvent suitable for NMR. The development of microscopy based on these spectroscopic methods now makes such analysis relatively simple (see below). Space precludes a detailed account of these and many other techniques familiar to the organic chemist. Instead we focus for the remainder of the chapter on some of the techniques used to characterize the physical properties of polymeric materials.

5. Optical microscopy

The optical microscope is a sophisticated instrument capable of providing images with a resolution of the order of 1 μm , molecular information via birefringence, and chemical information via colour changes or through the use of specific dyes. When these factors are combined with relative ease of sample preparation (c.f. electron microscopy) and purchase cost, optical microscopy is a powerful technique for the study of many materials, particularly those that transmit in the visible region of the spectrum.

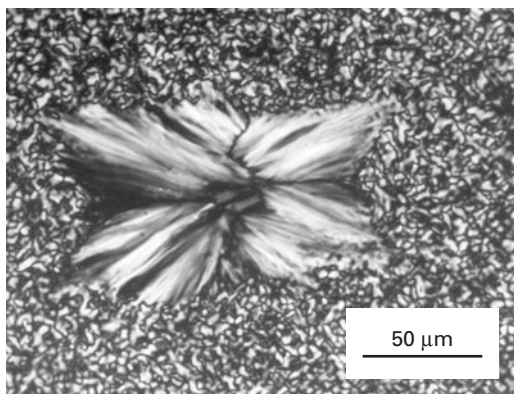

Fig. 1.5 Polarized transmitted light optical micrograph. A lamellar aggregate of the long chain alkane C₂₉₄H₅₉₀ is shown, surrounded by quenched material.

In transmitted light microscopy, a beam of light passes through a transparent medium, and this may change it in a number of ways. The amplitude may be modified from place to place as a result of variations in absorption or scattering characteristics, and this can be exploited to form an image using bright and dark field microscopy. In these techniques, it is spatial variations in the amplitude of the light entering the objective lens that results directly in image contrast. When transparent thin film samples are examined, including polymers, the structures within them can result, not in spatial variations in the amplitude of the transmitted beam but, rather, spatial variations in phase and, consequently, such phase objects are not visible to the naked eye. In phase contrast microscopy, these phase differences are converted into amplitude contrast rendering phase object visible. Possibly the most widely used transmission technique for the study of polymers is polarized light microscopy (Figure 1.5). This exploits the fact that polymer molecules are intrinsically anisotropic structures and, therefore, under many circumstances, give rise to optically anisotropic materials. When a beam of plane polarized light passes through such a system, its polarization state will, in general, be altered. In the case of crystalline or liquid crystalline materials, the molecular anisotropy gives rise directly to birefringent materials. The study of polymeric spherulites is an area that has exploited the attributes of polarized light microscopy for many decades.^{83–85} Other examples include flowing polymer solutions, sheared polymer melts, and glassy artefacts that are exposed to a mechanical stress.

In general, all the above techniques can also be used, with varying degrees of success, in reflected as well as transmitted modes. Although the least promising of these would appear to be polarized light microscopy, since this requires that the beam pass through the specimen, polarizing techniques can be powerful. For example, if the sample is relatively thin, incident illumination can be used along with a reflecting substrate to produce polarized light images. However,

the true utility of reflected light microscopy concerns samples that are too thick or too highly absorbing to be suited to transmission techniques, but where the surface topography contains useful structural information. In differential interference contrast (DIC) microscopy, the surface of the sample is illuminated by two displaced polarized beams, which, on recombination, interfere with one another. If the surface is illuminated with white light, the above results in surface topography (the local gradient \equiv rate of change of optical path difference) can be visualized as optical interference colours.

For more details on the above imaging modes and more specialized optical techniques the reader is referred to *Applied polymer light microscopy* by D. A. Hemsley.⁸⁶

6. Electron microscopy

Electron microscopy can be divided into two areas; transmission electron microscopy (TEM) involving thin specimens and the scanning electron microscope (SEM) involving bulk samples.⁸⁷ However, whenever a polymer is exposed to a beam of electrons, energy is dissipated in the specimen, bonds are broken, and permanent chemical and physical changes result.⁸⁸⁻⁹¹ The extent to which these effects prevent examination is then largely a matter of the material itself and information required.⁹²⁻⁹⁴

For TEM, a basic requirement is that the specimen is sufficiently thin for transmission of the electron beam (~ 100 nm). Thus, intrinsically thin specimens⁹⁵⁻⁹⁹ can be examined directly, or after dispersion upon a support film, but, generally, the geometry of the sample must be changed. For polymers, ultramicrotomy¹⁰⁰ is the most direct means of achieving this, but the cutting process can be far from straightforward, involving appreciable deformation of the specimen. Alternative techniques include casting films from solution,¹⁰¹ *in situ* crystallization,¹⁰² mechanical elongation,¹⁰³ and fragmentation.⁹³

In the TEM, image contrast depends upon variations in atomic number (Z-contrast), variations in thickness (thickness contrast) and Bragg diffraction (diffraction contrast). In the case of polymers, it is the first of these that is most widely exploited. In materials such as conducting polymers and certain blends, compositional variations can lead to meaningful contrast.^{104,105} Elsewhere, image contrast can be induced by chemical treatment of the specimen, and many different stains have also been developed to this end. All of these rely upon the incorporation of electron-dense elements into the structure at particular sites, either through specific chemical reactions or just physical absorption. Consequently, image contrast may reflect chemical variations within the specimen or just the local physical structure (amorphous compared with crystals). However, while staining is a proven approach, it is not without its problems; the aggressive nature of most reagents can result in artefacts¹⁰⁶ and, where structural features are smaller than the thickness of the TEM specimen, images can be difficult to interpret. Common polymeric stains

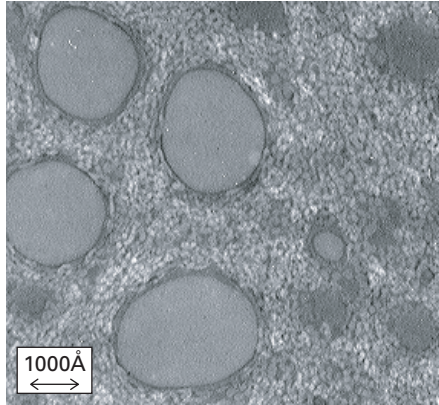

Fig. 1.6 TEM image of a RuO_4 -stained thin film of an atactic polystyrene/Kraton G1650 blend containing 30% polystyrene. Swollen styrene domains can be seen within the block copolymer together with the larger phase-separated polystyrene regions.

include osmium tetroxide (OsO_4) (which is widely applied to unsaturated block copolymers¹⁰⁷ and rubber modified systems¹⁰⁸), ruthenium tetroxide (RuO_4) (a versatile stain that has been applied with success to many different polymer types^{109–112}), chlorosulfonic acid (a means of staining ethylene-based systems¹¹³) and phosphotungstic acid (which tends to be used in conjunction with systems containing polyamides¹¹⁴). Where the chemistry of the polymer is inappropriate, additional prior treatment of the specimen can be employed to modify it in some way; electron irradiation¹¹⁵ and chemical pre-treatments¹¹⁶ have been used with success, as has negative staining^{117–119} (Figure 1.6).

An alternative means of generating a thin specimen in which the local transmission of the incident electron beam varies in relation to structural features is surface replication. Although numerous variants exist, replication involves the oblique evaporation of some electron-dense metal onto the sample surface, so-called shadowing (to give image contrast), followed by the production of a thin, transparent support film (typically carbon). In this way, surface topography is translated via the non-uniform distribution of shadow metal into image contrast. Although fracturing the sample can be a simple means of producing surface texture that is related to underlying structure, fracture surfaces can also contain fractography features which can be misinterpreted,^{120,121} can be prone to bias,¹²² and are often too rough to allow the production of good quality replicas.¹²³ Etching has long been used to reveal structural features in metallurgy¹²⁴ to remove material from the specimen in such a way that surface relief develops, which is simply related to the underlying microstructure. In the case of polymers, etching procedures can be divided into a number of distinct classes. In solvent etching, one component of the microstructure is dissolved, leaving the other preserved in its original form. Although there are many examples of solvents being used to treat single component polymer systems in

1: Polymer characterization

order to expose structural details,¹²⁵ the propensity for polymers to swell means that this approach is most safely applied to blend systems.¹²⁶ Afshari *et al.*¹²⁷ described an interesting study of polypropylene/polyamide 6 fibre systems, in which formic acid was used to remove the nylon fibres from the polypropylene matrix, decalin was used to dissolve the polypropylene matrix, leaving the fibres, whilst a fluorescent dye was used in conjunction with laser scanning confocal microscopy to study the fibres *in situ*. In contrast to selective dissolution, chemical etching involves material degradation and the subsequent removal of molecular fragments from the sample surface. True chemical etchants include chromic acid and related compounds for systems containing polyolefins or poly(vinylidene fluoride) (PVF₂);^{128–130} sodium ethoxide/ethanol for polyimides,¹³¹ polyurethanes, and poly(ethylene oxide);¹³² aqueous methylamine for poly(hydroxybutyrate) (PHB);¹³³ a number of amines for poly(ethylene terephthalate) and its blends;¹³⁴ and strong aqueous bases^{135,136} and diethylene triamine^{137,138} for systems containing polycarbonates. However, the most versatile procedures are based upon oxidative etching with manganese. The so-called permanganic etchants now form a family of reagents whose chemistry can be varied to suit particular applications;^{130,139} of which polyolefins are an area of particular success. As in the case of staining, etching also involves exposing the specimen to reagents that are capable of inducing artifacts.^{140,141} Consequently, whenever a specimen is exposed to such aggressive reagents, independent corroboration of the results is essential.^{113,122,128,137,142} For further details of the above techniques, see the review articles on solvent and chromic treatments¹⁴³ and permanganic reagents.¹⁴⁴

In the SEM a narrow (~ 10 nm) primary electron beam of the order of 10 keV in energy is scanned across the surface of the specimen and an image is built up pixel by pixel (Figure 1.7). Since it is essential that the charge deposited on the sample surface by the electron beam is able to leak away, for insulating polymers, it is usually desirable to coat the specimen with a conducting film

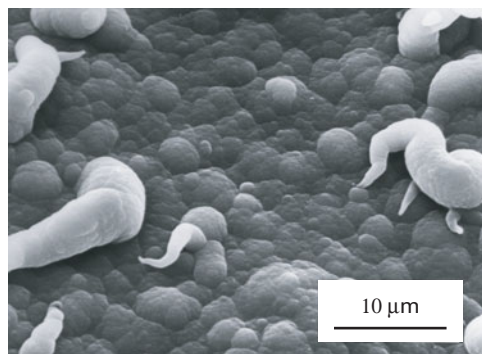

Fig. 1.7 SEM image of the surface of an electrochemically polymerized film of polypyrrole *p*-toluene sulfonate.

prior to examination; sputter coating with gold and chromium are commonly used procedures and each has its merits.^{145,146} Although many processes occur within the sample, for imaging purposes it is convenient to consider two processes; low energy secondary electron emissions (~ 30 eV) and high energy backscattered electrons (~ 10 keV).^{87,147} Since the production of backscattered electrons is dependent upon the local atomic number,¹⁴⁷ these can provide a means of imaging compositional variations within the surface.^{148,149} Nevertheless, it is secondary electron emission and surface topography that is most widely used for imaging, through the direct examination of the external surface of the sample^{118,149} or the production of an internal fracture surface.^{120,150,151} The etching techniques described above can also be naturally exploited, and without the need for successful replica production. That is, the SEM can successfully examine etched surfaces that are too friable or too rough to give good replicas for TEM work.¹⁵² For example, conducting polymers are extremely susceptible to attack by permanganic reagents¹⁵³ and, consequently, the phase structure of a blend containing such a polymer can be imaged clearly after etching away the conducting network to leave a porous surface. A similar result arose during studies involving the enzymatic degradation of PHB.¹⁵⁴ Although staining is most commonly used in conjunction with TEM images, it has also been used in a limited number of studies to enhance contrast in the SEM. For example, polyethylene/carbon fibre composites were treated with chlorosulfonic acid such that, in backscattered SEM images, the fibres appeared light against the stained polyethylene matrix.¹⁵⁵ Backscattered electrons imaging has also been used directly to examine suitably stained polymeric systems.^{156,157} However, when a sufficiently low accelerating voltage is used to produce the primary beam (~ 1 kV), SEM techniques can also produce excellent images of the phase structure of stained blends and block copolymers.^{156,158,159}

The book by Sawyer and Grubb¹¹⁹ provides a more detailed account of electron microscopy of polymers and in particular, an excellent overview of the different sample preparation techniques that have been devised.

7. Analytical microscopy

The above account of optical and electron microscopy focused entirely upon imaging. However, the energy distribution of the emergent radiation also contains useful information. In the TEM, a beam of monochromatic electrons enters the sample, some of which, undergo inelastic scattering. Electron energy loss spectroscopy (EELS) in its various guises¹⁶⁰ is particularly well suited to low- Z systems, such as most polymers. In this way, information on the elemental composition of the sample can be obtained in the conventional TEM or, using more specialized instrumentation, elemental maps can be generated, by energy filtering the bright field image.^{161,162} Inelastic scattering within the sample results in the production of secondary electrons, as above, and X-rays, which include characteristic lines that reflect the elemental

composition of the sample material. In addition to identifying the chemical composition of unknown specimens, energy dispersive spectrometry (EDS) can also be used in conjunction with the scanning transmission electron microscopy (STEM) modes to display the spatial distribution of different elements within the sample. In STEM, a small electron probe is positioned upon the specimen such that element maps are built up pixel by pixel. Similar approaches can be applied in the SEM, although the resulting data can include artefacts that result from the precise interactions between the electrons, X-rays, and the sample. Consequently, in the SEM, EDS is best described as a semi-quantitative technique, particularly when the sample surface is rough.

Infra-red (IR) and Fourier Transform infra-red (FTIR) techniques are widely used to study polymeric materials. As a technique for local analysis, the utility of IR spectroscopy is, however, limited by a combination of physical and practical factors. First, the theoretical resolution of an optical system, outside the near-field regime, will be determined by the wavelength of the radiation involved.¹⁶³ In this respect, IR is not ideal. Second, instrumentally, IR microscopy is limited by the requirement for optical elements that reflect and/or transmit over the wavelength range of interest to manipulate the probe beam, and the need for efficient detection. The former is most easily met simply by the use of masks that determine which region of the sample is to be interrogated. While it is possible to perform IR microscopy in reflection, transmission is often preferable on grounds of sensitivity. However, since polymers absorb heavily at particular regions within the infra-red, this returns us to the same problems of optimum geometry and sample preparation, as discussed above in connection with TEM (Figure 1.8).

Raman microscopy avoids many of the difficulties described above. The sample can be interrogated using a laser operating in the visible or near-infrared regions of the spectrum, such that both the incident and scattered radiation can be manipulated using a modified optical microscope. The wavelengths involved, being much shorter than IR, mean that the lateral spatial resolution is also improved. However, the Raman effect is a weak one; this requires the use of efficient detectors and means that fluorescence can swamp the weak Raman signal, particularly in the case of aged or degraded specimens. Practically, Raman microscopy can be performed in two ways. The sample can be illuminated using a monochromatic (laser) source, as in conventional optical microscopy, and the reflected or transmitted beam can be passed through an optical filter, which transmits only those wavelengths that are of interest, to form a final image. Alternatively, the laser can be focused onto the sample such that data are acquired from a single point; images are then built up pixel by pixel. A principal advantage of the latter approach is that it provides the potential for confocal optics,^{110–113,164} although the true nature of confocal Raman microscopy is a topic of considerable debate¹⁶⁵ despite its wide-spread use in the study of polymer films and laminates.¹⁶⁶

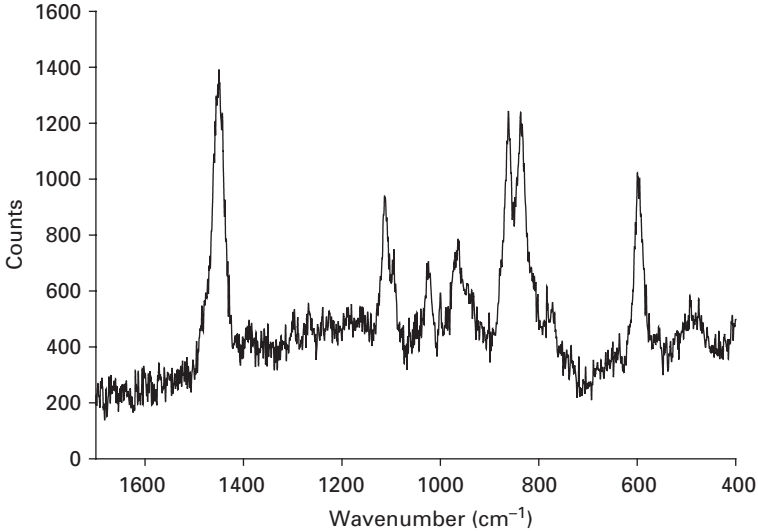

Fig. 1.8 Confocal Raman spectrum obtained from a heat-sealed composite silk/Paraloid 72B/silk crepeline sample. In art-conservation polymers, such as poly(butyl methacrylate) are used to consolidate fragile antique textiles. Here the lateral resolution of the technique has been combined with the confocal optics to decouple the spectrum of the adhesive from those of the other components.

8. Scanning probe microscopy

Compared with the above techniques, the origins of scanning probe microscopies (SPMs) are relatively recent. In 1982, Binnig *et al.*¹⁶⁷ described the first scanning tunnelling microscope (STM), in which a bias voltage is applied between an atomically sharp tip and a conducting sample. Provided the separation between the sample and the tip is of the order of 0.1 nm, a current flows between them due to quantum mechanical tunnelling and, since this is very strongly dependent upon separation, a topographic image of the surface can be obtained by scanning the tip across the sample and monitoring its vertical position at constant scanning current. The resulting images, potentially, have atomic resolution but this will depend upon surface roughness. Nevertheless, the above does illustrate the basic principles of the approach; a point probe is scanned across a surface under conditions where it is operating in the near-field regime.

Since the early 1980s, the number of variants to the above that have been developed are manifold and, therefore, only a brief introduction to the technique is possible here. To exploit the potential of STM fully, the sample needs to be both flat and conducting, and hence it is not widely used for the study of polymers. However, a variant of the technique has become very widely used—atomic force microscopy (AFM). In many ways, AFM is derived from surface profilometry,¹⁶⁸ in which a stylus is scanned across the

1: Polymer characterization

surface of a (non-conducting) specimen to build up a topographic map. When an atomically sharp tip is brought close (~ 1 nm) to a surface, interaction forces result and, if the tip is mounted at the end of a cantilever, the cantilever will deflect. At its most simple level, the result is a profilometer with high spatial and force resolution (Figure 1.9).

For the study of non-conducting samples the mechanical interaction between the probe tip and the specimen can be exploited in many ways.

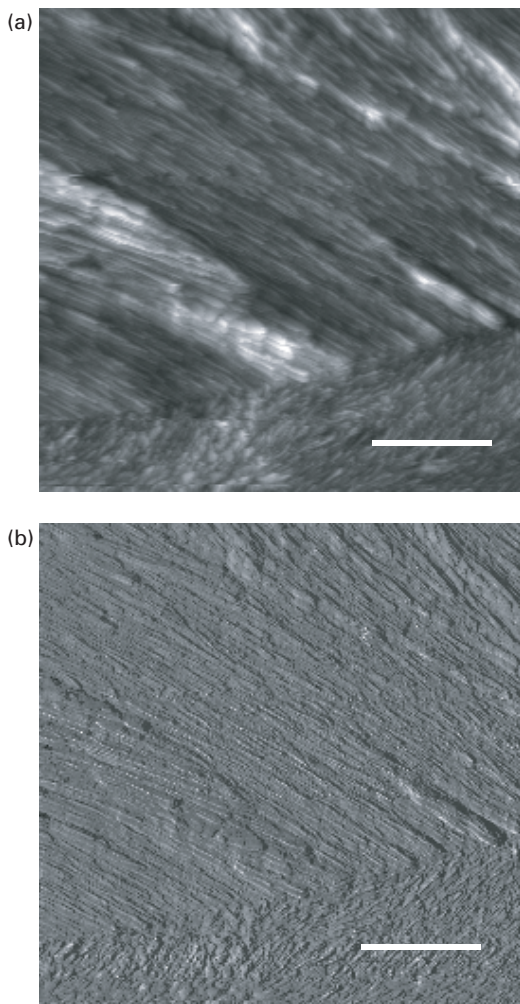

Fig. 1.9 AFM tapping mode images of a spherulitic texture in isotactic polypropylene. The sample was crystallized to completion at 145°C and subjected to permanganic etching prior to examination. Image (a) shows topography while (b) contains phase information. Scale bars $5\ \mu\text{m}$.

These include contact force imaging (CFI) mode, in which the tip is scanned across the sample surface at constant force, tapping mode in which the tip oscillates close to the surface enabling either the forces or phase relationships between load and displacement to be used to form the image, and local force spectroscopy or force/volume imaging in which the variation of force with tip/sample separation at a point can be used to study local interactions.

The simplicity of sample preparation is the major advantage of AFM over TEM, for example, for the detailed study of lamellar structure. Coupled with permanganic etching, the AFM is now recognized as a powerful tool for the characterization of polymeric materials.^{169–171} In particular, AFM lends itself to the study of nucleation and growth phenomenon where the requirement for a high vacuum in conventional electron microscopy prohibits the use of high temperatures and has, to date, been applied successfully to a large variety of different polymers.¹⁷⁰ The unique ability to image in three dimensions allows structural information such as lamellar thickness¹⁷¹ to be extracted and the direct imaging of complex structures including nanocomposites.^{155,172}

In the final example, it is possible to modify the chemical nature of the tip to explore specific interactions,¹⁷³ for example, single polymer load extension curves have been explored by, first, using the tip to detach some molecules, reattach them elsewhere and, finally, monitor the force as they are extended.^{173–175} Indeed, another use of AFM is as a means of moving atoms and molecules to build structures. Recent developments include a novel high-speed imaging system.¹⁷⁶

In situations where the electrical properties of a material are of interest, a range of SPMs have been developed to explore different effects. Weisendanger¹⁷⁷ provides a more comprehensive summary of the multitude of different SPM techniques than is possible here.

9. Thermal analysis

Differential scanning calorimetry (DSC) constitutes one of the most widely used techniques for the study of polymers, particularly those systems that crystallize. Although the term DSC is used in conjunction with many different instruments, fundamentally, these can be divided into two categories; heat flow instruments based upon differential thermal analysis (DTA) and those which are true power compensated instruments.

In DTA, the temperature of the sample is compared with that of an inert reference as both are subjected to, ideally, identical thermal programmes. To illustrate the principles, consider an experiment to investigate the melting behaviour of a material. In this, heat is supplied to both the sample and the reference and, as a consequence, the temperature of each will rise. As the sample melts, the thermal energy supplied by the instrument no longer raises its temperature but, rather, provides the necessary enthalpy of fusion. Since the temperature of the inert reference will continue to rise throughout this process, the temperature difference between the sample and the reference

changes and a peak in the output signal results. In such an instrument, the output signal takes the form of temperature difference as a function of time (at constant heating rate this is easily converted to temperature) and, therefore, transition temperatures can be obtained easily, whereas thermodynamic parameters must be deduced through a knowledge of specific heat capacities, thermal conductivities, etc.¹⁷⁸ In power compensated DSCs, the sample and the reference are heated separately, and then it is the difference in the power required to maintain them at, theoretically, the same temperature throughout the thermal cycle that is recorded. That is, the output takes the form of the power difference as a function of time, enabling enthalpies of fusion, specific heat capacities, etc. to be obtained relatively easily. In practice, the feedback control between the sample and the reference temperature sensors and heaters will necessarily introduce some errors¹⁷⁹ and it has, therefore, been suggested that power compensated calorimeters suffer from many of the same problems experienced by heat flow instruments.¹⁷⁸ While this is qualitatively true, quantitatively, the problems are very much less.

Despite the theoretical advantages of the power compensated approach, the associated instrumentation is much more complex and, therefore, there are circumstances where the simplicity of DTA has much to recommend it. DTA requires just two thermocouples and can, therefore, be used under demanding conditions. For example, high-pressure DTA experiments have been used extensively to generate phase diagrams of polyethylene and related low molar mass compounds^{180–182}—high-pressure DSC is rather more complex.^{183,184}

Crystalline polymers present particular problems for thermal analysis, since they are never present in a thermodynamic equilibrium state. The question, therefore, is not, is the experiment invasive, but rather, how invasive is it? Where multiple melting peaks are observed,^{185–187} two possible interpretations can be proposed: each peak represents a particular component within the initial material; one or more of the peaks are a direct result of structural changes that have occurred during the course of the DSC scan itself. For example, in polyethylene terephthalate (PET), this issue has an extensive history;^{188,189} in polyethylene blends, multiple peaks are a necessary feature of the system, but here, co-crystallization and dynamic reorganization within the DSC can result in particularly complex forms of behaviour.^{190,191} Nevertheless, nowhere has the topic of DSC-induced changes been debated more extensively than in connection with poly (ether ether ketone) (PEEK)—see Ref. 192 for example.¹⁹² Ultimately, this problem is entirely to do with the timescale of the experiment relative to the kinetics of sample reorganization and, therefore, reducing the former, will reduce the impact of the latter. While high-speed DSC may be desirable, even in power compensated instruments, there are limits to which this can be practically realized. Recently, it has been suggested that a simple expedient to overcome this involves reducing the thermal inertia of the total sample; that is, the sample plus its encapsulation system.¹⁹³ Replacing conventional sample cans (mass ~10 mg) with

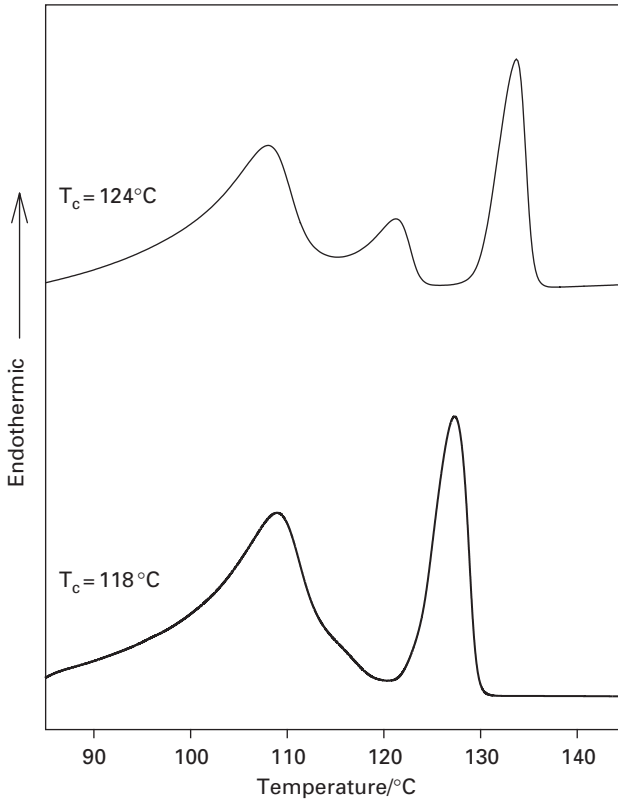

Fig. 1.10 DSC traces showing the effect of crystallization temperature on the melting behaviour of a nucleated polyethylene blend (20% high-density and 80% low-density polyethylene). In this case, all the peaks represent specific lamellar populations within each system.

pieces of aluminium foil (mass $< 100 \mu\text{g}$) and similarly reducing the sample mass can have a dramatic effect. Other processes that have been studied by DSC/DTA include the cure kinetics of thermosetting polymers¹⁹⁴ and thermal degradation, both through the direct measurement of the associated exothermic peaks^{195,196} and through associated changes in other thermal characteristics of the specimen.^{196,197} However, neither of these is entirely without risk to the instrument since, in both, damaging species may escape from the DSC can (Figure 1.10).

In the case of glassy systems, DSC can also be used to examine the discontinuity in the specific heat capacity that is associated with the glass transition.¹⁹⁸ However, this transition is generally broad and weak and, therefore, inferring T_g in this way can be difficult; also, different authors choose to identify T_g in different ways.^{198,199} As in the case of crystalline polymers, polymer glasses are also never at equilibrium and, therefore, the form of the transition that is

observed in practice will depend upon experimental conditions, the way the glass was prepared and subsequent physical ageing. In particular, the so-called enthalpy relaxation peaks are seen after ageing and care should be taken not to misinterpret these as first-order thermodynamic transitions.^{199–201}

Temperature modulated DSC (MDSC)^{202–204} is another technique that has proved useful in the study of the glass transition^{194–196,205,206} where, it has been claimed, the approach is capable of providing better resolution and sensitivity than conventional DSC.²⁰⁷ In this, a modulated temperature programme is superimposed upon the conventional heating ramp and the resulting heat flows are interpreted in terms of two heat capacities; an in-phase storage heat capacity and an out-of-phase kinetic heat capacity. Various theoretical procedures^{208,209} have been proposed for this and there is little doubt that the approach can provide information that is complementary to conventional DSC.²¹⁰ However, the technique does involve slow temperature scans (cf. high-speed DSC above) and the authors feel that there are areas where the additional data are not, at present, easy to interpret.

10. Molecular relaxation spectroscopy

In MDSC, the basis of the technique involves examining the response of a system to an oscillating thermal stimulus. As described above, the result is parameters that characterize the in-phase and out-of-phase response of the system. In dynamic mechanical thermal analysis (DMTA), an oscillatory strain is applied to a sample and the resulting stresses are determined as a function of frequency, temperature, or both. Since polymers are viscoelastic solids, the stress will generally be out of phase with the strain, so leading to three parameters: the real storage modulus; the imaginary loss modulus; and $\tan \delta$, the ratio of the loss modulus to the storage modulus. For an in-depth theoretical account of the technique, see the review by Gradin *et al.*²¹¹

Using the above approach, a wide range of different complex moduli can be obtained, depending upon the geometry of the experiment. Common testing modes include tensile (films and fibres), shear sandwich and parallel-plate torsion (soft solids and viscous melts), compression, three-point bend and dual cantilever (bulk samples). However, the accurate acquisition of absolute mechanical parameters in this way is not trivial, particularly in systems, like polymers, which creep. For example, in tensile and compression modes, the strain must never pass through zero. For this reason, dual cantilever, in which a beam of material is flexed about zero deformation, is attractive in that no offset has to be applied. However, end effects and clamping conditions are still important—particularly where the temperature range of interest can appreciably change the characteristics of the material. Also, each mode is only suitable over a limited range of mechanical response, where this includes both material properties and sample geometry. Consequently, the true utility of DMTA is as a means of determining changes in the mechanical behaviour of a material as

a function of temperature or frequency. DMTA has, therefore, been used widely to study crosslinking,²¹² the effects of additives and fillers²¹³ and exposure to environmental factors such as water and other low molar mass compounds.^{214,215} Reference 215 is interesting from the technical perspective, in that the authors employed free torsional oscillations to study the effect of various penetrant molecules on the β -relaxation process in alkaline polycaprolactam. In the case of nano-composites the extent of the interfacial layers can result in significantly altered chain relaxation dynamics.²¹⁶

In the case of amorphous materials, the primary relaxation process is associated with T_g and, for these systems, is termed as the α -relaxation. As described above, the change in the heat capacity associated with T_g can be relatively small and, therefore, DSC is not ideally suited to the study of the glass transition. Conversely, in DMTA, T_g is easily detected, since it is associated with a large change in the mechanical properties. At temperatures below T_g , molecular motion is related to molecular segments or side-groups, processes which can lead to a number of secondary relaxation peaks in $\tan \delta$; conventionally, these are sequentially indicated β , γ , etc. with decreasing temperature. In the case of polymethylmethacrylate (PMMA), for example, the β -transition has been shown to be associated with side-chain motions of the ester groups while the γ - and δ -relaxations involve motion of the methyl groups attached to the main chain and the side chain, respectively.²¹⁷ In blend systems, the presence of a single glass transition is taken to indicate miscibility and, therefore, the study of the α -transition is particularly important. However, since DMTA cannot resolve phases less than ~ 5 nm in size,²¹⁸ miscibility, in this context, does not necessarily imply miscibility on the molecular scale. Nevertheless, relatively broad and weak transitions are readily detected by DMTA and, therefore, miscibility can be explored with this technique with much greater sensitivity than is possible by DSC. Examples of miscible systems where this approach has been employed include PEEK/poly(ether imide)²¹⁹ and PVF₂/PMMA.²²⁰ In nylon/polystyrene ionomer blend systems, miscibility depends on the counterion^{218,221} while in interpenetrating network systems, the extent of crosslinking is critical.²²² Systems where two distinct glass transitions have been observed include poly[(S)-lactide]/poly[(R,S)-3-hydroxybutyrate]²²³ and PEEK/poly(ether sulfone).²²⁴ However, in both these cases, small shifts in behaviour with blend composition are reported, suggesting partial miscibility of the two components.

In crystalline polymers, the principal relaxation process is associated with melting. In polyethylene, α ; β -, and γ -transitions have been identified and, particularly in high-density polyethylene, the α -transition has been sub-divided into α and α' . In ethylene-based polymers, the γ -transitions at $\sim -120^\circ\text{C}$ is generally associated with the amorphous phase, in particular, with 'crankshaft' motion of methylene sequences.^{211,225} However, based upon studies of solution grown lamellae, it has also been suggested that this may then be associated with

defects within the crystals.²²⁶ The strength of the β -transitions is found to vary with branch content and, therefore, is generally associated with the motion of side-groups within amorphous areas or at lamellar fold surfaces. Indeed, Woo *et al.*^{227,228} have suggested that, in ultra-low-density polyethylenes, the β -relaxation may provide an indication of the type and number of branch points; where side groups undergo hydrogen bonding, this then has a marked effect on the β -relaxation.²²⁸ In high-density polyethylene, the temperature of the α - and α' -processes correlates with the melting transition and therefore these relaxations are associated with the crystalline structure. The α -process varies with crystal thickness, suggesting that it is also associated with fold surfaces, while α' has been assigned to slip at lamellar boundaries.²²⁹ In polytetrafluoroethylene (PTFE), the α -, β -, and γ -transitions are located at about 127, 30–100, and -97°C , respectively.²³⁰ The α -transition is found to decrease with increasing crystallinity and has, therefore, been associated with the amorphous phase (specifically T_g); the γ -transition behaves in a similar manner. In this system, the intermediate β -transition increases and broadens with crystallinity, suggesting that it is related to a crystalline relaxation.²¹¹ In general, producing a mechanistic interpretation of an observed relaxation processes is far from straightforward. Indeed, the convention of referring to the observed peaks in $\tan \delta$ as α , β , γ , etc. with decreasing temperature, whatever their molecular origin, means that the significance of each of these terms can vary enormously from material to material, as in the above examples.

Practically, DMTA is limited to low frequencies (up to tens of hertz) and, consequently, provides information about relatively slow processes. Dielectric spectroscopy is a related approach in which an alternating electric field is applied to a sample and the complex permittivity is then obtained from phase and amplitude measurements of current and voltage; again, it is possible to consider data in the frequency domain, the temperature domain, or even as frequency/temperature contour maps.^{230,231} See Refs. 230 and 232 for a theoretical account of the underlying physics. The approach can provide information in the frequency range 10^{-2} – 10^{11} Hz²³² by coupling the applied electric field with dipoles in the system and, as such, the molecular probe (molecular dipole moment) is well defined. This, however, immediately presents a limitation in that the technique is not well suited to non-polar polymers such as polyethylene and PTFE. In such materials, dielectric spectroscopy tends to provide direct information about impurities or degradation since it is necessary to decorate the polymer to render certain relaxations detectable.²³³ In polyethylene, deliberate oxidation or chlorination can be used to effect suitable changes.

As in DMTA, dielectric spectroscopy can also be used to study both imposed factors; such as additives,²³⁴ degradation,²³⁵ and penetrant molecules,²³⁶ and intrinsic molecular processes. In the latter case, a number of distinct dielectric relaxations are generally observed, which are labeled α , β , γ , etc. with decreasing temperature; in the case of Nafion perfluorocarboxylate polymers, for example, specific α' , α , β , γ , and δ -relaxations have

been observed.²³⁷ In the case of amorphous polymers, the α -transition is generally observed somewhat above T_g , as measured by DSC or DMTA. The origin of this is the different experimental frequencies involved in each technique—the higher the frequency, the higher the apparent relaxation temperature. Nevertheless, the α -transition is related to T_g and, consequently, it is characterized by a very marked increase in relaxation time with decreasing temperature. From a molecular perspective, it involves micro-Brownian motion of chains, and a number of specific models have been proposed.²³² The β -relaxation is associated with local molecular motions and is generally broader than the α , reflecting both the moiety involved and its environment. Indeed, even in miscible blends, multiple β -processes can be observed.²³⁸

In modified polyethylene, effects similar to DMTA are seen. Although it is accepted that the α -relaxation is related to the crystalline phase, a number of different models have been proposed and, consequently, its precise interpretation is unclear.²³⁹ The β -relaxation has a large activation energy and is regarded as an analogue of the β -relaxation seen in amorphous systems.²³² The γ -relaxation, which is extremely broad in the frequency domain, has been attributed variously to the crystalline phase and to chain ends and branches within amorphous regions.²⁴⁰ In other semi-crystalline systems, specific molecular interpretations have been proposed for the multiple relaxation processes that are seen.²³² A particular area of interest in semi-crystalline systems is the rigid amorphous phase that is imagined to exist between crystalline and amorphous regions.²³⁸

In conclusion, although DMTA and dielectric spectroscopy involve very different stimuli, the information they provide is complementary and similar basic principles apply to both. Consequently, the pair can be used in tandem²⁴¹ to provide a more comprehensive picture of the molecular relaxation processes that occur within polymeric materials.

11. X-ray and neutron scattering methods

X-ray scattering methods provide a route to unambiguously determining the basic structural characteristics of polymeric materials. The penetration of X-rays means that these techniques are not restricted to thin films, as in the case of IR spectroscopy, or optically transparent materials, as in the case of optical microscopy. Complex materials including filled polymers, composites, and other optically opaque samples, such as semi-crystalline polymers, can be studied with ease. Moreover, the sample preparation required for X-ray scattering techniques is often minimal.

Wide-angle X-ray scattering techniques can provide direct information on key features such as crystallinity, preferred orientation, phase identification and compositional analysis.^{242,243} More detailed analysis can yield details of local chain conformations and packing arrangements in both crystalline and disordered polymers.²⁴⁴

1: Polymer characterization

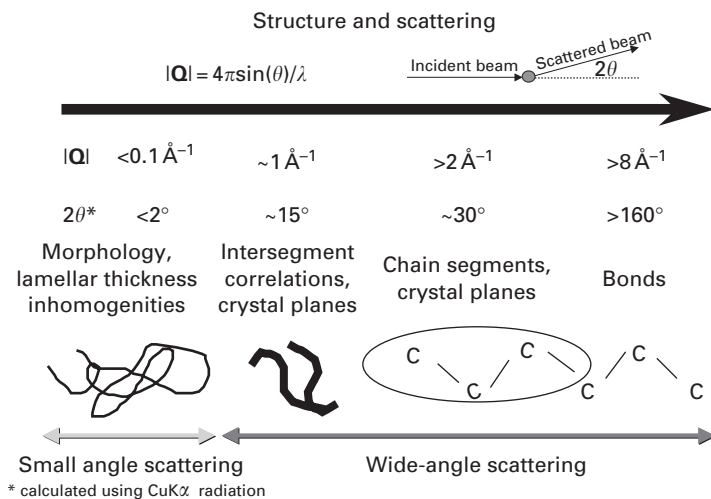

Fig. 1.11 A schematic of the scales of structure accessible through X-ray and neutron scattering procedures.

Small-angle X-ray scattering techniques provide a route to information at a larger scale, particularly in multi-phase materials such as semi-crystalline polymers, block copolymers, and blends. Quantitative details on crystalline lamellar size or on preferred orientation are just two examples of the structural parameters which can be obtained using this powerful technique.^{242,243}

Figure 1.11 provides a schematic of the range of information that is available from scattering techniques. Scattering data is often reported in terms of the magnitude of the scattering vector $|\mathbf{Q}|$ which depends both upon the scattering angle 2θ and the incident wavelength λ as indicated in Figure 1.11. The scattering vector provides an experiment-independent scale in contrast to ordinates such as the scattering angle. Moreover, it allows data obtained through neutron scattering procedures to be compared with X-ray scattering data.

X-rays are scattered by the electrons around each atomic nucleus and, therefore, the strength of scattering depends on the atomic number. This means that for polymers containing relatively high atomic number elements such as Cl, F, P, or Si, the resultant scattering signal is dominated by correlations between atoms of those elements. The X-ray scattering from polyvinylchloride (PVC) is a good example of this high- Z domination. Due to the various chain defects present in PVC, the Cl atoms are dispersed in a rather disordered manner and this has inhibited detailed structural analysis. For most polymers containing only C, H, N, or O, this effect is not present. Moreover, the low atomic number composition means that X-ray transparency is high and experiments can be performed using transmission geometry with sample thicknesses from 0.1 to 2.0 mm. Transmission geometry facilitates considerably the study of anisotropy and the deployment of small-angle X-ray scattering techniques.

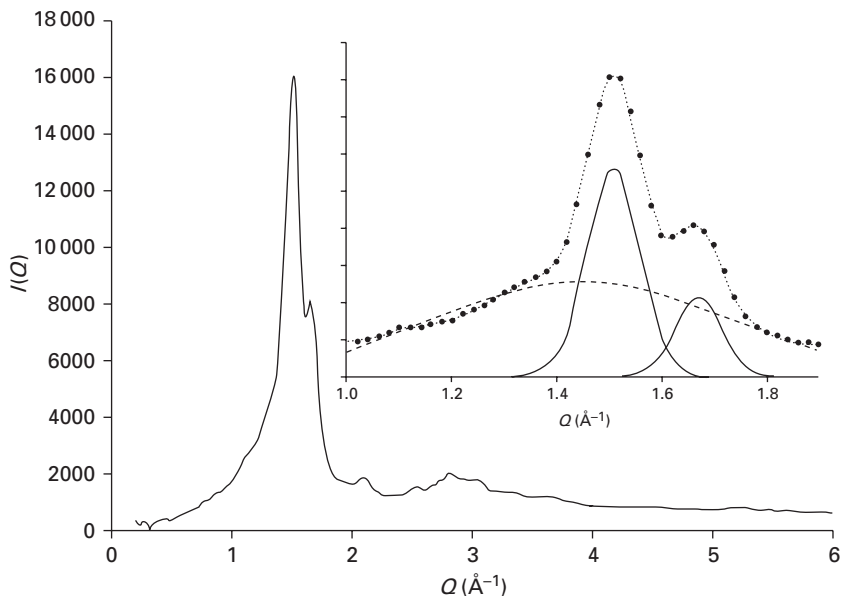

Fig. 1.12 Wide-angle X-ray scattering pattern for poly ϵ -caprolactone obtained at room temperature using a transmission X-ray diffractometer.²⁴⁵ The inset illustrates how the total scattering (points) can be decomposed into crystalline (full lines) and amorphous (broken line) components. The dotted line represents the sum of the crystalline and amorphous components.

Conversely, the use of parafocusing reflection powder diffractometers widely used in other areas of materials science can lead to minor complications. Essentially, the sample does not absorb sufficiently for it to appear to be ‘infinitely thick’ as in the case of metals and this will lead to modification to the intensity values which will need to be corrected before interpretation.

Figure 1.12 shows a wide-angle X-ray scattering pattern for poly ϵ -caprolactone obtained at room temperature using a transmission X-ray diffractometer.²⁴⁵ This pattern is typical of many semi-crystalline hydrocarbon based polymers. The sharp peaks at $Q \sim 1.52, 1.66, 2.1, \text{ etc. } (\text{\AA}^{-1})$ arise from the crystalline phase, whilst the much broader peaks beneath these sharp peaks arise from the non-crystalline or the so-called amorphous phase. We can obtain values for the so-called d -spacings, that is, the spacing between the crystalline planes through $d = 2\pi/Q_0$ where Q_0 is the position of a particular peak. This is Bragg’s law. The breadth of the peaks ΔQ provides information on the correlation length (l_c) for that structure, in essence, the size of the crystal, through $l_c = 2\pi/\Delta Q$. If we are able to separate out the contributions in the X-ray scattering pattern from the crystalline and the amorphous phases we can use the ratio of the integrated second moment of the crystalline scattering to the total scattering as a measure of the crystallinity of that sample.²⁴³ Using non-linear least squares peak fitting

procedures, it is fairly straightforward to identify the contributions from the crystalline phase, while providing an adequate representation of the amorphous phase is generally more difficult. Using the scattering from a sample in the melt as a model for the amorphous scattering often leads to complications due to the temperature dependence of the scattering. However, in most cases, reliable and consistent results for the degree of crystallinity can be obtained if sufficient care is taken in the peak fitting procedure. The inset to Figure 1.12 shows an example of this analysis. The crystalline and amorphous components of the scattering can be seen directly. Analysis of the curves yields a crystallinity of the order of 40%.

The absence of sharp peaks in a wide-angle X-ray scattering pattern is a simple and straightforward test for the lack of a crystalline structure. Non-crystalline polymers such as atactic polystyrene or atactic PMMA exhibit rather characteristic X-ray scattering patterns²⁴⁶ and where this is the case, it may be possible to carry out identification and compositional analysis from the X-ray scattering patterns. As a first approximation, we can use the position of the diffuse peaks in an amorphous pattern to derive the real space length scale giving rise to that peak through a modified Bragg's law $r = k2\pi/Q_0$ where the value of k depends on the nature of the structural units but usually lies in the range 1–1.2.²⁴⁴

Materials which exhibit a preferred orientation in either the amorphous or crystalline phases reflect this in the wide-angle X-ray pattern. Figure 1.13 shows the wide-angle X-ray pattern for a melt spun monofilament fibre of poly ϵ -caprolactone obtained using a transmission system equipped with an

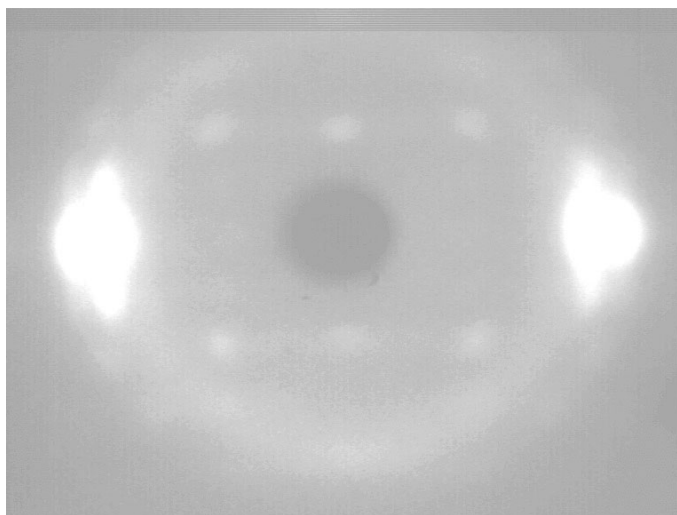

Fig. 1.13 Wide-angle X-ray pattern of a melt spun fibre of poly ϵ -caprolactone. The fibre axis is vertical. The intense spots on the equator correspond to $Q \sim 1.5 \text{ \AA}^{-1}$.

X-ray sensitive charge coupled device (CCD) detector. This experimental arrangement allows data to be obtained rapidly in tens of seconds but with a restricted Q range. The high degree of preferred orientation of the crystals is immediately obvious. Moreover, the symmetry of the pattern enables us to locate the direction of preferred orientation, not surprisingly in this case it is parallel to the fibre axis. The azimuthal breadth of the peaks can be used as a measure of the degree of preferred orientation and straightforward procedures are available to yield the complete orientation distribution function. Even within the limited Q range of the X-ray pattern shown in Figure 1.13, there is considerably more information in the pattern than in Figure 1.12. There are very intense peaks on the equatorial section and a number of much weaker peaks lying on the so-called layer lines. The spacing between the layer lines yields the length of the repeating structure in the crystal along the fibre axis. Such scattering data from fibres can be used to determine the conformation of the chains in the crystals and other details of the crystal structure.²⁴⁷

Figure 1.14 shows the small-angle X-ray scattering pattern from the same poly ϵ -caprolactone fibres studied in Figure 1.13 taken using beam-line 16.1

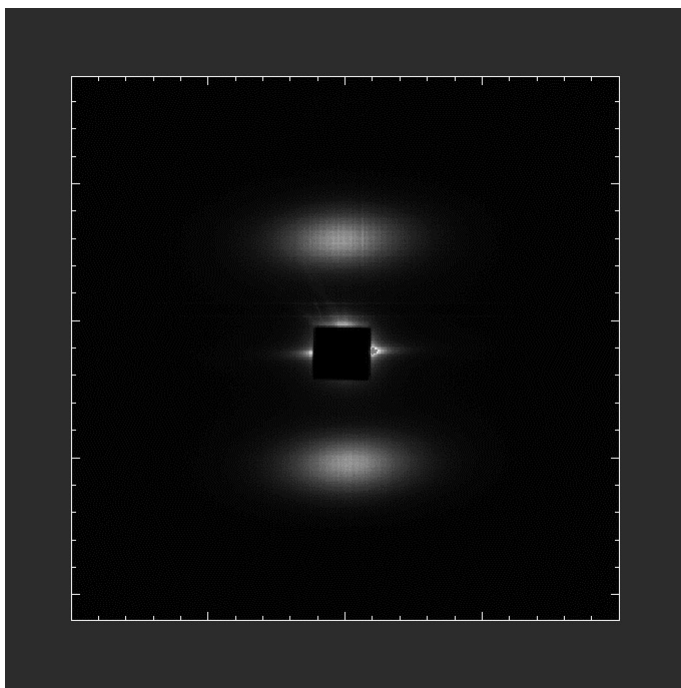

Fig. 1.14 Small-angle X-ray pattern of a melt spun fibre of poly ϵ -caprolactone. The fibre axis is vertical. The Q range is from -0.1 to 0.1 \AA^{-1} for both horizontal and vertical directions.

at the Daresbury synchrotron source.²⁴⁵ Similar patterns can be obtained using laboratory X-ray sources but require a substantially longer data accumulation time. The high level of preferred orientation is immediately visible. The intense peaks arise from the segregated amorphous and crystalline structure in which thin crystals sandwich the amorphous material. The scattering vector corresponding to the peaks (Q_0) can be used to calculate the long period (l_p), that is, the length scale of this alternating structure through $l_p = 2\pi/Q_0$. If we know the degree of crystallinity, for example, from a wide-angle X-ray scattering study, we can use this to calculate the thickness of the crystalline and amorphous components. The horizontal scattering streak in Figure 1.14 arises from elongated voids in the fibre. Block copolymers exhibit patterns at small angle which are characteristic of the morphology, that is, lamellar, columns, spheres, etc.²⁴²

Some polymers may be of particular interest in that they exhibit liquid crystal phases. X-ray scattering in conjunction with thermal analysis and optical microscopy provides a powerful tool to identify nematic and smectic phases.²⁴⁸ Usually the information of interest lies at the boundary of small-angle and wide-angle scattering regimes and identification is greatly facilitated if macroscopically aligned samples are available, for example, through the use of magnetic fields.

Neutron scattering procedures follow in broad outline X-ray scattering techniques. Clearly such studies can only be carried out at specialist national or international facilities.²⁴⁹ As a consequence, neutron scattering experiments are focused in obtaining data not available with other techniques. For polymers, neutron scattering techniques offer two distinct advantages.²⁵⁰ The first is that data over a much larger Q range can be easily obtained, for example, using GEM or SANDALS at the UK ISIS pulsed neutron facility broad Q data (equivalent to wide-angle) can be obtained with Q values from 0.1 to 50 \AA^{-1} . Data over this extended range is particularly useful in detailed studies of the local arrangements of disordered polymers.²⁵¹

The second advantage centres on the fact that hydrogen has a different neutron scattering cross-section to deuterium.²⁵⁰ This can be widely exploited in both 'wide-angle' and 'low-angle' techniques. Hydrogen has a large incoherent cross-section which leads to a substantial background which contains no useful static structure information. It is, however, widely used in the study of dynamics. The broad Q neutron scattering data for a per-deuterated polymer will have a similar appearance to a wide-angle X-ray scattering pattern, although the fall-off of intensity with Q is much less pronounced than in the case of an X-ray scattering pattern. Figure 1.15 shows broad Q neutron scattering data obtained using GEM at ISIS, the lowest curve is obtained for per-deuterated polyethylene in the melt phase and the subsequent curves are snapshots taken over successive time periods after quenching the sample to an intermediate temperature in order to follow the isothermal crystallization

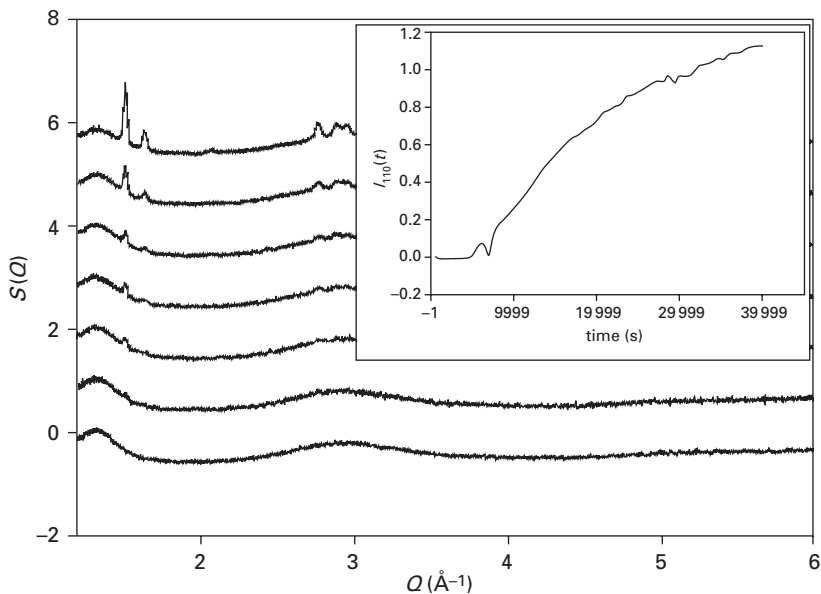

Fig. 1.15 Broad Q neutron scattering for a sample of per-deuterated linear polyethylene. The lowest curve corresponds to the melt state and the successive curves correspond to snapshots taken at time intervals following quenching from the melt (160°C to 129°C). The inset shows how the intensity of the first sharp crystalline peak increases with time during the crystallization process.

process.²⁵² The inset shows the development of the intensity of the first crystalline peak with time during the early stages of crystallization. The first curve is typical of many disordered polymers in that it contains a series of rather diffuse peaks. The first is usually associated with inter-segmental correlations while at high Q the scattering arises from correlations within a segment.²⁵¹ Despite the diffuse nature of the scattering, considerable structural information can be obtained using advanced computational modelling procedures tightly coupled to the scattering data.²⁵¹

Figure 1.16 shows the broad Q neutron scattering data recorded for thin films of per-deuterated polypyrrole doped with toluene sulfonate.²⁵³ The diffuse nature of the peaks shows that the structure is highly disordered. However, these films exhibit a substantial level of preferred orientation as can be seen by comparing the scattering recorded with the scattering vector perpendicular to the film thickness and parallel to the film. By comparing the scattering for films prepared using per-deuterated toluene sulfonate with those prepared with the equivalent hydrogen containing compound, quantitative details of the location of the dopant within the film were obtained. Essentially, the film exhibits a layered structure with more or less alternating layers of polypyrrole and dopant.²⁵³

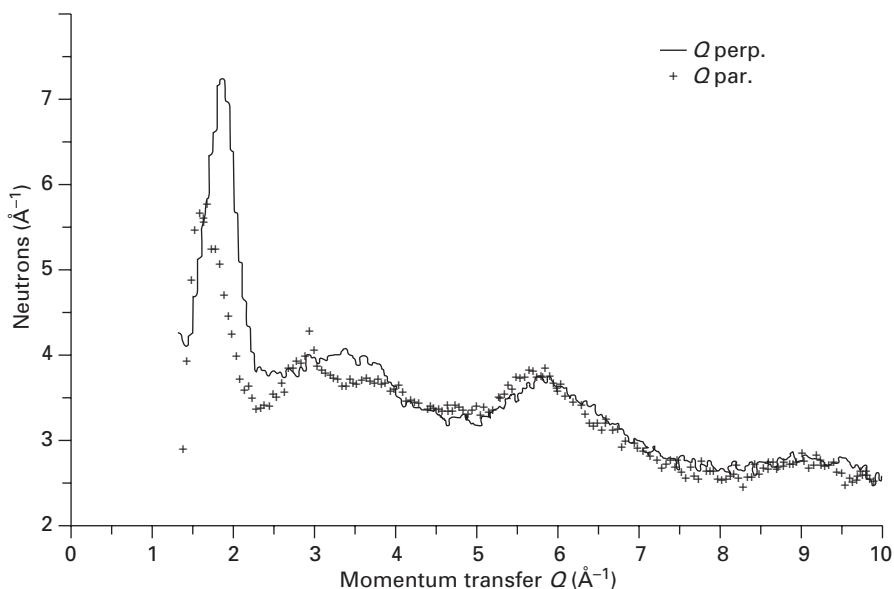

Fig. 1.16 Broad Q neutron scattering for a sample of per-deuterated polypyrrole doped with deuterated toluene sulfonate. The full line shows the data for Q perpendicular to the film surface and the points show the data for Q parallel to the film surface.

We can exploit mixtures of per-deuterated and per-hydrogenated polymers in small-angle neutron scattering measurements to reveal information on the configuration of individual chains as well as assemblies of chains in the case of phase separating blends, block copolymers, and other inhomogeneous systems.^{250,254} This is the classic polymer science technique which has underpinned much of our current understanding of the structure on the scale of the radius of gyration.²⁵⁴ Figure 1.17 shows an example of small-angle neutron scattering data recorded using D22 at the Institut Laue Langevin for a sample of per-deuterated polyethylene with 10% of per-hydrogenated polyethylene.²⁵⁵ The sample is molten and has been subjected to a controlled deformation (~ 3 times) using a channel die. The flow axis is horizontal and the square in the centre of the intense scattering corresponds to the beam stop area. The beam stop prevents the very intense zero angle beam saturating the detector. The scattering is clearly anisotropic and the intensity falls off less quickly with Q in the direction normal to the flow axis compared to the direction parallel to the flow axis. The rate of fall-off of the intensity is related to the radius of gyration of the chain in that direction. Quantitative analysis of the data reveals an extension of the chains in the direction of flow by $\sim 20\%$ with a radius of gyration in that direction of ~ 200 Å.

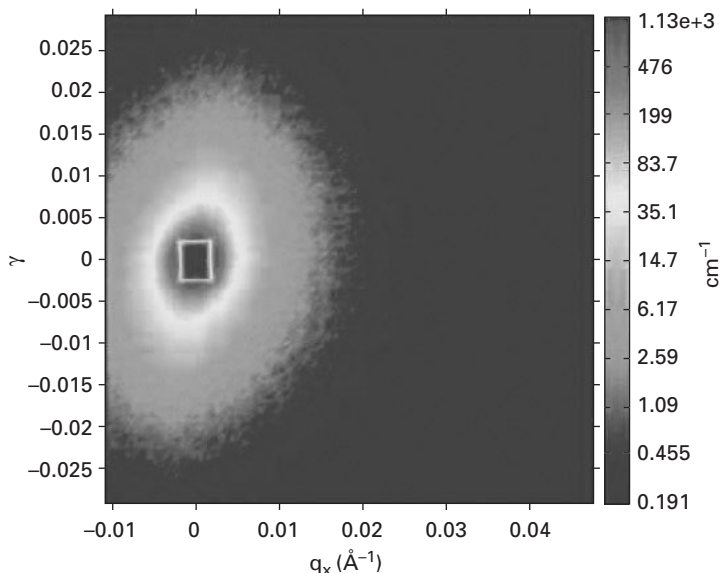

Fig. 1.17 Small-angle neutron scattering pattern for a sample of per-deuterated lightly branched polyethylene containing 10% of hydrogen containing linear polyethylene. The sample is molten and has just been subjected to deformation in a channel die. The flow axis is horizontal and the effective extension ratio is ~ 3 .

12. Conclusions

This chapter gives some examples of the range of techniques available for the characterization of polymeric materials. It is by no means an exhaustive, and of necessity brief, but it does serve to illustrate some of the challenges faced by the polymer scientist, and the need for interactions across the boundaries of traditional scientific disciplines. The situation is particularly complicated because subtle changes in chemical composition can often have marked influence on the macroscopic properties of polymer and such small differences may be particularly challenging to monitor at a molecular level using techniques like NMR. However, ultimately the key to developing materials with desirable properties is control through synthesis. In the discussion that follows, many routes to macromolecular materials are described. In every case the level of control over structure is determined by the intended application. Thus, for cross-linked polystyrene beads particle size may be important, for a block copolymer produced by anionic chain-growth polymerization the size of the blocks may be a crucial feature, and dendrimers are often designed to be single monodisperse systems. It is to be hoped that the following account, while by no means complete, will give the reader a flavour of the methods of constructing macromolecules and macromolecular systems.

References

1. Hadjichristidis, N.; Iatrou, H.; Pispas, S.; Pitsikalis, M. *J. Poly. Sci., Part A: Polym. Chem.* **2000**, *38*(18), 3211–3234.
2. Tomalia, D. A.; Naylor, A. M.; Goddard, W. A., III *Angew. Chem., Int. Ed. Engl.* **1990**, *29*, 138.
3. Romagnoli, B.; Hayes, W. *J. Mater. Chem.* **2002**, *12*, 767–799.
4. Semlyn, J. A., ed., *Cyclic Polymers*, Elsevier: New York; **1986**.
5. Ben-Haida, A.; Colquhoun, H. M.; Hodge, P.; Williams, D. J. *J. Mater. Chem.* **2000**, *10*, 2011–2016.
6. Kricheldorf, H. R. *Macromolecules* **2003**, *36*, 2302–2308.
7. (a) Higashi, F.; Ogata, S.; Aoki, Y. *J. Polym. Sci., Polym. Chem. Ed.* **1982**, *20*, 2081. (b) Yamazaki, N.; Matsumoto, M.; Higashi, F. *J. Polym. Sci., Polym. Chem. Ed.* **1975**, *13*, 1373.
8. Dalton, L. R.; Steier, W. H.; Robinson, B. H.; Zhang, C.; Ren, A.; Garner, S.; Chen, A. T.; Londergan, T.; Irwin, L.; Carlson, B.; Fifield, L.; Phelan, G.; Kincaid, C.; Amend, J.; Jen, A. *J. Mater. Chem.* **1999**, *9*, 1905–1920.
9. Roncali, J. *J. Mater. Chem.* **1999**, *9*, 1875–1893.
10. Laforgue, A.; Simon, P.; Sarrazin, C.; Fauvarque, J. F. *J. Power Sources* **1999**, *80*, 142–148.
11. Friend, R. H.; Gymer, R. W.; Holmes, A. B.; Burroughes, J. H.; Marks, R. N.; Taliani, C.; Bradley, D. D. C.; Dos Santos, D. A.; Bredas, J. L.; Logdlund, M.; Salaneck, W. R. *Nature*, **1999**, *397*, 121–128.
12. Jacob, M. M. E.; Hackett, E.; Emmanuel, P. G. *J. Mater. Chem.* **2003**, *13*, 1–5.
13. Canali, L.; Sherrington, D. C. *Chem. Soc. Rev.* **1999**, *28*, 85–93.
14. Merrifield, R. B. *Angew. Chem., Int. Ed. Engl.* **1985**, *24*, 799–810.
15. Guillier, F.; Orain, D.; Bradley, M. *Chem. Rev.* **2000**, *100*, 2091–2157.
16. Kobayashi, S.; Akiyama, R. *Chem. Commun.* **2003**, 449–460.
17. Wulff, G. *Angew. Chem., Int. Ed. Engl.* **1995**, *34*, 1812.
18. Kaneko, D.; Gong, J. P.; Osada, Y. *J. Mater. Chem.* **2002**, *12*, 2169–2177.
19. Tanaka, T.; Sun, S. T.; Hirokawa, Y.; Katayama, S.; Kucera, J.; Hirose, Y.; Amiya, T. *Nature* **1987**, *325*, 796–798.
20. Davis, F. J. *J. Mater. Chem.* **1993**, *3*, 551–562.
21. Finkelmann, H. In *Polymer Liquid Crystals*; Ciferri, A.; Krigbaum, W. R.; Meyer, R. B., eds, Academic Press: New York; **1982**, Chapter 2.
22. Cooper, A. I. *J. Mater. Chem.* **2000**, *10*, 207–234.
23. Sherrington, D. C. *Chem. Commun.* **1998**, 2275–2286.
24. Lettieri, T. R. A.; Hartman, W.; Hembree, G. G.; Marx, E. *J. Res. Natl. Inst. Stand. Technol.* **1991**, *96*, 669–691.
25. Moad, G.; Rizzardo, E.; Solomon, D. H. *Macromolecules* **1982**, *15*, 909.
26. Georges, M. K.; Veregrin, R. P. N.; Kazmaier, P. M.; Hamer, G. K. *Macromolecules* **1993**, *26*, 2987.
27. (a) Hawker, C. J. *Acc. Chem. Res.* **1997**, *30*, 373. (b) Hawker, C. J.; Bosman A. W.; Harth, E. *Chem. Rev.* **2001**, *101*, 3661–3688.
28. (a) Patten, T. E.; Matyjaszewski, K. *Acc. Chem. Res.* **1999**, *32*, 895. (b) Matyjaszewski, K.; Xia, J. H. *Chem. Rev.* **2001**, *101*, 2921–2990.
29. (a) Kato, M.; Kamigaito, M.; Sawamoto, M.; Higashimura, T. *Macromolecules* **1995**, *28*, 1721. (b) Wang, J. S.; Matyjaszewski, K. *J. Am. Chem. Soc.* **1995**, *117*, 5614.

30. (a) Gaynor, S. G.; Qiu, J.; Matyjaszewski, K. *Macromolecules* **1998**, *31*, 5951–5994. (b) Ashford, E. J.; Naldi, V.; O'Dell, R.; Billingham, N. C.; Armes, S. P. *J. Chem. Soc., Chem. Commun.* **1999**, 1285–1286. (c) Wang, X. S.; Lascelles, S. F.; Jackson, R. A.; Armes, S. P. *J. Chem. Soc., Chem. Commun.* **1999**, 1817–1818.
31. Hong, K. L.; Uhrig, D.; Mays, J. W. *Curr. Opin. Sol. State Mat. Sci.* **1999**, *4*, 531–538.
32. Wang, J. S.; Jerome, R.; Teyssie, P. J. *Phys. Org. Chem.* **1995**, *8*, 208–221.
33. Lodge, T. P. *Macromol. Chem. Phys.* **2003**, *204*, 265–273.
34. Sanger, J.; Gronski, W. *Macromol. Chem. Phys.* **1998**, *199*, 555–561.
35. Iatrou, H.; Hadjichristidis, N. *Macromolecules* **1993**, *26*, 2479–2484.
36. Soreson, W. R.; Campbell, T. W. *Preparative Methods of Polymer Chemistry*, 2nd edn., John Wiley & Sons: New York; **1968**.
37. Percec, V.; Oda, H. *J. Mater. Chem.* **1995**, *5*, 1115–1123.
38. Webster, O. W.; Hertler, W. R.; Sogah, D. Y.; Farnham, W. B.; Rajanbabu, T. V. *J. Am. Chem. Soc.* **1983**, *105*, 5706.
39. Sogah, D. Y.; Farnham, W. B. In *Organosilicon and Bioorganosilicon Chemistry: Structure, Bonding, Reactivity and Synthetic Applications*; Sakurai, H., ed., John Wiley & Sons: New York; **1985**, Chapter 20.
40. Mulhaupt, R. *Macromol. Chem. Phys.* **2003**, *204*, 289–327.
41. Ziegler, K.; Holzkamp, E.; Breil, H.; Martin, H. *Angew. Chem.* **1955**, *67*, 541.
42. Natta, G. *J. Polym. Sci.* **1960**, *48*, 219.
43. Kaminsky, W.; Arndt, M. *Adv. Polym. Sci.* **1997**, *127*, 143–187.
44. Adler, H. J.; Fischer, P.; Heller, A.; Jansen, I.; Kuckling, D.; Komber, H.; Lehmann, D.; Piontek, J.; Pleul, D.; Simon, F. *Acta Polym.* **1999**, *50*, 232–239.
45. Kaminsky, W. *Macromol. Chem. Phys.* **1996**, *197*, 3907–3945.
46. Shmulinson, M.; Volkis, V.; Lisovskii, A.; Nelkenbaum, E.; Eisen, M.S. *Polym. Adv. Technol.* **2002**, *13*, 823–829.
47. Gibson, V. C.; Spitzmesser, S. K. *Chem. Rev.* **2003**, *103*, 283–315.
48. Gibson, V. C. *Adv. Mater.* **1994**, *6*, 37–42.
49. Grubbs, R. H.; Miller, S. J.; Fu, G. C. *Acc. Chem. Res.* **1995**, *28*, 446–452.
50. Frenzel, U.; Nuyken, O. *J. Polym. Sci., Part A: Polym. Chem.* **2002**, *40*, 2895–2916.
51. Trnka, T. M.; Grubbs, R. H. *Acc. Chem. Res.* **2001**, *34*, 18–29.
52. (a) Edwards, J. H.; Feast, W. J.; Bott, D. C. *Polymer* **1984**, *25*, 395–398. (b) Feast, W. J.; Winter, J. N. *J. Chem. Soc., Chem. Commun.* **1985**, 202–203.
53. Farina, V.; Krishnamurthy, V.; Scott, W. *Org. React.* **1998**, *50*, 1–652.
54. Miyaura, M.; Suzuki, A. *Chem. Rev.* **1995**, *95*, 2457–2483.
55. Schluter, A. D. *J. Polym. Sci., Part A: Polym.* **2001**, *39*, 1533–1556.
56. Hartwig, J. E. *Angew. Chem., Int. Ed. Engl.* **1998**, *37*, 2046–2067.
57. Jing, W. X.; Kraft, A.; Moratti, S. C.; Gruner, J.; Cacialli, F.; Hamer, P. J.; Holmes, A. B.; Friend, R. H. *Synth. Met.* **1994**, *67*, 161–163.
58. McCullough, R. D.; Lowe, R. D. *J. Chem. Soc., Chem. Commun.* **1992**, 70–72.
59. Chen, T. A.; Wu, X. M.; Rieke, R. D. *J. Am. Chem. Soc.* **1995**, *117*, 233–244.
60. The reader is referred to a number of excellent textbooks on polymer science. (a) Billmeyer, F. W. *Textbook of Polymer Science*; 3rd edn; Wiley: New York; **1984**. (b) Stevens, M. P. *Polymer Chemistry: An Introduction*; 2nd edn, Oxford University Press: New York; **1990**. (c) Cowie, J. M. G. *Polymers: Chemistry and Physics of*

1: Polymer characterization

- Modern Materials*, 2nd edn; Glasgow: Blackie; New York: Chapman and Hall, **1991**. (d) Young, R. J.; Lovell, P. A. *Introduction to Polymers*, 2nd edn; Chapman and Hall: London, **1991**. (e) Allen, G., Bevington, J. C. eds, *Comprehensive Polymer Science: The Synthesis, Characterization, Reactions and Applications of Polymers*; Pergamon; Oxford, **1989**.
61. Flory, P. J. *Principles of Polymer Chemistry*; Cornell University Press: New York; **1953**.
 62. Munk, P. *Introduction to Macromolecular Science*; Wiley: New York; **1989**.
 63. Hunt, B. J. In *Modern Techniques for Polymer Characterisation*; Pethrick, R.A.; Dawkins, J. V., eds, Wiley: Chichester; **1999**, Chapter 9.
 64. Berry, G. C.; Cotts, P. M. In *Modern Techniques for Polymer Characterisation*; Pethrick, R. A.; Dawkins, J. V., eds, Wiley: Chichester; **1999**, Chapter 4.
 65. Barth, H. G.; Boyes, B. E.; Jackson, C. *Anal. Chem.* **1998**, *70*, 251R–278R.
 66. Rabek, J. F. *Experimental Methods in Polymer Chemistry*; Wiley-Interscience: New York; **1980**.
 67. (a) Hedqvist, H.; Mueller-Harvey, I.; Reed, J. D.; Krueger, C. G.; Murphy, M. *Anim. Feed Sci. Technol.* **2000**, *87*(1–2), 41–56. (b) Adam, N.; Ghosh, P. *Inflamm. Res.* **2001**, *50*, 294–299.
 68. Grubisic, Z.; Rempp, P.; Benoit, H. *J. Polym. Sci., Part B* **1967**, *5*, 753.
 69. Podzimek, S.; Vlcek, T.; Johann, C. *J. Appl. Polym. Sci.* **2001**, *81*(7), 1588–1594.
 70. Romagnoli, B.; Ashton, P. R.; Harwood, L. M.; Philp, D.; Price, D. W.; Smith, M. H.; Hayes, W. *Tetrahedron* **2003**, *59*, 3975–3988.
 71. Karas, M.; Bahr, U.; Deppe, A.; Stahl, B.; Hillenkamp, F.; Giessmann, U. *Makromol. Chem., Macrom. Symp.* **1992**, *61*, 397–404.
 72. Hillenkamp, F.; Karas, M.; Beavis, R. C.; Chait, B. T. *Anal. Chem.* **1991**, *63*(24), A1193–A1202.
 73. Danis, O.; Karr, D. E.; Westmoreland, D. G.; Piton, M. C.; Christie, D. I.; Clay, P. A.; Kable, S. H.; Gilbert, R. G. *Macromolecules* **1993**, *26*, 6684–6685.
 74. Danis, P. O.; Karr, D. E.; Xiong, Y. S.; Owens, K. G. *Rapid. Commun. Mass Spectrom.* **1996**, *10*, 862–868. (b) Danis, P. O.; Karr, D. E. *Org. Mass Spectrom.* **1993**, *28*, 923–925.
 75. Cambell, D.; White, J. R. *Polymer Characterisation; Physical Techniques*; Chapman and Hall: London; **1989**.
 76. Kim, Y.; Priddy, D.; Harwood, H. J. *Polymer* **2003**, *44*(15), 4165–4170.
 77. Ferguson, R. C. *Macromolecules* **1969**, *2*, 237.
 78. Hirai, A.; Mitchell, G. R.; Davis, F. J. *New Polym. Mat.* **1990**, *1*, 251–260.
 79. Caprio, M.; Serra, M. C.; Bowen, D. E.; Grassi, A. *Macromolecules* **2002**, *35*(25), 9315–9322.
 80. Miri, M.; Morales-Tirado, J. A. *J. Chem. Educ.* **2003**, *80*, 839.
 81. Moore, J. S.; Stupp, S. I. *Macromolecules* **1987**, *20*, 273–281.
 82. Schaefer, J. *Macromolecules* **1971**, *4*, 98–104.
 83. Bunn, C. W.; Alcock, T. C. *Trans. Faraday Soc.* **1945**, *41*, 317.
 84. Keith, H. D. *J. Polym. Sci., Part A* **1964**, *2*, 4339.
 85. Sutton, S. J.; Vaughan, A. S.; Bassett, D. C. *Polymer* **1996**, *37*, 5735–5738.
 86. Hemsley, D. A. *Applied Polymer Light Microscopy*; Elsevier: London, UK; **1989**.
 87. Goodhew, P. J.; Humphreys, F. J. *Electron Microscopy and Analysis*; Taylor and Francis: London, UK; **1988**.

88. Rose, M. F. *IEEE Trans. Electr. Insul.* **1987**, EI-22, 555.
89. Billingham, N. C. *Makromol. Chem., Macromol. Symp.* **1989**, 28, 145–163.
90. Faucitano, A.; Buttafava, A.; Martinotti, F.; Bortolus, P.; Comincioli, V. *J. Polym. Sci., Part A: Polym. Chem.* **1987**, 25, 1517–1521.
91. Papet, G.; Audouin-Jirackova, L.; Verdu, J. *Radiat. Phys. Chem.* **1989**, 33, 329–335.
92. Grubb, D. T. *J. Mater. Sci.* **1974**, 9, 1715.
93. Dobb, M. G.; Johnson, D. J.; Saville, B. P. *J. Polym. Sci., Polym. Symp.* **1977**, 58, 237.
94. Voigt-Martin, I. G.; Krug, H.; Van Dyck, D. *J. Phys. France* **1990**, 51, 2347–2371.
95. Lovinger, A. J. *J. Polym. Sci., Polym. Phys. Ed.* **1983**, 21, 97–110.
96. Inoue, T.; Yase, K.; Okada, M.; Okada, S.; Matsuda, H.; Nakanishi, H.; Kato, M. *Jpn. J. Appl. Phys.* **1989**, 28, L2037–L2039.
97. Yase, K.; Inoue, T.; Okada, M. *J. Electron Microsc.* **1990**, 39, 454–458.
98. Haas, K.; Geil, P. H. *J. Polym. Sci., Part A-2: Polym. Phys.* **1966**, 4, 289.
99. Organ, S. J.; Keller, A. *J. Polym. Sci., Part B: Polym. Phys.* **1987**, 25, 2409–2430.
100. Plummer, H. K. *Microsc. Microanal.* **1997**, 3, 239–260.
101. Butler, M. F.; Donald, A. M. *J. Mater. Sci.* **1997**, 32, 3675–3685.
102. Izumi, K.; Ping, G.; Toda, A.; Miyaji, H.; Miyamoto, Y. *Jpn. J. Appl. Phys.* **1992**, 31, L626–L627.
103. Zhao, Y.; Zhang, W.; Yang, D. *J. Mater. Sci. Lett.* **1993**, 12, 1309–1312.
104. Minto, C. D. G.; Vaughan, A. S. *J. Mater. Sci.* **1995**, 30, 6028–6034.
105. Han, J. H. *Polymer* **1995**, 36, 2451–2462.
106. Chou, T. M.; Prayoonthong, P.; Aitouchen, A.; Libera, M. *Polymer* **2002**, 43, 2085–2088.
107. Ishizu, K.; Omote, A.; Fukutomi, T. *Polymer* **1990**, 31, 2135–2140.
108. Vitali, R.; Montani, E. *Polymer* **1980**, 21, 1220.
109. Li, C.; Cooper, S. L. *Polymer* **1990**, 31, 3–7.
110. González-Montiel, A.; Keskkula, H.; Paul, D. R. *Polymer* **1995**, 36, 4587–4603.
111. Kunz, M.; Drechsler, M.; Möller, M. *Polymer* **1995**, 36, 1331–1339.
112. Trent, J. S.; Scheinbeim, J. I.; Couchman, P. R. *Macromolecules* **1983**, 16, 589–598.
113. (a) Kanig, G. *Kolloid Z. Z. Polym.* **1973**, 251, 782. (b) Zhou, H.; Wilkes, G. L. *Polymer* **1997**, 38, 5735–5747. (c) Cedeño, A.; Puig, C. C. *J. Macromol. Sci., Phys.* **1999**, B38, 505–514. (d) Borsig, E.; Fiedlerova, A.; Greco, R.; Michler, G. H.; Pionteck, J.; Schultze, U. *J. Macromol. Sci., Phys.* **1999**, B38, 541–547.
114. (a) Martinez-Salazar, J.; Cannon, C. G. *J. Mater. Sci. Lett.* **1984**, 3, 693–694. (b) Muratoglu, O. K.; Argon, A. S.; Cohen, R. E.; Weinberg, M. *Polymer* **1995**, 36, 921–930.
115. Michler, G. H. *Polymer* **1986**, 27, 323–328.
116. (a) Sue, H. J.; Garcia-Meitin, E. I.; Burton, B. L.; Garrison, C. C. *J. Polym. Sci., Part B: Polym. Phys.* **1991**, 29, 1623–1631. (b) Zhang, X.; Li, G.; Wang, D.; Yin, Z.; Yin, J.; Li, J. *Polymer* **1998**, 39, 15–21. (c) Baltá Calleja, F. J.; Rueda, D. R.; Michler, G. H.; Naumann, I. *J. Macromol. Sci., Phys.* **1998**, B37, 411–419.
117. Shibazaki, H.; Kuga, S.; Onabe, F.; Brown, R. M. *Polymer* **1995**, 36, 4971–4976.

118. Kakugo, M.; Sadatoshi, H.; Yokoyama, M.; Kojima, K. *Macromolecules* **1989**, *22*, 547–551.
119. Sawyer, L. C.; Grubb, D. T. *Polymer Microscopy*; Chapman and Hall: London, UK; **1996**.
120. Wilfong, D. L.; Hiltner, A.; Baer, E. *J. Mater. Sci.* **1986**, *21*, 2014–2026.
121. Young, R. J. *Introduction to Polymers*; Chapman and Hall: London, UK; **1981**.
122. Bassett, D. C.; Hodge, A. M. *Proc. R. Soc. London, Ser. A* **1978**, *359*, 121.
123. Nutting, J.; Cosslett, V. E. In *Metallurgical Applications of the Electron Microscope*; Institute of Metals: London, UK; **1950**, p. 65.
124. Burrells, W. *Microscope Technique*; Fountain Press: London, UK; **1977**.
125. (a) Bartosiewicz, L.; Mencik, Z. *J. Polym. Sci., Polym. Phys. Ed.* **1974**, *12*, 1163. (b) Di Corleto, J. A.; Bassett, D. C. *Polymer* **1990**, *31*, 1971–1977. (c) Deblieck, R. A. C.; Mathot, V. B. F. *J. Mater. Sci. Lett.* **1988**, *7*, 1276–1280. (d) Mirabella, F. M.; Westphal, S. P.; Fernando, P. L.; Ford, E. A.; Williams, J. G. *J. Polym. Sci., Part B: Polym. Phys.* **1988**, *26*, 1995–2005. (e) Mao, L. J.; Zhang, Z. P.; Ying, S. K. *Polym. Commun.* **1991**, *32*, 242–244.
126. (a) Bassett, D. C.; Olley, R. H.; Al Raheil, I. A. M. *Polymer* **1988**, *29*, 1539–1543. (b) Minto, C. D. G.; Vaughan, A. S. *Synth. Met.* **1996**, *81*, 81–86. (c) Yang, C. Y.; Reghu, M.; Heeger, A. J.; Cao, Y. *Synth. Met.* **1996**, *79*, 27–32. (d) van Gisbergen, J. G. M.; Meijer, H. E. H.; Lemstra, P. J. *Polymer* **1989**, *30*, 2153–2157. (e) Petrović, Z. S.; Budinski-Simendić, J.; Divjaković, V. *J. Appl. Polym. Sci.* **1991**, *42*, 779–790. (f) Briber, R. M.; Khoury, F. *J. Polym. Sci., Part B: Polym. Phys.* **1993**, *31*, 1253–1272. (g) Burgisi, G.; Paternoster, M.; Peduto, N.; Saraceno, A. *J. Appl. Polym. Sci.* **1997**, *66*, 777–787.
127. Afshari, M.; Kotek, R.; Kish, M. H.; Dast, H. N.; Gupta, B.S. *Polymer* **2002**, *43*, 1331–1341.
128. Vaughan, A. S. *J. Mater. Sci.* **1993**, *28*, 1805–1813.
129. (a) Fitchmun, D. R.; Mencik, Z. *J. Polym. Sci., Polym. Phys. Ed.* **1973**, *11*, 951. (b) Armond, V. J.; Atkinson, J. R. *J. Mater. Sci.* **1969**, *4*, 509.
130. Rybníkář, F. *J. Appl. Polym. Sci.* **1985**, *30*, 1949–1961.
131. Heberer, D. P.; Cheng, S. Z. D.; Barley, J. S.; Lien, S. H.-S.; Bryant, R. G.; Harris, F. W. *Macromolecules* **1991**, *24*, 1890–1898.
132. (a) Bu, H. S.; Cheng, S. Z. D.; Wunderlich, B. *Polymer Bulletin* **1987**, *17*, 567–571. (b) Bu, H. S.; Cheng, S. Z. D.; Wunderlich, B. *Polymer* **1988**, *29*, 1603–1607.
133. Organ, S. J.; Barham, P. J. *J. Mater. Sci. Lett.* **1989**, *8*, 621–623.
134. (a) Miyagi, A.; Wunderlich, B. *J. Polym. Sci., Polym. Phys. Ed.* **1972**, *10*, 2073. (b) Chu, C.-M.; Wilkes, G. L. *J. Macromol. Sci., Phys.* **1974**, *B10*, 551. (c) Joseph, E.; Wilkes, G. L.; Baird, D. G. *Polymer* **1985**, *26*, 689–703.
135. Eastmond, G. C.; Smith, E. G. *Polymer* **1973**, *14*, 509.
136. Winerich, D.; Siegmann, A.; Narkis, M. *J. Macromol. Sci., Phys.* **1997**, *B36*, 247–262.
137. Hobbs, S. Y.; Dekkers, M. E. J.; Watkins, V. H. *J. Mater. Sci.* **1988**, *23*, 1219–1224.
138. Kong, Y.; Hay, J. N. *Polymer* **2002**, *43*, 1805–1811.
139. (a) Norton, D. R.; Keller, A. *Polymer* **1985**, *26*, 704–716. (b) Hill, M. J.; Barham, P. J.; Keller, A.; Rosney, C. C. A. *Polymer* **1991**, *32*, 1384–1393. (c) Lemmon, T. J.; Hanna, S.; Windle, A. H. *Polym. Commun.* **1989**, *30*, 2–4. (d) Vaughan, A. S.; *Polymer* **1992**, *33*, 2513–2521. (e) Patel, D.; Bassett, D. C. *Proc. R. Soc. London, Ser. A* **1994**, *445*, 577–599. (f) Parker, J. A.; Bassett, D. C.;

- Olley, R. H.; Jääskeläinen, P. *Polymer* **1994**, *35*, 4140–4145. (g) Bassett, D. C.; Olley, R. H.; Sutton, S. J.; Vaughan, A. S. *Polymer* **1996**, *37*, 4993–4997.
140. Muccigrosso, J.; Phillips, P. J. *IEEE Trans. Electr. Insul.* **1978**, *EI-13*, 172.
141. Barnes, S. R. *Polymer* **1980**, *21*, 723.
142. Voigt-Martin, I. G.; Mandelkern, L. *J. Polym. Sci., Part B: Polym. Phys.* **1989**, *27*, 967–991.
143. Mijovic, J. S.; Koutsky, J. A. *Polym. Plast. Technol. Eng.* **1977**, *9*, 139.
144. Olley, R. H. *Sci. Prog. Oxf.* **1986**, *70*, 17–43.
145. Lee, R. E. *Scanning Electron Microscopy and X-ray Analysis*; Prentice Hall: New Jersey, USA; **1993**.
146. Haworth, C. W. In *Electron Microscopy and Microanalysis of Crystalline Materials*; Belk, J. A., ed., Applied Science: London, UK; **1979**, p. 157.
147. Bishop, H. E. In *Quantitative Scanning Electron Microscopy*; Holt, D. B.; Muir, M. D.; Grant, P. R.; Boswarva, I. M., eds, Academic Press: London, UK; **1974**, p. 41.
148. Henry, L.; Lamothe, V.; Antoine, J.; Soumireu-Lartigue, S.; Bakis, P.; Vibert, C. *Microsc. Anal.* **2000**, *75*, 29.
149. Postema, A. R.; Hoogsteen, W.; Pennings, A. J. *Polym. Commun.* **1987**, *28*, 148–150.
150. Sakai, Y.; Miyasaka, K. *Polymer* **1990**, *31*, 51–57.
151. Chu, C. M.; Wilkes, G. L. *J. Macromol. Sci., Phys.* **1974**, *B10*, 231.
152. Shabana, H. M.; Guo, W.; Olley, R. H.; Bassett, D. C. *Polymer* **1993**, *34*, 1313–1315.
153. Sutton, S. J.; Vaughan, A. S. *J. Mater. Sci.* **1993**, *28*, 4962–4969.
154. Tomasi, G.; Scandola, M.; Briese, B. H.; Jendrossek, D. *Macromolecules* **1996**, *29*, 507–513.
155. Thronguang, W.; Spontak, R. J.; and Balik, C. M. *Polymer* **2002**, *43*, 2279–2286.
156. Okamoto, M.; Shiomi, K.; Inoue, T. *Polymer* **1995**, *36*, 87–91.
157. (a) Goizueta, G.; Chiba, T.; Inoue, T. *Polymer* **1992**, *33*, 886. (b) Goizueta, G.; Chiba, T.; Inoue, T. *Polymer* **1993**, *34*, 253–256.
158. Vezie, D. L.; Thomas, E. L.; Adams, W. W. *Polymer* **1995**, *36*, 1761–1779.
159. Brown, G. M.; Butler, J. H. *Polymer* **1997**, *38*, 3937–3945.
160. Spence, J. C. H. In *High Resolution Transmission Electron Microscopy and Associated Techniques*; Buseck, P. R.; Cowley, J. M.; Eyring, L., eds, Oxford University Press: Oxford, UK; **1992**, p. 129.
161. Tetley, L.; Huxham, M. *Microscopy and Analysis* **1992**, *28*, 15.
162. Mayer, J. *Microsc. Anal.* **1992**, *27*, 28.
163. Fillard, J. P. *Near Field Optics and Nanoscopy*; World Scientific: Singapore; **1998**.
164. (a) Wilson, T. In *Confocal Microscopy*; Wilson, T. ed., Academic Press: London; **1990**, p. 10. (b) Hoheisel, W.; Jacobsen, W.; Lutge, B.; Weiner, W. *Macromol. Mater. Eng.* **2001**, *286*, 663–668. (c) Tabaksblat, R.; Meier, R. J.; Kip, B. J. *Appl. Spectrosc.* **1992**, *46*, 60–68. (d) Williams, K. P. J.; Pitt, G. D.; Batchelder, D. N.; Kip, B. J. *Appl. Spectrosc.* **1994**, *48*, 232–235.
165. (a) Turrell, G.; Dhamelincoart, P. In *Modern Techniques in Raman Spectroscopy*; Laserna, J. J., ed., Wiley: London; **1996**, p. 116. (b) Everall, N. J. *Appl. Spectrosc.* **2000**, *54*, 773–782. (c) Everall, N. J. *Appl. Spectrosc.* **2000**, *54*, 1515–1520. (d) Michielsen, S. *J. Appl. Polym. Sci.* **2001**, *81*, 1662–1669. (e) Reinecke, H.;

- Spells, S. J.; Sacristan, J.; Yarwood, J.; Mijangos, C. *Appl. Spectrosc.* **2001**, *55*, 1660–1664. (f) Baldwin, K. J.; Batchelder, D. N. *Appl. Spectrosc.* **2001**, *55*, 517–524. (g) Baia, L.; Gigant, K.; Posset, U.; Schottner, G.; Kiefer, W.; Popp, J. *Appl. Spectrosc.* **2002**, *56*, 536–540. (h) Bruneel, J. L.; Lassegues, J. C.; Sourisseau, C. *J. Raman Spectrosc.* **2002**, *33*, 815–828. (i) van den Brink, M.; Pepers, M.; van Herk, A. M. *J. Raman Spectrosc.* **2002**, *33*, 264–272.
166. (a) Hajatdoost, S.; Yarwood, J. *Appl. Spectrosc.* **1996**, *50*, 558–564. (b) Hajatdoost, S.; Olsthoorn, M.; Yarwood, J. *Appl. Spectrosc.* **1997**, *51*, 1784–1790. (c) Mura, C.; Yarwood, J.; Swart, R.; Hodge, D. *Polymer* **2000**, *41*, 8659–8671. (d) Eaton, P.; Holmes, P.; Yarwood, J. *J. Appl. Polym. Sci.* **2001**, *82*, 2016–2026. (e) Sammon, C.; Mura, C.; Eaton, P.; Yarwood, J. *Analisis* **2000**, *28*, 30–34. (f) Sacristan, J.; Mijangos, C.; Reinecke, H.; Spells, S.; Yarwood, J. *Macromol. Rapid Commun.* **2000**, *21*, 894–896. (g) Sacristan, J.; Mijangos, C.; Reinecke, H.; Spells, S.; Yarwood, J. *Macromolecules* **2000**, *33*, 6134–6139. (h) Eaton, P.; Holmes, P.; Yarwood, J. *Appl. Spectrosc.* **2000**, *54*, 508–516.
167. Binnig, G.; Rohrer, H. *Helv. Phys. Acta* **1982**, *55*, 726–735.
168. Grissom, C. A.; Charola, A. E.; Wachowiak, M. J. *Stud. Conserv.* **2000**, *45*, 73–74.
169. (a) Stocker, W.; Graff, S.; Lang, J.; Wittmann, J. C.; Lotz, B. *Macromolecules* **1994**, *27*, 6677–6678. (b) Mezghani, K.; Phillips, P. J. *Polymer* **1997**, *38*, 5725–5733. (c) Winkel, A. K.; Miles, M. J. *Polymer* **2000**, *41*, 2313–2317. (d) Drummond, K. M.; Shanks, R. A.; Cser, F. *J. Appl. Polym. Sci.* **2002**, *83*, 777–784.
170. (a) Li, L.; Chan, C. M.; Li, J. X.; Ng, K. M.; Yeung, K. L.; Weng, L. T. *Macromolecules* **1999**, *32*, 8240–8242. (b) Ivanov, D. A.; Nysten, B.; Jonas, A. M. *Polymer* **1999**, *40*, 5899–5905. (c) Beekmans, L. G. M.; Vansco, G. J. *Polymer* **2000**, *41*, 8975–8981. (d) Winkel, A. K.; Hobbs, J. K.; Miles, M. J. *Polymer* **2000**, *41*, 8791–8800. (e) Heck, B.; Hugel, T.; Ijima, M.; Strobl, G. *Polymer* **2000**, *41*, 8830–8848. (f) Li, L.; Chan, C. M.; Yeung, K. L.; Li, J. X.; Ng, K. M.; Lei, Y. G. *Macromolecules* **2001**, *34*, 316–325. (g) Hobbs, J. K.; Miles, M. J. *Macromolecules* **2001**, *34*, 353–355. (h) Hobbs, J. K.; Humphris, A. D. L.; Miles, M. J. *Macromolecules* **2001**, *34*, 5508–5519. (i) Lei, Y.; Chan, C. M.; Li, J. X.; Ng, K. M.; Wang, Y.; Jiang, Y.; Li, L. *Macromolecules* **2002**, *35*, 6751–6753. (j) De Cupere, V. M.; Rouxhet, P. G. *Polymer* **2002**, *43*, 5571–5576. Schönherr, H.; Waymouth, R. M.; and Frank, C. W. *Macromolecules* **2003**, *36*, 2412–2418. (k) Lei, Y.; Chan, C. M.; Wang, Y.; Ng, K. M.; Jiang, Y.; Li, L. *Polymer* **2003**, *44*, 4673–4679.
171. (a) Schönherr, H.; Snétivy, D.; Vancso, G. J. *Polym. Bull.* **1993**, *30*, 567–574. (b) Sutton, S. J.; Izumi, K.; Mijaji, H.; Fukao, K.; Miyamoto, Y. *Polymer* **1996**, *37*, 5529–5532. (c) Zhou, H. Y.; Wilkes, G. L. *Polymer* **1997**, *38*, 5735–5747. (d) Trifonova, D.; Varga, J.; Vancso, G. J. *Polym. Bull.* **1998**, *41*, 341–348. (e) Trifonova-Van Haeringen, D.; Varga, J.; Ehrenstein, G. W.; Vancso, G. J. *J. Polym. Sci., Part B: Polym. Phys.* **2000**, *38*, 672–681. (f) Vancso, G. J.; Beekmans, L. G. M.; Pearce, R.; Trifonova, D.; Varga, J. *J. Macromol. Sci., Phys.* **1999**, *B38*, 491–503.
172. White, H.; Fenton, J. *Microsc. Anal.* **2003**, *96*, 9.
173. Dufrière, Y. F. *Microsc. Anal.* **2003**, *97*, 9.
174. Nazarov, M. V.; Nazarova, T. A.; Dub, S. N.; Banini, G. K. *Microsc. Anal.* **2003**, *97*, 13.

175. Gracias, D. H.; Somorjai, G. A. *Macromolecules* **1998**, *31*, 1269–1276.
176. Humphris, A. D. L.; Hobbs, J. K.; Miles, M. J. *Appl. Phys. Lett.* **2003**, *83*, 6–8.
177. Weisendanger, R. *Scanning Probe Microscopy and Spectroscopy—Methods and Applications*; Cambridge University Press: Cambridge, UK; **1994**.
178. Wetton, R. E. In *Polymer Characterization*; Hunt, B. I.; James, M. I., eds, Blackie: London, UK; **1993**, p. 178.
179. Schawe, J. E. K.; Shick, C.; Höhne, G. W. H. *Thermochim. Acta* **1993**, *229*, 37–52.
180. Bassett, D. C.; Turner, B. *Nat. Phys. Sci.* **1972**, *240*, 146.
181. Hokosaka, M.; Minomura, S.; Seto, T. *Jpn. J. Appl. Phys.* **1980**, *19*, 1763.
182. Takamizawa, K.; Sasaki, Y.; Kono, K.; Urabe, Y. *Rep. Prog. Polym. Phys. Jpn.* **1976**, *19*, 285.
183. Turner, B. *High Temp. High Press.* **1973**, *5*, 273.
184. Arntz, H. *Rev. Sci. Instrum.* **1980**, *51*, 965.
185. Overbergh, N.; Berghmans, H.; Smets, G. *J. Polym. Sci., Part C* **1972**, *38*, 237.
186. Cheng, S. Z. D.; Bu, H. S.; Wunderlich, B. *J. Polym. Sci., Part B: Polym. Phys.* **1988**, *26*, 1947–1964.
187. Zhao, Y.; Vaughan, A. S.; Sutton, S. J.; Swingler, S. G. *Polymer* **2001**, *42*, 6587–6597.
188. Holdsworth, P. J.; Turner-Jones, A. *Polymer* **1971**, *12*, 195.
189. Zhou, C. X.; Clough, S. B. *Polym. Eng. Sci.* **1988**, *28*, 65–68.
190. Tanem, B. S.; Stori, A. *Polymer* **2001**, *42*, 6609–6918.
191. Hosier, I. L.; Vaughan, A. S.; Swingler, S. G. *J. Polym. Sci., Part B: Polym. Phys.* **2000**, *38*, 2309–2322.
192. (a) Blundell, D. J. *Polymer* **1987**, *28*, 2248–2251. (b) Lee, Y. C.; Porter, R. S. *Macromolecules* **1987**, *20*, 1336–1341. (c) Bassett, D. C.; Olley, R. H.; Al Raheil, I. A. M. *Polymer* **1988**, *29*, 1745–1754. (d) Marand, H.; Prasad, A. *Macromolecules* **1992**, *25*, 1731–1736.
193. Gabbott, P.; Clarke, P.; Mann, T.; Royall, P.; Shergill, S. *Am. Lab.* **2003**, *35*, 17.
194. (a) Dean, K.; Cook, W. D.; Burchill, P.; Zipper, M. *Polymer* **2001**, *42*, 3589–3601. (b) Liu, Y. L.; Chen, Y. J.; Wei, W. L. *Polymer* **2003**, *44*, 6465–6473. (c) Agag, Y.; Takeichi, T. *Macromolecules* **2003**, *36*, 6010–6017.
195. Pospíšil, J.; Horák, Z.; Pilař, J.; Billingham, N. C.; Zweifel, H.; Nešpůrek, S. *Polym. Degrad. Stabil.* **2003**, *82*, 145.
196. Somani, P. R.; Marimuthu, R.; Viswanath, A. K.; Radhakrishnan, S. *Polym. Degrad. Stabil.* **2003**, *79*, 77.
197. Janigová, I.; Lacík, I.; Chodák, I. *Polym. Degrad. Stabil.* **2002**, *77*, 35.
198. Cheng, S. Z. D. *J. Appl. Polym. Sci., Appl. Polym. Symp.* **1989**, *43*, 315.
199. Boyer, R. F. *J. Appl. Polym. Sci.* **1987**, *33*, 955–969.
200. Fried, J. R.; Karasz, F. E.; MacKnight, W. J. *Macromolecules* **1978**, *11*, 150.
201. Gomez Ribelles, J. L.; Dias-Calleja, R.; Ferguson, R.; Cowie, J. M. G. *Polymer* **1987**, *28*, 2262–2266.
202. Reading, M.; Luget, A.; Wilson, R. *Thermochimica Acta* **1994**, *238*, 295.
203. Divito, M. P.; Cassel, R. B.; Marguiles, M.; Goodkowsky, S. *Am. Lab.* **1995**, *27*, 28.
204. Schawe, J. E. K. *Thermochim. Acta* **1996**, *271*, 127–140.
205. (a) Schawe, J. E. K. *Thermochim. Acta* **1995**, *261*, 183–194. (b) Schawe, J. E. K. *J. Therm. Anal.* **1996**, *47*, 475–484.
206. Toda, A.; Tomita, C.; Hikosaka, M. *Prog. Theor. Phys. Supp.* **1997**, *126*, 103–106.
207. Zhang, J.; Richardson, M. O. W. *Polymer* **2000**, *41*, 6843–6849.

1: Polymer characterization

208. Schawe, J. E. K. *Thermochim. Acta* **1995**, 260, 1–16.
209. Jones, K. J.; Kinshott, I.; Reading, M.; Lacey, A. A.; Nikolopoulos, C.; Pollock, H. M. *Thermochim. Acta* **1997**, 304/305, 187–199.
210. (a) Toda, A.; Oda, T.; Hikosaka, M.; Saruyama, Y. *Thermochim. Acta* **1997**, 293, 47–63. (b) Toda, A.; Tomita, C.; Hikosaka, M.; Saruyama, Y. *Polymer* **1998**, 39, 1439–1443. (c) Chen, W.; Moon, I. -K.; Wunderlich, B. *Polymer* **2000**, 41, 4119–4125. (d) Toda, A.; Arita, T.; Tomita, C.; Hikosaka, M. *Polymer* **2000**, 41, 8941–8951.
211. Gradin, P.; Howgate, P. G.; Seldén, R.; Brown, R. A. In *Comprehensive Polymer Science*; Booth, C.; Price, C., eds, Pergamon Press: Oxford, UK; **1989**, Vol. 2, Polymer Properties, p. 533.
212. (a) Dunbar, J. H.; North, A. M.; Pethrick, R. A.; Steinhauser, D. B. *J. Chem. Soc., Faraday Trans. 2* **1975**, 71, 1478. (b) Payne, A. R.; Whittaker, R. E.; Smith, F. J. *J. Appl. Polym. Sci.* **1972**, 16, 1191.
213. (a) Wyn-Jones, E.; Crook, K. R. *J. Phys. Chem.* **1969**, 30, 3450. (b) North, A. M.; Pethrick, R. A.; Rhoney, I. *J. Chem. Soc., Faraday Trans. 2* **1974**, 70, 223. (c) Dunbar, J. H.; North, A. M.; Pethrick, R. A.; Steinhauser, D. B. *J. Polym. Sci., Polym. Phys. Ed.* **1977**, 15, 263. (d) Bhagawan, S. S.; Tripathy, D. K.; De, S. K. *J. Appl. Polym. Sci.* **1987**, 34, 1581–1601.
214. (a) Starkweather, H. W. In *Water in Polymers*; Rowland, S. P., ed., ACS Symposium Series 127, **1980**, p. 433. (b) Soulier, J. P.; Berruet, R.; Chateauminois, A.; Chabert, B.; Gauthier, R. *Polym. Commun.* **1988**, 29, 243–246.
215. Kolařík, J.; Janáček, J. *J. Polym. Sci., Part C* **1967**, 16, 441.
216. Arrighi, V.; McEwen, I. J.; Qian, H.; Serrano Pioto, M. B. *Polymer* **2003**, 44, 6259–6266.
217. Ward, I. M.; Hadley, D. W. *Mechanical Properties of Solid Polymers*; Wiley: Chichester, UK; **1993**.
218. Molnár, A.; Eisenberg, A. *Macromolecules* **1992**, 25, 5774–5782.
219. Goodwin, A. A.; Simon, G. P. *Polymer* **1997**, 38, 2363–2370.
220. Chuang, H. K.; Han, C. D. *Adv. Chem. Ser.* **1984**, 204, 171–183.
221. Hagen, R.; Weiss, R. A. *Polymer* **1995**, 24, 4657–4664.
222. Meseguer Duñas, J. M.; Torres Escuriola, D.; Gallego Ferrer, G.; Monleón Pradas, M.; Gómez Ribelles, J. L.; Pissis, P.; Kyritsis, A. *Macromolecules* **2001**, 34, 5525–5534.
223. Ohkoshi, I.; Abe, H.; Doi, Y. *Polymer* **2000**, 41, 5985–5992.
224. Nandan, B.; Kandpal, L. D.; Mathur, G. N. *Polymer* **2003**, 44, 1267–1279.
225. Woo, L.; Westphal, S.; Ling, M. T. K. *Polym. Eng. Sci.* **1994**, 34, 420–427.
226. McCrum, N. G.; Morris, E. L. *Proc. R. Soc. London Ser. A* **1966**, 292, 506.
227. Woo, L.; Westphal, S.; Ling, M. T. K. *Thermochim. Acta* **1993**, 226, 85–98.
228. Woo, L.; Westphal, S.; Ling, M. T. K. *Thermochim. Acta* **1994**, 243, 147–154.
229. (a) Sinnot, K. M. *J. Appl. Phys.* **1966**, 37, 3385. (b) Lee, H.; Cho, K.; Ahn, T.-K.; Choe, S.; Kim, I.-J.; Park, I.; Lee, B. H. *J. Polym. Sci., Part B: Polym. Phys.* **1997**, 35, 1633–1642.
230. McCrum, N. G.; Read, B. E.; Williams, G. *Anelastic and Dielectric Effects in Polymeric Solids*; Wiley: London, UK; **1967**.
231. Pratt, G. J.; Smith, M. J. A. *Polymer* **1986**, 27, 1483–1488.
232. Williams, G. In *Comprehensive Polymer Science*; Booth, C.; Price, C., eds, Pergamon Press: Oxford, UK; **1989**, Vol. 2, Polymer Properties, p. 601.

233. Starkweather, H. W.; Avakian, P.; Fontanella, J. J.; Wintersgill, M. C. *Macromolecules* **1992**, *25*, 7145–7149.
234. (a) Barrie, I. T.; Buckingham, K. A.; Reddish, W. *IEE Proc.* **1966**, *113*, 1849. (b) Bánhegyi, G.; Karasz, F. E. *Colloid Polym. Sci.* **1987**, *265*, 394–405.
235. (a) La Mantia, F. P.; Schifani, R. *Polym. Degrad. Stabil.* **1985**, *10*, 67–78. (b) Iida, K.; Nakamura, S.; Ieda, M.; Ito, K.; Sawa, G. *Polym. J.* **1987**, *8*, 905–913.
236. (a) Wentworth, S. E.; Goydan, R. *J. Polym. Sci., Part C—Polym. Lett.* **1986**, *24*, 159–163. (b) Aldrich, P. D.; Thurow, S. K.; McKennon, M. J.; Lyssy, M. E. *Polymer* **1987**, *28*, 2289–2296.
237. Perusich, S. A.; Avakian, P.; Keating, M. Y. *Macromolecules* **1993**, *26*, 4756–4764.
238. Simon, G. P.; Schönhals, A. In *Polymer Characterization Techniques and Their Application to Blends*; Simon, G. P., ed., ACS: Washington D.C., USA; **2003**, p. 96.
239. (a) Skinner, J. L.; Park, Y. H. *Macromolecules* **1984**, *17*, 1735–1740. (b) Mowrey, S. W.; Rutledge, G. C. *Macromolecules* **2002**, *35*, 4539–4549. (c) Vaisman, L.; Fernanda González, M.; Marom, G. *Polymer* **2003**, *44*, 1229–1235.
240. Suljovrujić, E. *Polymer* **2002**, *43*, 5969–5978.
241. (a) Diaz-Calleja, R.; Gómez, J. L.; Ribes, A.; Riande, E.; Guzmán, J. *Macromolecules* **1988**, *21*, 2121–2127. (b) Maxwell, A. S.; Monnerie, L.; Ward, I. M. *Polymer* **1998**, *26*, 6851–6859. (c) Salmerón, M.; Gallego Ferrer, G.; Torregrosa Cabanilles, C.; Meseguer Duñas, J. M.; Monleón Pradas, M.; Gómez Ribelles, J. L. *Polymer* **2001**, *42*, 10 071–10 075.
242. Roe, R.-J. *Methods of X-ray and Neutron Scattering in Polymer Science*; Oxford University Press: New York; **2000**.
243. Batla-Calleja, F. J.; Vonk, C. G. *X-ray Scattering of Synthetic Polymers*; Elsevier: New York; **1989**.
244. Mitchell, G. R. In *X-ray Scattering from Non-crystalline and Liquid Crystalline Polymers in Comprehensive Polymer Science*; Allen, G.; Bevington, J., eds, Pergamon Press: New York; **1989**, Vol. 1, Chap. 31, pp. 687–729.
245. Siripitayananon, J.; Molloy, R.; Mitchell, G. R., to be submitted to *J. Polym. Sci. Polym. Phys. Ed.*
246. Mitchell, G. R.; Proctor, A. D.; Gilbert, A. *J. Polym. Sci., Part C: Polym. Lett.* **1990**, *28*, 423–433.
247. Tadokoro, H. *Structure of Crystalline Polymers*; Wiley: New York; **1979**.
248. Donald, A. M.; Windle, A. H. *Liquid Crystalline Polymers*; Cambridge University Press: New York; **1992**.
249. For example, see www.ill.fr or www.isis.rl.ac.uk
250. Higgins, J. S.; Benoit, H. C. *Polymers and Neutron Scattering*; Clarendon Press: Oxford; **1994**.
251. Mitchell, G. R.; Rosi, B.; Ward, D. J. *Philos. Trans. R. Soc. London, Ser. A* **1994**, *348*, 97–115.
252. Siripitayananon, J.; Mitchell, G. R., to be submitted to *Polymer*.
253. Mitchell, G. R.; Davis, F. J.; Cywinski, R.; Howells, W. S. *J. Phys. C: Solid State Phys.* **1988**, *21*, L411.
254. King, S. M. In *Modern Techniques for Polymer Characterisation*, Pethrick, R. A.; Dawkins, J. V., eds, Wiley; **1999**, Chap. 7.
255. Thornley, S. A.; Mitchell, G. R., to appear in *Polymer*.

General procedures in chain-growth polymerization

NAJIB ARAGRAG, DARIO C. CASTIGLIONE, PAUL R. DAVIES,
FRED J. DAVIS, and SANGDIL I. PATEL

1. Introduction

This chapter is intended to provide a general introduction to the laboratory techniques used in polymer synthesis, by focusing on some relatively well-known polymerizations that occur by chain-growth processes. In this way some of the more commonly used procedures in polymer chemistry are described. Due to the nature of the intermediates produced,¹ such as free radicals, carbanions, carbocations, together with a range of organometallic species, the techniques often involve handling compounds in the complete absence of oxygen and moisture. Because of this the best results may require quite sophisticated equipment and glassware;² however, it is our intention to show that the general procedures are accessible to any reasonably equipped laboratory, and indeed some of the techniques are suitable for use in an undergraduate teaching laboratory.³⁻⁵

Chain-growth polymerization involves the sequential step-wise addition of monomer to a growing chain. Usually, the monomer is unsaturated, almost always a derivative of ethene, and most commonly vinylic, that is, a mono-substituted ethane, **1** particularly where the growing chain is a free radical. For such monomers, the polymerization process is classified by the way in which polymerization is initiated and thus the nature of the propagating chain, namely anionic, cationic, or free radical; polymerization by coordination catalyst is generally considered separately as the nature of the growing chain-end may be less clear and coordination may bring about a substantial level of control not possible with other methods.⁶

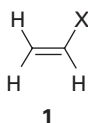

Structure 1

Ring-opening polymerizations exhibit many of the features of chain-growth polymerization, but may also show some of the features expected from step-growth polymerizations.⁷ However, it is probably fair to say that from a practical point of view the techniques involved are rather similar or the same as those used in chain-growth processes and consequently some examples of ring-opening processes are provided here.

It is particularly instructive to consider the requirements of chain-growth compared to step-growth processes in terms of the demands for reagent purity and reaction conditions. In both cases monomer purity is of the highest importance, but it should be remembered that for a chain-growth process only a tiny fraction (depending, of course, on the molecular weight) of monomer molecules react with initiator and consequently there is the potential for massive inhibition of the reaction by traces of impurities, the classic example being the inhibition of free-radical chain-growth polymerization by small quantities of phenolic compounds. Indeed, use is made of this property in the stabilization of monomers and compounds such as **2** are added to commercial monomer samples to prevent polymerization prior to use. These need to be removed prior to use; *vide infra*. Water and oxygen may also need to be removed and often this necessitates the use of vacuum lines and other equipment used typically for air- and moisture-sensitive materials. In the case of step-growth polymerization, the crucial need is to avoid the presence of monofunctional units that can cap the polymerization and of course any unknown material that might inadvertently effect the stoichiometry—here high molecular weights are only possible at high conversions as dictated by Carother's equation (see Chapter 4).

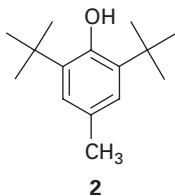

Structure 2

2. Free-radical chain polymerization

This is perhaps the most well-known method of polymerization, and as the name implies, involves the continuous addition of monomer units to a growing free-radical chain.⁸ The general mechanism of this process in relation to the polymerization of a vinyl monomer is shown in Scheme 1. As Scheme 1 shows, initiation is a two-stage process in which, first a free radical is formed, and second this radical adds on to a monomer unit. The second stage is essentially the same for

2: General procedures in chain-growth polymerization

all the related processes; however, the first step can be achieved in a variety of ways; and the type of initiator depends on the nature of the polymerization experiment. In a laboratory, 2,2'-azo-bisisobutyronitrile (AIBN), in a sealed tube is usually the initiator of choice for this and other free-radical processes presumably because of the convenient timescale of its decomposition (Scheme 2) of about 18 h at 60°C. More commonly used in an industrial setting are peroxides and, in an aqueous or mixed environment, inorganic initiators such as persulfate and other redox systems. Electromagnetic radiation, usually visible or ultraviolet light but occasionally higher energy radiations such as X- and γ -rays are also of some importance,⁹ photoinitiators often being used to cure preformed polymer chains by the polymerization of pendant polymerizable side-groups.^{10*} Some examples of free-radical initiators in common use are listed in Table 2.1.^{11,12} In some cases, polymerization apparently occurs in the absence of any added initiator; here polymerization is induced by adventitious free-radical production.[†] The propagation step is, of course, the core of the process, but as in all chain-growth processes, it is the number of monomer units that are added for each initiator molecule that determines the molecular weight of the final material. In the case of free-radical polymerization this is controlled by considering the processes involved in terminating the growing chain; often these involve radical-radical combinations and high molecular weights are favoured by keeping the concentration of free radicals low. In the ideal case, that is, where there is no chain transfer, the number average degree of polymerization is related to the initiator concentration by eqn (1).

$$x_n = \frac{[\text{Monomer}]}{\sqrt{[\text{Initiator}]}} \quad (1)$$

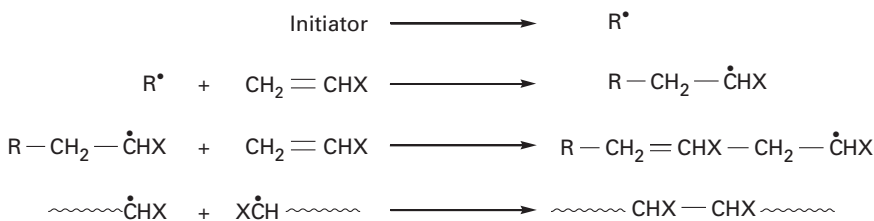

Scheme 1 Mechanism of free-radical polymerization.

* It must also be noted here that not all photoinitiators initiate free-radical polymerization, for example, the use of onium salts as photoinitiators is based on their ability to initiate cationic polymerization processes.

† A bottle of styrene left untouched for long periods will be found to have polymerized even though the inhibitor has not been removed; monomer from which the inhibitor has been removed has an even shorter shelf-life. For this reason, it is suggested that styrene is disposed of after 12–18 months and that with the inhibitor removed used immediately.



Scheme 2 Thermal decomposition of the initiator AIBN.

Table 2.1 Examples of free-radical initiators in common use

Thermal free-radical initiators ^a	Solvent	T(°C)	k _d (s ⁻¹)	t _{1/2} (s)	t _{1/2} (h)
2,2'-Azobisisobutyronitrile (AIBN) ^b	Benzene	50	2.20 × 10 ⁻⁶	3.15 × 10 ⁵	87.52
	Benzene	70	3.20 × 10 ⁻⁵	2.17 × 10 ⁴	6.02
	Benzene	100	1.50 × 10 ⁻³	4.62 × 10 ²	0.13
1,1'-Azobis(cyclohexane-carbonitrile)	Benzene	80	6.50 × 10 ⁻⁶	1.07 × 10 ⁵	29.62
	Benzene	95	5.40 × 10 ⁻⁵	1.28 × 10 ⁴	3.56
	Benzene	102	1.30 × 10 ⁻⁴	5.33 × 10 ³	1.48
Benzoyl peroxide ^c	Benzene	60	2.00 × 10 ⁻⁶	3.47 × 10 ⁵	96.27
	Benzene	78	2.30 × 10 ⁻⁵	3.01 × 10 ⁴	8.37
	Benzene	100	5.00 × 10 ⁻⁴	1.39 × 10 ³	0.39
<i>tert</i> -Butyl peroxide	Benzene	80	7.80 × 10 ⁻⁸	8.89 × 10 ⁶	2468.47
	Benzene	100	8.80 × 10 ⁻⁷	7.88 × 10 ⁵	218.80
	Benzene	130	3.00 × 10 ⁻⁵	2.31 × 10 ⁴	6.42
Dodecanoyl peroxide (lauroyl peroxide)	Benzene	40	4.90 × 10 ⁻⁷	1.41 × 10 ⁶	392.94
	Benzene	60	9.20 × 10 ⁻⁶	7.53 × 10 ⁴	20.93
	Benzene	85	3.80 × 10 ⁻⁴	1.82 × 10 ³	0.51
Potassium persulfate	Water	80	6.90 × 10 ⁻⁵	1.00 × 10 ⁴	2.79
	0.1 M NaOH	50	9.50 × 10 ⁻⁷	7.30 × 10 ⁵	202.67
	0.1 M NaOH	60	3.20 × 10 ⁻⁶	2.17 × 10 ⁵	60.17
	0.1 M NaOH	80	9.20 × 10 ⁻⁵	7.53 × 10 ³	2.09
	0.1 M NaOH	90	3.50 × 10 ⁻⁴	1.98 × 10 ³	0.55
Photoinitiators	λ_{max}(nm)	Transparent region (nm)			
Acetophenone	242	360–450			
	280				
Anthraquinone	250	390–450			
	270				
	325				
Benzophenone	250	380–450			
	300				
Triarylsulfonium hexafluoroantimonate salts		370–450			
Triarylsulfonium hexafluorophosphate salts	298	380–450			

^aHazard information is provided in the text where initiators are used; but it should be noted that free radical initiators often present a risk of explosion.

^bAIBN is now becoming difficult to obtain. 1,1'-Azobis(cyclohexanecarbonitrile) is often promoted as an alternative.

^cDecomposes to give phenyl radicals.

2: General procedures in chain-growth polymerization

It is often found that the molecular weight of the material is rather higher than is convenient; in such cases chain-transfer agents may be used. Common chain-transfer agents in use include thiols and halogenoalkanes; and in some cases the solvent may be used to control molecular weight [e.g. both toluene and tetrahydrofuran (THF) may act in this way]. A convenient source of data on the effectiveness of chain-transfer agents is given by the *Polymer Handbook*.¹¹ The use of functionalized chain-transfer agents such as 2-mercaptoethanol can lead to monofunctional polymers,¹³ as shown in Scheme 3; these can be subsequently reacted to form, for example, a block copolymer.

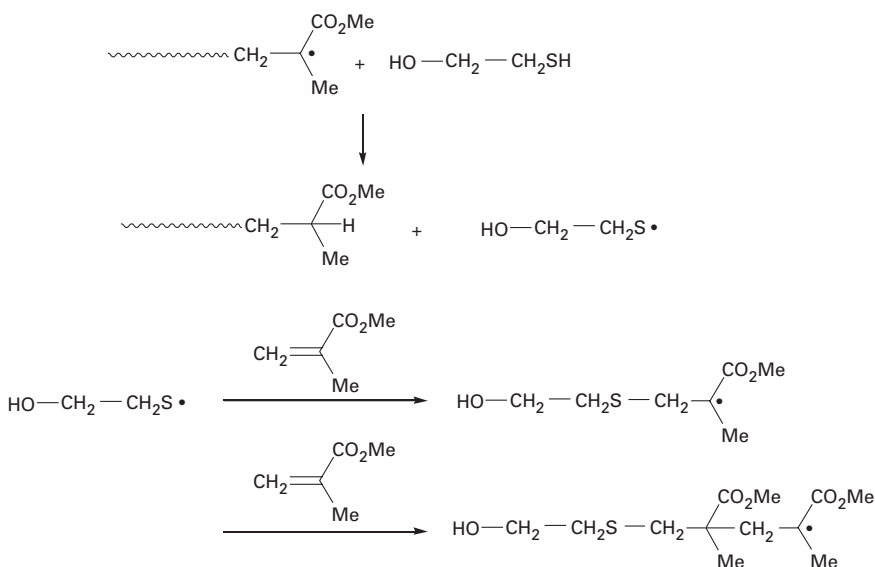

Scheme 3 Chain-transfer process with 2-mercaptoethanol to give a hydroxyl-terminated polymer.

2.1 General procedures in free-radical polymerization

Although the presence of water is generally not an issue in free-radical chain polymerization (indeed water may be a suitable medium for polymerization as in Protocols 5–7) unlike, for example, chain-growth polymerization initiated by anionic species, it is always advisable to use solvents of the highest purity and this will generally include some element of pre-drying. In general, solvents should be distilled, particularly as a number of suitable solvents for polymerization reactions contain stabilizers which usually serve to mop up free radicals and therefore inhibit the polymerization

process. It is usually advisable to pre-dry solvents often with calcium hydride (see below) and then distil them from another drying agent. LiAlH_4 is not nowadays a favoured reagent in this latter capacity. Ethereal solvents are not usually suitable for free-radical processes (unless a restricted molecular weight is required*). However, where they are used, they are generally dried on a mixture of sodium and benzophenone under a nitrogen atmosphere; the deep blue colour of the sodium benzophenone ketyl indicating that the solvent is dry. This ketyl also acts to remove oxygen. The demand for dry THF in many laboratories is such that a semi-permanent solvent-still is required. It is important that the users remember the possibility and danger of peroxide build-up in such systems and regularly test for these. This is done by adding 1 mL of the solvent to 1 mL of a 10% (w/v) solution of sodium iodide in acetic acid; a yellow colour indicates peroxides present, but in low concentrations; a brown colour high concentrations.† In any case, a still should be dismantled regularly and cleaned. Solvent-stills are a clear fire risk and should not be used without appropriate precautions and should be carefully monitored during use. Some information about common solvents used both for polymerization and in the preparation and purification of common monomers is listed in Table 2.2. The list is not exhaustive and the reader is referred to the excellent book by Perrin and Armarego,¹⁴ and some excellent textbooks on practical chemistry.¹⁵⁻¹⁷

After monomer and solvent purity (particularly the removal of inhibitors), perhaps the most crucial factor in determining the success of a free-radical polymerization process is the absence of oxygen. Oxygen is, of course, highly reactive towards free radicals and has a detrimental effect on polymerizations. For this reason, free-radical polymerizations need to be performed under anaerobic conditions. Solution or bulk polymerizations tend to be performed in polymerization tubes such as the one shown in Figure 2.1. Such tubes may be sealed using a flame in which case it is usually desirable to prepare them with a constriction near the top. For less volatile monomers and solvents, particularly where only small volumes are being used, it is sufficient to seal the tube using a 'Young's tap' making the whole process much more convenient. Even under these circumstances it is important to treat such tubes with considerable respect, large unexpected changes in pressure will cause them to shatter explosively and a blast screen should be placed

* The methylene unit attached to the ethereal oxygen is particularly reactive towards radical attack and thus chain-transfer processes would be expected to substantially reduce the molecular weight of the final polymer. Some reduction is noticed but both this solvent and toluene can be used for free-radical polymerization (and note the successful polymerization of benzyl acrylate in Protocol 1).

† Peroxides may be destroyed by treating the solvent with a concentrated solution of ferrous sulfate.

2: General procedures in chain-growth polymerization

Table 2.2 Some properties and purification methods of common solvents

Solvent	Boiling point ^a	Purification method	Hazards ¹⁸
Tetrahydrofuran (THF)	65	Pre-dried over CaH ₂ then dried over Na and distilled from Na with benzophenone	Highly flammable, ^b may form peroxides, irritating to eyes and respiratory system
Diethyl ether	35	As with THF above; diethyl ether sufficiently dry for the preparation of Grignard reagents can be obtained by standing on sodium wire	Extremely flammable, may form peroxides
Toluene	111	These solvents can be dried with calcium hydride then distilled; alternatively, they can be treated as the etherial solvent above	Highly flammable, harmful by inhalation
Benzene	80		Caution: Cancer suspect agent, highly flammable, toxic by inhalation
Chlorobenzene	131.7	Relatively pure chlorobenzene can be prepared by washing with H ₂ SO ₄ then drying with sodium bicarbonate, followed by drying with CaCl ₂ then distillation from P ₂ O ₅	Flammable, harmful by inhalation
Hexane	68.7	Distillation and storing over 4A molecular sieves is usually suitable for these solvents	Highly flammable, harmful by inhalation and in contact with the skin
Pentane	36.1		Highly flammable
Petroleum ether	Various		Extremely flammable or highly flammable
Chloroform	61	Chloroform can be simply purified by passing through a column of basic alumina to remove the ethanol, which is added as a stabilizer. Chloroform must be stored in the dark to avoid the photochemical generation of phosgene	Harmful by inhalation, potential carcinogen

Table 2.2 *Continued*

Solvent	Boiling point^a	Purification method	Hazards¹⁸
Dichloromethane	40	Dry dichloromethane can be obtained by pre-drying with CaCl ₂ followed by distillation from CaH ₂	Harmful by inhalation, potential carcinogen
Dimethylformamide (DMF)	153	Dried by stirring over calcium hydride for 24 h, then distilled under reduced pressure	Harmful in contact with skin, irritating to eyes
Dimethylsulfoxide (DMSO)	190	Dried overnight over CaO, then dried over CaH ₂ then distilled at reduced pressure	Harmful if taken internally, irritating to eyes
Acetonitrile	80	Dried over molecular sieve and by stirring over CaH ₂ , then distilled from CaH ₂	Highly flammable, toxic by inhalation in contact with skin and if swallowed
Methanol	65	Ethanol or methanol can generally be dried using 4A molecular sieve followed by distillation; for more rigorous drying the solvents can be treated with magnesium and iodine	Highly flammable, toxic by inhalation and if swallowed
Ethanol	79		Highly flammable
Ethyl acetate	77	Washed with Na ₂ CO ₃ and then with saturated NaCl, distilled from CaH ₂	Highly flammable

^a°C at 760 mmHg unless otherwise stated.

^bA flammable liquid is generally considered to be one with a flash point below 55°C but above 21°C; a highly flammable liquid is one with a flash point above 0°C and below 21°C; any liquid with a flash point lower than 0°C and a boiling point lower than 35°C must be labelled extremely flammable. These are the definitions used here but it should be noted that the term extremely flammable is sometimes used for liquids with a flash point below 32°C.

between the tube and the occupants of the laboratory. For systems where stirring is required, such as in emulsion and suspension polymerizations, either a continuous stream of nitrogen is bubbled through the solution, or the apparatus is evacuated and nitrogen admitted into the system, which is then maintained under a head of nitrogen. A few years ago, this latter process

2: General procedures in chain-growth polymerization

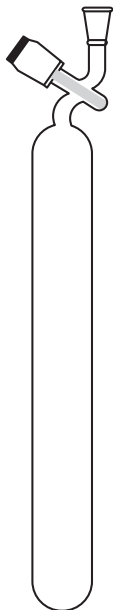

Fig. 2.1 Polymerization tube for free-radical polymerization of gram-scale samples.

may have been performed using a balloon containing nitrogen connected to a three-way tap, nowadays most workers prefer the versatility of a double manifold system, which provides access to both an inert gas supply and the vacuum pump. A typical set-up for this is shown in Figure 2.2. The manifold consists of two glass tubes with taps, which allow one or the other tube to be connected to the reaction vessel. One section of the manifold is connected to a source of dry nitrogen at one end and a gas bubbler at the other. The other section is connected to the vacuum pump. Commercial nitrogen and argon are sufficiently dry for the reactions described here, but it is normal to place a drying tube containing silica gel between the cylinder and the manifold although elaborate ‘drying trains’ are to be avoided.¹⁷ It is also important to be able to maintain a smooth gentle flow of inert gas and for this reason the cylinder is connected to the system via a needle valve, which allows careful regulation of the gas flow. The examples provided below are intended to illustrate some of the techniques available for producing polymers by free-radical chain-growth polymerization. In the first example we illustrate how a monomer may be prepared and purified prior to the polymerization process. The freeze–pump–thaw process for removing oxygen from the solution is a general technique, and applicable to a wide range of processes where free radicals are generated.

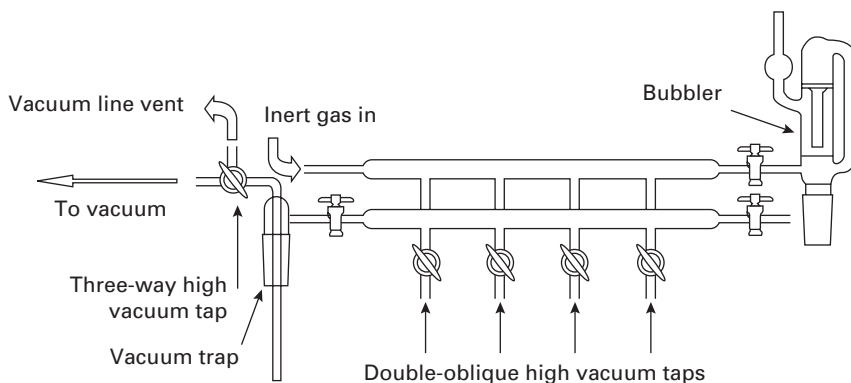
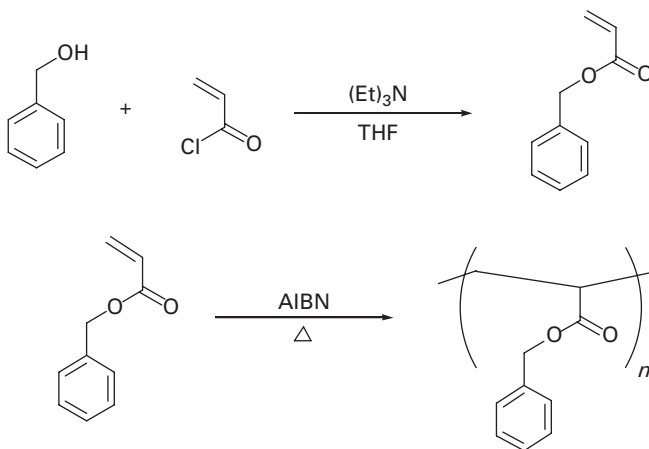

Fig. 2.2 Double manifold system designed to provide a source of inert gas and reduced pressure.

Protocol 1.

Preparation and polymerization of benzyl acrylate (Scheme 4)

Caution! Carry out all procedures in a well-ventilated fume-hood, wear appropriate disposable gloves, a lab-coat, and safety glasses. All vacuum-line work should be performed while standing behind a protective Perspex screen. Check all glassware for star cracks before use with any reduced pressure system. Never use flat-bottomed flasks with rotary evaporators.



Scheme 4 Preparation and polymerization of benzyl acrylate.

2: General procedures in chain-growth polymerization

Equipment

- Dual manifold (nitrogen/vacuum)
- Vacuum source
- Source of dry nitrogen
- Thermostatted water-bath
- Funnel
- Buchner filter apparatus
- Erlenmeyer flasks (250 mL)
- Reflux condenser
- Hotplate stirrer
- Separating funnel
- Round-bottomed flask (500 mL)
- Vacuum oven
- Dropping funnel
- Rotary evaporator
- Lab-jack
- Polymerization tube
- Dewar containing liquid nitrogen
- Single-necked round-bottomed flask (250 mL) for use on rotary evaporator
- Sintered-glass funnel
- Three-necked round-bottomed flask (250 mL)
- Teflon[®]-coated magnetic stirrer bar
- Ice-salt-bath
- Apparatus for distillation at reduced pressure: four single-necked round-bottomed flasks (50 mL), condenser, thermometer, air bleed, 'pig-type' receiver-adapter, Claisen still-head, and thermometer

Materials

- Acryloyl chloride, 11.30 mL, 0.14 mol **Flammable, causes severe burns; avoid contact with eyes, skin, and respiratory system**
- AIBN, 0.010 g, 6.1×10^5 mol **Toxic, harmful, explosive, highly flammable**
- Benzyl alcohol, 9.60 mL, 0.09 mol **flammable, severe irritant**
- THF, 100 mL **highly flammable, may form peroxides, irritating to eyes and respiratory system**
- Methanol, ca. 200 mL **highly flammable, toxic by inhalation and if swallowed**
- 2,6-Di-*tert*-butyl-4-methylphenol trace, ca. 10 mg **harmful, irritant**
- Triethylamine, 19.40 mL, 0.13 mol **highly flammable, irritating to eyes, skin, and respiratory system**
- Dichloromethane, ca. 70 mL **harmful by inhalation, potential carcinogen**
- Chlorobenzene, 20 mL **flammable, harmful by inhalation**
- Hexane for chromatography **highly flammable, harmful by inhalation and in contact with the skin**
- Diethyl ether for chromatography **extremely flammable, may form peroxides**
- Silica gel for flash chromatography **harmful by inhalation, irritating to respiratory system**
- Liquid nitrogen for cooling **extremely cold liquid, vapour can cause rapid suffocation**

Method

Step 1: preparation of benzyl acrylate

1. To a three-necked round-bottomed flask (250 mL) equipped with a reflux condenser, a dropping funnel, and a magnetic stirrer bar, add benzyl alcohol (9.60 mL, 0.09 mol). Add dry THF (60 mL)^a followed by 2,6-di-*tert*-butyl-4-methylphenol (trace, ca. 10 mg)^b and stir until all the solid has dissolved. Finally, triethylamine (19.40 mL, 0.13 mol) is added and the flask cooled to ca. -5°C using an ice-salt bath.
2. Acryloyl chloride (11.30 mL, 0.14 mol)^c is dissolved in THF (40 mL) and the solution placed in the dropping funnel. The solution is then added dropwise to the stirred benzyl alcohol solution, over about 10 min ensuring that the temperature does not exceed 5°C . The solution is then allowed to warm to room temperature and stirred for 24 h.
3. After 24 h, the solution is transferred to a 500 mL round-bottomed flask and the THF removed on the rotary evaporator to yield a yellow solid. This solid is then dissolved in dichloromethane (50 mL) and washed with water (50 mL)

Protocol 1. *Continued*

in a separating funnel. The dichloromethane (lower) layer is then run-off into an Erlenmeyer flask (250 mL) and dried with anhydrous sodium sulfate (sufficient to become free flowing when the solution is swirled). This solution is then filtered under gravity through a fluted filter paper into a conical funnel placed in the single-necked round-bottomed flask (250 mL) to remove the drying agent and the dichloromethane is then removed from this red organic layer on the rotary evaporator, to leave a red liquid.

4. Benzyl acrylate is then purified by distillation at reduced pressure (b.p. 130–140°C at 20 mmHg) to yield a colourless liquid.^d This is further purified by column chromatography (on silica gel)^e to give the monomer in 69% yield.^f

Step 2: Polymerization of benzyl acrylate

5. Place the benzyl acrylate (2 g, 0.012 mol) and AIBN (0.010 g, 6.1×10^5 mol) in a polymerization tube the add chlorobenzene (20 mL). A protective netting sleeve is then placed over the tube to minimize danger from glass, should the tube shatter. Attach the tube to the manifold and close the Young's tap at the top of the tube.
6. Place the polymerization tube into the Dewar containing liquid nitrogen, using the lab-jack to raise the Dewar to the correct position, wait for the solution to freeze (evaporation of the liquid nitrogen becomes less rapid) and evacuate the manifold by closing the nitrogen supply and opening the vacuum tap.
7. Open the tap to the polymerization tube and allow the air to be pumped out of the tube, with the liquid nitrogen Dewar still in place. After a few minutes the air will be removed from the system (generally this can be detected by the sound of the pump). Close the tap on the polymerization tube, the upper tap, and the access to the pump.
8. Remove the nitrogen Dewar from under the polymerization tube and allow the system to warm to room temperature. Any sudden contact with the polymerization tube at this stage may cause the tube to shatter.
9. Allow nitrogen into the system by opening the N₂ inlet tap; then carefully open the upper tap and then the lower tap in sequence, being particularly careful to ensure that a sudden influx of air does not cause the tube to become detached from the manifold.
10. Repeat steps 6–9 two more times to ensure complete removal of oxygen from the system.
11. When nitrogen has been passed into the system for a third time, place the polymerization tube into the liquid nitrogen Dewar and evacuate the manifold by closing the nitrogen supply and opening the vacuum tap.
12. Close the Young's tap on the polymerization tube and warm to room temperature. Place the tube in a thermostatted water-bath at 55°C for 18 h.

2: General procedures in chain-growth polymerization

13. After 18 h, remove the tube from the water-bath and allow to cool to room temperature. Pour the cooled solution into a flask containing cooled (0°C) methanol. The solid polymer is collected, dried, and then further purified by twice dissolving in dichloromethane (typically 1 g in <10 mL) and re-precipitating into methanol. Finally, the polymer is dried in a vacuum oven at 40°C.

Possible problems

Polymerization will be obvious by the marked increase in viscosity of the solution, if this is not apparent then it is possible that a trace of inhibitor remains in the monomer (this is not likely in this case). Either re-purify the monomer or increase the quantity of initiator and leave the polymerization for a longer period (this latter procedure is not to be recommended if any control of the molecular weight is required).

Filtration of the crude polymer may prove difficult as residual solvent may act as a plasticiser and the resultant soft polymer may block the filter funnel. In such cases, the solution containing the precipitated polymer can be allowed to stand and the supernatant liquid can be decanted.

^aSee Table 2.2.

^bThis inhibits free-radical polymerization both during the reaction and the final distillation.

^cAcryloyl chloride can be obtained commercially, but care must be taken when storing the material, and in any case it should not be stored for long periods (since an exothermic polymerization may occur); acryloyl chloride can be readily prepared by heating acrylic acid with excess benzoyl chloride and distillation of the volatile component.

^dThe apparatus for distillation at reduced pressure is described in Ref. 17, it is recommended that a relatively small-scale apparatus is used: 50 mL flasks and glassware with 14/23 joints. The joints should all be greased using vacuum grease. The flask containing the benzyl acrylate is fitted with the Claisen still-head, the condenser, the thermometer, and the 'pig-type' receiver-adaptor. The remaining three flasks are attached to this adaptor (special clips are available to prevent these flasks falling off). An air-bleed is pulled from a glass pipette by grasping both ends of the pipette and heating the thin end (sufficiently far away from your hand to avoid burning); when the glass softens, the pipette is quickly removed from the heat and both hands pulled apart. The resultant capillary is adjusted to the right size and then placed in the Claisen head using a screw adaptor such that it is just above the bottom of the flask. The receiver-adaptor is connected to the water aspirator and a vacuum applied, the distillation flask is then heated using an oil-bath (a hot air gun may be more suitable in some circumstances) and the middle fraction of the distilled material collected (**caution!**—never distil to dryness).

^eThe eluent used was a mixture of dichloromethane and carbon tetrachloride, a suitable alternative is a mixture of hexane and diethyl ether.

^f¹H NMR δ_{H} (400 MHz; CDCl₃; Me₄Si): 7.40 (5H, m, aromatic H), 6.45 (1H, dd, $J_{3,2}$ 17.2, $J_{3,3}$ 1.5, 3' H), 6.16 (1H, dd, $J_{2,3}$ 10.4, $J_{2,3'}$ 1.5, 2-H), 5.83 (1H, dd, $J_{3,3'}$ 1.5, $J_{3,2}$ 10.4, 3-H), 5.25 (2H, s, 4-H).

Structural studies of polymer materials often use neutron scattering techniques. In such circumstances the use of deuterated chains can be necessary because it overcomes problems associated with inelastic scattering. In this example, a commercial sample of polystyrene-d₇ is polymerized in such a way as to maximize yield due to the high cost of the monomer. There is little advantage in polymerizing styrene in solution unless large quantities are required (where heat transfer becomes a problem). Polystyrene can be polymerized in the

bulk at temperatures above 100°C without any added initiator, but under such circumstances the molecular weight may be rather high. Control of the molecular weight and lower polymerization temperatures can be achieved using initiators. Usually benzoyl peroxide is the initiator of choice, however, we have found that AIBN works well and that is the one described here.

Protocol 2.

Bulk polymerization of styrene-d₇ (Scheme 5)

Caution! Carry out all procedures in a well-ventilated fume-hood, wear appropriate disposable gloves, a lab-coat, and safety glasses. All vacuum-line work should be performed while standing behind a protective Perspex screen. Never use flat-bottomed flasks with rotary evaporators.



Scheme 5 Polymerization of styrene initiated by AIBN.

Equipment

- Dual manifold (nitrogen/vacuum)
- Vacuum source
- Source of dry nitrogen
- Thermostatted water-bath
- Separating funnel
- Erlenmeyer flasks (250 mL)
- Funnel
- Lab-jack
- Polymerization tube
- Dewar containing liquid nitrogen
- Beaker (500 mL)
- Vacuum oven
- Apparatus for filtration under reduced pressure: Buchner funnel, flask, and water aspirator

Materials

- Sodium hydroxide solution (1 M)
 - Magnesium sulfate
 - Styrene-d₇, 2 g, 19 mmol
 - AIBN, 0.032 g, 0.2 mmol
 - Methanol, ca. 300 mL
 - Dichloromethane, 45 mL
 - Liquid nitrogen for cooling.
- causes severe burns**
do not breath dust, avoid contact with skin and eyes
flammable, irritating to eyes and respiratory system
toxic, harmful, explosive, highly flammable
highly flammable, toxic by inhalation and if swallowed
harmful by inhalation, potential carcinogen
extremely cold liquid, vapour can cause rapid suffocation

Method

1. The styrene is freed of inhibitors by shaking with sodium hydroxide in a separating funnel. It is then dried with magnesium sulfate^a. A protective netting sleeve is then placed over the tube to minimize danger from glass should the tube shatter. Attach the tube to the manifold and close the Young's tap at the top of the tube.
2. Styrene-d₇ (2 g, 19 mmol) is added to a polymerization tube (Figure 2.2) and AIBN (0.032 g, 0.2 mmol) is then added.

2: General procedures in chain-growth polymerization

3. The monomer and initiator are then degassed using the freeze–pump–thaw technique described in Protocol 1 (steps 6–11). The tube containing the degassed monomer is then placed in a thermostatted water-bath at 55°C for about 15 h. After this time the styrene has been converted into a glassy solid lump of polystyrene at the bottom of the tube.
4. The glassy polymer is dissolved by adding dichloromethane (15 mL) and allowing to stand for 2 h. The highly viscous solution is then allowed to drop slowly into a flask containing cold methanol. The solid polymer is collected, dried, and then further purified by twice dissolving in dichloromethane (15 mL) and re-precipitating into methanol. Finally, the polymer is dried in a vacuum oven at 40°C.

^aStyrene can be purified by distillation at reduced pressure, but it does exhibit a marked tendency to bump and with a small sample such as used here losses may be rather significant.

2.2 Copolymerization

The introduction of a second monomer into a free-radical polymerization is a useful tool to modify the properties of the resultant polymer. Such an approach may offer advantages over the blending of the two polymers since the latter procedure does not guarantee a miscible material due to the poor entropy of mixing of large molecules. One simple application of copolymerization might be the introduction of chemical reactive units to allow the incorporation of other units following polymerization. Two examples might be the incorporation of chromophores containing nitro compounds to generate a liquid crystalline compound with specific optical properties or the introduction of hydroxyl or other units to provide site for subsequent cross-linking. We shall see in Chapter 9 how this approach can be useful in providing materials that display a permanent memory of their orientation at the time of cross-linking.

For free-radical copolymers the incorporation of a second monomer is not straightforward. The composition of the final copolymer is determined by the kinetics in a way first described by Dorstal¹⁹ but later elaborated by Alfrey,²⁰ Mayo and Walling²¹, and others. The kinetic model assumes that the kinetics depends on the end group of the radical chain and the new monomer in a way commonly described for monomers M_1 and M_2 as shown in Scheme 6.

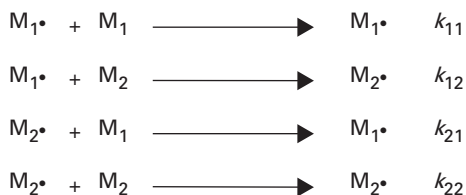

Scheme 6 Reactions occurring in a copolymerization; in the simplest model, the reactivity of the propagating chain is considered to be dependent only on the terminal monomer unit.

Table 2.3 Some typical data for reactivity ratios

M_1	M_2	r_1	r_2	Conditions
Styrene	Acrylonitrile	0.4	0.04	60°C
Styrene	Maleic anhydride	0.04	0.01	60°C
Styrene	Methyl methacrylate	0.52	0.46	60°C
Methyl methacrylate	Styrene	0.46	0.42	60°C
Acrylonitrile	Methyl methacrylate	0.15	1.22	80°C

The monomer reactivity ratios $r_1 (=k_{11}/k_{12})$ and $r_2 (=k_{22}/k_{21})$ (Table 2.3) reflect the relative rate constants for a given radical adding to its precursor monomer and to the alternative. If the monomers are very similar for example two slightly different acrylates then the values of r_1 and r_2 are close to equal and unity. In such a case, the composition of the polymer is equal to the composition of the feedstock at all stages of the polymerization. If on the other hand, the values are both small as in the case of maleic anhydride and styrene then each monomer is reluctant to react with itself; the result is an alternating copolymer.

Protocol 3.

Preparation of a poly(styrene–acrylic acid) copolymer by free-radical polymerization (Scheme 7)

Caution! Carry out all procedures in a well-ventilated fume-hood, wear appropriate disposable gloves, a lab-coat, and safety glasses. All vacuum-line work should be performed while standing behind a protective Perspex screen.



Scheme 7 A copolymer formed from styrene and acrylic acid.

Equipment

- Dual manifold (nitrogen/vacuum)
- Vacuum source
- Source of dry nitrogen
- Thermostatted water-bath
- Apparatus for filtration under reduced pressure: Buchner flask, sintered-glass funnel, and water aspirator
- Lab-jack
- Polymerization tube
- Dewar containing liquid nitrogen
- Beaker (500 mL)
- Erlenmeyer flasks (250 mL)
- Vacuum oven

2: General procedures in chain-growth polymerization

Materials

- Acrylic acid, 1.7 mL, 25 mmol **flammable, causes burns**
- Styrene, 25.55 mL, 223 mmol **flammable, irritating to eyes and respiratory system**
- AIBN, 0.41 g, 2.5 mmol **toxic, harmful, explosive, highly flammable**
- Methanol, ca. 150 mL **highly flammable, toxic by inhalation and if swallowed**
- Acetone, ca. 20 mL **highly flammable**
- Petroleum ether 60/80, ca. 300 mL **highly flammable**
- Liquid nitrogen for cooling **Extremely cold liquid, vapour can cause rapid suffocation**

Method

Preparation: Styrene and acrylic acid should be purified to remove inhibitors prior to use. Both may be distilled under reduced pressure, but styrene can be washed with a dilute aqueous solution of potassium carbonate.

1. Place styrene (25.55 mL, 223 mmol), acrylic acid (1.7 mL, 25 mmol), and AIBN (0.41 g, 2.5 mmol) in a polymerization tube. A protective netting sleeve is then placed over the tube to minimize danger from glass should the tube shatter. Attach the tube to the manifold and close the Young's tap at the top of the tube.
2. Place the polymerization tube into the liquid nitrogen Dewar and evacuate the manifold by closing the nitrogen supply and opening the vacuum tap.
3. Once frozen, open the tap to the polymerization tube and allow the air to be pumped out of the tube, with the liquid nitrogen Dewar still in place. After a few minutes the air will be removed from the system (generally this can be detected by the sound of the pump). Close the tap on the polymerization tube, the upper tap, and the access to the pump.
4. Remove the nitrogen Dewar from under the polymerization tube and allow the system to warm to room temperature. Any sudden contact with the polymerization tube at this stage may cause the tube to shatter.
5. Allow nitrogen into the system by opening the N₂ inlet tap; then carefully open the upper tap and then the lower tap in sequence, being particularly careful to ensure that a sudden influx of gas does not cause the tube to become detached from the manifold.
6. Repeat steps 2–5 two more times to ensure complete removal of oxygen from the system.
7. When nitrogen has been passed into the system for a third time, place the polymerization tube into the liquid nitrogen Dewar and evacuate the manifold by closing the nitrogen supply and opening the vacuum tap.
8. Close the Young's tap on the polymerization tube and warm to room temperature. Place the tube in a thermostatted water-bath at 55°C for 1 hr.^a
9. Remove the tube from the water-bath and allow to cool to room temperature.
10. Pour the viscous solution drop-wise into 150 mL methanol contained in a beaker (500 mL) cooled in ice. Dissolve the polymer in a small quantity of a suitable solvent (no more than 10 mL per gram polymer), in this case acetone, and precipitate from a suitable non-solvent for the polymer (in this case, petroleum ether 60/80).

Protocol 3. *Continued*

11. Dissolve the polymer once again in a suitable solvent and re-precipitate. Collect the white polymer by filtration at the water pump using a clean dry sintered-glass funnel and dry the sample in the vacuum oven at 60°C for 24 h.

^aIt is important that the polymerization not be allowed to proceed to high yield since the different reactivities of the two monomers will result (in most cases at least) in a changing composition as a function of time as one of the monomers is depleted more rapidly than the other.

Polymerization is not always the final chemical transformation in a process and there are a number of commercial processes that rely on manipulation of a preformed polymer backbone. Polyvinyl alcohol, for example, cannot be made directly from the monomer (which is the enol form of acetaldehyde), and is made instead by hydrolysis of poly(vinyl acetate). Poly(acrylonitrile) is of particular interest since there are some important commercial consequences of its pyrolysis; in particular, heating to high temperatures in the absence of oxygen results in a process known as graphitization. If this process is performed on poly(acrylonitrile) fibres under stress then the resulting carbon fibres exhibit a very high modulus and excellent heat resistance. They find particular use in composite materials. The underlying chemistry of the pyrolysis process is complex, but it is clear that the 1,3-relationship between neighbouring nitrile units facilitates cyclization, and the resulting ladder structure loses nitrogen in the form of HCN and N₂ as outlined in Scheme 8. The following example, describes the copolymerization of acrylonitrile with 2-vinylpyridine. Subsequent pyrolysis results in the formation of an electrically conductive material, in spite of the presence of the comonomer units; when the copolymer is heated sufficiently for the formation of a highly conjugated structure but not at a sufficiently high temperature for graphitization to occur, then there is an excess of nitrogen in the thermally restructured product. This may find use as electrode material in rechargeable power cells.²²

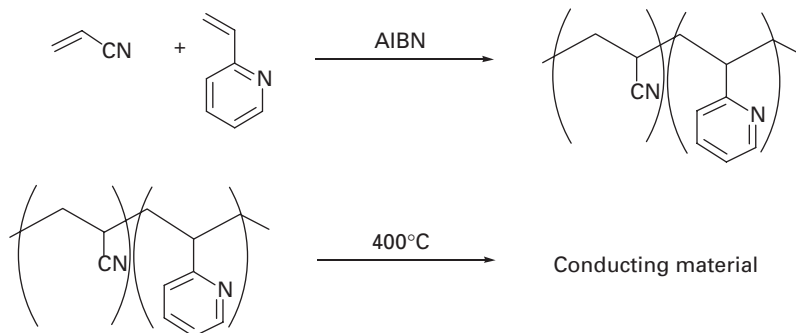

Scheme 8 Copolymerization of styrene and 2-vinylpyridine and thermal restructuring to form a conducting material.

Protocol 4.

Thermal restructuring of a copolymer of acrylonitrile and 2-vinylpyridine

Caution! Carry out all procedures in a well-ventilated fume-hood, wear appropriate disposable gloves, a lab-coat, and safety glasses. All vacuum-line work should be performed while standing behind a protective Perspex screen.

Equipment

- Dual manifold (nitrogen/vacuum)
- Source of dry nitrogen
- Thermostated water-bath
- Vacuum oven
- Apparatus for filtration under reduced pressure: Buchner flask, sintered-glass funnel, and water aspirator
- Lab-jack
- Vacuum source
- Polymerization tube
- Dewar containing liquid nitrogen
- Beaker (500 mL)
- Erlenmeyer flasks (250 mL)
- Tube furnace

Materials

- Acrylonitrile, 2.00 g, 37 mmol **highly flammable, toxic by inhalation, in contact with skin and if swallowed**
- 2-Vinylpyridine, 1.70 g, 16 mmol **flammable, harmful by inhalation and skin contact**
- 2,6-Di-*tert*-butyl-4-methylphenol trace, ca. 20 mg **harmful, irritant**
- AIBN, 0.044 g, 0.24 mmol **toxic, harmful, explosive, highly flammable**
- Chlorobenzene, 20 mL **flammable, harmful by inhalation**
- Methanol, ca. 1 L **highly flammable, toxic by inhalation and if swallowed**
- Dichloromethane, ca. 150 mL **harmful by inhalation, potential carcinogen**
- Diethyl ether, ca. 100 mL **extremely flammable, may form peroxides**
- Liquid nitrogen for cooling. **extremely cold liquid, vapour can cause rapid suffocation**

Method

Preparation: Acrylonitrile is purified by pre-drying over calcium hydride (24 h), then distilled in the presence of a trace of 2,6-di-*tert*-butyl-*p*-cresol under a nitrogen atmosphere (b.p. 78°C, 760 mmHg). 2-Vinylpyridine is distilled under reduced pressure with a trace 2,6-di-*tert*-butyl-*p*-cresol and used immediately to avoid polymerization during storage.

1. Place acrylonitrile (2.00 g, 37 mmol), 2-vinylpyridine (1.70 g, 16 mmol) and AIBN (0.044 g, 0.24 mmol) in a polymerization tube. Finally chlorobenzene (20 mL) is added. A protective netting sleeve is then placed over the tube to minimize danger from glass should the tube shatter. Attach the tube to the manifold and close the Young's tap at the top of the tube.
2. Steps 2–7 of Protocol 3 are repeated and the polymerization tube is placed in a thermostated water-bath at 50°C and the mixture allowed to polymerize for 48 h.
3. The polymer tube is allowed to cool to room temperature and the vacuum released by opening the Young's tap; the partially soluble and the swollen polymer^a is poured into a beaker (1 L) containing an excess of methanol (400 mL). The material is collected then swollen in dichloromethane (ca. 50 mL) and then precipitated into methanol (500 mL), and once again the solid collected. Finally, a further portion of dichloromethane is added and the

Protocol 4. Continued

polymer precipitated into diethyl ether. The polymer is then dried in a vacuum oven at 50°C for 48 h. Polymers prepared in this way show little evidence of any unreacted monomer or solvent in the final product.^b

4. Pyrolysis of the sample is performed in a tube furnace.^c A sample of the polymer (ca. 1 g) is placed in a crucible and mounted in the furnace. The ends of the furnace are sealed save for the inlet for the inert gas supply and the gas outlet pipe which must be vented into the fume-hood. The sample is then heated at the required temperature (e.g. 400°C for 3 h) and allowed to cool to room temperature under a nitrogen atmosphere.

^aPoly(acrylonitrile) is soluble in DMF but not in solvents such as dichloromethane. DMF is not a suitable solvent to use in solvent purification not least because removing it from the final polymer is likely to be difficult. Increasing the 2-vinylpyridine concentration improves solubility in dichloromethane.

^bUnlike the previous example, the monomers are polymerized to high yield. This, of course, means that the uptake of monomers is close to their relative concentrations in the initial feedstock; however, of course the composition of the polymer in the initial stages of the polymerization is likely to be different to that formed when monomers become depleted in differing amounts. In this particular example a clear indication of the average microstructure in the polymer can be obtained using ¹³C NMR (see Chapter 1). The sequence distributions and composition of the polymers can be calculated using the reactivity ratios.²³

^cAt temperatures below 500°C borosilicate glass (Pyrex[®]) apparatus may be used, but particular care needs to be taken to ensure that the temperature at the sample is known. The reaction is exothermic so it may be difficult to control temperatures with larger samples.

2.3 Smart actuators using *N*-isopropylacrylamide gels

N-Isopropylacrylamide (NIPA) gels have been investigated extensively for their dynamic properties as well as the expected swelling properties found commonly amongst cross-linked polymers. Amongst the novel and unique characteristics are those observed during changes in the external conditions of the gel. For example, the gel can swell or shrink by a factor of several hundred on changes in temperature. Such properties have been attributed to a phase transition, commonly referred to as the *lower critical solution temperature* (LCST).²⁴ When in aqueous solution above the LCST, the polymer exhibits phase separation where the density and pore size of the network exhibit large-scale fluctuations. The forces acting on the gel during the transition are the elasticity, the affinity of the polymer chains to one another and the hydrogen ion pressure.²⁵ In the example below, the polymerization of NIPA and cross-linking reaction is carried out in one step. Ammonium persulfate is used as the free-radical initiator along with *N,N,N,N*-tetramethylethylenediamine, and the cross-linking is achieved with the use of *N,N'*-methylenebisacrylamide. Thin rods of the gel can be obtained by placing glass tubes in the polymerization mixture; the gel can be readily removed from these 'moulds' using hot water.

Protocol 5.

Synthesis of cross-linked poly(*N*-isopropylacrylamide) (Scheme 9)

Caution! Carry out all procedures in a well-ventilated fume-cupboard, wear appropriate disposable gloves, a laboratory coat, and safety glasses.

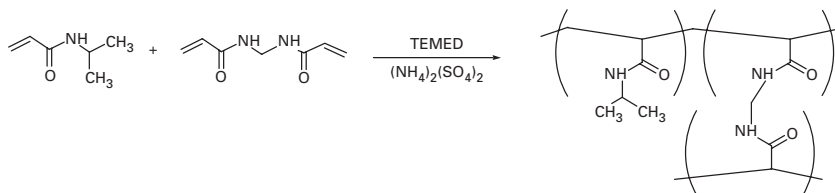

Scheme 9 Synthesis of a highly absorbent network by copolymerization of NIPA and *N,N'*-methylenebisacrylamide.

Equipment

- Beaker (100 mL)
- Glass capillaries (5 mm diameter, 30 mm length)
- Refrigerator (set between 0 and 5°C)
- Scalpel *Care*

Materials

- NIPA, 5.0 g, 44 mmol^a
 - *N,N'*-Methylenebisacrylamide, 77 mg, 0.5 mmol
 - *N,N,N,N*-Tetramethylethylenediamine, 58 mg, 0.5 mmol
 - Ammonium persulfate, 25 mg, 0.1 mmol
 - Water, deionized, 50 mL
 - *n*-Hexane, 200 mL
- harmful, toxic, irritant**
harmful
corrosive, flammable
harmful, irritant, sensitizer, oxidant
highly flammable, harmful by inhalation and in contact with the skin

Method

1. Dissolve NIPA (5.0 g, 44 mmol) and *N,N'*-methylenebisacrylamide (77 mg, 0.5 mmol) in a glass beaker (100 mL) with deionized water (50 mL). Add *N,N,N,N*-tetramethylethylenediamine (58 mg, 0.5 mmol) and immerse the desired number of glass capillaries (~30) in the solution.
2. Add ammonium persulfate (25 mg, 0.1 mmol) and immediately place the beaker in a refrigerator at about 2°C. Leave the solution to stand at this temperature for 20 h.
3. Remove the glass capillaries from the bulk of the gel by cutting around them with the use of a scalpel. Hold the individual glass capillaries under running tap water (hot) to remove the gel cylinders from within.
4. Wash the gels with copious amounts of water using a soak–decant method and leave them to stand (in water) for 24 h. After this time wash the gels again with water, hexane (200 mL), and finally, water (using the same soak–decant method).

^aNIPA (5.0 g) is recrystallized prior to use from *n*-hexane (60 mL) and dried in a vacuum oven at 50°C.

2.4 Suspension and emulsion polymerization

On a laboratory scale, styrene is perfectly suited to bulk polymerization, particularly when, as above, only a couple of grams of material are required. On a larger scale, however, a number of difficulties may be encountered, for example, the polymer must be purified, in particular to remove unreacted monomer—re-precipitation is less than satisfactory in this regard since it introduces the subsequent need to remove both the solvent and the precipitating medium. The main difficulty, however, is that the exothermic nature of most polymerization reactions generally necessitates heat transfer in order to avoid localized heating giving a rather inhomogeneous product (having, e.g. a rather large polydispersity and possibly some degradation). Although performing the reaction in solution does overcome this problem this introduces the need to remove the solvent (it may also be the case that the growing polymer chains precipitate from solution at higher molecular weights).

An alternative approach to polymerization is to suspend the monomer as small droplets in a non-solvent (this usually means water but other systems can be used). The droplets typically have diameters ranging from 100 to 5000 μm and aggregation is prevented by a combination of stirring and stabilizers [these include poly(vinyl alcohol), gelatin, a variety of cellulose derivatives, and the sodium salt of poly(acrylic acid)]. In such systems the initiator is miscible with the monomer phase, so the system can be regarded as a large number of small-scale bulk polymerizations. There is a particular problem with agglomeration if the beads become sticky, and it is not surprising that this finds most use commercially in the production of glassy polymers such as polystyrene and polyacrylonitrile. Suspension polymerization finds particular use in the preparation of polymer beads for polymer supported reactions, and there are specially designed reactors available.²⁶ These may be also used to form larger-sized polymer particles that are also monodisperse by a technique known as seeded suspension polymerization.^{27,28} The following example was provided by Dr M. Whitcombe of the Institute for Food Research in Norwich.²⁹

Protocol 6.

Formation of polystyrene beads cross-linked with divinyl benzene by suspension polymerization

Caution! Carry out all procedures in a well-ventilated fume-cupboard, wear appropriate disposable gloves, a lab-coat, and safety glasses. All vacuum-line work should be performed while standing behind a protective Perspex screen.

Equipment

- Dual manifold (nitrogen/vacuum)
- Resin kettle (250 mL)
- Source of dry nitrogen
- Dropping funnel

2: General procedures in chain-growth polymerization

- Mechanical stirrer
- Nitrogen inlet
- Oil-bath
- Centrifuge
- Condenser
- Hotplate
- Vacuum oven

Materials

- Sodium hydroxide (1 M) **causes severe burns**
- Magnesium sulfate **do not breath dust, avoid contact with skin and eyes**
- Styrene, 0.2 g, 2 mmol **flammable, irritating to eyes and respiratory system**
- Methanol, ca. 500 mL **highly flammable, toxic by inhalation and if swallowed**
- Water, deionized, 100 mL
- Divinylbenzene, 4.8 g, 36 mmol **irritant**
- AIBN, 0.1 g, 0.6 mmol **harmful, irritant**
- Poly(vinyl alcohol) (87–89% hydrolysed, MW = 85 000–146 000), 7 g **combustible, irritant**

Method

Preparation: The styrene is freed of inhibitors by shaking with sodium hydroxide solution in a separating funnel, it is then dried with magnesium sulfate.^a Divinyl benzene is freed from inhibitor in a similar way.^b Deionized water is purged with inert gas for an hour prior to the experiment.

1. In a resin kettle (250 mL) equipped with a mechanical stirrer, condenser, dropping funnel, and nitrogen inlet, poly(vinyl alcohol) (7 g, 87–89% hydrolysed, MW = 85 000–146 000)^c is dissolved in water (100 mL) by stirring at 90–95°C.
2. The mixture is cooled to room temperature and divinylbenzene (4.8 g, 36 mmol), styrene (0.2 g, 2 mmol), and AIBN (0.1 g, 0.6 mmol) are placed in the flask.^d The mixture is stirred at 650 rpm under a gentle stream of nitrogen while the temperature is raised to 65°C.
3. The polymerization is allowed to proceed under a gentle stream of nitrogen and with vigorous stirring for 24 h.
4. The mixture is cooled to room temperature and the polystyrene beads are washed by repeated sedimentation from water at 10°C in a centrifuge at 13 000 rpm for 30 min. Finally, the beads are dried in a vacuum oven at 80°C overnight.

^aStyrene can be purified by distillation at reduced pressure, but it does exhibit a marked tendency to bump and with a small sample such as used here losses may be significant.

^bFor example, Whitcombe *et al.* suggest (Chapter 8) the removal of inhibitor by washing the divinylbenzene with dilute sodium hydroxide solution (~0.1 M) in a separating funnel, followed by washing with water, then with saturated brine, and drying the organic layer over calcium chloride.

^cOther dispersing agents include polyacrylic acid, gelatin, methylcellulose, zinc oxide, and kaolin.

^dThere are many possible reagent combinations for such polymers and the styrene/divinylbenzene ratio must be tailored to suit individual needs [benzoyl peroxide is often used as an initiator for suspension polymerizations, see, e.g. Ref. 1(e)]. Often surface area is important particularly if chromatographic uses are intended; in such circumstances a small volume of a porogenic solvent can be added to the mixture. In additional experiments in Ref. 29, for example, the monomer and initiator are dissolved in a mixture of dioctyl phthalate and *n*-decane (77 : 23 v/v, 4.5–7.5 mL) before being placed in the reaction flask. The resultant material has a much greater surface area.

As an alternative to suspension polymerization, emulsion polymerization offers a number of potential advantages. While superficially similar, there are

two important differences: (i) the initiator is water soluble, and so not present in the monomer phase; and (ii) the addition of a surfactant (or soap) stabilizes the monomer phase and prevents agglomeration, thus the need for glassy polymers is eliminated.* The process is rather complex, but it is clear that polymerization occurs largely in the micelles generated by the soap. Because there is likely to be only a single radical in each micelle, bimolecular termination is unlikely and extremely high molecular weights may be obtained (often a chain-transfer agent is added to moderate this). This process also serves to give rather narrow polydispersity and produces even-sized spherical particles. Emulsion polymerization can be used to generate polystyrene microspheres of up to about 1 μm in diameter in a conventional system. Larger uniform particles are best produced in a low-gravity environment, thus, for example, particles with 10 μm diameter were produced on the maiden flight of the ill-fated space shuttle Challenger.³⁰

Protocol 7.

Emulsion polymerization of styrene³¹

Caution! Carry out all procedures in a well-ventilated fume-hood, wear appropriate disposable gloves, a lab-coat, and safety glasses. All vacuum-line work should be performed while standing behind a protective Perspex screen. Never use flat-bottomed flasks with rotary evaporators.

Equipment

- Dual manifold (nitrogen/vacuum)
- Source of dry nitrogen
- Oil-bath
- Apparatus for filtration under reduced pressure:
Buchner flask, sintered-glass funnel, and water aspirator
- Resin kettle
- Condenser
- Hotplate
- Mechanical stirrer
- Nitrogen inlet

Materials

- Styrene, 50 mL, 437 mmol
 - Magnesium sulfate
 - Sodium dodecylsulfate, 1.0 g
 - Potassium persulfate, 0.05 g, 0.2 mmol
 - Aluminium sulfate solution, ca. 100 mL, 5% w/v
- flammable, irritating to eyes and respiratory system
do not breath dust, avoid contact with skin and eyes
harmful if swallowed or inhaled, causes irritation
to skin, eyes, and respiratory tract, may cause
allergic skin or respiratory reaction
irritant, harmful, avoid contact with skin and
eyes, strong oxidizing agent**

Method

1. The styrene is freed of inhibitors by shaking with sodium hydroxide in a separating funnel. It is then dried with magnesium sulfate.^a Deionized water is purged with inert gas for an hour prior to the experiment.

* Famously, emulsion polymerization was utilized to form styrene-butadiene synthetic rubber during the Second World War [the Mutual recipe consists of (by weight) 26% butadiene, ca. 9% styrene, ca. 63% water, ca. 1.7% soap, 0.17% decanethiol (added as a chain-transfer agent) and 0.1% potassium persulfate initiator].

2: General procedures in chain-growth polymerization

2. A resin kettle is equipped with a mechanical stirrer, condenser, nitrogen inlet, and water (100 mL) is placed in the flask. Then styrene (50 mL, 437 mmol), potassium persulfate (0.05 g, 0.2 mmol) are added. Nitrogen is then bubbled into the solution via a gas inlet tube.
3. After about 30 min, the gas inlet is removed and the system placed under a blanket of inert gas using the double manifold and the sodium dodecylsulfate (1.0 g) is added. The mechanical stirrer is then started and vigorous stirring is maintained. The solution is heated to 50°C for 2–4 h.^b
4. The polymer latex produced is precipitated by adding a solution of aluminium sulfate and boiling. The polystyrene is then filtered, washed with water, and dried in the vacuum oven at 55°C for 24 h.

^aGiven that this experiment is performed in an aqueous environment, further drying (by, e.g. distillation from calcium hydride) is unnecessary.

^bSorenson recommends 70°C for 2 h followed by 95°C for 2 h; Sandler and Karo recommend 50°C for 2 h.

3. Anionic polymerization

Although the mechanism is a chain-growth process, as for free-radical polymerization above, anionic polymerization exhibits marked differences in terms of control of structure, tacticity, and molecular weight. As the name implies, initiation and propagation, proceed via anionic intermediates and consequently monomers which best undergo such polymerizations are those that can stabilize a negative charge. Monomers that may be polymerized this way include, styrene, methacrylate, acrylate esters, and butadiene. The cyanoacrylate esters, which by virtue of two powerful electron-withdrawing groups are extremely reactive to very weak nucleophiles, have found commercial exploitation as adhesives. While anionic polymerization has a relatively long history³² it is the work of Szwarc,³³ which is probably the most influential in this regard, in particular his development of ‘living polymers’, which made the development of much greater control of polymer structures possible. This is of course best illustrated by the formation of block copolymers. When a solution of styrene is polymerized with butyllithium (Protocol 8) the orange-red colour of the styryl anion persists even when all the monomer is consumed. At this stage a solution containing another monomer, for example, methyl methacrylate, can be added and the polymerization will resume.* Thus, a polymer with well-defined blocks of different chemical structures can be formed. Such block copolymers have rather different properties from the random copolymers that can be formed with the free-radical methodology (Protocol 3). One of the most

* It should be noted that such reactions can only occur if the anion formed in the first stage is sufficiently nucleophilic to initiate polymerization of the second monomer; for example, subsequent addition of styrene to a methacrylate terminated anion can not be achieved. For instance, an equimolar mixture of styrene and methyl methacrylate produces almost pure poly(methyl methacrylate).³⁴ In fact it is generally the case that methyl methacrylate and related systems cannot copolymerize with non-polar monomers.³⁵

important properties of block copolymers is the tendency to phase separate at a molecular level; for example, in a styrene–butadiene–styrene block copolymer the soft butadiene segments phase separate from the rigid styrene blocks. Such material behaves like a cross-linked rubber. On heating, the cross-links are effectively removed when the styrene blocks become fluid. Thermoplastic elastomers have achieved considerable commercial success.

Anionic polymerization is highly demanding in terms of solvent purity and particularly with respect to the need for a completely water-free environment. In this respect, the best results are conducted using vacuum-line methodology. Such techniques may involve, for example, preparing reagents on the vacuum line *in situ*; flame-sealing glassware and the use of break seal-type connectors. Reference 2 provides a detailed account of how such methodology can be used to form a number of controlled structures. It is, however, possible to produce polymers successfully making use of the procedures commonly employed by organic chemists for working in an inert atmosphere, these techniques include, for example, the use of syringes and septa to add air-sensitive reagents. The protocols that follow focus largely on these techniques.

3.1 Providing an inert environment

The following procedures all relate to anionic polymerizations, which must be performed in an inert environment. In most cases, both water and oxygen will react with the anionic propagating chain and must therefore be removed. Although, as stated above such environments are best provided using vacuum-line techniques, perfectly acceptable results may be obtained by using the types of procedures familiar to all organic chemists who use air-sensitive reagents, equipment pre-dried and connected to the double manifold, reagents transferred using syringes into flasks fitted with septa, etc. There are a number of excellent accounts of such procedures and all the protocols used in this section have drawn on these.^{17,34–36}

Air-sensitive reagents may be synthesized *in situ* if required, but the more common ones, particularly the butyllithiums are sold as stock solutions in a suitable inert solvent such as hexane. Many chemical companies provide such compounds in specially designed containers which make transfer of the reagent relatively straight forward; In the Aldrich Sure/Seal™ system,^{34,35} for example, the reagent bottle has a crown cap with a small hole in it lined with a Teflon®-backed elastomer; this allows a syringe needle to be inserted through the liner. On withdrawing the needle the liner may self-seal, but even if it does not there is a similar Teflon® elastomer liner in the Bakelite cap, which provides an additional seal. Such materials can have particularly long shelf-lives, particularly if they are stored at 0°C.* In spite of this, lengthy storage of alkyllithium, for example, is not advised, and thus, it may be false economy to purchase larger

* An improved system known as the Oxford Sure/Seal Valve cap, provided for use with Sure/Seal bottles is reported to give even greater shelf-life for the reagent.

2: General procedures in chain-growth polymerization

(e.g. 800 mL) bottles when only small quantities are used to initiate polymerization unless the frequency of usage merits it. Disposal of large quantities of organometallic reagent is particularly problematic and should only be done with reference to the technical guidelines.* The possibility of decomposition, however slow, makes it important that the activity of the reagent is determined before use. This is particularly so in the case of anionic polymerization where the molecular weight is expected to be closely defined by the initiator concentration by as indicated by Eqn (2), where x_n is the number average degree of polymerization and $[M]$ and $[I]$ relate to the concentrations of monomer and initiator, respectively. A number of methods are available for determining the activity of organometallics and in an earlier volume in this series, Taylor³⁷ has provided detailed experimental procedures for three such methods as follows:

1. *The double titration procedure.*³⁸ Here the total base concentration is determined by quenching with water and titrating with HCl. Second, the non-organometallic base is determined by destroying the organometallic with an alkyl halide (generally 1,2-dibromoethane) prior to quenching and titrating to determine the concentration of base.
2. *Charge-transfer titration.*³⁹ Here the coloured charge-transfer complex formed between organometallics and certain heterocyclic compounds is used as an indicator to determine the end-point of a titration with butanol.
3. *Formation of coloured dianions.*⁴⁰ 2,5-Dimethoxybenzyl alcohol, diphenylacetic acid, and 1-pyreneacetic acid (**3**, Scheme 10) are amongst a number of compounds that form coloured dianions on reaction with organolithium compounds. The organometallic reagent can be titrated directly into a flask containing the indicator, the end-point being the onset of a permanent colour due to the initial formation of the dianion. Apparently this procedure will also work with Grignard reagents but the result is less accurate.³⁷

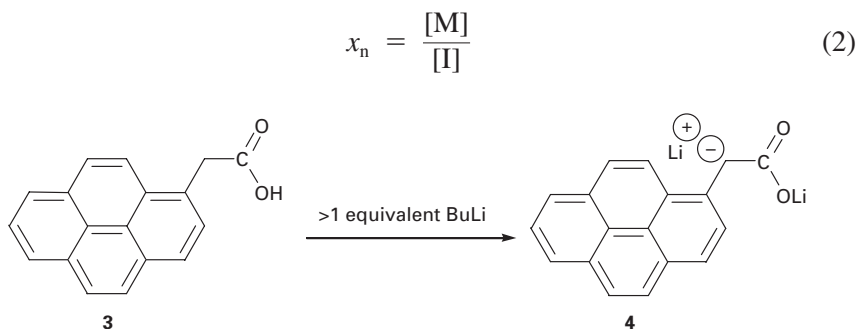

Scheme 10 Reaction of 1-pyreneacetic acid with butyllithium to form a coloured dianion.

* The practice of venting the bottle by placing a syringe needle through the seal and leaving in the fumehood is not recommended except with bottles in which only traces of the reagent remain.

The latter of the three procedures above is particularly convenient and a brief description of the experimental procedure involved is given in Protocol 9.

Polymerizations that use organometallic initiators require careful preparation and planning, in particular to ensure that all glassware solvents and reagents are completely dry. Glassware is dried in an oven for 24 h prior to use and the apparatus is set up while hot and connected to a source of dry nitrogen or argon [usually via a double manifold system (see earlier), but occasionally via a balloon containing inert gas connected to the top of the apparatus]. Syringes and syringe needles, after drying in the oven, are cooled and stored in a desiccator under inert gas, so as to be ready when required. Solvents, monomers, and other reagents must be dried to the highest possible specifications for the best results. This often means multiple purification steps and using the same methodology as used for air and moisture sensitive materials. If possible these reagents should be distilled directly into the (air-tight) polymerization vessel after the final drying stage; if this is not possible then reagent transfer should be performed using a syringe or cannular as described below. Transfer of the organometallic reagent to the reaction flask is usually achieved via a side-arm fitted with a septum cap using a syringe, or for larger quantities of reagent (and in some cases for more reactive reagents), a double-headed needle with one end in the reagent bottle, and one in the flask, in a process known as cannulation. In this latter case, transfer is achieved using a pressure of inert gas applied to the reagent bottle. In the former, the reagent bottle is pressurized with inert gas as shown in Figure 2.3,

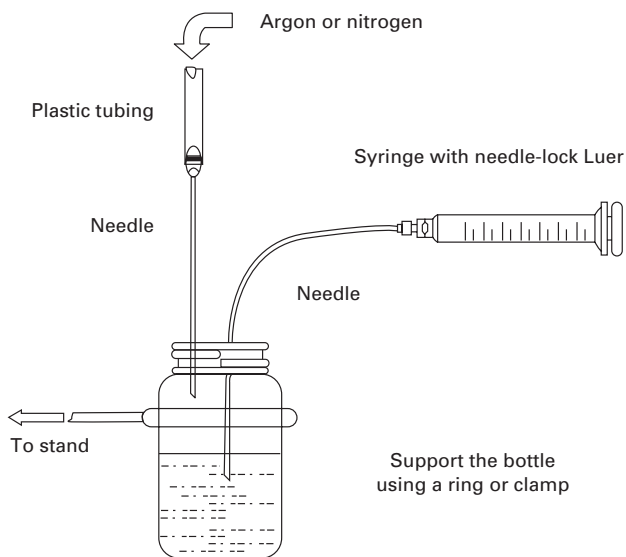

Fig. 2.3 Removal of an organometallic reagent from a reagent bottle using a syringe.

2: General procedures in chain-growth polymerization

before the syringe needle is inserted through the cap (the dry syringe is flushed with dry nitrogen immediately before use).

Protocol 8.

Polymerization of styrene initiated by *sec*-butyllithium (Scheme 11)

Caution! Carry out all procedures in a well-ventilated fume-hood, wear appropriate disposable gloves, a lab-coat, and safety glasses. All vacuum-line work should be performed while standing behind a protective Perspex screen. Never use flat-bottomed flasks with rotary evaporators.

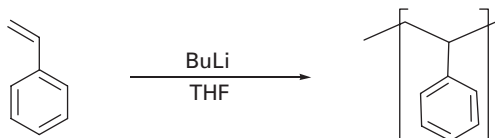

Scheme 11 Polymerization of styrene initiated by *sec*-butyllithium.

Equipment

- Dual manifold (nitrogen/vacuum)
- Two-necked round-bottomed flask (250 mL)
- Nitrogen gas inlet
- Magnetic stirrer
- Teflon-coated magnetic stirrer bar
- Vacuum oven
- Apparatus for filtration under reduced pressure: Buchner flask, sintered-glass funnel, and water aspirator
- Source of dry nitrogen
- Syringe (1 mL)
- Syringe (50 mL)
- Rubber septum
- Beaker (500 mL)
- Erlenmeyer flasks (250 mL)
- Rotary evaporator
- Single-necked round-bottomed flask for use with rotary evaporator

Materials

- Styrene, 10 mL, 87 mmol
 - *sec*-Butyllithium, 1.3 M, 0.5 mL, ca. 0.65 mmol
 - THF, 50 mL
 - Acetone for cooling bath
 - Solid CO₂ for cooling bath
 - Propan-2-ol, 2 mL
 - Dichloromethane, ca. 30 mL
 - Methanol, ca. 500 mL
- flammable, irritating to eyes and respiratory system**
highly flammable, reacts violently with water, spontaneously flammable in air, causes burns, harmful by inhalation
highly flammable, may form peroxides, irritating to eyes and respiratory system
highly flammable
extremely cold solid, vapour can cause rapid suffocation
highly flammable
harmful by inhalation, potential carcinogen
highly flammable, toxic by inhalation and if swallowed

Method

Preparation: Dry all glassware in an electric oven set at 125°C for 24 h prior to reaction. Distil a suitable quantity (>50 mL) of THF into a dry receiver flask fitted with a septum, distil styrene from calcium hydride under reduced pressure into a dry receiver flask fitted with a septum. Butyllithium is titrated with 1-pyreneacetic acid, to obtain an approximate value for its activity.^a

Protocol 8. *Continued*

1. While the apparatus is still hot, set up the two-necked flask with a septum cap and magnetic stirrer bar. Connect to the double manifold with a gas inlet adapter, evacuate the flask and then fill with nitrogen. Allow the flask to cool to room temperature.^b
2. Flush a syringe (50 mL) with nitrogen, by inserting the needle into a septum cap fitted to a piece of tubing connected to the inert gas supply. Withdraw the THF (50 mL) from the receiving flask and transfer into the reaction vessel. Repeat the procedure using the styrene (10 mL, 87 mmol). Cool the reaction flask to ca. -70°C using a dry ice/acetone mixture.
3. A dry syringe needle is connected to the inert gas supply by means of some plastic tubing, with a gentle flow of gas passing through the needle, insert the tip through the seal on the bottle of *sec*-butyllithium. Flush a syringe (1 mL) with nitrogen, by inserting this into a septum cap fitted to a piece of tubing connected to the inert gas supply. Insert the second needle through the seal on the butyllithium and withdraw the required amount of initiator (0.5 mL, 0.65 mmol) as shown in Figure 2.3.
4. Carefully add the butyllithium to the reaction flask by inserting the syringe needle through the septum attached to the side-arm. A dark red colouration due to the presence of the styryl anion will be produced. Stir the polymerization mixture for 4 h.
5. After 4 h the viscous solution should remain red, quench the reaction by adding propan-2-ol (2 mL) *via* the septum (**caution!**). The reaction can be then opened to the atmosphere.
6. The polystyrene is isolated by removing the solvent on the rotary evaporator, dissolving the polymer in the minimum volume of dichloromethane, and then pouring this solution into a beaker containing aqueous methanol (1:4, ca. $10 \times$ volume). Further purification is achieved by repeated dissolution in dichloromethane, followed by re-precipitation into methanol; finally, the white solid is dried in a vacuum oven at 60°C .

^aA dry two-necked round-bottomed flask containing a magnetic stirring bar is charged with dry 1-pyreneacetic acid (ca. 100 mg, 0.38 mmol), and fitted with a rubber septum and a nitrogen inlet. The flask is evacuated then flushed with nitrogen using the double manifold and dry THF (10 mL) is added and the resulting solution stirred. A graduated syringe (1 mL) is charged with the organolithium reagent and this is added drop-wise to the solution of pyrene acetic acid over several minutes noting the volume added when the red colour of the dianion persists.

^bAlternatively, the hot system can be evacuated and then flushed with nitrogen several times to ensure complete replacement of the air with dry inert gas.

Although the polymerization with butyllithium is an effective way of generating polymer, both initiation and propagation in ionic polymerizations are rather complex processes and governed by factors such as solvation and binding to counterions. For the polymerization of methacrylates, a particular problem with butyllithium is the reactivity towards the carbonyl group, for

2: General procedures in chain-growth polymerization

this reason less reactive initiators such as diphenylhexyllithium (Scheme 12) have been used with some success.⁴¹ Particularly convenient are salts between lithium and large aromatic molecules with acidic hydrogens, one of the most common examples being fluorene.⁴² While this compound is a rather weak acid, it is of course considerably more acidic than butane and consequently the salt can be easily prepared by reaction with butyllithium, this salt can be used to initiate the polymerization of methyl methacrylate in a relatively simple procedure.^{1(e),32} In the example below the formation of a largely syndiotactic polymer is described (Scheme 13), this stereochemical control is provided largely by the solvent and hence a similar procedure using toluene as the solvent will produce a predominantly isotactic material.

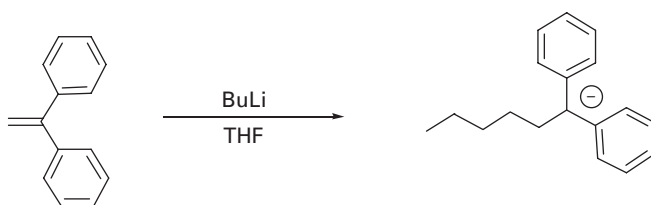

Scheme 12 Reaction of butyllithium with 1,1-diphenylethene to form diphenylhexyllithium.

Protocol 9.

Preparation of predominantly syndiotactic methyl methacrylate using 9-fluorenyllithium as the initiator (Scheme 13)

Caution! Carry out all procedures in a well-ventilated fume-hood, wear appropriate disposable gloves, a lab-coat, and safety glasses. All vacuum-line work should be performed while standing behind a protective Perspex screen.

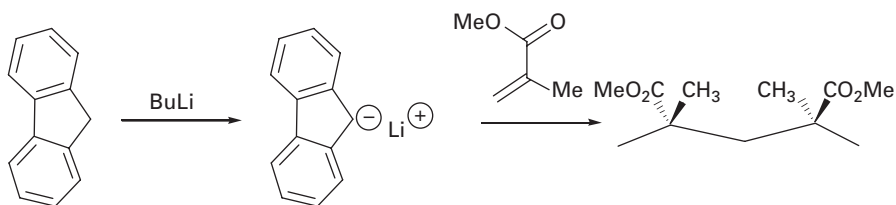

Scheme 13 Polymerization of polystyrene initiated with 9-fluorenyllithium.

Equipment

- Dual manifold (nitrogen/vacuum)
- Two-necked round-bottomed flask (250 mL)
- Nitrogen gas inlet
- Stirrer
- Dry ice/acetone bath
- Source of dry nitrogen
- Syringe (1 mL)
- Syringe (10 mL)
- Syringe (50 mL)
- Vacuum oven

Protocol 9. *Continued*

- Teflon[®]-coated magnetic stirrer bar
- Apparatus for filtration under reduced pressure: Buchner flask, sintered-glass funnel, and water aspirator
- Rubber septum
- Beaker (500 mL)
- Erlenmeyer flasks (250 mL)
- Condenser

Materials

- Fluorene, 0.2 g, 1.2 mmol
- Butyllithium, 1.6 M, 0.3 mL, 0.5 mmol
- THF, 50 mL
- Methyl methacrylate, 10 g, 100 mmol
- Acetone for cooling bath
- Solid CO₂ for cooling bath
- Methanol, ca. 200 mL
- Petroleum ether, ca. 1 L
- Dichloromethane, ca. 30 mL

avoid inhalation and contact with skin and eyes
highly flammable, reacts violently with water,
spontaneously flammable in air, causes burns,
harmful by inhalation
highly flammable, may form peroxides, irritating
to eyes and respiratory system
highly flammable, irritating to respiratory system
and skin, may cause sensitization by skin contact
highly flammable
extremely cold solid, vapour can cause rapid suffocation
highly flammable, toxic by inhalation and if swallowed
highly flammable
harmful by inhalation, potential carcinogen

Method

Preparation: Dry the glassware in an oven for 24 h prior to construction, all solvents and monomers should be dried prior to use (see earlier).

1. A two-necked round-bottomed flask (250 mL) is equipped with a reflux condenser, septum cap, and magnetic stirrer bar, and connected to a supply of dry inert gas via the manifold system. The system is then evacuated and heated with a flame or a hot air gun to remove any residual trace of water and allowed to cool under nitrogen.
2. Fluorene (0.2 g, 1.2 mmol) is then added to the flask and the flask once again evacuated then purged with nitrogen. Dry THF^a (50 mL) is then added via the septum. When the fluorene has dissolved completely, *n*-butyllithium (0.3 mL, 0.5 mmol) is then added *via* the septum, and the mixture stirred for 1 h, the orange colour providing an indication that the reaction is complete.
3. The solution of 9-fluorenyllithium is then cooled to ca. -70°C in a dry ice/acetone bath and dry methyl methacrylate (10 g, 100 mmol)^b which has been allowed to stand in the dry ice/acetone bath for about 10 min is added to the solution using a syringe. The polymerization is allowed to continue for about 5 h and then the reaction is quenched using methanol (10 mL).
4. After allowing the viscous solution to warm to room temperature, the polymer is precipitated by pouring slowly into 500 mL of petroleum ether with stirring. The solid polymer is then collected and dissolved in dichloromethane, and re-precipitated into petrol as before. The resultant polymer is then collected at the pump using a sintered-glass funnel and washed thoroughly with methanol. Finally, the polymer is dried for 24 h in the vacuum oven at 50°C . The tacticity of the polymer can be gauged from NMR or IR spectroscopy.

2: General procedures in chain-growth polymerization

^aDried with CaH_2 for 24 h and then distilled from sodium with benzophenone as the indicator (see Table 2.2).

^bMethyl methacrylate is passed through a basic alumina column directly into a round-bottomed flask containing CaH_2 and stored in the fridge. This should be distilled directly from the CaH_2 under vacuum prior to use.

An alternative method of initiation is through the use of the radical anion produced from the reaction of sodium (or lithium) with naphthalene. Such radical anions react with styrene by electron transfer to form styrene radical anions; these dimerize to produce a dianion, which initiates polymerization as outlined in Scheme 14. One particular feature of this method is that polymerization proceeds outwards from the centre. Subsequent reaction of the living chains ends with another suitable monomer system produces a triblock copolymer. This is the principle by which styrene–butadiene–styrene triblock copolymers (formed when butadiene is polymerized in the same way, and styrene is added as second monomer) are produced commercially. This material behaves as a thermoplastic elastomer, since the rigid styrene blocks form cross-links at room temperature; on heating these rigid styrene portions soften, allowing the material to be remoulded.^{1(b)}

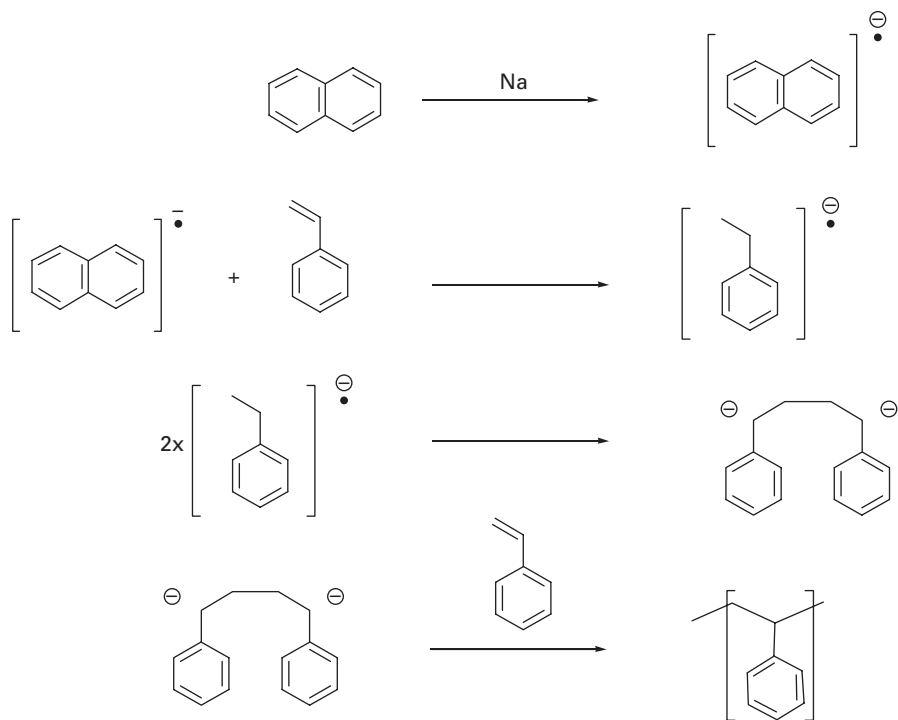

Scheme 14 Polymerization of polystyrene initiated with the sodium naphthalene anion.

Protocol 10.

Preparation of the sodium naphthalene anion and polymerization of styrene

Caution! Carry out all procedures in a well-ventilated fume-cupboard, wear appropriate disposable gloves, a lab-coat, and safety glasses. All vacuum-line work should be performed while standing behind a protective Perspex screen. Never use flat-bottomed flasks with rotary evaporators.

Equipment

- Dual manifold (nitrogen/vacuum)
- Source of dry nitrogen
- Reflux condensers
- Syringe (50 mL)
- Syringe needle connected to inert gas supply
- Two-necked round-bottomed flask (100 mL)
- Teflon[®]-coated magnetic stirrer bar
- Teflon[®]-stirrer guider
- Apparatus for filtration, Buchner funnel, flask, and water pump
- Three-necked round-bottomed flask (250 mL)
- Thermometer
- Gas bubbler
- Mechanical overhead stirrer, stirrer rod, and paddle
- Stirrer
- Dry ice/acetone bath
- Rubber septa
- Vacuum oven
- Beakers and Erlenmeyer flasks (various)

Materials

- Naphthalene, 12.8 g, 100 mmol **harmful if swallowed, very toxic to aquatic organisms, may cause long-term adverse effects in an aquatic environment**
- Sodium metal, 2.5 g, 108 mmol **reacts violently with water liberating highly flammable gases, causes burns**
- THF, 100 mL **highly flammable, may form peroxides, irritating to eyes and respiratory system**
- Styrene, 10 mL, 87 mmol **flammable, irritating to eyes and respiratory system**
- Methanol, ca. 500 mL **highly flammable, toxic by inhalation and if swallowed**
- Dichloromethane, ca. 30 mL **harmful by inhalation, potential carcinogen**
- Acetone for cooling bath **highly flammable**
- Solid CO₂ for cooling bath **extremely cold solid, vapour can cause rapid suffocation**
- Standard hydrochloric acid solution (ca. 0.1 M) **causes burns, irritating to the respiratory system**

Method

Preparation: Dry all glassware by leaving in an electric oven set at 125°C for 24 h prior to reaction. Distil a suitable quantity (>50 mL) of THF into a dry receiver flask fitted with a septum. Distil styrene from calcium hydride under reduced pressure into a dry receiver flask fitted with a septum. Naphthalene is purified by sublimation at reduced pressure.

1. While the apparatus is still hot,^a a three-necked round-bottomed flask (250 mL) is equipped with an overhead stirrer, a rubber septum through which a needle connected to the inert gas supply is inserted and a condenser to which a gas bubbler containing silicone fluid is attached. The apparatus is then left to cool with a gentle stream of dry nitrogen flowing through the system.^b
2. With the nitrogen flowing condenser is removed, naphthalene (12.8 g, 100 mmol) is added to the flask and the condenser quickly replaced. Then using a dry syringe, THF (100 mL) is transferred to the reaction flask.

2: General procedures in chain-growth polymerization

3. Remove a piece of sodium from the oil and cut pieces from the lump. These should be washed in hexane contained in a small beaker, wiped dry with a piece of clean filter paper, weighed, and then replaced in the hexane. When 2.5 g of sodium has been obtained the pieces should be cut to approximately the size of a match-head (still keeping the sodium in the hexane as far as possible). The pieces of sodium are dried and quickly added to the flask as in step 2.^c
4. The flask is stirred rapidly and cooled by means of an ice-bath such that the temperature does not exceed about 30°C, the reaction mixture is then stirred for 2 h.
5. A small sample (3 mL) is removed from the flask via the septum using a syringe, and dropped into methanol (5 mL) this solution is then added to water (10 mL) and titrated using dilute hydrochloric acid (0.1 M).^d
6. The pre-dried two-necked round-bottomed flask (100 mL) is equipped with a reflux condenser, septum cap, and Teflon[®]-coated magnetic stirrer, while hot^{a,b} and connected to a supply of dry inert gas via the manifold system. The system is then evacuated and flushed with nitrogen several times and allowed to cool under nitrogen.
7. Using a syringe needle, dry THF (50 mL) is added to the flask. Then a small quantity of the sodium naphthalene catalyst is added until the green colour persists.^e The required amount of catalyst solution is then added (e.g. 0.4 mL see note *d*) using a syringe. The solution is cooled to ca. -78°C using a dry ice/acetone bath and stirred. Styrene (10 mL, 87 mmol) is then added using a syringe. The solution turns from green to red in colour.
8. The polymerization is allowed to proceed for ca. 2 h, whereupon the reaction is warmed to room temperature. The reaction is quenched by the addition of methanol (1 mL), and the polymer is isolated by precipitation into methanol as detailed above (Protocol 8, Step 6), and dried in the vacuum oven at 60°C.

^aCare—wear heat-resistant gloves.

^bThe apparatus should be used immediately on reaching room temperature; if it is left for any period of time it can be flamed (in fact a hot-air gun is a convenient heat source for this purpose) under dry nitrogen and allowed to recool.

^cThe reaction begins almost immediately and a dark green colour due to the naphthalene radical anion is observed.

^dIt is important to obtain a reasonable idea of the initiator concentration so that one can effectively gauge the relative quantities of styrene and initiator to form the desired molecular weight polymer in the next stage.

^eA few drops. This effectively titrates the quantity of water present in the solvent and glassware.

Block copolymers have a number of interesting properties, in particular, when they are made up of incompatible units. Such materials show extremely interesting morphologies,⁴² as it is possible to obtain phase separation, with each unit forming separate domains. The potential for self-assembly of such units is now attracting considerable interest, particularly in the area of photonic crystals.⁴³ As the following procedures show, the methods by which

block copolymers can be formed are similar to those described above, although fatigue processes may be more important in determining the structure of the final polymer, and it is recommended that the polymer is thoroughly analysed by, for example, gel permeation chromatography (GPC) at each stage of the polymerization process, in order to establish the effectiveness of the methodology. It should also be noted that although good quality materials can be prepared using the methods below, high-vacuum techniques such as those described in Ref. 2 give outstanding results in terms of molecular weight distribution, and facilitate the formation of quite complex polymer geometries.

Protocol 11.

A block copolymer of styrene and isoprene (Scheme 15)

Caution! Carry out all procedures in a well-ventilated fume-cupboard, wear appropriate disposable gloves, a lab-coat, and safety glasses. All vacuum-line work should be performed while standing behind a protective Perspex screen. Never use flat-bottomed flasks with rotary evaporators.

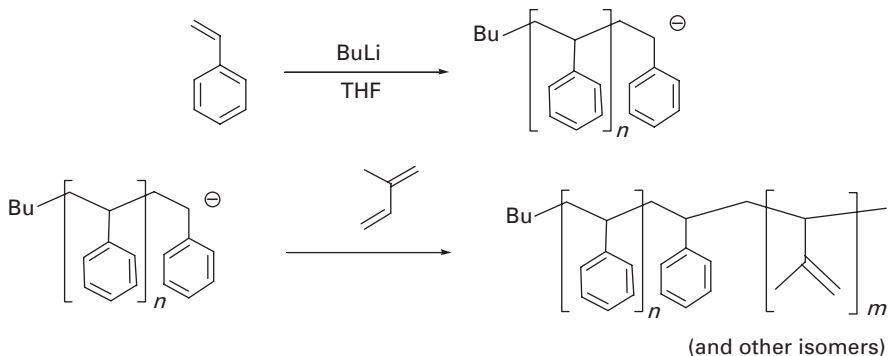

Scheme 15 A block copolymer of styrene and isoprene.

Equipment

- Dual manifold (nitrogen/vacuum)
- Source of dry nitrogen
- Two-necked round-bottomed flask (100 mL) (×2)
- Gas-tight syringe (10 mL)
- Gas-tight syringe (50 mL)
- Gas-tight syringe (2 mL)
- Two-necked round-bottomed flask (250 mL)
- Dry ice-bath
- Rotary evaporator
- Apparatus for filtration, Buchner funnel, flask, and water pump
- Teflon[®]-coated magnetic stirrer bar
- Hotplate stirrer
- 10 cm long narrow bore needle (×2)
- 20 cm long narrow bore needle
- Single-necked round-bottomed flask (100 mL)
- Beakers and Erlenmeyer flasks (various)
- Rubber septa
- Dry ice/acetone bath
- Vacuum oven
- Vacuum desiccator

2: General procedures in chain-growth polymerization

Materials

- Styrene, ca. 5 mL, 44 mmol
 - Isoprene, ca. 5 mL, 50 mmol
 - *sec*-Butyllithium 1.3 M, 0.5 mL, 5.85 mmol
 - THF, 50 mL
 - Acetone for cooling bath
 - Solid CO₂ for cooling bath
 - Methanol, ca. 150 mL
 - Dichloromethane, ca. 30 mL
- flammable, harmful by inhalation
extremely flammable very toxic to aquatic organisms, may cause long-term adverse effects in an aquatic environment
highly flammable, reacts violently with water, spontaneously flammable in air, causes burns, harmful by inhalation
highly flammable, may form peroxides, irritating to eyes and respiratory system
highly flammable
extremely cold solid, vapour can cause rapid suffocation
toxic, highly flammable
harmful by inhalation potential carcinogen

Method

Preparation: Dry all glassware by leaving in an electric oven set at 125°C for 24 h prior to reaction. Distil a suitable quantity (>50 mL) of THF into a dry receiver flask fitted with a septum. Styrene may be distilled from calcium hydride under reduced pressure into a dry receiver flask fitted with a septum and then purged with inert gas. Isoprene may be distilled on a gas line over *n*-butyllithium at 0°C before being distilled into a dry receiver flask and purged with inert gas as per Ref. 2.

1. While the apparatus is still hot, a two-necked round-bottomed flask (250 mL)^a is equipped with a Teflon-coated magnetic stirrer bar, a rubber septum on one neck whilst the second neck is connected to the double manifold.
2. The polymerization flask is then evacuated and then subsequently purged with inert gas.
3. Approximately 50 mL of dry THF is then transferred via syringe to the flask.
4. The required volume of styrene (e.g. 5 mL, 44 mmol) is then added to the THF and the mixture stirred.^b The mixture is then cooled down to ca. -70°C with a dry ice/acetone bath.
5. The required amount of initiator (*sec*-butyllithium 0.05 mL, 0.65 mmol) is then added to the polymerization tube whilst stirring vigorously.^c The solution should turn red in colour.
6. Allow the solution to warm to room temperature, and stir for 30 min. Then cool down the content of the flask to ca. -70°C.^d
7. Once the flask is cool, isoprene (5 mL, 50 mmol) is added and the polymerization mixture is once again warmed to room temperature and stirred for a further 30 min.
8. The reaction is quenched by injecting dry methanol (1 mL, **caution!**) and opening the system to air.
9. The solution is then transferred to a single-necked round-bottomed flask (100 mL) and all the solvent is removed using a rotary evaporator.
10. The polymer is purified by redissolving the residue in a minimum amount of dichloromethane and precipitation into ice-cold methanol. The solution is decanted to leave a white precipitate and the remaining solvent removed by

Protocol 11. Continued

filtration at the water pump. This procedure is then repeated twice and the polymer dried using a vacuum desiccator or vacuum oven.^e

^aAs an alternative, a two-necked Schlenk tube can be used (see Chapter 3, Figure 3.4).

^bAt this stage the mixture can be degassed using the freeze–pump–thaw–purge method (outlined in Protocol 1).

^cCare must be taken to ensure that the initiator is injected directly into the cold, stirring solution. Initiator that touches the sides of the polymerization tube first may be liable to react with styrene residue, thus not initiating the solution effectively.

^dAt this stage an aliquot may be removed for analysis to check the percentage conversion of monomer to polymer.

^eThe precise procedure for purification will be determined by the composition of the copolymer, if the material is soft at room temperature then filtration will not be possible and draining the majority of the non-solvent off will be sufficient.

This method for the preparation of poly(styrene-*b*-tBuA) is based upon the procedure described by Jérôme *et al.*⁴⁴ Teyssie and co-workers^{45,46} demonstrated that the addition of LiCl can be effective in the living anionic polymerization of the acrylic monomers, because a μ -type complex⁴⁷ is formed between LiCl and the growing site. This complex prevents the occurrence of side-reactions at the propagating site, thus markedly narrowing the molecular weight distribution.

Protocol 12.

Synthesis of poly(styrene-*b*-tBuA) diblock copolymer

Caution! Carry out all procedures in a well-ventilated fume-hood, wear appropriate disposable gloves, a lab-coat, and safety glasses. All vacuum-line work should be performed while standing behind a protective Perspex screen. Never use flat-bottomed flasks with rotary evaporators.

Equipment

- Dual manifold (nitrogen/vacuum)
- Two-necked round-bottomed flask (100 and 50 mL)
- Gas-tight syringe (10 mL)
- Gas-tight syringe (50 mL)
- Gas-tight syringe (2 mL)
- Magnetic stirrer bar
- Dry ice-bath
- Rotary evaporator
- Source of dry nitrogen
- Beakers and Erlenmeyer flasks (various)
- Hotplate stirrer
- Nitrogen gas inlet
- Syringe needles (various)
- Rubber septa
- Apparatus for filtration, Buchner funnel, flask, and water pump
- Vacuum oven

Materials

- Freshly distilled styrene,^a 6.6 mL, 58 mmol
- Freshly distilled *tert*-butyl acrylate,^b 4.57 mL, 31 mmol
- Lithium chloride, 0.02 g, 0.5 mmol
- α -Methylstyrene, 0.05 mL, 0.38 mmol

**flammable, harmful by inhalation
highly flammable, irritating to eyes skin and respiratory
system. very toxic to aquatic organisms, may cause
long-term adverse effects in an aquatic environment
harmful if swallowed, irritating to eyes, skin, and
respiratory system
flammable irritant**

2: General procedures in chain-growth polymerization

- *sec*-Butyllithium, 1.3 M, 0.5 mL, 0.65 mmol **highly flammable, reacts violently with water, spontaneously flammable in air, causes burns, harmful by inhalation**
- THF 50 mL **highly flammable, may form peroxides, irritating to eyes and respiratory system**
- Acetone for cooling bath **highly flammable**
- Solid CO₂ for cooling bath **extremely cold solid, vapour can cause rapid suffocation**
- Methanol, ca. 150 mL **toxic, highly flammable**

Method

Initiator preparation

The monofunctional initiator [(α -methylstyryl)-lithium (α -MeSt⁻Li⁺)] is prepared by reacting *sec*-BuLi with a slight molar excess of α -MeSt at room temperature in dry THF.

1. Flush nitrogen through a pre-dried two-necked round-bottomed flask (50 mL) equipped with a magnetic stirrer bar and sealed with two septa.
2. Freshly distilled THF (10 mL) is added directly via a gas-tight syringe through the side-arm of the flask.
3. *sec*-Butyllithium 1.3 M (0.5 mL, 0.65 mmol) is then added at room temperature directly via a gas-tight syringe through the side-arm of the flask.
4. α -Methylstyrene (0.05 mL, 0.38 mmol) is then added to the stirred mixture, at room temperature, via a gas-tight syringe through the side-arm of the flask. The colour of the solution should turn and stay dark red.^c

Polymerization reaction

5. Into a dry two-necked, round-bottomed flask (100 mL) equipped with a magnetic stirrer bar, a septum cap, and a nitrogen gas inlet attached to the double manifold, add lithium chloride (0.02 g, 0.5 mmol) under a flow of nitrogen. Freshly distilled THF (50 mL) is added directly *via* a gas-tight syringe through the side-arm of the flask.
6. The initiator solution is transferred into the flask by means of a syringe.
7. Cool down the mixture to ca. -78°C using a dry ice/acetone bath and add freshly distilled styrene (6.6 mL, 57 mmol). The solution should turn a red colour.
8. Allow the solution to warm to room temperature and stir for 30 min. Cool down the content of the flask to ca. -78°C and then add freshly distilled *tert*-butyl acrylate, (4.57 mL, 31 mmol). Stir the mixture for a further 30 min at room temperature.
9. Methanol (5 mL) is then added to the polymerization flask and the contents of the flask is stirred for a further 30 min.
10. The solution is then transferred to a single-necked round-bottomed flask (250 mL) and the THF removed on the rotary evaporator. The crude mixture is then dissolved in a minimum amount of acetone and the dissolved material precipitated into a solution of 7 : 3 methanol : water.

Protocol 12. *Continued*

11. The precipitated material is collected, dissolved it in acetone and precipitated it once again. The dissolution/precipitation step must be done at least three times to ensure the elimination of any traces of unreacted initiator.
12. The precipitated polymer (white solid) is filtered using a Buchner filter and dried under vacuum.

^aStyrene should be washed with 10% NaOH (aq.), dried over Na₂SO₄ and then filtered in order to remove any stabilizer. The resultant pre-dried styrene should then be directly distilled carefully under high vacuum and used immediately.

^bMethacrylate monomers should be passed through a basic alumina column directly into a Schlenk flask containing CaH₂ and stored in the fridge. The monomer should be directly distilled carefully from the CaH₂ under high vacuum and used immediately.

^cLoss of colour suggests that traces of water are present, if the colour disappears rapidly then the system should be investigated for sources of adventitious water. These should be removed and the procedure repeated.

The block copolymer produced in the above protocol can be hydrolysed to produce an acrylic acid containing system. Such block copolymers are not accessible directly by anionic polymerization due to the reactivity of the acidic hydrogen towards basic initiators. The method for the preparation of poly(styrene-*b*-acrylic acid) given below is based upon the procedure described by Zang *et al.*⁴⁸

Protocol 13. Hydrolysis of Poly(styrene-*b*-tBuA) Diblock Copolymer

Caution! Carry out all procedures in a well-ventilated fume-hood, wear appropriate disposable gloves, a lab-coat, and safety glasses. All vacuum-line work should be performed while standing behind a protective Perspex screen. Never use flat-bottomed flasks with rotary evaporators.

Equipment

- Dual manifold (nitrogen/vacuum)
- Two-necked round-bottomed flask (25 mL)
- Single-necked round-bottomed flask (100 mL)
- Gas-tight syringe (10 mL)
- Gas-tight syringe(2 mL)
- Hotplate stirrer and temperature controller
- Vacuum oven
- Source of dry nitrogen
- Nitrogen-gas inlet
- Condenser
- Rubber septum
- 10 cm long narrow bore needle (×2)
- Oil-bath
- Rotary evaporator

Materials

- Hydrochloric acid
 - 1,4-Dioxane 5 mL
- causes burns, irritant
highly flammable, irritating to eyes skin and respiratory system, limited
evidence of carcinogenic effects, repeated exposure may cause skin
dryness or cracking**

Method

1. Into a dry two-necked, round-bottomed flask (25 mL), equipped with a magnetic stirrer bar a rubber septum and a condenser fitted with a nitrogen gas

2: General procedures in chain-growth polymerization

inlet, is added the block copolymer poly(styrene-*b*-tBuA) (3 g) and 1,4-dioxane (5 mL). The gas inlet is attached to the double manifold system and the flask placed under an atmosphere of nitrogen (see Protocol 8).

2. The flask is placed in the oil-bath mounted on the hotplate stirrer and the thermostat set to 65°C. The polymer is then stirred until it dissolves.
3. An excess of hydrochloric acid (the amount depends on the number of acrylate blocks within the polymer) is then added slowly via a gas-tight syringe through the side-arm of the flask.
4. The mixture is then stirred for 6 h. Finally, the solution is transferred to a single-necked round-bottomed flask (100 mL) and the solvent removed on the rotary evaporator. The polymer is dried in the vacuum oven at 40°C.

4. Ring-opening polymerizations initiated by anionic reagents

The ring-opening polymerizations of heterocyclic compounds are important, not least because of the number of commercial polymers produced in this way. The best-known examples include Nylon 6, which is produced from ϵ -caprolactam as shown in Scheme 16; poly(ethylene oxide) produced by ring-opening polymerization of ethylene oxide (or oxirane), a route to which is described in Protocol 14 (Scheme 17), and poly(dimethylsiloxane) which is formed from a cyclic tetramer produced on hydrolysis of dimethylsilyldichloride in a way similar to that described in Protocol 15.

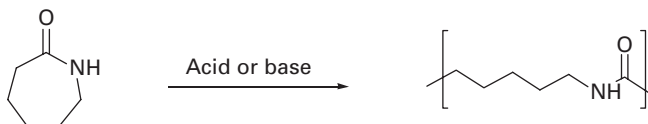

Scheme 16 Synthesis of Nylon 6 from ϵ -caprolactam.

The final products from ring-opening polymerizations often resemble polymers that might be produced by step-growth processes. However, a more detailed consideration in many cases leads to the conclusion that such polymerizations are chain-growth processes although more subtle factors may need to be considered, including some examples where the ring-opening stage merely serves to generate a difunctional monomer which then polymerizes by step growth.⁴⁹ The first example, namely the polymerization of ethylene oxide, illustrates however, that such details aside, many of the techniques described in the previous section are appropriate for ring-opening polymerizations. As with the anionic polymerizations, both the propagating chain, and the counterion must be considered if effective materials are to be produced. Thus, although nucleophilic attack is an important part of the process, coordination of the

resulting alkoxide anion can determine the success of the polymerization. For example, ethylene oxide is not polymerized by butyllithium, although initiation occurs. This is a consequence of tight binding between the lithium ion and the alkoxide ion produced in the initiation process. More recently, it has been shown that polymerization of ethylene oxide with lithium counterions can be achieved in the presence of a strong Lewis base, which acts to disrupt the lithium/alkoxide interactions.^{50,51} Potassium salts are less problematic, and the situation is better still if the metal ion is complexed with a cryptand, in this case Kryptofix[®] 222. This is the case in the following example, which is based on an excellent account by Eisenbach⁵² and Boileau *et al.*^{53*}

Protocol 14.

Ring-opening polymerization of ethylene oxide using an anionic initiator (Scheme 17)

Caution! Carry out all procedures in a well-ventilated fume-hood, wear appropriate disposable gloves, a lab-coat, and safety glasses. All vacuum-line work should be performed while standing behind a protective Perspex screen. Never use flat-bottomed flasks with rotary evaporators.

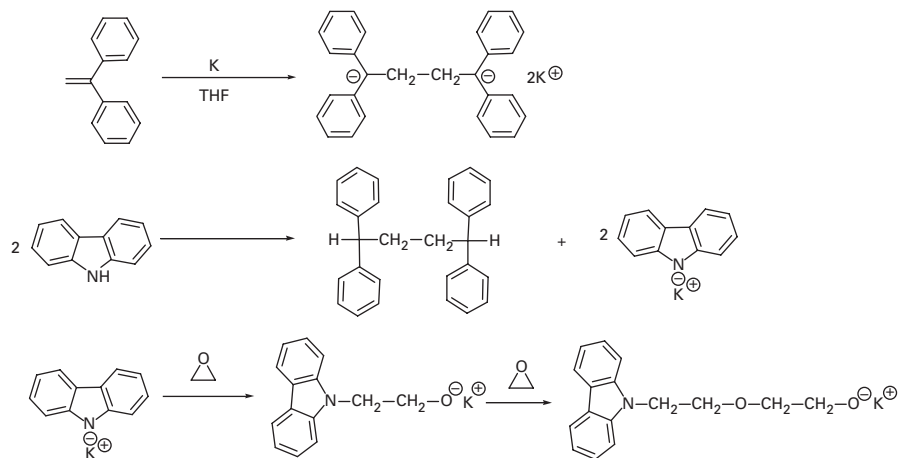

Scheme 17 Anionic ring-opening polymerization of ethylene oxide.

Equipment

- Dual manifold (nitrogen/vacuum)
- Two-necked round-bottomed flask (50 mL × 2)
- Round-bottomed flask (100 mL) fitted with side-arm and taps
- Polymerization tubes
- Source of dry argon
- Gas-tight syringes and needles (25, 10, and 1 mL)
- Gas-inlet tubes
- Dewar containing liquid nitrogen
- Lab-jack

* It should be noted that ethylene oxide can also be polymerized by cationic initiating systems and a wide range of other anionic initiators.

2: General procedures in chain-growth polymerization

- Hotplate stirrer and temperature controller
- Teflon[®]-coated magnetic stirrer bar
- Thermostatted water-bath
- Vacuum oven
- Dry ice/acetone bath
- Oil-bath
- Rubber septa
- Beakers and Erlenmeyer flasks (various)
- Apparatus for filtration, Buchner funnel, flask, and water pump

Materials

- Ethylene oxide, 8 mL, 160 mmol **extremely flammable, very toxic by inhalation, irritating to eyes skin and respiratory system, may cause cancer, may cause heritable genetic damage**
- THF, ca. 50 mL **highly flammable, may form peroxides, irritating to eyes and respiratory system**
- 1,1-Diphenylethene, 0.6 mL, 3.8 mmol **toxicity unknown**
- Potassium metal, 0.5 g, 13 mmol **reacts violently with water, contact with water liberates highly flammable gases, causes burns**
- Sodium metal, ca. 0.2 g **reacts violently with water liberating highly flammable gases, causes burns**
- Carbazole, 0.1 g, 0.8 mmol **irritating to eyes, skin, and respiratory system, very toxic to aquatic systems, may cause long-term adverse effects in the aquatic environment**
- Hexaoxa-1,10-diazabicyclo[8,8,8]hexacosane (Kryptofix[®] 222), 0.012 g, 0.03 mmol **irritating to eyes, skin, and respiratory system**
- Liquid nitrogen for cooling. **extremely cold liquid, vapour can cause rapid suffocation**
- Acetone for cooling bath **highly flammable**
- Solid CO₂ for cooling bath **extremely cold solid, vapour can cause rapid suffocation**
- Methanol, 2 mL **highly flammable, toxic by inhalation and if swallowed**
- Hexane, ca. 2 L **Highly flammable, harmful by inhalation and in contact with the skin**

Method

Preparation: All glassware must be dried in the oven prior to use. 1,1-Diphenylethene is distilled under reduced pressure (b.p. 113 at 2 mmHg)⁵⁴ from a small amount of potassium into a two-necked round-bottomed flask fitted with a septum and connected to the distillation apparatus via a Youngs' tap such that the collecting flask can be filled with argon and removed from the distillation apparatus. Carbazole is purified by recrystallization from toluene, followed by methanol, and then sublimed in vacuum. 4,7,13,16,21,24-Hexaoxa-1,10-diazabicyclo[8,8,8]hexacosane (Kryptofix[®] 222) is dried by placing the required amount in a round-bottomed flask and heating at 60°C for 24 h.

Initiator preparation

1. Potassium (0.5 g, 13 mmol) is placed in a two-necked round-bottomed flask (50 mL) fitted with a rubber septum and connected to the dual manifold by a gas-inlet tube. A potassium mirror is created by evacuating the flask and heating the potassium (**caution!**). The flask is then placed under an atmosphere of argon and dry THF (10 mL, see Table 2.2) is added by syringe and the mixture is cooled in a dry ice/acetone mixture (−78°C). 1,1-Diphenylethene (0.6 mL, 3.8 mmol) is then added by syringe, whereupon a deep red colour is formed indicating the immediate formation of 1,1,4,4-tetraphenyltetramethylene dipotassium. The solution is maintained at −78°C for ca. 48 h to ensure complete reaction.

Protocol 14. Continued

2. Under an atmosphere of argon, carbazole (0.1 g, 0.8 mmol) is placed into a two-necked round-bottomed flask (50 mL) connected to the inert gas supply via the double manifold and fitted with a septum and a Teflon[®]-coated magnetic follower. Into this flask is introduced THF (5 mL) and then using a syringe, 1,1,4,4-tetraphenyltetramethylenedipotassium is added slowly, while the solution is vigorously stirred; a faint pink colouration indicating an excess has been added and that the addition should be stopped.^a
3. Kryptofix[®] (0.012 g, 0.03 mmol) is placed in a two-necked round-bottomed flask (50 mL) fitted with a rubber septum and connected to the double manifold by a gas-inlet tube. The flask is then heated to 60°C for a further 2 h and then cooled to room temperature and immediately prior to polymerization, the minimum volume of THF is added to dissolve the ligand.

Monomer preparation

4. Into a dry tube fitted with a Youngs' tap and a Quickfit joint (of the type used to polymerize butyl acrylate in Protocol 1) is placed a small piece of sodium (about the size of a match-head). The tube is connected to the manifold or a vacuum line, evacuated and a sodium mirror formed (as for potassium above.) The tube is then cooled (−78°C, dry ice/acetone) and ethylene oxide (ca. 8 mL) is added from the cylinder.^b The tube is then held at −10°C for 24 h. After this time the liquid is once again connected to the gas-line, frozen (liquid nitrogen), and the tube evacuated. An identical tube containing a sodium mirror is also prepared on the same line and cooled to −78°C. The first tube is allowed to return to room temperature and ethylene oxide is then transferred by virtue of its low vapour pressure. The second tube is then isolated from the system and once again allowed to stand under vacuum for 24 h.

Polymerization

5. This may be performed in Schlenk-type glassware⁵⁵ of the type shown in Figure 3.4, consisting of a long tube with a side-arm and taps, both at this side-arm and the top of the flask. However, a round-bottomed flask (100 mL) fitted with similar taps is also effective. The side-arm is fitted with a rubber septum and the tap connecting this to the flask is closed. Under an atmosphere of argon, THF (ca. 25 mL) is distilled into the flask and the stopper closed.
6. The polymerization flask is then connected to a gas-line (or the dual manifold) and cooled under liquid nitrogen. The flask is then evacuated and, with the pump isolated, allowed to warm to −78°C. The tube containing the ethylene oxide is also connected to the vacuum line and the series of taps connecting the two tubes opened. As before, the ethylene oxide will transfer under its own vapour pressure.
7. The tube is disconnected from the vacuum line and cooled at −78°C while the solution of Kryptofix[®] is added via the side-arm using a gas-tight syringe, followed by the required amount of the potassium carbazole

2: General procedures in chain-growth polymerization

(0.25 mL, 0.025 mmol). The solution is then allowed to warm to room temperature and then placed in a thermostatted water-bath at 30°C for 1 week (with intermittent agitation).

- After 1 week the anionic chain ends are terminated by the addition of methanol (2 mL) and the polymer is precipitated into an Erlenmeyer flask containing hexane (freshly distilled ca. 1 L). The polymer is then redissolved in THF and re-precipitated into hexane as before, it is then filtered and dried in the vacuum oven at 40°C for 24 h.

^aThe anionic species should be titrated to check the concentration of activated material using the double titration procedure described above.³⁸ Although with sufficient care the yields should be almost quantitative, the concentration of initiator should be adjusted in line with these readings.

^bEthylene oxide can be conveniently prepared as in Ref. 52; by dropping 2-chloroethanol into a suspension of calcium oxide in water refluxing under a slightly reduced pressure (a device known as a barostat can be used for this). The ethylene oxide can be collected in a trap at -78°C.

Polysiloxanes form a class of commercially important inorganic polymers used for example in sealants, lubricants, greases, and elastomers. Poly(dimethylsiloxane) is the most commonly found example. The polymer is prepared by a ring-opening polymerization of octamethylcyclotetrasiloxane, which is itself prepared from dimethyldichlorosilane by hydrolysis as shown in Scheme 18.⁵⁶ The following procedure is a modification of this approach using tetravinyltetramethylcyclotetrasiloxane and serves to illustrate the general applicability of the method.

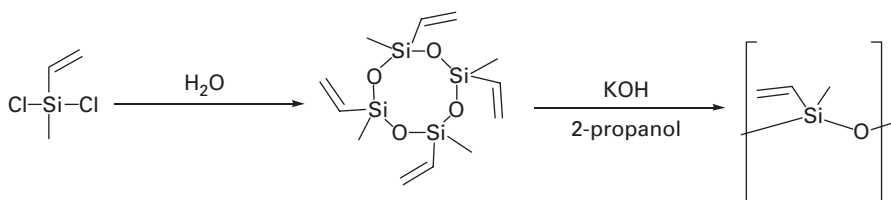

Scheme 18 Formation and ring-opening polymerization of cyclic siloxane.

Protocol 15.

Formation and ring-opening polymerization of octavinylcyclotetrasiloxane

Caution! Carry out all procedures in a well-ventilated fume-hood, wear appropriate disposable gloves, a lab-coat, and safety glasses. All vacuum-line work should be performed while standing behind a protective Perspex screen. Never use flat-bottomed flasks with rotary evaporators.

Equipment

- Dual manifold (nitrogen/vacuum)
- Three-necked round-bottomed flask (250 mL)
- Source of dry nitrogen
- Rubber septum

Protocol 15. *Continued*

- Soda-lime guard tube
- Dropping funnels (100 mL × 2)
- Erlenmeyer flask (250 mL) and funnel
- Separating funnel (500 mL).
- Syringe (50 mL)
- Hotplate stirrer
- Drying tube (CaCl₂)
- Apparatus for distillation at reduced pressure: four single-necked round-bottomed flasks (50 mL), condenser, thermometer, air bleed, 'pig-type' receiver-adaptor, Claisen still-head, and thermometer
- Condenser
- Teflon[®]-coated magnetic follower
- Gas inlet adapter
- Single-necked round-bottomed flasks (250 mL × 2)
- Oil-bath
- Two-necked round-bottomed flask (100 mL)
- Rotary evaporator
- Standard distillation apparatus: thermometer still-head, condenser, receiver-adaptor, single-necked round-bottomed flask (250 mL)

Materials

- Dichloromethylvinylsilane, 27 mL, 0.21 mol **highly flammable, reacts violently with water, causes burns, irritating to respiratory system**
- Potassium hydroxide, 0.20 g, 3.57 mmol **causes severe burns**
- Hydrochloric acid (6 M), 10 mL **causes burns, irritant**
- Diethyl ether, ca. 100 mL **extremely flammable, may form peroxides**
- Magnesium sulfate
- THF **highly flammable, may form peroxides, irritating to eyes and respiratory system**
- Dry propan-2-ol 80 mL **highly flammable. irritating to eyes, vapour may cause drowsiness or dizziness.**

Method

Preparation: Propan-2-ol is dried by refluxing followed by distillation from CaO. The distillate is then allowed to stand over molecular sieve (type 5A) for several days followed by further fractionation.

1. A three-necked round-bottomed flask (250 mL) is equipped with a condenser, two dropping funnels, and a Teflon[®]-coated magnetic follower. To this flask is added diethyl ether (25 mL) and HCl (6 M, 10 mL). One dropping funnel is charged with water (60 mL) and the other with a solution of dichloromethylvinylsilane, (27 mL, 0.21 mol) in diethylether (25 mL) and this tube is fitted with a soda-lime guard tube.
2. The water and the dichloromethylvinylsilane solution are then added slowly to the flask with stirring to maintain gentle boiling without vigorous heating.
3. Once addition is complete, a further portion of ether is added and the two layers are separated in a separating funnel (500 mL). The aqueous layer is then extracted with a further portion of ether (50 mL) and the combined organic layers are dried with MgSO₄ and filtered under gravity using a fluted filter paper.
4. The ether is removed on the rotary evaporator and the product is distilled under reduced pressure (60°C, 1 mmHg)^a to yield a colourless oil.^b
5. Potassium hydroxide (0.20 g 3.57 mmol) is placed in a single-necked round-bottomed flask (250 mL) equipped with a gas-inlet adapter. The flask is attached to the manifold, evacuated (to 0.01 mmHg), and heated to 70°C for 19 h.

2: General procedures in chain-growth polymerization

- The flask is then placed under a nitrogen atmosphere, and dry propan-2-ol (80 mL) is added to the flask, which is set up for distillation at atmospheric pressure.¹⁷ and the volume of solvent is then reduced by distillation to 30 mL. This is the catalyst solution.
- The catalyst solution (0.05 mL) is added to a dry two-necked round-bottomed flask (100 mL), equipped with a gas inlet, under a continuous stream of nitrogen. The flask is then heated to 55°C. After several minutes, a white solid is deposited and no more solvent is visible. At this stage the siloxane (1.00 g) is added, the flask equipped with a drying tube, and the nitrogen inlet removed and replaced with a stopper. The flask is heated rapidly to 160°C to initiate the polymerization process and the polymerization is allowed to proceed for 3 h, whereupon a highly viscous polymeric oil is formed.^c The polymer is soluble in benzene and toluene.^d

^aSee Protocol 1.

^bYield: 4.66 g, 26%.

^cTraces of inorganic material can be removed, if required, by washing a solution of the polymer with a very dilute solution of hydrochloric acid (>0.01 M).

^d¹H NMR δ_{H} (400 MHz; C₆D₆; Me₄Si): 5.90 (1H m vinyl-H), 5.70 (2H, m, vinyl-H), 0.05(3H, s, methyl-H).

4.1 Cationic polymerization

The ability of a monomer to undergo cationic polymerization is dependent on the stability of the cation produced during the propagation stage of the reaction. Styrene undergoes polymerization by cationic, anionic, and free-radical mechanisms owing to the ability of the phenyl ring to stabilize the intermediate. Vinyl ethers are particularly susceptible, due to the stabilizing influence of the oxygen lone pairs, and although in some cases reaction may be somewhat vigorous,* a high degree of control is now possible with relatively complex polymers being made with quite narrow polydispersities.⁵⁷ Cationic polymerization is generally initiated by proton or Lewis acids; and boron trifluoride etherate is quite commonly used, as is the case in the example given below.

Protocol 16.

Cationic polymerization of styrene

Caution! Carry out all procedures in a well-ventilated fume-hood, wear appropriate disposable gloves, a lab-coat, and safety glasses. All vacuum-line work should be performed while standing behind a protective Perspex screen. Never use flat-bottomed flasks with rotary evaporators.

* For example, Sorenson^{1(e)} describes the polymerization of vinyl isobutyl ether using liquid propane to moderate the heat of reaction; on passing a stream of BF₃ through the solution an extremely rapid reaction occurs, with considerable quantities of propane being boiled off in the process.

Protocol 16. *Continued*

Equipment

- Dual manifold (nitrogen/vacuum)
- Three-necked round-bottomed flask (250 mL)
- Nitrogen bubbler
- Disposable syringe and needle
- Beakers and Erlenmeyer flasks (various)
- Stirrer
- Teflon[®]-coated magnetic stirrer bar
- Source of dry nitrogen
- Septum
- Thermometer
- Pasteur pipette
- Apparatus for filtration, Buchner funnel, flask, and water pump
- Vacuum oven

Materials

- Styrene, 30 mL, 262 mmol
 - Boron trifluoride etherate, 0.1 mL, 0.79 mmol
 - Toluene, 75 mL
 - THF, ca. 10 mL
 - Methanol, ca. 1 L
- flammable, irritating to eyes and respiratory system
corrosive, moisture sensitive (distilled)
highly flammable, harmful by inhalation
highly flammable, may form peroxides, irritating to eyes
and respiratory system
highly flammable, toxic by inhalation and if swallowed**

Method

1. Set up the dry three-necked round-bottomed flask (250 mL) with a Teflon[®]-coated magnetic stirrer bar a nitrogen bubbler, thermometer, and septa and flush the equipment with nitrogen.
2. Add the styrene (30 mL, 262 mmol) and toluene (75 mL) to the three-necked flask and stir the solution gently.
3. Add drop-wise BF₃Et₂O (0.1 mL, 0.79 mmol) via a disposable syringe and needle.
4. Once addition of the BF₃Et₂O is complete, separate the needle, syringe barrel, and plunger and transfer them into a 50 mL beaker filled with methanol in order to destroy any unreacted BF₃.
5. Maintain stirring for 5 h, during this time the viscosity of the solution will increase.
6. Add the polymerization mixture dropwise via a Pasteur pipette to 500 mL of methanol stirred in a beaker. Use a flat stirrer bar and adjust the stirring rate so as to induce a non-contorted vortex. A fine white precipitate will be produced, if this is not observed then adjust the stirring rate to produce this.
7. Re-dissolve the crude polymer in THF and re-precipitate the polymer in methanol using the procedure described in step 6. Filter the product and dry in a vacuum oven at 60°C.

5. Coordination polymers

Polymer science is broad-based and requires an understanding of areas traditionally thought of as physics, engineering, and mathematics, in addition to the organic and physical chemistry methodologies discussed above and in the previous chapter. Until now, we have made little mention of an area of

2: General procedures in chain-growth polymerization

what might be traditionally thought of as inorganic chemistry but which has transformed polymer science, and it is fair to say the world we live in, through the commercialization of the products; this is the role of transition metal compounds in the formation of polymers, that is, coordination catalysts. Of these probably the best known and to date most commercially successful are the Ziegler–Natta catalysts.^{58,59} These catalysts, named after the joint winners of the 1963 Nobel Prize for Chemistry, who pioneered their use and development, are used to manufacture a wide range of commercial polymers including high-density polyethylene and isotactic polypropylene. In general, a Ziegler–Natta catalyst is considered to be a combination of a transition metal compound of an element from Groups IV to VIII and an organometallic compound from Groups I to III of the periodic table. However, the most common and significant materials within this broad definition are those based on titanium and aluminium compounds; specifically titanium tri- and tetrahalides and trialkylaluminium compounds. Aluminium alkyls are particularly hazardous and must be handled in the absence of oxygen. Because of the commercial importance of these polymers, an enormous range of catalysts has been developed and a full discussion is outside the scope of this work, however some practical examples can be found in the excellent book by Sorenson.^{1(e)} Currently the most commonly used Ziegler–Natta type systems have titanium tetrachloride on a solid support particularly MgCl_2 .⁶⁰ However, soluble catalysts have much higher efficiencies, and more recently there has been particular interest in the use of soluble metallocene catalysts. In particular, the discovery by Kaminsky that zirconocenes, when used in conjunction with methylaluminoxane (MAO) (produced by partial hydrolysis of trimethylaluminium), is an extremely active catalyst for ethene polymerization and has led to a surge of activity in this area and to the development of a range of new polymeric materials not previously available.^{61,62} The example below, describes how bis(cyclopentadienyl) zirconium dichloride is used in conjunction with MAO to polymerize 1-hexene,⁶³ as shown in Scheme 19.

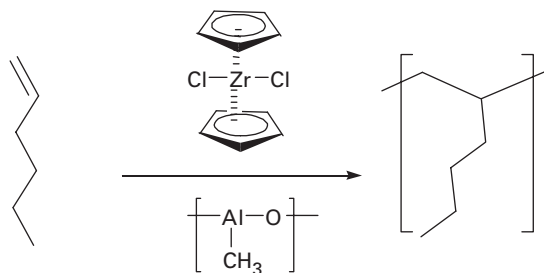

Scheme 19 Polymerization of hexene using metallocene-based catalyst system.

Protocol 17.

Polymerization of 1-hexene using a metallocene catalyst

Caution! Carry out all procedures in a well-ventilated fume-hood (or where appropriate in a dry-box) wear appropriate disposable gloves, a lab-coat, and safety glasses. All vacuum-line work should be performed while standing behind a protective Perspex screen. Never use flat-bottomed flasks with rotary evaporators.

Equipment

- Dual manifold (argon/vacuum)
- Two-necked round-bottomed flask (100 mL × 2)
- Dry-box
- Gas-tight syringes and narrow bore needle (2, 10, and 20 mL)
- Lab-jack
- Beakers and Erlenmeyer flasks (various)
- Dry ice/acetone bath
- Rotary evaporator
- Source of dry argon
- Hotplate stirrer
- Teflon[®]-coated magnetic stirrer bar
- Apparatus for filtration, Buchner funnel, flask, standard funnel and water pump
- Single-necked round-bottomed flask (25 mL)
- Separating funnel
- Rubber septa
- Vacuum oven

Materials

- 1-Hexene, 2 mL, 16 mmol
 - Bis(cyclopentadienyl)zirconium dichloride, 0.0292 g, 0.1 mmol
 - MAO (10% solution in toluene), 0.7 mL (12 mmol with respect to aluminium)
 - Dichloromethane, ca. 5 mL
 - Toluene, 5 mL
 - Magnesium sulfate anhydrous
 - Acetone for cooling bath
 - Solid CO₂ for cooling bath
 - Methanol, ca. 200 mL
- highly flammable, harmful: may cause lung damage if swallowed irritating to eyes, skin, and respiratory system**
- reacts violently with water, spontaneously flammable in air, toxic by inhalation, in contact with skin, and if swallowed, causes burns harmful by inhalation, potential carcinogen highly flammable, harmful by inhalation**
- highly flammable extremely cold solid, vapour can cause rapid suffocation highly flammable, toxic by inhalation and if swallowed**

Method

Preparation: All glassware is dried in an electric oven at 125°C for 24 h prior to use; apparatus is constructed whilst still hot and allowed to cool under an atmosphere of inert gas. Toluene is distilled from sodium benzophenone and stored under argon in a two-necked flask equipped with a tap and a septum cap. 1-Hexene is distilled from CaH₂ and stored under argon in the same way as the toluene above.

1. A metallocene solution is prepared by weighing out bis(cyclopentadienyl) zirconium dichloride (0.0292 g, 0.1 mmol) in a glove-box under an argon atmosphere and placing in a dry single-necked round-bottomed flask (25 mL). The flask is then fitted with a appropriate septum cap and removed from the dry-box. With the flask connected to the inert gas supply by means of a syringe needle inserted through the septum, dry toluene (5 mL) is added by means of a clean dry syringe.
2. A dry two-necked round-bottomed flask (100 mL) is equipped with a Teflon[®]-coated magnetic follower, a condenser, and a septum cap. The flask is

2: General procedures in chain-growth polymerization

connected to the dual manifold by means of a gas-inlet tube, and is evacuated and then maintained under an atmosphere of argon.

3. MAO (12.5 mL, 21 mmol with respect to aluminium) is added to the reaction flask using a gas-tight syringe followed by the metallocene solution (0.2 mL 0.004 mmol). The mixture is placed in a dry ice/acetone bath and allowed to stand at -78°C for 1 h.
4. The monomer is prepared for addition by cooling to -78°C in the presence of a portion of MAO. A two-necked round-bottomed flask (100 mL) fitted with a rubber septum is attached to the double manifold by means of a gas-inlet tube and flushed with argon. 1-Hexene (2 mL, 16 mmol) and MAO (0.7 mL, 12 mmol with respect to aluminium) are added using gas-tight syringes of appropriate sizes. The flask is then placed in a dry ice/acetone bath and allowed to stand at -78°C for 30 min.
5. The monomer solution prepared in step 4 above is then added to the metallocene/MAO solution using a syringe as before. The solution is then stirred for 5 days at -78°C .
6. After 5 days, the polymerization is terminated by addition of ice-water (50 mL) and the toluene layer removed. The aqueous layer is placed in a separating funnel and extracted with three portions of CH_2Cl_2 (ca. 3×25 mL). The combined organic extracts are then dried using anhydrous magnesium sulfate filtered and the solvent removed on the rotary evaporator.
7. The crude polymer is dissolved in a small amount of dichloromethane and precipitated by dropping this solution into a cold stirred solution of methanol. This procedure is repeated and the polymer collected by filtration at the pump and dried in the vacuum oven at 40°C for 24 h.

A different type of organometallic process that has also seen many important developments in recent years is the ring-opening polymerization of cyclic alkenes induced by organometallic catalysts, also known as ring-opening metathesis polymerization (ROMP). For example, cyclopentene is polymerized by a $\text{WCl}_6/\text{Al}^i\text{Bu}_3$ catalyst to produce an acyclic polymer as shown in Scheme 20.⁶⁴ It is impossible here to do justice to the outstanding work that has been done in this area,^{65,66} but a simple example is given below; this utilizes a catalyst invented by Professor R. Grubbs⁶⁷ to polymerize norbornene (Scheme 21).⁶⁸ This catalyst is particularly easy to use; and such polymerizations may, for example, be performed in an undergraduate laboratory.³

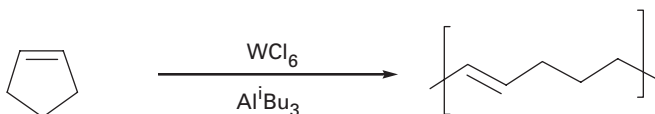

Scheme 20 Ring-opening polymerization of cyclopentene.

Protocol 18.

Ring-opening polymerization of norbornene (Scheme 21)

Caution! Carry out all procedures in a well-ventilated fume-hood (or where appropriate in a dry-box) wear appropriate disposable gloves, a lab-coat, and safety glasses. All vacuum-line work should be performed while standing behind a protective Perspex screen.

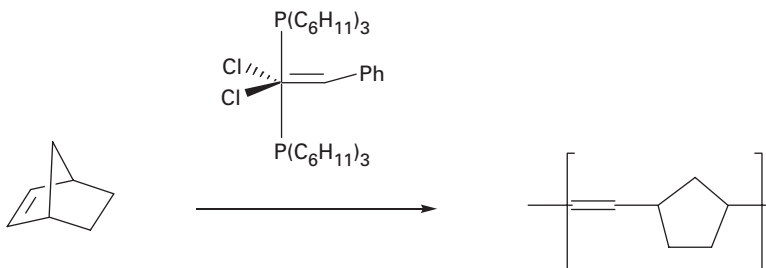

Scheme 21 Ring-opening polymerization of norbornene.

Equipment

- Dual manifold (argon/vacuum)
- Single-necked round-bottomed flask (25 mL)
- Gas-tight syringes and narrow bore needles (1, 5, and 50 mL)
- Two-necked round-bottomed flask (100 mL)
- Magnetic stirrer
- Condenser
- Beakers and Erlenmeyer flasks (various)
- Source of dry argon
- Dry-box
- Apparatus for filtration, Buchner funnel, flask, and water pump
- Teflon[®]-coated magnetic stirrer bar
- Rubber septa
- Gas-inlet adapter
- Vacuum oven

Materials

- Norbornene, 1 g, 11 mmol
 - Benzylidene-bis(tricyclohexylphosphine) ruthenium dichloride, 0.1 g, 0.1 mmol^a
 - Dichloromethane, ca. 45 mL
 - Ethyl vinyl ether, 0.05 mL, 0.5 mmol
 - Methanol, ca. 200 mL
- highly flammable
irritating to eyes, skin, and respiratory system**
- harmful by inhalation, potential carcinogen
highly flammable, repeated exposure may cause skin
dryness or cracking, vapours may cause drowsiness or dizziness
highly flammable, toxic by inhalation and if swallowed**

Method

Preparation: All glassware is dried in an electric oven at 125 °C for 24 h prior to use; apparatus is constructed whilst still hot, and allowed to cool under an atmosphere of inert gas. Dichloromethane is pre-dried with CaCl₂ followed by distillation from CaH₂.

1. A catalyst solution is prepared by weighing out benzylidene-bis(tricyclohexylphosphine)ruthenium dichloride (0.1 g, 0.1 mmol) in a dry-box under an

2: General procedures in chain-growth polymerization

argon atmosphere and placing in a dry single-necked round-bottomed flask (25 mL). The flask is then fitted with an appropriate septum cap and removed from the dry-box. With the flask connected to the inert gas supply by means of a syringe needle inserted through the septum, dry dichloromethane (3 mL), is added by means of a clean dry syringe.^b

2. A dry two-necked round-bottomed flask (100 mL) is equipped with a Teflon[®]-coated magnetic follower, a condenser, a gas-inlet adapter, and a septum cap. The flask is then charged with norbornene (1 g, 11 mmol). The flask is connected to the dual manifold by means of the gas-inlet adapter, and is evacuated^c and then maintained under an atmosphere of argon.
3. By means of a gas-tight syringe, dichloromethane (40 mL) is added the reaction flask, and the mixture stirred until the monomer has dissolved. The polymerization is then initiated by the addition of 0.6 mL of the catalyst solution via a gas-tight syringe, and the solution stirred for 24 h.
4. The polymerization is then halted by the addition of ethyl vinyl ether (0.05 mL, 0.5 mmol).^d The polymer is then precipitated into methanol and purified by dissolving in chloroform and re-precipitation. The polymer is then dried in the vacuum oven at 40°C.

^aResearch-scale quantities of this catalyst can be obtained from the Sigma-Aldrich Corporation.

^bThis procedure can be performed using a glove bag, but in such circumstances it is recommended that the exact quantities required for the polymerization (step 2) should be measured, to avoid any subsequent decomposition of the catalyst solution.

^cThe flask must be cooled at this stage to prevent the monomer subliming.

^dThis stage is necessary to cleave the polymer from the ruthenium.

6. Conclusions

The examples described in this chapter are designed to provide an indication of some of the procedures that are regularly used by polymer chemists to prepare materials, particularly by chain-growth processes. There are of course many useful techniques and examples that have not been included and we have concentrated on (for the most part at least) relatively well-established procedures, which have stood the test of time. With increasing demands on material properties the emphasis on controlled polymerization has also increased; of course anionic polymerization and particularly coordination polymerization techniques have much to offer in this regard, but in recent years other new options have become available to the polymer scientist. Some of these are discussed in the next chapter.

References

1. The reader is referred to a number of excellent textbooks on polymer science. These include: (a) Billmeyer, F. W. *Textbook of Polymer Science*, 3rd edn; Wiley: New York; 1984. (b) Stephens, M. P. *Polymer Chemistry: An Introduction*, 2nd

- edn; Oxford University Press: New York; **1990**. (c) Cowie, J. M. G. *Polymers: Chemistry and Physics of Modern Materials*, 2nd edn; Blackie: Glasgow; Chapman and Hall: New York; **1991**. (d) Young, R. J., Lovell, P. A. *Introduction to Polymers*, 2nd edn; Chapman and Hall: London; **1991**. (e) Allen, G.; Bevington, J. C., eds, *Comprehensive Polymer Science: The Synthesis, Characterization, Reactions & Applications of Polymers*; Pergamon: Oxford; **1989**. For more practical details, see (f) Sorenson, W. R.; Campbell, T. W. *Preparative Methods of Polymer Chemistry*, 2nd edn.; Wiley-Interscience: New York; **1968**.
2. Hadjichristidis, N.; Iatrou, H.; Pispas, S.; Pitsikalis, M. *J. Polym. Sci. Part A: Polym. Chem.* **2000**, 38(18), 3211–3234.
 3. France, M. B.; Uffelman, E. S. *J. Chem. Educ.* **1999**, 76, 661–665.
 4. Takaki, M.; Itoh, T. *J. Chem. Educ.* **1999**, 76(1), 62–63.
 5. Sanford, E. M.; Hermann, H. L. *J. Chem. Educ.* **2000**, 77(10), 1343–1344.
 6. Boffa, L. S.; Novak, B. M., eds. *Transition Metal Catalyst in Macromolecular Design*; American Chemical Society: Washington, DC, **2000**.
 7. Vogl, O.; Furukawa, J., eds, *Polymerisation of Heterocycles*; Dekker: New York; **1973**.
 8. Moad, G.; Solomon, D. H. *The Chemistry of Free Radical Polymerization*; Pergamon: Oxford; **1995**.
 9. Rånby, B. *In Current Trends in Photochemistry*; Allen, N. S.; Edge, M.; Bellobono, I. R.; Selli, E., eds, Ellis Horwood: Hemel Hempstead; **1995**.
 10. Crivello, J. V. *J. Polym. Sci. Part A: Polym. Chem.* **1999**, 37(23), 4241–4254.
 11. Brandrup, J.; Immergut, E. H., eds. *Polymer Handbook*, 3rd edn; Wiley: New York; **1989**.
 12. Aldrich Polymer Products Application and Reference Information.
 13. Teodorescu, M. *Eur. Polym. J.* **2002**, 38(5), 841–846.
 14. Perrin, D. D.; Armarego, W. L. F. *Purification of Laboratory Chemicals*, 3rd edn. Pergamon Press: Oxford; **1988**.
 15. Furniss, B. S.; Hannaford, A. J.; Smith, P. W. G.; Tachell, A. R. *Vogel's Textbook of Practical Organic Chemistry*, 5th edn; Longman Scientific: Essex, UK; **1988**
 16. Casey, M.; Leonard, J.; Lygo, B.; Proctor, G. *Advanced Practical Organic Chemistry*; Blackie: Glasgow; **1990**.
 17. Harwood, L. M.; Moody, C. J.; Percy, J. M. *Experimental Organic Chemistry, Standard and Microscale*; 2nd edn; Blackwell: Oxford; **2000**.
 18. Bretherick, L. *Hazards in the Chemical Laboratory*, 24th edn; Royal Society of Chemistry: London; **1986**.
 19. Dorstal, H. *Monatsh. Chem.* **1936**, 69, 424–426.
 20. Alfrey, T., Jr. *In Copolymerisation*; Ham, G. E., ed., Wiley: New York; **1964**.
 21. Mayo, F. R.; Walling, C. *Chem. Rev.* **1950**, 46, 191–287.
 22. Gilmour, R. A. A. *British Patent* GB2335073, **1999**.
 23. Miri, M.; Morales-Tirado, J. A. *J. Chem. Educ.* **2003**, 80, 839.
 24. Hirokawa, Y.; Tanaka, T. *J. Chem. Phys.* **1984**, 81(12), 6379.
 25. Tanaka, T. *Sci. Am.* **1981**, 244(1), 110.
 26. Sherrington, D. C. *Chem. Commun.* **1998**, 2275–2286.
 27. Okubo, M.; Shiozaki, M.; Tsujihiro, M.; Tsukuda, Y. *Colloid Polym. Sci.* **1991**, 269, 222–226.
 28. Kim, J. W.; Ryu, J. H.; Suh, K. D. *Colloid Polym. Sci.* **2001**, 279, 146–152.

2: General procedures in chain-growth polymerization

29. Flores, A.; Cunliffe, D.; Whitcombe, M. J.; Vulfson, E. N. *J. Appl. Polym. Sci.* **2000**, *77*, 1841–1850.
30. Lettieri, T. R.; Hartman, A. W.; Hembree, G. G.; Marx, E. *J. Res. Nat. Inst. Stand. Technol.* **1991**, *96*(6), 669–691.
31. Kolthoff, I. M.; Dale, W. J. *J. Am. Chem. Soc.*, **1947**, *69*, 441.
32. Sandler, S. R.; Karo, W. *Sourcebook of Advanced Polymer Preparations*; Academic Press: San Diego, CA; **1998**.
33. (a) Szwarc, M. *Nature* **1956**, *178*, 1168. (b) Levy, M.; Milkovich, R.; Szwarc, M. *J. Am. Chem. Soc.* **1956**, *78*, 2656–2657. (c) Szwarc, M. *Carbanions, Living Polymers and Electron-Transfer Processes*; Wiley: New York; **1968**. (d) Szwarc, M. *J. Polym. Sci., Part A: Polym. Chem.* **1998**, *36*, ix.
34. Gill, G. B.; Whiting, D. A. *Aldrichchim. Acta* **1986**, *19*, 31–41.
35. *Aldrich Technical Bulletin*, AL134, Sigma Aldrich Company 1997.
36. Shriver, D. S.; Drezdson, M. A. *The Manipulation of Air-sensitive Compounds*; John Wiley and Sons: New York; **1986**.
37. Taylor, R. J. K.; Casey, G. *In Organocopper Reagents, A Practical Approach*; Taylor, R. J. K., ed., Oxford University Press: Oxford; **1994**.
38. (a) Whitesides, G. M.; Casey, C. P.; Krieger, J. K. *J. Am. Chem. Soc.* **1971**, *93*, 1379–1389. (b) Gimán, H.; Cartledge, F. K. *J. Organometallic Chem.*, **1964**, *2*, 447–454.
39. Watson, S. C., Eastham, J. F., *J. Organomet. Chem.*, **1967**, *9*, 165–168.
40. (a) Harwood, L. M.; Moody, C. J.; Percy, J. M. *Experimental Organic Chemistry, Standard and Microscale*, 2nd edn; Blackwell: Oxford; **2000**, p.532. (b) Kiljunen, H.; Hase, T. A. *J. Org. Chem.* **1991**, *56*(24), 6950–6952.
41. Ozaki, H.; Hirao, A.; Nakahama, S. *Macromolecules* **1992**, *25*(5), 1391–1395.
42. Munk, P. *Introduction to Macromolecular Science*; Wiley: New York; **1989**.
43. Park, C.; Yoon, J.; Thomas, E. L. *Polymer* **2003**, *44*(22), 6725–6760.
44. Jérôme, R.; Varshney, S. K.; Hautekeer, J. P.; Fayt, R.; Jacobs, C.; Teyssié, P. *Macromolecules*, **1990**, *23*, 3893.
45. Varshney, S. K.; Jérôme, R.; Fayt, R.; Teyssié, P.; Jacobs, C.; Bayard, P. *Macromolecules*, **1992**, *25*, 4457.
46. Fayt, R.; Forte, R.; Jacobs, C.; Jérôme, R.; Ouhadi, T.; Teyssié, P.; Varshney, S. K. *Macromolecules*, **1987**, *20*, 1442.
47. Kunkel, D.; Muller, A. H. E.; Janata, M.; Lochman, L. *Makromol. Chem., Macromol. Symp.* **1992**, *60*, 315.
48. Zang, H.; Ruckenstein, E. *J. Polym. Sci. Part A: Polym. Chem.* **1998**, *36*, 1865.
49. Stephens, M. P. *Polymer Chemistry: An Introduction*, 2nd edn; Oxford University Press: New York; **1990**, Ch. 11.
50. Esswein, B.; Moller, M. *Angew. Chem. Int. Ed. Engl.*, **1996**, *35*(6), 623–625.
51. Schmalz, H.; Lanzendörfer, M. G.; Abetz, V.; Müller, A. H. E. *Macromol. Chem. Phys.* **2003**, *204*, 1056–1071.
52. Eisenbach, C. D.; Peuscher, M.; Wegner, G.; Weiss, M. *Makromol. Chem., Macromol. Chem. Phys.* **1983**, *184*(11), 2313–2323.
53. (a) Deffieux, A.; Graf, E.; Boileau, S. *Polymer* **1981**, *22*(4), 549–552. (b) Lasalle, D.; Boileau, S.; Sigwalt, P. *Eur. Polym. J.* **1977**, *13*, 591.
54. *Organic Synthesis Collected Volumes* **1**, 226.
55. *Aldrich Technical Bulletin*, AL-166.
56. Patnode, W.; Wilcock, D. F. *J. Am. Chem. Soc.* **1946**, *68*, 358.

57. Percec, V.; Oda, H. *J. Polym. Sci., Part A: Polym. Chem.* **1995**, 33(14), 2359–2374.
58. Ziegler, K.; Holzlcamp, E.; Breil, H.; Martin, H. *Angew. Chem.* **1955**, 67, 541.
59. Natta, G. *J. Polym. Sci.* **1960**, 48, 219.
60. Soga, K.; Shiono, T. *Prog. Polym. Sci.* **1997**, 22(7), 1503–1546.
61. Kaminsky, W. *J. Chem. Soc., Dalton Trans.* **1998**, 1413–1418.
62. Kaminsky, W.; Arndt, M. *Adv. Polym. Sci.* **1997**, 127, 143–187.
63. Frauenrath, H.; Keul, H.; Höcker, H. *Macromol. Rapid Commun.* **1998**, 19, 391–395.
64. Amass, A. J.; Tuck, C. N. *Eur. Polym. J.* **1978**, 14, 817–823.
65. Grubbs, R. H.; Tumas, W. *Science* **1989**, 243, 907–915.
66. Schrock, R. R. *Acc. Chem. Res.* **1990**, 23, 158–165.
67. Schwab, P.; France, M. B.; Ziller, J. W.; Grubbs, R. H. *Angew. Chem., Int. Ed. Engl.* **1995**, 34, 2039–2041.
68. Ahmed, S. R.; Bullock, S. E.; Cresce, A. V.; Kofinas, P. *Polymer*, **2003**, 44, 4943–4948.

Controlled/‘living’ polymerization methods

WAYNE HAYES and STEVE RANNARD

1. Introduction

Chain-growth polymerizations such as free-radical polymerizations are characterized by four key processes: (i) initiation, (ii) propagation, (iii) chain transfer, and (iv) termination.¹ If it is possible to minimize the contribution of chain transfer and termination during the polymerization, it is possible to achieve a level of *control* over the resulting polymer and achieve a predetermined number average molecular weight and a narrow molecular weight distribution (polydispersity). If such an *ideal* scenario can be created, the number of polymer chains that are produced is equal to the number of initiator groups; the polymerization will proceed until all of the monomer has been consumed and the polymer chain ends will remain active so that further addition of monomer will lead to continued polymerization. This type of polymerization was termed a ‘*living*’ polymerization by Szwarc² in 1956 and represents one of the ultimate goals of synthetic polymer chemists. Flory³ determined that in the absence of termination, the number of propagating polymer chains must remain constant and that the rate of polymerization for each growing chain must be equal. In this situation, the number average degree of polymerization (DP_n) and hence the molecular weight of the polymer can be predicted by simple consideration of the monomer to initiator ratio (see eqns (1) and (2), respectively).

$$DP_n = \frac{[\text{monomer}]}{[\text{initiator}]} \quad (1)$$

$$\text{Number average molecular weight (polymer)} = DP_n \times \text{molecular weight (monomer)} \quad (2)$$

Several key criteria are used to elucidate the ‘living’ nature of a polymerization.⁴ For a polymerization to be considered ‘living’, the rate of initiation must exceed the rate of propagation. Therefore, all the propagating polymer chains are formed simultaneously and grow at the same rate. If this

situation did not occur, the first chains formed would be longer than those initiated later and the molecular weight distribution of the propagating chains would broaden. In addition, an ideal 'living' or 'immortal' polymerization must not exhibit any termination of the propagating polymer chains over the lifetime of the reaction. Consequently, 'living' polymerizations are characterized by very narrow molecular weight distributions ($M_w/M_n < 1.2$). The ability of the propagating species to undergo polymerization until full monomer conversion

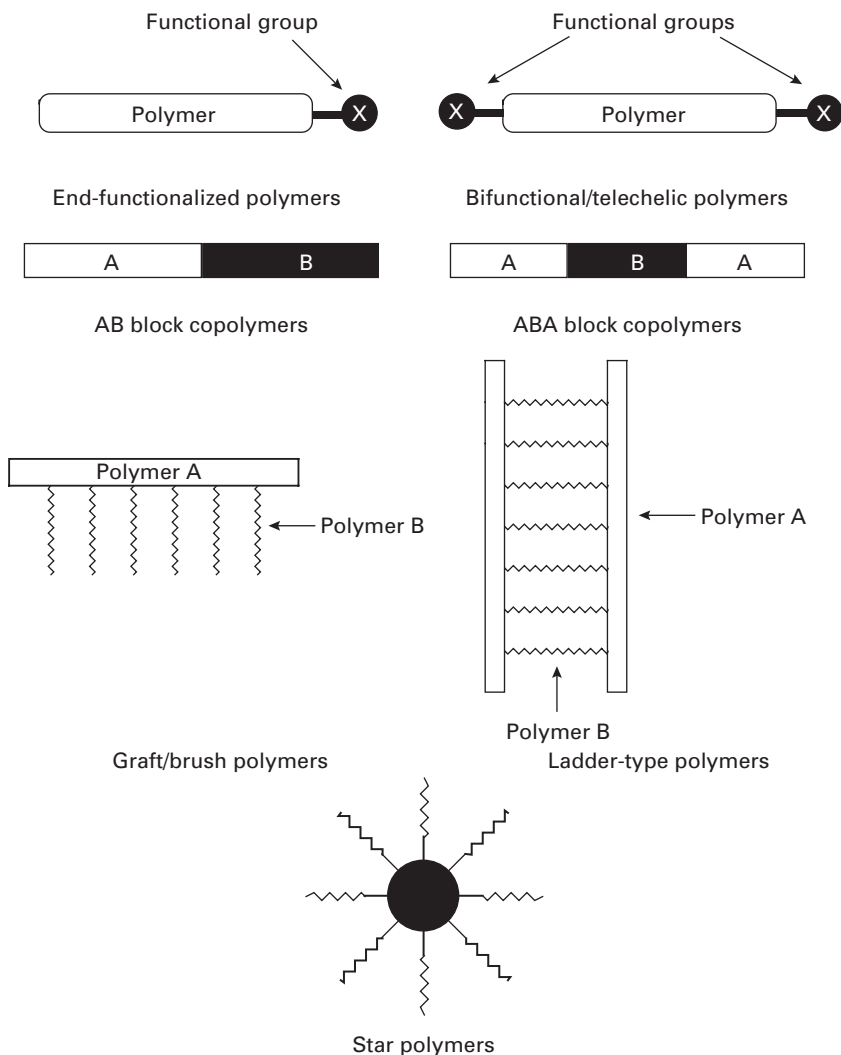

Fig. 3.1 The variety of polymer and copolymer architectures that can be synthesized by 'living' polymerization techniques.

and then to continue polymerizing upon addition of another monomer feed is another key feature of ‘living’ polymerizations (i.e. the active chain ends are stable enough to enable synthesis of block copolymers via sequential monomer addition). If all of these criteria have been satisfied, polymers and block copolymers exhibiting Poisson-type molecular weight distributions will be produced and a linear relationship exists between the number average molecular weight (M_n) of the resultant polymer and monomer conversion.

As a consequence of the development of ‘living’ polymerization methodologies, synthetic polymer chemists are now able to construct, in a precise manner, a wide variety of polymer architectures⁵ (Figure 3.1) that were previously inaccessible using uncontrolled chain-growth methods such as free-radical polymerizations that employed initiators such as azobisisobutyronitrile (AIBN) or benzoyl peroxide.⁶ For example, in light of recent developments in ‘living’ anionic polymerization techniques, ABA block copolymers such as styrene–butadiene–styrene for use in thermoplastic elastomers can be produced in a reliable fashion on an industrial scale.⁵ The implications of ‘living’ polymerization methods upon materials science are enormous, as synthetic polymer chemists now have a range of powerful synthetic tools available to them to facilitate the construction of well-defined polymers almost to order. In this respect, meaningful structure–property relationships (analogous to those employed in drug discovery by the pharmaceutical industry) can be carried out for the first time, enabling detailed development of high technology polymeric materials.

2. Covalent ‘living’ polymerization: group transfer polymerization

Several ‘living’ polymerization techniques have been shown to initiate and propagate by the reaction of an active covalent end group with monomers. One such method is the Group Transfer Polymerization (GTP). This polymerization technique, first described by Webster and co-workers⁷ from the research laboratories of DuPont, employs silyl ketene acetals in the covalent ‘living’ polymerization of a variety of alkylated methacrylates (Scheme 1). Initiation involves Michael-type addition of the monomer to the silyl ketene acetal. The monomer adduct thus formed rapidly adds more monomer in a repetitive Michael-type addition process to afford the desired polymer. The term GTP was adopted to indicate that the silyl group of the silyl ketene acetal initiator system has been transferred to the terminal moiety of the propagating polymer and subsequently to the monomer that is undergoing addition. Each transfer of the silyl group to the monomer regenerates a silyl ketene acetal group at the end of the propagating chain. The polymerization mechanism has received extensive investigation and, to date, a definitive mechanism is yet to receive universal acceptance. Several mechanisms to rationalize the polymerization characteristics have been proposed, including

associative and dissociative and pseudo anionic pathways. However, the focus of this chapter does not permit an extensive discussion of the various mechanistic proposals and the reader is referred to the literature for more details.⁷⁻¹²

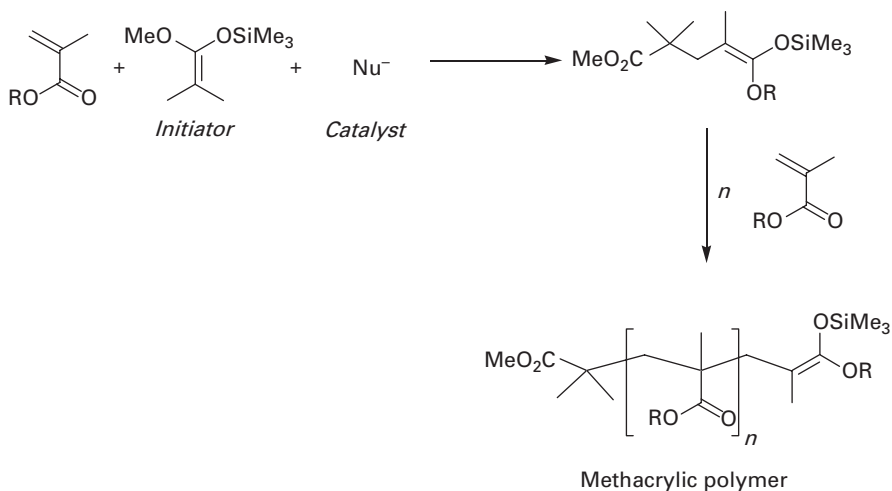

Scheme 1 GTP of methacrylic monomers.

Silyl ketene acetals are relatively stable species and require activation by a catalyst in order to initiate polymerization of α,β -unsaturated monomers. Numerous catalysts for GTP polymerizations have been examined^{7,13,14} and these studies have revealed that bifluorides and bioxyanions such as tris(dimethylamino) sulfonium bifluoride (TASHF₂) and tetra-*n*-butyl ammonium bibenzoate (TBABB), respectively, afford optimum polymerization characteristics. (*Note*: Bifluoride based catalysts are not soluble in tetrahydrofuran (THF) and thus acetonitrile is used as the solvent in these cases; in general TBABB is the optimum catalyst as it is readily soluble in THF and affords better control of molecular weight, conversion, and polydispersity.) GTP has been shown to be robust ($M_w/M_n < 1.1$) and is compatible with numerous α,β -unsaturated monomers including acrylates, ketones, lactones, and polyunsaturated esters such as ethyl sorbate. Many of these polymerizations can be carried out at ambient temperatures, but the method can also be performed using elevated temperatures. In addition, GTP is suitable for use with a wide range of reaction solvents of varying polarity (ranging from *n*-heptane to THF, although note that the protic and electron donor solvents are not suitable for GTP).

Although GTP demonstrates the fundamental characteristics of a 'living' polymerization, namely narrow molecular weight distribution, control of molecular weight derived from the monomer/initiator stoichiometry, and the

3: Controlled/'living' polymerization methods

ability to construct block copolymers, the technique is not foolproof and is inhibited by the presence of moisture and inherent termination reactions such as isomerization and backbiting.

Protocol 1.

Synthesis of the GTP catalyst TBABB (Scheme 2)

This method for the preparation of TBABB is based upon the procedure described by Dicker *et al.*^{13,14}

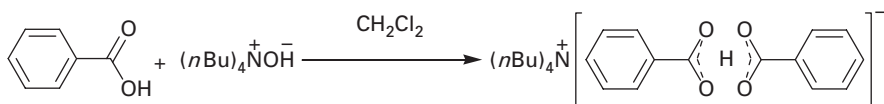

Scheme 2 Preparation of TBABB catalyst.

Caution! Carry out all procedures in a well-ventilated fume-cupboard, wear appropriate disposable gloves, a lab-coat, and safety glasses. All vacuum-line work should be performed while standing behind a protective Perspex screen. Never use flat-bottomed flasks with rotary evaporators.

Equipment

- Separating funnel (250 mL)
- Erlenmeyer flask (250 mL)
- Sintered-glass filter funnel (porosity 2)
- Single-necked round-bottomed flask (500 mL)

Materials

- Benzoic acid, 20.0 g, 164 mmol
- Tetra *n*-butyl ammonium hydroxide, 40% w/v aq., 80 mL
- Dichloromethane, 3 × 50 mL
- Anhydrous magnesium sulfate, ca. 15 g
- THF solvent, 250 mL
- Diethyl ether for precipitation, 300 mL

**irritant, harmful if swallowed and by inhalation
causes burns, harmful by inhalation**

**carcinogen, harmful by inhalation
harmful by inhalation**

**irritant, highly flammable may form explosive peroxides
irritant, highly flammable**

Method

1. To a separating funnel (250 mL), add benzoic acid (10 g, 82 mmol) and tetra-*n*-butyl ammonium hydroxide solution (40% w/v aq., 80 mL) and vigorously shake the mixture until all of the acid has dissolved. Vent the separating funnel at regular intervals to prevent the build-up of excessive pressure in the separating funnel.
2. Extract the aqueous phase with dichloromethane (3 × 50 mL) and combine the organic extracts in an Erlenmeyer flask (250 mL).
3. Add benzoic acid (10 g, 82 mmol) to the organic extracts and stir with a glass rod to ensure complete dissolution of the acid.
4. Dry the organic phase with anhydrous magnesium sulfate (ca. 15 g, 30 min).

Protocol 1. Continued

5. Filter the 'dried' organic phase at the pump through a sintered-glass filter funnel, transfer the solution to a single-necked, round-bottomed flask (500 mL) and concentrate the solution *in vacuo* using a rotary evaporator.
 6. Dissolve the residual solid in warm THF (ca. 250 mL) and concentrate the solution until half of the volume of solvent remains using a rotary evaporator.
 7. To this concentrated solution, slowly add diethyl ether (ca. 250 mL) until a fine white crystalline product is observed. Filter the organic phase at the pump through a sintered-glass filter funnel and wash the product with diethyl ether (ca. 50 mL).
 8. Transfer the white crystalline product to a clean, dry single-necked, round-bottomed flask (100 mL) and dry using a vacuum line. Yields ca. 90% are typical.
-

Protocol 2. GTP of methyl methacrylate (Scheme 1)

Caution! Carry out all procedures in a well-ventilated fume-cupboard, wear appropriate disposable gloves, a lab-coat, and safety glasses. All vacuum-line work should be performed while standing behind a protective Perspex screen.

Polymethylmethacrylate (PMMA) possessing a degree of polymerization of 190 monomer groups and $M_n \approx 19000$ has been targeted in the following procedure.

Equipment

- Dual manifold (nitrogen/vacuum)
- Vacuum source
- Source of dry nitrogen
- Hotplate stirrer
- Teflon-coated magnetic stirrer bar
- Contact thermocouple
- 20 mL gas-tight syringe + 20 cm long narrow bore needle
- Cannula needle
- Three-necked, round-bottomed flask (250 mL)
- Rubber septa
- Beaker (500 mL)
- Buchner filter
- Buchner filter apparatus
- Filter paper (Whatman no. 1)

Materials

- [(1-Methoxy-2-methyl-1-propenyl) oxy]trimethylsilane,^a **irritant**
- Freshly distilled methyl methacrylate,^b **causes burns, may cause sensitization by inhalation and skin contact**
- TBABB, 0.05 g, 0.103 mmol **irritant**
- Freshly distilled THF,^c 50 mL **irritant, highly flammable may form explosive peroxides**
- Methanol for precipitation, ca. 700 mL **toxic, flammable carcinogen, harmful by inhalation**
- Chloroform, ca. 20 mL

Note: Silicone grease should not be used to seal reaction vessels used in GTP methods. Employ apiezon type greases or fine teflon tape instead.

3: Controlled/'living' polymerization methods

Method

1. Vacuum distil THF (50 mL) directly into a clean, dry three-necked, round-bottomed flask (250 mL)—the reaction flask. Purge the flask with dry nitrogen and allow the solvent to warm to room temperature. Remove a stopper and seal with an appropriate rubber septum.
2. Cannulate [(1-methoxy-2-methyl-1-propenyl)oxy]trimethylsilane (0.15 mL, 0.734 mmol) from a graduated 2 mL Schlenk flask using a transfer needle (or cannula) (using this technique it is possible to add the initiator to an accuracy of ± 0.05 mL) by applying pressure from the nitrogen supply as shown in Figure 3.2.
3. Remove the septum and add tetra *n*-butyl ammonium bibenzoate (see Protocol 1) (0.05 g, 0.103 mmol) to the solution whilst maintaining a positive nitrogen pressure. Once the addition is complete, seal the flask with an appropriate rubber septum.
4. Stir the solution for approximately 2 min before adding freshly distilled methyl methacrylate (15 mL, 140 mmol) in a dropwise fashion via a cannula or a gas-tight syringe to the reactor flask at a rate of approximately 1 mL/min.
5. Monitor the exotherm using a contact thermometer (attach the contact thermometer to the side of the reactor)—typical temperatures reached vary between 45 and 60°C.
6. Once the reaction has cooled to room temperature, add methanol (ca. 5 mL) to the reaction mixture in order to terminate the polymerization.
7. Purify and recover the resultant polymer by precipitation using drop-wise addition of the THF solution into the vortex walls of a rapidly stirred ten-fold excess of cold methanol (ca. 500 mL). A brilliant white fine precipitate should

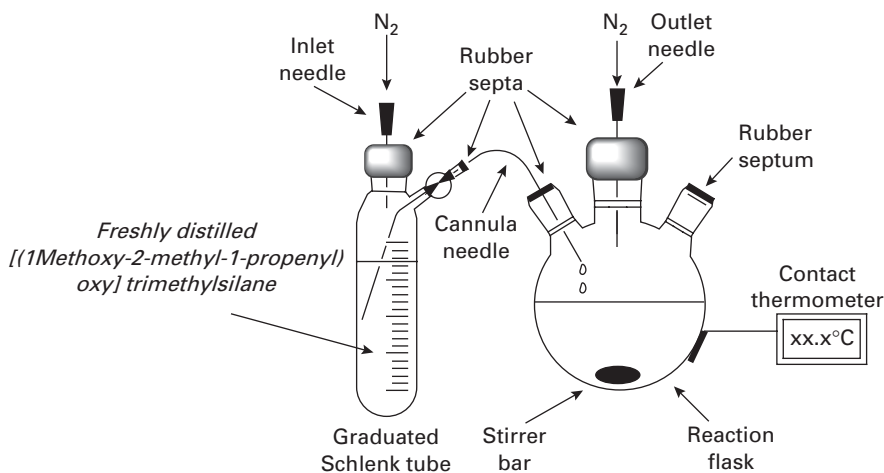

Fig. 3.2 Transfer of initiator/catalyst/solvent to reaction flask.

Protocol 2. Continued

be produced. Filter the polymer at the pump through a sintered-glass filter funnel, transfer the solid obtained to a large watch glass and dry it in a vacuum oven at 50°C for at least 4 h. Once a consistent weight is achieved, record the crude yield. Yields >95% are typical.

8. Transfer the crude polymer into a 100 mL beaker and dissolve it in chloroform (ca. 10–20 mL). Precipitate the polymer in the same manner as described in step 7 by drop-wise addition of the chloroform solution to a ten-fold excess of cold methanol. Filter the polymer at the pump through a sintered-glass filter funnel, transfer the solid obtained to a large watch glass and dry it in a vacuum oven at 50°C for at least 8 h. Once a constant weight is achieved, record the yield of the brilliant white powder.
9. Analyse the product using gel permeation chromatography (GPC) calibrated with a range of PMMA narrow standards to determine M_n and M_w/M_n .

^aThe group transfer initiator [(1-methoxy-2-methyl-1-propenyl)oxy]trimethylsilane is commercially available although it can be synthesized from methyl isobutyrate by following the procedure first described by Ainsworth *et al.*¹⁵ and the modification developed by Eastmond and Grigor.¹⁶ The initiator, either synthesized or purchased, should be distilled under vacuum into a 2 mL graduated Schlenk flask with 0.1 mL graduations and stored under nitrogen.

^bMethyl methacrylate should be passed through a basic alumina column directly into a Schlenk flask containing CaH₂ and stored in the fridge. Methyl methacrylate should be distilled with care, directly from the CaH₂ under high vacuum and used immediately.

^cTHF is distilled as follows: allow the solvent to stand over sodium wire until no further evolution of gas is observed. Transfer the pre-dried THF to a still containing sodium wire/benzophenone and bring the solvent to reflux under a stream of dry nitrogen until the deep purple colour of the sodium benzophenone ketyl persists—this indicates that the THF is anhydrous. Under a flow of dry nitrogen, collect the dry THF into a clean dry flask that contains sodium wire and then distill the required volume directly into the polymerization vessel under vacuum immediately prior to use.

Protocol 3.

Block copolymer synthesis using GTP: synthesis of poly(methyl methacrylate-*b*-*n*-butyl methacrylate) (Scheme 3)

Caution! Carry out all procedures in a well-ventilated fume-hood, wear appropriate disposable gloves, a lab-coat, and safety glasses. All vacuum-line work should be performed while standing behind a protective Perspex screen.

This procedure is carried out in exactly the same way as described in Protocol 2. However, in this approach, once complete conversion of the initial monomer feed has been attained (as determined by GPC analysis) a second monomer is added to the reactor flask. Since the polymerization exhibits ‘living’ characteristics, active polymer chain ends still exist in the monomer ‘starved’ flask and further addition of another monomer enables the polymerization to continue, therefore producing an AB block copolymer.

3: Controlled/‘living’ polymerization methods

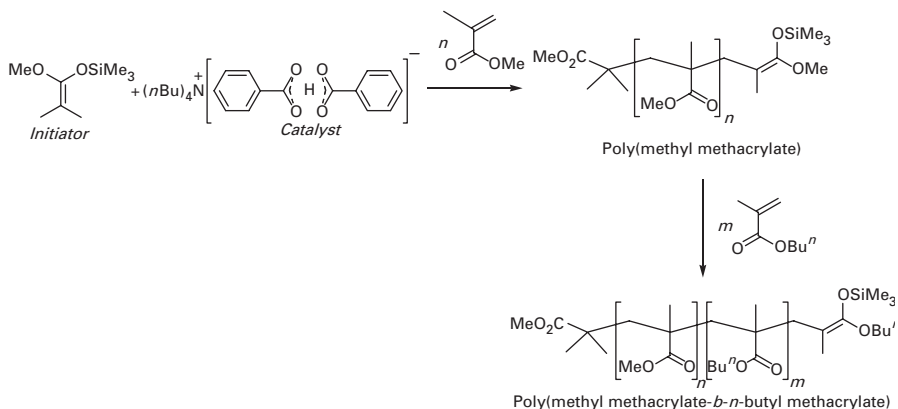

Scheme 3 Synthesis of poly(methyl methacrylate *b*-*n*-butyl methacrylate) using GTP.

Equipment

- Dual manifold (nitrogen/vacuum)
- Vacuum source
- Source of dry nitrogen
- Hotplate stirrer
- Teflon-coated magnetic stirrer bar
- Contact thermocouple
- 0.5 mL gas-tight syringe + 20 cm long narrow bore needle
- Cannula needle
- Three-necked, round-bottomed flask (250 mL)
- Rubber septa
- Beaker (500 mL)
- Buchner filter
- Buchner filter apparatus
- Filter paper (Whatman no. 1)

Materials

- (1-Methoxy-2-methyl-1-propenyl)oxytrimethylsilane,^a 0.15 mL, 0.734 mmol
 - Freshly distilled methyl methacrylate,^b 15 mL, 140 mmol
 - TBABB, 0.05 g, 0.103 mmol
 - Freshly distilled *n*-butyl methacrylate,^b 22.5 mL, 140 mmol
 - Freshly distilled THF,^c 150 mL
 - Methanol for precipitation, ca. 700 mL
 - Chloroform, ca. 20 mL
- irritant**
causes burns, may cause sensitization by inhalation and skin contact
irritant
causes burns, may cause sensitization by inhalation and skin contact
irritant, flammable
toxic, highly flammable may form explosive peroxides
carcinogen, harmful by inhalation

Method

1. Vacuum distil THF (50 mL) directly into a clean, dry three-necked, round-bottomed flask (250 mL)—the reaction flask. Purge the flask with dry nitrogen and allow the solvent to warm to room temperature. Remove a stopper and seal with an appropriate rubber septum.
2. Cannulate [(1-methoxy-2-methyl-1-propenyl)oxy]trimethylsilane (0.15 mL, 0.734 mmol) from a graduated 2 mL Schlenk flask using a transfer needle (or cannula) (using this technique it is possible to add the initiator to an accuracy of ± 0.05 mL) by applying pressure from the nitrogen supply as shown in Figure 3.2.

Protocol 3. Continued

3. Remove the septum and add TBABB (see Protocol 1) (0.05 g, 0.103 mmol) to the solution whilst maintaining a positive nitrogen pressure. Once the addition is complete, seal the flask with an appropriate rubber septum.
4. Stir the solution for approximately 2 min before adding freshly distilled methyl methacrylate (15 mL, 140 mmol) in a drop-wise fashion via a cannula or a gas-tight syringe to the reactor flask at a rate of approximately 1 mL/min.
5. Monitor the exotherm using a contact thermometer (attach the contact thermometer to the side of the reactor)—typical temperatures reached vary between 45 and 60°C.
6. Once the reaction has cooled to room temperature, remove an aliquot of the reaction mixture and add it to a small amount of methanol to terminate the polymerization of the aliquot. Analyse the aliquot by GPC to determine the success of the initial polymerization.
7. Add freshly distilled *n*-butyl methacrylate (22.5 mL, 140 mmol) in a drop-wise fashion via a cannula to the reactor flask.
8. Determine successful reinitiation by monitoring the exotherm of the second polymerization. When the reaction mixture has returned to room temperature add methanol (ca. 5 mL) in order to terminate the polymerization.
9. Purify and recover the resultant polymer by precipitation using drop-wise addition of the THF solution into the vortex walls of a rapidly stirred ten-fold excess of cold methanol (ca. 500 mL). A brilliant white fine precipitate should be produced. Filter the polymer at the pump through a sintered-glass filter funnel, transfer the solid obtained to a large watch glass and dry it in a vacuum oven at 50°C for at least 4 h. Once a consistent weight is achieved, record the crude yield. Yields >95% are typical.
10. Transfer the crude polymer into a 100 mL beaker and dissolve it in chloroform (ca. 10–20 mL). Precipitate the polymer in the same manner as described in step 9 by drop-wise addition of the chloroform solution to a ten-fold excess of cold methanol. Filter the polymer at the pump through a sintered-glass filter funnel, transfer the solid obtained to a large watch glass and dry it in a vacuum oven at 50°C for at least 8 h. Once a constant weight is achieved, record the yield of the brilliant white powder.
11. Analyse the product using GPC calibrated with a range of PMMA narrow standards to determine M_n and M_w/M_n and also compare the product M_n to the homopolymer aliquot removed after the first polymerization.

^aSee Protocol 2.

^bMethacrylate monomers should be passed through a basic alumina column directly into a Schlenk flask containing CaH₂ and stored in the fridge. The monomer should be directly distilled carefully from the CaH₂ under high vacuum and used immediately.

^cSee Protocol 2.

3. Controlled free-radical polymerizations mediated by nitroxides

The nature of free-radical polymerization has traditionally hindered attempts to produce an ideal 'living' free radical polymerization technique. It is very difficult to prevent chain transfer and termination reactions in free-radical polymerizations and although several methods have afforded polymers with very low polydispersities ($M_w/M_n < 1.1$), these approaches are often referred to as 'controlled' polymerizations rather than 'living' in the literature.

In the early 1980s, Moad *et al.*¹⁷ initially attempted to control free-radical polymerization using stable free radicals such as nitroxides. Following developmental work by Georges *et al.* at Xerox,¹⁸ the approach has led to the realization of a diverse range of polymer architectures^{19–21} that were previously unobtainable using traditional anionic or cationic polymerization techniques.

Polymerizations of this type involve interactions between two types of radical species: (i) transient and (ii) stable (or persistent). The stable radicals can combine with highly reactive transient radicals to form the so-called 'dormant' adducts as part of a dynamic equilibrium. In this dormant state, both radical species are effectively inactive and cannot participate in reactions with other reactive radicals. The dormant species, however, may be controllably dissociated to yield the transient and stable species. After dissociation, the transient radical at the end of the growing polymer chain reacts rapidly with vinyl monomers to form polymer chains. If the concentration of the stable radical species is high enough, the transient radical at the end of the growing chain reacts with the free stable radical to 'cap' the growing end of the polymer chain and reform the dormant species. The continued formation and capping of the transient species during polymerization, minimizes its concentration and, therefore, reduces the occurrence of termination reactions and produces 'living' conditions.

In contrast to the GTP polymerization methods described above, controlled free-radical polymerizations involving nitroxides typically employ a *unimolecular initiator*^{22,23} (as shown in Scheme 4) with the monomer without the need for a catalyst. The unimolecular initiator incorporates a latent nitroxide free radical that is more stable than the propagating polymer radical. The C–O bond between the nitroxide unit and the 'masked' initiating carbon centre is thermally labile (dissociation occurs at approximately 125°C). Therefore, polymerizations of this type are simply carried out by dissolving the initiator in the bulk monomer and heating the mixture to temperatures >125°C. The highly reactive vinylic radical liberated can thus participate in propagation with the monomer and the stable free nitroxide radical 'mediates' the polymerization by repetitive recombination and dissociation with the growing polymer chain. Consequently, a degree of control of the free-radical polymerization is achieved with defined molecular weight and narrow polydispersities ($M_w/M_n < 1.1$) of the polymers being obtained.

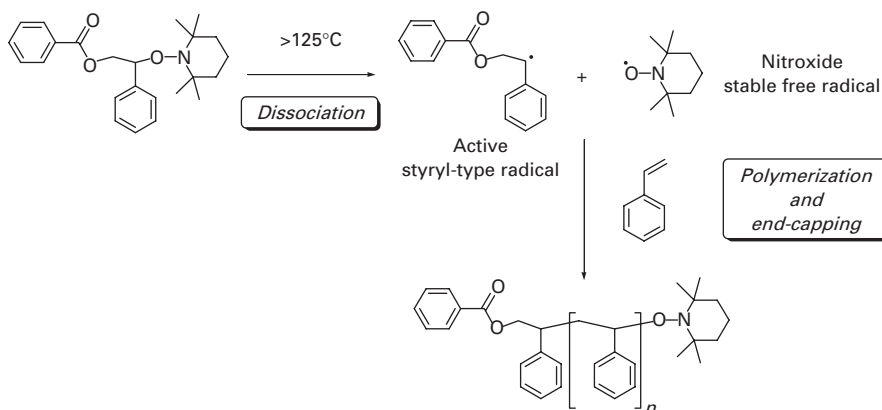

Scheme 4 Polymerization of styrene using a nitroxide-based unimolecular initiator.

Alternative bimolecular methods have been reported¹⁷ that involve mixing appropriate ratios of monomer with free-radical initiators (such as benzoyl peroxide) and an excess of the nitroxide stable free-radical moiety. Such bimolecular methods do not afford the same degree of control of molecular weight and polydispersity since the stoichiometry of the mediating system cannot be accurately defined, which is a crucial factor in these controlled polymerization systems. A wide variety of unimolecular nitroxide based initiator systems have been described in the literature with those based upon the 2,2,6,6-tetramethylpiperidinyl-1-oxy (TEMPO) group proving to be the most commonly used.

While possessing many of the key advantages of controlled/‘living’ polymerization methods, nitroxide-mediated free-radical polymerizations do exhibit several limitations. The range of monomers that have been polymerized using nitroxide-mediated techniques include styrenics, acrylamides and (meth)acrylates but these have predominantly been reported in bulk polymerizations (i.e. without solvent) and are conducted at elevated temperature for long time periods. In addition, synthesis of the unimolecular initiator can prove troublesome (dependent upon the type required) and often requires extensive purification in order to attain sufficient purity levels to allow molecular weight control.

Protocol 4. **Synthesis of nitroxide unimolecular initiator using benzoyl peroxide (Scheme 5)**

This method for the preparation of a TEMPO-based unimolecular initiating system is based upon the procedure described by Hawker and co-workers.²²

3: Controlled/'living' polymerization methods

Caution! Carry out all procedures in a well-ventilated fume-hood, wear appropriate disposable gloves, a lab-coat, and safety glasses. All vacuum-line work should be performed while standing behind a protective Perspex screen.

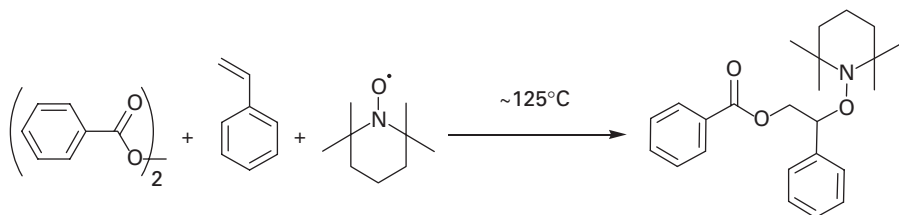

Scheme 5 Synthesis of nitroxide unimolecular initiator using benzoyl peroxide.

Equipment

- Dual manifold (nitrogen/vacuum)
- Source of dry nitrogen
- Three-necked, round-bottomed flask (100 mL)
- Rubber septa
- Teflon-coated magnetic stirrer bar
- Hotplate stirrer
- Contact thermocouple
- 25 mL gas-tight syringe + 20 cm long narrow bore needle
- Single-necked round-bottomed flask (2 × 250 mL)
- Chromatographic column (ca. 30 cm long, ca. 50 mm i.d.)
- Scintillation vials (50 × 20 mL)
- Oil-bath

Materials

- Benzoyl peroxide, 1.14 g, 4.25 mmol
 - TEMPO, 1.48 g, 9.5 mmol
 - Freshly distilled styrene,^a 50 mL, 0.436 mol
 - Dichloromethane, ca. 500 mL
 - Hexane, ca. 250 mL
 - Silica, ca. 150 g
- risk of explosion by shock, friction, fire, or other ignition sources, may cause fire, irritating to eyes, may cause sensitization by skin contact causes burns, harmful by inhalation flammable, harmful by inhalation, irritating to eyes and skin carcinogen, harmful by inhalation highly flammable, irritating to the skin, vapours may cause drowsiness and dizziness, harmful to lungs, possible risk of impaired fertility, toxic harmful by inhalation, irritating to respiratory system**

Method

1. Into a dry three-necked, round-bottomed flask (100 mL) that is equipped with a condenser add freshly distilled styrene^a (50 mL, 0.436 mol) directly via a gas-tight syringe through the side-arm of the flask and then flush the flask with nitrogen.
2. While maintaining the reaction flask under a positive pressure of nitrogen, add TEMPO (1.48 g, 9.5 mmol) to the styrene.
3. *Note: Care required in this step!* While maintaining the reaction flask under a positive pressure of nitrogen, add benzoyl peroxide (1.14 g, 4.25 mmol) to the styrenic solution. Once the addition is complete, seal the flask with an appropriate rubber septum.

Protocol 4. *Continued*

4. Place the reaction flask in an oil-bath that is maintained at a temperature of 90°C and heat the mixture under a steady flow of nitrogen for a period of ca. 20 h. Use a contact thermometer to maintain the temperature setting.
5. Allow the reaction mixture to cool to room temperature.
6. Transfer the reaction mixture into a single-necked round-bottomed flask (250 mL).
7. Vacuum distil the reaction mixture to remove the excess styrene.
8. Dissolve the crude mixture in the minimum volume of 1:1 hexane/dichloromethane.
9. Apply the concentrated solution to the head of a packed chromatographic column^b (packed with silica gel) using a Pasteur pipette.
10. Initially elute the column with 1:1 hexane/dichloromethane, once the styrene has eluted, gradually increase the polarity of the mobile phase to dichloromethane.
11. Combine the fractions corresponding to the desired nitroxide unimolecular initiator and transfer the solution into a single-necked round-bottomed flask (250 mL).
12. Using a rotary evaporator, concentrate the solution until a clear oil (often yellowish in appearance) is produced. Yields ca. 40% are typical.

^aStyrene should be washed with 10% NaOH (aq.), dried over Na₂SO₄ and then filtered at the pump in order to remove any stabilizer. The resultant pre-dried styrene should then be directly distilled carefully under high vacuum and used immediately.

^bGuidelines to column chromatography: prior to purifying the crude product, always optimize the chromatographic conditions using thin layer chromatography (TLC).

Calculate how much of the stationary phase (alumina or silica) is required by assessing the optimum TLC separation. Measure the difference in R_f between the required product and the by-products. A general guide: if the R_f difference is approximately 0.2, 40 g of silica/alumina per gram of crude product is required; if the R_f difference is >0.4, 20 g of alumina/silica per gram of crude product is required. Weigh out the required amount of alumina/silica (in a fume-hood) and to it add the solvent to be used as the initial eluent in order to prepare a slurry. This process will generate heat and before the slurry so produced can be packed into the empty column it must be allowed to cool. Gently stir the slurry to remove the gas bubbles.

Into the base of the clean empty chromatographic column, place a plug of cotton wool (not too tightly packed) and pour onto a small amount of sand. The cotton wool plug is used to prevent the stationary phase pouring out of the column. Tap the column carefully so that the sand is level. Some columns have a porous glass frit located at the bottom of the column prior the tap, in these cases, it is not necessary to pour in sand or use a cotton wool plug.

Slowly pour the slurry into the column, ensuring that a minimum number of air bubbles are created. Open the tap of the column and allow the solvent in the slurry to steadily run into a suitably sized collection vessel (beaker/conical flask). Gently tap the sides of the column with a piece of thick rubber tubing to free any air bubbles that persist in the packed column and to ensure that the stationary phase is compacted into a uniform packed bed. It may be necessary to repeat the above procedure in order to pack all of the stationary phase that is required for the desired separation. If this is the case, allow the solvent in the slurry to run to approximately 1 cm above the level of the settling stationary phase. Turn the tap of the column to stop the flow of the solvent. Gently pour in the second batch of slurry and reopen the tap. Repeat the above process until all the stationary phase is loaded into the column.

Note: If any of the stationary phase pours into the collection vessel, then the column will need to be dismantled and reconstructed.

3: Controlled/'living' polymerization methods

Once all the stationary phase has been loaded into the column and has settled such that the bed is compact, level, and stable (mark the side of the column with a marker pen to record the level of the stationary phase as it settles), pour a small amount of sand carefully onto the head of the stationary phase. This is used to prevent disruption of the top few centimetres of the stationary phase when fresh mobile phase solvents are added to the column.

The column can now be used to purify the crude product. Allow the solvent level in the column to drop to just above (ca. 1 mm) the level of the stationary phase. Apply the crude mixture as a concentrated solution in a solvent system that is less polar than the solvent system to be used as the initial column mobile phase. Allow the level of the crude product solution to drop to the top of the stationary phase, but do not allow the column to become dry.

Carefully pour in the first aliquot of mobile phase and allow that to run at a steady rate through the column. Once the flow of solvent has started through the column, the separation must *not* be stopped

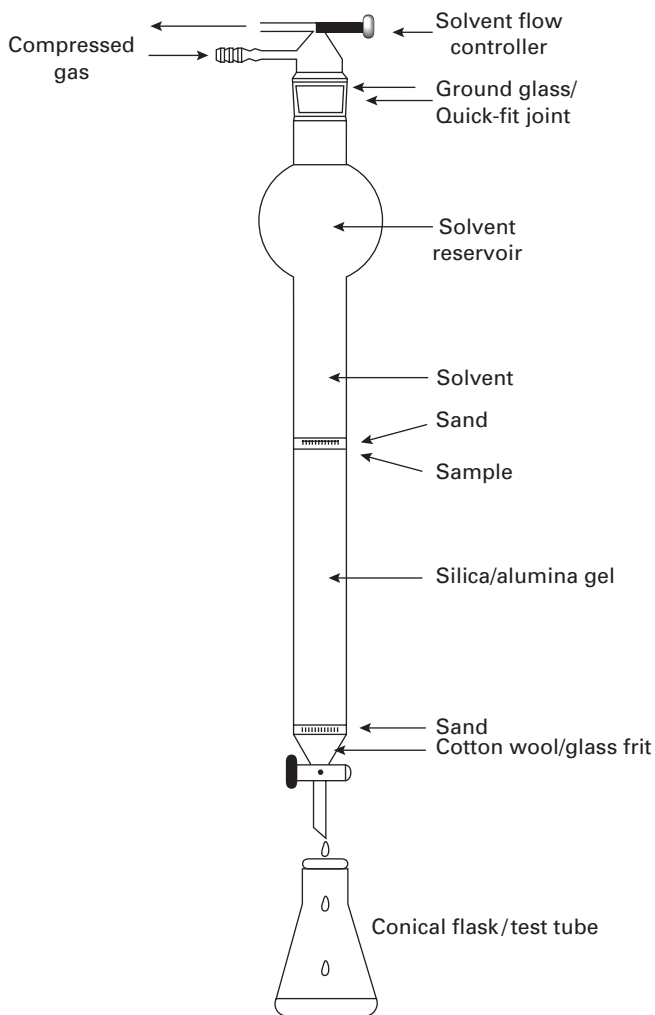

Fig. 3.3 Experimental set-up for flash column chromatography.

Protocol 4. Continued

until all of the required products have been eluted. *Never* allow the column to run dry. Collect regular-sized fractions (use scintillation vials ca. 20 mL) and use TLC analysis to monitor the components eluting from the column.

For *Flash* column chromatography, the column preparation is analogous to that described above, however, the stationary phase material is of finer grade and requires pressure in order to force the solvent through the column (Figure 3.3).

Protocol 5.

Bulk polymerization of styrene using a TEMPO-based unimolecular initiator (Scheme 4)

Caution! Carry out all procedures in a well-ventilated fume-hood, wear appropriate disposable gloves, a lab-coat, and safety glasses. All vacuum-line work should be performed while standing behind a protective Perspex screen.

Polystyrene possessing a degree of polymerization of 192 monomer units and $M_n \approx 20\,300$ has been targeted in the following procedure described by Hawker and co-workers.²²

Equipment

- Dual manifold (nitrogen/vacuum)
- Vacuum source
- Source of dry nitrogen
- Hotplate stirrer
- Teflon-coated magnetic stirrer bar
- Contact thermocouple
- 0.5 mL gas-tight syringe + 20 cm long narrow bore needle
- Schlenk flask (10 mL)
- Three-way tap, gas-tight and equipped with ground-glass joint
- Rubber septa
- Beaker (1500 mL)
- Buchner filter
- Buchner filter apparatus
- Filter paper (Whatman no. 1)
- Oil-bath

Materials

- Freshly distilled styrene,^a 5.21 g, 50 mmol
 - TEMPO-based unimolecular initiator, 0.099 g, 0.26 mmol
 - THF for precipitation, ca. 20 mL
 - Methanol for precipitation, 2 × ca. 500 mL
- flammable, harmful by inhalation,
irritating to eyes and skin
treat as toxic
irritant, highly flammable may form
explosive peroxides
irritant, flammable**

Method

1. To a clean, dry Schlenk flask (10 mL) that is maintained under positive nitrogen pressure via the side-arm (that is equipped with an appropriate rubber septum) (Figure 3.4), add the TEMPO-based unimolecular initiator (0.099 g, 0.26 mmol).
2. Seal the Schlenk flask by attaching the three-way tap that is equipped with a ground-glass joint. Use either high-quality vacuum grease or preferably, Teflon tape to create a vapour-tight seal on the flask. Redirect the nitrogen

3: Controlled/‘living’ polymerization methods

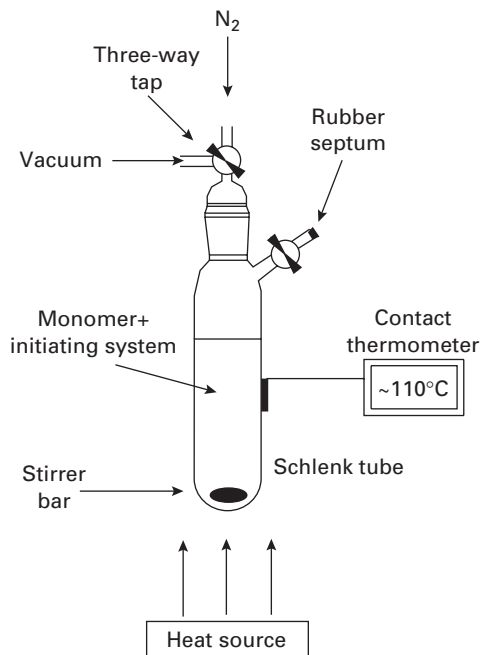

Fig. 3.4 Experimental apparatus for bulk polymerization of styrene using TEMPO-based unimolecular initiators.

purge by connecting the nitrogen inlet to the three-way tap and opening the vent on the side-arm of the Schlenk tube.

3. To the above mixture, add freshly distilled styrene (5.21 g, 50 mmol) directly via a gas-tight syringe through the side-arm of the Schlenk tube. Once the addition is complete, seal the flask by closing the side-arm tap.
4. Degas the mixture by using repetitive freeze–pump–thaw cycles^b (repeat the cycle at least three times).
5. Seal the tube under a nitrogen atmosphere and then place it in an oil-bath that is maintained at a temperature of 123°C. Upon immersion in the hot oil-bath, the polymerization mixture will become homogeneous and will develop a yellowish-red colour.
6. The polymerization mixture will eventually solidify and at this point (typically >24 h) the Schlenk flask should be removed from the hot oil-bath and allowed to cool to room temperature.
7. Dissolve the solid in the minimum volume of THF (~10 mL).
8. Precipitate the polystyrene by dropping the concentrated THF solution using Pasteur pipette into the vortex walls of a rapidly stirred ten-fold excess of cold methanol (ca. 500 mL). Contain the methanol in a large beaker (1500 mL) to carry out this operation. A fine white precipitate should result.^c

Protocol 5. Continued

9. Filter the suspension and dry the white powder obtained in a vacuum oven (set to 50°C). Following drying, record the mass of polystyrene obtained.
10. Dissolve the polystyrene obtained in THF so as to obtain a viscous solution and then repeat steps 8 and 9.
11. Analyse the product using GPC calibrated with a range of polystyrene narrow standards to determine M_n and M_w/M_n .

^aSee Protocol 4.

^bFreeze–pump–thaw degassing is carried out as follows: (i) Ensure that the Schlenk flask has been thoroughly purged with nitrogen. (ii) Freeze the solution by immersing the Schlenk flask in a bath of liquid nitrogen (care required when handling liquefied gases) that is contained in a nitrogen Dewar. (iii) Once the solution is completely frozen, keep the flask submerged in the liquid nitrogen and then apply high vacuum to it by rotating the three-way tap to the appropriate position. After a short period (typically 1 min), seal the Schlenk flask by again rotating the three-way tap to the appropriate position. (iv) Remove the flask from the liquid nitrogen bath. Allow the contents of the flask to warm up to room temperature and the solution will melt (as this occurs, small gas bubbles will appear and dissipate into the void above the surface of the solution). (v) Increase the nitrogen gas pressure (so as to avoid suck back) and then backfill the Schlenk tube with nitrogen by slowly rotating the three-way tap to the appropriate position. Repeat steps 2–5 at least three times.

^cIf an opaque white solution is obtained, the crude polystyrene solution is too dilute. Remove more THF from this solution using rotary evaporation and then re-continue the precipitation. Alternatively, if white ‘string-like’ material results from the initial addition of the polymer solution to the methanol, then the crude polystyrene solution is too concentrated and will require dilution by the addition of THF. At the end of the addition of the crude polymer solution to the methanol, if a fine white dispersion that can be readily filtered has not been obtained, then simply remove all of the solvent by rotary evaporation and repeat the process, in this case adjusting the concentration of the crude polymer solution and the volume of methanol used.

4. Controlled free-radical polymerizations: atom transfer free-radical polymerizations (ATRP) and aqueous ATRP

Atom transfer free-radical polymerization²⁴ (ATRP) proceeds by a transient/stable radical mechanism analogous to nitroxide-mediated free-radical polymerizations (see Section 3). This controlled polymerization concept was first described^{25,26} independently by two research groups in 1995, and exhibits a high degree of control over the molecular weight of the desired polymer and more remarkably, the ability to realize very narrow molecular weight distributions ($M_w/M_n < 1.05$). ATRP methodologies involve (see Scheme 6) the one-electron oxidation of a transition metal (‘ ML_n ’ where ‘L’ is a ligand) with concomitant abstraction of a halide atom from a stable organic halide (the *dormant* species ‘RX’) to lead to the generation of a highly reactive organic radical (the *transient* species ‘R’). This organic radical can freely propagate in the presence of monomer. Subsequent reductive abstraction of the halide from the metal by the transient (propagating) radical ‘ P_{m+x}^* ’ leads to the generation of a dormant polymer ‘ $P_{m+x}X$ ’.

3: Controlled/'living' polymerization methods

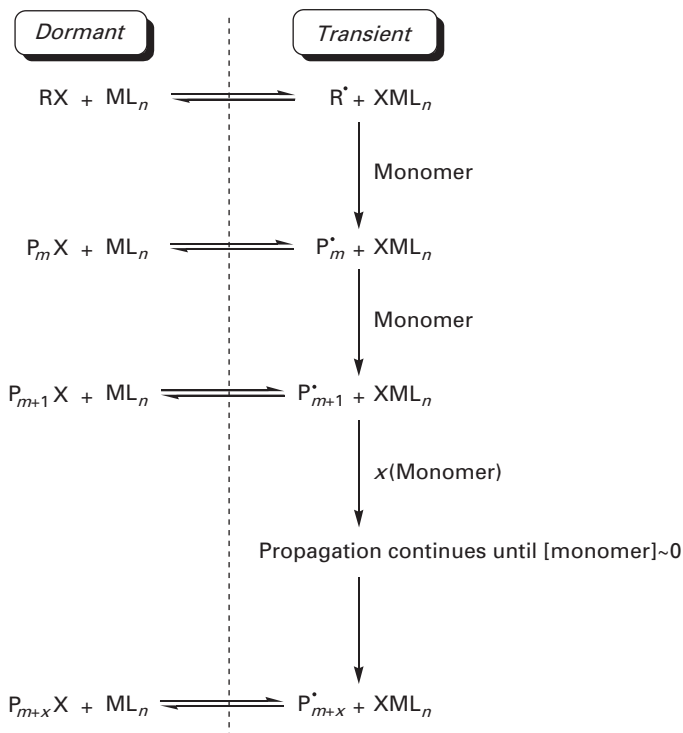

Scheme 6 Simplified general mechanism for ATRP.

A wide variety of transition metals have been studied and, in addition, numerous ligand systems have also been investigated.²⁴ Of those studied, the copper(I)/copper(II) redox couple has proved to be the most popular transition metal in combination with either 2,2'-bipyridine or 2-pyridinecarbaldehyde imine²⁷ ligand systems. ATRP has been shown to be a very versatile controlled polymerization system and compatible with a diverse set of monomers (styrene, methyl methacrylate, acrylates etc). The methodology has recently been adapted to allow the controlled room temperature polymerization of hydrophilic monomers in aqueous solvent,²⁸⁻³¹ thus becoming the first 'living' polymerization to tolerate large amounts of water and allow a wide range of water-soluble block copolymer syntheses. In addition, ATRP has also enabled the synthesis of a wide range of hydrophilic and hydrophobic polymer architectures that could not be realized via more conventional polymerization techniques.^{32,33}

Protocol 6.**Bulk polymerization of styrene using ATRP**

Caution! Carry out all procedures in a well-ventilated fume-hood, wear appropriate disposable gloves, a lab-coat, and safety glasses. All vacuum-line work should be performed while standing behind a protective Perspex screen.

Polystyrene possessing a degree of polymerization of 95 monomer units and $M_n \approx 10\,000$ has been targeted in the following bulk polymerization procedure reported by Matyjaszewski and co-workers^{24,26} (Scheme 7).

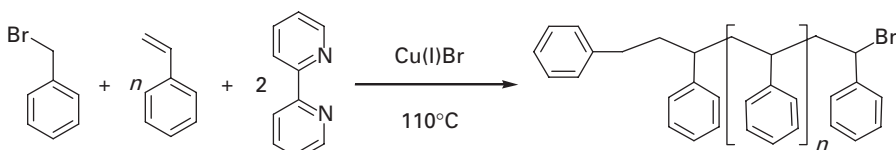

Scheme 7 Polymerization of styrene using ATRP.

Equipment

- Dual manifold (nitrogen/vacuum)
- Vacuum source
- Source of dry nitrogen
- Hotplate stirrer
- Contact thermocouple
- Teflon-coated magnetic stirrer bar
- Schlenk flask (10 mL) equipped with side-arm and gas-tight tap
- Three-way tap, gas-tight and equipped with ground-glass joint
- Small rubber septa
- 0.5 mL gas-tight syringe + 20 cm long narrow bore needle
- Short chromatographic column (ca. 15 cm long, ca. 20 mm i.d.)
- Scintillation vials (50 × 20 mL)
- Beaker (2 × 1500 mL)
- Single-necked round-bottomed flask (250 mL)
- Buchner filter
- Buchner filter apparatus
- Filter paper (Whatman no. 1)
- Oil-bath

Note: Use the same experimental set-up as described in Protocol 5.

Materials

- Freshly distilled styrene,^a 6.01 g, 57.7 mmol
 - Copper(I) bromide, 0.088 g, 0.61 mmol
 - Benzyl bromide, 0.103 g, 0.60 mmol
 - 2,2'-Bipyridine, 0.196 g, 1.26 mmol
 - THF for precipitation and alumina column, ca. 250 mL
 - Neutral alumina, ca. 15 g
 - Methanol for precipitation, 2 × ca. 500 mL
- flammable, harmful by inhalation, irritating to eyes and skin**
irritating to eyes, respiratory system, and skin
irritating to eyes, respiratory system, and skin
toxic by inhalation, in contact with skin, and if swallowed, irritating to eyes, respiratory system, and skin
irritant, highly flammable may form explosive peroxides
harmful by inhalation, irritating to respiratory system
irritant, flammable

Method

1. To a clean, dry Schlenk flask (10 mL) that is maintained under positive nitrogen pressure via the side-arm, add copper(I) bromide (0.088 g, 0.734 mmol),

3: Controlled/'living' polymerization methods

2,2'-bipyridine (0.196 g, 0.734 mmol) and benzyl bromide (0.103 g, 0.734 mmol).

2. Seal the Schlenk flask by attaching the three-way tap that is equipped with a ground-glass joint. Use either high-quality vacuum grease or preferably, Teflon tape to create a vapour-tight seal on the flask. Redirect the nitrogen purge by connecting the nitrogen inlet to the three-way tap and opening the vent on the side-arm of the Schlenk tube.
3. To the above mixture, add freshly distilled styrene (6.01 g, 57.7 mmol) directly via a gas-tight syringe through the side-arm of the Schlenk tube. Once the addition is complete, seal the flask by closing the side-arm tap and equip it with an appropriate rubber septum.
4. Degas the mixture by using repetitive freeze–pump–thaw cycles^b (repeat the cycle at least three times).
5. Seal the tube under a nitrogen atmosphere and then place it in an oil-bath that is maintained at a temperature of 110°C. Upon immersion in the hot oil-bath, the polymerization mixture will become homogeneous and will develop a deep red/brown colour.
6. The polymerization mixture will eventually solidify and at this point (typically 18–24 h) the Schlenk flask should be removed from the hot oil-bath and allowed to cool to room temperature.
7. Dissolve the solid in the minimum volume of THF (ca. 3–5 mL) and apply this concentrated solution to a short alumina column^c (ca. 15 cm long, ~20 mm i.d. containing approximately 10 g alumina packed in THF). Pass THF through the column and collect an appropriate number of fractions (ca. 5 mL fractions) until all of the polystyrene has eluted (using a short glass capillary, place approximately 1 μ L of each fraction onto a small silica TLC plate and visualize the plate under a UV lamp—if polystyrene is present, a dark blue spot will be apparent).
8. Transfer all of the THF fractions that contain the polystyrene into a single-necked round-bottomed flask (ca. 100 mL) and concentrate the solution using a rotary evaporator until the viscosity of the solution increases (the volume of the solution will be ca. 10 mL).
9. Precipitate the polystyrene by dropping the concentrated THF solution using Pasteur pipette into the vortex walls of a rapidly stirred ten-fold excess of cold methanol (ca. 500 mL). Contain the methanol in a large beaker (1500 mL) to carry out this operation. A fine white precipitate should result.^d
10. Filter the suspension and dry the white powder obtained in a vacuum oven (set to 50°C). Following drying, record the mass of polystyrene obtained.
11. Dissolve the polystyrene obtained in THF so as to obtain a viscous solution and then repeat steps 9 and 10.
12. Once a constant weight is achieved, record the yield of the brilliant white powder.

Protocol 6. Continued

13. Analyse the product using GPC calibrated with a range of polystyrene narrow standards to determine M_n and M_w/M_n .

^aSee Protocol 4.

^bSee Protocol 5.

^cSee Protocol 4.

^dSee Protocol 5.

Protocol 7.

Synthesis of the 2-bromoisobutyrate ester of poly(ethylene oxide) (PEG-Br): an aqueous ATRP initiator

This method for the preparation of the PEG-Br initiator is based upon the procedure described by Wang and Armes³⁴ (Scheme 8).

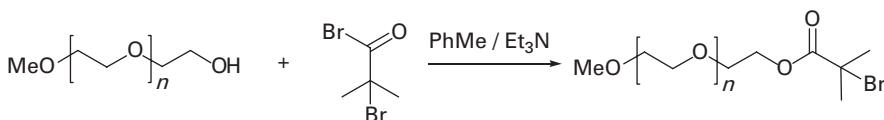

Scheme 8 Preparation of the PEG-Br.

Caution! Carry out all procedures in a well-ventilated fume-cupboard, wear appropriate disposable gloves, a lab-coat, and safety glasses. All vacuum-line work should be performed while standing behind a protective Perspex screen. Never use flat-bottomed flasks with rotary evaporators.

Equipment

- Dean–Stark apparatus
- Vacuum source
- Three-necked round-bottomed flask (500 mL)
- Hotplate stirrer
- Teflon-coated magnetic stirrer bar
- Pressure-equalizing addition funnel (10 mL)
- Dry nitrogen source
- Rubber septa
- Glass stoppers
- Beaker (500 mL)
- 5 mL gas-tight syringe + 10 cm narrow bore needle
- Filter paper (Whatman no. 1)
- Buchner filter apparatus
- Buchner funnel
- Water condensor
- Oil-bath

Materials

- Monomethoxy-capped poly(ethylene glycol) $M_n = 1100$, 20.0 g, 18.3 mmol
 - Triethylamine, 4.7 mL, 36.7 mmol
 - 2-Bromoisobutyryl bromide
 - Toluene, 250 mL
 - Diethyl ether for precipitation, 2 × 250 mL
- irritant, harmful if swallowed and by inhalation**
flammable, irritant, harmful by inhalation
corrosive, irritant, harmful by inhalation
irritant, flammable
irritant, highly flammable

Method

1. Add monomethoxy-capped poly(ethyleneglycol) ($M_n = 1100$, 20.0 g, 18.3 mmol) to a clean, dry three-necked flask (500 mL) under a positive pressure of dry

3: Controlled/'living' polymerization methods

- nitrogen. Transfer toluene (250 mL) to the flask and add the stirrer bar. Fit the Dean and Stark apparatus and condenser to the flask and stopper the remaining necks. Heat the mixture gently until a homogeneous solution has been formed.
2. Increase the temperature of the oil-bath until the solution begins to reflux. Collect the initial fraction in the Dean–Stark apparatus. This is the water/toluene azeotrope and removal of this fraction will ensure a dry toluene solution of poly(ethylene glycol). Allow the solution to cool.
 3. Whilst maintaining a positive pressure of dry nitrogen, remove the Dean–Stark apparatus and refit the condenser and nitrogen supply to the flask. Replace one stopper with a rubber septum and fit a pressure-equalizing addition funnel (10 mL) to the other neck of the flask.
 4. Using a gas-tight syringe (5 mL), add triethylamine (4.7 mL, 36.7 mmol) to the room temperature solution and stir. Add 2-bromoisobutyryl bromide (4.54 mL, 36.7 mmol) to the addition funnel. Add the 2-bromoisobutyryl bromide to the reaction dropwise, over 15 min, so that any exotherm is controlled. Stir the reaction at room temperature for a further 48 h whilst maintaining a positive pressure of dry nitrogen.
 5. Filter the white precipitate using a Buchner filtration apparatus and discard the precipitate. Concentrate the remaining clear solution to approximately 50 mL using a rotary evaporator. Precipitate the product from the concentrate by drop-wise addition into the vortex walls of rapidly stirred cold diethyl ether (250 mL). Filter the white precipitate from the solvent using a Buchner filtration apparatus. Dissolve the precipitate in toluene (50 mL) and repeat the precipitation process. Filter the white precipitate again and dry under vacuum to remove all traces of solvent. The final product should be stored under dry nitrogen in the dark. Yields >90% are usual.
 6. Analyse the PEG-Br product using ^1H NMR, ^{13}C NMR, and FT-IR spectroscopies and MALDI-TOF mass spectrometry.³⁵
-

Protocol 8.

Polymerization of oligo(ethylene glycol) methacrylate using aqueous ATRP

This method for aqueous ATRP is based upon the procedure described by Wang and Armes³⁴ (Scheme 9).

Caution! Carry out all procedures in a well-ventilated fume-cupboard, wear appropriate disposable gloves, a lab-coat, and safety glasses. All vacuum-line work should be performed while standing behind a protective Perspex screen.

Poly(oligoethylene glycol methacrylate) possessing a degree of polymerization of 20 repeat units and a molecular weight $M_n \approx 9000$ has been targeted in the following polymerization procedure.

Protocol 8. *Continued*

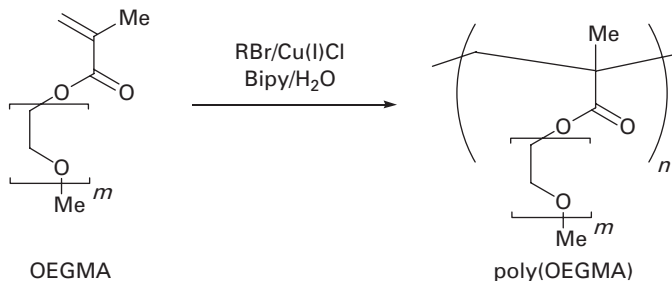

Scheme 9 Polymerization of oligo(ethylene glycol) methacrylate using aqueous ATRP (RBr = PEG-Br).

Equipment

- Two-necked round-bottomed flask (100 mL)
- Hotplate stirrer
- Dry nitrogen source
- 10 cm narrow bore needle
- Buchner filter apparatus
- Glass stopper
- Sintered-glass filter funnel (porosity 2)
- Teflon-coated magnetic stirrer bar
- Rubber septa
- 2 cm narrow bore needle
- 5 mL sample vial
- Vacuum source

Materials

- Oligo(ethylene glycol) methacrylate [average degree of polymerization = 7], 10 g, 23.8 mmol
- PEG-Br,^a 0.5 g, 1.20 mmol
- Copper(I) Bromide, 0.172 g, 1.20 mmol
- 2,2'-bipyridine, 0.375 g, 2.40 mmol
- Deionized water, 5 mL
- Silica

**harmful, irritating to eyes and skin,
possible sensitizer
treat as toxic
irritating to eyes, respiratory system, and skin
harmful, irritating to eyes and skin, harmful
non-toxic
irritating to the respiratory system**

Method

1. Add deionized water (5 mL), PEG-Br initiator^a (0.5 g, 1.20 mmol), oligo(ethylene glycol) methacrylate (10 g, 23.8 mmol) and magnetic stirrer bar to a 100 mL two-necked round-bottomed flask. Fit a rubber septum to each neck. Place the small needle into one septum to act as a vent.
2. Attach the 10 cm needle to the end of a rubber tube joined to a dry nitrogen source. Place the needle into the second septum and bubble dry nitrogen through the solution for 30 min to remove all oxygen.
3. After degassing the solution, remove the needle from the solution but do not remove from the septum. Remove the small vent needle from the first septum.
4. Fill a sample vial (5 mL) with dry nitrogen and replace the cap. Weigh the Cu(I)Br (0.172 g, 1.20 mmol) and 2,2'-bipyridine (0.375 g, 2.40 mmol) into the nitrogen-filled sample vial and replace cap.
5. Remove the first septum from the reaction flask while maintaining a positive pressure of dry nitrogen through the second septum. Empty the contents of the sample vial (Cu(I)Br/2,2'-bipyridine) into the flask, stopper the open neck

3: Controlled/'living' polymerization methods

with a glass stopper, and stir at room temperature for 1 h under the dry nitrogen pressure.

6. The reaction mixture will become dark brown indicating the predominant presence of the Cu(II) species. An exotherm (5–10°C) may be noted. (Kinetic data have shown that >99% conversion of monomer is achieved within 25 min.)
7. Add the sintered-glass funnel to the Buchner filter system and attach the vacuum source. Fill the funnel to a depth of 2 cm using anhydrous silica. Filter the aqueous polymer solution through the silica. A blue colour will appear, indicating the Cu(II) species that is formed in the presence of oxygen. The solution of polymer must be freeze-dried overnight to remove all water and leave a white solid polymer product. Yields >90% are typical.
8. Analyse the polymer using GPC (THF using PMMA standards), ¹H NMR, ¹³C NMR, and IR spectroscopies.

^aSee Protocol 7.

The controlled polymerization techniques that have been described above do not, in general (with the exception of GTP), require exhaustive exclusion of moisture and purification of monomers and reagents. Several of the 'living' polymerization methods reported so far do suffer these experimental restrictions and, thus, uptake of these techniques by the polymer community has been limited. There are several notable examples of 'living' polymerizations that merit recognition, including anionic methods,³⁶ cationic polymerizations,³⁷ 'immortal' polymerizations mediated by metalloporphyrin reagents,³⁸ reversible addition fragmentation chain transfer (RAFT)³⁹ techniques and ring-opening metathesis polymerizations (ROMP).⁴⁰ Each of these 'living' polymerization methods has its own beneficial attributes and monomer compatibility characteristics and, therefore, careful consideration must be taken when selecting a 'living' polymerization process.

References

1. For an excellent description of the mechanism of chain-growth polymerization, see: Odian, G. In *Principles of Polymerization*, 3rd edn., Wiley-Interscience: New York; **1991**, Ch. 3.
2. (a) Szwarc, M.; Levy, M.; Milkovich, R. *J. Am. Chem. Soc.* **1956**, *78*, 2656.
(b) Szwarc, M. *J. Polym. Sci., Part A: Polym. Chem.* **1998**, *36*, ix.
3. Flory, P. J. *Principles of Polymer Chemistry*; Cornell University Press: New York; **1953**.
4. Quirk, R. P.; Lee, B. *Polym. Int.* **1992**, *27*, 359.
5. Webster, O. W. *Science* **1991**, *251*, 887.
6. Sorenson, W. R.; Campbell, T. W. *Preparative Methods of Polymer Chemistry*, 2nd edn., Wiley-Interscience: New York; **1968**, Ch. 4.

7. Webster, O. W.; Hertler, W. R.; Sogah, D. Y.; Farnham, W. B.; Rajanbabu, T. V. *J. Am. Chem. Soc.* **1983**, *105*, 5706.
8. Sogah, D. Y.; Farnham, W. B. In *Organosilicon and Bioorganosilicon Chemistry: Structure, Bonding, Reactivity and Synthetic Applications*; Sakurai, H., ed., John Wiley & Sons: New York; **1985**, Ch. 20.
9. Farnham, W. B.; Sogah, D. Y. *ACS Polym. Prepr.* **1982**, *27*(1), 167.
10. Quirk, R. P.; Bidinger, G. *Polym. Bull.* **1989**, *22*, 63.
11. Webster, O. W. *Makromol. Chem. Macromol. Symp.* **1992**, *60*, 287.
12. Jenkins, A. D. *Eur. Polym. J.* **1993**, *29*(2/3), 449.
13. Dicker, I. B.; Farnham, W. B.; Hertler, W. R.; Laganis, E. D.; Sogah, D. Y.; Del Pesco, T. W.; Fitzgerald, P. H. *US Patent No.* 4588795 **1986**.
14. Dicker, I. B.; Cohen, G. M.; Farnham, W. B.; Hertler, W. R.; Laganis, E. D.; Sogah, D. Y. *Macromolecules* **1990**, *23*, 4034.
15. Ainsworth, C.; Chen, F.; Kuo, Y. H. *J. Organomet. Chem.* **1972**, *46*, 59.
16. Eastmond, G. C.; Grigor, J. *Makromol. Chem. Rapid Commun.* **1986**, *7*, 37.
17. Moad, G.; Rizzardo, E.; Solomon, D. H. *Macromolecules*, **1982**, *15*, 909.
18. Georges, M. K.; Veregrin, R. P. N.; Kazmaier, P. M.; Hamer, G. K. *Macromolecules* **1993**, *26*, 2987.
19. Hawker, C. J. *Acc. Chem. Res.* **1997**, *30*, 373.
20. Malmström, E. E.; Hawker, C. J. *Macromol. Chem. Phys.* **1998**, *199*, 923.
21. Emrick, T.; Hayes, W.; Fréchet, J. M. J. *J. Polym. Sci., Part A: Polym. Chem.* **1999**, *37*, 3748.
22. Hawker, C. J.; Barclay, G. C.; Dao, J. *J. Am. Chem. Soc.* **1996**, *118*, 11467.
23. Dao, J.; Benoit, D.; Hawker, C. J. *J. Polym. Sci., Part A: Polym. Chem.* **1998**, *36*, 2161.
24. Patten, T. E.; Matyjaszewski, K. *Acc. Chem. Res.* **1999**, *32*, 895.
25. Kato, M.; Kamigaito, M.; Sawamoto, M.; Higashimura, T. *Macromolecules* **1995**, *28*, 1721.
26. Wang, J. S.; Matyjaszewski, K. *J. Am. Chem. Soc.* **1995**, *117*, 5614.
27. Haddleton, D. M.; Jasieczek, C. B.; Hannon, M. J.; Shooter, A. J. *Macromolecules* **1997**, *30*, 2190.
28. Gaynor, S. G.; Qiu, J.; Matyjaszewski, K. *Macromolecules* **1998**, *31*, 5951.
29. Ashford, E. J.; Naldi, V.; O'Dell, R.; Billingham, N. C.; Armes, S. P. *J. Chem. Soc., Chem. Commun.* **1999**, 1285.
30. Wang, X. S.; Lascelles, S. F.; Jackson, R. A.; Armes, S. P. *J. Chem. Soc., Chem. Commun.* **1999**, 1817.
31. Wang, X. S.; Malet, F. L. G.; Armes, S. P.; Haddleton, D. M.; Perrier, S. M. *Macromolecules* **2001**, *34*, 162.
32. Grubbs, R. B.; Hawker, C. J.; Dao, J.; Fréchet, J. M. J. *Angew. Chem., Int. Ed. Engl.* **1997**, *36*, 270.
33. Leduc, M. R.; Hayes, W.; Fréchet, J. M. J. *J. Polym. Sci., Part A: Polym. Chem.* **1998**, *36*, 1.
34. Wang, X.-S.; Armes, S. P. *Macromolecules* **2000**, *33*, 6640.
35. Yu, D.; Vladimirov, N.; J. M. J. Fréchet, J. M. J. *Macromolecules* **1999**, *32*, 5186.
36. Fontanille, M. In *Comprehensive Polymer Science*; Pergamon Press: Oxford; **1989**, Vol. 3, Ch. 25, p. 365.

3: *Controlled/‘living’ polymerization methods*

37. Miyamoto, M.; Sawamoto, M.; Higashimura, T. *Macromolecules* **1984**, *17*, 265.
38. Inoue, S.; Aida, T.; Kuroki, M.; Hosokawa, Y. *Makromol. Chem. Macromol. Symp.* **1992**, *32*, 255.
39. Chiefari, J.; Chong, Y. K.; Ercole, F.; Krstina, K.; Jeffrey, J.; Le, T. P. T.; Mayadunne, R. T. A.; Meijs, G. F.; Moad, C. L.; Moad, G.; Rizzardo, E.; Thang, S. H. *Macromolecules* **1998**, *31*, 5559.
40. Grubbs, R. H.; Gilliom, L. R. *J. Am. Chem. Soc.* **1986**, *108*, 733.

Step-growth polymerization—basics and development of new materials

ZHIQUN HE, ERIC A. WHALE, and FRED J. DAVIS

1. Introduction

Step-growth polymerization is often referred to as condensation polymerization, since often—but by no means always—small molecules such as water are released during the formation of the polymer chains. There are a number of differences in the way polymerization occurs in step-growth polymerization compared to chain-growth processes, and these have marked practical implications. The most obvious difference is that, as the name implies, the polymer chain grows in a step-wise fashion; the initial stage of the reaction involves the conversion of monomers to dimers and from these other lower molecular weight oligomers.¹ It is only as the reaction nears completion that significant quantities of higher molecular weight material can be formed. Thus, in order to obtain effective molecular weights, the reaction must proceed almost to completion, indeed the molecular weight (in terms of the number average degree of polymerization x_n) of the polymer can be linked to the extent of reaction (p) using eqn (1). Thus, in the simplest case of a difunctional (AB) monomer, when 50% of the available groups have reacted, the number average degree of polymerization is only 2.

$$x_n = \frac{1}{1 - p} \quad (1)$$

The consequence of eqn (1) is that high molecular weights in step-growth polymerizations are associated with highly efficient reactions that do not have side-reactions. Notwithstanding this, the types of molecular weights associated with chain-growth processes are not encountered in these processes (except in the case of monomers with more than two reactive groups where

4: Step-growth polymerization

hyper-branched or even cross-linked polymers are possible). There is an additional complication, namely the role of cyclization. Kricheldorf² has recently shown that under perfect conditions cyclization is the ultimate fate of any polymerization reaction. Thus, under extremely high conversions the prediction given by eqn (1) would overestimate the actual molecular weights produced.

Molecules that undergo step-growth polymerization must have at least two reactive functional groups. If the functionality is greater than this, for example, trifunctional, then hyperbranched polymers or even cross-linked systems can be formed.^{3,4} Commonly, this involves the reaction of two different reactive difunctional monomers. Such a system is often classified as an AA BB system and is well known to chemistry students in the form of the formation of Nylon 6,6 via the condensation of adipoyl chloride with 1,6-diaminohexane, in an interfacial polymerization, often referred to as the Nylon rope trick.* A similar procedure can be used to form an ester, and an example is given later. As an alternative to using rather reactive di-acid chlorides, where the possibility that a proportion of the material can become deactivated by, for example, hydrolysis, carboxylic acids may be activated *in situ*; a particularly popular example of this being the phosphorylation reaction.⁵ This approach has a number of advantages, one of which is offering the possibility of polymerizing by functional monomers such as 4-aminobenzoic acid,⁶ thereby circumventing the need for stoichiometric balance.⁷ In other instances, the reaction is forced by removing volatile by-products from the reaction, and less reactive materials may give quite reasonable molecular weight polymers in this way.

2. The synthesis of an aromatic polyamide

The range of chemical reactions that can be used to form step-growth type polymers is too large to describe adequately here. As a consequence, this chapter focuses on some of the problems associated with forming aromatic polymers. Such systems have attracted considerable interest in view of the success of Kevlar and the aramid fibres. They offer particular synthetic challenges, one of which being that a level of intractability generally accompanies the increase in mechanical strength associated with rigid rod systems. This first example is representative of a procedure frequently used for

* Approximately 3 g of hexane-1,6-diamine is dissolved in aqueous sodium hydroxide (0.5 M, 50 mL) and placed in a beaker (100 mL). A solution of adipoyl chloride (**care!** lachrymator) in hexane (1 g in 50 mL) is added to this beaker and two layers will be seen. At the interface between the aqueous and the non-aqueous phase, a thin film will form. This film can be pulled using a pair of tweezers to form a long strand of Nylon 6,6.

the synthesis of polyamides; the polymer is prepared in solution using the phosphorylation procedure described above.⁸

Protocol 1.

An aromatic polyamide formed between 1,4-diaminobenzene and isophthalic acid (Scheme 1)

Caution! Carry out all procedures in a well-ventilated fume-cupboard, wear appropriate disposable gloves, a lab-coat, and safety glasses.

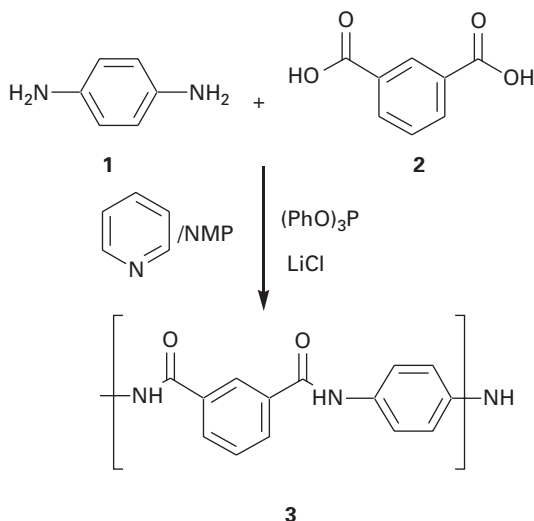

Scheme 1 Formation of polyamide using phosphorylation reaction.

Equipment

- Two-necked round-bottomed flask (250 mL)
- Apparatus for Soxhlet extraction, single-necked round-bottomed flask, Soxhlet extractor thimble and condenser
- Teflon[®]-coated magnetic follower
- Vacuum desiccator
- Erlenmeyer flasks (various)
- Apparatus for filtration, Buchner funnel and flask, water pump
- Condenser
- Hotplate/magnetic stirrer and oil-bath
- Thermometer and ground-glass adapter
- Vacuum oven

Materials

- *p*-phenylenediamine, 2.16 g, 20 mmol

toxic by skin contact, inhalation and if swallowed, may cause sensitization by skin contact

4: Step-growth polymerization

- Sodium dithionate, 3.5 g **may cause fire, harmful if swallowed, contact with acids, liberates toxic gas**
- Decolourizing carbon, approximately 3–5 g
- Isophthalic acid, 3.32 g, 0.02 mol
- Phosphorous pentoxide **irritant causes severe burns**
- *N*-methylpyrrolidone (NMP), 60 mL **irritating to skin, eyes, and respiratory system**
- Pyridine, 40 mL **highly flammable, harmful by skin contact, inhalation and if swallowed**
- Dimethylacetamide, ca. 50 mL **harmful by skin contact and inhalation, eye irritant**
- Methanol, ca. 500 mL **toxic by inhalation and if swallowed, highly flammable**
- Triphenyl phosphite, 10.5 mL, 0.04 mol **irritating to skin, eyes, and respiratory system, prolonged contact may cause skin sensitization**
- Lithium chloride, ca. 3 g **harmful, irritating to skin, eyes, and respiratory system, potential teratogen**

Method

Preparation: In an Erlenmeyer flask (1 L) *p*-phenylenediamine (100 g) is dissolved in hot water (300 mL) containing sodium dithionate (3.5 g) and the solution is then filtered and cooled in an ice-bath to crystallize. The white crystals formed are collected by filtration at the water pump, dried in air and then in a vacuum desiccator over phosphorous pentoxide.^a Isophthalic acid is purified by recrystallization from hot methanol; the hot solution is filtered and then cooled in an ice-salt-bath, the white crystals formed are collected by filtration at the water pump and dried in a vacuum oven.

1. In a two-necked round-bottomed flask (250 mL), equipped with a thermometer, condenser, and a magnetic stirrer is placed *p*-phenylenediamine (2.16 g, 20 mmol) and isophthalic acid (3.32 g, 20 mmol). To this mixture NMP, 60 mL and pyridine (40 mL) containing lithium chloride (1.4 g, 4% by weight) are added and then triphenyl phosphite (10.5 mL, 40 mmol) is added and the mixture is stirred to give a dark-coloured solution.
2. The temperature is raised to 85–95°C and the mixture is maintained at this temperature for 6–7 h. The reaction is then cooled to room temperature and methanol is added to precipitate the polymer.
3. The crude polymer is purified by dissolving in dimethylacetamide containing LiCl (3% by weight) and precipitating using methanol. This procedure is repeated twice.
- 4 The polymer is then purified by Soxhlet extraction using methanol for 6–8 h. Finally, the polymer is dried in a vacuum oven at 40°C for 24 h.^b

^aYield 83 g (83%); the colour changes gradually from white to purple on storage.

^bTypical yield 99%, $M_n = 8.7 \times 10^{-3}$, $M_w = 19.1 \times 10^{-3}$ (GPC in DMF containing 1% lithium bromide using polyethylene oxide and polyethylene glycol as standards).

3. Preparation of a main-chain liquid crystalline poly(ester ether) with a flexible side-chain (Scheme 2)

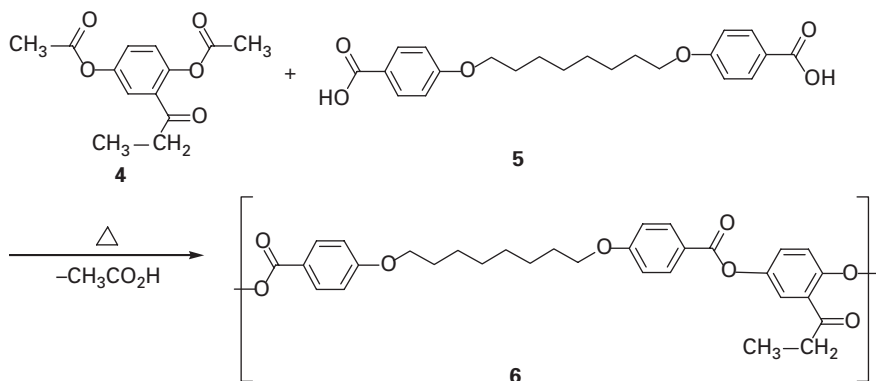

Scheme 2 Preparation of a main chain liquid crystalline poly(ester ether) with a flexible side-chain.

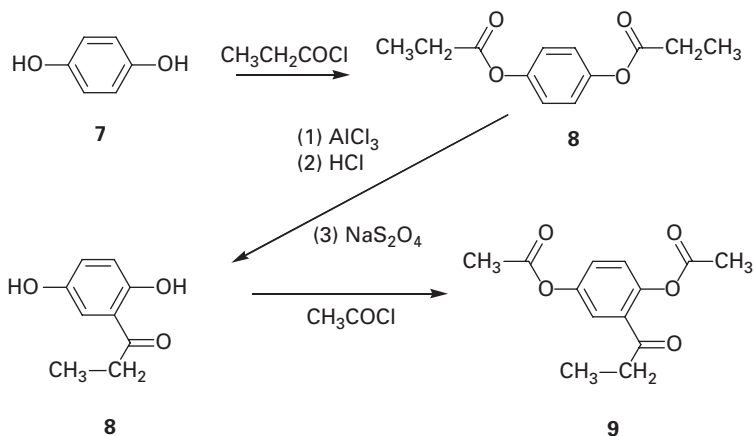

Scheme 3 Formation of an aromatic di-ester with a flexible side-chain.

A common method for polyester formation is via trans-esterification. The procedure described below uses a procedure that is modified from that described in Sorenson.⁹ In this case, aromatic di-acid **5** and di-ester **4** monomers are reacted together in the melt. During the polymerization, the molecular weight grows while volatile side-product is continuously removed from the reaction vessel by means of a vacuum pump. Scheme 2 describes the formation of a main-chain liquid crystalline poly(ester ether) containing

4: Step-growth polymerization

flexible side-chain units. Such units can dramatically improve the processability of such polymers albeit at the expense of some other properties,¹⁰ and may be introduced into hydroquinones using the Fries rearrangement (Scheme 3) as outlined below. The three aromatic rings present in the polymer described here form a ‘hard rod’ to promote liquid crystalline phase formation, and because of the presence of the side-group the phase is formed at a relatively low temperature, namely 125–230°C. As a consequence of this enhanced processibility, the polymer can be aligned uniaxially in the nematic phase using a magnetic field ($B \sim 0.6$ T) and the orientation can be preserved by a rapid cooling.

Protocol 2.

Preparation of an aromatic di-ester with a flexible side-chain 4 for use in a trans-esterification polymerization

Caution! Carry out all procedures in a well-ventilated fume-cupboard, wear appropriate disposable gloves, a lab-coat, and safety glasses.

Equipment

- 2 × Three-necked round-bottomed flasks (1 L)
- Thermometer
- Hotplate stirrer/water-bath and oil-bath
- Nitrogen inlet
- Apparatus for filtration, Buchner funnel and flask, water pump
- Single-necked round-bottomed flask (500 mL)
- Teflon[®]-coated magnetic follower
- Vacuum oven
- Condensers
- Dropping funnel and stopper
- TLC plates (with fluorescent indicator)
- Gas bubbler
- Erlenmeyer flasks
- Ice-bath
- Drying tube (CaCl₂)
- Rotary evaporator
- Powder funnel

Materials

- Hydroquinone, 30 g, 0.27 mol
 - Tetrahydrofuran, 400 mL
 - Pyridine, 60 mL
 - Propionoyl chloride, 61 mL, 0.60 mol
 - Aluminium chloride, 112 g, 0.84 mol
 - Hydrochloric acid (concentrated)
 - Saturated sodium bicarbonate solution
 - Dichloromethane
 - Sulfuric acid solution (ca. 5 M) , 50 mL
 - Sodium dithionite, 90 g, 517 mmol
 - Sodium hydroxide solution (1.5 M), 600 mL
 - Acetyl chloride, 170 mL, 2.16 mol
- harmful by inhalation and if swallowed
highly flammable, irritating to eyes and respiratory system, may form explosive peroxides
highly flammable, harmful by skin contact, inhalation and if swallowed
highly flammable, causes burns, reacts violently with water causes burns
causes burns, irritating to respiratory system
potentially irritating to eyes, skin, and respiratory system
harmful by inhalation, potential carcinogen
extremely corrosive, causes serious burns, harmful by ingestion, inhalation, and skin contact, chronic exposure may result in lung damage and possibly cancer
may cause fire, harmful if swallowed, contact with acids liberates toxic gas
causes burns
highly flammable, reacts violently with water, causes burns**

Protocol 2. Continued

- | | |
|--------------------------------------|---|
| • Magnesium, 0.05 g, 2 mmol | highly flammable, contact with water liberates extremely flammable gas |
| • Diethylether, ca. 200 mL | extremely flammable, may form explosive peroxides |
| • Aluminium oxide for chromatography | irritating to respiratory system |
| • Ethanol | highly flammable |
| • Petroleum ether | highly flammable |
| • Ethyl acetate | highly flammable |

Method

Step 1: Formation of the diester

1. Hydroquinone (30 g, 270 mmol) is added to a three-necked flask (1 L) equipped with a condenser, a dropping funnel, a thermometer, and a Teflon-coated magnetic follower, followed by tetrahydrofuran (400 mL). When the entire solid is dissolved, pyridine (60 mL) is added. The solution is then cooled to below 10°C by means of an ice-bath.
2. From the dropping funnel, propionoyl chloride (61 mL, 0.600 mmol) is added with stirring to the hydroquinone solution whilst ensuring the temperature does not exceed 10°C. An orange precipitate is observed immediately. Once addition is complete, the reaction mixture is stirred overnight (whereupon the orange precipitate becomes white). At this stage thin layer chromatography (TLC) should confirm the formation of the diester.^a
3. On completion of the reaction, the solvent is removed on the rotary evaporator, and the product dissolved in dichloromethane, and washed twice with sulfuric acid solution (approximately 5 M, 50 mL). The pale yellow solution is washed repeatedly with water, and finally with saturated sodium bicarbonate solution till the pH is 7. Finally, the solvent is removed and the white solid is recrystallized from aqueous ethanol (1500 mL, 50%) and dried in a vacuum oven at 50°C.

Step 2: Fries rearrangement¹¹ of hydroquinone dipropionate

4. A three-necked flask is equipped with a nitrogen inlet, and a condenser with a gas bubbler attached.
5. Dry hydroquinone dipropionate (55 g, 0.28 mol) and aluminium chloride (112 g, 0.84 mol) are finely ground and mixed using a mortar and pestle, and then introduced into the reaction flask via the unused neck by means of a powder funnel, and the stopper is placed on the neck.
6. The temperature is increased slowly to 110–120°C by means of an oil-bath; at about 110°C hydrogen chloride will be evolved from the reaction. The temperature is maintained for about 1 h and the mixture is then heated further to 160°C (slowly over 1 h) and this temperature is maintained for a further 5 h. After this time, the initial yellow colouration of the reactants is transformed to a dark brown or even black colour.

4: Step-growth polymerization

7. After cooling, the aluminium chloride is decomposed by the addition of crushed ice to the reaction mixture followed by hydrochloric acid (concentrated 28 mL). The product is then extracted from aqueous solution using diethylether.
8. A solution containing sodium dithionite (150 g per litre) in sodium hydroxide solution (1.5 M) is prepared. The crude product from step 7 above is placed in a flask and partially dissolved in diethylether. This mixture is then poured into a separating funnel and the alkaline sodium dithionite solution is added (600 mL).^b The funnel is then shaken vigorously, the water phase collected and the ether phase washed with further portions of the sodium dithionite solution until the aqueous phase becomes lighter.
9. The aqueous material from step 8 is collected and acidified with concentrated hydrochloric acid; a yellow precipitate of the required product is formed at ca. pH 7. This product is collected by filtration at the pump and purified by recrystallization using a mixture of ethanol and petroleum ether (1:9, 500 mL).^c

Step 3: Esterification of 2,5-dihydroxypropiophenone

10. A single-necked round-bottomed flask (500 mL) is fitted with a condenser and a drying tube, and 2,5-dihydroxypropiophenone (17 g, 0.1 mol), acetyl chloride (170 mL), and magnesium (0.05 g) are added. The reaction mixture is heated to reflux in a water-bath set at a temperature of 55–60°C. After two days the excess acetyl chloride is removed under reduced pressure (rotary evaporator).
11. The crude product from step 10 above is purified by dry column flash chromatography^{12,d} and then by recrystallization from a mixed solvent of petroleum ether and ethyl acetate (1:1) to yield colourless crystals (m.p. 57–60°C).

^aIf TLC reveals an unexpected spot, then it may be possible to complete the conversion by adding a further portion of propionoyl chloride as in steps 1 and 2.

^bHydroquinones are particularly susceptible to aerial oxidation, but the quinones produced are readily reduced.

^cThe product obtained by crystallization contained a trace contaminant as revealed by TLC; nevertheless, this was considered sufficiently pure to carry on to the next stage where purification is easier. The product can be purified by column chromatography on silica, using a mixed solvent system composed of petroleum ether and ethyl acetate; the material is rather polar and has only limited solubility in this eluant mixture making this process too inefficient to be done on a large scale.

^dActivated Al₂O₃ (neutral) is used as the stationary phase. This is placed in a sintered-glass funnel (100 mL), placed on a clean Buchner flask and connected to the water aspirator, and allowed to settle. The crude product is placed on top of the stationary phase as a solution, and the eluting solvent passed through with the aid of the water vacuum. In this case, a mixed solvent of ethyl acetate and petroleum ether is suitable, and the polarity of the solvent is increased from 5% to 60% ethyl acetate in 5% steps using a 100 mL of solvent at each elution. Some excellent accounts of this procedure are given elsewhere.^{13,14}

Protocol 3.**Preparation of a main-chain liquid crystalline poly(ester ether) with a flexible side-chain**

Caution! Carry out all procedures in a well-ventilated fume-cupboard, wear appropriate disposable gloves, a lab-coat, and safety glasses.

Equipment

- Dual manifold (nitrogen/vacuum)
- Glass tube with a ground-glass top and side-arm
- Screw top thermometer adapter
- Gas bubbler
- Fine capillary (made from an ordinary pipette)
- An electromagnet ($B \sim 0.6$ T) equipped with a thin hot-stage and a temperature controller
- Source of dry nitrogen
- Bunsen burner
- Glass mortar and pestle
- Wood's metal bath
- Apparatus for filtration, Buchner funnel and flask, water pump
- Vacuum oven
- Kapton sheet of 25 μm thickness

Materials

- Monomer **4**, 0.97 g, 4 mmol
 - Monomer **5**, 1.5 g, 4 mmol
 - Zinc acetate dihydrate, 0.5 mg, 2×10^{-6} mol
 - Antimony (III) oxide, 0.7 mg, 2×10^{-6} mol
 - Methanol
 - *p*-chlorophenol
 - Wood's metal
- treat as harmful**
treat as harmful
harmful by inhalation and if swallowed, irritant
toxic by skin contact, inhalation, and if swallowed, potential carcinogen
toxic by inhalation and if swallowed, highly flammable
harmful by skin contact, inhalation, and if swallowed
harmful by inhalation, in contact with the skin, and if swallowed

Method

Preparation: Monomer **4** is synthesized as above; monomer **5** is prepared using a procedure analogous to that described in Protocol 5 below.^a

1. An equal molar amount of monomer **4** (0.97 g, 4 mmol) and monomer **5** (1.5 g, 4 mmol) are ground to a fine powder in a glass mortar. The mixture is then transferred to a glass tube equipped with a side-arm and a ground-glass joint. To these monomers is then added the catalyst mixture consisting of $\text{Zn}(\text{CH}_3\text{CO})_2 \cdot 2\text{H}_2\text{O}$ (0.5 mg, 2×10^{-6} mol) and Sb_2O_3 (0.7 mg, 2×10^{-6} mol).
2. A nitrogen inlet is constructed using a fine capillary^b held through a screw-top Quickfit thermometer adapter, placed on top of the glass tube. The system is adjusted such that the capillary reaches the bottom of the glass tube. The side-arm is connected to a gas bubbler. The glass tube is then placed in a Wood's metal bath, which is heated by means of a Bunsen burner (**care!**).
3. A flow of nitrogen gas is allowed to pass through the reaction mixture and is heated by means of the Wood's metal bath. When the mixture becomes molten, the temperature is maintained. The pressure inside the glass tube is reduced, first using the water aspirator to remove most of the acetic acid produced in the reaction, and then using a standard rotary pump for about 3 h.^c

4: Step-growth polymerization

4. When the reaction is judged to be complete, the reaction mixture is cooled and removed from the Wood's metal bath. The polymer is collected by breaking the glass tube.
5. The crude polymer is purified by dissolving in *p*-chlorophenol at 80°C followed by precipitation by the addition of cold methanol to the solution. The purified polymer is washed with methanol three times and then dried in a vacuum oven at 50°C for 12–18 h.
6. A polymer film of 1–2 cm diameter and 0.5–1.0 mm thickness is prepared by melting on a hotplate in between two sheets of Kapton. After cooling, the top sheet is peeled off.
7. To align the sample magnetically, the film prepared in step 6 is placed on a hot-stage in between the two poles of an electromagnet. The hot-stage is powered by a temperature controller and the temperature probed with a thermocouple (Chrome–alumel—type 3). The magnetic field direction must be marked carefully on the sample. The hot-stage is connected to a supply of nitrogen and the sample is maintained under a nitrogen atmosphere for the duration of the experiment. (This prevents thermally initiated oxidation of the sample.) The sample is then heated to 190°C, and when the temperature is stabilized the magnetic field is switched on.
8. The magnetic field is maintained for 2 h, and the sample is cooled rapidly on a cold metal surface or with liquid nitrogen as soon as the power supply of the magnet is turned off. The film is then placed in the sample holder of a suitable X-ray diffractometer (with axis vertically aligned) and the diffraction pattern is recorded with a flat-plate camera.

^aMethyl-*p*-hydroxybenzoate (33.6 g, 220 mmol) and potassium carbonate (30.4 g, 220 mmol) are dissolved in DMF (180 mL). The solution is heated to 70–80°C with stirring, and dibromooctane (25 g, 90 mmol) is added to the solution, which is heated overnight. Monomer **5** is isolated by precipitation into water followed by recrystallization. The di-ester (30 g, 70 mmol) is hydrolysed with potassium hydroxide (24.3 g, 435 mmol).

^bA fine glass capillary can be prepared from a standard Pasteur pipette, by heating the glass end of the pipette in a hot flame whilst holding the pipette firmly in both hands. When the glass softens and begins to deform, the pipette is quickly removed from the heat source and the ends pulled apart.

^cThe high viscosity of the polymer melt may cause problems. In a condensation polymerization, viscosity of the polymer melt will gradually increase as the reaction progresses. However, the increase of the molecular weight may also be limited by the high viscosity, as the monomer diffusion rate is drastically reduced. Although it is likely that little acetic acid is observed condensing at the vacuum outlet, it is important to keep the reaction going in order to improve the molecular weight at this stage.

4. Non-periodic crystallization from a side-chain bearing copolyester

In highly aromatic polymers, processibility is a major problem. One possible solution to this might be to prepare copolymers, since the disruption of regular sequences should restrict crystallization.¹⁵ Unfortunately, it is found

that short sequences in the polymer chain locally match to form crystals, so the improvement in processibility is less than what might be hoped.¹⁶ In this example, both a biphenyl and a phenyl unit are included in a copolymer, with the phenyl ring system further substituted with an aliphatic side-chain, in order to promote additional disruption to any solid-state ordering.¹⁷ The modification of polymer repeat units alters the properties of the final polymers dramatically. The polymers produced exhibit complex crystallization behaviour.¹⁸

The polymer described here is prepared through interfacial polymerization⁹ using a variation of the well-known Schotten–Baumann reaction. The reaction is shown in Scheme 4. To work effectively, the aromatic OH groups must be deprotonated by treatment with base, and the phenolate ions produced from the monomers **10** and **11** then react with sebacyl chloride **12**. In fact, in the example chosen, the polymer formed was found to have a rather low molecular weight.

Protocol 4.

Formation of a copolyester by an interfacial polymerization (Scheme 4)

Caution! Carry out all procedures in a well-ventilated fume-cupboard, wear appropriate disposable gloves, a lab-coat, and safety glasses.

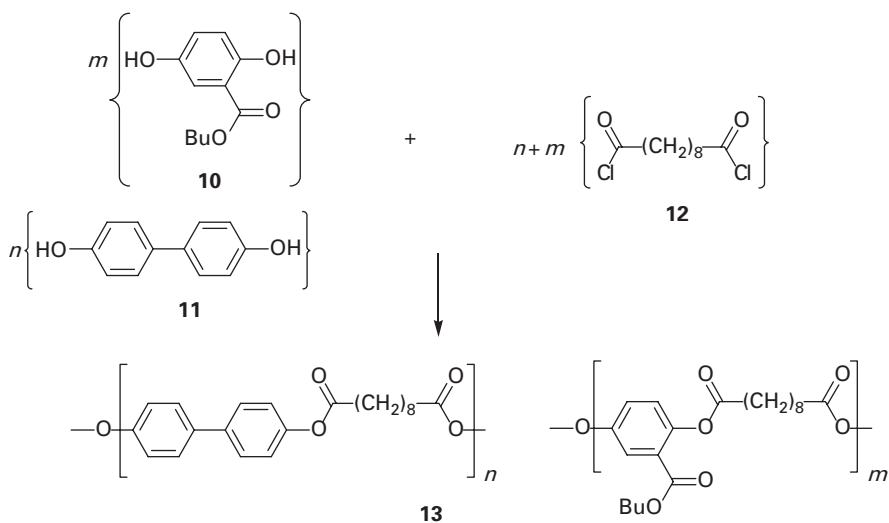

Scheme 4 Interfacial polymerization to form an aromatic polyester.

4: Step-growth polymerization

Equipment

- High speed blender
- Burette
- Single-necked round-bottomed flask (250 mL)
- Soxhlet extractor and thimble
- Apparatus for filtration, Buchner funnel and flask, water pump
- Glass beaker (1 L)
- Column
- Drying tube
- Erlenmeyer flask (250 mL)
- Condenser
- Hotplate stirrer and oil-bath
- Differential scanning calorimeter (DSC), aluminium container for DSC
- Teflon[®]-coated magnetic stirrer bar

Materials

- Monomer **10**, 0.83 g, 5 mmol
 - Biphenol **11**, 0.93 g, 5 mmol
 - Sebacyl chloride **12**, 2.3 mL, 10 mmol
 - Sodium hydroxide, 3.98 g, 100 mol
 - Molecular sieve (type 4A)
 - Alumina, type UG, <200 mesh
 - Benzoic acid for standardization
 - Soda lime for trap
 - Distilled water
 - Tetrabutylammonium hydrogen sulfate, 0.18 g, 0.05 mmol
 - Methanol
 - Chloroform
- treat as harmful**
treat as harmful
reacts violently with water liberating toxic gas, harmful by skin contact, inhalation, and if swallowed causes burns
dust may cause irritation if inhaled irritant
irritant, harmful if swallowed and by inhalation causes burns
irritant
toxic by inhalation and if swallowed, highly flammable harmful by inhalation and if swallowed, potential carcinogen

Method

Preparation: Monomer **10** is prepared by esterification of 2,5-dihydroxybenzoic acid.^a Sebacyl chloride is distilled under reduced pressure (b.p. 124–125°C at 0.7 mmHg).

1. Carbon dioxide and oxygen-free water^{19,20} is obtained by refluxing distilled water in a round-bottomed flask with a soda lime-filled drying tube on top of the condenser for 3–4 h. The flask is then purged with nitrogen and stoppered.
2. Sodium hydroxide pellets (3.98 g, 100 mmol) are dissolved in CO₂/O₂-free water (~300 mL) and stored under nitrogen. The NaOH solution is titrated with benzoic acid as a standard using phenolphthalein as the indicator.
3. Ethanol-free chloroform¹⁹ is obtained by passing ethanol through a column of aluminium oxide (type UG, <200 mesh). It is then stored over molecular sieve (type 4A).
4. Biphenol (0.93 g, 5 mmol) and monomer **10** (0.83 g, 5 mmol) are dissolved in the CO₂/O₂-free sodium hydroxide solution prepared in step 2 above. The solution is then placed into a household blender^b to form the aqueous phase of the interfacial polymerization. Then, tetrabutylammonium hydrogen sulfate (0.18 g, 0.05 mmol) is added as phase transfer catalyst.
5. Sebacyl chloride (2.3 mL, 10 mmol) is dissolved in ethanol-free chloroform to form the organic phase.
6. The organic phase from step 5 is poured into the blender and stirred at high speed for about 5 min, more CO₂/O₂-free water can be added if necessary.

Protocol 4. Continued

7. The product is then put into a beaker and the chloroform is evaporated off.^c The resulting polymer is filtered at the water aspirator and washed with methanol. It is then placed in a Soxhlet thimble and extracted in a Soxhlet apparatus using methanol. This removes unreacted monomer and any other low molecular weight material. The final polymer will be an off-white powder.
8. The crystallization behaviour of the material is probed by DSC. A sample of the polymer (0.01 g) is accurately weighed and encapsulated in an aluminium container for DSC. The sample is placed in the DSC chamber (see Chapter 1) and then heated to 250°C and the temperature held for 5 min. The sample is then cooled at 20°C/min to room temperature. The same sample is then scanned at 20°C min⁻¹ from room temperature to 250°C in order to record the melting transition curve. To observe non-periodic phenomena, the sample is first heated up to 250°C at 20°C min⁻¹ and held at this temperature for 5 min. The sample is then rapidly cooled to 160°C and held at this temperature for 12 h; it is then rapidly cooled to 120°C and held for 12 h, then cooled and held at 90°C.^d The sample is then cooled at 20°C min⁻¹ to room temperature. Recording a heating scan will reveal multiple transition peaks.

^a2,5-Dihydroxybenzoic acid (18.8 g, 120 mmol), butanol (23 mL, 250 mmol), and H₂SO₄ (3–4 mL, conc.) are refluxed in toluene previously dried over sodium (25 mL) in a flask equipped with a Teflon-coated magnetic stirrer and a Dean–Stark trap for 9 h. On completion of the reaction (as revealed by TLC), the product is poured into water and extracted with ether. Washing with sodium hydrogen carbonate solution and then water followed by recrystallizing from petroleum ether (60–80 fractions) gives the product as a white solid.

^bIt is very important to stir the reaction at high speed during the polymerization stage. A standard household blender is a convenient method of mixing for interfacial polymerization, but should not be used with flammable solvents.

^c**Care!** Significant quantities of chloroform should, of course, be removed by using, for example, a rotary evaporator in the normal way.

^dThe melting temperature of the polymer will be affected by the molecular weight and copolymer composition. Hence, the melting temperature of the final copolymer may be slightly different. The temperatures given above relate to a polymer with a melting point of 150°C. If the temperature is higher than this, then the initial heating should be repeated and the temperatures increased accordingly.

5. A comparison of melt polymerization of an aromatic di-acid containing an ethyleneglycol spacer with polymerization in a solvent and dispersion in an inorganic medium

In the procedures below, methodology is described to facilitate medium scale (ca. 100 g) synthesis of a main-chain thermotropic liquid crystalline polymer containing ethylene glycol units as a flexible spacer between the rigid aromatic units. Two methods are described; melt polymerization, and polymerization in a heat-transfer solvent with an inorganic medium (Claytone).²¹ For melt polymerization, the material is obtained as an extremely rigid solid, while in the

4: Step-growth polymerization

inorganic medium the polymer remains dispersed even when the reaction is near completion. In both cases, high conversions can be achieved, but it is noticeable that for the melt polymer some decomposition occurs at the later stages of the reaction. Not only is the polymer discoloured, but hydroquinone is evolved. Polymerization using a heat-transfer solvent appears to be the most effective in terms of producing high molecular weight; there is little discolouration and no hydroquinone evolved, suggesting low levels of decomposition. Although the material is contaminated with the inorganic dispersing medium, this is present in relatively low concentrations and, as can be seen from the protocols below, the polymeric material produced is relatively easy to handle.

Protocol 5.

Reaction of ethyl 4-hydroxybenzoate with 1,2-bis (2-chloroethoxy) ethane and hydrolysis to form the corresponding di-acid 18 (Scheme 5)

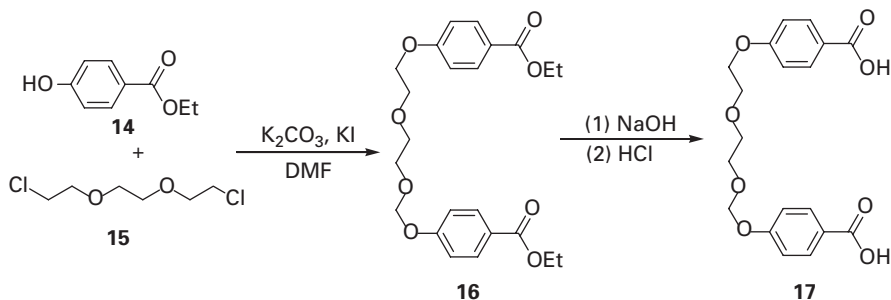

Scheme 5 Synthesis of a polymerizable aromatic di-acid with a flexible coupling chain.

Equipment

- Three-necked round-bottomed flask (1 L)
- Thermometer
- Hotplate stirrer and oil-bath
- Single-necked round-bottomed flask
- Apparatus for filtration, Buchner funnel and flask, water pump
- Condensers
- Dropping funnel and stopper
- Dean-Stark trap
- TLC plate (with fluorescent indicator)
- Erlenmeyer flasks (various)
- Teflon-coated magnetic follower

Materials

- Ethyl-4-hydroxy benzoate, 182.6 g, 1.1 mol
- Potassium carbonate, 151 g, 1.1 mol
- Potassium iodide, 0.5 g, 3 mmol
- Dimethyl formamide (DMF), 500 mL
- 1,2-Bis(2-chloroethoxy)ethane, 93.5 g, 0.5 mol

- Petroleum ether/ethyl acetate mixture (3:2 for TLC)
- Ethanol
- Hydrochloric acid (concentrated)

irritating to eyes, skin, and respiratory system
irritating to eyes, skin, and respiratory system
irritant
potentially teratogenic, harmful in contact with skin, irritating to eyes
toxic by skin contact, harmful if swallowed, risk of eye damage, irritating to eyes, skin and respiratory system, may form explosive peroxides
highly flammable
highly flammable
causes burns, irritating to respiratory system

Protocol 5. Continued

Method

1. DMF (500 mL) is placed in a dry three-necked flask (1 L) equipped with a condenser, a thermometer, and a dropping funnel. Ethyl-4-hydroxy benzoate^a (182.6 g, 1.1 mol), potassium carbonate (151 g, 1.1 mol) and potassium iodide (0.5 g, 3 mmol) are added to the DMF. A relatively large amount of solid material remains undissolved.^b
2. The mixture is then heated to 80°C and 1,2-bis(2-chloroethoxy)ethane (93.5 g, 0.5 mol) is added over about 3 h. Heating of the resultant mixture is then continued with occasional stirring until TLC suggests that the reaction is essentially complete.^{c,d} In this case, after about nine days TLC shows that the majority of the material is present as either ethyl 4-hydroxybenzoate (which, of course, is present in slight excess) or as the di-aromatic ether with only a faint spot due to the mono-aromatic compound.
3. The flask is then allowed to cool to room temperature and tipped into 3 L of water, whereupon an oil is formed, which rapidly solidifies to give a white product. This solid is filtered, and recrystallized from ethanol until the solution is no longer yellow and TLC shows only the presence of the di-ester. Typical yield = 85 g (38%).^e
4. A single-necked round-bottomed flask is equipped with a Dean–Stark trap,^f condenser, and Teflon[®]-coated magnetic follower. The di-ester (68.5 g) is added to the flask. Then potassium hydroxide (56 g, 1 mol) dissolved in water (500 mL) is added together with ethanol (200 mL).
5. The solution is then heated to boiling. After ca. 1–2 h all the material will dissolve, and the solvent is removed from the side-arm, until the rate of collection slows substantially (after ca. 200 mL has been removed).

^aAlthough this may be simply misfortune on the part of the worker, one batch of this starting compound was severely contaminated with the dimethyl ester. Both are fine independently, but the mixture is not, since the crude product cannot be readily purified by crystallization.

^bAs a consequence of this solid material, magnetic stirring of the solution is not possible. In view of the long period required for reaction, mechanical stirring was deemed unsuitable; as a consequence no stirring was used in this procedure.

^cSolvent petroleum ether/ethyl acetate (3:2)—3 spots: top spot, $R_f = 0.46$, due to ethyl 4-hydroxybenzoate, next spot, $R_f = 0.33$, due to mono-ether, and lowest spot, $R_f = 0.20$, due to di-ether.

^dA small sample is taken from the reaction flask and diluted with a small amount of water, this causes the organic material to precipitate and allows some of the solvent to be removed with a pipette. Then acetone is added to dissolve the precipitate. This procedure reduces the amount of DMF present, which caused 'smearing' of the spots.

^eImproved yields can be obtained by increasing the amount of KI to 1% and increasing the temperature to ~100 °C (in the liquid). However, since care must be taken to avoid overheating as the solid material in the flask results in an inhomogeneous temperature distribution, this is probably not suited to the quantities here. Under these forcing conditions, the intermediate spot (which is presumed to be due to monosubstituted materials) is lost in 48 h.

^fThere is, of course, no element of phase separation here. This set-up simply provides an easy way to maintain the solution at constant reflux and, subsequently, remove the volatile component without changing from a reflux to a distillation arrangement. In fact, the set-up shown in Chapter 9, that is, that

4: Step-growth polymerization

6. The solution is then allowed to cool and acidified with HCl. The solid is then collected by filtration^g washed with water, transferred to an Erlenmeyer flask (3 L), heated in water (~1 L), and filtered. This procedure is then repeated using methanol as the solvent. After allowing the methanol to cool, the suspension is filtered and dried at the vacuum pump.^g The solid is then dried in an oven at 110°C for at least two days (to a constant weight); yield after drying = 48 g.^h

designed for removing water from solvents of higher density, is better since the volatile component is constantly cycled through the side-arm during the refluxing stage.

^gWith some difficulty, the material was found to be very fine and tends to block sintered funnels. Consequently, the procedure for filtering this material was to allow most of the sample to pass through under gravity, and to use the pump to remove the final residues.

^hTLC showed one spot and NMR revealed no other organic contaminants.

Protocol 6.

Melt polymerization of an aromatic di-acid containing an ethyleneglycol spacer

Equipment

- Single-necked round-bottomed flask (500 mL)
- Wood's metal bath
- Bunsen burner
- Gas outlet tubes (×2)
- Dual manifold (nitrogen/vacuum)
- Vacuum source
- Source of dry nitrogen
- Buchner funnel with ground-glass joint

Materials

- Di-acid, 47.9 g, 0.123 mol
- Hydroquinone diacetate, 23.8 g, 0.123 mol
- Antimony(III) oxide, 22 mg, 7.5×10^{-5} mol
- Zinc acetate dihydrate, 16 mg, 7.3×10^{-5} mol
- Wood's metal
- Ethanol

**treat as harmful
irritating to eyes, respiratory system, and skin
toxic by skin contact, inhalation and
if swallowed, potential carcinogen
harmful by inhalation and if swallowed, irritant
harmful by inhalation, in contact with the skin,
and if swallowed
highly flammable**

Method

Preparation: The tetraethyleneglycol-linked di-acid monomer is dried under high vacuum for 2 h prior to use. Hydroquinone diacetate is recrystallized from ethanol and dried under vacuum to constant weight. All glassware is dried in the oven at 125°C prior to use.

1. The dry di-acid (47.9 g, 0.123 mol) and hydroquinone diacetate (23.8 g, 0.123 mol) are ground using a mortar and pestle to ensure thorough mixing, and antimony(III) oxide (22 mg, 7.5×10^{-5} mol) and zinc acetate dihydrate (16 mg, 7.3×10^{-5} mol) are added. The mixture is then placed in a pre-weighed single-necked round-bottomed flask (500 mL) and weighed.
2. The round-bottomed flask containing the mixture is fitted with an outlet tube attached to a collecting flask (a Buchner flask with a ground-glass joint), and thence to the dual-manifold system. The system is then evacuated and flushed with argon several times.

Protocol 6. Continued

3. The round-bottomed flask is placed in a warm Wood's metal bath and the bath heated until the material melts,^a whereupon vigorous bubbling will start and acetic acid will be liberated. The flask is maintained at this temperature until no further acetic acid is distilled over.
4. At this point, the flask is evacuated via the manifold (water aspirator) and a further quantity of acetic acid is distilled. Finally, the pressure is further reduced using a rotary pump to give a vacuum of ca. 1 mm Hg and a further quantity of acetic acid is removed, and heating is allowed to continue for about 30 min at this pressure.^b
5. The flask containing the polymer is broken and the solid material removed. This polymer is transferred to a polyethene bag and treated with a hammer to produce small particles. Yield = 54 g (95%).

^aAt a bath temperature of 260°C.

^bAfter ca. 1 h at low pressure, the liquid will darken slightly and some white crystals will be observed round the neck of the flask—these have been identified by mass spectrometry as hydroquinone and suggests that the polymer is decomposing under these conditions.

Protocol 7.

Polymerization of an aromatic di-acid containing an ethyleneglycol spacer by polymerization in a solvent and dispersion in an inorganic medium

Equipment

- Three-necked round-bottomed flask (500 mL)
- Heating mantle
- Beakers and Erlenmeyer flasks (various)
- Mechanical stirrer, polished glass stirrer rod, paddle, and Teflon stirrer guide
- Gas outlet tubes (×2)
- Mortar and pestle
- Dual manifold (nitrogen/vacuum)
- Vacuum source
- Source of dry nitrogen
- Apparatus for filtration, Buchner funnel and flask, water pump
- Thermometer
- Buchner funnel with ground-glass joint

Materials

- Di-acid, 50.9, 131 mmol
 - Hydroquinone diacetate, 25.3 g, 131 mmol
 - Antimony(III) oxide, 23 mg, 7.9×10^{-5} mol
 - Zinc acetate dihydrate, 17 mg, 7.8×10^{-5} mol
 - Wood's metal
 - Claytone, 0.7 g
 - High-boiling heat-transfer fluid (Dowtherm), 200 mL
 - Ethanol
 - Acetone
- treat as harmful irritating to eyes, respiratory system, and skin toxic by skin contact, inhalation, and if swallowed, potential carcinogen harmful by inhalation and if swallowed, irritant harmful by inhalation, in contact with the skin, and if swallowed irritating to eyes, respiratory system, and skin, carcinogen potential (inhalation) treat as harmful highly flammable highly flammable**

4: Step-growth polymerization

Method

Preparation: The tetraethyleneglycol-linked diacid monomer is dried under high vacuum for 2 h prior to use. Hydroquinone diacetate is recrystallized from ethanol and dried under vacuum to constant weight. All glassware is dried in the oven at 125°C prior to use.

1. The dry di-acid (50.9 g, 0.131 mol) and hydroquinone diacetate (25.3 g, 0.131 mol) are ground using a mortar and pestle and antimony(III) oxide (23 mg) and zinc acetate dihydrate (17 mg) are added.
2. This mixture is then placed in a three-necked round-bottomed flask equipped with a thermometer (0–300°C), an overhead stirrer, and an outlet tube connected by (thick-walled) tubing to a Buchner flask fitted with a Quickfit (female) joint. The conical flask is, in turn, attached to the dual-manifold system using a similar outlet tube.
3. An inorganic clay (Claytone, 0.7 g) is added together with a high-boiling heat-transfer fluid (Dowtherm, 200 mL). The mixture is heated to 250°C and stirred vigorously, whereupon liquid (largely acetic acid) is collected in the conical flask.
4. After the initial boiling of the liquid subsides (ca. 2 h), a vacuum (water aspirator) is applied to remove further acetic acid. After treating under vacuum, argon is readmitted to the flask and the system left for a further 10 min. This cycle of evacuation and heating under argon is continued for about 2 h until no more liquid is collected.
5. The mixture is then allowed to cool, whereupon the polymer separates out from the solvent (and becomes cloudy) at ca. 200°C. This polymer is then transferred into a beaker (mostly while still liquid, although the solid could easily be removed from the flask). Acetone is then added to the waxy solid obtained and the material ground under acetone using a mortar and pestle. The product is then filtered, washed further with acetone and finally washed by heating in acetone. The material is dried in an oven at 140°C. Yield = 57 g (93%).

References

1. Flory, P. J. *Principles of Polymer Chemistry*; Cornell University Press: Ithaca, NY; **1953**.
2. Kricheldorf, H. R.; Rabenstein, M.; Maskos, M.; Schmidt, M. *Macromolecules* **2001**, *34*, 713–722.
3. Stockmayer, W. H. *J. Chem. Phys.* **1944**, *12*, 125.
4. Feast, W. J.; Stainton, N. M. *J. Mater. Chem.* **1994**, *4*, 1159–1165.
5. (a) Higashi, F.; Ogata, S.; Aoki, Y. *J. Polym. Sci., Polym. Chem. Ed.* **1982**, *20*, 2081. (b) Yamazaki, N.; Matsumoto, M.; Higashi, F. *J. Polym. Sci., Polym. Chem. Ed.* **1975**, *13*, 1373.
6. Idemura, S.; Preston, J. *J. Polym. Sci., Part A.: Polym. Chem. Ed.* **2003**, *41*, 1014–1026.

7. Stevens, M. P. *Polymer Chemistry, An Introduction*, 2nd edn; OUP: Oxford; **1990**.
8. He, Z.; Davis, F. J.; Mitchell, G. R. *Polymer* **1994**, *35*, 2218–2221.
9. Sorenson, W. R.; Campbell, T. W. *Preparative Methods of Polymer Chemistry*, 2nd edn; John Wiley & Sons: New York; **1968**.
10. He, Z.; Davis, F. J.; Mitchell, G. R. *Eur. Polym. J.* **1996**, *32*, 735–746.
11. Fries, K.; Finck, G. *Ber.* **1908**, *41*, 2447.
12. Harwood, L. M. *Aldrichimica Acta* **1985**, *18*, 25.
13. Harwood, L. M.; Moody, C. J.; Percy, J. M. *Experimental Organic Chemistry, Standard and Microscale*, 2nd edn; Blackwells: Oxford; **2000**.
14. Casey, M.; Leonard, J.; Lygo, B.; Proctor, G. *Advanced Practical Organic Chemistry*; Blackie: Glasgow; **1990**.
15. (a) Flory, P. J. *J.Chem. Phys.* **1947**, *15*, 684. (b) Flory, P. J. *J.Chem. Phys.* **1949**, *17*, 223. (c) Flory, P. J. *Trans. Faraday Soc.* **1955**, *51*, 848.
16. Windle, A. H.; Viney, C.; Golombok, R.; Donald, A. M.; Mitchell, G. R. *Faraday Discuss.* 1985, **79**, 55.
17. Zhou, Q.-F.; Lenz, R. W. *J. Polym. Sci., Polym. Chem. Ed.* **1983**, *21*, 3313–3320.
18. He, Z.; Davis, F. J.; Olley, R. H.; Mitchell, G. R. *Polymer* **2001**, *42*, 5351–5363.
19. Perrin, D. D.; Armarego, W. L. F. *Purification of Laboratory Chemicals*, 3rd edn; Pergamon Press: New York; **1988**.
20. Furniss, B. S.; Hannaford, A. J.; Smith, P. W. G.; Tachell, A. R. *VOGEL's Textbook of Practical Organic Chemistry*, 5th edn; Longman Scientific: Essex, UK; 1988.
21. Bunn, A.; Griffin, B. P.; Macdonald, W. A.; Rance, D. G. *Polymer* **1992**, *33*, 3066–3072.

The formation of cyclic oligomers during step-growth polymerization

ABDERRAZAK BEN HAIDA, PHILIP HODGE,
and HOWARD M. COLQUHOUN

1. Introduction

Step-growth polymerization is controlled both by the efficiency of the synthetic routes chosen (as indicated in Chapter 4) and by statistical considerations. In particular, the formation of the desired polymer is almost always accompanied by a cyclic oligomer fraction.^{1,2} As the dilution increases,³ the chances of cyclization also increase, since polymerization is a second-order process involving the reaction between linear species, whereas cyclization, involving the (intramolecular) reaction between the two ends of a linear molecule, is inherently a first-order process. Cyclization is a particular feature of the early stages of a step-growth polymerization (up to extents of reaction of 98–99%), where a proportion of the end groups that react are on the same molecule. Hence, cyclics form. Since the chances of meeting of the end groups decrease rapidly as the distance between them increases, the cyclics are of relatively low molecular weight, that is, they are oligomers. Further reaction leads mainly to linear molecules, although at *extremely* high conversions the number of end groups is quite small and intramolecular reactions essentially terminate the process, such that it might be expected that all chains ultimately cyclize.^{4,5} Practically though, the levels of conversion necessary to obtain these very large rings are extremely high and difficult to obtain (either by virtue of side reactions, monomer imperfections, or simply the level of viscosity of high molecular weight polymer solutions). What is usually obtained, therefore, is a mixture of cyclics and linear molecules. However, since cyclic oligomers often differ considerably in, for example, solubility compared to their high molar mass linear homologues, separation is often relatively straightforward.⁶

The commercial importance of polymers produced by step-growth polymerization gives a particular significance to understanding the nature of such

materials. The presence of cyclic oligomers can be detrimental to the polymer properties since their presence could cause problems during processing. For instance, cyclic oligomers of polyethylene terephthalate (PET) tend to migrate to the surface of spun fibres and, under certain conditions, they crystallize to produce a surface 'bloom' which interferes with subsequent dyeing. More recently, it is the reverse of cyclization, namely ring-opening polymerization, which has been a particular focus of attention. Such ring-opening polymerizations offer an attractive route to high performance polymers,⁷ particularly in view of the low viscosity of the oligomeric precursors, the absence of volatile by-products and the fact that for non-strained rings the polymerization is entropically driven and essentially thermally neutral.

A range of sophisticated techniques has been used to synthesize cyclic systems,⁸ in particular, with regard to supermolecular chemistry.⁹ However, a statistical approach based on high dilution has the advantage of simplicity, this makes this approach particularly attractive for commercial processes, where large-scale production may be required. Unfortunately, very dilute solutions allow the synthesis of only small amounts of products, and thus for most synthetic work an influxion procedure is usually more practical. In the pseudo-high-dilution method, the reactants are brought together at a rate that is lower than the rate of the reaction, and are subjected to rapid dispersion in a diluent. Typically, controlled slow addition is achieved using a precision dropping funnel or a syringe pump. The reactive chain concentration is maintained at a very low level, so that the reactive end groups will react intramolecularly (cyclization), rather than undergoing intermolecular condensation (chain extension). A pseudo-high-dilution reaction requires that reactive intermediates are rapidly diluted as they are introduced, favouring the formation of cyclics, and if the linking reactions are not reversible the final concentrations of products can be high. The rate of the condensation reaction must be high relative to the rate of reactant addition, so that reactant concentrations do not build up during the reaction. Provided that the rings so formed do not react further, high final concentration of cyclic materials (up to 1.0 M) can be obtained. This procedure corresponds to the Ruggli/Ziegler high-dilution technique. In the following account, the production of cyclic systems in several step-growth polymerizations is described, with particular emphasis on ways in which the amount of cyclic material can be maximized.

2. Synthesis and extraction of cyclic oligomers of poly(ether ketone)

Poly(ether ketone) (PEK) **1** is a crystalline high-performance aromatic polymer. It can be prepared in solution¹⁰ from the condensation of 4,4'-dihydroxybenzophenone with 4,4'-difluorobenzophenone, in the presence of anhydrous potassium carbonate, using diphenylsulfone as solvent at

5: Cyclic oligomers by step-growth polymerization

high temperature (310°C), as shown in Scheme 1. The reaction must be performed at high temperature to prevent premature crystallization of the polymer at only low molecular weight. After polymerization, the diphenylsulfone can be removed from the product by extraction with hot methanol. Material produced in this way still contains more than 10% of cyclic systems, which may be extracted with chloroform, since, as is often found for cyclic oligomers,⁶ they differ substantially in solubility from the parent polymer.

Protocol 1.

Synthesis of PEK and isolation of cyclic oligomers (Scheme 1)

Caution! Carry out all procedures in a well-ventilated fume-hood, wear appropriate disposable gloves, a lab-coat, and safety glasses. Never use flat-bottomed flasks on rotary evaporators.

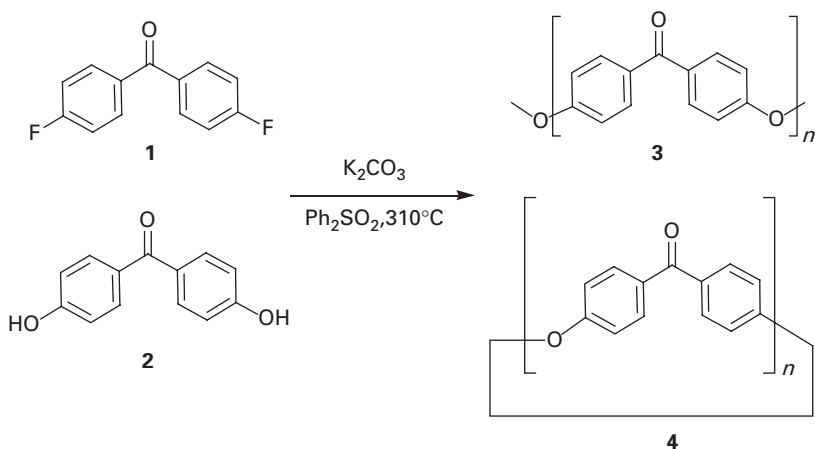

Scheme 1 Synthesis of PEK by reaction of 4,4'-dihydroxybenzophenone and 4,4'-difluorobenzophenone.

Equipment

- Dual manifold (nitrogen/vacuum)
- Three-necked round-bottomed flask (100 mL)
- Hot-plate stirrer and oil-bath
- Apparatus for filtration under reduced pressure: Buchner funnel, flask, and water aspirator
- Teflon-coated magnetic follower
- Source of dry nitrogen
- Condenser
- Erlenmeyer flask
- Apparatus for Soxhlet extraction, single-necked round-bottomed flask, Soxhlet extractor thimble and condenser
- Thermometer
- Nitrogen inlet

Protocol 1. Continued

- Aluminium sheet
- Heating mantle and sand-bath
- Mechanical stirrer, polished glass stirrer rod, paddle, and Teflon stirrer guide

Materials

- 4,4'-dihydroxybenzophenone, 2.0 g, 9.3 mmol **irritating to eyes, skin, and respiratory system**
- Anhydrous potassium carbonate, 1.70 g, 12.3 mmol **irritating to eyes, skin, and respiratory system**
- Diphenylsulfone, 13.30 g **harmful if swallowed, irritating to eyes, skin, and respiratory system**
- 4,4'-Difluorobenzophenone, 2.04 g, 9.3 mmol **Irritating to eyes, skin, and respiratory system**
- Chloroform, ca. 100 mL **harmful by inhalation, and if swallowed, potential carcinogen**
- Methanol, ca. 300 mL **toxic by inhalation and if swallowed, highly flammable**

Method

1. A 100 mL three-necked round-bottomed flask is equipped with a condenser, fitted with a nitrogen inlet, a mechanical stirrer, and a thermometer. To this flask is added a mixture of 4,4'-dihydroxybenzophenone (2.0 g, 9.3 mmol) and anhydrous potassium carbonate (1.70 g, 12.3 mmol) in diphenylsulfone (13.30 g).^a
2. The flask is placed in a sand-bath contained in a heating mantle and the reaction mixture is vigorously stirred at 200°C under a nitrogen atmosphere for 1 h. Then 4,4'-difluorobenzophenone (2.04 g, 9.3 mmol) is added rapidly and the temperature is gradually raised to 310°C and held at this temperature for 3 h.
3. When the polymerization is complete, the hot viscous mixture is poured onto a clean aluminium sheet and allowed to cool. A toffee-like solid is formed. This is collected and milled to a powder. The powder is then extracted with refluxing methanol (2 × 150 mL portions) in order to remove the diphenylsulfone. The fine powder that remains is washed with water and then methanol, and dried to give the crude product (3.41 g, 93%).
4. To isolate the cyclic material, the crude product is extracted with chloroform. A sample of the crude product (1.50 g) is placed in a Soxhlet thimble, and extracted with chloroform for 24 h. The chloroform is removed on the rotary evaporator to give cyclic oligomers.^{b,c}

^aThis material acts as a solvent at the temperature of the polymerization (m.p. 127–129°C, b.p. 379°C).

^bThe sample obtained had $\eta_{inh} = 0.65$ dL/g (H_2SO_4); $T_g = 152^\circ C$ and $T_m = 370^\circ C$. The molecular weight can be estimated by partial reduction of a small portion of polymer **3** with triethylsilane and trifluoroacetic acid to give a sample in which 68% of the carbonyls have been reduced (by 1H NMR). This material is soluble in dimethylacetamide (the sample had $M_n = 8400$ and $M_w = 13\,900$ by GPC).

^c13% w/w of total product; GPC shows this fraction to consist of cyclics from the trimer up to the octamer.

5: Cyclic oligomers by step-growth polymerization

The preparation of PEK in solution makes the formation of rings more likely than, for example, in melt polymerizations, such as those described in Chapter 4. In principle, the proportion can be increased substantially, however, by using conditions that keep the concentration of reactive chain ends low. As noted above, low concentrations are, at best, inconvenient on a laboratory scale, and certainly would not be amenable to scale-up for commercial production. However, if the monomer is introduced slowly, such that it reacts more rapidly than the rate of addition, then intramolecular reaction is favoured. The situation is complicated by the possibility of a reversible fluoride-induced cleavage of the oxygen–phenyl bond, so that if the fluoride ion stays in solution there is a possibility that the open-chain form and the cyclic form may equilibrate.¹¹ Nevertheless, the following procedure shows how this approach may be used to isolate cyclic oligomers of PEK.¹² The reaction involves the intramolecular reaction of 4-fluoro-4'-hydroxybenzophenone **5** (itself produced from 4,4'-difluorobenzophenone **1** as shown in Scheme 2) in a mixture of NMP and toluene in the presence of sodium carbonate (Scheme 3). The process gives a high yield of cyclic material. Such rings may then be polymerized by reaction with the potassium salt of 4-hydroxybenzophenone at 385°C.¹²

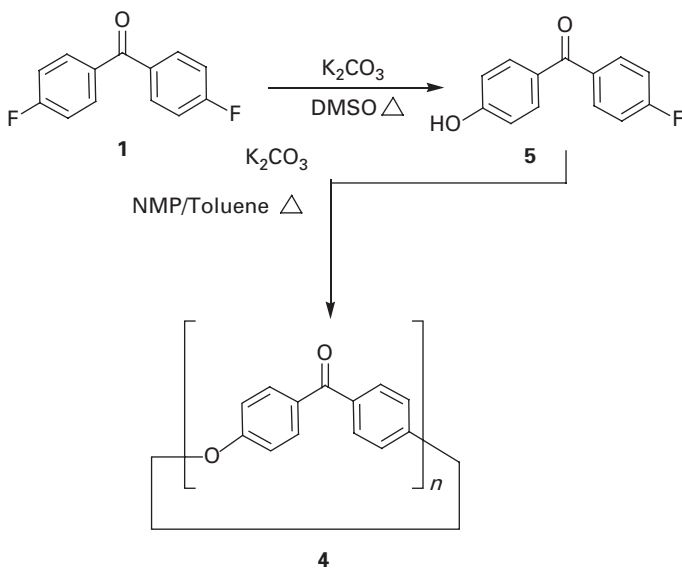

Scheme 2 Synthesis of PEK with a high concentration of macrocycles.

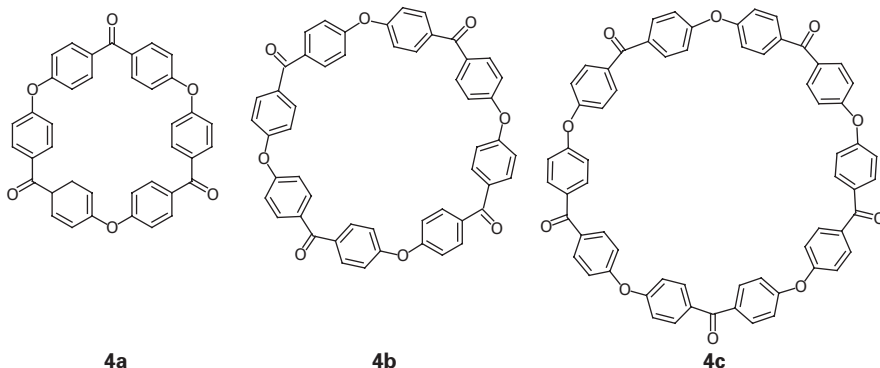

Scheme 3 Cyclic oligomers synthesized from 4-fluoro-4'-hydroxybenzophenone.

Protocol 2.

Synthesis of cyclic oligomers of PEK under pseudo-high-dilution conditions

Caution! Carry out all procedures in a well-ventilated fume-hood, wear appropriate disposable gloves, a lab-coat, and safety glasses. Never use flat-bottomed flasks with rotary evaporators.

Equipment

- Dual manifold (nitrogen/vacuum)
- Nitrogen inlet
- Hot-plate stirrer and oil-bath
- Apparatus for filtration, Buchner funnel and flask, water aspirator
- Three-necked round-bottomed flask (500 mL)
- Teflon-coated magnetic follower
- Dean–Stark trap
- Thermometer
- Erlenmeyer flasks (various sizes)
- Source of dry nitrogen
- Condensers
- TLC plate (with fluorescent indicator)
- Apparatus for Soxhlet extraction, single-necked round-bottomed flask, Soxhlet extractor thimble and condenser
- Single-necked round-bottomed flask (500 mL)
- Separating funnel (500 mL)
- Syringe pump
- Vacuum oven
- Chromatographic column

Materials

- 4,4'-Difluorobenzophenone, 15.0 g, 68 mmol
 - 4-fluoro-4'-hydroxybenzophenone, 5.00 g, 23 mmol
 - Sodium hydroxide, 5.44 g, 136 mmol
 - DMSO, 150 mL
 - Hydrochloric acid, 150 mL of 20%
 - Anhydrous potassium carbonate, 2.00 g, 14.7 mmol
 - Dichloromethane, ca. 100 mL
 - Toluene (for reaction and recrystallization)
- irritating to eyes, skin, and respiratory system**
irritating to eyes, skin, and respiratory system
causes burns
harmful if taken internally, irritating to eyes
causes burns, irritating to respiratory system
irritating to eyes, skin,
and respiratory system
harmful by inhalation, potential carcinogen
highly flammable, harmful by inhalation

5: Cyclic oligomers by step-growth polymerization

- Silica (particle size of 0.040–0.063 nm)
- *N*-Methyl-2-pyrrolidone (NMP), 300 mL
- Methanol, 600 mL
- Chloroform for extraction and chromatography
- Ethyl acetate for chromatography

harmful by inhalation, irritating to respiratory system
harmful, possible reproductive toxin
toxic by inhalation and if swallowed, highly flammable
harmful by inhalation, and if
swallowed, potential carcinogen
highly flammable

Method

1. To a single-necked round-bottomed flask equipped with a condenser, a Teflon-coated magnetic follower and inlet to the double manifold is added a mixture of 4,4'-difluorobenzophenone (15.0 g, 68 mmol), sodium hydroxide (5.44 g, 136 mmol), water (35 mL), and DMSO (150 mL).
2. The flask is evacuated, placed under a nitrogen atmosphere, and stirred vigorously at 60°C for 2 h. The temperature is then raised to 70°C and stirring continued for a further 20 h.
3. The mixture is cooled to room temperature and then added, with vigorous stirring, to an Erlenmeyer flask containing cold water (300 mL). In a separating funnel (500 mL), the solution is washed with dichloromethane (2 × 75 mL). The aqueous layer is collected and acidified with hydrochloric acid (150 mL of 20%). The white precipitate is collected by filtration at the water aspirator, washed with water and dried at 60°C. The product is purified by recrystallization from toluene.^a
4. A 500 mL three-necked round-bottomed flask is equipped with a Dean–Stark trap, a condenser, a thermometer, and a nitrogen inlet. To this flask is added anhydrous potassium carbonate (2.00 g, 14.7 mmol), NMP^a (250 mL), and toluene (45 mL). The solution is purged with nitrogen, stirred vigorously, and the temperature is raised to 145–150°C.
5. A solution of 4-fluoro-4'-hydroxybenzophenone (5.00 g, 23 mmol) in NMP (45 mL) is added over a 24 h period using a syringe pump.^b When addition is complete, the reaction is stirred for a further hour at 145–150°C and then cooled to room temperature.
6. The reaction mixture is added slowly to cold methanol (300 mL). A white precipitate forms. The precipitate is collected by filtration at the water aspirator, washed with water (300 mL) and then methanol (300 mL). Finally, the product is dried in a vacuum oven at 70°C.
7. A portion of the crude product from step 3 above is then placed in a Soxhlet thimble and extracted with chloroform for 24 h. The chloroform is removed on the rotary evaporator to give a product consisting essentially of cyclic oligomers.^c
8. Individual cyclic oligomers are isolated from the crude product from step 7 by extracting with dichloromethane and subjecting this extract to column chromatography on silica gel^d using gradient elution; a mixture of chloroform and ethyl acetate can be used starting with a low proportion of the more polar ethyl acetate (0.5%) and finishing with a slightly larger

Protocol 2. Continued

quantity (2%). This procedure yields the trimer, tetramer, and pentamer (structures shown in Scheme 3).^e

^aYield 12.60 g (86%), m.p. 168°C, NMP is freshly distilled from calcium hydride.

^bThis allows the addition of reagents at a slow rate such that the concentration is kept low at all times; at the same time the Dean–Stark trap facilitates the removal of water and drives the reaction towards oligomer formation.

^cTypical yield of cyclic material 79%; GPC indicates trimer 12%, tetramer 33%, pentamer 9%, hexamer 9%, heptamer 7%, octamer 7%, and nonamer 1%.

^dMerck silica gel 60 of particle size of 0.040–0.063 nm.

^eThe oligomers are obtained in varying quantities from 50 to 200 mg. For the trimer and tetramer, crystals suitable for X-ray analysis may be grown.

3. Synthesis of some sulfone-linked paracyclophanes from macrocyclic thioethers

Poly(1,4-phenylenesulfone) has an exceptionally high melting point, believed to be in excess of 500°C.¹³ Clearly, processing such material represents an enormous challenge. Consequently, the polymer represents an attractive target for a precursor route based on the ring-opening polymerization of cyclic oligomers. Thus, the development of cyclic precursors to such materials is a topic of great interest. In this section, a route to such a system is described.^{14,15} It involves three steps: the first is the synthesis of 4,4'-thiobis(benzenethiol) **8**, by chlorosulfonation of diphenylsulfide followed by reduction as outlined in Scheme 4, the second is the nucleophilic condensation polymerization of this dithiol with and 4,4'-dichlorodiphenylsulfone **9** under conditions of high dilution; finally, the resulting macrocycles are oxidized to sulfone-linked paracyclophanes. In this way, cyclic systems containing 4, 8, 12, 16, and 20 benzene rings can be produced.*

Protocol 3.

Preparation of 4,4'-thiobis(benzenethiol)(Scheme 4) and polymerization with 4,4'-dichlorodiphenylsulfone under conditions of high dilution (Scheme 5)

Caution! Carry out all procedures in a well-ventilated fume-hood, wear appropriate disposable gloves, a lab-coat, and safety glasses.

* In principle, cyclic systems with six units cannot be formed directly in this reaction, however, in a related reaction in which the oxidized form of **8**, that is 4,4'-sufonylbis(benzene thiol) is reacted with 4,4'-dichlorodiphenylsulfone, the cyclic system containing six aromatic rings has been found to predominate. This arises by intramolecular displacement of a bridging thioether group rather than a terminal halide.¹⁴

5: Cyclic oligomers by step-growth polymerization

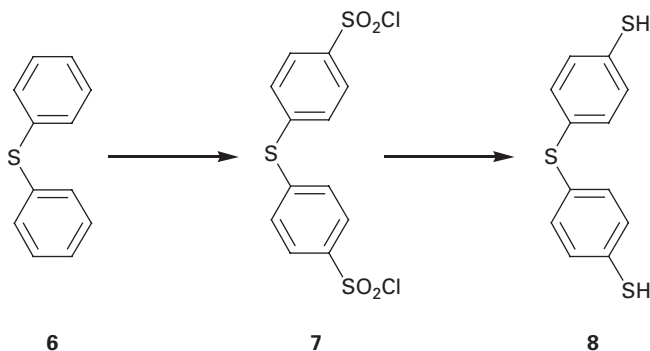

Scheme 4 Synthesis of 4,4'-thiobis(benzenethiol).

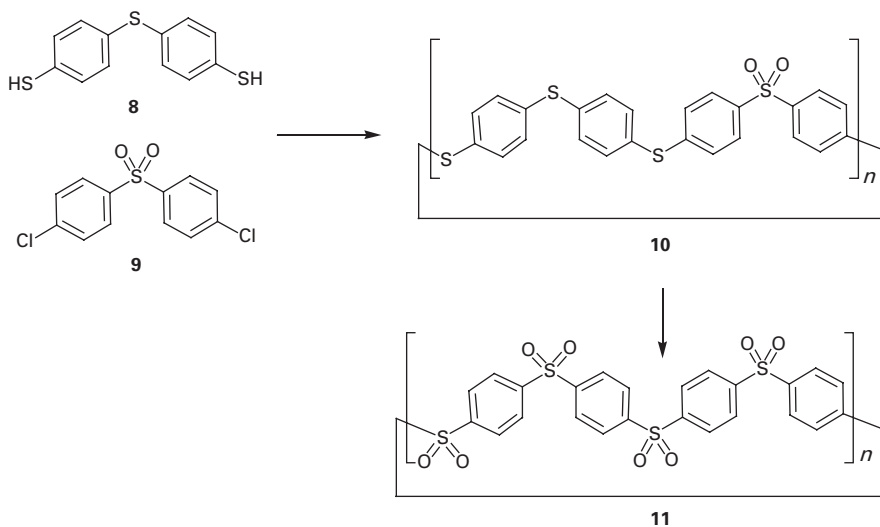

Scheme 5 Synthesis of macrocyclic thioether sulfones and their oxidation to sulfone-linked paracyclophanes.

Equipment

- Three-, two-, and single-necked round-bottomed flasks (500 mL, 1 L, 100 mL, respectively)
- Hot-plate stirrer and oil-bath
- Gas inlet and gas outlet
- Apparatus for filtration, Buchner funnel and flask, water aspirator
- Dean–Stark trap
- Chromatography column
- Teflon-coated magnetic follower
- Condenser
- Dropping funnel (pressure-equalizing)
- Erlenmeyer flasks (various sizes)
- Thermometer
- Vacuum oven

Protocol 3. Continued

Materials

- Diphenylsulfide, 15.0 g, 80.0 mmol
 - Chlorosulfonic acid, 30 mL
 - Silica gel for chromatography
 - THF
 - Stannous chloride dihydrate, 100 g, 450 mmol
 - Glacial acetic acid, ca. 500 mL
 - Anhydrous hydrogen chloride
 - Hydrochloric acid (concentrated), 150 mL
 - NaOH (5%), 200 mL
 - Anhydrous potassium carbonate, 2.40 g, 17.2 mmol
 - Dimethylacetamide, 200 mL
 - Toluene, 45 mL
 - 4,4'-Dichlorodiphenylsulfone, 2.47 g, 8.63 mmol
 - Trifluoroacetic acid, 12 mL
 - Hydrogen peroxide (30% aqueous solution), 10 mL
 - Chloroform for extraction and chromatography
 - Ethyl acetate for chromatography
- harmful if inhaled, irritant oxidizer, corrosive, causes severe eye, nose, and throat burns, toxic by inhalation
- harmful by inhalation, irritating to respiratory system
- highly flammable, may form peroxides, irritating to eyes and respiratory system
- irritant, may cause burns, harmful by inhalation, skin absorption, and if swallowed
- flammable, causes severe burns
- causes severe burns, irritating to respiratory system
- causes severe burns, irritating to respiratory system
- causes burns
- irritating to eyes, skin, and respiratory system
- harmful by inhalation and in contact with the skin, irritating to eyes
- highly flammable, harmful by inhalation
- treat as harmful
- harmful by inhalation, causes severe burns
- oxidant, causes burns
- harmful by inhalation, and if swallowed, potential carcinogen
- highly flammable

Method

1. To a single-necked round-bottomed flask equipped with a magnetic stirrer and a gas outlet tube which is connected to a water trap^a is added diphenyl sulfide (15.0 g, 80.0 mmol) and chlorosulfonic acid (30 mL). The mixture is stirred at room temperature for 8 h.
2. The solution is then cautiously quenched in ice water, whereupon a white precipitate is obtained. This precipitate is quickly filtered off and washed with chilled water until neutral.
3. The white crude product is dried in a vacuum oven at 60°C, and then purified by column chromatography over silica gel using THF as the eluent to give 4,4'-thiobis(benzenesulfonylchloride).^b
4. A two-necked round-bottomed flask is equipped with a magnetic stirrer, a condenser, a gas inlet tube, and a gas outlet tube; the gas inlet tube is connected to a source of anhydrous HCl^c and the outlet tube as in note *a*.
5. Stannous chloride dihydrate (100 g, 0.45 mol) and glacial acetic acid (400 mL) are added to the flask and the mixture is heated to 50°C and stirred while anhydrous hydrogen chloride is bubbled into the flask, until the mixture is saturated.^d
6. When all the stannous chloride has dissolved, 4,4'-thiobis(benzenesulfonylchloride) **7** (10 g, 0.026 mol) is added quickly to the stirred solution under a flow of anhydrous hydrogen chloride. The solution is then heated at 80°C for 24 h, and refluxed for 3 h.

5: Cyclic oligomers by step-growth polymerization

7. Upon cooling to room temperature, bright yellow crystals precipitate from the solution. This precipitate is dissolved in 5% NaOH (200 mL), and the solution filtered through a sintered-glass funnel into hydrochloric acid (concentrated, 150 mL). The collected solid is then dried and recrystallized from glacial acetic acid to give yellow crystals of 4,4'-thiobis(benzenethiol) **8**.^e
8. A 500 mL three-necked round-bottomed flask is equipped with a magnetic follower, a thermometer, a dropping funnel (pressure-equalizing), a Dean–Stark trap, condenser, and nitrogen inlet. To this flask is added anhydrous potassium carbonate (2.40 g, 17.2 mmol), dimethylacetamide (200 mL), and toluene (45 mL). The solution is purged with nitrogen, the suspension of potassium carbonate is stirred vigorously, and the flask is heated in the oil-bath such that the toluene is refluxing.
9. A mixture of 4,4'-dichlorophenylsulfone **9** (2.47 g, 8.63 mmol) and 4,4'-thiobis(benzenethiol) **8** (2.16 g, 8.63 mmol) dissolved in dimethylacetamide (100 mL) is added drop-wise over 5 h to the stirred refluxing suspension. On completion of the addition, the toluene is removed (this can be done using the Dean–Stark trap) and the temperature of the reaction is raised to 155°C and maintained at this temperature for a further 15 h.
10. The mixture is allowed to cool, filtered to remove the precipitated salts, and the filtrate concentrated to about 60 mL.^f
11. The resulting precipitate is then collected by filtration at the water aspirator, washed with water until all the acid is removed (i.e. the washing is neutral when tested with pH paper), and then suspended in methanol in a single-necked round-bottomed flask equipped with a condenser and a magnetic follower. The mixture is then stirred at 60°C for 30 min. The solid is collected by filtration at the water aspirator, and then dried in a vacuum oven at 70°C for 12–15 h.
12. The product from step 11 contains a mixture of cyclic oligomers. These can be separated by column chromatography on silica using mixtures of ethyl acetate and chloroform (gradually increasing the ethyl acetate concentration).^g
13. The isolated cyclic oligomer (0.25 g) is suspended in trifluoroacetic acid (12 mL) in a single-necked round-bottomed flask equipped with a condenser and a magnetic follower. The suspension is heated to 60°C with stirring and a solution of 30% aqueous hydrogen peroxide (10 mL) is added over a period of 15 min.
14. The temperature of the reaction is then raised to 80°C and heating continued for 3 h at 80°C. The mixture is then cooled and the product collected by filtration at the water aspirator. Finally, the recovered solid is washed with water and methanol, and dried in the vacuum oven at 100°C.

^aLarge quantities of hydrogen chloride should not be vented directly into the fume-cupboard; usually the acid can be scrubbed by passing into water. It is vital that the water at the outlet cannot enter the reaction flask. An inverted funnel placed in a beaker of water such that it dips just below the surface is suitable here.

^bYield 24.5 g, 80%, m.p. 156°C.

Protocol 3. Continued

^cAnhydrous hydrogen chloride gas can be generated by adding drop-wise concentrated sulfuric acid (80 mL) to NaCl (100 g).

^dThe well-known procedure using zinc dust and acid gives only very poor yields.

^eYield 5.20 g, 80%, m.p. 110°C (by DSC).

^fFor example, by distillation under reduced pressure.

^gYields of cyclic compounds **10**: $n = 1$, 0.25% (m.p. 362°C); $n = 2$, 9% (m.p. = 374°C), $n = 3$, 4.5% (m.p. 158°C), $n = 4$, 1% ($T_g = 134^\circ\text{C}$), $n = 5$, 0.6% ($T_g = 128^\circ\text{C}$).

4. Summary

Cyclic systems are inherently produced in step-growth polymerizations. Oligomeric materials can be produced using pseudo-high-dilution conditions; that is, by slow addition of reacting monomer to the polymerization reaction. This provides a powerful tool for dramatically increasing the yields of cyclics (provided equilibration processes do not come into play). The cyclic systems produced have considerable potential as feedstocks for entropically-driven ring-opening polymerizations.¹⁶

References

1. Semlyn, J. A., ed., *Cyclic Polymers*; Elsevier: New York; **1986**.
2. (a) Maravigna, P.; Montaudo, G. In *Comprehensive Polymer Science*; Allen, G.; Bevington, J. C., eds, Pergamon: Oxford; **1989**, Vol. 5, pp. 63–90. (b) Suter, U. R. In *Comprehensive Polymer Science*; Allen, G.; Bevington, J. C., eds, Pergamon: Oxford; **1989**, Vol. 5, pp. 91–96.
3. Fawcett, A. H.; Mee, R. A. W.; McBride, F. W. *Macromolecules* **1995**, *28*, 1481.
4. Kricheldorf, H. R.; Rabenstein, M.; Maskos, M.; Schmidt, M. *Macromolecules* **2001**, *34*, 713–722.
5. Kricheldorf, H. R. *Macromolecules* **2003**, *36*, 2302–2308.
6. (a) Bryant, J. J. L.; Semlyen, A. J. *Polymer* **1997**, *38*, 191. (b) Bryant, J. J. L.; Semlyen, A. J. *Polymer* **1997**, *38*, 4531.
7. Hodge, P.; Colquhoun, H. M.; Williams, D. J. *Chem. Ind. (London)* **1998**, 162.
8. Parker, D., ed., *Macrocyclic Synthesis: A Practical Approach*; Oxford University Press: Oxford; **1996**.
9. Steed, J. W.; Atwood, J. L. *Supramolecular Chemistry*; Wiley: Chichester; **2000**.
10. Staniland, P. A. In *Comprehensive Polymer Science*; Allen, G.; Bevington, J. C., eds, Pergamon: Oxford; **1989**, Vol. 5, p. 492.
11. Colquhoun, H. M.; Lewis, D. F.; Hodge, P.; Ben-Haida, A.; Williams, D. J.; Baxter, I. *Macromolecules* **2002**, *35*, 6875–6882.
12. Ben-Haida, A.; Colquhoun, H. M.; Hodge, P.; Williams, D. J. *J. Mater. Chem.* **2000**, *10*, 2011–2016.
13. Robello, D. R.; Ulman, A.; Urankar, E. J. *Macromolecules* **1993**, *26*, 6718–6721.
14. Baxter, I.; Ben-Haida, A.; Colquhoun, H. M.; Hodge, P.; Kohnke, F. H.; Williams, D. J. *Chem. Eur. J.* **2000**, *6*, 4285–4296.
15. Baxter, I.; Colquhoun, H. M.; Hodge, P.; Kohnke, F. H.; Williams, D. J.; *Chem. Commun.* **1998**, 283–284.

5: Cyclic oligomers by step-growth polymerization

16. (a) Brunnelle, D. J.; Shannon, T. G. *Macromolecules* **1991**, *24*, 3035. (b) Miyatake, K.; Yokoi, Y.; Yamamoto, K.; Tsuchida, E.; Hay, A. S. *Macromolecules* **1997**, *30*, 4502. (c) Chen, M.; Gibson, H. W. *Macromolecules* **1996**, *29*, 5502. (d) Colquhoun, H. M.; Lewis, D. F.; Fairman, R. A.; Baxter, I.; Williams, D. J. *J. Mater. Chem.* **1997**, *7*, 1.

The synthesis of conducting polymers based on heterocyclic compounds

DAVID J. WALTON, FRED J. DAVIS, and PHILIP J. LANGLEY

1. Introduction

Polymers are best known for their effectiveness as electrical insulators, indeed electrical wiring throughout the world is now sheathed in plastic. However, it was recognized early on that polymers with an appropriate structure ought to be able to conduct electricity. Unfortunately, the same features that might allow this phenomenon also introduce intractability and processing difficulties. As a consequence, it was not until the mid-1970s that the potential of these materials was explored and better-defined materials started to be made. There are now numerous polymers with substantial electrical conductivities and the topic of electrically conducting polymers still continues to excite with many hundreds of new publications printed each year. The backbone structures of some of conjugated polymers are given in Table 6.1. In this chapter we shall deal with electrochemical and chemical syntheses of some relatively simple examples.

For electrical conductivity, it is necessary to transfer charge along a conjugated chain, between chains, and also along grain boundaries or between particles. The most energetically difficult process will control the rate of charge transport and this will vary with nature of the polymer, its physical form, and other parameters, but in all cases conjugation along the chain is necessary although it is not sufficient for carbonaceous polymers to simply possess a conjugated chain. To promote conductivity π -overlap along the entire polymer chain length is required to give a half-filled band of delocalized π -electrons. In real systems, distortions of the bonds disrupt the conjugation, and the materials are generally semiconductors. The higher metallic conduction can be achieved by a process known as doping in which electrons are added or more generally removed from the conjugated system (although this is not same as the doping process found in semiconductor technology)

The simplest conjugated polymer chain is a polyacetylene chain. Such materials can be prepared by coordination polymerization,¹ or using a

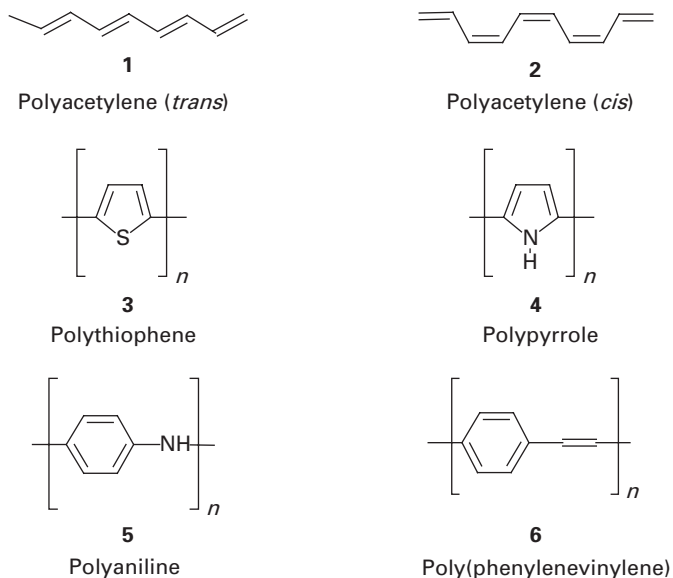
Table 6.1 Some polymer backbone structures forming the basis for conducting materials*

* In the conducting form these are generally polycationic, charge compensated by anions that originate from the oxidising medium.

sophisticated route involving the degradation of a soluble precursor polymer.² There are particular issues such as long-term stability that have to date mitigated against the commercialization of polyacetylene, although the related polymer poly(phenylenevinylene) (PPV) has attracted attention because of its photophysical properties, particularly as the basis of a polymer light-emitting diode (LED), in which an electrical signal is converted into the emission of light.³ A range of other organic polymers can also be prepared, in particular through the oxidation of electron-rich aromatic heterocycles such as pyrrole. Polypyrrole (and related heteroaromatic materials such as polyaniline and polythiophene) can be readily prepared in the polycationic form through either chemical⁴ or electrochemical⁵ oxidation of the appropriate monomer to give flexible, free-standing films that are stable in air. Some of these procedures are extremely simple, and a number of examples are given below. First, however, a brief introduction to the principles of electrochemical synthesis is included.

2. Electrochemical synthesis

The preparation of polypyrrole, polythiophene, polyaniline, and related conducting polymers demonstrates principles of electrochemical synthesis that are more widely applicable, and it is instructive to examine these in detail.

An electrochemical cell is part of the complete electrical circuit of the system and thus electrons must travel through it just like any other electrical component. It has a resistance, and under altering or variable current and voltage conditions it will have a capacitance. To transverse the cell, electrons must leave the cathode leaving a reduced (electron-rich species) in the cell, while simultaneously electrons must pass into the anode from a species in the cell that becomes oxidized (electron-poor). To complete the circuit ions must cross the cell (cations towards the cathode competing with anions towards the anode).

Clearly, the energy necessary to pass electrons right across the cell involves the inherent energetics of electron transfers at both electrodes ('electrode potentials' of the processes involved) and a component relating to mass transport, which involves the diffusion of species to and from the electrode as well as the mobility of ions crossing the centre of the cell. Highly oxidized and reduced species are simultaneously formed, however we may only be interested in one of these, and because they could react together unfavourably if allowed to meet, we may keep them apart by a semi-permeable membrane between the cell compartments. This will increase the overall cell resistance to some extent and will affect the cell voltage required to maintain electrolysis.

Now if there were two highly reactive species (for the oxidation and reduction process), it would require only a low voltage to drive the two electrode reactions.* In fact a battery is a device that contains species that are sufficiently reactive so that instead of needing any externally supplied voltage to move electrons, the electrons are driven externally under the energy of reaction. Alternatively, two unreactive species (or even just one, if sufficiently unreactive) will require a higher voltage for electrolysis.

The upshot is that the measured voltage necessary to drive a cell with the minimum two electrodes is a complex mixture of potentials at both electrodes together with various voltage losses in the system, and we do not know, if the required voltage should suddenly be seen to rise after a period of electrolysis, whether this is due to some time-dependent effect at the anode, the cathode or elsewhere in the system.

Since the measured voltage in the above arrangement is ambiguous, it is common to run a two-electrode cell at constant current, so that the number of electrons being transferred in unit time is known, and the charge passed during electrolysis, which is an important figure of merit to be monitored, is simply the product of the constant current and the time of passing. This is procedurally simple, requiring only a straightforward power source as apparatus, but there may be complexities in interpretation of results. The electrolysis mixture contains a solvent, an electrolyte salt, and the electroactive species of interest; and although initially this electroactive species will necessarily be chosen to be the most reactive, as time goes by and the species becomes

* The voltage between the two electrodes in a simple cell of this type is highly dependent upon a number of factors and more usually a three-electrode cell containing a chemical standard is used (see text).

depleted, in order to maintain constant current the power source will increase its applied voltage so that another species will start to react. This could be the solvent, for instance, forming disadvantageous by-products. One way to spot this happening is to note the rise in cell voltage if the power source has a read-out to display the voltage it is delivering to maintain current (or else the operator should make sure there is a voltmeter in parallel across the cell). However, a voltage rise could indicate depletion at the counter-electrode, partial fouling of a cell membrane or some other effect that does not compromise the reaction of interest at the working electrode. Furthermore, it may be that the operator has selected too high a current density (current per unit area of electrode) perhaps even from the start of electrolysis, such that the concentration and diffusion properties of the desired electroactive species cannot maintain this current value. In this case other processes will interfere.

Now, this is not usually a problem for producing polypyrrole and related polymers, since a typical film on the electrode weighs only some tens of milligrams, and an electrolyte containing, for example, 0.01 M pyrrole can support its formation without appreciable depletion of the monomer. Constant-current electrolysis is therefore often used for these polymers; although it should be noted that the exact properties of the film can vary with preparation conditions, and with this methodology the exact electrode potential is not known.

There is a further consideration for the two-electrode or constant-current (galvanostatic) situation, in that an unusual electrode material such as conductive indium–tin oxide, some other semiconductor or even another conducting organic compound, which it may be desired to coat in the conducting polymer, may not be able to operate at too high a current density (such that electrochemical damage to the electrode occurs instead of the desired reaction). If the electrode metal is itself reactive such as aluminium, copper, and iron, (and this can be a particular problem for oxidations) then transformation of the electrode material can compete with the desired reaction. This is rarely a problem for a highly conducting noble metal electrode such as platinum, which can tolerate high current densities.

One benefit of the constant-current methodology, however, is that the total charge Q passed (an important parameter when there are known amounts of electroactive species) can be quantified simply by knowing the time t for which constant current i has passed since ($Q = i \times t$).

The problems with the two-electrode methodology described above can be overcome by careful control of the electrode potential at the working electrode. This is, after all, the most important parameter in an electrolysis, and if all electrons are transferred at the same energy, then only the reaction of choice will take place. To do this requires an additional electrode, which is a reference electrode against which potentials can be measured. The three-electrode configuration requires more complex electrochemical apparatus called a potentiostat.

The principle is analogous to the situation in a thermal reaction in which a heating mantle is simply turned to a particular setting and the apparatus

allowed to heat up. A more accurate means of control is to employ a digital thermometer that gives feedback to the heater so that, if, for example, a temperature of 60°C is desired inside the reaction flask, then continuous comparison of the heated solution with the calibrated reference temperature device allows this value to be maintained. This is the equivalent of a three-electrode electrolysis, in which there is continuous comparison between a thermodynamically reversible standard reference potential and the potential of the working electrode to maintain a set value.

A typical reference couple is the normal hydrogen electrode (NHE) in which the reaction is $\text{H}^+ + \text{e} = \frac{1}{2}\text{H}_2$ at a catalytic surface such as platinum black. However, this involves the cumbersome procedure of bubbling hydrogen gas (usually from a gas cylinder with important safety consequences) into the electrolysis cell, so more commonly used reference electrodes are saturated calomel [Hg(I)/Hg(0)] (standard calomel electrode or SCE) or silver silver chloride [Ag(I)/Ag(0)], which are conveniently fabricated in glass tubes that may be capped by a glass frit or a salt bridge. The different standard reactions have different chemical potentials and so it is always important to state which reference electrode is used when quoting voltages. Strictly, the reference electrode should be infinitely close to the working electrode, but not touching it. In practical terms, the electronic make-up of a potentiostat allows very high resistance in the reference electrode circuit, so that effectively only a minuscule current flows (this is necessary to keep the reference couple within the conditions of exact thermodynamic reversibility) and so the tip of the reference electrode need not be in such close proximity to the working electrode surface after all, especially in a conductive solution such as an aqueous one where there is not so great a resistance drop across the distance between the two electrodes as there is elsewhere in the reference electrode circuit.

The working and reference electrodes are thus poised at a set potential, which will be between ± 3 V, since almost the whole of organic electrochemistry occurs within this 6-V range. (These are true thermodynamic electrode potentials and +3 V corresponds roughly to the oxidation of benzene, while -3 V corresponds roughly to the reduction of benzene.) Pyrrole electro-oxidation typically takes place above +0.8 V (versus SCE reference).

However, the potential between the working and counter-electrodes will be higher than the set electrode potential between the reference electrode and the working electrode, reflecting the counter-electrode reaction and other processes requiring electrical energy. The important point is now that as the electroactive reagent becomes depleted with time the cell current will die away, eventually to nothing, without any higher-energy process occurring, and if for instance degradation of an indium-tin oxide electrode could be such a process then it will not occur. However, since in potentiostatic electrolysis the current is no longer at a fixed value, to quantify the charge passed either an integrating device such as a coulometer (coulomb meter) must be put in series with the cell or else a current-time plot must be recorded and the area underneath it calculated.

6: Conducting polymers from heterocycles

Potentiostatic electrolysis is a more sophisticated tool, necessary when there are competing processes with similar electrode potentials (only the lowest potential one can be achieved distinct from any others), and is essential when a dynamic method is required, for example ramping a voltage from one value to another and back again. This is a method used in the production of conducting polymers, particularly polyaniline, where better quality polymer films are obtained by this method. The range of electrochemical approaches available provides excellent flexibility for tuning the nature of the products, their doping levels and even their morphology. The wide range of heteroatomic systems available in this way is demonstrated by the general formula 7.

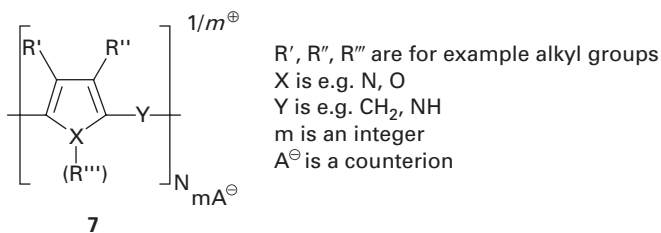

3. Synthesis of polypyrrole

This is without doubt the easiest conducting polymer to prepare electrochemically. Pyrrole will form a polymer on a wide variety of electrode materials, without great care over choice of potential if potentiostatic, or of current density if galvanostatic, in a wide variety of solvents including water, with a great range of electrolyte salts present (Scheme 1). Electrolysis may be terminated

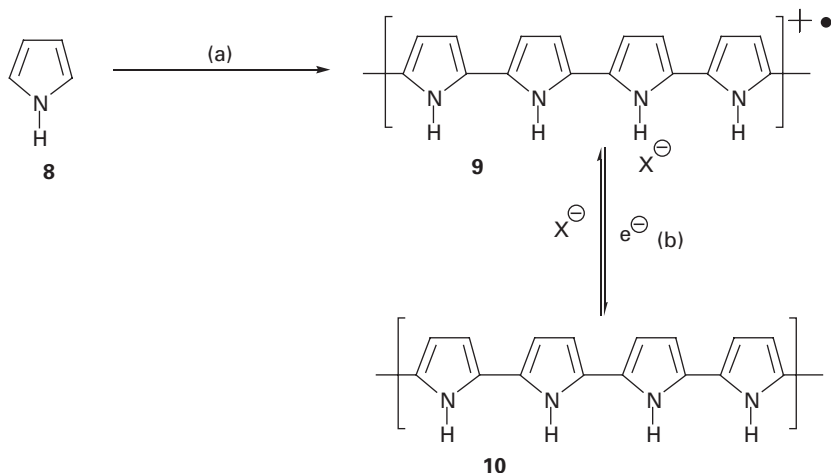

Scheme 1 (a) Electrochemical preparation of poly(pyrrole) and (b) separate redox between charged and uncharged forms.

to give an adherent electrode coating, or else continued until the film formed is thick enough to be peeled from the electrode.

Protocol 1. Electrochemical polymerization of pyrrole

Caution! Carry out all procedures in a well-ventilated fume-cupboard, wear appropriate disposable gloves, a lab-coat, and safety glasses.

Equipment

- Potentiostat
- Electrochemical cell with suitable electrodes, carbon rod, conducting glass electrode, SCE
- Volumetric flask (100 mL)
- Source of dry nitrogen
- Deionized water

Materials

- Pyrrole, 0.67 g, 10 mmol
 - Sodium *p*-toluenesulfonate, 1.94 g, 10 mmol
 - Calcium hydride
 - Deionized water
- flammable, harmful by inhalation, toxic if swallowed, risk of serious damage to eyes irritating to eyes and respiratory system contact with water liberates highly flammable gases**

Method

Preparation: pyrrole is distilled slowly from calcium hydride under reduced pressure prior to use and stored in the fridge in a brown bottle at 4°C.

1. Pyrrole (0.67 g, 10 mmol) and sodium *p*-toluenesulfonate(1.94 g, 0.01 mol)^a are added to a volumetric flask (100 mL), and water is added to up to the graduation.
2. The solution is poured into the electrochemical cell. This cell is flat bottomed and cylindrical in construction and has a gas inlet and two side-arms with female Quickfit joints into which are inserted two male joints terminated with sintered-glass frits. The conducting-glass electrode^b is then attached to a crocodile clip with a long wire contact, which is clipped so that the crocodile clip is above the surface of the liquid. The graphite rod and SCE are then placed in the side-arms provided (separated from the solution by a sintered-glass frit).
3. With the potentiostat on standby the electrodes are connected up to the correct outputs and the programme selected, for example, a potential of +1.0 V (versus SCE) is appropriate.
4. The potentiostat is switched on and a black film is seen to form on the electrode. Electrolysis is then continued for about 30 mins. The black film is then washed and peeled from the electrode for subsequent analysis.

^aPolar solvents are normally used; alternatives to water include, acetonitrile, propylenecarbonate, methanol, and tetrahydrofuran. Dimethylformamide is not so good but has been used despite some

6: Conducting polymers from heterocycles

early claims.⁶ In some circumstances, rather less polar solvents including dichloromethane might be used. For most organic solvents a tetraalkyl ammonium salt is usually used in place of the sodium or potassium salt; a wide variety of both tetraethyl and tetrabutyl ammonium salts are available from Sigma-Aldrich and other suppliers. The background electrolyte assists in the carrying of charge, and so it is important that an ionic salt is included. In addition, since the polymer will take up the anions from this salt, its nature is important. Sodium *p*-toluenesulfonate produces good quality films, which may have a degree of anisotropy in their amorphous structure.^{7,8}

^bConducting glass, platinum or any other inert material is recommended. However, the procedure is so simple that polypyrrole *p*-toluene sulfonate can be prepared as a lecture demonstration in a drinking glass using steel nails as electrodes powered by a battery.

^cFor galvanostatic operation, a current density (i.e. current per unit electrode area) up to 10 mA cm⁻² (but generally lower) is convenient. Better quality films (certainly in terms of anisotropy) can be obtained by scanning the voltage between 0 and 1.0 V or better still by applying a square-wave potential.⁷

Polypyrrole produced electrochemically may exhibit some structural organization, which can be probed by X-ray scattering, but additionally by neutron scattering.⁸ This latter technique requires the use of a deuterium-based polymer, to minimize inelastic scattering. The electrochemical polymerization is largely performed as above (with some modifications to allow the use of D₂O), and the monomer and dopant molecules can be synthesized at relatively low cost as outlined below. Pyrrole-d₅ is obtained by hydrogen–deuterium exchange in acidic D₂O, while the sulfonate salt is prepared by a standard preparation⁹ in which the protonated compounds are exchanged for the deuterated ones.

Protocol 2.

Electrochemical polymerization of pyrrole-d₅ doped with sodium *p*-toluenesulfonate-d₈.

Caution! Carry out all procedures in a well-ventilated fume-cupboard; wear appropriate disposable gloves, a lab-coat, and safety glasses.

Equipment

- Dual manifold nitrogen/vacuum
- Potentiostat
- Electrochemical cell with suitable electrodes, carbon rod, conducting glass electrode, SCE
- Three-necked round-bottomed flask
- Deionized water
- Gas-inlet adapter
- Overhead stirrer, stirrer rod, gland, and paddle
- Hotplate and oil-bath
- Source of dry nitrogen
- Volumetric flask (100 mL)
- Apparatus for filtration under reduced pressure: Buchner funnel, flask, and water aspirator
- Small-scale vacuum distillation apparatus
- Erlenmeyer flask (various sizes)
- Condenser
- Glove bag (Aldrich Atmosbag)
- Vacuum oven

Materials

- Pyrrole, 30 mL, 440 mmol
- Calcium hydride

flammable, harmful by inhalation, toxic if swallowed, risk of serious damage to eyes contact with water liberates highly flammable gases

Protocol 2. Continued

- Toluene- d_8 , 25 g, 250 mmol **highly flammable, harmful by inhalation**
- NaCl
- D_2O , 50 mL **high concentrations in the body can affect biochemical processes**
- DCl (conc. in D_2O), 0.5 mL **causes severe burns**
- D_2SO_4 , 25 g, 245 mmol **causes severe burns**
- $CaCl_2$ **irritating to eyes**
- Sodium carbonate **irritating to eyes**

Method

Preparation: Pyrrole is distilled slowly from calcium hydride under reduced pressure prior to use and stored in the fridge in a brown bottle at 4°C.

1. Under a blanket of nitrogen^a a single-necked round-bottomed flask equipped with a Teflon[®]-coated magnetic follower is charged with pyrrole (30 mL, 440 mmol), D_2O (50 mL), and DCl (concentrated, 0.5 mL), the mixture is connected to the nitrogen supply using a gas-inlet adapter, and stirred vigorously for 24 h.
2. The pyrrole is separated using a separating funnel and poured into another round-bottomed flask and step 1 is repeated. This procedure is then repeated five times whereupon pyrrole should contain about 98% deuterium.^b The substitution level is checked by infrared (IR) spectroscopy.^c Finally, the pyrrole is dried with $CaCl_2$ and then distilled at reduced pressure from CaH_2 (in a small-scale vacuum distillation apparatus).
3. A dry three-necked round-bottomed flask (250 mL) is equipped with an overhead stirrer, a condenser, and a gas-inlet adapter and under a blanket of nitrogen toluene- d_8 (25 g, 250 mmol) is added together with D_2SO_4 (25 g, 245 mmol).^d
4. The reaction mixture is heated in an oil-bath maintained at 120°C. After about 1 h, the toluene layer is cooled to room temperature and poured into cold water (100 mL).^e
5. The acid is neutralized by the careful addition of sodium carbonate and the solution is heated to boiling and then saturated with sodium chloride.
6. The hot solution from step 5 is then filtered under gravity, to remove any undissolved sodium chloride, and cooled in ice. The white crystals of the deuterated sodium *p*-toluene sulphonate sodium salt are collected by filtration using a Buchner funnel and the product is recrystallized from hot water and dried in a vacuum oven at 100°C
7. Pyrrole- d_5 (0.72 g, 0.01 mol) and sodium *p*-toluenesulfonate- d_8 (2.02 g, 0.01 mol) are added to a dry volumetric flask (100 mL). Under a blanket of nitrogen, D_2O is added such that the flask is filled to the line and the flask stoppered.
8. An electrochemical cell is arranged as in Protocol 1 (step 2), except that the cell is placed in a glove bag together with the flask containing the monomer and electrolyte. The glove bag is sealed and the electrochemical oxidation proceeds

6: Conducting polymers from heterocycles

in an identical fashion to Protocol 1. The final polymer must be removed from the electrode in a dry environment and protected from moisture.

^aAn upturned glass funnel attached to a supply of dry nitrogen is placed above the flask.

^bAt this stage the pyrrole and aqueous solution are substantially contaminated with black polymeric material.

^cThe peak at 3400 cm^{-1} due to the N–H is shifted to ca. 2500 cm^{-1} (N–D); the peak at 3100 cm^{-1} (C–H) is shifted to ca. 2300 cm^{-1} (C–D).

^dThe use of D_2SO_4 is to prevent any substitution of protons with deuterium during the reaction.

^e D_2O is not necessary at this stage.

Chemical oxidation of pyrrole can be achieved with a number of oxidants, but the approach below using ferric chloride seems to be one of the most popular. A simple approach is to make use of the slight solubility of pyrrole in water,^{*} although for less-soluble pyrroles an interfacial method can be used, with the pyrrole derivative dissolved in for example toluene. In the example below the reactivity of pyrrole is demonstrated by the synthesis of polymeric material from 2,4-dimethylpyrrole;¹⁰ here the methyl group is blocking one of the more reactive 2- (or α -) positions. Thus, although 2,4-dimethylpyrrole should not give the typical α -linked pyrrole, polymeric material is still formed. In this case, there may be β -coupling and also the methyl groups may be somewhat reactive, and there may be some linkages via CH_2 , it should also be noted that a detailed analysis of the product produced (see below) suggests that oxygen may be incorporated. However, despite the complex nature of the reaction, a conducting powder is obtained.

Protocol 3.

Chemical oxidation of 2,4-dimethyl pyrrole using ferric chloride

Caution! Carry out all procedures in a well-ventilated fume-cupboard, wear appropriate disposable gloves, a lab-coat, and safety glasses.

Equipment

- Teflon[®]-coated magnetic stirrer bar
- Magnetic stirrer
- Condenser
- Single-necked round-bottomed flask (250 mL)
- Apparatus for filtration, Buchner flask and funnel, and water aspirator
- Vacuum oven

Materials

- 2,4-Dimethylpyrrole, 0.371 mL, 3.6 mmol
- Calcium hydride

**irritating to eyes, skin, and respiratory system
contact with water liberates highly
flammable gases**

* Pyrrole in acetonitrile reacts with FeCl_3 very well to give a powder, but can get hot if you mix everything too quickly.

Protocol 3. Continued

- Anhydrous ferric chloride, 1.17 g, 7.2 mmol
- Toluene, 20 mL

causes burns
highly flammable, harmful by inhalation

Method

Preparation: 2,4-Dimethylpyrrole is distilled slowly from calcium hydride under reduced pressure prior to use and stored in the fridge at 4°C.

1. 2,4-Dimethylpyrrole (0.371 mL, 3.6 mmol) is dissolved in toluene (20 mL)^a in a round-bottomed flask equipped with a condenser and a magnetic follower. To this is added a solution of iron(III) chloride (1.17 g, 7.2 mmol) in water (7.2 mL to make a 0.1 M solution).
2. After shaking the solution is stirred for 24 h at room temperature, after which time the reaction mixture contains a considerable quantity of solid residue.
3. The residue from step 2 above is collected by filtration at the water pump washed with water and dried in a vacuum oven at 40°C. The material has a number average degree of polymerization of about 7 by MALDI-TOF spectrometry^b and NMR (see Chapter 1).

^aPyrrole may be oxidized directly in water as follows: freshly distilled pyrrole (0.67 g, 10 mmol) is added to water in an Erlenmeyer flask (250 mL), equipped with a Teflon[®]-coated magnetic stirrer bar. The solution is stirred vigorously and aqueous ferric chloride solution (4.055 g anhydrous ferric chloride in 50 mL water) is added. A black precipitate is immediately formed; after 20 min, this precipitate is collected by filtration, washed with copious amounts of water, and dried under vacuum. The properties depend on the molar ratios of Fe(III) and pyrrole.¹¹

^bThe mass spectrum also shows peaks at $M + 17$ showing further oxidation presumably by reaction of the cationic intermediate with water.

More sophisticated derivatives of pyrrole have been developed for a variety of reasons, for example, 3-alkyl pyrroles such as 3-octylpyrrole have been prepared to improve processibility. Particular interest has been shown in the development of materials that exhibit liquid crystalline properties. In the following example,¹² a 3-substituted pyrrole with mesogenic properties is synthesized using the route shown in Scheme 2. A particular feature of this is the formation of *N*-(*p*-toluenesulfonyl)pyrrole to control substitution at the 3-position rather than the 2-position, which is otherwise more reactive. Mesogenic materials offer particular advantages in terms of processibility and more importantly, in providing conducting polymer films with alignment predetermined prior to polymerization. This monomer is polymerized in a number of ways most notably as a partially aligned film. The latter process requires custom-built apparatus, and different laboratories may have different approaches,¹³ but it serves to illustrate the principle.

6: Conducting polymers from heterocycles

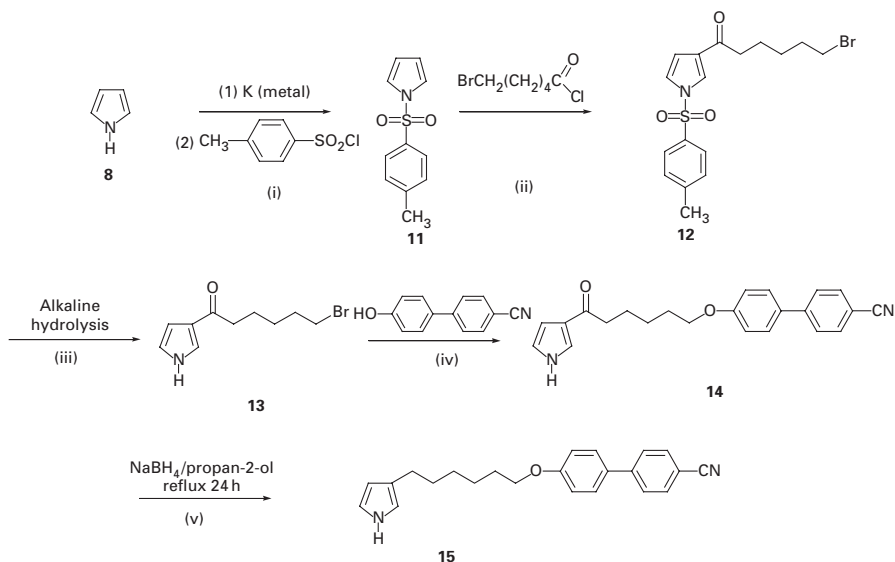

Scheme 2 Preparation of a 3-substituted pyrrole with a mesogenic unit in the side-chain.

Protocol 4.

Preparation of potassium pyrrole and subsequent formation of *N*-(*p*-toluenesulfonyl)pyrrole [Scheme 2(i)]

Caution! Carry out all procedures in a well-ventilated fume-cupboard, wear appropriate disposable gloves, a lab-coat, and safety glasses. Never use flat-bottomed flasks with rotary evaporators. Potassium presents an extreme fire risk and appropriate precautions should be taken at all times.

Equipment

- Three-necked round-bottomed flask
- Reflux condenser
- Heat source, namely hotplate, oil-bath, and thermometer
- Watch glass
- Overhead stirrer
- Apparatus for recrystallization, Erlenmeyer flask, Buchner flask, funnel, and water aspirator
- Pressure-equalizing dropping funnel
- Buchner flask (1 L)
- Apparatus for distillation under reduced pressure
- Sintered-glass funnel (porosity 3)
- Penknife or scalpel
- Stirrer gland, rod, and Teflon stirrer paddle
- Beaker (500 mL)

Materials

- Potassium, 10.1 g, 256 mmol
- Pyrrole, 20 mL, 289 mmol
- *p*-Toluenesulfonyl chloride, 40.6 g, 213 mmol

reacts violently with water, contact with water liberates highly flammable gases, causes burns flammable, harmful by inhalation, toxic if swallowed, risk of serious damage to eyes harmful on contact with the skin or if swallowed

Protocol 4. Continued

- Dry THF, 500 mL **highly flammable, may form peroxides, irritating to eyes and respiratory system**
- Calcium hydride **contact with water liberates highly flammable gases**
- Methanol **highly flammable, toxic by inhalation and if swallowed**
- Petroleum ether (40–60) **highly flammable**
- Xylene (anhydrous) **flammable, harmful by inhalation**
- Dry nitrogen **asphyxiation hazard**
- Celite **irritating to eyes and respiratory system, possible carcinogen**

Method

Preparation: All glass equipment is dried in an oven at 150°C, assembled while hot (use heat-resistant gloves), and allowed to cool under an atmosphere of dry nitrogen. Pyrrole is dried by distilling under reduced pressure (water aspirator) from calcium hydride immediately before use.^a *p*-Toluenesulfonyl chloride is recrystallized from petroleum ether (60–80°C fraction).^b

1. A three-necked round-bottomed flask (1 L) is equipped with a gas inlet, a pressure-equalizing dropping funnel, and a condenser attached to a source of the inert gas supply (using the manifold system described in Chapter 2).
2. The system is purged with inert gas (argon or nitrogen) and dry THF (200 mL) is placed in the flask.
3. A piece of fresh potassium metal^c (10.0 g, 256 mmol) is placed in a beaker containing anhydrous xylene under a blanket of inert gas and small pieces, are cut under the xylene (**Care**^d) and slowly added, with vigorous stirring to the THF. The suspension is then heated to reflux while maintaining stirring, whereupon small beads of molten potassium are formed.
4. Pyrrole (20 ml, 289 mmol in 100 mL of dry THF) is added drop-wise to the suspension of molten potassium and heating is continued until the potassium has been completely consumed. The mixture of potassium pyrrole is cooled and may be stored or used directly. To store the potassium pyrrole, the solid must be filtered quickly at the pump under a blanket of nitrogen, washed well with dry THF and dried in a vacuum desiccator over P₂O₅. The dry solid (which is yellow in colour) can then be stored under nitrogen. For direct conversion to *N*-(*p*-toluenesulfonyl)pyrrole, then proceed as in step 5 below.
5. The mixture of potassium pyrrole is diluted with a further quantity of THF (100 mL) to facilitate partial dissolution of the white solid and a solution of recrystallized *p*-toluenesulfonyl chloride (40.6 g, 213 mmol) in dry THF (200 mL) is added drop-wise. (**Care!** This reaction is exothermic and addition should be controlled so that only slight warming occurs.) The mixture is then allowed to stir for 24 h.
6. The solution is then filtered through a No. 3 sintered funnel containing Celite[®] as a filter aid and the THF is removed using the rotary evaporator to give a white residue.

6: Conducting polymers from heterocycles

7. Recrystallization from methanol and drying at 50°C gives *N*-tosylpyrrole as a white crystalline solid (melting point 103°C,^e yield 37.0 g, 78.5%).^f

^aPyrrole purified in this way may be kept in brown bottles and stored under nitrogen in the freezer for several months without becoming coloured, however, it is recommended that freshly purified material be used in this case.

^bThe use of freshly purchased material is advocated, material which has been left to stand for a long period contains substantial amounts of *p*-toluenesulfonic acid and therefore a reduced melting point. This may be purified¹⁴ by dissolving in the minimum amount of CHCl₃ and filtering then further diluting (five times) with petroleum ether (30–40°C) and filtering once more. The solution is then concentrated to a small volume to give pure *p*-toluenesulfonyl chloride (m.p. 68–69°C).

^cPotassium metal should be carefully inspected prior to use to ensure there are no traces of peroxide on the surface, it is never advisable to use potassium from containers stored for long periods.

^dIn order to avoid droplets of condensation from the fume-hood falling into the beaker containing the potassium and thus causing a fire, the beaker should be covered with a watch glass. Any excess potassium must be disposed of carefully by reaction with *tert*-butanol (*Not* ethanol or *iso*-propanol, both of which ignite on contact with potassium).

^eWe obtained 103°C, literature value¹⁵ 104.5°C.

^fAn identical procedure can be used for the formation of *N*-benzenesulfonylpyrrole. Typical quantities which may be used are potassium metal (10 g, 256 mmol), pyrrole (25 mL, 19.3 g, 288 mmol) and *N*-benzenesulfonyl chloride (45.1 g, 255 mmol). The material is obtained as a pale brown solid, which is purified by recrystallization without filtration followed by drying *in vacuo* at 45°C to give pale brown crystals [yield 30.5 g, 57.6 %, m.p.: 87–89°C (lit. value¹⁵ 89–89.5°C)].

Protocol 5.

Preparation of *N*-benzenesulfonyl-3(6-bromohexanoyl)pyrrole^a and hydrolysis to 3-(6-bromohexanoyl)pyrrole [Scheme 2(ii) and (iii)]

Caution! Carry out all procedures in a well-ventilated fume-cupboard, wear appropriate disposable gloves, a lab-coat, and safety glasses. Never use flat-bottomed flasks with rotary evaporators.

Equipment

- Dual manifold nitrogen/vacuum
- Two-necked round-bottomed flask (1 L)
- Reflux condenser
- Magnetic stirrer
- Single-necked round-bottomed flask (1 L)
- Apparatus for recrystallization, Erlenmeyer flask, Buchner flask, funnel and water aspirator
- Source of dry nitrogen (gas manifold)
- Pressure-equalizing dropping funnel
- Buchner flask (1 L)
- Ice-bath for cooling
- Separating funnel (500 mL)
- Round-bottomed flask (500 mL) for use with rotary evaporator
- Rotary evaporator

Materials

- *N*-benzenesulfonylpyrrole, 11.3 g, 54.5 mmol
 - Anhydrous aluminium chloride, 10.8 g, 81 mmol
 - 6-bromohexanoyl chloride, 15 g, 70 mmol
 - Dichloromethane, ca. 500 mL
 - Anhydrous magnesium sulfate
 - Brine
 - Dioxane, 300 mL.
- treat as harmful
causes burns
reacts violently with water, causes burns,
irritating to eyes, skin, and respiratory system
harmful by inhalation, potential carcinogen**
- highly flammable, may form peroxides, harmful by inhalation**

Protocol 5. *Continued*

- Sodium hydroxide solution (5 M), 300 mL
 - Methanol
 - Diethyl ether for purification
 - Petroleum ether (60–80) for purification
 - Alumina (neutral) for chromatography
- causes burns**
highly flammable, toxic by inhalation and if swallowed
extremely flammable, may form peroxides
highly flammable
irritating to respiratory system

Method

1. A two-necked round-bottomed flask (1 L) is equipped with a reflux condenser, a pressure-equalizing dropping funnel, a Teflon[®]-coated magnetic stirrer bar and a nitrogen inlet.^b
2. Dry dichloromethane (200 mL—see Chapter 2) is added to the flask together with anhydrous aluminium chloride (10.8 g, 81 mmol) and the mixture is stirred under a nitrogen atmosphere.
3. 6-Bromohexanoyl chloride (15 g, 70.3 mmol) in dichloromethane (150 mL) is placed in the dropping funnel. This is then added drop-wise to the flask at 20°C and the mixture allowed to stir for 20 min.
4. *N*-Benzenesulfonylpyrrole (11.3 g, 54 mmol) in CH₂Cl₂ (150 mL) is then added drop-wise while maintaining the temperature below 5°C by cooling with ice. The reaction is left to stir for ca. 20 h.^c
5. The reaction mixture is carefully hydrolysed with ice-water and the organic phase collected. The aqueous layer is then extracted with CH₂Cl₂ (three portions). The combined organics are then washed with brine and dried over anhydrous magnesium sulfate; filtration followed by evaporation of the solvent to yield a dark brown oil, which crystallizes upon standing. The brown solid is recrystallized from methanol (m.p. 53–54.5, yield 17.3 g, 83%).
6. In a round-bottomed flask (1 L) equipped with a condenser *N*-benzenesulfonyl-3(6-bromohexanoyl) pyrrole (12.0 g, 31.3 mmol) is added together with a mixture of 1,4-dioxane (300 mL) and NaOH solution (5 M, 300 mL). The reaction mixture is stirred at room temperature for 48–72 h until thin layer chromatography (TLC) indicates the absence of starting material.^d
7. The dioxane is removed on the rotary evaporator and the pale yellow solid obtained is dissolved in dichloromethane and the aqueous layer is extracted with two further portions of dichloromethane. The organics are then combined, washed with saturated NaCl solution, and dried with anhydrous magnesium sulfate. The solution is then filtered and the solvent removed to yield a pale yellow oil, which crystallizes on cooling.
8. The solid is purified using column chromatography on neutral alumina^e using diethyl ether and petroleum ether (1 : 1) to elute the product. The solid product (crude yield 8.0 g, 100%) is recrystallized from diethyl ether/petroleum ether (60–80 fraction) to give white crystals (m.p. 73.5–76°C).

6: Conducting polymers from heterocycles

^aThe *N*-tosylpyrrole derivative was also prepared in the same way.

^bConnected via the condenser to a double manifold (see Chapter 2).

^cA range of conditions have been investigated for a similar alkylation and it would seem that the regioselectivity is independent of the concentration of the sulfonylpyrrole, and the reaction temperature, but that the formation of the 3-product is favoured by performing the reaction in dilute homogeneous solution; a more concentrated solution of the complex was found to favour 2-substitution.¹²

^dTLC indicated one major and one minor product.

^eWashed with water (10% w/v).

Protocol 6.

Preparation of 3-[6-(4'-cyanobiphenyl-4-yloxy)hexanoyl]pyrrole and reduction to 3-[6-(4'-cyanobiphenyl-4-yloxy)hexyl]pyrrole [Scheme 2(iv) and (v)]

Caution! Carry out all procedures in a well-ventilated fume-cupboard, wear appropriate disposable gloves, a lab-coat, and safety glasses. Never use flat-bottomed flasks with rotary evaporators.

Equipment

- Single-necked round-bottomed flask (500 mL)
- Reflux condenser
- Hotplate magnetic stirrer
- Rotary evaporator
- Apparatus for recrystallization, Erlenmeyer flask, Buchner flask, funnel, and water aspirator
- Vacuum oven
- Teflon-coated magnetic stirrer bar

Materials

- 3-(6-Bromohexanoyl)pyrrole, 8.00 g, 32.8 mmol
 - Anhydrous potassium carbonate, 13.83 g, 100 mmol
 - Potassium iodide (trace)
 - 4-Cyano-4'-hydroxybiphenyl, 6.39 g, 32.7 mmol
 - Dimethylformamide, 165 mL
 - Propan-2-ol
 - Phosphorous pentoxide
 - Sodium borohydride, 5.29 g, 139.8 mmol
 - Ethyl acetate
 - Petroleum ether (60–80 fraction)
 - Dichloromethane
 - Silica
- treat as harmful
harmful if swallowed, irritating to
eyes, skin, and respiratory system
irritant**
- potentially teratogenic, harmful in contact
with skin, irritating to eyes
highly flammable
causes severe burns
harmful if swallowed, irritating to eyes
and respiratory system
highly flammable
highly flammable**
- harmful by inhalation, potential carcinogen
harmful by inhalation, irritating to
respiratory system**

Method

1. A single-necked round-bottomed flask (500 mL) is equipped with a reflux condenser and a Teflon[®]-coated magnetic stirrer bar.^a To this is added 3-(6-bromohexanoyl)pyrrole (8.00 g, 32.8 mmol), anhydrous potassium carbonate (13.83 g, 100 mmol), 4-cyano-4'-hydroxybiphenyl (6.39 g, 32.7 mmol), Potassium iodide (trace)^b, and dimethylformamide (165 mL). The mixture is warmed to 90–100°C for 1 h.

Protocol 6. *Continued*

2. The product is precipitated from solution by addition of a large excess of demineralized water and filtered at the pump, washing with copious amounts of water.
3. The cream-coloured solid is dried at the pump, and then placed in a vacuum oven over P₂O₅ at 65°C overnight. The product is then recrystallized from a mixture of propan-2-ol and water (10.1 g, 86%, m.p. 131°C).
4. To a single-necked round-bottomed flask (500 mL) fitted with a reflux condenser, is added propan-2-ol (150 mL), then 3-[6-(4'-cyanobiphenyl-4-yloxy)hexanoyl]pyrrole (4.64 g, 13.0 mmol) and NaBH₄ (5.29 g, 139.8 mmol) are added and the mixture refluxed for 48 h.
5. The reaction is carefully hydrolysed with water and the solvent removed on the rotary evaporator. Ethyl acetate is added to the crude residue to dissolve organic material; this procedure is repeated three times with further addition of ethyl acetate. Removal of the solvent yields a cream-coloured solid, which is dissolved in dichloromethane and passed through a bed of silica to remove polymeric residues. This cleaner product is recrystallized from a mixture of ethyl acetate and petroleum ether (60–80 fraction) to yield white crystals [2.5 g, 56%, m.p.: C₁, 86.0; C₂ 96.6; N (72.4–72.0)]^c, which can be dried in a vacuum desiccator.

^aThis aids initial mixing of the reagents but once there is substantial solid in the flask, will not be effective, additional measures to stir the mixture do not appear to be necessary.

^bThis catalyses the S_N2 reaction.

^cThe monomer exhibits complex phase behaviour, in particular, a monotropic liquid crystalline phase, which is only apparent on cooling, such materials can only be properly characterized by using differential scanning calorimetry (DSC) in conjunction with optical microscopy and also by X-ray scattering (see Chapter 1).

Protocol 7. **Polymerization of 3-[6-(4'-cyanobiphenyl-4-yloxy)hexyl]pyrrole under anaerobic conditions^a**

Caution! Carry out all procedures in a well-ventilated fume-cupboard, wear appropriate disposable gloves, a lab-coat, and safety glasses.

Equipment

- Dual manifold system vacuum/nitrogen
- Three-necked round-bottomed flask (250 mL)
- Filter stick
- Hotplate magnetic stirrer
- Two-way tap with Quickfit adapter
- Syringe and needles
- Single-necked round-bottomed flasks (250 mL × 3)
- Source of dry nitrogen
- Two-necked round-bottomed flask (250 mL)
- Vacuum pump
- Magnetic stirrer bar
- Cannula
- Rubber septa

6: Conducting polymers from heterocycles

Materials

- 3-[6-(4'-cyanobiphenyl-4-yloxy)hexyl]pyrrole, 0.19 g, 0.5 mmol
 - Anhydrous ferric chloride, 0.27 g
 - Deionized water
 - Acetonitrile
 - Nitrogen gas
- treat as harmful
causes burns**
- highly flammable, toxic by inhalation, in contact with
skin, and if swallowed
asphyxiation hazard**

Method

Preparation: All solutions, solvents, and reagents must be thoroughly degassed prior to use as follows: acetonitrile is placed in a single-necked round-bottomed flask and placed in an ultrasonic-bath for 30 min. The flask is then fitted with a rubber septum and an outlet needle and a needle connected by tubing to a source of dry nitrogen are inserted through the septum. Nitrogen is then bubbled through the solution for 60–90 min. Thereafter, the acetonitrile is kept under nitrogen at all times^b. A solution of 3-[6-(4'-cyanobiphenyl-4-yloxy)hexyl]pyrrole (0.19 g, 0.5 mmol) in acetonitrile (20 mL) is degassed in an identical fashion, as is deionized water for washing.

1. A three-necked round-bottomed flask is equipped with a magnetic follower, a rubber septum (S1), a two-way tap and a filter stick (a glass inlet tube with a sintered-glass frit at one end), which is also sealed at its open end with a suitable rubber septum (S2).
2. To flask is added anhydrous ferric chloride (0.27 g) and the flask is then evacuated repeatedly (five times) under high vacuum and refilled with nitrogen, using a double-manifold system connected to the two-way tap.
3. Degassed acetonitrile [High performance liquid chromatography (HPLC) grade, 20 mL] is then added via the rubber septum (S1) using a clean dry syringe. The degassed monomer solution (see above) is added to the flask by syringe and stirred. A black precipitate is formed within minutes but the solution is stirred for a further 17–18 h.
4. A clean, dry, degassed two-necked round-bottomed flask is equipped with a rubber septum and a gas-inlet tube. The gas-inlet tube is in turn connected to the pump. A double-headed needle (cannula—see e.g. Chapter 3) is inserted in the septum in this flask and then through the septum attached to the filter stick (S2). The reaction solvent is then removed by means of the vacuum through this cannula,
5. The polymeric solids remaining in the flask are washed with degassed water (three portions) followed by degassed acetonitrile (two portions), and filtered as in step 4 above. The washed polymers are dried under vacuum for 2–3 h.

^aAs an alternative 3-[6-(4'-cyanobiphenyl-4-yloxy)hexyl]pyrrole can be oxidized with copper(II) perchlorate (**Care!** Contact with combustible material may cause fire, irritant) as follows: 3-[6-(4'-cyanobiphenyl-4-yloxy)hexyl]pyrrole (0.34 g, 1 mmol) is dissolved in acetonitrile (8–10 mL) and added to two-necked round-bottomed flask fitted with a nitrogen bubbler and a nitrogen gas inlet (e.g. a needle connected to the inert gas supply inserted through a rubber septum). The solution is maintained

Protocol 7. Continued

under a continuous stream of nitrogen and held at $20 \pm 1^\circ\text{C}$ in a thermostatted water-bath. Copper (II) perchlorate hexahydrate, $\text{Cu}(\text{ClO}_4)_2 \cdot 6\text{H}_2\text{O}$ (0.74 g, 2 mmol) is dissolved in acetonitrile (8–10 mL) and added drop-wise to the monomer solution. A black precipitate is formed immediately in the clear solution. The mixture is stirred for a minimum of 90 min and then filtered. The solid polymer is then washed under filtration with copious amounts of water followed by acetonitrile, in order to remove unreacted monomer and oxidant. Finally, the polymer is washed with hot acetonitrile using a Soxhlet extractor, for up to 6–8 h. Drying *in vacuo* for a further 6–8 h yields poly 3-[6-(4'-cyanobiphenyl-4-yloxy)hexyl]pyrrole as an amorphous black solid.

^bSubsequent manipulations of solvents are performed with nitrogen-purged syringes and/or a cannula, through degassed, flasks fitted with septa (see text).

The presence of the mesogenic side-chains allows for the development of orientation in films prior to polymerization. If the monomer is then polymerized in this aligned state, it would be expected that the orientation imparted on the pyrrole units by association with the mesogens would become incorporated into the polymer. High levels of anisotropy may lead, for example, to new applications that can exploit the different conducting mechanisms along and orthogonal to the polymer chains.¹⁶ The apparatus for polymerizing the substituted pyrroles as an aligned film consists of a reaction cell through which bromine vapour (the oxidant) can be passed. This apparatus is designed to fit within the cavity of a polarizing microscope, and contains an aperture for viewing the sample to ensure the required phase/alignment state.

Protocol 8. Polymerization of 3-[6-(4'-cyanobiphenyl-4-yloxy)hexyl]pyrrole as an aligned film

Equipment

- Type K Chromel–Aluminel thermocouple
- Temperature controller
- Glass reaction cell with inlet and outlet for nitrogen and oxidant vapour
- Optical microscope
- Source of dry nitrogen
- Vacuum oven
- Glass slide
- Aluminium heating block designed for use with the reaction cell
- Power supply
- 2 × Dreschel bottles

Materials

- 3-[6-(4'-cyanobiphenyl-4-yloxy)hexyl]pyrrole, ca. 50 mg, 1.3 mmol
 - Acetonitrile
 - Nitrogen gas
 - Dimethylformamide
- treat as harmful**
highly flammable, toxic by inhalation, in contact with skin, and if swallowed asphyxiation hazard
potentially teratogenic, harmful in contact with skin, irritating to eyes

6: Conducting polymers from heterocycles

- Bromine
- Probidimide[®] 32
- Sodium thiosulfate solution (saturated)

**very toxic by inhalation, causes severe burns
irritating to eyes, skin, and respiratory system**

Method

1. A glass slide (ca. 1 cm × 1 cm) is spin-coated with a solution of Probidimide[®] 32 in dimethylformamide.^a The coated slide is annealed at high temperatures (ca. 200°C), followed by unidirectional rubbing with a soft cloth, to yield a hard, inert, rubbed polymer film, suitable for enticing homogeneous alignment of a mesophase.
2. The sample to be polymerized (**15**, ca. 50 mg) is deposited on the glass slide and placed in a reaction cell cavity.^b The reaction cell is connected on one side to a reservoir of bromine in a glass tube fitted with both gas inlet and outlet valves (such that nitrogen can be passed through the tube, but without bubbling through the bromine). Between the bromine reservoir and the cell is a three-way tap, which is connected to a separate nitrogen inlet and allows the passage of bromine free- nitrogen through the cell as required. On the opposite side, the cell is connected to two Dreschel bottles arranged in series containing a saturated solution of sodium thiosulfate to destroy the effluent bromine vapour.^c
3. The cell is placed in an aluminium heating block shaped out to contain the cell and fitted with four heating elements, connected to a 10-A power supply, and placed in the cavity of a polarizing microscope.^d The cell is then purged with a continuous stream of nitrogen and heated to the approximate required temperature^e for polymerization in the liquid crystalline region; this involves heating to ca. 80°C such that the sample becomes isotropic and then cooling fairly rapidly to 60°C or until an optical texture typical of a liquid crystalline phase is observed.^f
4. With the sample in the required phase, the nitrogen is passed over the tube containing bromine and this tube warmed with a beaker containing hot water to speed up evaporation of bromine. Bromine vapour is then allowed to pass over the sample continuously until polymerization appears complete. The cell is then re-purged with fresh nitrogen alone, cooled, and the glass slide containing the polymeric deposit removed. The samples are washed (still attached to the glass slide) by standing in acetonitrile for 24 h and dried under vacuum for 3–4 h.^g

^aThis polyimide precursor forms a polymer coating on the glass surface, onto which alignment may be introduced by rubbing, before the coating has hardened; such rubbed films induce orientation in liquid crystalline materials.

^bThe reaction cell consists of a small glass vessel equipped with an inlet and outlet, to permit the throughput of oxidant vapour and nitrogen (as a carrier gas).

^c $2\text{S}_2\text{O}_3^{2-} + \text{Br}_2 \rightarrow \text{S}_4\text{O}_6^{2-} + 2\text{Br}^-$.

^dBoth halves of the heating block contain a small aperture, orthogonal to the plane of, and positioned above and below, the cell centre. This permits the passage of light through the cell to the eyepiece lens.

Protocol 8. Continued

^eThe temperature of the cell is regulated with a temperature controller, connected to the cell via a type K Chromel–Alumel thermocouple, which is inserted into a small aperture within the heating block.

^fThis procedure is required because the pyrrole derivative forms a monotropic liquid crystalline phase; that is, it is only observed on cooling from the isotropic, and is kinetically favoured but thermodynamically unfavoured; notwithstanding this the phase is sufficiently stable in this case to allow polymerization.

^gThe procedure appears to much more efficient in the isotropic phase than in the nematic phase. In the nematic phase polymerization may be confined largely to the surface for thicker films; in the isotropic phase, polymerization is much more uniform.

4. Synthesis of polyaniline

Polyaniline (Scheme 3), is not strictly a heteroaromatic monomer, but has a number of similarities to polypyrrole. There are differences, however, one of which is that are three redox levels each of which may be protonated or deprotonated. Of these, the pH-driven switch between the emeraldine (17) salt and emeraldine base (18) is attracting interest.¹⁷

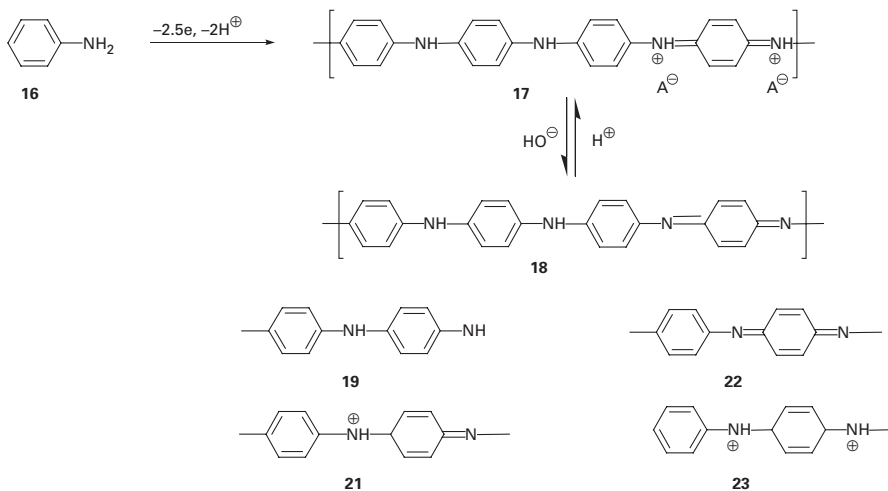

Scheme 3 Oxidation of aniline and possible oxidation levels and protonation levels of the polyaniline produced.

Polyaniline is less tolerant of preparation conditions than polypyrrole, and the list of anion dopants used in the preparation is more limited. However, subsequent replacement of the anion used in preparation by a dodecylbenzene sulfonate makes polyaniline become soluble in solvents such as *N*-methyl pyrrolidone (NMP), or *m*-cresol, and it can be spin-coated or otherwise solution-processed. In a similar way derivatives of aniline, such as

6: Conducting polymers from heterocycles

2-methoxyaniline¹⁸ when oxidized in a similar fashion to that given in Protocol 9 below give a conducting polymer that is soluble in solvents such as chloroform, dichloromethane, and acetonitrile.

Protocol 9. Electrochemical polymerization of aniline

Caution! Carry out all procedures in a well-ventilated fume-cupboard, wear appropriate disposable gloves, a lab-coat, and safety glasses.

Equipment

- Potentiostat
- Electrochemical cell with suitable electrodes, carbon rod, platinum foil electrode, SCE
- Volumetric flask
- Deionized water

Materials

- Aniline, 0.93 g, 10 mmol
 - Hydrochloric acid, 1 M, 100 mL
 - Deionised water
- toxic by inhalation, in contact with skin, and if swallowed,
danger of cumulative effects
causes burns, irritating to respiratory system**

Method

Preparation: Aniline is distilled from calcium hydride under reduced pressure prior to use and stored under nitrogen in the fridge at 4°C.

1. A volumetric flask (100 mL) is charged with aniline (0.93 g, 10 mmol) and made up to the mark with hydrochloric acid (1 M). The solution is then purged with nitrogen for approximately an hour prior to use.
2. The solution is poured into the electrochemical cell. This is arranged as described in Protocol 1, but here the working electrode is a piece of platinum foil^a that has previously been cleaned with nitric acid (concentrated) followed by washing with water and drying in an oven at 120°C.
3. With the potentiostat on standby, the electrodes are connected up to the correct outputs and the potential selected; typically, this will be +1.2 V (versus SCE). Nitrogen gas is then slowly bubbled through the electrolyte.
4. The potentiostat is switched on to apply the potential across the electrodes and a blue-black film is seen to form on the electrode. Electrolysis is then continued until sufficient material is formed.^b The film is then washed with water and dried in the vacuum oven at 40°C.

^aOther electrodes such as gold can be used, but films formed on platinum generally have good adhesion qualities.

^bTypically, this is determined by the total charge delivered.

Protocol 10. Chemical Oxidation of Aniline

Caution! Carry out all procedures in a well-ventilated fume-cupboard, wear appropriate disposable gloves, a lab-coat and safety glasses.

The following procedure is based on one described by Alan J. Heeger¹⁹ who jointly shared the 2000 Nobel prize for chemistry with Hideki Shirakawa and Alan G. MacDiarmid for their work on conducting polymers.

Equipment

- Mechanical stirrer, stirrer rod, paddle, and stirrer gland
- Three-necked round-bottomed flask (1 L)
- Thermometer
- Ice-bath for cooling
- Apparatus for filtration, Buchner flask, and funnel
- Dropping funnel

Materials

- Aniline, 20 mL, 20.43 g, 220 mmol
 - Ammonium persulfate, 23.0 g, 110 mmol
 - hydrochloric acid, 1.5 M, 500 mL
 - Methanol
 - Diethyl ether
- toxic by inhalation, in contact with skin, and if swallowed, danger of cumulative effects**
contact with combustible material may cause fire, irritating to eyes, skin, and respiratory system, harmful if swallowed, may cause sensitization by inhalation and skin contact
causes burns, irritating to respiratory system
highly flammable, toxic by inhalation and if swallowed
extremely flammable, may form peroxides

Method

1. A three-necked round-bottomed flask (1 L) is equipped with a thermometer, a mechanical (overhead) stirrer,^a and a dropping funnel. Aqueous HCl (1.5 M, 250 mL) is added followed by aniline (20.43 g, 220 mmol). The solution is cooled in ice to 0°C.
2. A solution containing ammonium persulfate (23.0 g, 110 mmol) in aqueous HCl (1.5 M, 250 mL) is placed in the dropping funnel and then very slowly^b added to the aniline solution whilst maintaining the temperature close to 0°C.
3. After the addition is complete, the reaction mixture is then left stirring for a further hour.
4. The solid polyaniline is collected from the reaction mixture by filtration and washed thoroughly with water. The solid is then washed with several portions of methanol and finally with diethyl ether.^c The solid is then dried under vacuum for 48 h or until a constant mass is reached.^d

^aA magnetic stirrer will not cope with the quantities of solid material produced in this reaction, particular care is needed to ensure that the rod is exactly vertical and the paddle rotates freely, and of course, is not obstructed by the thermometer.

^bHeeger recommends an addition period of 3 h.

^cThis washing is best undertaken by removing the solid from the filtration apparatus and placing it in a beaker. The solid can then be mixed thoroughly with the organic solvent and refiltered.

^dThe polyaniline can be converted to the base form by stirring with a solution of aqueous ammonia (3%) for 3 h followed by washing as in step 3.

5. Synthesis of polythiophene

Thiophene differs from pyrrole and aniline in that it is insoluble in water and less electron-rich than either of these two molecules with a consequence that it is oxidized at a higher potential, sufficiently high that oxidation of water may interfere in the process. Both considerations mean that the material must be polymerized in a non-aqueous medium, and acetonitrile or nitrobenzene are often chosen.^{20,21} The following example is broadly applicable to most substituted thiophenes and has been used for the oxidation of a range of long-chain alkyl thiophenes.²² 3-Hexylthiophene and a range of other 3-substituted materials are available commercially, and can be polymerized electrochemically. Chemical polymerization is usually performed using organometallic coupling reactions,²³ a simple example being the one shown in Scheme 4,²⁴ in this example, the aryl iodide and the stannylthiophene are reacted in equimolar quantities in dry dimethylformamide in the presence of $[\text{Pd}(\text{PPh}_3)_4]$ ²⁵ (10 mol%) at 80–90°C. It must be noted, however, that the polymer produced is both in its neutral non-conducting form, and has random regiochemistry; nowadays, particular effort is being put into the development of substituted thiophenes with regular regiochemistry using organometallic coupling reactions.^{26,27} Some regioregular polythiophenes and their precursors are available commercially.

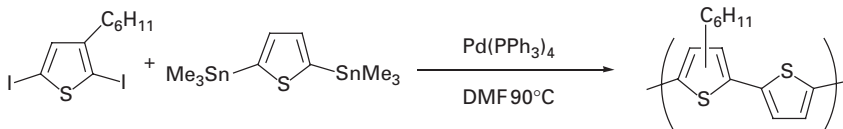

Scheme 4 Preparation of a regio-random poly(thiophene) derivative by a palladium-catalysed polycondensation.

Protocol 11.

Electrochemical polymerization of 3-hexylthiophene (Scheme 5)

Caution! Carry out all procedures in a well-ventilated fume-cupboard, wear appropriate disposable gloves, a lab-coat, and safety glasses.

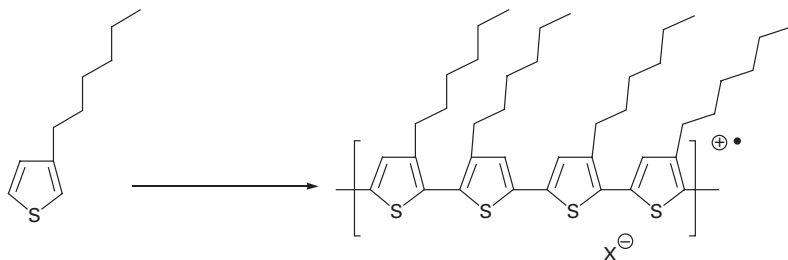

Scheme 5 Electrochemical preparation of poly(3-hexylthiophene).

Protocol 11. Continued

Equipment

- Potentiostat
- Electrochemical cell with suitable electrodes, conducting glass, platinum gauze electrode, SCE
- Volumetric flask
- Vacuum desiccator
- Source of dry nitrogen

Materials

- 3-Hexylthiophene, 1.68 g, 10 mmol **flammable, treat as toxic asphyxiation hazard**
- Nitrogen gas **highly flammable, toxic by inhalation in contact with skin and if swallowed**
- Nitrobenzene, 100 mL **corrosive, harmful by inhalation**
- Tetrabutylammonium hexafluorophosphate, 0.69 g, 2.5 mmol
- Hexane, for washing **highly flammable, harmful by inhalation and in contact with the skin**

Method

Preparation: Nitrobenzene is dried over calcium chloride and then distilled from barium oxide, 3-hexylthiophene is distilled under reduced pressure.

1. A volumetric flask (100 mL) is charged with 3-hexylthiophene^a (1.68 g, 10 mmol) and tetraethylammonium hexafluorophosphate (0.69 g, 2.5 mmol) and made up to the mark with nitrobenzene.^b The solution is then purged with nitrogen for approximately an hour prior to use.
2. The solution is poured into the electrochemical cell. This is arranged as described in Protocol 1, with the working electrode (anode) being a piece of conducting indium–tin oxide glass (1.5 cm × 1.5 cm) and the counter-electrode a platinum gauze using an SCE as the reference. The electrochemical cell is then placed in a water-bath maintained at 10°C.^c
3. With the potentiostat on standby, the electrodes are connected up to the correct outputs. Dry nitrogen gas is then slowly bubbled through the electrolyte.
4. The potentiostat is switched on to apply the potential across the electrodes and a coloured film is seen to form.^d Electrolysis is then continued until sufficient material is formed. The film is then washed with hexane and dried in a vacuum desiccator.

^a3-Hexylthiophene is available commercially or it can be obtained by the nickel-catalysed coupling of hexylmagnesiumbromide with 3-bromothiophene.²⁸

^bAcetonitrile or propylene carbonate are preferred solvents for electrochemical reactions, but the solubility of many alkylthiophene derivatives is poor.

^cAn alternative arrangement uses a water-jacketed electrochemical cell with water from the coolant-bath continuously passed through the system.

^dElectrochemical oxidation is usually performed in constant current mode; an optimum current density is up to 10 mA cm⁻² (usually a higher current density is used than for, say, the oxidation of pyrrole).

6: Conducting polymers from heterocycles

While electrochemical polymerization represents a relatively straightforward method of producing polythiophenes and for example, offers particular potential for generating controlled structures on electrode surfaces²⁹ there are clearly some random factors in the polymerization, which involves the formation of cation radicals; defects include coupling in the 3-position (calculations have shown that thiophene has significant reactivity at the 3-position, unlike pyrrole, where the α -position is favoured)³⁰ and for 3-alkyl thiophenes a non-regioregular structure (i.e. head-to-tail and head-to-head polymerization). Organometallic coupling reactions have proved particularly successful at countering this problem. The procedure below is based on one designed by McCullough.³¹

Protocol 12. Regiospecific formation of poly(3-hexylthiophene) by a nickel-catalysed cross-coupling (Scheme 6)

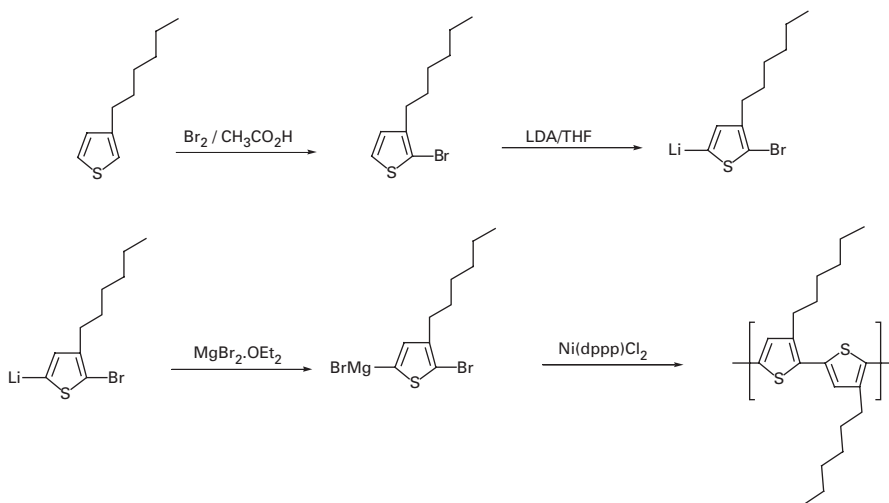

Scheme 6

Caution! Carry out all procedures in a well-ventilated fume-cupboard, wear appropriate disposable gloves, a lab-coat, and safety glasses. Never use flat-bottomed flasks with rotary evaporators.

Equipment

- Three-necked round-bottomed flask (250 mL)
- Gas inlet
- Teflon[®]-coated magnetic stirrer bar
- Funnel
- Pressure-equalizing dropping funnel
- Condenser
- Gas outlet
- Water-bath

Protocol 12. Continued

- Solid-addition tube
- Separating funnel (250 mL)
- Septum cap
- Dry two-necked flask (250 mL)
- Apparatus for distillation at reduced pressure: four single-necked round-bottomed flasks (50 mL), condenser, thermometer, air bleed, 'pig-type' receiver-adaptor, Claisen still-head, and thermometer

Materials

- 3-Hexylthiophene, 10 g, 60 mmol **flammable, treat as toxic asphyxiation hazard**
- Argon **asphyxiation hazard**
- Bromine, 3.1 mL, 0.06 mmol **very toxic by inhalation, causes severe burns**
- Sodium metabisulfite, ca. 1 g. **harmful by inhalation, in contact with skin, and if swallowed causes severe burns**
- Sodium hydroxide solution (1 M) **flammable, causes severe burns**
- Acetic acid, 25 mL **highly flammable**
- Magnesium bromide etherate, 2.58 g, 10 mmol **highly flammable**
- Dichloro[1,3-bis(diphenylphosphino)propane]nickel(II), 0.026 g, 0.05 mmol **cancer suspect agent**
- Di-isopropylamine, 1.4 mL, 10 mmol **highly flammable**
- Butyllithium, 4.0 mL, 10 mmol **highly flammable, reacts violently with water, spontaneously flammable in air, causes burns, harmful by inhalation highly flammable**
- Ethanol (for coolant) **highly flammable**
- Acetone (for coolant) **highly flammable**
- Methanol **highly flammable, toxic by inhalation and if swallowed**
- Solid CO₂ (dry ice) **extreme cold, may cause burns, asphyxiation hazard**
- THF, 50 mL **highly flammable, may form peroxides, irritating to eyes and respiratory system**

Method

Preparation: All glass equipment is dried in an oven at 150°C, assembled while hot (use heat-resistant gloves), and allowed to cool under an atmosphere of dry nitrogen. THF is dried by sodium benzophenone as outlined in Chapter 2.

1. A three-necked round-bottomed flask (250 mL) is equipped with a gas-inlet tube,^a a pressure-equalizing dropping funnel, a condenser, and a Teflon[®]-coated magnetic stirrer bar. To the end of the condenser is attached a gas outlet connected to a trap to remove any HBr evolved.^b
2. The flask is charged with 3-hexylthiophene^c (10 g, 60 mmol), acetic acid (70 mL), and purged with Argon, and cooled in a water-bath at about 10°C.
3. Bromine in acetic acid (3.1 mL, 0.06 mmol, in 25 mL) is then added from the dropping funnel drop-wise over a period of about 1 h in order to ensure the temperature remains at about 10–15°C.
4. The material is stirred for a further 30 min in an ice-bath, and the mixture is then poured on to a mixture of water and crushed ice (approximately 100 mL) containing sodium metabisulfite (ca. 1 g). The crude product is then isolated by extraction with diethyl ether in a separating funnel, and the ether layer is then washed with three portions of sodium hydroxide solution (1 M) to remove the acetic acid. The product is finally purified under reduced pressure to give 2-bromo-3-hexylthiophene.

6: Conducting polymers from heterocycles

5. A dry three-necked flask (250 mL) is equipped with a condenser, a septum cap, a solid sample addition tube,^d and a Teflon[®]-coated magnetic stirrer. The addition tube is then charged with magnesium bromide etherate (2.58 g, 10 mmol). The condenser is then connected to the double manifold via a gas adapter and the flask is evacuated and then purged with argon.
6. Using dry syringes as outlined in the procedure for the use of butyllithium in Chapter 2,^e add to this flask dry di-isopropylamine^f (1.4 mL, 10 mmol), and dry THF (50 mL). Then at room temperature add butyllithium (4.0 mL, 2.5 M, 10 mmol). The mixture is then cooled in a dry ice/ethanol-bath (-40°C) and stirred for 40 min.
7. The mixture is then cooled to -78°C using a dry ice/acetone-bath and magnesium bromide etherate (2.58 g, 10 mmol) is added from the solid-addition adapter, and the reaction stirred at -78°C for 30 min. The reaction mixture is then warmed to -40°C (dry ice/ethanol) and stirred for a further 15 min.
8. The reaction is then slowly warmed to -5°C (ice-saltwater-bath), and an upturned funnel connected to the inert gas supply is placed just above the solid addition adapter, a gentle flow of argon is passed through this and the adapter quickly removed while Ni(dppp)Cl₂ (0.026 g, 0.05 mmol) is added (**Caution!**).^g The adapter is then quickly replaced and the inert gas supply removed.
9. The mixture is allowed to warm to room temperature overnight and the polymer precipitated by dropping into cold methanol, the solid is filtered at the water aspirator, washed with methanol, water and methanol, and dried in the vacuum oven at 30°C .^h

^aThis should allow nitrogen from the manifold to pass through the solution, an all-in-one piece is preferable to a screw thread arrangement through which a glass pipette is passed but in this case the complete exclusion of oxygen and water is not required.

^bAn upturned funnel immersed in water should suffice here.

^cSee Protocol 11.

^dThis consists of a bent tube with a male Quickfit joint. The powder is placed in the tube before the reaction the tube is then attached to one of the necks of the flask (not the central vertical one). The tube is then swivelled around when the solid is required. This arrangement allows the solid to be added in a completely air-free environment.³² Once the Grignard reagent is formed, the solid addition may be performed directly from one of the necks under a blanket of nitrogen.

^eThe syringe and needle are dried in the oven and allowed to cool in a desiccator, the syringe is then flushed with argon. A second needle attached to the inert gas supply is passed through the seal on the Sure-Seal bottle and the syringe needle is passed through the bottle seal.

^fDi-isopropylamine may be dried over calcium hydride and distilled under nitrogen prior to use, but the compound is available from Aldrich packaged in a Sure-Seal container.

^gSuch couplings are generally exothermic, for example, the addition of this nickel catalyst to a mixture of vinylchloride, and 4-chlorophenylmagnesium bromide in ether at 0°C leads after a short induction period to a violent uncontrollable reaction.³³ The scale and conditions used here, however, are sufficient to moderate the reaction.

^hMcCullough recommends the removal of oligomers by Soxhlet extraction with methanol, followed by hexane.³¹

6. Conclusions

This chapter has provided some examples of the ways in which conjugated polymers can be prepared. While the account is not of course exhaustive, and indeed many extremely important synthetic routes have not been included, such as the formation of polyacetylene by the ‘Durham’ route,³⁴ it does serve to illustrate that the range of synthetic techniques vary from the simple to the extremely sophisticated. Electrochemical synthesis is largely in the former classification, however, it does have considerable potential in the design of materials for molecular electronics since it will allow patterns to be formed on the electrode surface. With the continuing demand for new materials both for electronic and power distribution needs, it is to be expected that this area will continue to develop in the foreseeable future.

References

1. Shirakawa, H.; Ikeda, S. *Polym. J.* **1971**, *2*, 231.
2. (a) Feast, W. J. *Chem. Ind.* **1985**, 263. (b) Edwards, J. H.; Feast, W. J.; Bott, D. C. *Polymer* **1984**, *25*, 395–398.
3. Friend, R. H.; Gymer, R. W.; Holmes, A. B.; Burroughes, J. H.; Marks R. N.; Taliani, C.; Bradley, D. D. C.; Dos Santos, D. A.; Bredas, J. L.; Logdlund, M.; Salaneck, W. R. *Nature* **1999**, 397(6715), 121–128.
4. Bocchi, V.; Gardini, G. P. *J. Chem. Soc., Chem. Commun.* **1986**, 148.
5. Diaz, A. F.; Kanazawa, K. K.; Gardini, G. P. *J. Chem. Soc., Chem. Commun.* **1979**, 635.
6. Otero, T. F.; Arevalo, A. H. *Synth. Met.* **1994**, *66*, 25–32.
7. Kiani, M. S.; Bhat, N. V.; Davis, F. J.; Mitchell, G. R. *Polymer* **1992**, *33*, 4113–4120.
8. Mitchell, G. R.; Davis, F. J.; Cywinski, R.; Howells, W. S. *J. Phys. C: Solid State Phys.* **1988**, *21*, L411–L413.
9. Furniss, B. S.; Hannaford, A. J.; Smith, P. W. G.; Tachell, A. R. *Vogel's Textbook of Practical Organic Chemistry*, 5th edn; Longman Scientific: Essex, UK; **1988**.
10. Cross, M. G.; Walton, D.; Morse, N. J.; Mortimer, R. J.; Rosseinsky, R.; Simmonds, D. J. *J. Electroanal. Chem.* **1985**, *189*, 389.
11. Armes, S. P. *Synth. Met.* **1987**, *20*, 365–371.
12. (a) Langley, P. J.; Davis, F. J.; Mitchell, G. R. *J. Chem. Soc., Perkin Trans. 2*, **1997**, 2229. (b) Langley, P. J.; Davis, F. J.; Mitchell, G. R. *Mol. Cryst. Liq. Cryst.* **1993**, *236*, 225.
13. Jegou, C.; Agricole, B.; Vicentini, F.; Barrouillet, J.; Mauzac, M.; Mingotaud, C. *J. Phys. Chem.* **1994**, *98*, 13 408.
14. Perin, D. D.; Armarego, W. L. F. *Purification of Laboratory Chemicals*, 3rd edn; Pergamon: Oxford; **1988**.
15. Papadopoulos, E. P.; Haider, N. F. *Tetrahedron Lett.* **1968**, *14*, 1721.
16. Chen, Y.; Imrie, C. T.; Ryder, K. S. *J. Mater. Chem.* **2001**, *11*(4), 990–995.
17. Higgins, R. W. T.; Zaidi, N. A.; Monkman, A. P. *Adv. Funct. Mater.* **2001**, *11*(6), 407–412.
18. Macinnes, D., Jr.; Funt, B. L. *Synth. Met.* **1988**, *25*, 235–242.

6: Conducting polymers from heterocycles

19. Fite, C.; Cao, Y.; Heeger, A. J. *Solid State Commun.* **1989**, *70*, 245–247.
20. Tourillon, G. In *Handbook of Conducting Polymers*; Skotheim, T. A., ed., Marcel Dekker: New York; **1986**.
21. Roncali, J.; Yassar, A.; Garnier, F. *J. Chem. Soc., Chem. Commun.* **1988**, 581.
22. Bryce, M. R.; Chissel, A.; Kathirgamanathan, P.; Parker, D.; Smith, N. R. M. *J. Chem. Soc., Chem. Commun.* **1987**, 466–467.
23. Hassan, J.; Sévignon, M.; Gozzi, C.; Schulz, E.; Lemaire, M. *Chem. Rev.* **2002**, *120*, 1359–1469.
24. Yamamoto, T.; Arai, M.; Kokubo, H.; Sasaki, S. *J. Polym. Sci., Part A: Polym. Chem.* **2003**, *41*, 1449–1453.
25. Coulson, D. R. *Inorg. Synth.* **1972**, *13*, 121.
26. McCullough, R. D.; Lowe, R. D. *J. Chem. Soc., Chem. Commun.* **1992**, 70–72.
27. Chen, T. A.; Wu, X. M.; Rieke, R. D. *J. Am. Chem. Soc.* **1995**, *117*, 233–244.
28. McCullough, R. D.; Williams, S. P.; Tristramnagle, S.; Jayaraman, M.; Ewbank, P. C.; Miller, L. *Synth. Met.* **1995**, *69*(1–3), 279–282.
29. Roncali, J. *J. Mater. Chem.* **1999**, *9*, 1875–1893.
30. Dossantos, D. A.; Bredas, J. L. *J. Chem. Phys.* **1991**, *95*(9), 6567–6575.
31. McCollough, R. D.; Lowe, D. L.; Jayaraman, M.; Anderson, D. L. *J. Org. Chem.* **1993**, *58*, 904–912.
32. Casey, M.; Leonard, J.; Lygo, B.; Proctor, G. *Advanced Practical Organic Chemistry*; Blackie: Glasgow; **1990**.
33. Kumada, M.; Tamao, K.; Sumitani, K. *Organic Synthesis Collective Volumes 6*, Noland, W. E., ed., Wiley, NY, **1988**, p. 407.
34. Edwards, J. H.; Feast, W. J.; Bott, D. C. *Polymer* **1984**, *25*, 395–398.

Some examples of dendrimer synthesis

DONALD A. TOMALIA

1. Introduction

Dendrimers are highly branched macromolecules with unique structural properties. They may be thought of as core–shell type macromolecules wherein they amplify their mass and terminal groups as a function of growth stages. These growth stages are referred to as generations (i.e. $G = 0, 1, 2, \dots$). They possess three key architectural features: (i) a core region; (ii) interior shell zones containing cascading tiers of branch cells (generations) with radial connectivity to the initiator core; and (iii) an exterior or surface region of terminal moieties attached to the outermost generation. With this architecture, a careful choice of building blocks and functional groups can provide control over shape, dimensions, density, polarity, reactivity, and solubility.¹

One of the earlier dendrimers made, using a divergent strategy, is the Starburst[®] poly(amidoamine) (PAMAM) dendrimer family (Scheme 1).² This method involved assembling repeat units to introduce branch cells around the initiator core through successive chemical reactions at the periphery of the growing macromolecule. The first step of PAMAM synthesis involves Michael addition of four moles of methyl acrylate to the nucleophilic ethylenediamine core. This leads to an electrophilic carbomethoxy surface, which is then allowed to react with an excess of 1,2-diaminoethane to give a nucleophilic surface at generation zero. Reiteration of these two steps now involves addition of 8 mol of methyl acrylate to give $G = 0.5$ (electrophilic, carbomethoxy surface). This is followed by amidation to return to a nucleophilic surface at $G = 1.0$. As a result of this reiterative branch cell assembly, it is apparent that these constructions follow systematic dendritic branching rules, with radial symmetry giving a well-defined three-dimensional geometry to the final dendritic product.³

Editor's Note: Professor Tomalia is one of the pioneers of dendrimer chemistry, the importance of the work described here is reflected in the huge interest currently surrounding this topic.^{4–12}

7: Some examples of dendrimer synthesis

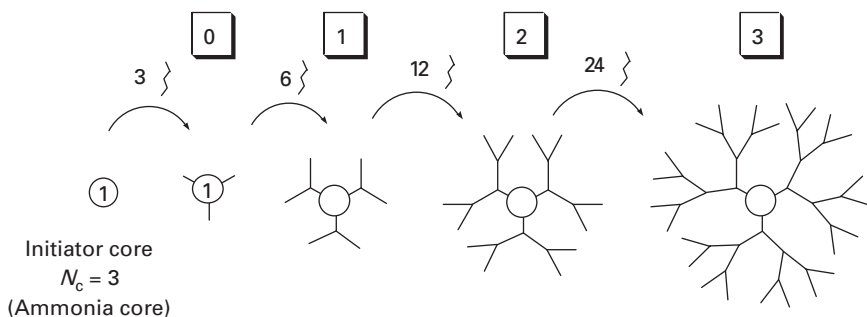
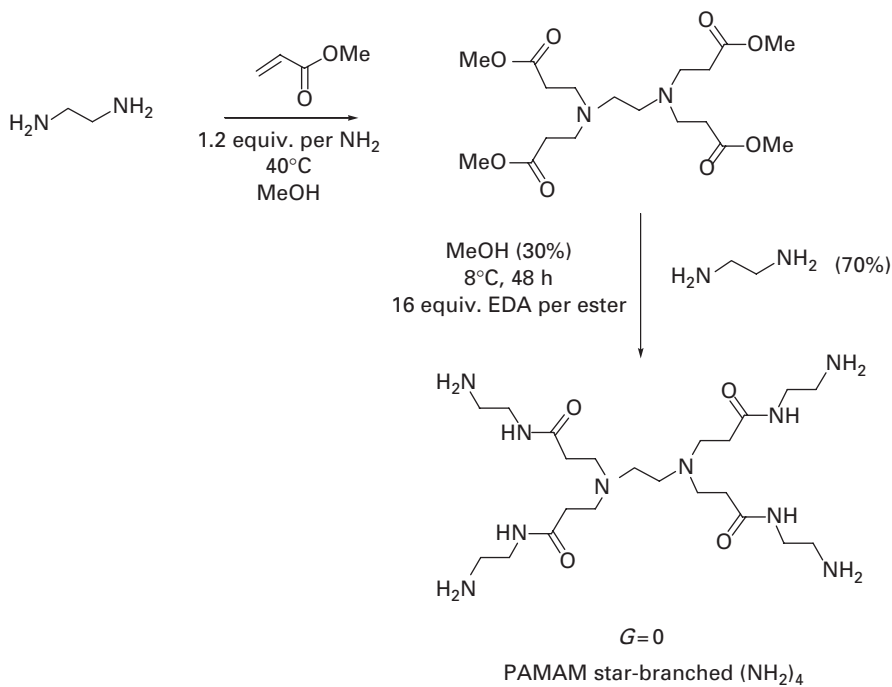

Scheme 1

In general, the placement of reactive functionalities on the exterior surface of the dendrimers allows introduction of a wide variety of terminal moieties. In alternate synthetic approaches, spacer groups have been deliberately introduced to relieve the steric hindrance in order to facilitate construction of the next generation. This may provide the possibility of enhancing interior cargo spaces for ‘guest–host’ type chemistry.¹³

2. Excess reagent method

Protocol 1.

Caution! Carry out all procedures in a well-ventilated hood, wear disposable vinyl or latex gloves, and chemical-resistant safety goggles.

Equipment

- Dual manifold (nitrogen/vacuum)
- Two-necked, round-bottomed flask (200 mL × 3)
- Nitrogen inlet
- Rotary evaporator
- Source of dry nitrogen
- Addition funnel (150 mL)
- Ice-bath
- Apparatus for azeotropic distillation: single-necked round-bottomed flasks, condenser, distillation head, thermometer, and adapter

Materials

- Methanol (HPLC grade), 300 mL
 - 1,2-Diaminoethane, 200 mL
 - Methyl acrylate, 100 mL
 - Toluene
- highly flammable, toxic by inhalation and if swallowed
flammable, harmful in contact with skin and if swallowed,
causes burns, may cause sensitization by skin contact**
- highly flammable, harmful by inhalation, in contact with skin, and
if swallowed, irritating to eyes, skin, and respiratory system,
may cause sensitization by skin contact
highly flammable, harmful by inhalation**

Method

Preparation: 1,2-Diaminoethane and methyl acrylate are freshly distilled prior to use.

Note: The following reaction mixtures must be cooled to ~0°C before adding together. All reaction mixtures must be kept under a blanket of nitrogen at all times.

Synthesis of star-branched ester-terminated precursor:

(core: 1,2-diaminoethane; $G = 0$); [*dendri*-PAMAM(CO₂Me)₄]

1. Prepare a solution of methyl acrylate (35 g, 37 mL, 0.407 mol) in methanol (10 mL) and transfer it to the two-necked round-bottomed flask in an ice-bath.
2. Prepare a solution of 1,2-diaminoethane (5 g, 5.5 mL, 0.083 mol) in methanol (10 mL) and transfer it to the addition funnel. Add the solution slowly over a period of 2 h, and monitor the rate of addition periodically to ensure that approximately 1.25 mL of this solution is added every 10 min. The final mixture must be stirred for 30 min at 0°C and then allowed to warm to room temperature followed by stirring for a further 24 h.
3. Remove the excess solvent under reduced pressure at 40°C, re-dissolve in (20 mL) methanol and evacuate as before, followed by drying the resulting colourless oil under vacuum (10⁻¹ mmHg, 40°C) overnight.

7: Some examples of dendrimer synthesis

4. Obtain NMR (^1H , ^{13}C), mass spectra, and size exclusion chromatography (SEC) of this product to assure product identity and quality for use in the next growth step.

Synthesis of PAMAM star-branched amine-terminated precursor:

(core: 1,2-diaminoethane; $G = 0$); [*dendri*-PAMAM(NH_2) $_4$]

Efficient branching amplification requires reactions with a very high degree of selectivity to minimize any structural defects. The tetradirectional amine terminated ($G = 0$) star-branched compound core (1,2-diaminoethane) is a key intermediate in the synthesis of highly pure dendrimeric macromolecules. This generation zero PAMAM intermediate is made by the controlled addition of the ester terminated precursor to a 100-fold excess of 1,2-diaminoethane. Formation of the amide linkage is highly exothermic and it is absolutely essential to keep the reaction below 40°C . Control of the reaction is obtained by adding the ester terminated dendrimer at -5°C . Dendrimer amidation versus bridging amidation are kinetically similar. To prevent both intradendrimeric cyclization as well as interdendrimer bridgings, a large excess of 1,2-diaminoethane is used. The excess can be removed to an undetectable level by azeotropic techniques.

5. Prepare a solution of ethylenediamine (37.56 g, 43 mL, 0.625 mol) in methanol (50 mL) and transfer it to a two-necked round-bottomed flask in an ice-bath.
6. Prepare a solution of PAMAM ($G = 0$) (5 g, 0.0125 mol) in methanol (20 mL) and transfer it to the addition funnel. Add the solution slowly over a period of 10 min and keep the temperature below 0°C . Stir the final mixture for 96 h at room temperature.
7. When ester groups are no longer detectable by NMR spectroscopy, remove the solvents under reduced pressure maintaining the temperature no higher than 40°C . Remove the excess 1,2-diaminoethane by using an azeotropic mixture of toluene and methanol. The remaining toluene can be removed by azeotropic distillation using methanol. Finally, remove the remaining methanol under vacuum (10^{-1} mmHg, 40°C , 48 h).
8. Dry the resulting colourless oil under vacuum (10^{-1} mmHg, 40°C) overnight.
9. Obtain NMR (^1H , ^{13}C), mass spectra, and SEC as this product will be used in the next step.

Synthesis of PAMAM dendrimer ester terminated:

(core: 1,2-diaminoethane; $G = 1.0$); [*dendri*-PAMAM(CO_2Me) $_8$]

10. Prepare a solution of methyl acrylate (12.9 g, 13.5 mL, 0.15 mol) in methanol (20 mL) and transfer it to a two-necked round-bottomed flask in an ice-bath.

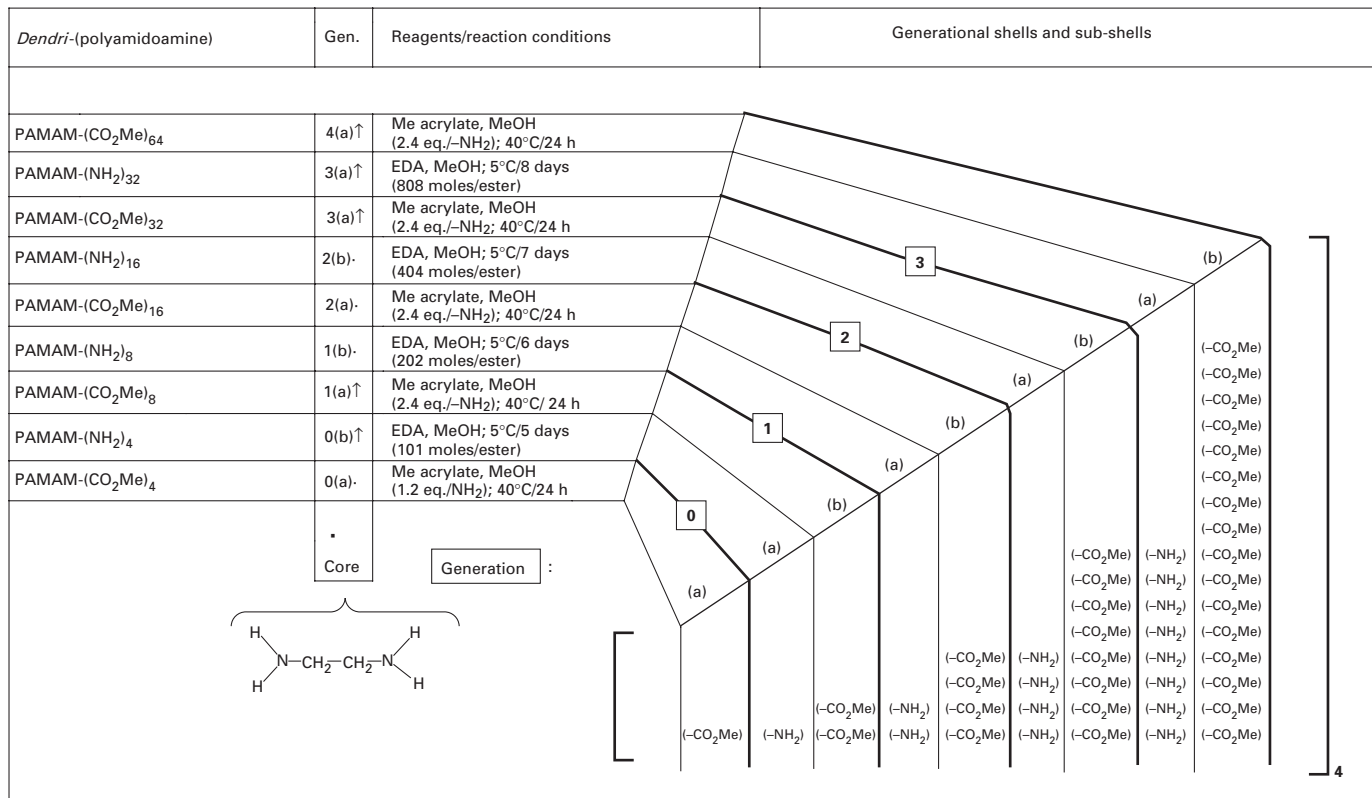

Fig. 7.1 Core Shell Sequencing® for the synthesis of PAMAM-dendrimers.

7: Some examples of dendrimer synthesis

11. Prepare a solution of PAMAM ($G = 0$, amine terminated) (8 g, 0.015 mol) in methanol (20 mL) and transfer it to the addition funnel. Add the solution slowly over a period of 1 h and keep the temperature below 0°C . Stir the final mixture for 24 h at room temperature.
12. Remove the excess solvent under reduced pressure at 50°C and dry the resulting colourless oil under vacuum (10^{-1} mmHg, 40°C) overnight.
13. Obtain NMR (^1H , ^{13}C), mass spectra, and SEC as this product will be used in the next step.

Synthesis of PAMAM dendrimer amine terminated:

(core: 1,2-diaminoethane; $G = 1.0$); [*dendri*-PAMAM(NH_2) $_8$]

14. Prepare a solution of ethylenediamine (60 g, 65 mL, 0.994 mol) in methanol (100 mL) and transfer it to a two-necked round-bottomed flask in an ice-bath.
 15. Prepare a solution of PAMAM ($G = 1.0$, ester terminated) (5 g, 0.004 mol) in methanol (20 mL) and transfer it to the addition funnel. Add the solution slowly over a period of 10 min and keep the temperature below 0°C . Stir the final mixture for 96 h at room temperature.
 16. When ester groups are no longer detectable by NMR spectroscopy, remove the solvents under reduced pressure maintaining the temperature no higher than 40°C . Remove the excess 1,2-diaminoethane by using an azeotropic mixture of toluene and methanol. The remaining toluene can be removed by azeotropic distillation using methanol. Finally, remove the remaining methanol under vacuum (10^{-1} mmHg, 40°C , 48 h).
 17. Dry the resulting colourless oil under vacuum (10^{-1} mmHg, 40°C) overnight.
 18. Obtain NMR (^1H , ^{13}C), mass spectra, and SEC. See Figure 7.1 for the synthesis of PAMAM-dendrimers.
-

3. Protection–deprotection method

A more compact Starburst[®] dendrimer can be designed which eliminates the need for excess reagent, by using ‘protect–deprotect’ schemes. In this synthetic approach, the reactive branch cell reagent contains multiple functionalities that are masked in a cyclic structure. For example, a bicyclic ortho ester structure may be used to mask three hydroxyl groups of pentaerythritol which leaves one unprotected hydroxyl group for coupling.¹⁴ An important requirement for this synthesis is the efficient formation of ether linkages. The synthetic amplification is initiated from a tetrabromide PE-Br₄ core. Branch cell reiteration is a four-step process involving: (a) nucleophilic displacement of bromide ions by alkoxide functionality; (b) mild acid hydrolysis of the bicyclic orthoester group to deprotected three hydroxyl groups/orthoester moiety; (c) tosylation of the hydroxyl groups; and finally

(d) bromide ion displacement of the tosylate groups to continue the sequence to the next generation level (Scheme 2). The chronological sequencing and amplification patterns for the poly(ether) dendrimers are illustrated in Figure 7.2.

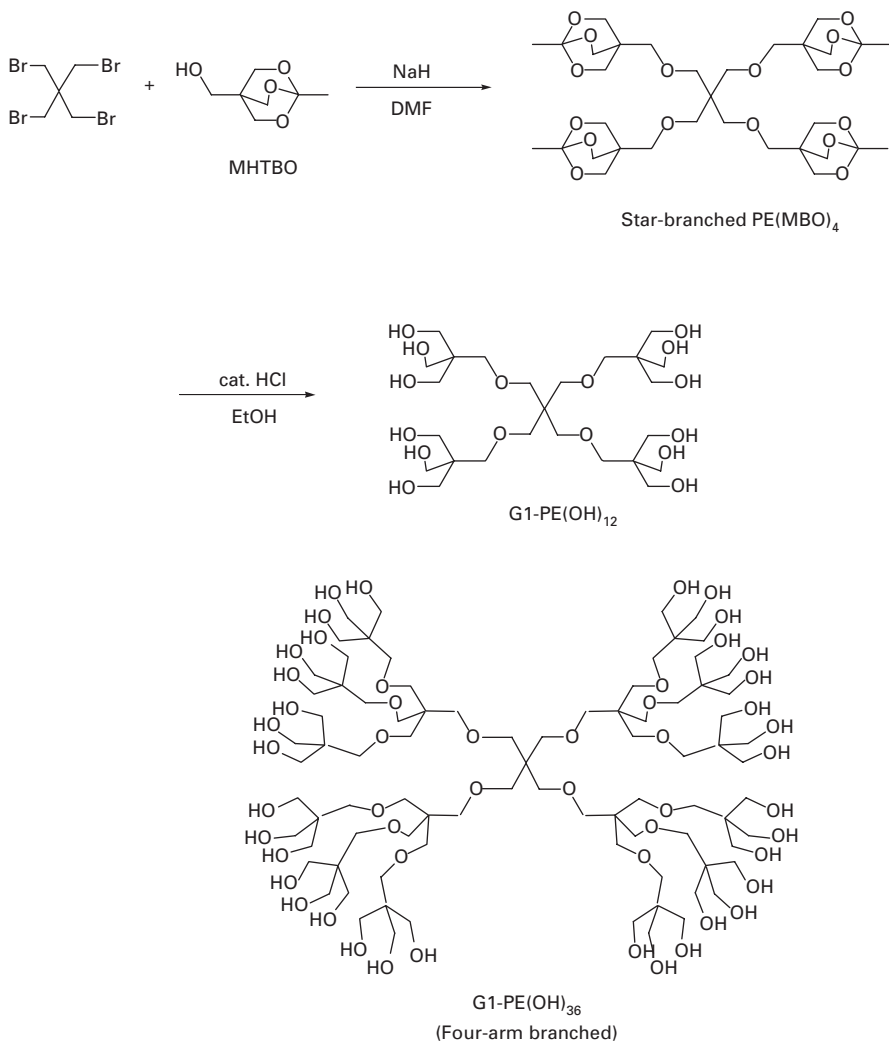

Scheme 2

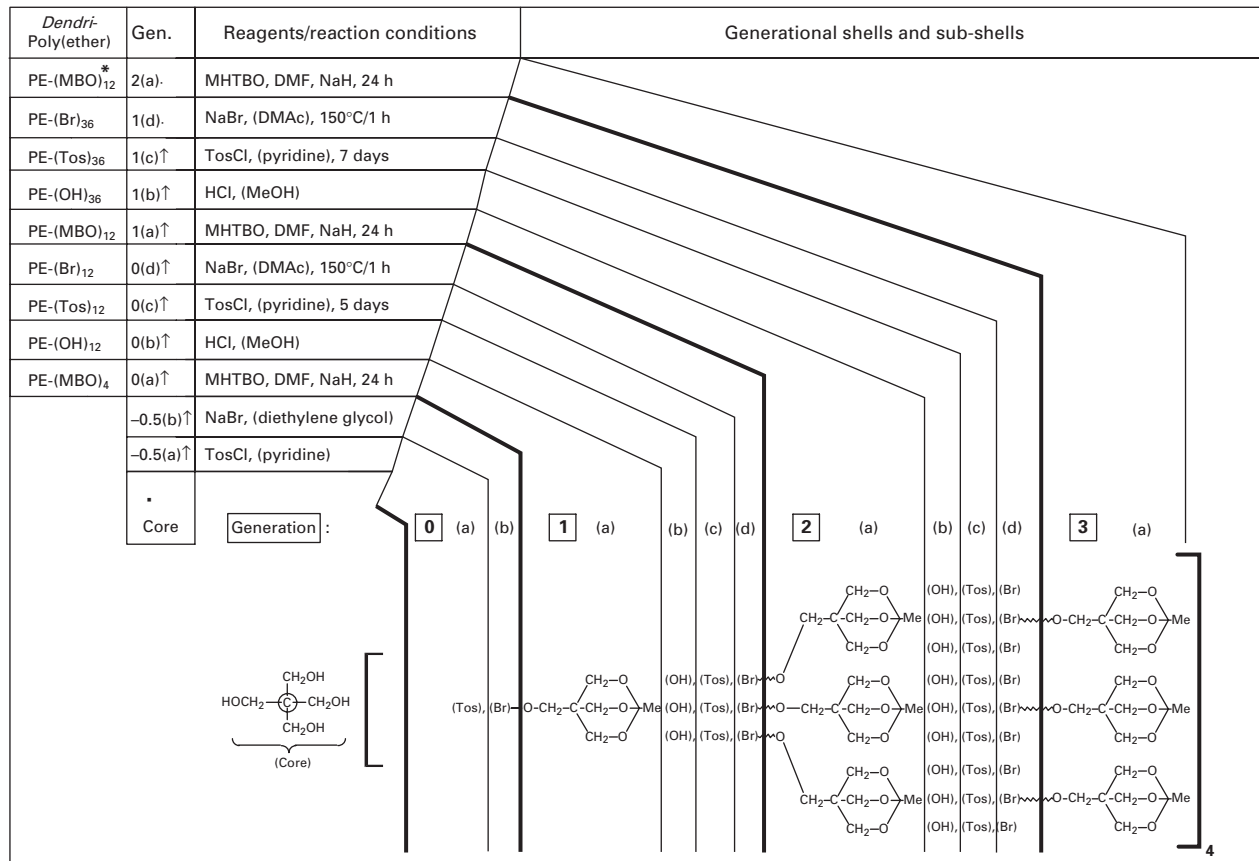

Fig. 7.2 Core Shell Sequencing® for the synthesis of PE-dendrimers.

Protocol 2.

Caution! Carry out all procedures in a well-ventilated hood, and wear disposable vinyl or latex gloves, and chemical-resistant safety goggles.

Equipment

- Dual manifold (nitrogen/vacuum)
- Single-necked, round-bottomed flasks (500 and 199 mL)
- Mechanical stirrer
- Dean–Stark trap
- Dewar condenser
- Hotplate Stirrer/oil-bath
- Vacuum oven
- Powder addition funnel
- Two-necked round-bottomed flasks (500 and 250 mL)
- Pressure-equalizing dropping funnel
- Source of dry nitrogen
- Gas-inlet adapter ($\times 2$)
- Addition funnel (150 mL)
- Condenser
- Septa
- Magnetic stirrer bar
- Apparatus for filtration, Erlenmeyer flasks, Buchner flasks, funnel, fast flow filter paper, and water aspirator.
- Erlenmeyer flasks (various sizes)
- Three-necked round-bottomed flask (500 mL)

Materials

- *p*-Toluenesulfonyl chloride, 18.7 g, 9.8 mmol **lacrymator, harmful on contact with the skin or if swallowed avoid skin contact**
- 1 methyl-4-hydroxymethyl-2,6,7-trioxabicyclo-[2,2,2]-octane (MHTBO), 50 g **potentially teratogenic, harmful in contact with skin, irritating to eyes**
- Dimethylformamide (DMF), ca. 250 mL **highly flammable, harmful by inhalation and in contact with the skin**
- Hexane, 400 mL **highly flammable, harmful by inhalation contact with water releases flammable gases, causes burns**
- Toluene, 250 mL **may impair fertility, potentially teratogenic irritating in contact with skin, eyes, and respiratory system**
- Sodium hydride (NaH), 8.3 g, 348 mmol (13.7 g of a 60% dispersion in mineral oil) **avoid skin contact**
- Dioctylphthalate, 200 mL **flammable, irritating to eyes and respiratory system**
- Pyridine *p*-toluenesulfonate (PPTS), 1 g, 4 mmol **avoid skin contact**
- Pentaerythritol, 27.2 g, 200 mmol **highly flammable, harmful by inhalation, in contact with the skin, and if swallowed**
- Triethyl orthoacetate, 32.44 g, 36.6 mL, 200 mmol **potential teratogen, harmful by inhalation and in contact with the skin**
- Pentaerythrityl tetrabromide, 20 g, 51.6 mmol, (206 mmol bromide)
- Pyridine, 140 mL
- *N,N*-Dimethylacetamide, 40 mL
- Sodium bromide, 8 g, 78 mmol **causes severe burns**
- Sodium chloride, 75 g **highly flammable, toxic by inhalation and if swallowed**
- HCl (conc.), 1.2 mL **harmful by inhalation, potential carcinogen**
- Methanol **highly flammable**
- Chloroform
- Ethyl acetate

Synthesis of the reactive branch cell Reagent: 1-methyl-4-hydroxymethyl-2,6,7-trioxabicyclo-[2,2,2]-octane (MHTBO)

1. To a round-bottomed flask (500 mL) equipped with a Dean–Stark trap fitted with a reflux condenser and a magnetic stirrer bar, add pentaerythritol (27.2 g, 200 mmol), triethyl orthoacetate (32.44 g, 36.6 mL, 200 mmol), PPTS (1 g, 4 mmol), and 200 mL of dioctylphthalate.
2. Attach the condenser to the dual manifold using a gas-inlet adapter, and place the system under a nitrogen atmosphere.^a Heat the reaction mixture on an oil-bath, with stirring at 140°C for 2–3 h under nitrogen until quantitative recovery of ethanol (32 mL theoretical) is obtained. Replace the nitrogen line with an aspirator vacuum (~25 mmHg) to remove the residual ethanol.
3. Replace the trap with a large Dewar condenser containing ice-water and evacuate the mixture at <0.1 mmHg.
4. Raise the bath temperature to 160°C to remove any residue product.
5. Dissolve the crude product in 250 mL of refluxing toluene, filter hot, and allow to cool to room temperature for 3 h. Leave this mixture in the freezer (–10°C) for 18 h. Filter the mixture in a Buchner funnel containing fast flow filter paper.
6. Allow the white solid to dry in air for 15 min and then vacuum dry at 25°C overnight.^b
7. Obtain NMR (¹H, ¹³C), and mass spectra, as this product will be used in the next step.

Synthesis of poly(ether) dendrimers from a pentaerythritol core PE(MBO)₄

8. To a two-necked 500 mL round-bottomed flask equipped with a mechanical stirrer, a powder addition funnel,^c and a rubber septum, add sodium hydride (7.3 g, 304 mmol, 12 g of a 60% dispersion in mineral oil) and 100 mL of hexane. Stir the mixture for 5 min then allow the reactants to settle to give a clear mixture and decant into a beaker of containing methanol. Repeat this procedure three times^d and then remove the mechanical stirrer and connect the system to the dual manifold using a gas inlet. Evacuate the greyish-white slurry at high vacuum to a constant weight of sodium hydride (6.5 g, 270 mmol). Then, with the flask under an atmosphere of nitrogen, add anhydrous DMF (150 mL) via a cannula.
9. Add MHTBO (39.2 g, 245 mmol) to the addition funnel and place under an inert atmosphere using the manifold system. Then add the MHTBO over ~30 min. After most of the gas evolution has ceased, heat at 60°C for 1.5 h until gas evolution has ceased completely.
10. Add pentaerythrityl tetrabromide (20 g, 51.6 mmol, 206 mmol bromide) to the above mixture.
11. Heat the mixture at 75°C for 22 h under nitrogen. Cool the mixture to 25°C and add drop-wise to a flask containing 1 L of a well-stirred ice-water.

Protocol 2. Continued

12. Filter this mixture in a large Buchner funnel containing fast flow filter paper. Wash the white solid with deionized water (4×100 mL) and dry the solid at 40°C under high vacuum overnight.
13. Obtain NMR (^1H , ^{13}C), mass spectra, and SEC, as this product will be used in the next step.

Synthesis of poly(ether): [*dendri*-PE(OH)₁₂]

14. Add PE(MBO)₄ (8 g, 11.4 mmol) to methanol (130 mL) in a two-necked round-bottomed flask (250 mL) equipped with a condenser and a dropping funnel.
15. Add 1.2 mL of concentrated HCl to the latter reaction mixture. Gently reflux for 1 h.
16. Add a Dean–Stark trap to the system (between the flask and condenser), distil methanol and methyl acetate until only about one-third of the solvent remains. Cool this mixture to 10°C .
17. Filter the precipitate and wash it with methanol. Dry the final product under high vacuum overnight at 25°C .
18. Obtain NMR (^1H , ^{13}C), mass spectra, and SEC, as this product will be used in the next step.

Synthesis of poly(ether): [*dendri*-PE(Tos)₁₂]

19. Add *dendri*-PE(OH)₁₂ (2 g, 3.29 mmol) to a flame-dried 500 mL three-necked flask equipped with a stirrer bar, a pressure-equalizing dropping funnel fitted with a rubber septum, a condenser, and a thermometer, and attached via the condenser to the dual manifold.
20. Add 40 mL anhydrous pyridine via a cannula. Cool the mixture to 0°C .
21. In a flame-dried flask prepare a solution of *p*-toluenesulfonyl chloride (18.7 g, 9.8 mmol, 30 equiv. per *dendri*-PE-(OH)₁₂) in 100 mL anhydrous pyridine.^e Cannula transfer this mixture to the dropping funnel. Add this solution from the dropping funnel to the PE-(OH)₁₂ solution maintaining the temperature at 0 – 5°C . Maintain the temperature at 0°C and stir for 1 h.
22. Seal the flask and leave the mixture at room temperature for 4 days.
23. Pour this mixture into 500 mL ice-water and decant the solvent after the precipitate has agglomerated at the bottom of the beaker.
24. Dry the crude product at 40°C under high vacuum overnight. Dissolve this solid in 100 mL of chloroform and filter the precipitate. Dry the final product under high vacuum overnight at 25°C .
25. Obtain NMR (^1H , ^{13}C), mass spectra, and SEC, as this product will be used in the next step.

Synthesis of poly(ether); [*dendri*-PE(Br)₁₂]

26. Add *dendri*-PE(Tos)₁₂ (6.35 g, 2.58 mol, 31 mmol Tos), 40 mL of anhydrous *N,N*-dimethylacetamide and sodium bromide (8 g, 78 mmol, 30 equiv. per

7: Some examples of dendrimer synthesis

PE(Tos)₁₂) to a 100 mL one-necked round-bottomed flask containing a stir bar.

27. Connect the flask to the manifold and heat the mixture at 150°C for 1.5 h with stirring under N₂, then cool to 25°C and pour into ice-water.
28. Filter the precipitate, wash it with deionized water, and dry the final product under high vacuum overnight.
29. Recrystallize from boiling ethyl acetate and vacuum dry the final product.
30. Obtain NMR (¹H, ¹³C) and mass spectra as this product will be used in the next step.

Synthesis of poly(ether): [*dendri*-PE(MBO)₁₂]

31. Weigh NaH (1.7 g, of a 60% dispersion in mineral oil, 1.0 g NaH, 43.5 mmol) and wash twice with 50 mL of hexanes, then vacuum dry at 30–40°C.
32. A two-necked round-bottomed flask (250 mL) containing a stirrer bar is equipped with a rubber septum and a reflux condenser, and connected to the nitrogen supply (dual manifold) with a gas-inlet adapter. Add sodium hydride (1.0 g, 43.5 mmol) to the flask and then anhydrous DMF (100 mL) via a cannula. Add MHTBO (5.8 g, 36.3 mmol, 2 equiv. per bromide) and heat the mixture at 60°C for 1.5 h. The evolution of hydrogen will cease within one hour and the mixture becomes homogeneous and clear.
33. Add *dendri*-PE(Br)₁₂ (2.0 g, 1.5 mol, 18 mmol bromide) to the mixture and heat at 140°C under N₂ with a reflux condenser attached for 22 h.
34. Cool the mixture to 25°C and pour into 800 mL of ice water containing 75 g of NaCl.
35. Filter the precipitate and wash it with deionized water (3 × 50 mL) and dry the final product under high vacuum at 70°C for 5 h then 25°C for 12 h.
36. Obtain NMR (¹H, ¹³C), mass spectra, and SEC.

^aThe manifold enables this to be done by evacuating the flask and then allowing nitrogen into the system (see Chapter 2).

^bThe product may be dried, for example, using a vacuum oven or a vacuum desiccator.

^cFor example, Aldrich supply funnels which are designed to deliver free-flowing granular material to reactions under vacuum conditions

^dThis procedure removes the mineral oil.

^eUsing a two-necked round-bottomed flask attached to the manifold using a gas inlet tube and fitted with a septum, see, for example, Chapter 2, Protocol 14.

References

1. Tomaila, D. A.; Baker, H.; Dewald, J.; Hall, M.; Kallos, G.; Martin, S.; Roeck, J.; Ryder, J.; Smith, P. *Polym. J. (Tokyo)* **1985**, *17*, 117–132.
2. Tomalia, D. A.; Baker, H.; Dewald, J.; Hall, M.; Kallos, G.; Martin, S.; Roeck, J.; Ryder, J.; Smith, P. *Macromolecules* **1986**, 2466–2468.
3. Smith, P. B.; Martin, S. J.; Hall, M. J.; Tomalia, D. A. In *Applied Polymer Analysis, and Characterization*; Mitchell, J. Jr., ed., Hanser Publishers: Munich; **1987**, pp. 357–385.

4. Zeng, F.; Zimmermann, F. C. *Chem. Rev.* **1997**, 97(5), 1681–1712.
5. Romagnoli, B.; Hayes, W. *J. Mater. Chem.* **2002**, 12, 767–799.
6. Fréchet, J. M. J.; Hawker, C. J. *Comprehensive Polymer Science*; 2nd Suppl., Aggaraval, S. L.; Russo, S., eds, Pergamon: Oxford; **1996**.
7. Voit, B. I. *Acta Polym.* **1995**, 46, 87–99.
8. Gitting, P. J.; Twyman, L. J. *Supramol. Chem.* **2003**, 15, 5–23.
9. Grayson, S. K.; Frechet J. M. J. *Chem. Rev.* **2001**, 101(12), 3819–3867.
10. Fischer, M.; Vogtle, F. *Angew. Chem., Int. Ed. Engl.* **1999**, 38(7), 885–905.
11. Inoue, K. *Prog. Polym. Sci.* **2000**, 25(4), 453–571.
12. Aulenta, F.; Hayes, W.; Rannard, S. *Eur. Polym. J.* **2003**, 39(9), 1741–1771.
13. Tomalia, D. A.; Naylor, A. M.; Goddard, W. A. III. *Angew. Chem.* **1990**, 102(2), 119–157, (*Angew. Chem., Int. Ed. Engl.* **1990**, 29(2), 138–175).
14. Padias, A. B.; Hall, H. K., Jr.; Tomalia, D. A.; McConnell, J. R. *J. Org. Chem.* **1987**, 52, 5305–5312.

New methodologies in the preparation of imprinted polymers

CAMERON ALEXANDER, NICOLE KIRSCH, and
MICHAEL WHITCOMBE

1. Introduction

Molecular imprinting is a rapidly emerging method for the creation of recognition sites in synthetic polymers,^{1–5} and the resultant materials offer considerable promise as selective adsorbents in a number of applications.^{6–16} The technique exploits the principle of using elements of a target molecule to create its own recognition site. This is achieved by the formation of a highly cross-linked polymeric matrix around a *template*, which can be the target molecule itself or a close structural analogue. The key to this procedure is to ensure that, during the polymerization, functional groups of the template molecule are fully engaged in interactions with ‘complementary functionality’ of polymer-forming components. These interactions are then ‘locked in’ by the incorporation of the whole assembly into the polymer structure. Subsequent removal of the template reveals the newly created binding sites containing functional groups in the precise stereochemical arrangement to ensure recognition of the target in a highly selective manner (Scheme 1).

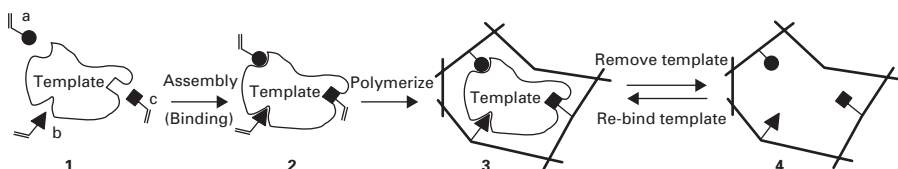

Scheme 1 Generalized depiction of the molecular imprinting technique: **1**—monomers a, b, and c form an attachment to complementary sites on the template. **2**—The pre-assembled template–monomer complex is polymerized with a large excess of cross-linker. **3**—The rigid polymer formed in this process retains an arrangement of functional elements complementary both in shape and spatial orientation to the template. **4**—Removal of the template reveals a binding pocket or cavity, which can be used to recapture the template species.

(a)

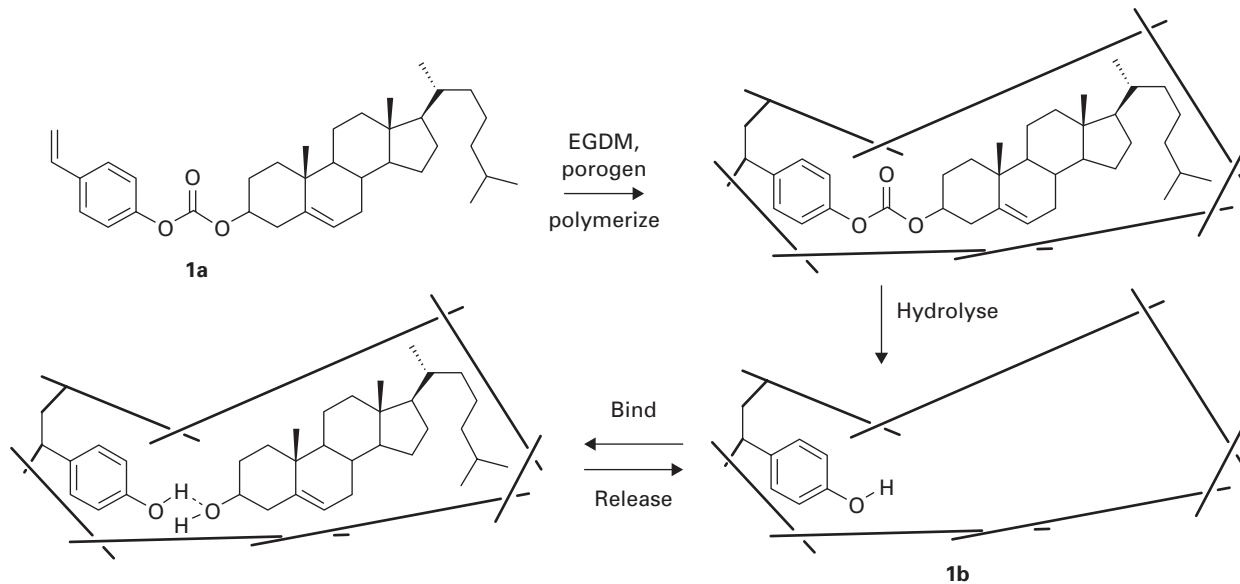

(b)

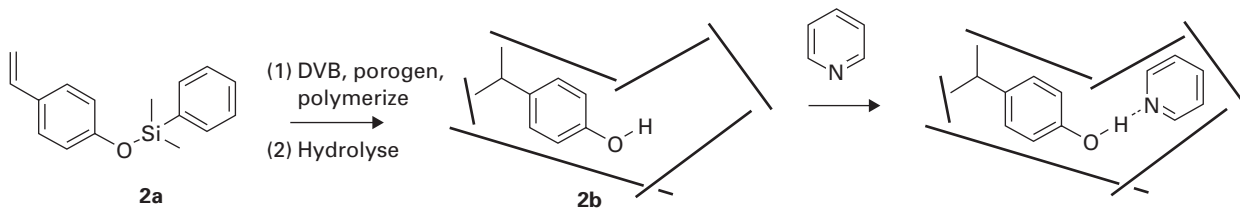

Scheme 2 The preparation of polymers by the 'sacrificial spacer' approach imprinted against: (a) cholesterol and (b) pyridine.

The first reports of molecular imprinting in organic polymers¹⁷ involved the templating of protected sugars, in the form of esters with a polymerizable boronic acid (however, see Ref. 18 for an earlier example of the imprinting concept) into a cross-linked polymer ‘scaffold’, and variations of the basic technique have now been adopted by many research groups around the world.¹⁹ In general, molecularly imprinted polymers (MIPs) are prepared by thermal or photochemical free-radical routes, employing acrylic or vinylic monomers in a solvent chosen to ensure that the final matrix is microporous. The numbers and types of molecules which have now been imprinted is very large, but a key factor in the preparation of MIP materials with the desired recognition properties is still the chemical nature of the link between the template and the polymer backbone. Consequently, strategies by which the template can be securely fixed in space as the growing matrix forms around it, yet be readily removed to generate the recognition site after polymer synthesis is complete, are of particular interest. A method in which these demands may be achieved is by *covalently* linking the template to a polymerizable monomer by a readily cleavable spacer group, which is designed in such a way that breakage of the template–polymer link yields functionality which can re-bind the template by *non-covalent* bonds. This is termed the *sacrificial spacer* approach, and two examples are given for the preparation of monomers (**1a**, **2a**) and polymers (**1b**, **2b**) designed to recognize a steroid, cholesterol,²⁰ and a simple heterocycle, pyridine,²¹ as shown in Scheme 2.

2. Sacrificial spacer approach

Protocol 1a.

Preparation of cholesteryl 4-vinylphenyl carbonate **1a** (Scheme 3)

Caution! Carry out all procedures in a well-ventilated fume-cupboard, wear appropriate protective gloves, a lab-coat, and safety glasses. All vacuum-line work should be performed while behind a protective blast-proof screen. Check all glassware for star cracks before using under vacuum and never use flat-bottomed flasks with rotary evaporators.

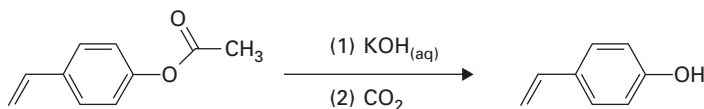

Scheme 3 Preparation of 4-vinylphenol.

Equipment

- Laboratory magnetic stirrer
- Three-necked reaction flask with addition funnel, thermometer, and guard tubes
- Ice-bath
- Separating funnel

Protocol 1a. Continued

- Teflon coated magnetic follower
- Ice salt bath
- Conical flasks (250 mL)
- Teflon coated magnetic follower
- Buchner flask, Buchner funnel, and filter paper

Materials

- | | |
|--|--|
| • 4-Acetoxy styrene 10 g, 62 mmol | harmful by inhalation, in contact with skin and, if swallowed corrosive, causes burns |
| • Cholesteryl chloroformate 7.5 g, 17 mmol | corrosive, harmful if swallowed, causes severe burns |
| • Potassium hydroxide 8.6 g, 153 mmol | extremely cold, may cause burns |
| • CO ₂ cylinder and trap or dry ice to generate CO ₂ gas | |
| • Tetrahydrofuran (THF), anhydrous | highly flammable, irritant, may form explosive peroxides, irritating to eyes and respiratory system |
| • Triethylamine, anhydrous 2.9 g, 4 mL, 29 mmol | highly flammable, corrosive, harmful by inhalation, in contact with skin, and if swallowed, causes severe burns |
| • Dichloromethane | carcinogen, harmful by inhalation |
| • Magnesium sulfate, dried | |
| • 2-Propanol (isopropanol) | highly flammable, irritating to eyes, vapours may cause drowsiness and dizziness |
| • Hexane | highly flammable, irritating to skin, harmful, danger of serious damage to health by prolonged exposure due to inhalation |

Method

Preparation of 4-vinylphenol: This method²⁰ was based on that originally published by Corson *et al.*²²

1. Dissolve 8.6 g of potassium hydroxide (8.6 g, 153 mol) in distilled water (85 mL) in a 250 mL conical flask, cool to room temperature.
2. Add THF (1 mL) and 4-acetoxy styrene (10 g, 62 mmol). Vigorously stir the reaction mixture at room temperature until the oily layer has completely dissolved in the aqueous part (approximately 1 h).
3. Filter the solution into a clean 250 mL flask and stand in an ice-bath.
4. Connect a Pasteur pipette or length of glass tube to a source of CO₂ gas via flexible tubing. If using a cylinder, include a Dreschel bottle or other trap to prevent liquid sucking-back into the cylinder head. Bubble CO₂ into the cooled mixture, with stirring, to precipitate the phenol.
5. Once precipitation is complete, filter off the crystals of the phenol, wash with water and dry under vacuum, alternatively the damp filtrate can be taken up

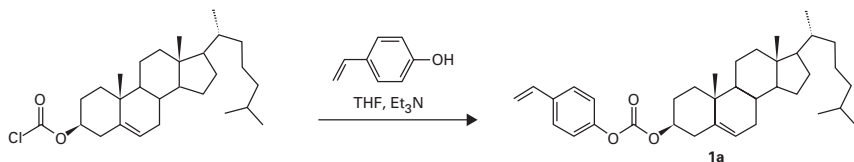

Scheme 4 Preparation of cholesteryl (4-vinyl)phenyl carbonate.

8: New methodologies for imprinted polymers

in diethyl ether, the solution dried with magnesium sulfate, filtered and evaporated before recrystallization from hexane. (This latter procedure is recommended for material used in Protocol 2a.) Store the 4-vinylphenol in the freezer.

Preparation of cholesteryl (4-vinyl)phenyl carbonate **1a**²⁰(Scheme 4)

1. In a 250 mL three-necked flask fitted with a thermometer and dropping funnel, dissolve 4-vinylphenol (2.0 g, 17 mmol) in a mixture of THF (60 mL) and triethylamine (4 mL). Close the flask with a calcium chloride or silica gel-filled guard tube (drying tube) and cool the solution to -10°C in an ice-salt-bath.
2. Dissolve cholesteryl chloroformate (7.5 g, 17 mmol) in 40 mL of THF and add this solution to the dropping funnel. Close the dropping funnel with a second guard tube (alternatively use a stoppered pressure-equalizing dropping funnel).
3. Add the solution of chloroformate drop-wise to the stirred solution of phenol such that the temperature of the reaction mixture does not rise above 0°C . A white precipitate of triethylamine hydrochloride will form as the reaction proceeds. When the addition is complete, remove the ice-bath and allow the flask to warm to room temperature.
4. After stirring for a further 3 h, or overnight if preferred, transfer the contents of the flask to a single-necked flask and remove the solvent by rotary evaporation, keeping the temperature below 40°C .
5. Dissolve the solid residue in 100 mL of dichloromethane and transfer to a separating funnel. Wash the lower organic layer twice with 50 mL of water and once with the same volume of brine. Dry the dichloromethane solution with magnesium sulfate, filter and evaporate.
6. Recrystallize once or twice from isopropanol or aqueous acetone. The product will be recovered as colourless crystals, m.pt $146-147^{\circ}\text{C}$.

Protocol 1b.

Preparation of cholesterol-imprinted polymer²⁰ **1b**

Equipment

- Vacuum line
- Quickfit test tube and vacuum stopcock adapter
- Thermostatically controlled water-bath
- Grinding equipment
- Sieves for particle sizing, if required
- Sintered-glass funnel and filter flask
- Soxhlet extractor, paper thimble, flask, and heating mantle
- Single-necked round-bottomed flask (50 mL)
- Reflux condenser

Materials

- Ethyleneglycol dimethacrylate
- (EGDMA) inhibitor-free^a 8.34 mL, 8.76 g, 44.2 mmol
- Toluene^b

irritant

highly flammable, harmful by inhalation

Protocol 1b. *Continued*

- | | |
|---|---|
| • Hexane ^{b,c} | highly flammable, irritating to skin, harmful: danger of serious damage to health by prolonged exposure through inhalation |
| • Azo- <i>bis</i> -isobutyronitrile (AIBN)
(0.149 g, 0.9 mmol) | explosive, harmful, risk of explosion by shock, friction, fire, or other sources of ignition, highly flammable, harmful by inhalation and if swallowed |
| • Methanol | highly flammable, toxic by inhalation, in contact with skin, and if swallowed |
| • Sodium hydroxide | corrosive, causes severe burns |
| • Hydrochloric acid | corrosive, causes burns, irritating to respiratory system |

Method

Preparation of imprinted polymer incorporating cholesteryl (4-vinyl)phenyl carbonate²⁰**1b^d**

1. For the preparation of 10 g of polymer: place cholesteryl (4-vinyl)phenyl carbonate (1.24 g, 2.33 mmol), EGDMA (8.34 mL, 8.76 g, 44.2 mmol), AIBN (149 mg, 1 mol%), toluene (2 mL), and hexane (18 mL) in a Quickfit test tube of a capacity such that the tube is no more than a third full. Agitate to dissolve the contents.
2. Lightly lubricate the glass joint with vacuum grease to prevent polymer from forming between the glass surfaces, close the tube with a vacuum stopcock and attach to a vacuum line.
3. Freeze the tube contents with liquid nitrogen.
4. Open the vacuum inlet and evacuate the headspace in the tube.
5. Close the stopcock, remove the liquid nitrogen Dewar and allow the tube contents to thaw. Dissolved air will outgas as the polymerization mixture melts. Thawing can be assisted by the application of a beaker containing warm water.
6. Once thawed, nitrogen gas can be admitted to the tube to equalize the pressure.
7. Repeat steps 3–6 for two more cycles, except on the last cycle do not admit nitrogen, but leave the contents of the tube at reduced pressure.
8. Remove the sealed tube from the vacuum line and submerge it to just above the level of the contents in a thermostatted water-bath at 65°C. Ensure that the tube contents are a homogeneous solution by agitation if necessary. The contents of the tube should begin to solidify within the first 5–10 min of heating but the polymerization should be continued for around 24 h. Maintain the water level in the bath during this time.
9. Remove the tube containing the white block of polymer from the bath and allow to cool.
10. Open the tube after releasing the vacuum and clean any vacuum grease from the ground-glass joint with a tissue moistened with ethyl acetate.
11. Hold the base of the tube in a cloth in case of breakage and chip the polymer into manageable pieces with the end of a spatula and collect the chunks of polymer in a filter funnel. Small pieces of material can be washed from the

8: New methodologies for imprinted polymers

tube using methanol. It is not normally necessary to break the glass in order to recover the polymer.

12. Wash the polymer particles well with methanol and allow to air-dry on the filter funnel.
13. Transfer the polymer to a mill and grind to a powder.
14. Collect the polymer powder and place it in a Soxhlet thimble. **Caution!** Do not inhale the dust.
15. Extract the polymer with methanol in a Soxhlet apparatus for 12 h to remove initiator fragments and unreacted monomers.
16. Dry the polymer in a vacuum oven or vacuum desiccator.

Template removal:²⁰

1. Weigh 2.5 g of the polymer and 1 g of sodium hydroxide in a 50 mL round-bottomed flask and add 25 mL of methanol.
2. Fit a reflux condenser to the flask and lower into an oil-bath at 90°C. Stir the mixture while heating under reflux for up to 6 h.
3. Cool the flask and pour the contents into a beaker containing 250 mL of water and 12 mL of concentrated hydrochloric acid. Stir the mixture for 20 min.
4. Filter-off the polymer and wash carefully on the filter with water, 50 : 50 water/methanol and methanol.

^aThe inhibitor can be removed by washing the EGDMA with dilute sodium hydroxide solution (approx. 0.1 M) in a separating funnel, followed by washing with water, then with saturated brine, and drying the organic layer over calcium chloride. As the density of this monomer is close to that of water, separation of the layers can be troublesome. A better separation can be achieved by the addition of some brine to the hydroxide solution and to the water-wash until the layers are clearly defined (organic layer uppermost). Alternatively, the monomer can be treated with base and washed as a solution in diethyl ether and the excess solvent removed by rotary evaporation using a cool water-bath after the drying step. This procedure can be carried out in advance and the de-inhibited monomer stored in a refrigerator for up to a week before use. A final 'polish' can be applied to the monomer by filtration through a short column of activated neutral alumina before use.

^bToluene and hexane were both distilled from calcium hydride before use.

^cIsohexane (Merck or Fisher Scientific) can be used as a less toxic alternative to *n*-hexane.

^dEssentially, the same basic protocol can be adapted for the preparation of non-covalently imprinted polymers. In this case, the cholesterol template monomer is replaced by the template to be imprinted and additional functional monomer (or monomers) is included in the polymerization mixture, at a pre-determined molar ratio with respect to the template. Typical functional monomers might be chosen from amongst: methacrylic acid, itaconic acid, vinylpyridine, dimethylaminoethyl methacrylate, acrylamide, hydroxyethyl methacrylate, and many more. Typical solvents for non-covalent imprinting include chloroform, THF, and acetonitrile. Templates are removed from non-covalently imprinted polymers by exhaustive washing with a suitable solvent.

Protocol 2a.

Preparation of (4-vinylphenoxy)dimethylphenylsilane²¹ 2a (Scheme 5)

Caution! This procedure should be carried out in a well-ventilated fume-cupboard, wear appropriate protective gloves, a lab-coat, and safety glasses. All

Protocol 2a. Continued

vacuum-line work should be performed while behind a protective blast-proof screen. Check all glassware for star cracks before using under vacuum and never use flat-bottomed flasks with rotary evaporators.

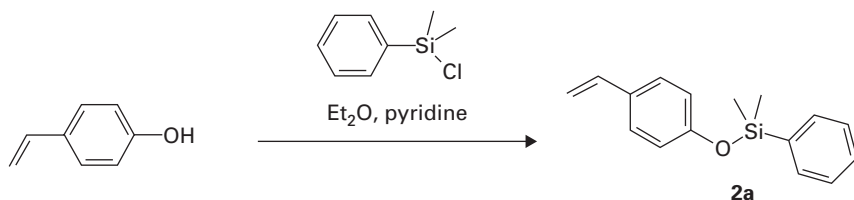

Scheme 5 Preparation of 4-vinylphenoxydimethylphenylsilane.

Equipment

- Laboratory magnetic stirrer
- 50 mL Two-necked round-bottomed flask equipped with septa and stopcock
- 2 mL and 10 mL gas-tight syringes
- Source of dry nitrogen gas
- Rotary evaporator
- Mini distillation kit
- Vacuum line

Materials

- 4-Vinylphenol 3 g, 24 mmol
 - Pyridine, anhydrous 2 mL
 - Diethyl ether, dried over sodium and freshly distilled before use 20 mL
 - Chlorodimethylphenylsilane 4.27 g (4.2 mL), 25 mmol
 - 2,6-Di-tert-butyl-4-methylphenol (BHT) trace ca. 5 mg
- corrosive, treat as harmful highly flammable, harmful by inhalation, in contact with skin, and if swallowed extremely flammable, may form explosive peroxides, harmful if swallowed, vapours may cause drowsiness and dizziness corrosive, causes burns, irritating to respiratory system irritant**

Method

Preparation of 4-vinylphenoxy dimethylphenylsilane **2a**

1. Weigh 4-vinylphenol (3.0 g, 24 mmol) into a 50 mL two-necked flask.
2. Purge the flask with dry nitrogen and seal with a tight-fitting rubber septum.
3. Using gas-tight syringes, charge the flask with diethyl ether (20 mL) and pyridine (2 mL) and stir to mix thoroughly.
4. Add chlorodimethylphenylsilane (4.2 mL, 4.27 g, 25 mmol) drop-wise to the reaction mixture via syringe. A white precipitate of pyridine hydrochloride will form as the reaction proceeds.
5. Stir the contents of the flask for 2 h, remove the precipitate by filtration and wash the solid obtained with dry diethyl ether.
6. Combine the ether fractions and add a few crystals of BHT, as 4-vinylphenoxydimethylphenylsilane readily polymerizes on standing.
7. Evaporate the solvent and distill the residue under reduced pressure to obtain a colourless liquid, b.p. 104–106°C/0.2 mbar.

Protocol 2b. Preparation of 4-vinylphenoxydimethylsilane-imprinted polymer²¹ 2b

Equipment

- Vacuum line
- Quickfit test tube and vacuum stopcock adapter
- Thermostatically controlled water-bath
- Grinding equipment
- Sintered-glass funnel and filter flask
- Soxhlet extractor, paper thimble, flask, and heating mantle

Materials

- | | |
|---|---|
| • Divinylbenzene (DVB),
inhibitor-free ^a 2.70 mL, 2.47 g, 19 mmol | irritant |
| • Hexane ^b 5 mL | highly flammable, irritating to skin, harmful: danger of serious damage to health by prolonged exposure through inhalation |
| • AIBN 64 mg, 0.4 mmol | explosive, harmful, risk of explosion by shock, friction, fire, or other sources of ignition, highly flammable, harmful by inhalation and if swallowed |
| • Methanol | highly flammable, irritating to skin, harmful: danger of serious damage to health by prolonged exposure through inhalation |
| • Hydrochloric acid 20 mL,
(5 M in methanol) | corrosive, causes burns, irritating to respiratory system |
| • Tetrahydrofuran | highly flammable, irritant, may form explosive peroxides, irritating to eyes and respiratory system |

Method

Preparation of polymer incorporating 4-vinylphenoxydimethylsilane²¹

1. For the preparation of 2.5 g of polymer: place 4-vinylphenoxydimethylsilane (254 mg, 1 mmol), DVB (2.70 mL, 2.47 g, 19 mmol), AIBN (64 mg, 1 mol%), and hexane (5 mL) in a 25 mL Quickfit test tube. Agitate to dissolve the contents.
2. Lightly lubricate the glass joint with vacuum grease to prevent polymer from forming between the glass surfaces, close the tube with a vacuum stopcock and attach to a vacuum line.
3. Freeze the tube contents with liquid nitrogen, and degas the solution as described in Protocol 1b.
4. Remove the sealed tube from the vacuum line and heat in thermostatted water bath at 65°C for 24 h. The onset of polymerization may not be easy to detect, but gelation should occur within a few hours.
5. At the end of the reaction time, remove the tube from the water-bath and allow to cool.
6. Carefully admit air to the tube and remove any vacuum grease from the ground-glass joint.
7. Recover the polymer from the tube as set out in Protocol 1b: it should be noted that divinylbenzene-based polymers can be very brittle and so it is necessary to be careful to avoid glassware breakage and risk of injury.

Protocol 2b. Continued

8. Wash the obtained polymer with methanol and allow to air-dry on the filter funnel.
9. Transfer the polymer particles into a mill (e.g. Fritsch Pulverisette 'O' grinding mill) and grind to a fine powder.
10. Collect the polymer powder and place it in a Soxhlet thimble (avoid inhalation of dust).
11. Extract the polymer with methanol in a Soxhlet apparatus for 12 h, then dry the polymer at 80°C under vacuum.

Template removal

1. Weigh 1.0 g of the polymer in a 50 mL round-bottomed flask and add 20 mL of HCl, diluted to 5 M with methanol.
2. Fit a reflux condenser to the flask and lower into an oil-bath at 80°C. Stir the mixture while heating under reflux for up to 6 h.
3. Cool the flask and filter the polymer.
4. Wash the polymer carefully on the filter with methanol/water, methanol, and THF and allow to air-dry.
5. Extract the polymer with diethyl ether and then dry under vacuum at 80°C.

^aThe inhibitor can be removed by extraction with base using a procedure similar to that for EGDMA, see footnote a, Protocol 1b, above.

^bSee footnote c, Protocol 1b, above.

3. Preparation of bacteria-imprinted polymers

The components typically used to prepare MIPs include acrylic acid, ethyleneglycoldimethacrylate, or divinylbenzene in solvents such as chloroform or toluene, and polymers prepared in this way are generally in the form of a bulk monolith, with a highly cross-linked microporous structure. In order to expose binding sites deep within the matrix, the polymers are then ground to a fine powder. As a result, most investigations of the molecular imprinting technique have been limited to small organic molecules as the templates to overcome the difficulties of diffusion into the polymer matrix. However, to imprint larger species, such as macromolecular aggregates, or even whole cells, a different methodology is required such that the recognition sites can be generated in easily accessible surfaces. The protocol involves polymer synthesis at an aqueous/organic interface under conditions where loss of cell structure and viability are kept to a minimum. In order to imprint bacteria such as, for example, *Listeria monocytogenes* or *Salmonella enteritidis* full microbiological safety precautions should be used, in addition to conventional techniques for handling reactive and corrosive chemicals.

Protocol 3.

Preparation of bacteria-imprinted polymer beads²³

Caution! This procedure should be carried out in a well-ventilated fume-cupboard with a UV shield in a laboratory equipped to Category 2 Microorganism Handling Standards. UV protective glasses, disposable gloves, and full length laboratory coat should be worn throughout.

Equipment

- Shaker/Incubator
- Centrifuge
- IKA-MINI-MR stirrer
- Beaker (500 mL, tall form)
- Glass crystallizing dish
- Dropping funnel (50 mL)
- Source of nitrogen
- Blak-Ray B-100A UV lamp
- Zeiss confocal laser scanning microscope (LSM 1D), 488 nm argon ion laser
- Nikon F301 camera

Materials

- | | |
|--|--------------------------------------|
| • Poly(allylamine) (PAA), $M_w = 100\ 000$ | irritant |
| • (3- <i>N</i> -morpholino)propylsulphonic acid (MOPS) | irritant |
| • Acridine orange 1 mL (10 mg mL ⁻¹) | possible mutagen |
| • FITC-Concanavalin A | irritant, harmful |
| • 1,6-Hexanedioldiacrylate 14.5 g, 14.4 mL, 64 mmol | harmful, flammable |
| • Adipoyl chloride 1.5 g, 1.2 mL, 8.2 mmol | harmful, corrosive, lachrymator |
| • AIBN 300 mg, 1.8 mmol | keep cold, may decompose explosively |
| • 1-Ethyl-3-(3-dimethylaminopropyl)carbodiimide (EDC) 5 mg, 0.025 mmol | harmful |
| • Dibutyl ether (DBE) 14.4 mL | harmful, flammable |
| • 1,1,2-Trichlorotrifluoroethane 270 mL | harmful |
| • FOMBLIN™ Diisocyanate 1.5 g | irritant |
| • Sodium acetate | |
| • Manganese chloride | |
| • Calcium chloride | |
| • Sodium chloride | |
| • Methanol | toxic, flammable |
| • Ethanol | flammable |
| • Nutrient broth | |
| • Coryneform broth | |
| • Methanolic HCl 6N, 150mL | toxic flammable, causes burns |

Method

Growth and staining of microorganisms

1. Obtain suspensions of microorganisms by overnight growth at 37°C of stock cultures in nutrient broth (*S. enteritidis*) or coryneform broth (*L. monocytogenes*).
2. Centrifuge 6 mL suspensions of cells (8000 rpm, 10 min), remove supernatant and resuspend in MOPS buffer (pH 7.8, 0.6 M, 10 mL).
3. Add acridine orange solution (10 mg mL⁻¹, 1 mL) and incubate for 3 h.

Protocol 3. Continued

4. Centrifuge the stained cells (5 min, 3000 rpm), remove the supernatant, and re-suspend bacterial pellets in MOPS buffer (pH 7.8, 0.6 N, 10 mL) by vortex mixing (30 s).

Preparation of polymeric beads in the presence of microorganisms
(see Figure 8.1):

1. Stir a solution of MOPS buffer (pH 7.8, 0.6 N, 250 mL) in a reaction vessel (500 mL tall-form beaker) equipped with a magnetic bar at setting 5 over a IKA-MINI-MR stirrer plate whilst passing a steady stream of nitrogen via a Pasteur pipette for 10 min.
2. Prepare a solution of adipoyl chloride (1.2 mL, 1.5 g, 8.2 mmol) in a mixed organic phase containing dibutyl ether (14.4 mL), 1,6-hexanediol diacrylate (14.4 mL, 14.5 g, 64 mmol), and AIBN (300 mg, 1.8 mmol), and add to the MOPS buffer.
3. Remove the Pasteur pipette and cover the beaker with glass crystallizing dish.
4. Increase the stirrer speed to setting 6 for 2 min to disperse the organic droplets.
5. Remove the covering dish and add rapidly a suspension of *L. monocytogenes* (acridine orange stained, 200 μ L of 10^{10} cfu mL⁻¹) in MOPS buffer (50 mL) and continue stirring for 3 min.
6. Add the PAA solution (0.2 M eq. in 0.6 M MOPS, pH 7.8, 45 mL) drop-wise with MOPS (30 mL of 0.6 M).
7. Assess capsules for bacterial attachment by Confocal Laser Scanning Microscopy (CLSM).
8. Re-cover the beaker with crystallizing dish and irradiate contents of the beaker with UV (Blak-Ray B-100A lamp) with stirring for 12 h.
9. Filter the resultant polymer beads, wash with water (3×100 mL) and methanol (3×100 mL) and allow to dry in air.

Surface modification of polymer beads with attached microorganisms

1. Stir rapidly the polymer beads (1.0 g) in 1,1,2-trichlorotrifluoroethane (250 mL) whilst adding drop-wise a solution of FOMBLIN diisocyanate (1.5 g, perfluoropolyether, diisocyanato terminated) in 1,1,2-trifluorotrifluoroethane (20 mL) via a funnel equipped with a drying tube.
2. Continue stirring for 3 h before adding the suspension to methanol (250 mL). Filter the suspension and wash the beads with further methanol (5×100 mL).

Removal of microorganisms from polymer surfaces

1. Reflux a suspension of polymer beads with attached microorganisms (250 mg) in 6 M HCl/methanol (150 mL) for 36 h, with regular monitoring of the extent of cell removal by scanning electron microscopy.
2. Filter the beads and wash repeatedly in methanol (5×250 mL) and dry in air.

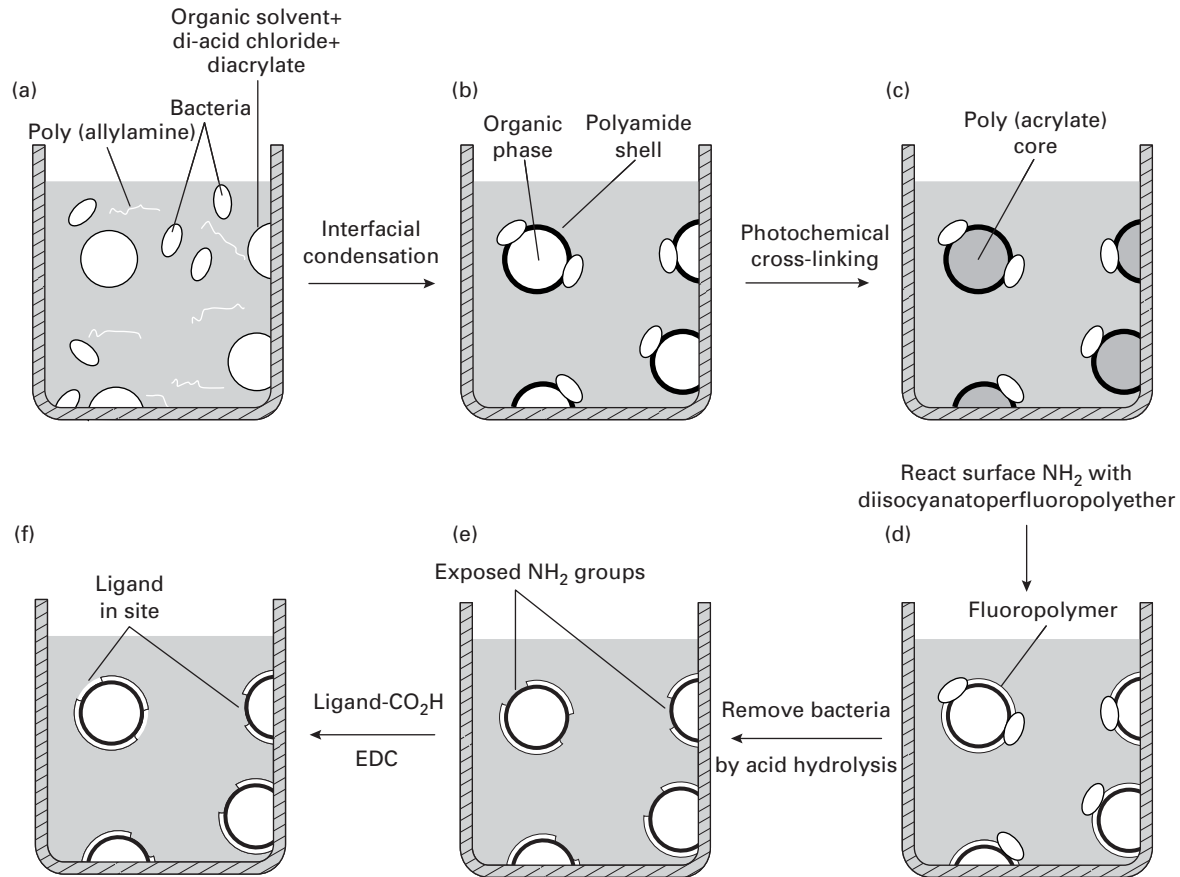

Fig. 8.1 Diagram showing the stages in the formation of bacteria-imprinted polymer beads.

Protocol 3. Continued

Fluorescent-labelling of imprinted sites at polymer surface

1. Prepare a buffer solution (sodium acetate 50 mM, 5 mM MnCl₂, 5 mM CaCl₂, 5 mL), add ethanol (500 μL) and a suspension of beads (100 mg), and stir gently whilst adding FITC-Concanavalin A (1 mg, ~0.0001 mmol).
 2. Adjust the pH of the solution to 4.75 and then add EDC (5 mg, 0.025 mmol) in acetate buffer (1 mL).
 3. Continue the reaction overnight with gentle shaking.
 4. Wash the beads with water (5 × 10 mL) and MeOH (5 × 10 mL).
-

References

1. Wulff, G. *Angew. Chem. Int. Ed. Engl.* **1995**, *34*, 1812.
2. Shea, K. J. *Trends Polym. Sci.* **1994**, *2*, 166.
3. Haupt, K. *Chem. Commun.* **2003**, 171.
4. Whitcombe, M. J.; Vulfson, E. N. *Adv. Mater.* **2001**, *13*, 467.
5. Sellergren, B., ed. *Molecularly Imprinted Polymers: Man-Made Mimics of Antibodies and their Applications in Analytical Chemistry*; Elsevier: Amsterdam; **2001**.
6. Whitcombe, M. J.; Alexander, C.; Vulfson, E. N. *Synlett* **2000**, 911.
7. Alexander, C.; Davidson, L.; Hayes, W. *Tet.* **2003**, *59*, 2025.
8. Wulff, G. *Chem. Rev.* **2002**, *102*, 1.
9. Takeuchi, T.; Haginaka, J. *J. Chromatogr. B* **1999**, *728*, 1.
10. Stevenson, D. *Trends Anal. Chem.* **1999**, *18*, 154.
11. Sellergren, B.; Andersson, L. I. *Meth.—A Companion Meth. Enzymol.* **2000**, *22*, 92.
12. Schweitz, L.; Spégel, P.; Nilsson, S. *Electrophoresis* **2001**, *22*, 4053.
13. Remcho, V. T.; Tan, Z. J. *Anal. Chem.* **1999**, *71*, A248.
14. Ramström, O.; Skudar, K.; Haines, J.; Patel, P.; Brüggemann, O. *J. Agric. Food Chem.* **2001**, *49*, 2105.
15. Piletsky, S. A.; Turner, A. P. F. *Electroanalysis* **2002**, *14*, 317.
16. Ramström, O.; Ye, L.; Krook, M.; Mosbach, K. *Chromatographia* **1998**, *47*, 465.
17. Wulff, G.; Sarhan, A. *Angew. Chem. Int. Ed. Engl.* **1972**, *11*, 341.
18. The concept of imprinting (in silica gel) is sometimes credited to F. H. Dickey, for the preparation of specific adsorbents: Dickey, F. H. *Proc. Natl. Acad. Sci. USA* **1949**, *35*, 227.
19. See the Society of Molecular Imprinting website available at www.smi.tuberlin.de.
20. Whitcombe, M. J.; Rodriguez, M. E.; Villar, P.; Vulfson, E. N. *J. Am. Chem. Soc.* **1995**, *117*, 7105.
21. Kirsch, N.; Alexander, C.; Lübke, M.; Whitcombe, M. J.; Vulfson, E. N. *Polymer* **2000**, *41*, 5583.
22. Corson, B. B.; Heintzelman, W. J.; Schwartzman, L. H.; Tiefenthal, H. E.; Lokken, R. J.; Nichels, J. E.; Atwood, G. R.; Pavlik, F. J. *J. Org. Chem.* **1958**, *23*, 544.
23. Aherne, A.; Alexander, C.; Payne, M. J.; Pérez, N.; Vulfson, E. N. *J. Am. Chem. Soc.* **1996**, *118*, 8771.

Liquid crystalline polymers

SANGDIL I. PATEL, FRED J. DAVIS, PHILIP M. S. ROBERTS,
CRAIG D. HASSON, DAVID LACEY, ALAN W. HALL,
ANDREAS GREVE, and HEINO FINKELMANN

1. Introduction

The idea of combining the anisotropic behaviour of liquid crystalline materials with the properties of macromolecular systems was first suggested by Onsager¹ and subsequently Flory.² The actual realization that such systems could exist came from studies of natural polymers such as the tobacco mosaic virus.³ Interest in these systems intensified with the development of high-strength systems, based on rigid-rod systems, notably the aramid fibres,⁴ however, liquid crystallinity in such systems occurs only at high temperatures, usually close to the decomposition point of the polymer.⁵ It was only in the late 1970s that the design criteria for liquid crystalline polymers became apparent, the secret being largely in the decoupling of the rigid aromatic groups which give rise to the anisotropic behaviour. As a result of these ideas two classifications of liquid crystalline materials were described (Figure 9.1).⁶ Main-chain liquid crystalline polymers, are those in which rigid aromatic molecules form part of the polymer backbone, either as a continuous chain or

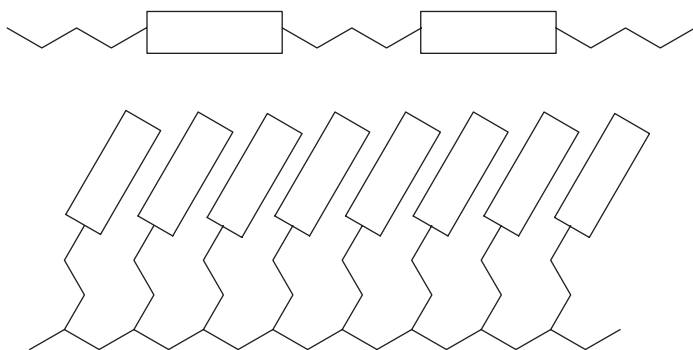

Fig. 9.1 Schematic representation of the two main classes of liquid crystalline polymers: (a) main-chain liquid crystalline polymer; (b) side-chain liquid crystalline polymer.

separated by a series of methylene groups in order to lower temperature at which liquid crystalline phase behaviour is observed. Side-chain systems resemble the comb-like systems studied by Shibaev and Plate,⁷ and have the rigid aromatic groups attached as a side-chain.

In general, the monomer systems required for main-chain liquid crystalline polymers are relatively simple; synthetically these systems are prepared by step-growth methods and the main challenge is often maintaining sufficient solubility to allow suitable chain-lengths to be grown (an example of how such problems might be overcome is given in Chapter 4). Side-chain systems tend to be produced from more complex structural sub-units, and may be produced either by polymerization of the appropriate monomer or by functionalization of a preformed polymer backbone.⁸ Examples of both approaches are given in this chapter. From a practical viewpoint, the advantage of side-chain systems is that they tend to be much more soluble in common organic solvents and also that thermal phase transitions occur at reasonable temperatures (reasonable being well below the temperature at which the polymer decomposes). A further advantage of such side-chain systems is that the phase behaviour can be effectively tuned through the chemical modifications of the three components, namely the side-group, the flexible coupling chain and the polymer backbone.⁶ The former two units are generally used to control the upper phase transition temperature, the latter the lower limit of the mesophase, since, for the most part, side-chain systems are atactic and the lower limit is controlled by the polymer glass transition, rather than by crystallization, as is the case for low molecular weight liquid crystals. This is clearly seen in the case of the two most commonly prepared classes of side-chain liquid crystalline polymers in that siloxanes are designed to have a relatively low glass transition and thus exhibit liquid crystalline phases at room temperature; in contrast,⁹ acrylates generally have rather higher glass transitions, which necessitate heating to access the mesophase,⁸ although here the structure may be locked in through rapid cooling to room temperature.⁹

Although liquid crystalline polymers have some disadvantages in terms of the display applications familiar in conventional liquid crystalline materials, not least because their intrinsic high viscosity precludes rapid responses, their polymeric nature makes other novel applications possible.¹⁰ One area that has attracted particular interest both from a theoretical¹¹ and a practical¹² point of view is the idea of cross-linking materials to produce liquid crystalline elastomers. Such materials provide an additional challenge to the synthetic chemist since their formation requires not only the preparation of monomers and polymers, but also the development of suitable cross-linking procedures. Furthermore, the properties of such materials depend heavily on the state of the material at the time of cross-linking and particularly where this involves forming a network from a preformed polymer, this final chemical transformation may be the most complex of all. In this chapter we have included examples to cover the most common processes involved in the synthesis of

liquid crystalline materials. Thus, we have provided details of the synthesis of a liquid crystalline acrylate, its copolymerization with 2-hydroxyethyl acrylate, and subsequent cross-linking under controlled conditions to prepare an elastomer. In addition we include details of the preparation of some siloxane based systems where the mesogenic unit is added to a preformed siloxane system; the use of an ingenious method of cross-linking to provide elastomers formed under an applied stress is described.

2. Synthesis of an acrylate-based liquid crystal polymer

The synthesis of acrylate materials is relatively straight forward, and can be performed without the recourse to complex reagents and equipment, but, because of the polymerization step may require particular care to ensure the purity of the final material. This is particularly so in the following example, where a cyanobenzoate ester is used to provide the anisotropic phase structure, since the electron-withdrawing group makes this ester particularly susceptible to hydrolysis. The first step in the production of a mesogenic monomer involves the acetylation of 6-chlorohexanol using a standard preparative procedure,¹³ followed by etherification and subsequent hydrolysis as shown in Scheme 1.

Protocol 1.

Synthesis of 4-(6-hydroxyhexyloxy) benzoic acid (Scheme 1)

Caution! Carry out all procedures in a well-ventilated fume-cupboard, wear appropriate disposable gloves, a lab-coat, and safety glasses.

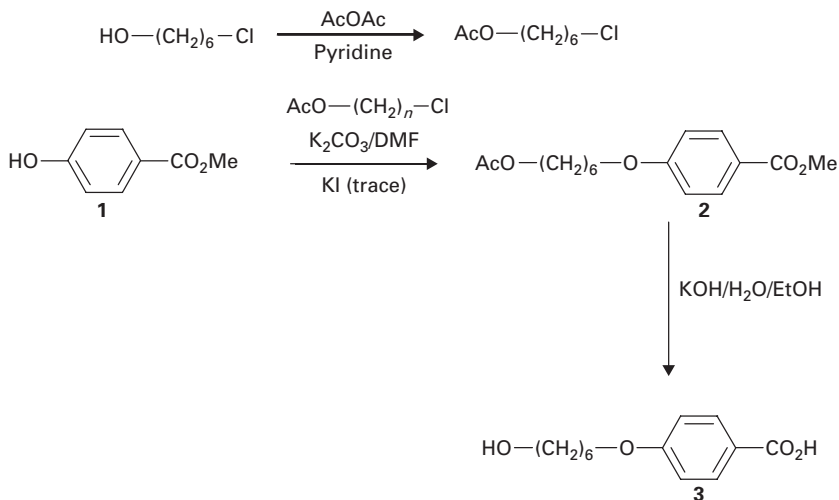

Scheme 1

Protocol 1. Continued

Equipment

- Two-necked round-bottomed flask (1 L)
- Reflux condenser
- Thermometer
- Teflon-coated magnetic stirrer bar
- Hotplate stirrer
- Erlenmeyer flask (3 L)
- Three-necked round-bottomed flask (1 L)
- Dropping funnel (250 mL)
- Powder funnel
- TLC plates (silica gel)
- Glass stirring rod
- Erlenmeyer flask (various sizes)
- Round-bottomed flask (1 L)
- Buchner Flask (3 L)
- Sintered-glass funnel (porosity 2)

Materials

- 6-Chlorohexanol, 100 g, 0.73 mol
 - Pyridine, 58 g, 0.73 mol
 - Acetic anhydride, 306 g, 3 mol
 - Water
 - Magnesium sulfate, anhydrous, ca. 15 g
 - Dimethylformamide, 300 mL
 - Ethanol, 250 mL
 - Potassium carbonate, 69.1 g, 0.5 mol
 - Methyl *p*-hydroxybenzoate, 60 g, 0.40 mol
 - Potassium iodide (catalytic amount)
 - Petroleum ether (b.p. 40–60°C), ca. 6 mL
 - Ethyl acetate, ca. 4 mL
 - Potassium hydroxide, 64.7 g, 1.16 mol
 - Hydrochloric acid, 12 N, 100 mL
- irritant, harmful
highly flammable, harmful by inhalation, in
contact with skin, and if swallowed
flammable, corrosive**
- potentially teratogenic, harmful in contact
with skin, irritating to eyes
highly flammable
irritating to eyes, skin, and respiratory system
irritating to eyes, skin, and respiratory system
Irritant
highly flammable
highly flammable**
- harmful if swallowed, causes severe burns
corrosive, causes burns, irritating to respiratory system**

Method

1. To a two-necked round-bottomed flask (1 L) equipped with a reflux condenser, thermometer, and a magnetic stirrer bar, add 6-chlorohexanol (100 g, 0.73 mol), pyridine (58 g, 0.73 mol) and acetic anhydride (306 g, 3 mol). Heat the solution to 130°C for 1 h whilst stirring.
2. Pour the mixture into an Erlenmeyer flask containing a large excess of water such that an oil layer separates (approximately 1 L of water is suitable for this purpose). Using a separating funnel isolate the oil from the aqueous material. Dry the organic phase with anhydrous magnesium sulfate (ca. 15 g, 15 min). The crude 6-chlorohexyl ethanoate is obtained as a yellow oil and used in the next stage without further purification.
3. To a three-necked round-bottomed flask (1 L) equipped with a reflux condenser, thermometer, a dropping funnel (250 mL), and a magnetic stirrer bar, add dimethylformamide (300 mL) and anhydrous potassium carbonate (69.1 g, 0.5 mol). Using a powder funnel, add methyl *p*-hydroxybenzoate (60 g, 0.40 mol) together with the potassium iodide. Heat the solution to 90°C and add 6-chlorohexyl ethanoate (97.4 g, 0.54 mol) drop-wise over several hours. Stir the solution for a total of 24 h whereupon TLC (silica gel, 3:2 petroleum ether: ethyl acetate) should indicate the complete conversion of starting material.

9: Liquid Crystalline polymers

- Cool the mixture and pour into 3 L of water whilst stirring vigorously with a glass rod. The resulting white crystals are filtered using a Buchner flask through a large sintered-glass funnel. The product is then washed with copious amounts of water and dried in a vacuum desiccator. Typical yields of methyl 4-(6-acetoxyhexoxy) benzoate are close to quantitative, m.p. 44–46°C.
- Methyl 4-(6-acetoxyhexoxy) benzoate (169 g, 0.57 mol) is dissolved in 200 mL of warm ethanol in a 500 mL Erlenmeyer flask.
- In a round-bottomed flask (1 L) equipped with a magnetic stirrer bar and reflux condenser dissolve potassium hydroxide (64.7 g, 1.16 mol) in water (ca. 100 mL), add the ethanolic solution of methyl 4-(6-acetoxyhexoxy) benzoate and stir at 80°C for 2 h.
- The solution is cooled to about 50°C and acidified with hydrochloric acid (100 mL, 12 N) and left to stand.^a After 6 h, the white solid is filtered and washed with copious amounts of water. Typical yield of 4-(6-hydroxyhexoxy) benzoic acid is 121.0 g (89%), m.p. 130–133°C (lit. value⁸ 139°C).

^aThe crystals are particularly fine and difficult to filter, use of a coarse sintered-glass funnel and filtering slowly under gravity is best here (see Chapter 4, Protocol 5, Note g).

The acid generated in Protocol 1 is then esterified with acrylic acid as shown in Scheme 2. The procedure uses an adaptation of the well-known Dean–Stark apparatus to continuously extract water during the reaction. This is shown in Figure 9.2 and allows a solvent denser than water to be continuously recycled through the system while the water is collected in the side-arm.

Protocol 2.

Synthesis of *p*-(6-propenyloxyhexyloxy) benzoic acid (Scheme 2)

Caution! Carry out all procedures in a well-ventilated fume-cupboard, wear appropriate disposable gloves, a lab-coat, and safety glasses. Never use flat-bottomed flasks with rotary evaporators.

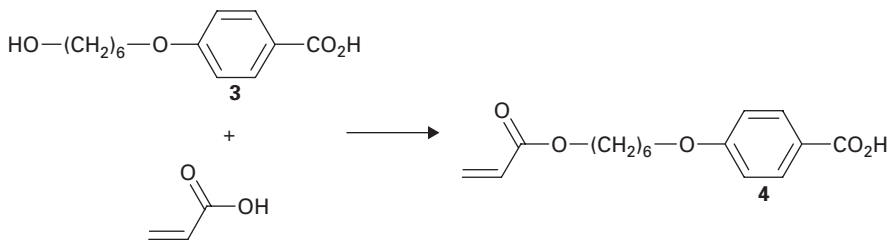

Scheme 2

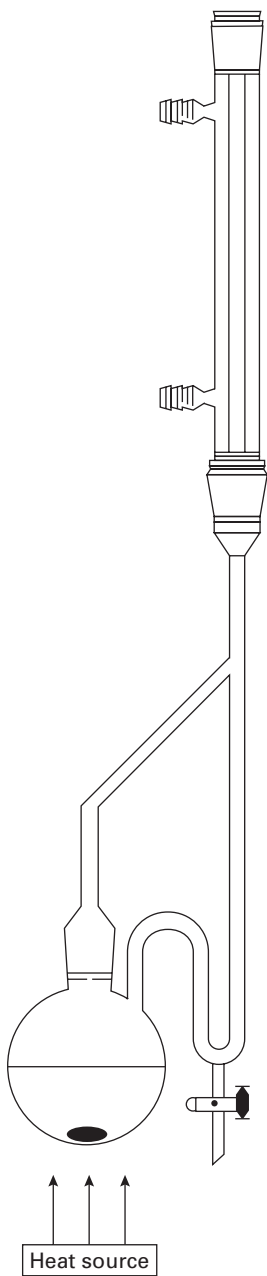

Fig. 9.2 Reverse Dean–Stark apparatus.

9: Liquid Crystalline polymers

Protocol 2. Continued

Equipment

- Reverse Dean–Stark apparatus (1 L)
- Reflux condenser
- Teflon-coated magnetic stirrer bar
- Hotplate stirrer and oil-bath
- Round-bottomed flask (1 L)
- Rotary evaporator
- TLC plates (silica gel)
- Erlenmeyer flask (3 L)
- Buchner flask (3 L)
- Sintered-glass funnel (porosity 2)
- Beaker (1 L)
- Glass rod

Materials

- 4-(6-hydroxyhexyloxy) benzoic acid, 16.7 g, 0.07 mol
 - Hydroquinone, 10 g, 0.09 mol
 - *p*-Toluenesulfonic acid, 5 g, 0.03 mol
 - Acrylic acid, 55 mL (large excess)
 - Chloroform, 55 mL
 - Petroleum ether (b.p. 40–60°C), ca. 6 mL
 - Ethyl acetate, ca. 4 mL
 - Water
 - Propan-2-ol for recrystallization
 - Diethyl ether, 300 mL
 - Ethanol, 250 mL
 - Magnesium sulfate, anhydrous, ca. 15 g
- treat as hazardous material
possible carcinogen, harmful, irritant
irritant
flammable, corrosive, causes burns
suspected carcinogen, harmful
highly flammable
highly flammable**
- highly flammable
highly flammable
highly flammable**

Method

1. Set up the reverse Dean–Stark apparatus with a reflux condenser and magnetic stirrer bar.
2. Add 4-(6-hydroxyhexyloxy) benzoic acid (16.7 g, 0.07 mol), hydroquinone (10 g), and *p*-toluenesulfonic acid (5 g) through the side-arm of the reverse Dean–Stark apparatus. Then add acrylic acid (55 mL, large excess) and chloroform (55 mL).
3. Heat the mixture with stirring until it begins to boil, maintain the boiling at a sufficient rate such that a steady rate of condensation into the side-arm is achieved (typically about 1 drop per second), it is often necessary to insulate the side-arm with cotton wool.
4. Continue heating until no more water is collected in the side-arm. This is best confirmed by removing the liquid in the side-arm; on continued reflux no more water is produced, and no trace of turbidity remains in the distillate. The level of conversion is then checked by TLC (silica gel, 3:2 petroleum ether:ethyl acetate), at this stage no trace of starting material should be present.
5. The mixture is cooled, transferred to a round-bottomed flask (1 L) and the chloroform is removed on the rotary evaporator. The residue is then poured into cold water and a white precipitate is produced. The white precipitate is filtered at the pump collected, placed in a beaker (1 L) and warm water (500 mL, 40°C). The mixture is stirred vigorously with a glass rod, filtered at the pump, and washed with water to remove all traces of acrylic acid. Finally after drying at the pump, the product is recrystallized from propan-2-ol to yield 19.4 g, (86%) of *p*-(6-propenyloxyhexyloxy) benzoic acid, m.p. 102°C (lit. value⁸ 92°C).

The final step of this synthesis involves a modification to the original procedure.⁸ A milder method of esterification using dicyclohexylcarbodiimide is used which avoids the generation of hydrochloric acid via acid chlorides¹⁴ as shown in Scheme 3.

Protocol 3.

Synthesis of 4-cyanophenyl-4'-(6-propenyloxyhexanoxy) benzoate (Scheme 3)

Caution! Carry out all procedures in a well-ventilated fume-cupboard, wear appropriate disposable gloves, a lab-coat, and safety glasses. Never use flat-bottomed flasks with rotary evaporators.

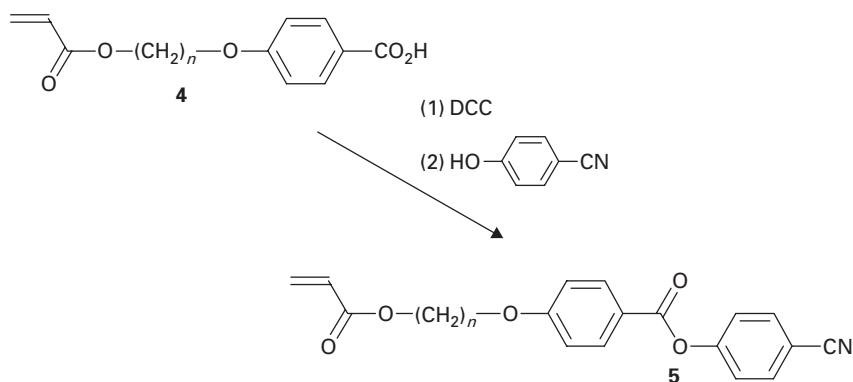

Scheme 3

Equipment

- Round-bottomed flask (250 mL)
- Rotary evaporator
- Ice-salt-bath
- Buchner flask (250 mL)
- Sintered-glass funnel (porosity 2)

Materials

- 4-(6-propenyloxyhexanoxy) benzoic acid, 10 g, 34 mmol **treat as hazardous material**
- Dichloromethane **toxic, carcinogenic in animals, harmful vapour, skin irritant**
- 4-Dimethylaminopyridine, 0.410 g, 3.4 mmol **toxic in contact with skin and if swallowed, irritating to eyes and skin**
- 4-Cyanophenol, 4 g, 34 mmol **harmful, irritant**
- Dicyclohexylcarbodiimide, 7 g, 34 mmol **toxic, corrosive, sensitizing**
- Hydrochloric acid (0.5 N), 200 mL **corrosive, causes burns, irritating to respiratory system**
- Sodium bicarbonate solution (aqueous, saturated)
- Magnesium sulfate
- Propan-2-ol for recrystallization **highly flammable**

Method

1. Add 4-(6-propenyloxyhexanoxy) benzoic acid (10 g, 34 mmol) to a 250-mL round-bottomed flask together with 50 mL of anhydrous dichloromethane, stir and cool to 0°C in an ice-salt bath.

- When the solid material has dissolved then add 4-dimethylaminopyridine (0.410 g, 3.4 mmol) and 4-cyanophenol (4 g, 34 mmol) to the stirred solution. Dicyclohexylcarbodiimide (7 g, 34 mmol) is added to the pale yellow solution. The resulting white mixture is stirred for 5 min at 0°C and 4 h at room temperature.
- After 4 h filter the precipitated urea under gravity (washing with a little dichloromethane) and concentrate the filtrate using the rotary evaporator. Dissolve the white residue in a little dichloromethane, wash with 0.5 N hydrochloric acid (2 × 100 mL), sodium bicarbonate solution (100 mL), dry with magnesium sulfate and filter under gravity.
- Concentrate the solution by rotary evaporation and recrystallize 4-cyanophenyl-4'-(6-propenyloxyhexanoxy) benzoate from propan-2-ol as fine colourless crystals, 9.0 g (68%).

The monomer can be polymerized in a chain-growth process initiated by azobisisobutyronitrile (AIBN) using the procedure described in Chapter 2 (Protocol 1). In the example given in Protocol 4 below the material is copolymerized with a small proportion (typically 6%) of hydroxyethylacrylate. This comonomer provides sites for subsequent cross-linking (see Protocols 11 and 12)

Protocol 4.

Copolymerization of 4-cyanophenyl-4'-(6-propenyloxyhexanoxy) benzoate with 2-hydroxyethylacrylate (Scheme 4)

Caution! Carry out all procedures in a well-ventilated fume-cupboard, wear appropriate disposable gloves, a lab-coat, and safety glasses.

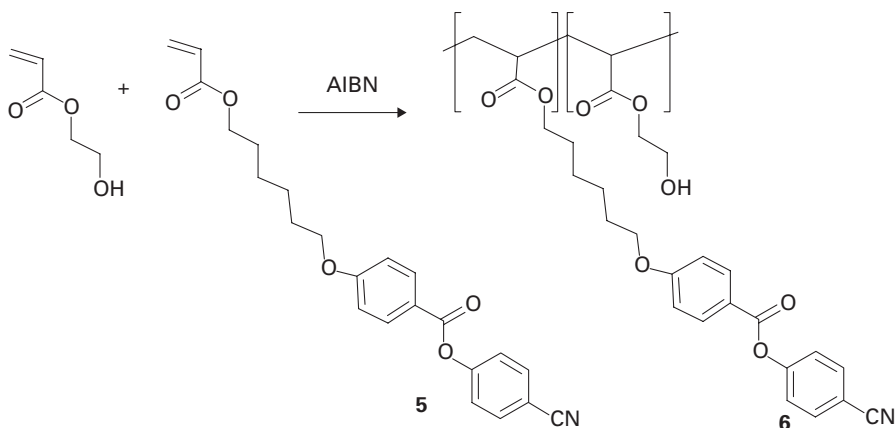

Scheme 4

Protocol 4. Continued

Equipment

- Dual manifold (nitrogen/vacuum)
- Polymerization tube
- Protective netting for polymerization tube
- Dewar
- Thermostatted water-bath
- Vacuum pump
- Source of dry nitrogen
- Blast screen
- Round-bottomed flask (100 mL)
- Rotary evaporator
- Erlenmeyer flasks (various sizes)
- Vacuum oven

Materials

- 4-Cyanophenyl-4'-(6-propenoyloxyhexanoxy) benzoate, **treat as hazardous material**
1 g, 2.5 mmol
- 2-Hydroxyethylacrylate, 18 mg, 0.15 mmol **toxic in contact with skin, causes burns, may cause sensitization by skin contact, harmful to aquatic organisms**
- AIBN 4 mg, 0.03 mmol **toxic, harmful, explosive, highly flammable**
- Chlorobenzene 20 mL **flammable, harmful by inhalation**
- Nitrogen gas (dry white spot) **asphyxiation hazard**
- Liquid nitrogen for cooling **extremely cold liquid, vapour can cause rapid suffocation**
- Dichloromethane for purification **toxic, carcinogenic in animals, harmful vapour, skin irritant**
- Methanol for purification **highly flammable, toxic by inhalation and if swallowed**
- Diethyl ether for purification **extremely flammable, may form peroxides**

Method

Preparation: 2-Hydroxyethylacrylate should be purified to remove inhibitors prior to use. This is done by distillation under reduced pressure.

1. Place the 4-cyanophenyl-4'-(6-propenoyloxyhexanoxy) benzoate (1 g, 2.5 mmol) and 2-hydroxyethylacrylate (18 mg, 0.15 mmol) in the polymerization tube. Add AIBN (4 mg, 0.03 mmol) and finally add chlorobenzene (20 mL). Place a protective netting over the tube to minimize danger from glass should the tube shatter. Attach the tube to the manifold and close the Young's tap at the top of the tube.
2. Carry out the freeze–thaw–degassing programme outlined in Chapter 2, to ensure all oxygen is removed from the system. Isolate the tube from the manifold by closing the Young's tap while the system is under vacuum.
3. Place the tube in a thermostatted water-bath at 55°C for 24 h. This procedure should be carried out behind a blast screen.
4. Remove the tube from the water-bath and allow to cool to room temperature
5. Transfer the resulting polymer solution into a round-bottomed flask (100 mL) and remove the majority of the chlorobenzene using a rotary evaporator. Then re-dissolve the polymer in the minimum volume of dichloromethane and drop the resulting viscous solution into cold methanol (150 mL) in an Erlenmeyer flask (500 mL). The flask is allowed to stand for 30 min and the liquid decanted. The solid is allowed to dry in the fume-cupboard and then re-dissolved in dichloromethane (minimum volume). Once again the polymer solution is precipitated, this time into diethyl ether. The polymer is then isolated as above and a further precipitation into ether undertaken. The polymer is

then placed in the vacuum oven and dried at 50°C for several hours to remove any residual solvent and water. The polymers are subsequently characterized by differential scanning calorimetry (DSC) to determine the phase transition temperatures.

3. The hydrosilylation reaction: a useful procedure for the preparation of a variety of side-chain polymers

The main structural features of a side-chain polymer are given in Figure 9.3 and although the polymer backbone and flexible spacer group are important in determining the thermal and physical properties of these polymers, potential applications are determined mainly by the side-group. For example, if the side-chain polymer is to be used as a non-linear optical (NLO) device then the structure of the side-group might be as shown in Figure 9.3(a), for liquid crystal display device applications structures such as shown in Figure 9.3(b) or (c) may be used.

Grafting of the side-group onto a preformed polymer backbone has been a very useful and highly productive way of making a large variety of side-chain polymers for display device applications. Such polymers should have low glass transition (T_g) temperatures, and for that reason many of these side-chain liquid crystalline polymers are prepared from preformed poly(siloxane) backbones. The polymer backbones come in a variety of different forms examples of which are shown in Figure 9.4. The procedure described here involves the preparation of a ferroelectric side-chain liquid crystal of structure **13**, in this case a cyclic siloxane tetramer, however, this procedure can be simply adapted to prepare a range of side-chain liquid crystalline poly(siloxanes) and elastomers (see later). The procedure is performed using the hydrosilylation reaction of the preformed cyclic siloxane tetramer **11** with the mesogenic side-group **10** in anhydrous toluene in the presence of the catalyst platinum(0)-1,3-divinyl-1,1,3,3-tetramethyldisiloxane complex **12** at room temperature.

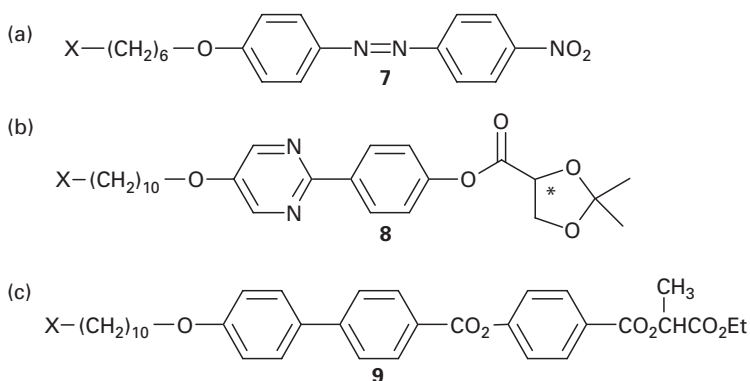

Fig. 9.3 The main structural features of a side-chain polymer.

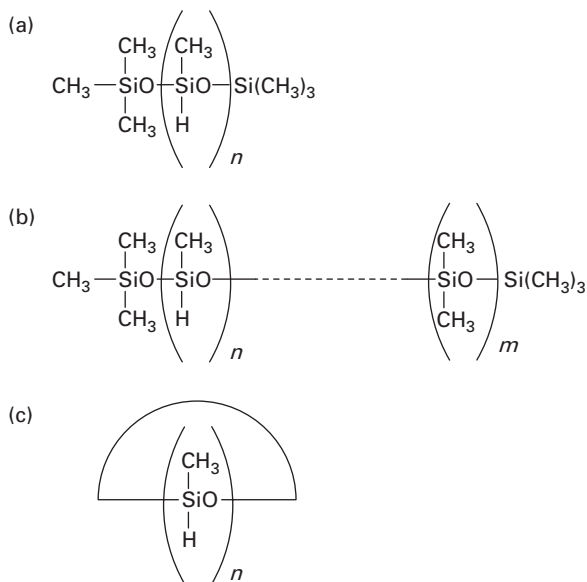

Fig. 9.4 Different types of polymer backbone: (a) homopolymers; (b) copolymers; (c) cyclic polymers.

Protocol 5.

Use of the hydrosilylation reaction to form a side-chain liquid crystalline cyclic tetramer (Scheme 5)

Caution! Carry out all procedures in a well-ventilated fume-cupboard, wear appropriate disposable gloves, a lab-coat, and safety glasses. Never use flat-bottomed flasks with rotary evaporators.

Equipment

- Dual manifold (nitrogen/vacuum)
- Three-necked, round-bottomed flask (100 mL)
- Pressure-equalizing dropping funnel
- Rubber septa
- Inlet tube
- Syringe and needle
- Magnetic stirrer
- Source of dry nitrogen
- Rotary evaporator
- TLC plates (silica gel)
- Teflon-coated magnetic stirrer bar
- Disposable syringe filter (PTFE, 0.45 μm)
- Centrifuge
- Cannula needle

Materials

- Nitrogen gas (white spot, dry)
- Dry air
- Toluene, anhydrous, 60 mL
- Cyclic siloxane tetramer **11**, 0.15 g, 0.5 mmol
- Compound **10**, 1.5 g, 2.6 mmol

asphyxiation hazard
caution, gas under pressure
flammable, toxic by ingestion, harmful vapour
flammable, harmful by inhalation or ingestion
treat as hazardous material

9: Liquid Crystalline polymers

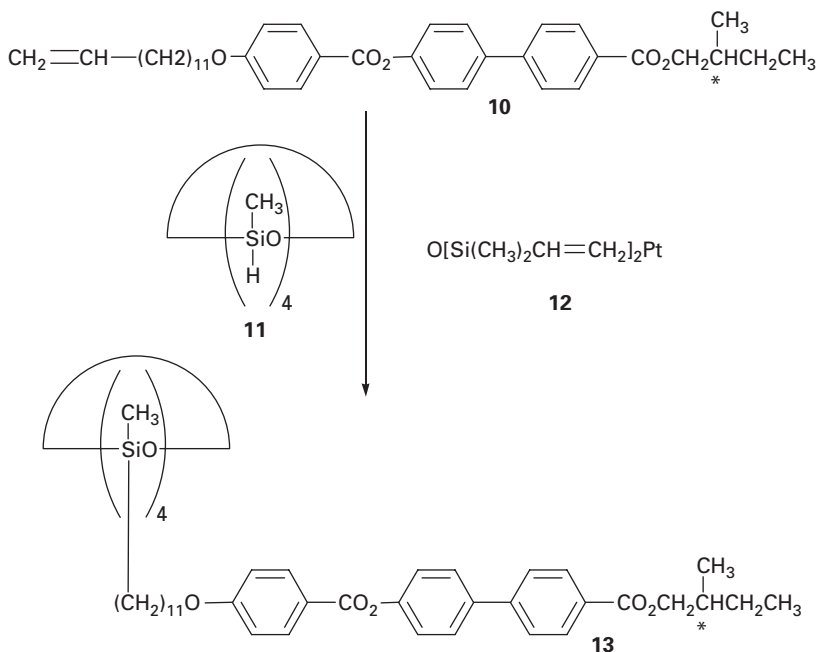

Scheme 5 Use of the hydrosilylation reaction to form a side-chain liquid crystalline cyclic tetramer.

- Catalyst **12** (solution), 10 μL
- Dichloromethane, anhydrous
- Methanol, anhydrous
- Petroleum ether (b.p. 40–60°C)
- Diethyl ether

flammable, harmful, hydrolytic sensitivity
toxic, carcinogenic in animals, harmful vapour, skin irritant
highly flammable, toxic by inhalation and if swallowed
highly flammable
extremely flammable, may form peroxides

Method

Preliminary stage: All glassware must be dried in an oven at 120°C for 1 h.

1. The 100-mL three-necked flask is set up for reflux, with the pressure-equalizing dropping funnel in the central neck and the septum and the inlet tube occupying the outer two necks.
2. Sweep the apparatus with dry nitrogen, via the inlet tube, for 2 min.
3. Replace the inlet tube with a stopper and place the nitrogen bubbler on top of the pressure-equalizing dropping funnel, allowing a slow, steady stream of dry nitrogen to pass over the top.
4. Add compound **10** (1.5 g, 2.6 mmol) and the catalyst **12** (20 μL) to the flask and, by using the syringe and needle, transfer anhydrous toluene (50 mL) from the Sure-Seal bottle to the flask via the septum.

Protocol 5. Continued

5. Add the cyclic siloxane tetramer **11** (0.15 g, 0.5 mmol), dissolved in anhydrous toluene (10 mL), to the pressure-equalizing dropping funnel and start the stirrer.
6. Exchange the stopper for the inlet tube and bubble dry air through the reaction mixture for 20 s.^a
7. Replace the stopper and add slowly, drop-wise, the cyclic siloxane tetramer to the reaction mixture.
8. When the addition has been completed, leave the reaction mixture stirring at room temperature for 24 h.^{b,c}
9. The progress of the reaction can be monitored by IR spectroscopy by removing a small quantity of the reaction mixture using a syringe and needle (via the septum), and examining the IR spectrum in the region 2000–2200 cm⁻¹. The disappearance of the band at 2155 cm⁻¹ (Si–H absorption band) indicates completion of the hydrosilylation reaction.
10. Filter off any undissolved material and remove the toluene by distillation under reduced pressure (rotary film evaporator).
11. Dissolve the side-chain liquid crystalline cyclic tetramer in the minimum amount of dry dichloromethane and precipitate the tetramer by the addition of dry methanol (usually about four or five times the volume of the dichloromethane).^d
12. Place the suspension of the side-chain liquid crystalline cyclic tetramer into centrifuge tubes and spin them at 10 000 rpm for 15 min.
13. Carefully decant off the liquid and check the purity of the side-chain liquid crystalline cyclic siloxane tetramer by TLC (silica gel, 9:1 petroleum ether: diethyl ether), against starting monomer **10**.
14. If the monomer is still present, repeat steps 11–13 until the product is free of monomer.
15. If the side-chain liquid crystalline cyclic siloxane tetramer is pure and free of starting monomer, redissolve the tetramer in the minimum amount of dry dichloromethane and filter using a disposable syringe filter (PTFE membrane 0.45 μm) to remove any small particulates. The solvent can then be carefully removed by distillation under reduced pressure (rotary film evaporator) and dried *in vacuo* overnight.

^aOxygen from the dry air will aid the hydrosilylation reaction.

^bHeat may be required (40–50°C) to complete the hydrosilylation reaction.

^cThe catalyst, hydrogen hexachloroplatinate(IV) hydrate, (H₂PtCl₆) may be used in the hydrosilylation reaction. If this catalyst is used then the reaction mixture must be left stirring at 60–70°C overnight.

^dSometimes a trace amount of colloidal platinum may be present in the side-chain liquid crystal cyclic siloxane tetramer. This can be removed by adding a small amount of triphenylphosphine (0.1 g) at step 11.

4. Photochemical preparation of liquid crystalline elastomers with a memory of the aligned cholesteric phase

The following protocols (6–10) describe the synthesis of some cholesterol-based acrylates and their photopolymerization in an aligned cholesteric phase. The protocols utilize a modification of a system previously described by Shannon.^{15,16} In the absence of a diacrylate comonomer, the cholesteric phase produced initially on copolymerization is not stable and reverts to a smectic phase on a single cycle of heating and cooling. In the presence of the diacrylate the first-formed phase is stable. This is one example of how cross-linking can stabilise the liquid crystal phase in liquid crystalline elastomers, others include, the so-called, polymer-stabilized liquid crystals¹⁷ and those described in the later protocols.

Protocol 6.

Synthesis of cholesteryl 2-(acryloyloxy) ethyl carbonate (Scheme 6)

Caution! Carry out all procedures in a well-ventilated fume-cupboard, wear appropriate disposable gloves, a lab-coat, and safety glasses. Never use flat-bottomed flasks with rotary evaporators.

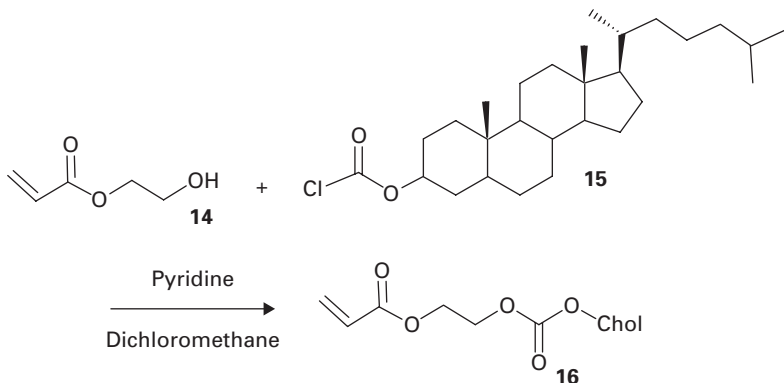

Scheme 6

Equipment

- Two-necked, round-bottomed flask (250 mL)
- Pressure-equalizing dropping funnel (50 mL)
- Teflon-coated magnet stirrer bar
- Hotplate stirrer
- Erlenmeyer flask (500 mL)
- Rotary evaporator
- Erlenmeyer flask (250 mL)

Materials

- 2-Hydroxyethyl acrylate, 7 mL, 60 mmol
- Pyridine, 3.6 mL, 44 mol

**toxic in contact with skin, causes burns,
may cause sensitization by skin contact,
harmful to aquatic organisms
highly flammable, harmful by inhalation, in contact
with skin and if swallowed**

Protocol 6. Continued

- Dichloromethane, 275 mL **toxic, carcinogenic in animals, harmful vapour, skin irritant**
- Cholesteryl chloroformate, 18.0 g, 40 mmol **corrosive**
- Magnesium sulfate
- Petroleum ether (b.p. 40–60°C) **highly flammable**

Method

1. To a two-necked round-bottomed flask (250 mL) equipped with a dropping funnel and a magnetic stirrer bar, add 2-hydroxyethyl acrylate (7 mL, 60 mmol) and pyridine (3.6 mL, 44 mmol) in dichloromethane (35 mL). Cool the mixture to 0°C in an ice-bath.
2. To the dropping funnel, add a solution of cholesteryl chloroformate (18.0 g, 40 mmol) in dichloromethane. Add the solution of cholesteryl chloroformate drop-wise to the contents of the round-bottomed flask.
3. Remove the ice-bath to allow the mixture to warm to room temperature and continue stirring for 19 h.
4. Dilute the mixture with dichloromethane (240 mL) before adding to an Erlenmeyer flask (500 mL). Dry the solution over magnesium sulfate, filter, and concentrate by rotary evaporator.
5. Recrystallize the solid from petroleum ether 60–80 in an Erlenmeyer flask (250 mL).

The second comonomer is produced in procedures as outlined in Protocols 7–9.

Protocol 7.

Synthesis of 11-bromoundecanoyl chloride (Scheme 7)

Caution! Carry out all procedures in a well-ventilated fume-cupboard, wear appropriate disposable gloves, a lab-coat, and safety glasses. Never use flat-bottomed flasks with rotary evaporators.

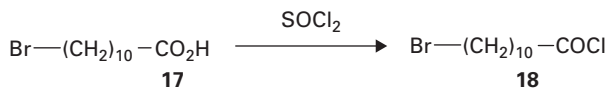

Scheme 7

Equipment

- Round-bottomed flask (250 mL)
- Pressure-equalizing dropping funnel (50 mL)
- Teflon-coated magnet stirrer bar
- Hotplate stirrer
- Rotary evaporator

Materials

- 11-Bromoundecanoic acid, 21.2 g, 80 mmol
- Thionyl chloride, 12 g, 100 mmol **reacts violently with water, harmful by inhalation and if swallowed, contact with water liberates toxic gas, causes severe burns**

9: Liquid Crystalline polymers

Method

1. To a single-necked round-bottomed flask (250 mL) equipped with a dropping funnel and a magnetic stirrer bar, add 11-bromoundecanoic acid (21.2 g, 80 mmol).
2. To the dropping funnel add thionyl chloride (12 g, 100 mmol).
3. Slowly add the contents of the dropping funnel to the round-bottomed flask whilst stirring; continue stirring for a further 20 h.
4. Remove the excess thionyl chloride on the rotary evaporator.

Protocol 8.

Synthesis of cholesteryl 11-bromoundecanoate (Scheme 8)

Caution! Carry out all procedures in a well-ventilated fume-cupboard, wear appropriate disposable gloves, a lab-coat, and safety glasses. Never use flat-bottomed flasks with rotary evaporators.

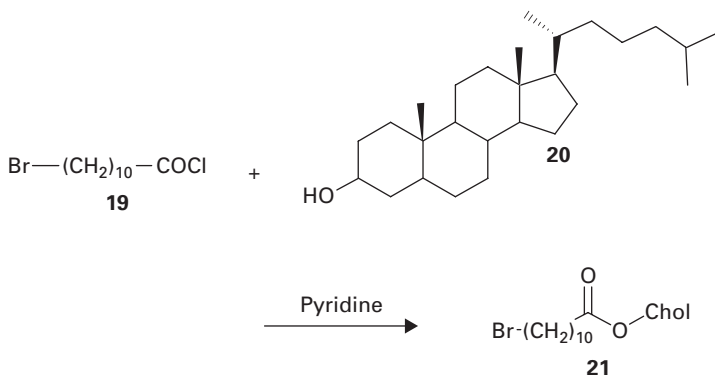

Scheme 8

Equipment

- Round-bottomed flask (250 mL)
- Teflon-coated magnet stirrer bar
- Hotplate stirrer
- Separating funnel (500 mL)
- Erlenmeyer flask (250 mL)
- Rotary evaporator

Materials

- Cholesterol (38.6 g, 0.1 mol)
- Pyridine (10 mL) **highly flammable, harmful by inhalation, in contact with skin, and if swallowed suspected carcinogen, harmful, should be stored in the dark to prevent formation of phosgene treat as hazardous material**
- Chloroform (ethanol free)^a **corrosive, causes burns, irritating to respiratory system**
- 11-Bromoundecanyl chloride, 35.7 g, 124 mmol
- Hydrochloric acid (1N), 100 mL
- Magnesium sulfate
- Petroleum ether (b.p. 40–60°C)
- Ethanol **highly flammable**

Protocol 8. Continued*Method*

1. To a single-necked round-bottomed flask (250 mL) equipped with a magnetic stirrer bar, add a solution of cholesterol (38.6 g, 100 mmol), pyridine (10 mL), and ethanol free chloroform (200 mL). Cool to 0°C in an ice-bath and stir.
2. Add a solution of 11-bromoundecanyl chloride (35.7 g, 124 mmol) in chloroform over 30 min. Continue stirring for 2 h at 0°C and a further 16 h at room temperature.
3. Dilute the mixture with chloroform (100 mL) and wash with 1 N hydrochloric acid (2 × 50 mL) and water in a separating funnel (500 mL). Separate and dry the organic layer in an Erlenmeyer flask (250 mL) dry with magnesium sulfate and filter under gravity.
4. Concentrate the mixture in a single-necked round-bottomed flask (250 mL) using a rotary evaporator.
5. Recrystallize the solid from a 1 : 1 v/v mixture of petroleum ether and ethanol.

^aEthanol-free chloroform is obtained by passing through a column of alumina.

Protocol 9.**Synthesis of 11-acryloyloxyundecanoic acid cholesteryl ester (Scheme 9)**

Caution! Carry out all procedures in a well-ventilated fume-cupboard, wear appropriate disposable gloves, a lab-coat, and safety glasses, UV-safe where appropriate.

**Scheme 9***Equipment*

- Round-bottomed flask (250 mL)
- Teflon-coated magnetic stirrer bar
- Oil-bath
- Hotplate stirrer
- Buchner flask (3 L)
- Sintered-glass funnel

Materials

- Potassium acrylate, 16.5 g, 150 mmol
- Cholesteryl 11-bromoundecanoate, 31.7 g, 50 mmol
- 2,6-Di-*tert*-butyl-4-methylphenol, 0.75 g, 3.4 mmol
- *N,N*-Dimethylformamide

treat as hazardous material
treat as hazardous material
harmful, irritant
toxic to reproductive organs, harmful in contact
with skin, irritating to eyes

9: Liquid Crystalline polymers

- Petroleum ether (b.p. 40–60°C)
- Ethanol

highly flammable
highly flammable

Method

1. To a single-necked round-bottomed flask (250 mL) equipped with a magnetic stirrer bar, add potassium acrylate (16.5 g, 0.15 mol), cholesteryl 11-bromoundecanoate (31.7 g, 0.05 mol) and 2,5-di-*tert*-butylcresol (0.75 g, 3.4 mmol) and dissolve in dimethylformamide.
2. Heat the solution to 100°C and stir for 21 h with the use of an oil-bath and hotplate stirrer.
3. Cool the mixture to room temperature and filter at the pump through a Buchner funnel (500 mL) and sintered funnel.
4. Recrystallize the solid from a 1:1 v/v mixture of petroleum ether and ethanol.

Protocol 10. Cholesteric alignment and photopolymerization

Caution! Carry out all procedures in a well-ventilated fume-cupboard, wear appropriate disposable gloves, a lab-coat, and safety glasses.

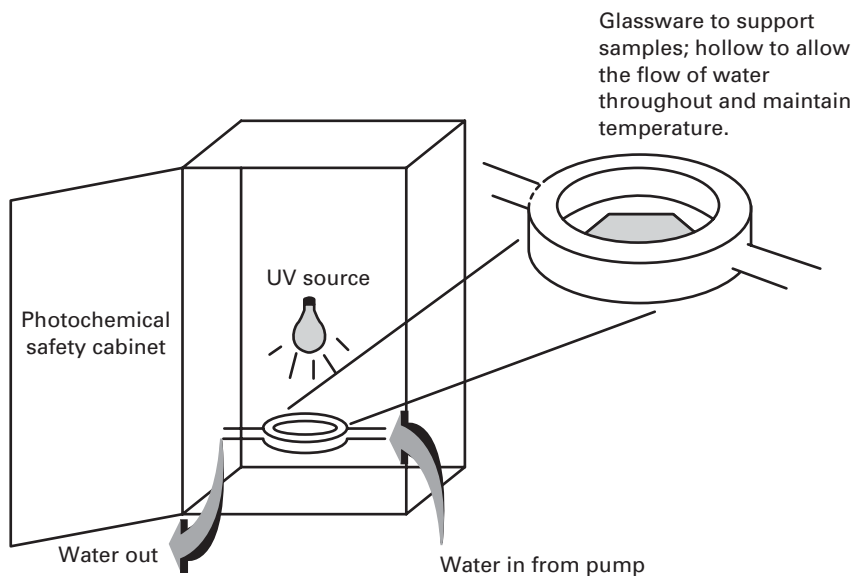

Fig. 9.5 Experimental set-up for the photopolymerization of aligned cholesteric samples.

Protocol 10. Continued

Equipment

- Glass vial (30 mL)
- Glass Pasteur pipettes, disposable
- Borosilicate glass slides
- Hotplate
- Photopolymerization glassware (Figure 9.5)¹⁴
- Water pump
- Water bath
- Photochemical safety cabinet
- 125 W Hg arc lamp (medium pressure)

Materials

- Cholesteryl-2-(acryloyloxy) ethyl carbonate, 53 mg, 0.1 mmol **treat as hazardous material**
- 11-Acryloyloxy-undecanoic acid cholesteryl ester, 63 mg, 0.1 mmol **treat as hazardous material**
- Irgacure 651, 1.2 mg, 0.005 mmol **treat as hazardous material**
- 1,6-Hexanediol diacrylate, 1.0 mg, 2 mmol **irritating to eyes and skin, may cause sensitization by skin contact**
- Dichloromethane **toxic, carcinogenic in animals, harmful vapour, skin irritant**

Method

1. To a glass vial (30 mL) add cholesteryl-2-(acryloyloxy) ethyl carbonate (53 mg, 0.1 mol), 11-acryloyloxy-undecanoic acid cholesteryl ester (63 mg, 0.1 mmol), Irgacure 651 (1.2 mg, 0.005 mmol), and 1,6-hexanediol diacrylate (1.0 mg, 2 mmol) and dissolve in the minimum amount of dichloromethane (~1 mL).
2. Cast the viscous solution to a borosilicate slide using a glass pipette applying a thin film from the centre of the slide outwards.
3. Heat the slide on a hotplate (~40°C) for a few seconds and shear the mixture (spread thinly) in a single direction across the surface of the slide using another clean borosilicate slide.
4. The slide is placed on the photopolymerization glassware¹⁴ (Figure 9.5) and connected to a water pump and water-bath (set to 40°C).
5. With the experimental set up safely within a photochemical safety cabinet, a 125 W Hg arc lamp (medium pressure) is fixed at a distance of 10 cm from the sample slide.
6. Irradiate for 30 min. The polymer is obtained as a (depending on the composition) highly coloured film indicative of a cholesteric phase.

5. Defining permanent memory of macroscopic global alignment in liquid crystal elastomers

For the sample described above, it was noted that cross-linking enhances the stability of the phase present at the time of cross-linking. For this sample, the cross-linking was introduced during the polymerization process. A similar situation exists where cross-linking is introduced to into preformed polymer backbones. Cross-linking a liquid crystalline polymer in a globally aligned state introduces a permanent memory of the alignment present at the time of

9: Liquid Crystalline polymers

cross-linking. It should be noted in passing that such behaviour is to be expected from the excellent theoretical models of Warner and his colleagues,¹⁸ and without the understanding provided by this team many of the developments described below might not have come about.

The following examples describe two different approaches to developing liquid crystalline elastomers. The first two examples, developed at Reading, utilize the acrylate-based polymer described in Protocol 4; the final technique, invented in Freiburg utilizes siloxane-based polymers. This latter process is particularly useful where high levels of orientation are required (and of course room temperature liquid crystalline phases).

In the first example, the acrylate-based, side-chain liquid crystal polymer, 4-cyanophenyl-4'-(6-propenoyloxyhexanoxy) benzoate (CBZ6), can be used to produce cross-linked, liquid crystalline networks. 2-Hydroxyethylacrylate is included at 6% to provide active sites for the subsequent cross-linking reaction (Protocol 4). The degree of polymerization is ~ 150 producing a nematic polymer with $T_g \sim 33^\circ\text{C}$ and $T_{NI} \sim 128^\circ\text{C}$. The networks are defined globally aligning in an external magnetic field by after cross-linking with a cross-linker such as diisocyanatohexane.

Protocol 11.

Cross-linking a liquid crystalline polymer to form a monodomain sample

Caution! Carry out all procedures in a well-ventilated fume-cupboard, wear appropriate disposable gloves, a lab-coat, and safety glasses.

Equipment

- Volumetric flask (50 mL)
- Kapton sheet (25 μm)
- Glass Pasteur pipettes, disposable
- Desiccator containing both silica gel and
- Electromagnet ($B > 1\text{ T}$)
- Hot-stage/oven and temperature controller
- Kapton tape

Materials

- Diisocyanatohexane (DCH), 100 mg, 0.6 mmol
 - Dichloromethane, anhydrous
 - Triethylamine, 20 mg, 0.2 mmol
 - CBZ6 random copolymer^a 50 mg
 - Propan-2-ol
- harmful, irritant, lachrymator, possible, sensitizer
toxic, carcinogenic in animals, harmful vapour, skin irritant
highly flammable, harmful by inhalation and
if swallowed, causes burns
treat as hazardous material
highly flammable**

Method

Preparation: The polymer is synthesized using the method described in Protocol 4.

1. To a volumetric flask (50 mL) add DCH (100 mg) and fill to the 50 mL mark with dry dichloromethane. [triethylamine (20 mg) can be added as a catalyst to the reaction, but is usually not required].

Protocol 11. *Continued*

2. Dissolve CBZ6 polymer (50 mg) in the minimum volume of dry dichloromethane (~ 0.25 mL) and add the required amount (0.45 mL) of the above solution to give a 30% molar excess of cross-linker.
3. Clean the Kapton substrate with propan-2-ol and allow to dry completely.
4. Using a glass pipette, cast the film in about five successive layers allowing time for solvent exclusion between each layer. Do not touch the cast polymer with the tip of the pipette as this introduces bubbles. The film is now left in a desiccator containing silica gel (to absorb moisture) and paraffin wax (to absorb dichloromethane) for around 1 h such that the majority of the solvent is excluded.
5. The film and substrate are now mounted in the magnet hot-stage by sticking the edges of the Kapton substrate to the oven floor with Kapton tape. Note that the Kapton has parallel grooves which run perpendicular to the direction the film comes away from the roll, it is important to ensure that these lines run parallel to the magnetic field (for systems with parallel coupling).
6. With the magnetic field on, the sample is rapidly heated to about 5°C above T_{NI} for a few seconds before cooling to the required temperature within the nematic phase. The solvent still contained in the films depresses T_{NI} to as low as 60°C on the initial rapid heating. On subsequent cooling from above T_{NI} , the sample shows a much smaller depression of T_{NI} of only a few degrees. The polymer aligns in a 2-T field in about 5 min but takes up to 30 min at 0.6 T (at 5°C below T_{NI}). The alignment time is strongly temperature dependent increasing to 120 min for 0.6 T at 15°C below T_{NI} . The film is now held at this temperature (usually 120°C) for 2–3 days for the completion of the reaction.
7. After removal from the hot-stage, the film and substrate are cooled to below T_{g} on a cold surface (e.g. an ice cube wrapped in tin foil) for a few seconds. The film is now removed from the substrate by scratching an edge of the film with a razor blade, this acts to separate a corner of the film and the rest of the substrate is now *carefully* peeled from the elastomer.

Possible problems

1. *Bubbles.* (a) The tip of the pipette was allowed to touch the cast film; (b) successive layers were cast before the previous layer had excluded the solvent; (c) the film was not left for long enough at room temperature in the desiccator.
2. *Non-uniform film surface.* Either not enough initial polymer for the cast area or too much solvent in the concentrated solution.
3. *Opaque film.* Caused by cross-linking occurring before complete alignment with the applied field due to either a high molecular weight polymer

9: Liquid Crystalline polymers

(thus slow alignment) or too large an excess of cross-linker (too fast cross-linking). The kinetics of cross-linking depend on the molecular weight of the polymer and the cross-linker used, see below. In essence, the short aliphatic cross-linkers, react more slowly than the long aliphatic cross-linkers, which react slower than the phenyl-containing cross-linkers. High molecular weight polymers react faster than low molecular weight polymers and also take longer to align in the magnetic field. The presence of the triethylamine further increases the kinetics of the cross-linking, especially at lower temperatures, therefore the length of time the cast film is left in the desiccator (step 4,) must be kept to a minimum when using triethylamine.

M_w/M_n	Cross-linker	Time to 70% gel (h)
320 000/45 000	Methylene bis(phenyl isocyanate) MDI	<1
320 000/45 000	Diisocyanatohexane (DCH)	25
160 000/40 000	Diisocyanatohexane (DCH)	60
160 000/40 000	Diisocyanatohexane + triethylamine	50
160 000/40 000	Diisocyanatododecane (DCDD)	40
160 000/40 000	Methylene bis(phenyl isocyanate) MDI	1
50 000/28 000	Methylene bis(phenyl isocyanate) MDI	5

4. *Film flows or becomes opaque when subsequently heated up.* Insufficient cross-linking. This may be a problem of a polymer with too low molecular weight polymer or insufficient cross-linker. Fully cross-linked samples retain their macroscopic shape on heating.

^aA copolymer containing 6% hydroxyethyl acrylate Compound 6, Protocol 4, this chapter.

5.1 Imprinting chiral structure in liquid crystalline elastomers

A similar approach has been used to produce materials with a chiral (cholesteric) structure by performing the experiments described above in the presence of a low molecular weight chiral liquid crystalline material (Figure 9.6). The chiral material is not covalently attached to the network and can be removed subsequently to produce an imprinted chiral structure.¹⁹ As before, the polymer displays a nematic mesophase between the glass transition ($T_g \sim 33^\circ\text{C}$) and the transition to an isotropic fluid ($T_{NI} \sim 128^\circ\text{C}$).

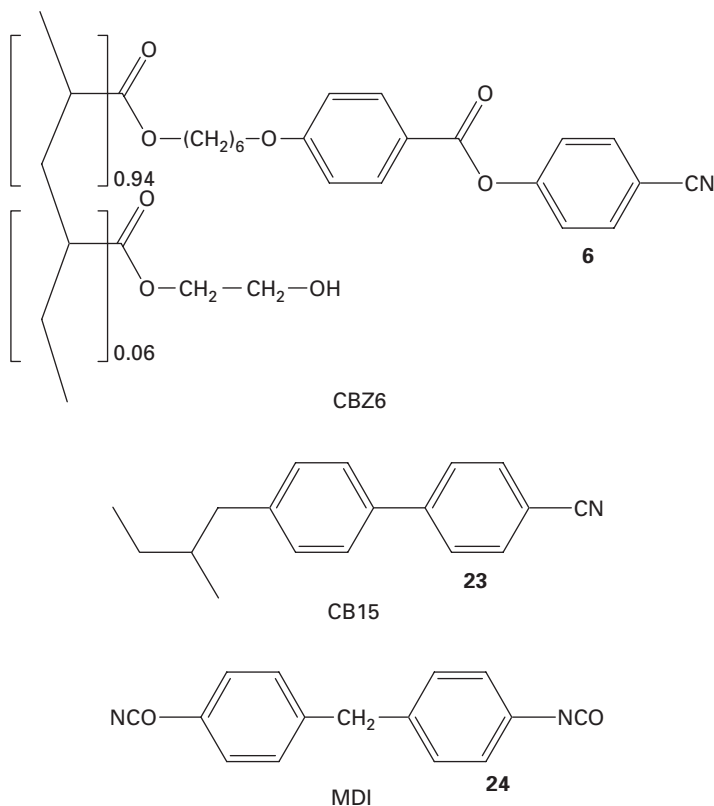

Fig. 9.6 Imprinting chiral structure in liquid crystalline elastomer, polymer 6 (CBZ6), chiral dopant 23 (CB15) and cross-linking agent 24 (MDI).

Protocol 12.

Caution! Carry out all procedures in a well-ventilated fume-cupboard, wear appropriate disposable gloves, a lab-coat, and safety glasses.

Equipment

- Glass vials (5 mL)
- Volumetric flask (5 mL)
- 1 mL graduated pipette
- Glass Pasteur pipettes, disposable
- Desiccator containing both silica gel and paraffin wax
- Hot-stage/oven and temperature controller
- Mylar sheet (100 μ m thickness, cut to for a ring with internal diameter, 20 mm and external diameter, 30 mm)
- Teflon (PTFE) sheet
- Filter paper
- Beaker (100 mL)
- Screw cap jar (15 mL)

Materials

- CBZ6 random copolymer, 23 mg
- CB15 chiral dopant, 35 mg, 0.1 mmol

**treat as hazardous material
irritant**

9: Liquid Crystalline polymers

- Dichloromethane, anhydrous 10 mL **toxic, carcinogenic in animals, harmful vapour, skin irritant**
- Methylene bis(phenyl isocyanate), 5 mg (MDI) **harmful by inhalation**
- KBr, anhydrous (pressed pellets: 25 mm diameter, 2 mm thick)
- Distilled water, 70 mL
- Nitrogen **Asphyxiation hazard**

Method

1. Add the liquid crystalline polymer CBZ6 (23 mg) to a glass vial (5 mL).
2. Add the chiral dopant CB15 (35 mg, 0.1 mmol) into another glass vial (5 mL) and add dry dichloromethane (1 mL) by pipette.
3. To the volumetric flask (5 mL) add the isocyanate cross-linker MBPI (5 mg) and make up the solution using dry dichloromethane (5 mL).
4. Remove a portion of the solution of CB15 in dichloromethane (2 mL) and add to the CBZ6 polymer giving a solution containing 30 mol% CB15.
5. Add a fraction of the solution of MDI in dichloromethane (0.5 mL) to the solution containing CBZ6 and CB15 to give a 10% molar excess of isocyanate to hydroxyl groups.
6. Weigh one of the KBr discs, place it on the hot-stage and heat to 35°C.
7. Using a pipette, add the solution of polymer, dopant, and cross-linker drop-wise to the KBr disc to form a droplet in the centre of the disc (15 mm diameter) and allow the solvent to evaporate. A flow of nitrogen over the sample may be used at this point to assist in evaporation but compressed air should be avoided as it may introduce moisture. When the solvent has evaporated the film will turn from transparent to opaque and the process may be repeated. Continue until all of the solution has been deposited.
8. Place the disc with the polymer film into a desiccator containing drying silica (for absorbing moisture) and paraffin wax (to absorb dichloromethane vapour) and leave for 1 h.
9. Weigh the disc and polymer film, the film should be opaque and of relatively uniform thickness any bubbles may be removed by the careful application of a *small* amount (less than one drop) of dry dichloromethane.
10. The disc is placed onto the hot-stage and the Mylar ring added such that it encircles the deposited sample. Heat the hot-stage at 5°C min⁻¹ to the cross-linking temperature (60°C).
11. Once the cross-linking temperature has been attained, add the second KBr disc to the top of the sample and apply pressure to define the sample thickness. If an aligned sample is desired a small, linear, oscillatory shear may be applied at this point (amplitude 5 mm, frequency 1 Hz).
12. Transfer the sample to an oven (preheated to 60°C) and place a mass (~50 g) on top of the sample to ensure it remains compressed to the thickness of the Mylar. Leave sample for 1–2 weeks to cross-link. Altering the

Protocol 12. *Continued*

duration of the reaction or the molecular weight of the polymer may be used to vary the degree of cross-linking.

13. On completion of the desired period of cross-linking the sample sandwiched between the two KBr discs is removed from the oven, placed into a beaker containing distilled water (50 mL) and left for the substrates to dissolve (~3–4 h).
14. The elastomer is removed from the KBr solution by floating it off onto a piece of Teflon sheet. Wash the elastomer twice in distilled water (20 mL) to remove any residual KBr and carefully pat dry with filter paper whilst on the Teflon substrate.
15. Weigh the sample; any mass loss at this point indicates either the presence of dichloromethane in the sample at the time of cross-linking or loss of CB15 during the process. Gain in mass indicates some absorption of water into the sample.
16. The elastomer is placed into a jar (~15 mL) containing dichloromethane (4 mL) and the jar is sealed for at least one hour to enable the elastomer to swell and the CB15 to be removed.
17. Remove the elastomer from the dichloromethane solution by again floating onto Teflon sheet and allow solvent to evaporate. Care must be taken, as the elastomer is highly swollen and fragile and will adhere to itself strongly if permitted to curl up during evaporation of the solvent.
18. Once most of the solvent has evaporated, the sample will become opaque and may be gently loosened from the Teflon surface and placed into an oven at 40°C to remove any residual dichloromethane.
19. The amount of CB15 extracted from the elastomer and the mass of the soluble fraction of the CBZ6 polymer may be determined from UV spectroscopy on the dichloromethane solution. In order to carry out the spectroscopic analysis the solution must first be diluted, typically a dilution of 100× is required to obtain an absorption of around 1 but this will vary slightly from sample to sample.

Cross-linked liquid crystalline polymers with the optical axis being macroscopically and uniformly aligned are called liquid single crystalline elastomers (LSCE). Without an external field cross-linking of linear liquid crystalline polymers result in macroscopically non-ordered polydomain samples with an isotropic director orientation. The networks behave like crystal powder with respect to their optical properties. Applying a uniaxial strain to the polydomain network causes a reorientation process and the director of liquid crystalline elastomers becomes macroscopically aligned by the mechanical deformation. The samples become optically transparent (Figure 9.7). This process, however, does not lead to a permanent orientation of the director.

Without stress, the elastomers relax to the polydomain structure. In order to achieve a permanent and uniform orientation in an LSCE, the conformation of

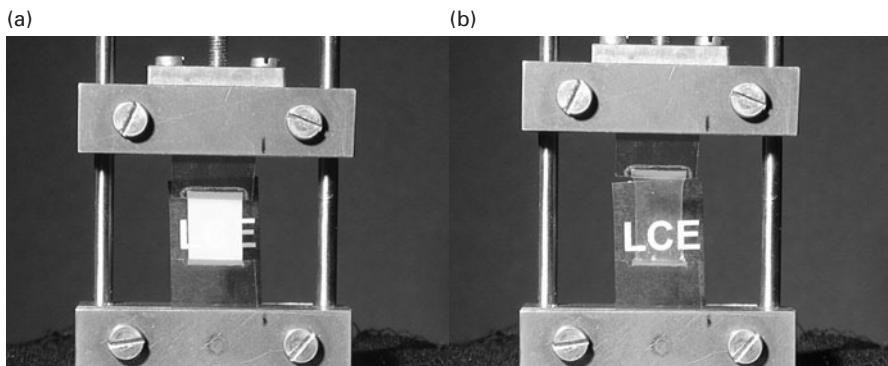

Fig. 9.7 Liquid crystalline elastomer (LCE): (a) polydomain sample ($\lambda = 1.0$); (b) sample aligned by a mechanical field ($\lambda = 1.4$) ($\lambda = L/L_0$, L = length of the sample, L_0 = length of the sample without load).

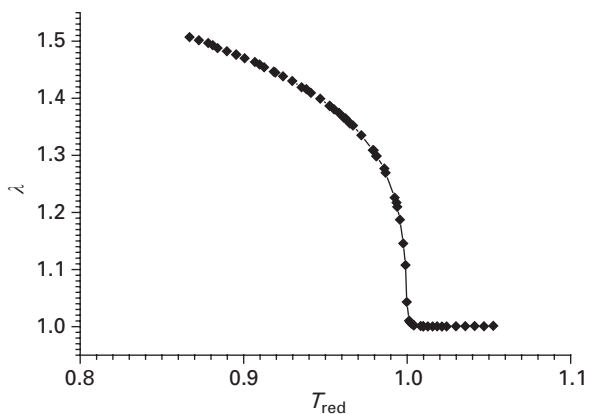

Fig. 9.8 The change in sample length observed when heating the LSCE from nematic to isotropic. Relative length $\lambda = L/L_{isotropic}$ of an LSCE versus reduced temperature $T_{red} = T/T_{n,i}$ ($L_{isotropic}$ = length of the sample in the isotropic state, T = temperature, $T_{n,i}$ = phase transformation temperature).

the network strands has to be consistent with the anisotropy of the nematic phase structure. This can be realized, if the network is additionally cross-linked in a second cross-linking reaction under load. The additional cross-links lock-in the anisotropic chain conformation and retain a reversible and uniform orientation of the nematic phase structure.

The uniform anisotropic structure of a nematic LSCE is directly reflected in the thermal expansion behaviour. When heating the LSCE from the nematic state into the isotropic state a strong reduction of the sample length along the optical axis is observed (Figure 9.8). This process directly indicates

the conformational changes of the network chains and the state of order between the nematic and isotropic state.

In the following the synthesis of a nematic LSCE is described.²⁰

Protocol 13.

Synthesis of a nematic liquid single crystalline elastomer (Scheme 10)

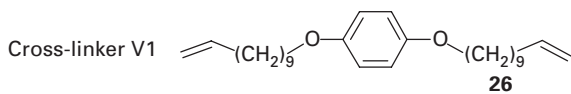
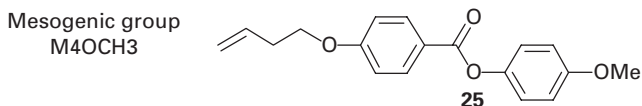
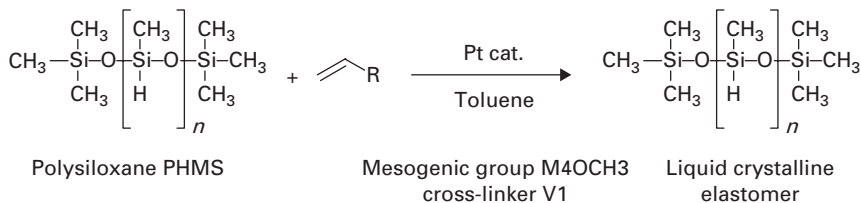

Scheme 10

Equipment

- Glass vial with cap (10 mL)
- Water-bath
- Teflon film (19.5 mm times 153 mm)
- Spin casting mould (see Figure 9.8)
- Glass syringe (0.45 μm Teflon filter)
- Microlitre syringe
- Thermostatted centrifuge
- Tweezers
- Adhesive tape (toluene resistant)
- Metal clips
- Vacuum oven

Materials

- Mesogen M4OCH3,²¹ 0.477 g, 1.6 mmol
- Cross-linker V1,²² 0.083 g, 0.2 mmol
- Poly(hydrogenmethylsiloxane)(degree of polymerization $n = 120$), 0.120 g, 2 mmol,
- Toluene, 2 mL
- Pt catalyst SML 86005, 6 μL

unknown (care!)

unknown (care!)

unknown (care!)

highly flammable, harmful by inhalation

unknown (care!)

Method

1. Prepare a solution of the mesogenic group M4OCH3 (0.477 g, 1.6 mmol), the cross-linker V1 (0.083 g, 0.2 mmol) and the poly(hydrogenmethylsiloxane) (0.120 g, 2.0 mmol) in toluene (1.5 mL). Use the glass vial for this step. Dissolve the solid substances with the help of the warm (50°C) water-bath if necessary.
2. Put a Teflon film (1.95 cm \times 15.3 cm) into the mould to make it possible to remove the swollen elastomer after the reaction.

9: Liquid Crystalline polymers

- Inject the solution into the mould by a syringe with a Teflon filter.
- Rinse the filter with 0.5 mL toluene and add the filtrate to the solution in the mould.
- Add 6 μL of the Pt catalyst to the solution using the microlitre syringe.
- Close the mould and fix the cover with screws.
- Mount the mould on the spindle of the thermostatted centrifuge (Figure 9.9). Turn on the thermostat and the centrifuge and carry out the reaction at 60°C, 4000 rpm for 1 h.
- Turn off the thermostat and the centrifuge, dismount the mould and cool it down to room temperature in a refrigerator or on ice.

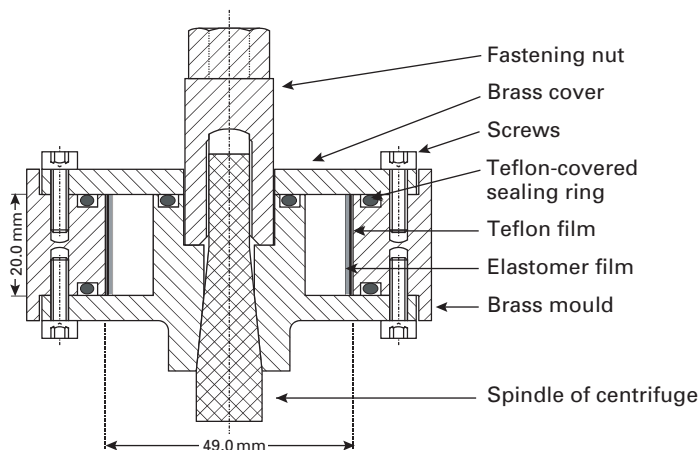

Fig. 9.9 Schematic diagram of the mould used for spin casting.

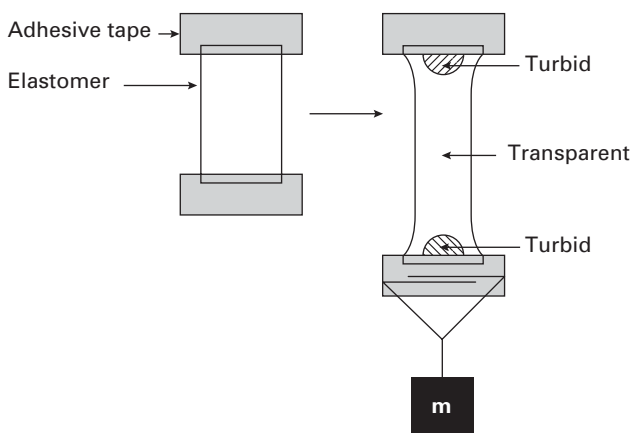

Fig. 9.10 The orientation process by a mechanical field.

Protocol 13. Continued

9. Open the mould and remove the swollen elastomer together with the Teflon film with the help of a pair of tweezers.
 10. Cut the elastomer in three parts and hang it on a retort stand with the help of the adhesive tape. Make sure that the edges of the elastomers are not damaged. Fix a metal clip to the other sides of the elastomers and load them carefully with 12 g (e.g. 30 clips) each for 30 min (Figure 9.10). The elastomers must stay transparent in the middle part. If this is not the case, increase the load without destroying the elastomers.
 11. De-swell the elastomers at room temperature for one week. After 24 h the load can be reduced to 5 g (e.g. 12 clips) if the elastomers stay transparent.
 12. Dry the elastomers in vacuum at 80°C for 24 h.
 13. *Characterization.* DSC results: glass transition, $T_g = -4^\circ\text{C}$; $\Delta C_p = 0.4 \text{ J g}^{-1} \text{ K}^{-1}$; nematic to isotropic phase transformation temperature $T_{n,i} = 71^\circ\text{C}$; $\Delta H_{n,i} = 1.4 \text{ J g}^{-1}$. X-ray: order parameter S (25°C) = 0.6 ± 0.1 .
-

6. Summary

In this chapter we have described some of the properties of polymeric materials with side-chain liquid crystalline units. As the reader will infer, there is little to distinguish the synthesis of these materials from other polymers described in earlier chapters (although side-groups may be chemically more complex). Where cross-linking is introduced, however, these materials exhibit interesting properties, which are determined by the state at the time of cross-linking. Under such circumstances, experimentalists need to think beyond the practicalities of forming covalent bonds between atoms and consider ways of for example aligning materials as these bonds are formed. It is through the use of combination of skills often involving scientists from a range of disciplines, that the promise of new materials such as those described in this chapter are being realized.

References

1. Onsager, L. *Ann. N. Y. Acad. Sci.* **1949**, *51*, 627.
2. Flory, P. J. *Proc. R. Soc. London* **1956**, *234A*, 73.
3. Elliot, A.; Ambrose, E. J. *Discuss. Faraday Soc.* **1950**, *9*, 246.
4. (a) Tanner, D.; Gabard, V.; Schaefer, J. R. *Polymers for Advanced Technologies; IUPAC International Symposium*; **1988**, p. 384. (b) Kwolek, S. L.; Morgan, P. W.; Schaefer, J. R.; Gulrich, L. W. *Macromolecules* **1977**, *10*, 1390. (c) Du Pont (Kwolek, S. L.) *British Patent*, 1,283,064. (d) Jaffe, M.; Jones, S. R. *In High Technology Fibres, Part A*; Lewin, M.; Preston, J., eds, Dekker: New York; **1985**. (e) Morgan, P. W. *Macromolecules* **1977**, *10*, 1381.
5. Ballauff, M. *Angew. Chem. Int. Ed. Engl.* **1989**, *28*, 253–267.

9: Liquid Crystalline polymers

- Finkelmann, H. In *Polymer Liquid Crystals*; Ciferri, A.; Krighbaum, W. R.; Meyer, R. B., eds, Academic Press: New York; **1982**.
- Piskunov, M. V.; Kostromin, S. G.; Stroganov, L. B.; Plate, N. A.; Shibaev, V. P. *Makromol. Chem. Rapid Commun.* **1982**, 3(6), 443–447.
- Portugal, M.; Ringsdorf, H.; Zentel, R. *Makromol. Chem.* **1982**, 183, 2311–2321.
- (a) Attard, G. S.; Williams, G. *Chem. Br.* **1986**, 22(10), 919–924. (b) Hirai, A.; Mitchell, G. R.; Davis, F. J. *New Polym. Mater.* **1990**, 1, 251–260.
- Zentel, R. *Angew. Chem. Int. Ed. Engl.* **1989**, 28, 1407–1415.
- Wang, X.-J.; Warner, M. *J. Phys. A* **1987**, 20, 713–731.
- Davis, F. J. *J. Mater. Chem.* **1993**, 3(6), 551–562.
- Fieser, L. F. *J. Am. Chem. Soc.* **1953**, 75, 4400.
- Patel, S. I. *Memory Effects in Liquid Crystalline Elastomers*; PhD Thesis; University of Reading; **2001**.
- Shannon, P. J. *Macromolecules* **1983**, 16, 1677–1678.
- Shannon, P. J. *Macromolecules* **1984**, 17, 1873–1876.
- (a) Broer, D. J.; Mol, G. N. *Makromol. Chem.* **1989**, 190(1), 19–30. (b) Brittin, M.; Mitchell, G. R.; Gilbert, A. *Mol. Cryst. Liq. Cryst.* **2001**, 357, 99–115.
- Warner, M. In *Side-Chain Liquid Crystal Polymers*; McArdle, C. B., ed., Blackie: New York; **1989**.
- Hasson, C. D.; Davis, F. J.; Mitchell, G. R. *J. Chem. Soc., Chem. Commun.* **1998**, 2515–2516.
- Küpfer, J.; Finkelmann, H. *Makromol. Chem. Rapid Commun.* **1991**, 12, 717–726.
- Finkelmann, H.; Rehage, G. *Makromol. Chem. Rapid Commun.* **1980**, 1, 31.
- Kundler, I. PhD Thesis; Freiburg, Germany; **1998**.

Index

Page entries in *italics* refer to protocols on those pages

- acrylonitrile
 - copolymer with 4-vinylpyridine *61–62*
 - pyrolysis of *60*
- 11-acryloyloxy-undecanoic acid
 - cholesteryl ester *232–233*
- anionic polymerisation *67–89*
 - of methyl methacrylate *73–75*
 - of styrene *71–72*
- antimony oxide *134–135*, *141*, *142–143*
- aromatic polyamide *127–129*
- atom transfer free-radical polymerisation (ATRP)
 - 116–123*
 - of oligo(ethylene glycol) methacrylate *121–123*
 - polyethylene oxide based initiator for *120–121*
 - of styrene *118–120*
- atomic force microscopy *16–18*
- bacteria-imprinted polymer *210*, *211–214*
- benzyl acrylate
 - from benzyl alcohol *52–54*
 - polymerisation of *52–55*
- 1,2-bis(2-chloroethoxy) ethane *139*
- 11-bromoundecanoyl chloride *230–231*
- carbon fibres *60*
- chain growth polymerisation *43*
- cholesteric alignment *233–234*
- cholesteryl 11-bromoundecanoate *231–232*
- cholesteryl 2-(acryloyloxy)ethyl carbonate
 - 229–230*
- cholesteryl 4-vinylphenyl carbonate
 - polymerisation of *205–207*
 - preparation of *203–205*
- Claytone *138*, *142–143*
- coordination polymerisation *90–95*
- core shell sequencing
 - PAMAM dendrimers *192*
 - PE dendrimers *195*
- 3-[6-(4'-cyanobiphenyl-4-yloxy)hexyl]pyrrole
 - polymerisation as an aligned film *176–178*
 - polymerisation using ferric chloride *174–176*
 - preparation of *173–174*
- 4-cyanophenyl-4'-(6-propenoyloxyhexyloxy)benzoate
 - synthesis of *222–223*
 - copolymer of *223–225*
 - cross-linking in copolymer containing *235–240*
- 4,4'-dichlorodiphenylsulphone *152–156*
- dielectric spectroscopy *23–24*
- differential interference
 - contrast microscopy *11*
- differential scanning calorimetry *19–21*
- differential thermal analysis *18–19*
- 4,4'-difluorobenzophenone *147–148*, *150–152*
- 4,4'-dihydroxybenzophenone *147–148*
- 1,1-diphenylethene *73*
 - in polymerisation of ethylene oxide *84–87*
- divinylbenzene *2*
- divinylbenzene *64–65*, *209–210*
- double manifold *51–52*
- Durham route *3*
- dynamic mechanical thermal analysis *21–23*
- electron energy loss spectroscopy (EELS) *14*
- electron microscopy *11–14*
 - etching in *12–13*
 - scanning *13–14*
 - stains for *12*
 - transmission *11–12*
- emulsion polymerisation *64*, *65*, *66–67*
- energy dispersive spectrometry *15*
- ethylene oxide
 - in initiation of ATRP *120–121*
 - ring opening polymerisation of *87–89*
- ethyleneglycol dimethacrylate *205–206*
- ferric chloride oxidation of pyrrole *167–168*
- flash column chromatography *112–113*
- free-radical chain polymerisation
 - of benzyl acrylate *52–55*
 - chain-transfer agents in *47*
 - copolymers from *57–62*
 - as emulsion polymerisation *64*, *65*, *66–67*
 - initiators for *46*
 - mechanism of *44–45*
 - of N-isopropylacrylamide *62–63*
 - of styrene-d₇ *56–57*
 - as suspension polymerisation *64*, *64–65*

Index

- gel permeation chromatography 4–7
- gels 62
- generations for dendrimers 188
- group transfer polymerisation 101–108
 - of a block copolymer 106–108
 - catalyst for 103–104
 - of methyl methacrylate 104–106
- 1-hexene polymerisation 92–93
- 3-hexylthiophene
 - electrochemical polymerisation 181–183
 - polymerisation using nickel catalyst 183–185
- hydrosilylation 225–226 226–228
- 4-(6-hydroxyhexyloxy)benzoic acid 217–219
- infra-red
 - microscopy 15
 - spectroscopy 15
- interfacial polymerisation 136–138
- isophthalic acid 128–129
- isoprene block copolymer with styrene 78–80
- Kevlar 1
- light scattering
 - detector for GPC
 - determination of Mw using 4
- liquid single crystal elastomer 242–244
- magnetic field orientation of liquid crystalline elastomer using 242–244
- MALDI-ToF 5–7
- mechanical field orientation of liquid crystalline elastomer using 242–244
- metallocene 3, 92–93
- methyl methacrylate
 - group transfer polymerisation of 106–108
 - polymerisation of initiated by 9-fluorenyllithium 73–75
- molecular weight
 - determination for polymer 4–7
 - number average 4
 - viscosity average 4, 5
 - weight average 4
- N*-[benzyl sulphonyl]pyrrole
 - acylation of 171–173
 - hydrolysis of 171–173
 - preparation of 171
- N*-isopropylacrylimide 62–63
- non-periodic crystallisation 135, 136
- norbornene polymerisation 94–95
- Nuclear Magnetic Resonance
 - ¹³C integrated intensity 9
 - monomer sequences 9
 - tacticity from 7–9
- nylon
 - 6,6 127
 - rope trick 127
- octavinylcyclotetrasiloxane – ring opening polymerisation of 87–89
- oligo(ethylene glycol) methacrylate polymerisation using ATRP 121–123
- optical microscopy 9–11
- organometallic coupling 181, 183–185
- p*-(6-propenoyloxyhexyloxy) benzoic acid 219–221
- phosphorylation procedure for polyamide synthesis 127–129
- photopolymerisation 233–234
- polarised light microscopy 9–11
- poly(aniline) 178–181
 - chemical oxidation 180–181
 - electrochemical polymerisation 179–180
- poly(esterether) 130–135
- poly(ether ketone)
 - cyclic oligomers from 146–152
 - synthesis in solution 147–148
 - synthesis under pseudo-high dilution conditions 150–152
- polypyrrole
 - electrochemical synthesis of 163–165, 164–165
 - d*₅ 165–167
 - 2,4-dimethyl- 167–168
- polythiophene 181–185
- potassium pyrrole 169–171
- p*-phenylenediamine 128–129
- pseudo-high dilution conditions 150–152
- Raman microscopy 15
- reactivity ratios 57–58
- ring-opening metathesis polymerisation 3, 93
 - of norbornene 94–5
- ring-opening polymerisation 44
 - of ethylene oxide 84–87
 - of octavinylcyclo-tetrasiloxane 87–89
- Sacrificial spacer 203, 203–210
- scanning probe microscopy 16–18
- Schlenk flask 115

Index

- sodium naphthalene anion
 - polymerisation of styrene by 76–77
- solvents – properties and purification 49–50
- starburst dendrimers 188–199
 - polyamidoamine 188–189, 190–193
 - poly(ether) dendrimers 193–196, 196–199
- step-growth polymerisation 44
- Stille reaction 3
- styrene
 - cationic polymerisation 89–90
 - copolymers containing
 - block 80–83, 78–80
 - random 58–60
 - d*₇ polymerisation 56–57
 - initiation of polymerization by *s*-butyllithium 71–72
 - initiation of polymerization by sodium naphthalene anion 76–77
 - polymerisation using a TEMPO based initiator 114–116
- sulphone-linked paracyclophanes 152–156
 - synthesis of 152–156
- supercapacitors 2
- supercritical CO₂ 2
- suspension polymerisation 64, 64–65
- syringe pump 151, 152
- template 201
- tert-butyl acrylate
 - block copolymer with styrene 80–82
 - hydrolysis of block copolymer containing 82–83
- 2,2,6,6-tetramethylpiperidinyl-1-oxide (TEMPO) 110
 - initiator based on 110–114
 - in polymerisation of styrene 114–116
- thermal analysis 18–23
- thermoplastic elastomers 3
- 4,4'-thiobis(benzenethiol) 152–156
- (4-vinylphenoxy)dimethylphenylsilane
 - polymerisation of 209–210
 - preparation of 207–208
- Woods metal bath 141
- X-ray scattering 24–29
 - small angle 28–29
 - wide angle 26–28
- Ziegler-Natta 3
- zinc acetate dihydrate 141, 134–135 142–43