

# The Watch of the Future

The Story of the  
Hamilton *Electric* Watch



Second Edition,  
Revised and Expanded

René Rondeau

On January 3, 1957, the Hamilton Watch Company announced a revolutionary new invention: the world's first battery-powered wristwatch. Now the complete story of this legendary watch is told in *The Watch of the Future* by René Rondeau.

It is a story of innovation and triumph, as well as corporate politics and discouraging setbacks. The development of the first electric watch is traced from its origins in 1946 through the end of production in 1969. The true story of the brilliant and ambitious styling which make these watches so popular today is also revealed.

Dozens of detailed photographs illustrate the painstaking process of making a watch which would run without a mainspring. You'll see rare prototypes, unusual dials, and unique watches.

In Part 2 every production model of the Hamilton Electric watch is illustrated and identified with its date of introduction and original selling price, and the most collectable watches are described in detail.

A special chapter on collecting Hamilton Electrics gives helpful information about evaluating, repairing, and maintaining these unique watches.

*The Watch of the Future* is a must for every watch collector, and all those who enjoy the modernistic styling of the 1950's.

For Clair Slank -

With Best Regards,

Paul R. —

5/5/93

V  
a  
b  
c  
t  
F  
  
u  
d  
c  
c  
d  
b  
t  
r  
  
t  
v  
s  
u  
  
t  
a  
a  
c  
  
F  
r  
r  
  
e  
e

# *The Watch of the Future*

*The Story of the Hamilton Electric Watch*

*Second Edition, Revised and Expanded*

*by René Rondeau*

*The Watch of the Future*

Second Edition, Revised and Expanded

Copyright © 1992, 1989 by René Rondeau

All rights reserved. No part of this book may be reproduced in any manner whatsoever without written permission from the publisher, except in the case of brief quotations embodied in critical articles and reviews.

Published by the author:

*René Rondeau*

*120 Harbor Drive*

*Corte Madera, CA 94925*

Printed in the United States of America

Library of Congress Catalog Card Number 92-93327

ISBN 0-9622219-1-0

Dedicated to the memory of  
James H. Reese

## *ACKNOWLEDGMENTS*

Many people have contributed to this book and without their help the story could never have been written. Foremost among them is James H. Reese, co-inventor of the Hamilton Electric, who spent many days answering questions about his work and who patiently taught me the intricacies of the operation and adjustment of the Model 500 and 505 movements. Sadly, Jim Reese passed away on March 21, 1992.

I am deeply indebted also to the late Fred Koehler, who at age 91 had lost none of his keen memory and skill, and who supplied many important materials relating to the early development of the watch.

Mrs. John Van Horn generously made available her husband's personal files which contained very significant information.

I also wish to thank Houston A. Rogers, one of the first dedicated collectors of Hamilton Electrics, who supplied catalogs, promotional materials, and other documentation. Without his help and experience this book could never have been possible.

Dr. Robert Ravel, who acquired the contents of the Hamilton Research Laboratory when the company was sold in 1970, has been an invaluable source of information. Thanks to his efforts over the past twenty years many critical documents and other items were spared from destruction. I am profoundly grateful to him.

I am indebted to the many former Hamilton employees who shared their experiences with me: Eugene Barber, William O. Bennett, Richard Blakinger, Wallace Bork, Lou Brethauer, Ray Carbonetta, Mike Carioselli, Kenneth Derr, John Dudley,



Jim Eckenrode, Ray Enders, Ed Fechter, Ira Fickes, Arthur Fillinger, Paul Frankenfeld, Wilmer Gingrich, Murray Gould, John Hendricks, Cleon Hougendobler, Roderick Jackson, John James, Aaron Johnson, Edward Jones, Floyd Jury, Al Kleiner, James LeVan, Paul Lenox, Philip Lichty, Robert McCollough, Harry P. Miller, Jay Miller, Jake Missimer, Harold Morgan, Doris Ober, Oscar Petters, Harold Quickel, J. Frank Remley, Frank Russell, Martin A. Ryan, Egbert Van Haaften, Marlin Walmer, and William Wolfe. Also, Richard Arbib, Mrs. Philip Biemiller, William O. Smith, Jr., and Jean Wuischpard.

Special thanks to Jeffrey Hess, who generously shared information about styling which he acquired in his own research. I also thankfully acknowledge the assistance of the National Association of Watch and Clock Collectors.

I am particularly grateful to Jerome C. Draper, Jr. for the use of technical equipment essential to the production of this book, and for the opportunity to pursue my research activities.

The superb photographs in this edition were taken by Mark Rathbun, who is not only a skilled photographer but a serious Hamilton Electric devotee as well.

Finally, I want to thank my wife, Fran, and my daughter, Christie, for their support and encouragement as I have continued to pursue my obsession with this fascinating story.

## *PREFACE*

Like many other watch collectors, I was first attracted to Hamilton Electrics because of their unusual styling. When I bought my first Electric, a "Pacer," I knew very little about it. There were few books about wristwatches at the time, and they contained little substantial information about Hamilton Electrics.

I began to wonder how the unusual electromechanical movement was developed, and who had designed the remarkably avant-garde cases. As I added more watches to my collection I found that many were not illustrated in the standard references. I wondered how many others there might be, and what they were called. This curiosity led me to do a little research, but I was quickly disappointed to find that, aside from brief microfilmed newspaper articles reporting the first watch in 1957, there was little to be found.

My first stumbling attempts to find out more about the Hamilton Electric eventually led to countless telephone calls and letters, and finally many visits to Lancaster, Pennsylvania to interview former employees first hand. The story grew slowly, pieced together from many small scraps of information. Each contact led to others, until eventually I had talked with everyone I could find who was in any way involved with the Hamilton Electric project, nearly four dozen individuals in all. I also sorted through hundreds of pages of memos and reports. This task would have been easier if the factory had saved its old records, but instead I was forced to assemble the paperwork from several different sources.

Thirty years had passed since the world's first battery watch was invented, and the memories of those who developed

it were not always precise. Yet, surprisingly, there were very few contradictions in the accounts of different individuals. Every recollection, no matter how trivial, helped to put things into perspective, and the occasional gaps or minor discrepancies in the story were resolved by the written documentation.

I published the first edition of *The Watch of the Future* in early 1989 and have been grateful for the positive response it has received. However, my research did not stop with the publication of the book and I have uncovered a great deal more information in the past three years. This new edition incorporates this material and makes the story as complete and accurate as possible.

I hope that others will share my fascination with this pioneering invention and that the work of the many individuals who developed it will finally be acknowledged.



HAMILTON  
WATCH  
COMPANY

# CONTENTS

Introduction	10
<b>PART 1: THE HISTORY</b>	
Chapter 1: <i>An Idea Whose Time Had Come</i>	14
Chapter 2: <i>Memorandum</i>	23
Chapter 3: <i>The Project Begins</i>	26
Chapter 4: <i>Progress</i>	34
Chapter 5: <i>Model 500</i>	43
Chapter 6: <i>Press Conference</i>	50
Chapter 7: <i>Styling and Advertising</i>	58
Chapter 8: <i>Problems and Competition</i>	69
Chapter 9: <i>Improvements</i>	77
Chapter 10: <i>Unfulfilled Dreams</i>	89
Chapter 11: <i>Collecting Hamilton Electrics</i>	97
<b>PART 2: THE WATCHES</b>	111
<b>APPENDIX 1: <i>Model 500 Contact Adjustment</i></b>	156
<b>APPENDIX 2: <i>Model 505 Service Guide</i></b>	163
Index	165

## *INTRODUCTION*

In 1951 America went on a buying spree which was to last most of the decade. After five years of deprivation during the War and five more years of rebuilding American industry, consumers were eager to indulge themselves. The suburbs grew and blossomed and the cars which took us there became larger and more ornamental. Televisions, radios, dishwashers, and other luxuries became necessities. It was the decade of the future: of rockets and speed, and a promise for ever greater conveniences to come.

However, while most American industries flourished in the 1950's there was one which was languishing – the watch industry.

Watchmakers had enjoyed their heyday two decades earlier in the 1930's, when many people were buying wristwatches for the first time, to replace their outmoded pocket watches. Unlike today, when quartz digital watches have become so cheap as to be disposable and fashion dictates different watches for different occasions, thirty or more years ago most people selected a watch with great care, with the expectation that it would last a lifetime and even be passed on to future generations.

By the 1950's the market for wristwatches had dwindled to those few first-time buyers – high school and college students – and the occasional person replacing an older watch or searching for a company award. The Hamilton Watch Company was feeling the pinch even more than some other manufacturers. Founded in Lancaster, Pennsylvania in 1892, Hamilton had always taken pride in producing high quality watches which were considered to be the finest in the U.S.

But, after World War II, Hamilton's traditional market was eroding under the pressure of competition from Elgin, Bulova, and other watchmakers. Timex had recently entered the market with inexpensive and rugged watches, opening a new market for 'casual' watches. Whereas in the 1930's Hamilton had proudly boasted that all of their watches were cased in precious metals, by 1953 stainless steel watches, many with imported Swiss movements, had begun to appear in the Hamilton catalog. In an attempt to increase their market share the company also launched a line of less expensive watches under the 'Illinois' label.

However, if Hamilton was to share in the consumer spending bonanza the company needed something so new and so futuristic that it would make old watches obsolete -- just as the wristwatch had done to the pocket watch thirty years before. As the decade opened, Hamilton's researchers and managers saw the answer in the 'watch of the future,' the electric watch.

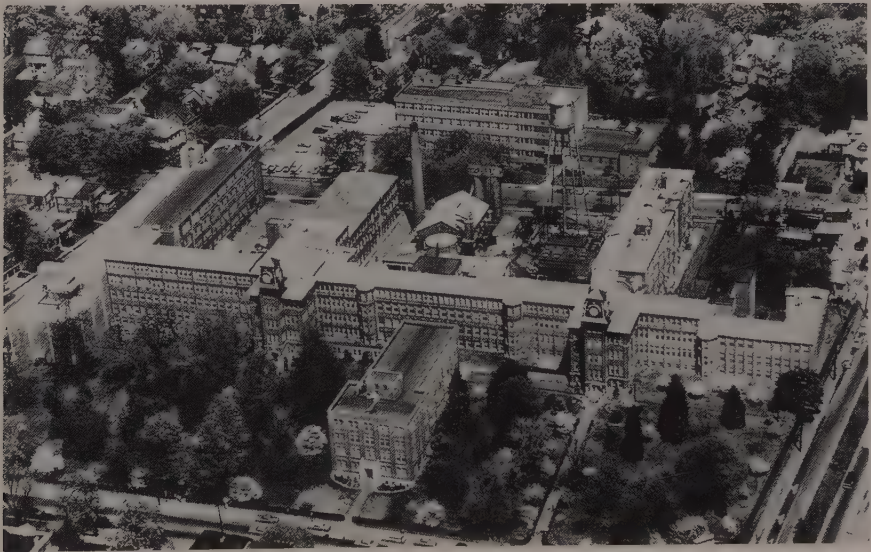

*The Hamilton factory covered a full city block in Lancaster, Pennsylvania. The small building behind the factory housed the Research and Development laboratory. [Factory photo, courtesy NAWCC library.]*





# Part 1: The History

## CHAPTER 1:

### *AN IDEA WHOSE TIME HAD COME*

On Wheatland Avenue in Lancaster, Pennsylvania, stands a modest five story brick building. There is nothing extraordinary about the structure and nothing to suggest its importance in the history of watchmaking. But it was here that the grandfather of all modern watches was invented: "the watch of the future," the world's first battery-powered watch.

Situated in the shadow of the massive Hamilton Watch Company factory, the laboratory building was the home of the Research and Development Department. The 75 scientists assigned to R&D enjoyed a very open working environment, unlike the rigidly structured roles of the assembly-line workers in the factory across the street. Under the direction of a Research Manager they explored new ideas for improving existing watches and production methods, such as new hair-spring alloys, improved dial finishes, better lubricants, and automated production machinery.

In the frequent meetings researchers held, new concepts were sometimes explored. The most promising ideas, those with commercial possibilities, would be assigned to an engineer for possible development, a process which might take months or years. While most of the accomplishments of the Research Department would never be noticed by the average consumer, one new product would revolutionize the watch market: the electric wristwatch. The invention of this futuristic wonder was, however, a long and painfully slow process.

The story begins in 1946 when research manager George Luckey, later to become Hamilton's president, decided to

*AN IDEA WHOSE TIME HAD COME*



*Hamilton's Research and Development Laboratory. [Factory photo, courtesy NAWCC library.]*

explore the possibility of producing a watch to be powered by batteries. (Miniature batteries had been developed during World War II and manufacturers in many fields were quick to recognize the possibilities than such an invention presented.)

The project was assigned to researcher Arthur E. Fillinger, who proceeded to design Hamilton's first battery-powered timepiece. For two very practical reasons this was made as a clock rather than a watch. For laboratory ex-

THE WATCH OF THE FUTURE

perimentation it was logical to make the movement large enough to be easily workable. And, even more importantly, miniature batteries were still in the development stages and none were commercially available yet.

Fillinger experimented for nearly two years with different materials for the coil and contacts. Dozens of contact systems were tried but all of them were prone to burning because of the powerful spark created each time they opened. The addition of a spark suppressing diode in the circuit helped alleviate the situation, but it remained a problem.

Although no watch-sized movement was ever built, in 1947 Fillinger applied for a patent based on a conjectural drawing adapted from his clock. It was not the first electric movement to be patented – several types of electric clocks had

Dec. 4, 1951

A. E. FILLINGER  
ELECTRIC WATCH

2,577,703

Filed Oct. 31, 1947

2 SHEETS—SHEET 1

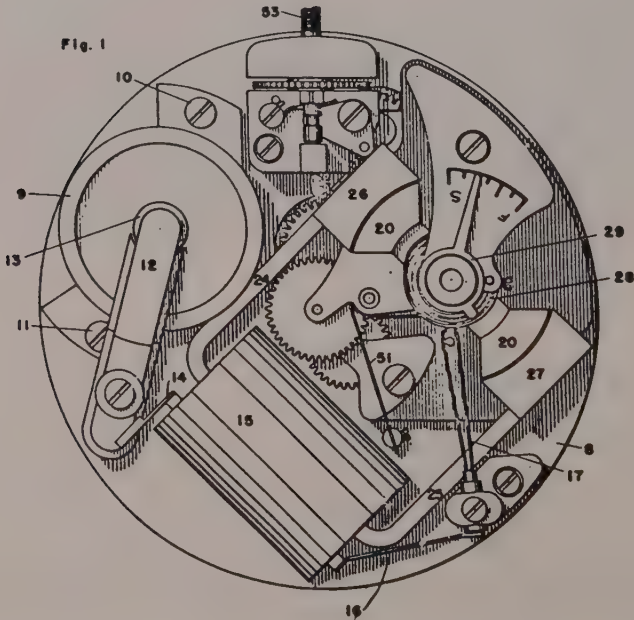

been made as long ago as the nineteenth century – however it was the first to be issued for an electric watch and it was an important step on the path to the battery-powered watch. In later years the company pointed with pride to the fact that this was their first patent on an electric watch.

Fillinger transferred out of the research department at the end of October, 1947, shortly after designing the movement. The work was taken over by John Hendricks, who continued to experiment with different contact systems.

In February, 1948 a model electric clock, cased in lucite, was displayed at Hamilton's annual sales conference. While it was an exciting concept, it was still very crude. After four days of operation the clock was 90 minutes off.

Work continued through May of 1950. Several more movements were built, only two of which were cased. Despite the time and effort spent in development the movements remained unreliable. Accuracy was improved, but problems with the contact system persisted. The clock was inherently flawed.

In January, 1950 a completely new movement was designed and built: the "Koehler Clock."

Fred Koehler was a 53-year-old German immigrant who had joined Hamilton as a Master Technician in 1935. Born in Munich in 1897, Koehler learned watchmaking in Chemnitz during World War I. He left Germany in 1925 to escape the severe economic depression which devastated the country after the war. After two years in Amsterdam, he emigrated to the United States, where he first worked for the Gruen Watch Company in Cincinnati.

Koehler was a creative inventor, but a very private and independent worker. He was a very modest man but in talking with his colleagues it is clear that Koehler was something of a legend in his own time, considered by many to be the finest watchmaker in Hamilton's history. His crowning achievement during his 27 years with the company was the development of Hamilton's famous marine chronometer during World War II.

## THE WATCH OF THE FUTURE



*Fred Koehler in 1957. This photo appeared in the Hamilton company magazine, "Timely Topics," with the caption "Hamilton's first electric-powered clock was made entirely by hand by Fred Koehler." Note the small clock at the rear of his workbench; it is the same clock pictured on the next page.*

More accurate than the imported models formerly used by the military, the Hamilton chronometer was the first which could be constructed on an assembly-line basis without the meticulous hand work normally required.

As the craftsman who had constructed the working models of the Fillinger/Hendricks clocks, Koehler understood the weaknesses of the design. He devised an electromagnetic movement of his own which incorporated significant improvements in the contact system and reductions in energy consumption. He also fashioned a more efficient indexing system to drive the hands. In October of 1951 he applied for a patent, titled "Electric Watch."

In his first laboratory model the movement was slightly larger than a pocket watch, but his intention was to reduce its size to wristwatch dimensions. (Making such a watch was not

AN IDEA WHOSE TIME HAD COME

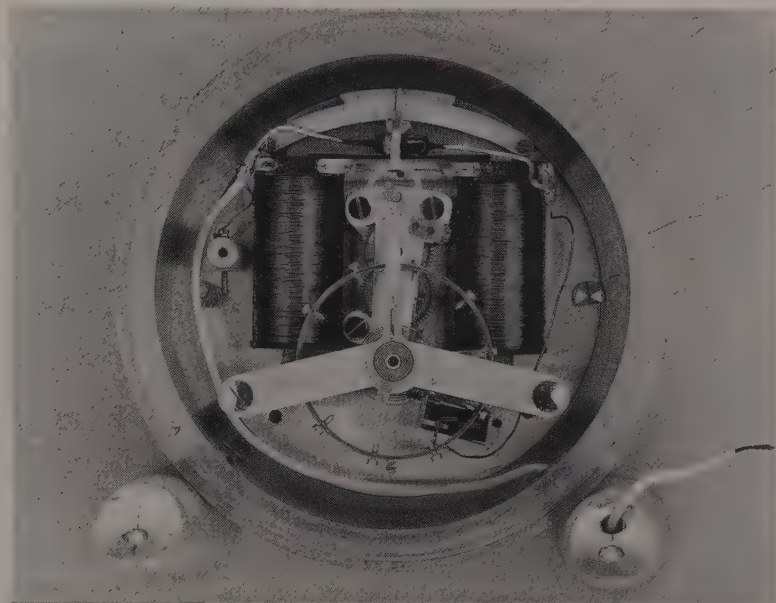

The 'Koehler Clock.' This is the first model, housed in a nickel-plated brass case. The movement is detailed in the patent drawing below.

Dec. 15, 1953

F. KOEHLER  
ELECTRIC WATCH

2,662,366

Filed Oct. 19, 1951

3 Sheets-Sheet 1

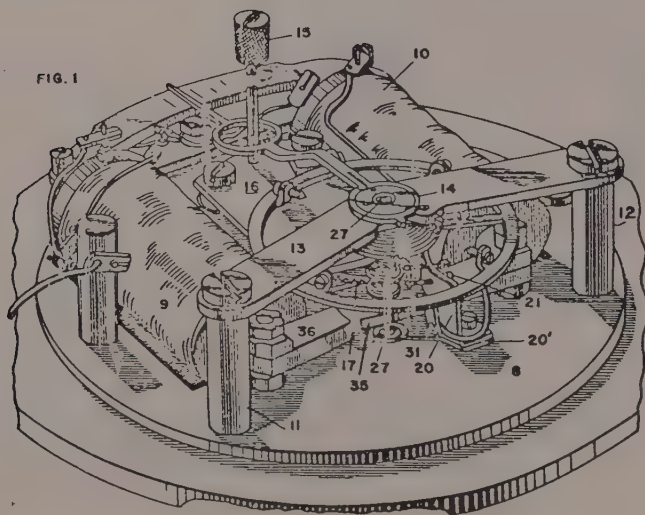

a simple matter of miniaturizing the parts because the smaller size also changes its electrical and magnetic properties.) In the Koehler clock the balance wheel drives the movement as well as regulating its speed.

Koehler's original model was fitted in a nickel-plated brass case with a display back and an etched dial designed by Koehler. A conventional C cell battery, mounted on the feet, supplied the necessary power. In all, six experimental models of the Koehler clock were constructed, each incorporating minor differences in design or construction.

Koehler's clocks were impressive in their performance. A laboratory record notation in September, 1952 indicated that "the timekeeping ability of the electric clock is equal to or better than that of a railroad watch."

Despite the significant advances which had been made in the five years since 1946, at the end of 1951 there was still no concerted effort at Hamilton to produce a viable electric watch. What was needed was a guiding force, someone who had the authority to influence Hamilton's management to support the project, and the drive to carry the concept through the complex stages of design and production. That man was John Van Horn.

When he first became intrigued by the concept of a battery-powered wristwatch early in 1952, Dr. John A. Van Horn was a 36-year-old physicist whose business acumen would ultimately be as important as his scientific skills. Van Horn was shrewd enough to understand the complex political dynamics of his department, as well as the byzantine corporate structure of the company. He realized something that others had not. In such a large company it was not enough to design a new product; it was equally important to maintain a level of commitment on the part of management. Van Horn was not just a far-sighted theoretician. He was a decisive and ambitious manager with a clear idea of his mission and how to accomplish it.



*AN IDEA WHOSE TIME HAD COME*

A native of Butte, Montana, John Van Horn earned his Doctorate in Physics at Pennsylvania State University in 1949. During World War II he worked as a civilian physicist with the Signal Corps and as a physics instructor in the Navy V-12 program. Prior to finishing his studies he worked as a research physicist at Airadio in Connecticut. Despite his experience in the private sector Van Horn was always an academic at heart.

*Dr. John A. Van Horn, responsible for the development of the Hamilton Electric watch.  
[Courtesy Mrs. J.A. Van Horn.]*



(Ultimately, he ended his career as a college professor.) He was reluctant at first to accept a position at Hamilton, but in later years he jokingly defended his decision by saying that, unlike some of his academic colleagues, he "wasn't convinced that a piece of work is inferior solely because it is useful."

Van Horn joined Hamilton in 1949 as Senior Physicist. By 1951 he had been promoted to Chief Physicist, in charge of

*THE WATCH OF THE FUTURE*

the Physics Section of the Research Department. His stature increased dramatically at that time, in part due to the fact that Hamilton's president was impressed with Van Horn's academic credentials.

Early in 1952 Van Horn learned of a persistent rumor which had begun circulating in the watch industry: the Elgin Watch Company was reportedly planning to market an electric watch. This news added a sense of urgency to Van Horn's growing interest in the subject. He recognized that such an invention would not only be an exciting challenge, but also an opportunity to further his own reputation and career.

Van Horn held a series of meetings to study the possible directions and electric watch project might take. Based on these discussions he wrote a memo which would prove to be a significant turning point in Hamilton's history.

## CHAPTER 2:

### MEMORANDUM

From: Dr. John A. Van Horn  
[Chief Physicist]

To: G.E. Shubrooks  
[Manager of Research]

Date: April 3, 1952

Subject: Electric Watches

*The current active interest in electric watches has resulted in considerable discussion of feasible mechanisms, particularly with Messrs. [Philip] Biemiller, [Ray] Enders, and [Fred] Koehler. This memo is intended to summarize these discussions.*

*There appear to be three types of movement justifying consideration. The first of these is the electric clock which has been designed by Mr. Koehler, of which several models actually exist. In this clock, the actual timekeeping is done by a balance wheel and hairspring. It is different from a standard watch in that the source of the power which moves the train is in the balance unit instead of in the barrel at the other end of the train. Mr. Koehler has developed a satisfactory method of indexing the hands from the balance wheel and the existing movements keep excellent time.*

*The drive is accomplished as follows: the balance staff carries a small rod of soft magnetic material, this rod lying parallel to the plane of the balance wheel. At some angle before the rest position of the balance, this rod begins to enter a gap in an electromagnet which is energized at this time by the closing of a contact also operated from the staff. The rod is drawn into the gap, feeding energy into the wheel, until the circuit is broken at*

about the time the rod lines up with the field. Indexing also occurs during this interval.

A second type of movement would be very similar to this one. Retaining the same indexing mechanism, it would be possible to build an instrument in which the current flows in a flat rectangular coil carried on the balance staff, the axis of coil and staff being the same. Near the rest position of the wheel, the coil enters a slot in a permanent magnet and a contact is closed so that the coil is energized and its field reacts with that of the permanent magnet.

Clearly these two instruments are much alike, differing in the same way in which a moving coil galvanometer differs from a moving magnet galvanometer. It is worthy of note that the moving coil is used in most galvanometers.

The second instrument might have some advantages. The major one would be an increase in efficiency. In the first instrument, the energy of the battery is used to magnetize a comparatively large piece of material. This energy is dissipated in the form of a spark where the contact is opened. In the second instrument, the current does not magnetize any 'iron', since the only magnetic material in the vicinity is permanently magnetized to saturation. A related advantage would be the minimization of contact burning with the smaller currents and with the elimination of the collapsing field. A third probably advantage would be the decreased sensitivity to external magnetic fields.

It might also have some disadvantages which would become apparent in the construction. Also, the disadvantages of the present instrument can undoubtedly be decreased by some redesign of the magnet. In the first experimental instrument, the problem was to make a clock which worked. It should now be possible to consider the choice of materials which will give a maximum efficiency and a minimum size.

A third instrument postulated would depend for its timekeeping on the vibration of a reed either made of magnetic material or carrying magnets or magnetic material. This reed would control the frequency of an electrical oscillator powered by

MEMORANDUM

*a battery and using a transistor for its valve. The moderately high frequency alternating current from this oscillator would be used to operate a mechanism essentially an ordinary plug-in electric clock.*

*It is much more difficult to evaluate the prospects of success with such an instrument since no work has been done on it. It is known, however, that the transistor permits building a very tiny audio oscillator. One was shown at a recent local IRE meeting. It is not impossible that Elgin's electronic watch is some such instrument. If it could be built, it would have the advantages of excellent timekeeping and negligible position error. It would have the disadvantage of requiring a transistor which is expensive and not immediately obtainable in quantity if at all. It would probably be subject to magnetic disturbance as presently conceived.*

*It is not known if the interest of the company is enough to justify a great deal of work on electric movements. If such is the case, it is the opinion of the writer that all three of these conceptions hold enough promise to justify a careful experimental examination. In the case of the first, this amounts to a measurement of the characteristics of an existing model and is being done. In the case of the second, it amounts to a variation of the first mechanism. In the case of the third, the problem is probably elaborate.*

*Finally, it is noted that these comments are not presented as the work of the writer. The present clock, both mechanically and electrically, is the work of Fred Koehler. The other concepts have evolved in group discussions, and for that matter are probably not restricted to the group listed above.*

*/s/ J.A.V.H.*

## CHAPTER 3:

### *THE PROJECT BEGINS*

Two weeks after John Van Horn wrote his memo summarizing the status of electric watch research at Hamilton, the Elgin Watch Company issued a press release which confirmed the rumor which had been circulating so pervasively: they intended to produce and market an electric watch. On May 15, 1952, Van Horn formally requested permission to begin intense work on the project. The Board of Directors agreed and at the end of May the assignment was given to Philip E. Biemiller, a physicist in Van Horn's division.

Phil Biemiller was a 29 year-old physicist from Glen Burnie, Maryland. After three years as a bomber pilot in the Pacific during World War II, Biemiller returned to Pennsylvania State University to study physics. He received his degree in 1951 and joined Hamilton a few months later. Biemiller was an ingenious young scientist with a sharp wit and a warm personal style which made him very popular among his colleagues.

Biemiller selected a Master Technician to work with him and Van Horn: James H. Reese. At 43, Reese was the elder member of the team. A native of New Windsor, Maryland, Reese received a degree in accounting but he never used it. Although he had taken few college courses in physics and chemistry, he had a natural talent for science. When Reese first applied to work at Hamilton in 1941 he was turned down. Shortly thereafter he enrolled in a night class taught by Arthur Sinkler, who would later become Hamilton's president. Midway through the course Sinkler told Reese he was wasting his time because he already knew everything Sinkler was

## THE PROJECT BEGINS

teaching. He hired Reese to work in Research and Development.

The three men complemented each other and made a very efficient team. Van Horn guided the general direction of the project, reconciling sometimes conflicting demands of science and management. Biemiller was responsible for the day-to-day development of the concept, while Reese had the rare ability to translate theoretical concepts into working models. (A born inventor, Reese received more patents during his career at Hamilton than any employee in the company's history. In a 1955 report Phil Biemiller said of Reese that "his mechanical skill and ingenuity are incomparable.")

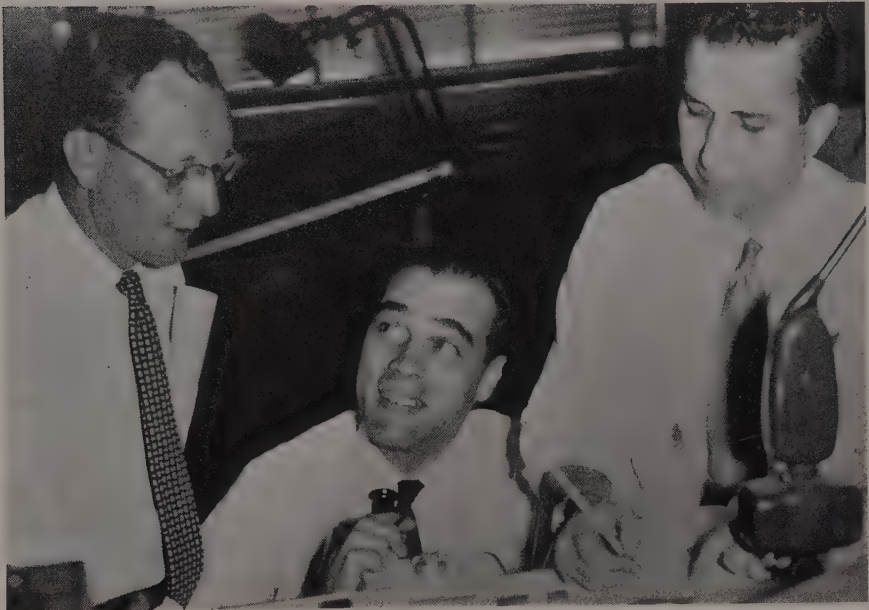

*John A. Van Horn, James H. Reese, and Philip Biemiller: inventors of the Hamilton Electric watch.*

The team started working on the electric watch project on June 10, 1952. For the next nine years, Reese and Biemiller were to do nothing else.

The company established three criteria for an electric watch: it must keep time at least as well as a conventional spring-wound watch; it must be about the same size as a conventional watch; and the battery life must be at least one year.

Biemiller began by making theoretical calculations of the predicted efficiency of the three types of possible movements described in the Van Horn memo. From the outset, however, the men were convinced that the permanent magnet movement with a moving coil was the most promising, and this is where they concentrated their efforts.

### **PERMANENT MAGNET MODEL 1 ("PM-1")**

After completing their preliminary studies they began construction of a working model in July, 1952. In this watch, known as 'Model 1' or 'PM-1', the sides of the movement consisted of two curved magnets made of Alnico 5, a common and powerful magnetic alloy. The center of the movement was entirely taken up by a large balance wheel shaped like a figure-eight, wrapped tightly in fine copper wire to form the coil.

Work progressed slowly. It would take four months until the prototype was ready for electrical testing, and those preliminary results were discouraging. It was not until December that the problems had been resolved to the point that the watch could be fitted with a rudimentary contact system to make a running model. It took another two months to overcome problems in the contact and indexing systems.

On February 25, 1953, the prototype movement was finally fitted in a Hamilton-Illinois "Model A Automatic" case. Since there was no room inside the case the battery was mounted in the strap. Model 1 worked, but it proved to be a very unreliable timekeeper because of magnetic and electrical leaks. Nonetheless, the men were not discouraged and they continued to maintain their faith in the PM watch.



## THE PROJECT BEGINS

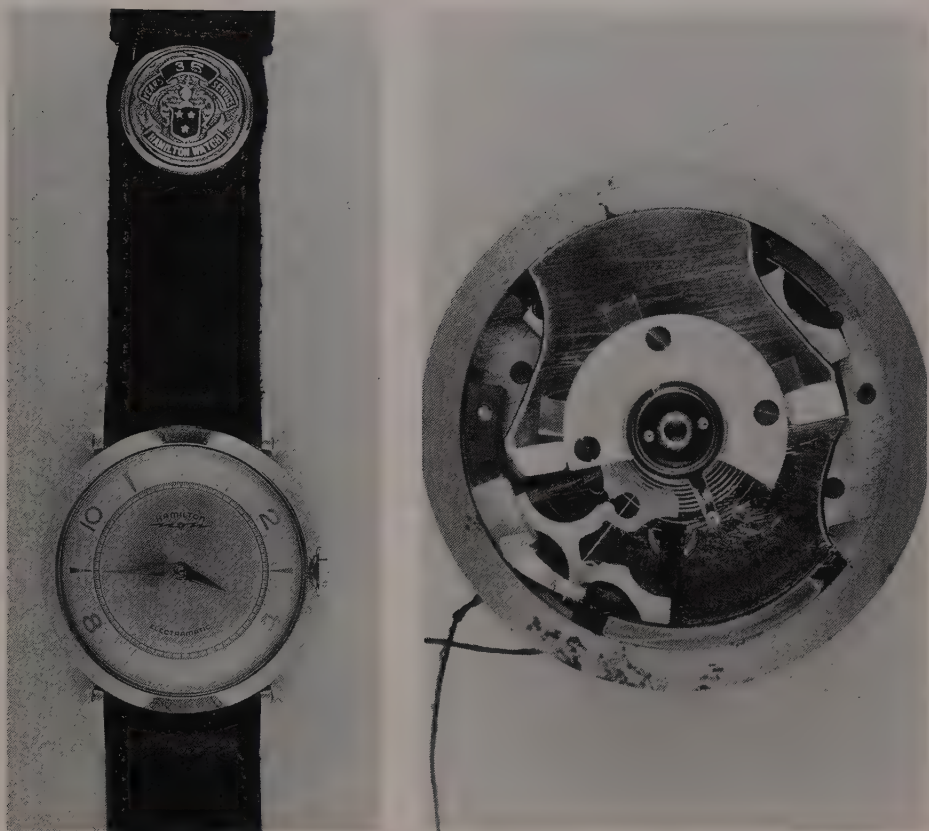

*Permanent Magnet watch, "PM-1" (1952). This was the first prototype with a moving coil, a precursor to the Model 500 and Model 505. Because the magnets took up so much room in the case, the battery was mounted in the strap, hidden by an award medallion. [Factory photos.]*

Management, however, wanted to be certain of the choice before committing their full resources to the project, so other researchers were assigned to study other possible electric movements.

## **VIBRATING REED**

Late in 1952 a project was established to explore the possibility of making an electronic watch which would operate without a balance wheel, using instead a vibrating reed or oscillating crystal to regulate the timekeeping. (This principle would ultimately become the basis for both the Bulova Accutron and the modern quartz crystal watch.) The project ran for eight months, during which time the proposed watch was evaluated on a theoretical level but no working model was produced.

It was decided that such a watch would be too expensive and difficult to make, primarily because of the scarcity of transistors. They had no way of knowing that by the end of the 1950's transistors would be easily obtained and there would be no problem of supply. Management also feared that the jewelers who sold and serviced Hamilton watches would reject a watch which was so radically different from conventional watches, while they would accept a new watch which retained the familiar balance wheel.

In retrospect, it was an unfortunate decision, as Bulova was to prove in 1960 when it launched the "Accutron." As for jewelers' acceptance, Hamilton mishandled that issue anyway, as will be seen later.

## **ELECTROMAGNETIC MODEL 1 ("EM-1")**

Not everyone at Hamilton was convinced that the permanent magnet watch was the correct choice. Researchers within the department were divided, some say bitterly, on the merits of the two technologies: permanent magnetic versus electromagnetic. Many of the scientists felt that the electromagnetic system of the Koehler clock would be best suited for a commercial electric wristwatch, believing that permanent magnets near the balance would be a source of problems for an

## THE PROJECT BEGINS



*Electromagnetic watch, "EM-1" (1952). This unique prototype is based on the 'Koehler clock.' The conventional balance wheel is driven by a fixed electromagnetic coil encircling the movement. The battery is fitted in a hole in the back of the case. Note the jagged arrow on the dial, suggesting electricity; this arrow also appears on the first Koehler clock.*

electric watch and that electromagnets were essential to intensify the magnetic fields obtainable from the crude miniature batteries available at the time. The early difficulties encountered with PM-1 confirmed their belief and added fuel to the controversy.

In October, 1952, Fred Koehler started working on a wristwatch based on his clock movement. To fit in the small Hamilton-Illinois automatic case, the coils were redesigned in a long semi-circle which surrounds the movement, rather than the two barrel-shaped electromagnets used in his clock. The balance wheel was conventional in size, leaving room for the battery to be incorporated into a hole in the case, covered by an insulated metal plate screwed to the back. The prototype was completed on November 15, 1952, a few months before PM-1 was cased, making it the first battery-powered wristwatch ever constructed.

## EVALUATING THE PROTOTYPES

In early 1953 the company assigned an engineer in the Watch Research Division, R.C. Demmy, to evaluate the physical and electrical characteristics of the EM-1 and PM-1 prototypes. Demmy was unaffiliated with either faction and was neutral in the controversy. He was instructed to answer three questions:

1. *What is the energy consumption at various points in the watch, such as the contact system, train, etc.*
2. *What are the critical points which may affect the ease of volume production and to what degree are these points critical?*
3. *What sort of performance can be expected over an extended period under conditions likely to be encountered in widespread public use?*

The evaluation of EM-1 lasted three months. The watch did well in timekeeping tests, despite the fact that it ran at a relatively slow four beats per second, moving the second hand in crisp half-second increments. The chief drawback to the design was its energy consumption, since much of the battery's power was used to energize the coil. This spelled doom for EM-1 for an electric watch, but the results of the test were useful for a separate project to develop a 'cordless clock'. (In a battery-powered clock, power consumption was a less critical consideration due to the larger batteries which could be used.)

In what may have been a political move the EM-1 prototype had been rejected even before the report was completed. In a memo accompanying the final report, research associate John Reber, Jr. acknowledged that "work on this project has been completed with rapidity and for this reason some questions may remain unanswered. In spite of this possibility and in view of the fact that *all emphasis has been*

## THE PROJECT BEGINS

*placed on the development of the PM type watch* [italics added], it is recommended that this project be terminated."

Ironically, four months after the report on the EM-1 had been completed, the Patent Office issued a patent for Koehler's electric watch. The *New York Times* featured the invention in an article headlined "*Inventor of Electric Watch Says Tiny Battery Will Run It 6 Months.*" While that may have seemed an exciting prospect to newspaper readers in 1953, it was not enough for Hamilton's management. The electromagnetic watch was shelved and no further prototypes were made. The controversy, however, was to continue for years.

As for the Permanent Magnet design, Van Horn, Biemiller, and Reese made such rapid progress in their work that by the time PM-1 was being evaluated, they were already constructing their second prototype, known as 'Model 1, Mark 2', or PM-2.

In the lab evaluation tests PM-1 had serious magnetic problems, however it was considered superior to EM-1 on the basis of electrical efficiency. PM-1 ran for nine months before the battery gave out and despite its early problems the design was rated "encouraging to very good." The evaluation project on the PM watch remained open-ended until February, 1955, as work progressed on refined models.

## CHAPTER 4:

### *PROGRESS*

One of the problems plaguing the development of an electric watch was the key element: batteries. The miniature batteries which were available by 1952 made it possible to construct watch-sized prototypes, but these power cells were crude and did not meet the longevity and leak-proof requirements for use in a production watch. In a 1953 report a Hamilton researcher wrote that "the availability of a commercial battery with suitable characteristics for an electric wrist watch may be questioned," to which Research Manager G.E. Shubrooks added a handwritten comment, "Amen!" Even as late as 1955 researchers complained that "the availability of a commercial battery may be a serious drawback to an electric wristwatch."

While early studies of battery requirements were done as a part of the watch development work, in 1953 a separate project was set up. Forty manufacturers of batteries were surveyed but none of the samples submitted were considered suitable, and at the time there were no manufacturers interested in studying such a specialized problem. Consequently, the Chemistry Section was assigned to find a workable solution: either to develop Hamilton's own miniature battery which would meet the specifications of the Physics Section or to procure batteries from a different outside source.

Fortunately, in 1954 the National Carbon Company (later to become Union Carbide) expressed interest, and over the next two years their engineers worked closely with Hamilton scientists to develop a battery with constant voltage, low

drain, and a leak-proof case. The result was a battery which is the grandfather of all watch batteries in use today.

Hamilton enjoyed a good working relationship with National Carbon but remained at their mercy since there were no competing sources of supply. Management decided to prepare a contingency plan to make batteries in Hamilton's own facilities. Engineers believed that they could improve upon the mercury cell which they had developed jointly with National Carbon, allowing for a battery with greater energy capacity which could be produced for a much lower cost: 30 cents per cell as opposed to \$1.00 for the Nation Carbon cell.

Although several patents were issued and test batteries were made, Hamilton discovered that the logistics of producing batteries on its own assembly line were much more complex than creating experimental samples under laboratory conditions. Hamilton's batteries were not commercially viable. Fortunately, volume production of National Carbon cells led to a decrease in cost once the Model 500 was commercially introduced.

*Watch batteries were such a novelty when they appeared commercially in 1957 that Hamilton created special advertising displays to call attention to this exciting invention.*



## THE WATCH OF THE FUTURE

(One curious offshoot of the battery project was highly unusual for Hamilton. In 1957 the company developed a battery-powered toy, the "beating heart." A metal capsule about the diameter of a one-cent coin was designed to make a sound which closely resembled a heartbeat. According to Eugene Barber, Director of Industrial Products at the time, "we took the device to the Ideal Toy Co. in New York and they considered placing the unit in a doll. After testing such a doll they realized that the 'death' of such a doll would result in a traumatic experience for a small child and turned down the idea. We had to agree with them and discontinued our interest in the device.")

### MODEL 1, MARK 2 (PM-2)

Van Horn, Biemiller, and Reese began constructing their second model even before the first prototype was evaluated. Their goal was to reduce energy losses by improving magnetic and electrical efficiency. Timekeeping problems would be solved later. PM-2 resembled PM-1 in many ways, but it

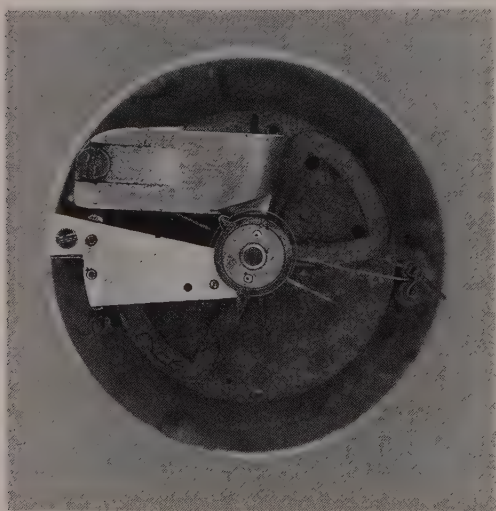

*Model 1, Mark 3. The circular magnet of Mark 1 has been replaced by a U-shaped magnet.*



## PROGRESS

differed in one major detail: the balance was made of epoxy plastic, with the coils cast into the wheel. The electrical improvements were dramatic: energy consumption was reduced by over two-thirds. However, timekeeping problems were even greater than in the first model because the plastic balance wheel was affected by atmospheric humidity. On dry days the watch would run fast, on damp days it would be slow.

Two more variations were produced, Mark 3 and Mark 4. These models used a U-shaped magnet to concentrate the magnetic force. Mark 4, the last of this design, used a balance



*The cases for Mark 3 (left) and Mark 2 (right) illustrate the efforts taken to fit the battery into the case rather than the strap. The case back was deepened to accommodate the battery in Mark 2, making an extremely bulky case when seen from the side.*

wheel with a single coil. Thanks to the use of finer coil wire they were able to use as many turns of wire in one coil as the

## THE WATCH OF THE FUTURE

first plastic wheel had used in both coils. This reduced energy consumption even further, to nearly one-tenth of the power required by PM-1. This was an exciting breakthrough, for it would allow them to use a smaller balance wheel, releasing space in the case to hold the battery. Timekeeping, however, remained a problem.

### MODEL 2

In September, 1953 a completely new movement was designed, the Model 2. It represented a significant advance toward the production model. Instead of the circular or U-shaped magnets of the Model 1 prototypes, two flat magnets, one curved and one straight, were fitted into the pillar plate. A small plastic balance wheel with a single coil and an anti-magnetic hairspring were used. Like the PM-1, the watches were fitted in gold-filled Hamilton-Illinois cases with a special dial emblazoned with a red "lightning bolt" symbol.

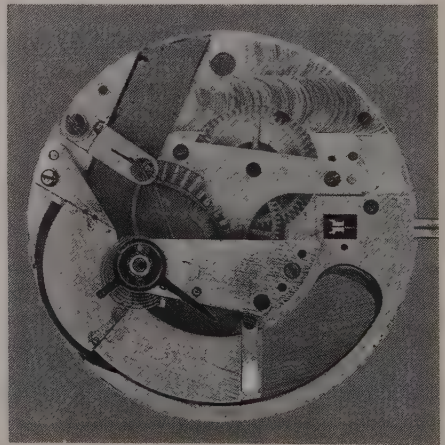

*Model 2 'wear test' prototype. The dial is imprinted with a red lightning bolt, like that on Model 1. The movement has a cast epoxy balance wheel and flat magnets in the pillar plate.*

## PROGRESS

Plans called for 25 test watches to be assembled and used for wear-tests. Ultimately, 23 were completed. The first was finished on December 5, 1953, and by the end of the month ten watches were delivered to Hamilton's executive vice-president (soon to become president) Arthur Sinkler, for distribution to the Board of Directors. One watch, serial number 1, was cased in 14K gold for presentation to president George Luckey, who had started the electric watch program seven years earlier.

*Model 2 prototype, serial number 1, cased in 14K gold. This watch was issued to Hamilton's president, George Luckey. The lightning bolt emblem is positioned in the lower part of the dial.*



Samples of the watch were also furnished to R.V. Hartman, head of the Product Performance division, and Richard Slaugh, Head Watchmaker, for their personal evaluations. This put the men in an awkward position as any criticism might be construed to be politically motivated negativism. Consequently, both men went out of their way to preface their critiques with conciliatory comments. Hartman wrote that his criticisms "are presented solely in the spirit of cooperation" and expressed enthusiasm for the concept. He urged that "we lose no time in being first on the market with it, regardless of whether the first model represents our ultimate conception in design." Dick Slaugh noted that "the criticisms should be taken in the spirit in which they were asked for *and* given. If

## THE WATCH OF THE FUTURE



*Hamilton's directors compare their Model 2 electric watches to a Hamilton pocket watch at a formal dinner in January 1954. President George Luckey (standing, left) is wearing his gold prototype. The president-to-be, Arthur Sinkler, is standing at the right.*

seemingly harsh, they are not meant to 'kill' the watch but to help make a better one."

Most of their observations were technical in nature, but Hartman made one suggestion which was enthusiastically received and may have been the impetus behind the release of the "Ventura" three years later. He mentioned that he wore one of the electric watches to a meeting of the New Jersey State Watchmakers Association and was disappointed by the lack of response from other watchmakers. "Not being privileged to see the movement, their evaluation was based solely upon external appearance and there is nothing distinctive about that.

I would think, since Pride of Ownership is a powerful sales factor, the electric watch needs something in its external appearance to set it apart from the conventional watch. When a customer buys an electric watch he'll want everyone who sees it to be aware that it's electric." John Van Horn, to whom the memo had been directed, made a marginal note at this point in the report: "RIGHT!"

Although most of the watches operated fairly reliably for the short duration of the wear test, many problems were revealed. The pivots on the non-magnetic stainless steel balance staff showed inordinate wear in a very brief time, the indexing system sometimes malfunctioned, and the contact system wore rapidly. Like PM-2, humidity variations affected the smaller plastic balance wheel. The watch could not be considered commercially viable until these problems were corrected. Van Horn and his team had a lot of work to do.

Early in 1954 the Research & Development Department was restructured. One of the changes was the creation of a new and more powerful position, Director of Research, to replace the former position of Manager. The previous manager, G.E. Shubrooks, was transferred, and Dr. John Van Horn was promoted to the new position of Director. This further strengthened his authority and virtually guaranteed that the permanent magnet electric watch project would be carried through all the development steps to production and sale. Phil Biemiller took over Van Horn's previous position, Chief Physicist.

Although the added responsibilities interfered with Van Horn's day-to-day participation in the electric watch project, he remained deeply involved. There was no major change in procedure since Phil Biemiller and Jim Reese had been the principal engineers since the beginning.

By April, 1954, Biemiller and Reese gave up on trying to develop a wear resistant non-magnetic balance staff. They concluded that the only solution would be to eliminate magnetic leakage near the balance so that a conventional metal

## THE WATCH OF THE FUTURE

staff could be used. For the next few months they experimented with different magnetic materials and various configurations, but it was not until November that they found the solution. In Hamilton's lab, metallurgist Marlin Walmer produced a magnetic alloy consisting of 77% platinum and 23% cobalt, which allowed for magnets which were smaller yet significantly more powerful. The reduced dimensions permitted the magnetic field to be concentrated directly below the coil, with little or no magnetic leakage to the rest of the movement, so a conventional carbon steel balance staff could be used.

Late in 1954 Jim Reese adapted one of the existing Model 2 movements by removing the flat magnets and gluing two of the new cylindrical magnets into the pillar plate. He also replaced the balance with a new design which used no epoxy resin. This transitional prototype yielded excellent results. The Model 500 had been born.



*Model 2 transitional prototype. The flat magnets have been replaced by cobalt-platinum plugs. In the picture on the right the shunt bridge and balance wheel have been removed to show the cylindrical magnets glued into the pillar plate. This is the first prototype of what would become the Model 500.*

## CHAPTER 5:

### *MODEL 500*

The year 1955 was devoted to refining all of the elements of the latest model, which was designated Model 500. In April they suffered a serious setback when it was discovered that General Electric held a patent for heat-treating cobalt-platinum magnets. Negotiations for a licensing agreement were started, but it became clear that the royalties would run up the cost prohibitively.

Van Horn, Biemiller, and Reese went back to studying other possible magnetic materials, while researchers in Hamilton's metallurgy lab tried to find another way to produce a

*This hand-tooled prototype, serial number 4, was one of the first laboratory models of the Model 500.*

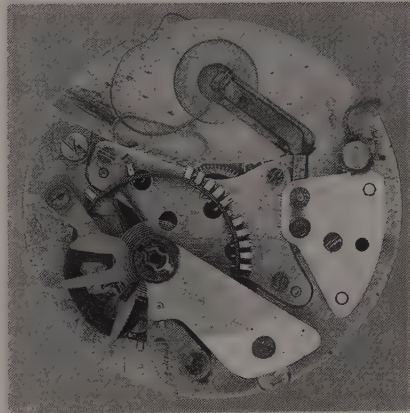

cobalt-platinum magnet. Fortunately, in early June Marlin Walmer successfully developed a process for manufacturing magnets which would not infringe on the GE patent. (Walmer later went on to establish a highly successful company of his own, manufacturing magnets for industrial uses.)

## THE WATCH OF THE FUTURE

Work on a new contact system continued, and the plastic wheel of the Model 2 was replaced with a metal wheel and an improved coil. By the end of the year, following months of laboratory experimentation, the Model 500 was ready to be submitted to wear tests to evaluate their reliability outside of the laboratory.

A test program was launched in January, 1956 to assemble and test 1,000 Model 500 prototypes. Approximately



*Wear-test prototypes (1956). The example on the left was issued to selected employees, who were instructed not to open the case. Managers and directors were privileged to wear watches with display backs. The "17 Jewel" engraving designates the early prototypes with double wheel index system. Note the strap clamp to hold the battery in position.*



three hundred were initially made, of which 160 were distributed to Hamilton personnel for wear tests while the remainder were kept in the laboratory. A few of the prototypes were made with clear backs to display the movement; they were given to officers, directors, and researchers. Other personnel received watches which were sealed and engraved "Do Not Open, Property of the Hamilton Watch Company." All of the wear-test prototypes were fitted into gold-filled "Titan" cases.

Division leaders who distributed the prototypes to their sections were asked to "remind everyone that although the existence of a Hamilton electric watch is not a secret, specific information regarding construction is classified as company confidential."

Each employee was given an instruction sheet to sign which specified the rules of the test program:

*With this form you are being issued a Model 500 electric watch on temporary loan, subject to return on request. It is understood that the watch will remain the property of the Hamilton Watch Company. This new type of watch is being tested to determine its performance characteristics. It must be understood that you will adhere to the following rules while the watch is in your possession.*

- 1. You will wear the watch every day at the factory so that rates can be taken.*
- 2. You will not lend it to anyone.*
- 3. You will handle the watch as though you had purchased it from some jewelry store and you may request that the watch be regulated, if necessary, during the first month you wear it.*
- 4. You will report every accident involving this watch such as dropping, wetting, etc. however unimportant it may seem to you.*

## THE WATCH OF THE FUTURE

5. *YOU WILL NOT, UNDER ANY CIRCUMSTANCES, OPEN THE CASE.*

6. *You will not set the watch unless requested to do so.*

7. *Should the watch stop, you will notify E.K. Prugh or P.E. Biemiller, extension 363, immediately.*

8. *You will return the watch if you are to be separated from the local plant for an extended period.*

*It cannot be impressed too strongly that these are experimental watches and reliable data must be accumulated before the watch can be produced for public use.*

By the end of the month, 43% of the wear test watches and 26% of the rack test watches had stopped. In mid-February Hamilton's president, Art Sinkler, scratched an angry note on the latest performance report he had received: "the only encouraging thing in this report is the slight improvement in failures during the second part of the test. Surely, dependability is the most important feature in the modern watch. These are still far from dependable."

Most of the problems were traced to the index system. The mechanical detent on the index wheels was subject to



*Some of the rebuilt prototypes with the magnetic index system were re-engraved "12 Jewels."*

## MODEL 500

friction and rapid wear. A new system was devised, which used a magnet to hold the position of a single index wheel between impulses. Not only did this solve the friction problem but it also eliminated eleven parts, including five jewels. A third of the test watches were rebuilt and an additional lot was made with the new magnetic indexing system.

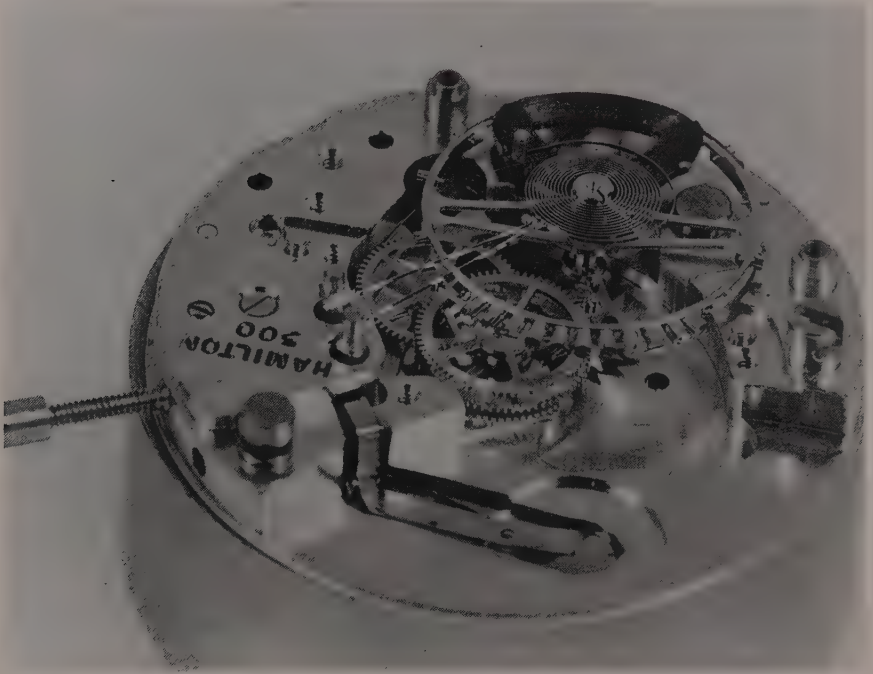

*This factory photo shows the new magnetic index movement with the balance and train bridges removed. The "Jewel" engraving was eliminated. Later models were marked "Pat. Pending."*

The failure rate of the new test watches dropped to 10% in the first month. Biemiller optimistically felt that if the movements could be run for one week before casing and one week after, mass produced Model 500 watches should have a failure rate no greater than any conventional watch.

Hamilton was eager to be the first to market an electric watch, but the more time passed the more likely it was that a

competitor might beat them to the punch. It had been four years since Hamilton began the project in earnest, prompted by news of Elgin's intentions, and there was every reason to believe that Elgin or someone else would soon have a marketable watch. Of course, they had no way of knowing that it would be another four years before another watch would appear. As soon as the Model 500 began to appear workable, management was ready to get the watch on the market whether or not it was perfected.

When Van Horn innocently asked the sales department which priority they considered most important – reducing size, cutting costs, or improving battery performance – Arthur Sinkler intervened and expressed his own impatience. "I do not understand why we cannot do all of them at the same time. Projects of lesser importance can be temporarily abandoned if necessary. If we're ever to get the electric watch on the market this attitude cannot be tolerated!"

Van Horn, Biemiller, and Reese all knew that the watch was still an unrefined prototype which was still not ready for release, but in the summer of 1956 they found themselves under tremendous pressure to gear up for commercial production. The company formed an "Electric Watch Marketing Committee" and very soon the scientists found themselves trapped by the marketing momentum that was building. Regardless of their personal misgivings they were forced to stop development work and instead adapt to the demands of the committee, searching for quick fixes to remaining problems.

On August 30, 1956, Van Horn sent the Electric Watch Marketing Committee a summary of the Model 500 in which he gave them what they were pushing so hard to get. He declared that "it is a consumer product ready for sale," despite the fact that the balance wheel still had a tendency to overbank and the new magnetic detent had not been fully proven in long-term tests.

He set a timetable for production, calculating that 3,000 watches could be available to jewelers by December 15th.

MODEL 500

However, from a marketing standpoint that was too close to Christmas to be practical so the Board elected to hold back the introduction of their new watch until right after the holiday season. The company would eventually pay a high price for its haste.



*The 1955 laboratory models [left] had a special dial with lightning bolts passing through the markers. Twenty-five of these experimental watches were made. The wear-test models issued in 1956 were fitted with the same dial later used for the "Titan," except that there is no "Electric" marking [right].*

## CHAPTER 6:

### *PRESS CONFERENCE*

To announce the world's first electric wristwatch Hamilton staged an elaborate press conference at the Savoy Plaza Hotel in New York. On January 3, 1957, over 120 reporters showed up for a luncheon and lecture, heavy on fanfare and hyperbole, to hear about this new wonder of the age.

Hamilton's public relations wizards set the objective of the press conference: "get the press media in, feed them, tell them our story, and get them out as quickly as possible." John Van Horn, Philip Biemiller, and James Reese were all on hand to discuss their new invention.

In the next few days the press release issued at the conference would be published in one form or another in over 500 newspapers and magazines across the United States:

*HAMILTON UNVEILS WORLD'S FIRST  
ELECTRIC WATCH, FIRST BASIC CHANGE  
IN PORTABLE TIMEKEEPING IN 477 YEARS.*

*A new era in timekeeping was ushered in today (Thurs., January 3, 1957) with the introduction of the world's first electric wristwatch, perfected after ten years of research, development, and testing by the Hamilton Watch Company of Lancaster, Pa.*

*No larger than a conventional wristwatch, the electric watch offers the highest accuracy and dependability ever achieved, and incorporates the first basic change in watch construction in almost*

## PRESS CONFERENCE

five centuries, according to Arthur B. Sinkler, Hamilton president.

Unveiled at a New York press showing, the watch will be available to consumers sometime this month in limited quantities. The first model, cased in 14 karat gold, retails for \$175. A gold-filled model, at \$89.50, will be available soon. (Both prices include federal tax.)

The radical structure of the electric watch completely eliminates the mainspring, an integral part of portable timekeeping devices since their invention in 1480 by Peter Henlein of Nuremberg, Germany. The new watch is the only one in existence which runs with winding or without periodic agitation, Sinkler added.

"The watch movement," he pointed out, "is so exquisitely engineered that a tiny Energizer the size of a small shirt button will run it for a minimum of twelve months. In fact, Hamilton's electric watch would run for more than 20 years on energy that would operate a 100-watt bulb for no longer than one minute."

Sinkler called the electric watch a "milestone in Hamilton's program of research and expansion," and predicted it would in time completely replace present-day automatic watches.

"Instruments used in American industry are becoming more and more complex. This necessitates, on an ever increasing scale, the successful combining of miniaturized mechanical, electronic and electric mechanisms," he continued. "Because of this a new technical civilization is being developed and Hamilton's Electric Watch with its miniaturized electric power plant and timekeeping assembly is a major step in opening the frontiers of this new era."

## THE WATCH OF THE FUTURE

*"The electric watch," he added, "also has profound implications for our national defense, with miniature timing devices so vital to modern weapons of war."*

*The electric watch operates on chemical energy stored in a tiny Energizer, according to Dr. John Van Horn, Hamilton's director of research and development. This energy is converted into electrical power as it releases a stream of electrons through a coil of fine wire fixed on a balance wheel. The electrical energy through interaction with permanent magnetic fields causes the balance wheel to oscillate. This oscillation is the mechanical energy which runs the watch.*

*"Hamilton presently has more than 35 patents pending on this operation," he added.*

*"The overall result is a precise miniature power plant built into the balance wheel, which in turn powers the gears and turns the hands of the watch. In the past, the balance wheel only controlled the power furnished by a mainspring. In the electric watch, it furnishes its own power as well as controls it," Dr. Van Horn pointed out.*

*"The essential difference between our motor and the conventional electric motor is that the power plant, combined with a balance wheel, permits the flow of energy to be strictly controlled and the speed of the hands to be held to an accuracy of more than 99.995 percent," Dr. Van Horn emphasized. "Combined with simplified construction and built-in shock resistance, the motor provides incredibly long life for the watch."*

*The coil is made of wire five times finer than human hair. Enough of this wire for 1000 watches would weigh only two ounces but would stretch from Dover all the way across the English*



## PRESS CONFERENCE

*Channel and well into France.*

*The tiny magnets used in the electrical system are of platinum alloy and have the highest energy content of any magnet in the world today. They were processed by Hamilton expressly for use in the electric watch.*

*The Hamilton electric watch is more nearly free from disturbance by stray magnetic fields than any other watch, according to Dr. Van Horn. "The television service man, a physician with an electrocardiograph or any of the increasing number of people who work with or around magnets will be able to wear this watch with no interference," he stated.*

*Dr. Van Horn reported that Hamilton researchers and engineers worked closely with the National Carbon Company to develop a power unit which would release its energy in the most frugal fashion possible to accommodate the "fraction of flea-power" needed by the delicate mechanism.*

*The resulting gold-plated Energizer is designed for long life and minimal power. It is 400 times more efficient, in terms of space, than the mechanical energy stored in a mainspring, and does an incredible amount of work for its size, he pointed out.*

*"For example," said Dr. Van Horn, "in the course of one year it must open and close the circuit 75 million times. The second hand must be pushed forward 75 million times and the balance wheel must oscillate 150 million times."*

*The electric watch is more accurate and dependable and has about one-third fewer parts than the automatic watch which has gained great popularity in recent years, he added. "Tests show that the day-to-day accuracy of these new electric*

## THE WATCH OF THE FUTURE

watches is far greater than that of automatic or manually-wound watches," he continued.

Before the electric watch, so-called automatic timepieces were dependent upon the wearer as a part of the power system, Dr. Van Horn explained. Power was furnished by agitating the whole watch instead of turning the stem. Hamilton's electric watch is truly automatic -- does not have to be worn regularly or agitated at any time to function properly.

Also, he said that the electric watch is less complex than the old automatic because there is no winding mechanism or mainspring. The result is a simpler and more efficient operation.

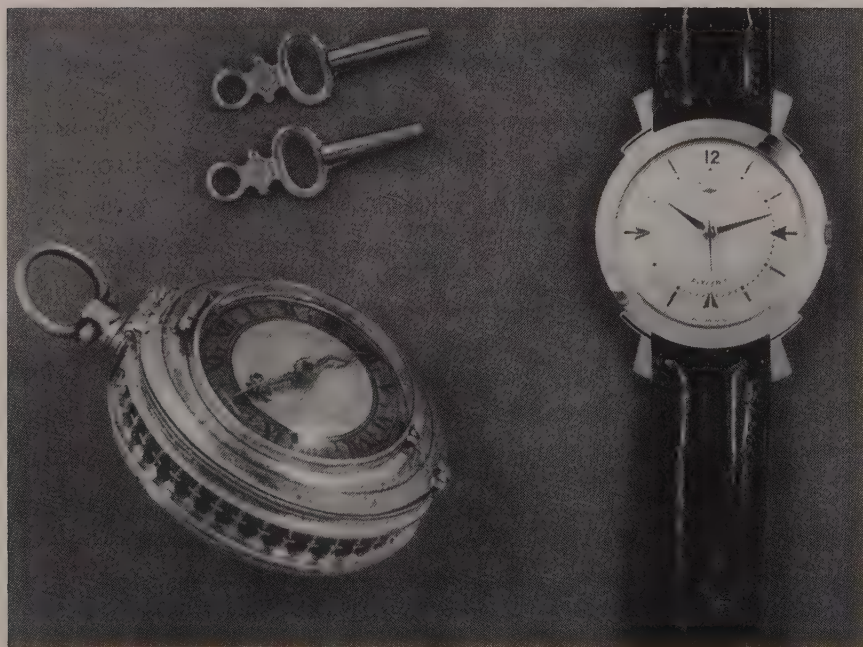

*Peter Henlein's so-called "Nuremberg Egg," compared with the new Hamilton Electric ("Van Horn" model). This photo was used in Hamilton's publicity to highlight the claim that the electric watch was the first major change in 500 years.*

## PRESS CONFERENCE

Following the luncheon and the distribution of the press releases, Arthur Sinkler opened the press conference with a few remarks, then introduced John Van Horn, who gave a 15 minute presentation with the aid of slides and a short film. Van Horn elaborated on the points which had been so carefully laid out by Hamilton's press agents. To emphasize the dramatic new technology represented by the electric watch, the alleged "Nuremberg Egg" of 1480 was often referenced. As a slide of this apocryphal watch appeared on the screen, Van

*Durward Kirby displays the new Hamilton Electric wristwatch to television viewers on the "Garry Moore Show" in 1957.*



Horn intoned that "basically, these are pictures of the watch until today, because from 1480 until January 3, 1957, the basic method of telling time by a portable timepiece has remained unaltered. It has been refined but there has been no change in concept from that of Peter Henlein's egg – whether key wound, stem wound, or so-called automatic... The last major improvement on the mechanical principle contained in the Nuremberg Egg was made in 1750."

## THE WATCH OF THE FUTURE

He described the electric watch as a miniature DC motor which kept time, and went on to say that "combining a balance wheel with an electric motor appears to be a simple solution. It is, except for the details. [Slide of automobile parts is shown.] An automobile is a simple mechanism too. It consists of an engine, steering wheel, and four other wheels. In addition there are some other details."

The presentation and Van Horn's speech were very effective and had the impact the company had hoped for. The reporters went back to their offices and filed stories which flooded the press over the next week. All three television networks, most leading magazines and virtually all of the nation's top newspapers featured the 'watch of the future.' In the context of the times the electric watch really was big news, something which fit in perfectly with the nation's obsession with the future.

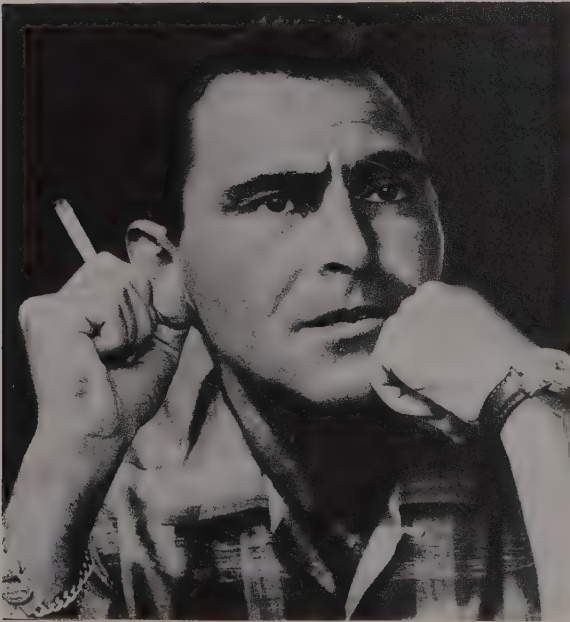

*Author Rod Serling was captivated by the futuristic Hamilton Electric. He can be seen wearing his "Ventura" on early episodes of "The Twilight Zone." Elvis Presley was another celebrity fan of the "Ventura," which he wore during filming of the movie "Blue Hawaii."*

## *PRESS CONFERENCE*

It is not hard to understand how easily such an invention captured the imagination of 1950's consumers. Forgetting all we know of the present and reading the press release with an open mind, the electric watch really does sound like an almost magical invention.

One news report quoted Jim Reese, discussing the future of the electric watch. "Certainly there will be changes – let's say refinements – in the electric watch from time to time. Take the automobile, for instance. Basically, its operation is the same as it was in the early years, but the industry has refined the product." Dr. Van Horn interjected with a smile, "we're not predicting just when we'll put fins on the fenders, however."

The irony, of course, is that Hamilton had already put fins on the fenders – in a very literal sense – on the newly released "Ventura."

## CHAPTER 7:

### *STYLING AND ADVERTISING*

Prior to World War II Hamilton had created some of the most interesting and attractive watches in the industry, but by the 1950's its styling had become dull and repetitive, reflecting the conservative nature of the company itself. "Our styling – a matter of great importance in the jewelry industry – had a pronounced tendency to appeal to those over sixty," admitted John Van Horn. Given that most objects in the 1950's had taken on a distinctly futuristic look it is surprising that watch design throughout the trade was so stodgy. Cars, furniture, appliances, architecture, and even jukeboxes were influenced by the national fascination with rockets, space travel, and the future, yet the watches produced by the major manufacturers were generally simple, round, and uninspired. For its part, Hamilton still relied on the tired, out-dated marketing concept of "the watch of railroad accuracy."

As they prepared to market the world's first truly new watch in centuries, Hamilton knew that the novelty of the technology would guarantee initial public and press interest in the "watch of the future," but to insure that this new invention would be discussed and noticed for a long time to come, something more was needed. So, to emphasize the unconventional nature of the watch, Hamilton went for shock effect.

If the watch industry had been attuned to national trends they might have been able to envision what was to follow, but no one was prepared. As John Van Horn explained a few years later, "the first two watches to appear were at two ends of the styling spectrum. One was a simple round watch, intended to sell. The other was shield-shaped, intended to

attract attention. The only man with any confidence in it was the stylist [actually Steve Fedor, the Director of Marketing], and while he defended his position by accepting bets that the total sale would exceed some small number, even he was surprised when the shield outsold any solid gold case which we had ever offered." The 'shield' referred to by Van Horn was the "Ventura," the first in a series of remarkably bold designs which Hamilton would produce over the next few years.

*Richard Arbib, the designer who styled the unique cases which are so popular with today's collectors.*



One man was not surprised: Richard Arbib, the designer who created the "Ventura." Arbib had been lobbying Hamilton's management for nearly five years to take a more daring approach to watch design.

At the time, Richard Arbib was the head of a design consulting firm in New York which did contract work for a diverse range of clients, including GM, American Motors, Swank men's accessories, and Century boats. A graduate of Pratt Institute, Arbib had worked in the styling division of

## THE WATCH OF THE FUTURE

General Motors before all production ceased at the onset of World War II. For the duration of the war he designed armaments for Republic Aviation, but he returned to Detroit as soon as automobile production resumed. In 1949 he moved to New York and founded his own design business. Arbib had a particular fascination with watch design, so he began soliciting work from case manufacturers.

American watchmakers had traditionally purchased watch cases from outside sources. Hamilton had a casemaking subsidiary, Ralph W. Biggs Co. in Stamford, Connecticut, but the company continued to purchase most of its cases from several other firms. Since most watchmakers were concerned more with mechanics than style the case companies often proposed new designs to the companies. Through contacts at the case manufacturers, Richard Arbib was retained directly by Hamilton in the early 1950's.

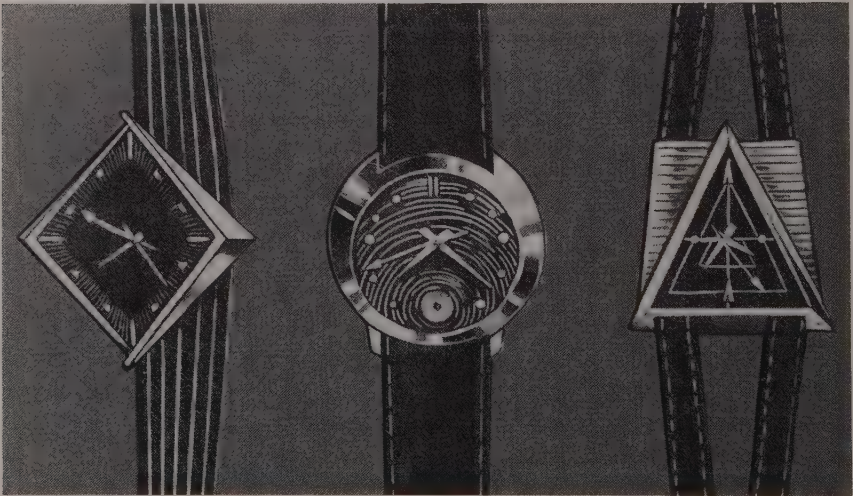

*Design concepts created by Richard Arbib for the Hamilton Electric.*

Arbib felt that most watch styling was unimaginative. He believed that watches should be completely coordinated, with the dial, case, strap and crystal all harmonizing into a bold



yet pleasing whole. In keeping with Arbib's original design, the first "Ventura" was produced with a gold and black strap which complemented the color and shape of the case. Hamilton soon abandoned these coordinated leather straps, though in succeeding years many electric watches were offered with matching metal bands. The best example of this coordinated styling was the "Vega," on which the cross-hatched pattern on the band is carried through the lugs and across the dial. It is a classic example of Arbib's styling philosophy.

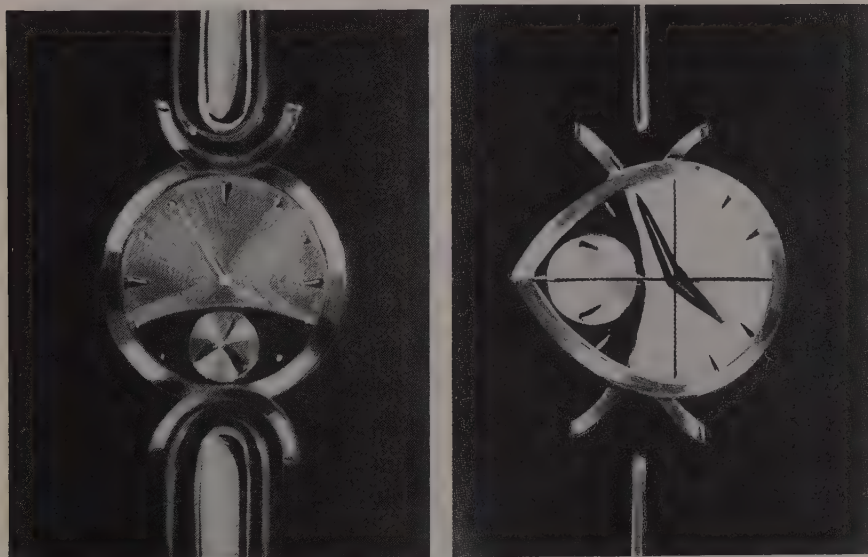

*Two dramatic drawings created by Arbib but never produced by Hamilton.*

The development process normally took about six months, and the final appearance of the watch was sometimes very different from the original drawing because so many people had a say in the process. Hamilton's Director of Merchandising made initial selections from the proposed drawings. In the Styling Division Bettye Miller reviewed, and if necessary, reworked each design before passing it on to the model maker. Depending on the modeler's skill a watch might

## THE WATCH OF THE FUTURE

end up looking better or worse than the original drawings. It was finally referred to the casemakers who sometimes had to adapt the model in order to make workable dies to produce the actual cases. The final determination, of course, came from the Marketing Committee and Hamilton's president, Arthur Sinkler.



*Prototype watches from Hamilton's design department, based on Arbib's designs. This model never reached production.*

The "Ventura" case was manufactured by Schwab & Wuischpard (S&W), who produced many cases for Hamilton over the years. The conventional watch introduced at the same

STYLING AND ADVERTISING

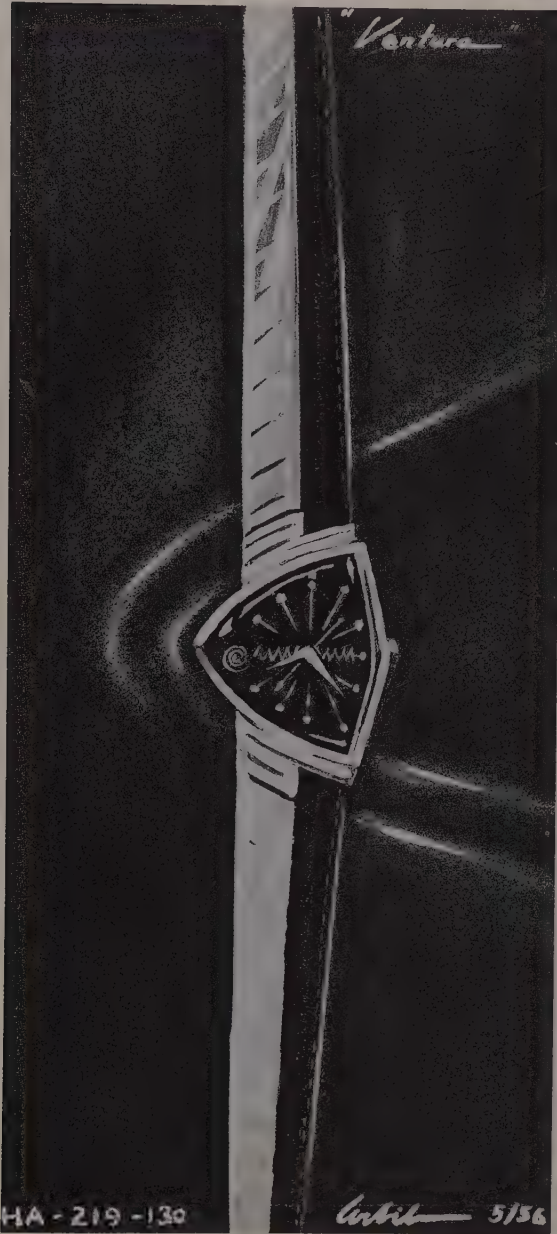

Original rendering of the "Ventura" by Richard Arbib.

## THE WATCH OF THE FUTURE

time as the "Ventura" was the "Van Horn," named in honor of John Van Horn. A gold-filled version, dubbed the "Titan," was released a few months later. (This design had been created in 1955 and was used for the wear-test prototypes made in 1956.) S&W and Biggs made many of the early Electric cases but by the 1960's most were being manufactured by the Star Watch



*The "Ventura" with its original two-tone gold and black strap.*

Case Company. One very rare model, the "Altair," was made by the obscure case company, Jonell.

Each design was named by Arbib but Hamilton sometimes changed the model names. For example, the third watch

released in the Electric series, the "Spectra," was originally called the "Scimitar," a name obviously reflecting the unique curves on the sides of the case.

Because of the overwhelming success of the "Ventura," Hamilton was prompted to produce other uniquely styled watches. This avant-garde styling became a hallmark of the Hamilton Electric watch, at least for the first few years. Richard Arbib produced hundreds of design sketches for Hamilton, but the association was terminated in 1960. Afterwards, Hamilton released several other interesting watches from Arbib's earlier sketches, but in the mid-1960's the company reverted to its earlier conservatism and most of the new models were round and relatively plain.

## ADVERTISING

Hamilton backed up its public relations promotion with an aggressive advertising campaign. Full color, full page ads appeared in all of the major magazines and the airwaves were blanketed with radio advertisements featuring discordant (presumably 'modernistic') music and an announcer intoning "the name is Hamilton, the watch is electric," and "it's the perfect gift for the man who looks to the future!" A variety of displays and point-of-sale material was developed for retail jewelers. One piece served a dual purpose: the company made small plexiglass displays housing a working Model 500 movement. It was a striking promotional piece, allowing the customer to actually see the new electric watch in operation. It also served as a spare movement for the jeweler to use in case he needed to send a customer's watch to the factory for repair.

The early advertisements for the Hamilton Electric were as dramatic as the watches themselves, full of bright colors and futuristic swirling patterns which suggested planets in orbit. Today, jaded as we are by computer graphics, it is hard to

## THE WATCH OF THE FUTURE



Everything about the Hamilton Electric Watch makes history. Sense, too. It's the first watch to require no winding—hand or automatic. A single miniature energy cell does all the work. Even Hamilton has never made a more accurate watch. It needs less care than any you've ever owned. It's shock-resistant, anti-magnetic. Your Hamilton jeweler will tell you more. A. VENTURA I. 14k gold. \$200. B. TITAN. 10k gold-filled, waterproof\*, \$89.50. (Van Horn. Masterpiece series, 14k gold. \$175.) Hamilton Watch Company, Lancaster, Pa.

\* PROVIDED ORIGINAL SEAL IS RESTORED IF OPENED FOR SERVICE  
PATENTS PENDING

# HAMILTON

the watch jewelers recommend more often than any other

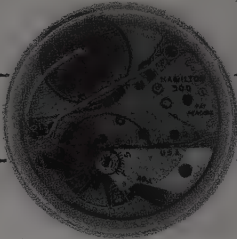

**HAMILTON**

no winding		anti-magnetic
fewer parts		fully-adjusted
amazingly accurate		shock-resistant

*fully guaranteed*

**THE WORLD'S FIRST** *Electric Watch*

*Electric watch "demonstrator unit" made to display the new electric movement. Offered to jewelers at \$32.50, the movement could be used for emergency repairs.*

imagine how striking these ads looked at the time. But, just as the watches became more conservative over the next few years, Hamilton's later advertising also became more mainstream, if not antiquated in tone.

The longest running promotion for the Hamilton Electric was not, strictly speaking, an advertisement at all. However, it has been seen by millions of people and endures even to the present day. In 1958 the Smithsonian Institution accepted a specially prepared exhibit, displaying four prototypes (PM-1, PM-2, Model 2 and an early Model 500) along with a new "Ventura." The most striking part of the exhibit is a large plexiglass model of the electric movement, showing all the

## THE WATCH OF THE FUTURE

movement parts and how they work. It was originally constructed as a fully functional, operating model. This museum display can still be seen by visitors to the Smithsonian Museum of American History. The descriptive text accompanying the exhibit has not changed in thirty-five years; while the electric watch was state-of-the-art in the 1950's, today these descriptions are dated, and even quaint.

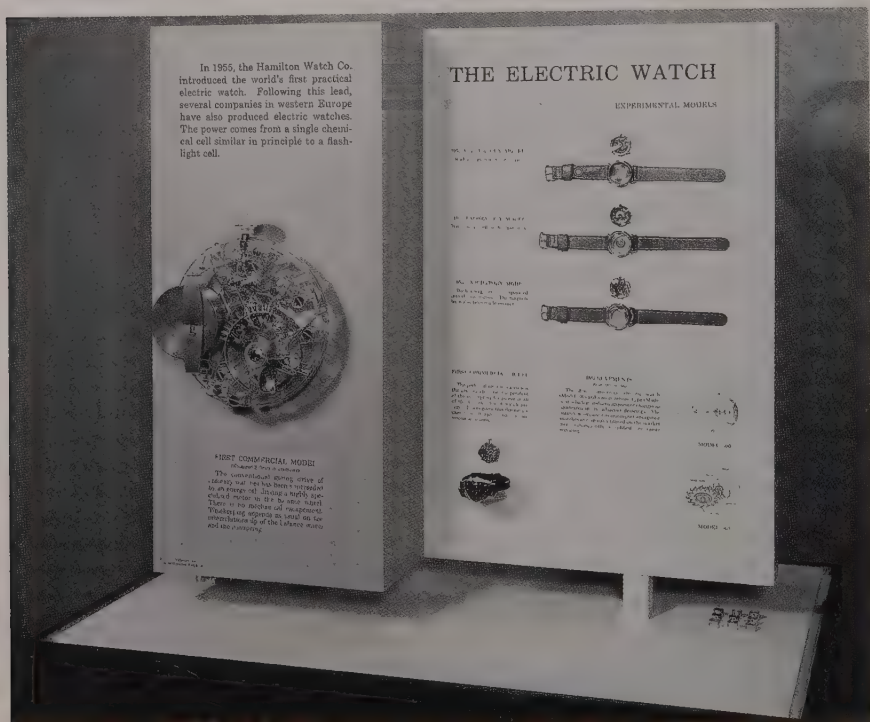

*Hamilton Electric display at the Smithsonian Institution in Washington, D.C. [Courtesy National Museum of American History, Smithsonian Institution.]*

However, when it was first released it would have been difficult to avoid seeing or hearing about the Hamilton Electric watch. The watch of the future had arrived, but Hamilton's crystal ball failed to reveal how rocky the future of the electric watch would be.



## CHAPTER 8:

### *PROBLEMS AND COMPETITION*

While Hamilton's management basked in the glory of international publicity they prepared to deal with the inevitable bugs which were inherent (and expected) in such a new and relatively untested product. However, even before the watches hit the shelves they found themselves overwhelmed by the magnitude of the unforeseen problems which developed.

Some of the problems were minor mechanical defects which had not surfaced during wear tests because the hand-made laboratory models were finished with a greater degree of precision than those produced on the assembly line. Despite

*Promotional key ring with Model 500 contacts and battery imbedded in plastic.*



a year of tests, researchers were also unprepared for the extent of failures in the contact system in the production model. Wit-

## THE WATCH OF THE FUTURE

hin the first six months 5% of the watches sold were returned for that reason alone.

Even very slight corrosion or contamination of the delicate contact points would case the watch to stop. The possible causes of contamination were everywhere, since virtually everything exuded potentially damaging gasses – oil, gaskets, the battery, even plastic crystals. In the first few months of 1957 Hamilton's chemists studied every aspect of the watch, including case materials and processing, dial finishes, and hands in an attempt to solve the gassing problem.

Production-related problems developed as well. The contact system proved to be so delicate and difficult to manufacture that the factory ran up \$121,000 in excess production costs in the first year. Also, foremen and assembly-line workers did not fully understand that the tolerances for electric watch parts were more critical than for the same parts made for mechanical watches. This led to a variety of minor disasters



*The first shipment of Model 500 Electric watches leaves the Hamilton factory in a Railway Express truck in 1957. [Photo courtesy Eugene Barber.]*

## *PROBLEMS AND COMPETITION*

when experienced foremen took accustomed liberties in production.

Winding the coil was also a major source of trouble. The Model 500 coil contains 2,200 turns of copper wire measuring fully 121 feet in length but only six ten-thousandths of an inch in diameter. The tolerances of the coil were critical, as any deviation would alter its electrical inductance. The spoilage rate in coil manufacture reached as high as 80% in the first months. Correcting these problems required a significant expense in time, education, and money.

Unfortunately, the most serious problem was not in production, where it could be controlled, but in marketing, where the effects proved permanently damaging. In the rush to be first in the market, Hamilton did not have time to establish a service training program for the jewelers and watchmakers in the field. So, as John Van Horn later explained, "we put our little heads together and came up with a solution which, in retrospect, could not have been worse. We told our customer, the jeweler, and his customer, the consumer, that any defects would be handled at the factory until jeweler education had been possible."

"We completely ignored the fact, which we knew, that our jewelers are predominantly ethical and competent men with pride in their ability and with a sense of responsibility for what they sell. ... The conscientious watchmaker, knowing he was a good workman, was told by us that he was not competent to service this product immediately. In many cases, he heard that he was not competent but failed to hear the word 'immediately' and took the defensive point of view that it must, therefore, be an abnormally complex and delicate mechanism which he could not recommend. In other cases he recognized the situation was temporary, and recognized also that in the interim period service would be slow, so that he was cautious in his recommendation."

The long-term effects of this "perfectly lamentable error" were enormous. At a time when \$400 a month was considered

## THE WATCH OF THE FUTURE

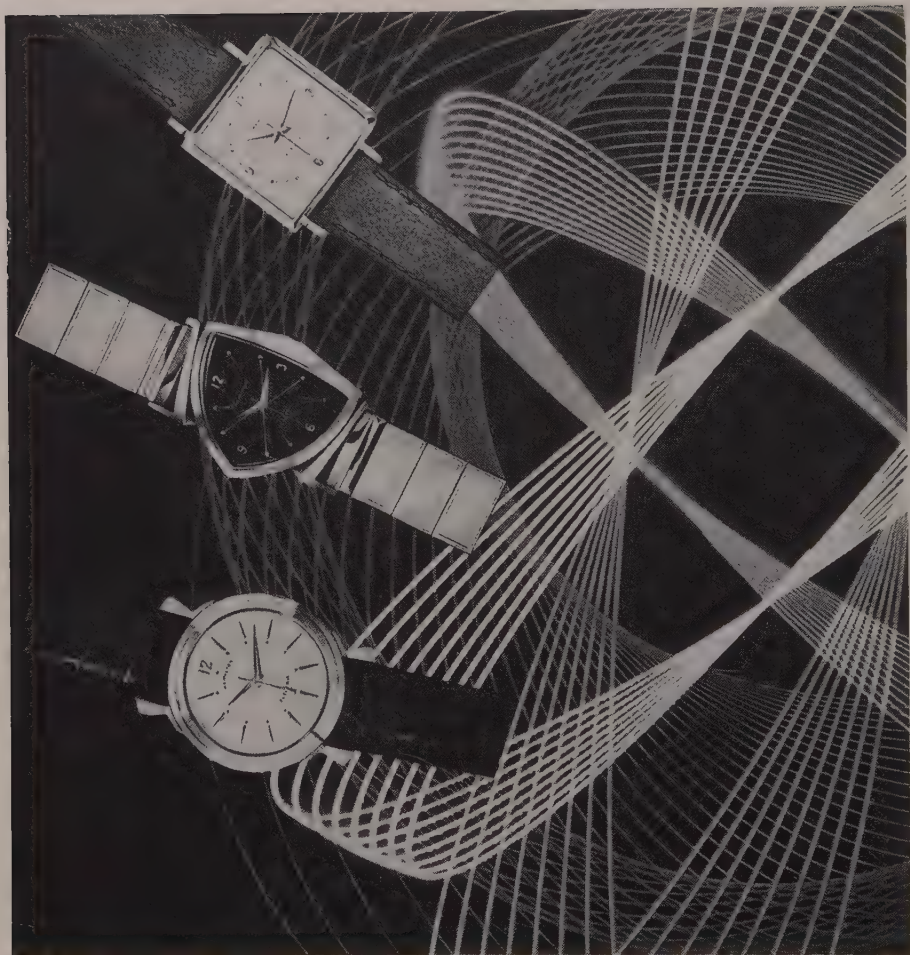

Patents pending

### From Hamilton—the only watches run electrically

Electricity gives them uncanny accuracy. No winding, no twist of the wrist needed. A tiny power cell inside does the work. Rugged, practical watches, Hamilton Electrics have fewer parts (no mainspring!). Your Hamilton Jeweler now has the new Anniversary series celebrating the first birthday of the world's only electric watch. (Top to bottom) Victor, \$89.50; Pacer, \$125; Titan, \$95. Hamilton Watch Company, Lancaster, Pa.

# HAMILTON



CREATOR OF THE WORLD'S FIRST ELECTRIC WATCH

## PROBLEMS AND COMPETITION

a good salary, a \$100 - \$200 Hamilton Electric watch was a major purchase. After being confronted by an unhappy customer whose expensive new watch stopped working, jewelers had a tendency to become decidedly gun-shy. Many of them took the easy way out and avoided selling the new electric watch. Unfortunately for Hamilton, there was no effective way to fight this negative perception, which continued to grow even after a jeweler education program had been established.

Although Hamilton took pride in being the first to market a battery-powered watch, they found that there were disadvantages to being ahead of the competition. The company had done all it could to promote the electric watch but there are limits to what one company can do to publicize something genuinely new. Hamilton assumed that with several companies advertising the advantages of a battery-powered watch, consumers would become increasingly comfortable with the new technology. So, by the end of the decade, Hamilton's managers not only welcomed new competition, they willingly shared their experiences.

*The novelty of the Hamilton Electric led to some under-handed competition meant to deceive the casual viewer. On close examination this counterfeit watch proves to be labelled "HARNILTON Electra." It has a pin lever spring-wound movement in a base metal case.*



Soon, however, Hamilton would be struggling to maintain its share of the market. It was to take over four years for a well-designed, reliable, and easily serviced movement (the Model 505) to become available, and it came to late to restore

jewelers' confidence in the product. Four years of service problems with the preceding Model 500 had eroded Hamilton's reputation with its customers. It is conceivable that the 505 might have turned things around for Hamilton were it not for the fact that the competition they had previously welcomed proved to be much more formidable than they had counted on. As it turned out, the 1960's were years of steady decline for the Hamilton Electric watch.

Though others came on the market with electric watches in 1961-1962, one in particular caused Hamilton the most trouble: Bulova. In October, 1960, Bulova announced its new battery-powered watch – the "Accutron." (The name combined 'accuracy' and 'electronic.') Unlike the Hamilton Electric, which was electromechanical, the Accutron was truly electronic. The balance wheel was eliminated, replaced by a rapidly vibrating miniature tuning fork. The concept was that of the 'double reed' which Hamilton had considered and discarded in 1953.

The Accutron was conceived at Bulova's Swiss subsidiary in Bienne. The initial concept was designed by Max Hetzel, who produced a crude prototype in 1955. It was then passed to William Bennett, the Chief Engineer at the New York office. Bennett put together a three-man team corresponding to the Van Horn-Biemiller-Reese team at Hamilton. Along with Egbert Van Haaften and William Mutter, Bennett worked for four years to refine the concept into a marketable product. Coincidentally, both Bennett and Van Haaften had worked in watch research at Hamilton before joining Bulova, but their previous work had no bearing on their research. Bennett had left in 1946, just before Hamilton began working on the electric watch. Van Haaften was involved in the earliest phases and had been Fred Koehler's supervisor when the "Koehler clock" was invented, but he left the company in 1952 before either the EM or PM watches were first constructed.

Bulova benefitted from Hamilton's troubles. They were well aware of the mistakes Hamilton had made in jeweler

## PROBLEMS AND COMPETITION

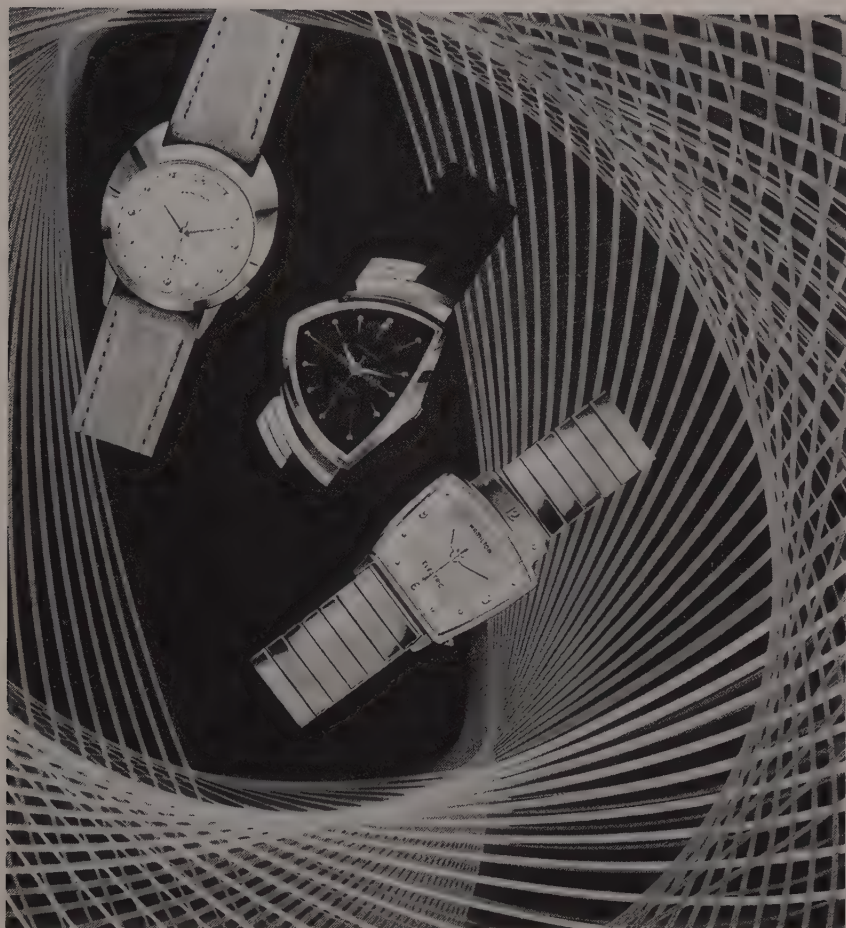

PATENTS PENDING

### What makes the Hamilton Electric Watch so accurate?

A tiny energy cell inside—a far more efficient power source than winding or wrist motion. Yet for all its amazing accuracy and good looks the American-made Hamilton Electric (the world's first) is not just an easy-chair watch. This man's watch is rugged. See it at your Hamilton Jeweler's. Spectra, \$150; Ventura I, \$200; Everest, \$110. Hamilton Watch Company, Lancaster, Penna.

# HAMILTON



CREATOR OF THE WORLD'S FIRST ELECTRIC WATCH

education and did everything possible to prevent the same thing from happening to them. Bulova created a comprehensive training program and supplied specialized tools to their jewelers well in advance of the public release of the watch. They also had a good service support system to back up their customers. Another factor contributed to Bulova's success: by 1960 resistance to new ideas had eased. Hamilton had paved the way for jeweler and consumer acceptance through its advertising, which made it easier for Bulova to launch a watch which was a complete break from the traditional.

More importantly, the times had also changed. Since the introduction of the Hamilton Electric, the space race had started, transistor radios were the rage, and the public was excited about technology. Bulova capitalized on this by advertising the difference between the Accutron and watches with "old-fashioned balance wheels." The distinction was reinforced by the fact that Bulova never referred to the Accutron as a watch, advising consumers that they should buy an Accutron *instead* of a watch. Bulova made other, subtle comparisons to the Hamilton Electric, at the same time linking the Accutron to the space age: "the second hand doesn't skip and jump – it moves with the smooth, continuous motion of a satellite in orbit." (Hamilton, on the other hand, was stuck in the railroad era: a 1963 advertisement asked "which 505 times the 5:05?")

Hamilton had advertised extensively that their electric watch was 99.995% accurate, but in their service literature they acknowledged that the figure was an average, saying that "to guarantee specific performance for any one customer seems unwise." Customers were pragmatically advised that if they found their watch was off, the error could easily be corrected by resetting the hands. Bulova went one step further, claiming that the Accutron was 99.9977% accurate "on your wrist, not just in a test laboratory," and eliminating the crown altogether.



## CHAPTER 9: *IMPROVEMENTS*

Hamilton had clearly made a mistake by rushing into the market before the electric watch had been debugged, but once the watch was released they were trapped by their decision. The cost of tooling was an important consideration, but in the early months the main obstacle to making a more reliable model was that engineers and researchers were forced to spend

*Model 500 Electric movement.*

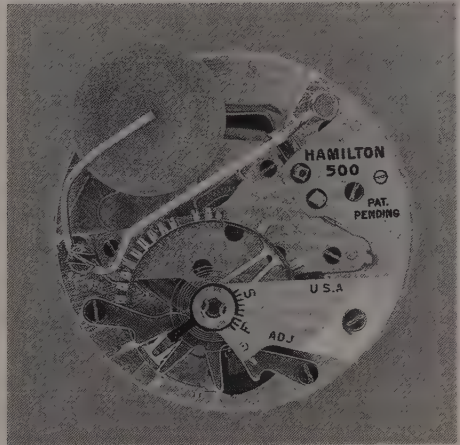

their time "putting out fires," as Jim Reese explained, rather than continuing their research efforts. Problems in production required constant attention, and the returns from the field were overwhelming the factory's capacity to handle them. A radical change was out of the question, temporarily at least, but in the meantime something needed to be done to improve the existing electric watch.

## MODEL 500A

A new research project was established in August, 1957 to develop a more reliable movement, as well as to cut the soaring production costs. The design phase of the new movement, called Model 501, was completed in seven months ("on schedule, time, and money!" John Van Horn enthused in a memo). However, it was never released. Instead, in 1959 Hamilton introduced a variation of the 501, called Model 500A. In the interim, however, new jeweler updates and a repair manual describing the Model 501 had already been published, based on development drawings and specifications. Because of that, confusion about model numbers persists even today.

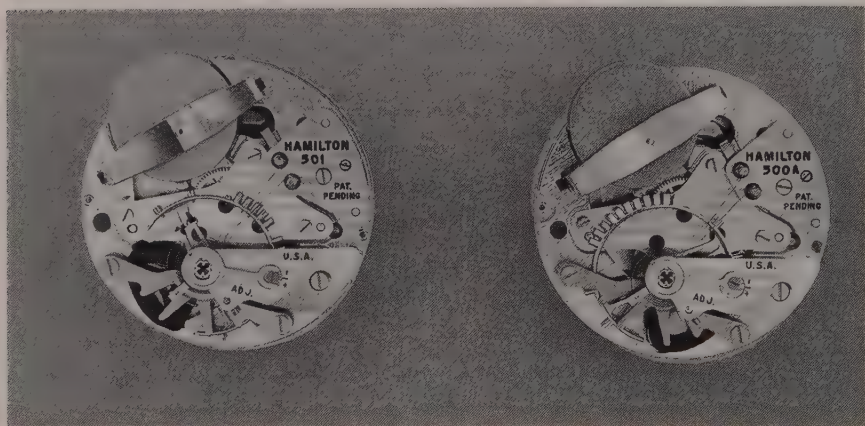

*The widely promoted Model 501 [left] was never released. Instead, a modified version with the Model 500 balance and contact assemblies was marketed as Model 500A [right].*

The Model 500A incorporates most of the design changes of the proposed Model 501, but it still differs from the Model 500 in only a few respects. The most significant change is the battery clamp. In the Model 500 the battery is held in place by a wire spring. Changing the battery requires extreme care because the clamp is located close to the delicate contact

## IMPROVEMENTS

wires. Any slip of the hand in removing and replacing this type of clamp could result in damage to the contacts. The 500A was designed with a recessed battery compartment in which the battery is held by a simple strap snapped into holes in the pillar plate. A new regulator system was added, making it easier to time.

The original Model 501 design called for "Kif" shock-proofing to replace the original "Incabloc" system, a change which was adopted solely for economy reasons. However, many Model 500A movements can be found with Incabloc shock jewels because the factory chose to use up existing parts inventory before making the switch to Kif. The 501 design specified a new style balance wheel, with the coil spot welded rather than screwed in place, but this wheel proved too complex and it was abandoned.

While the Model 500A incorporated all the functional improvements considered feasible at the time, the changes had no impact on reliability. The main problem remained the contact system, which was still difficult to manufacture and sensitive to adjust. For the average jeweler or customer the Model 500A was no better than the Model 500.

## MODEL 505

Phil Biemiller and Jim Reese had both been unhappy about the untimely release of the first electric watch because they knew all too well that the Model 500 was not ready. Biemiller had stayed at Hamilton only because of the electric watch project but he resented the fact that marketing had come ahead of science. Still, he was determined to complete his goal of making a reliable electric watch. Reese was discouraged to find that he was spending most of his time on production problems rather than research. Despite his best efforts, assembly line workers resisted learning the intricacies of the

# THE WATCH OF THE FUTURE

## How the 505 Electric Works

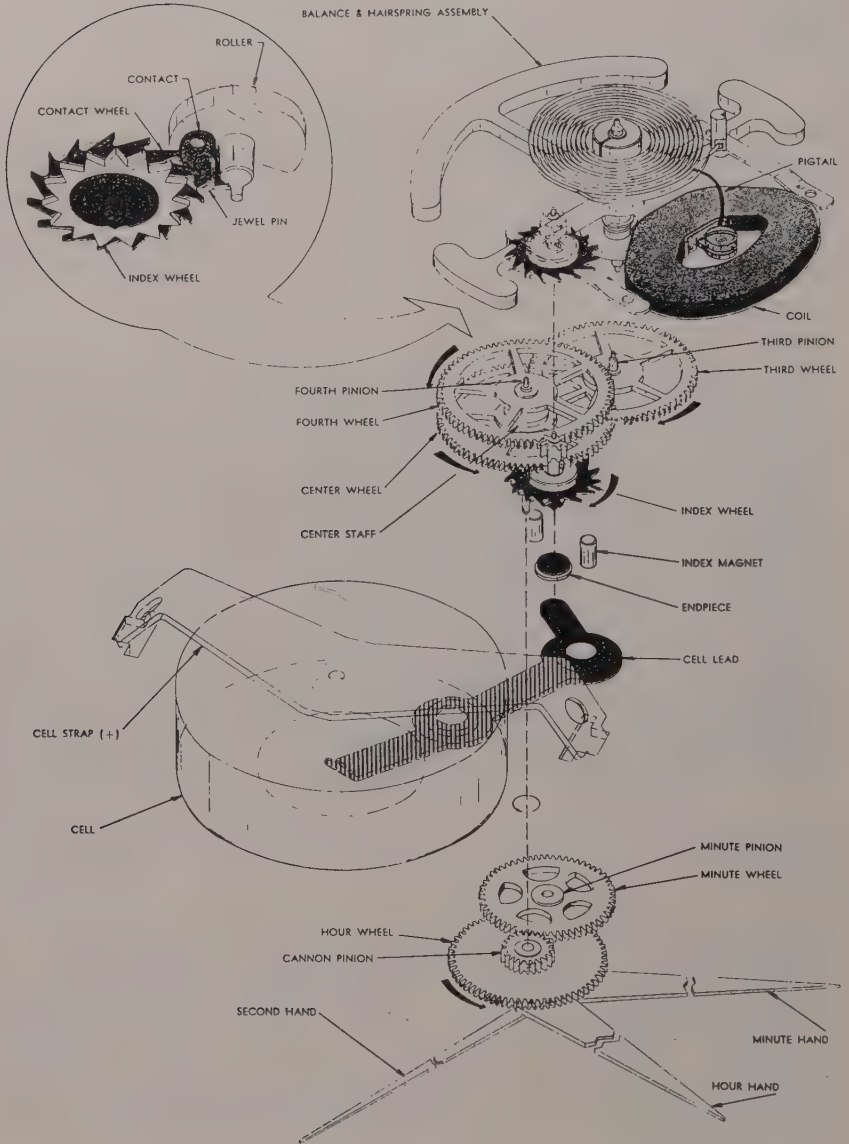

## IMPROVEMENTS

electric watch, particularly contact adjustment. They were intimidated by the new watch and often resented the scientists from the R&D laboratory across the street. Reese was relieved when he could finally return to the lab to work on a new model of the electric watch.

Work began again in early 1959. Biemiller and Reese concentrated their efforts on eliminating the weak points of the Model 500, particularly the contact system. The project progressed smoothly in the early months, but it was interrupted in January, 1960 when Phil Biemiller was hospitalized for lung cancer. After surgery and convalescence he returned to the lab, but his health continued to decline.

Biemiller was frustrated and angered by his weakening condition. At 36 he was still a young man, filled with ambition and an overwhelming determination to complete the work he had started seven years earlier. In April, 1961 he endured a second operation which left him with only a fraction of one lung. He returned to work as quickly as he could but because of his waning strength he was able to spend at most only a few hours a day in the laboratory. He persisted through sheer force

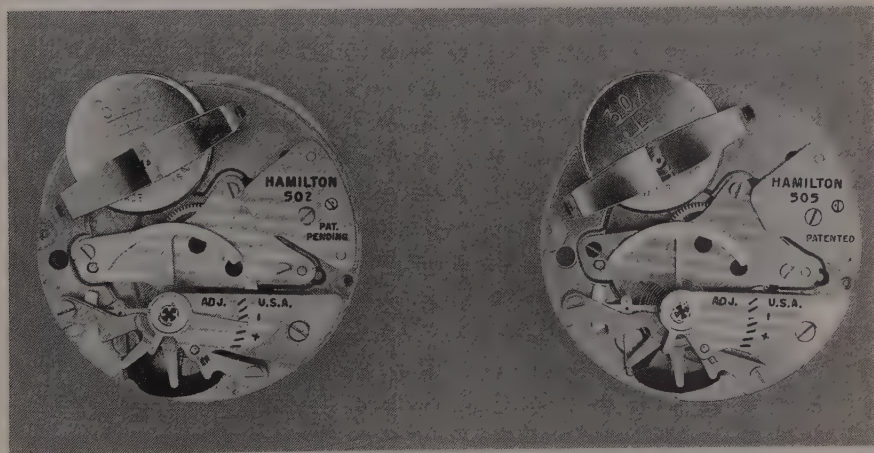

*Prototype Model "502" [left] was renamed Model 505 before being released in July, 1961.*

## THE WATCH OF THE FUTURE

of will. He managed to see the new Model 505 to completion, although many of his responsibilities had been assigned to another engineer since he was unable to work full-time. On October 3, 1961, exactly three weeks before his 38th birthday, Phil Biemiller died.

During the design phase the movement had been named Model 502, sequentially following the earlier movements. Parts production started in early 1961 and patent plates (still marked "patent pending") were made with the Model 502 engraving. In March, 1961 the advertising director suggested the designation be changed to Model 505 because it would sound better in advertising. New patent plates were produced (now marked "patented" because of the many patents which had been issued for the electric watch.) In order to dispose of some of the Model 502 plates the company later used them in watches exported from the U.S. Consequently, it is possible to find "Model 502" movements in Europe and South America.



*"Light and motion" display with twinkling lights that change from "Model 505 Electric" to "World's Most Advanced Watch." [Courtesy Justin Pinchot.]*

## IMPROVEMENTS

The heart of the new Model 505 was the completely new contact system which was invented by Jim Reese. He eliminated the fragile contact wires of the 500 and combined the contact and index systems into a single unit. Reese's new contact system required no adjustment (in fact, adjustments cannot be made) which was a major advance over the temperamental Model 500.

The fact that the contact system needed no adjustment was expected to be a strong selling point to jewelers, while the 18% reduction in manufacturing costs was welcomed by Hamilton's management.

The new Model 505 was released with a great deal of fanfare in May of 1961. Hamilton called it "the watchmaker's watch" because of its incredibly simple construction. The company was careful to avoid the mistakes it had made in releasing the Model 500 without a support system in place. A month before the official release Hamilton sent letters to all of its jewelers to advise them of the new watch and give them details of the marketing campaign that had been developed.

Hamilton advertised the 505 extensively in major magazines and furnished a wealth of advertising material to retail stores. Banners, window decals, a special "motion-light" window display, radio scripts, employee badges, counter cards, window streamers and newspaper advertisements were supplied. Jewelers also received a two-month calendar detailing the dates of Hamilton advertising and suggestions for in-store promotions.

*Model 505 keyring, with the new balance and index wheels imbedded in plexiglass.*



## THE WATCH OF THE FUTURE

**WORLD'S  
MOST  
ADVANCED  
WATCH**

Clockwise from top: Savitar, \$160; Titan II, \$125; Taurus, \$110; Vantage, \$110; Skip Jack, \$79.50 (\$75 with strap). Prices plus tax.

In the sphere of Electric watches, the new Hamilton 505 is a world apart.

More styles, more prices, more experience than any other Electric.

Remarkably accurate, it runs up to two years on a replaceable energy cell.

And the 505 electrical system is so simple, it never needs adjusting.

Prices start at \$75. At Hamilton Jewelers in the U.S. and Canada. **HAMILTON 505**



## IMPROVEMENTS

As a first-hand introduction to jewelers and watchmakers, a series of executive-level teams travelled around the country presenting seminars in 20 major markets. The importance of this promotion is indicated by the status of the factory representatives involved. These were not ordinary salesmen. Even president Arthur Sinkler and Research Director John Van Horn took to the road, travelling from Georgia across the south to Los Angeles, and up the coast to San Francisco.

*Model 505 cloth "badge" matches a large banner used in store decoration.*



In order to demonstrate how uncomplicated the new movement was, at each stop an audience of jewelry retailers and watchmakers watched TV monitors while a watchmaker disassembled a watch under the eye of a closed-circuit television camera. Then a non-watchmaker was guided through reassembly of the movement. The fact that even those with no watchmaking experience were capable of assembling the watch (admittedly with help) was impressive proof of the Model 505's simplicity.

THE WATCH OF THE FUTURE

**HAMILTON** world's most advanced watch

Original... **500**

World's first electric watch

New... **505**

**HAMILTON**

Hamilton produced two "demonstrator" units for the Model 505. One version compared the old Model 500 with the new 505, with drawings illustrating the difference between the contact systems [above]. This was used by Hamilton salesmen to graphically show watchmakers and jewelers that the troublesome Model 500 contact system had been eliminated. Jewelry stores displayed the movement to their customers with a different demonstrator [below].

Introducing . . .

**505**  
ELECTRIC

\* The most advanced watch in the world

- No Winding
- Fewer Parts
- Amazingly Accurate
- Anti-magnetic
- Fully Adjusted
- Shock Resistant
- Energy Cell Guaranteed For One Year

**HAMILTON**  
Creator Of The World's First Electric Watch

## IMPROVEMENTS

Hamilton expressed its confidence by telling salesmen that "we're going to advertise, promote, and push the 505 with more vigor, more ideas, more schemes, than we have ever previously placed behind a product. This will be backed by new models and large scale production. We are making these plans without qualms because we know that the 505 has it. It is sound – it is solid – it will perform. Its capacity for accurate timekeeping is fantastic. In 1962 it will be the sensation of the jewelry industry."

Unfortunately for Hamilton, although the Model 505 is reliable and accurate it was far from a sensation. It simply came too late. As Don Sauers writes in his history of Hamilton, *Time for America*, "'Here we are again' just doesn't pack the wallop of 'Introducing the world's first!'"

If they had not been forced to spend their time dealing with the problems caused by the hasty marketing of the Model 500, Reese and Biemiller would undoubtedly have been able to design the Model 505 much sooner. It is pure speculation now, but it seems likely that if Hamilton had waited until the 505 was developed to release the electric watch it would still have been the first in the market and they could have avoided the loss of business and injured reputation they suffered in the 1950's.

## THE WATCH OF THE FUTURE

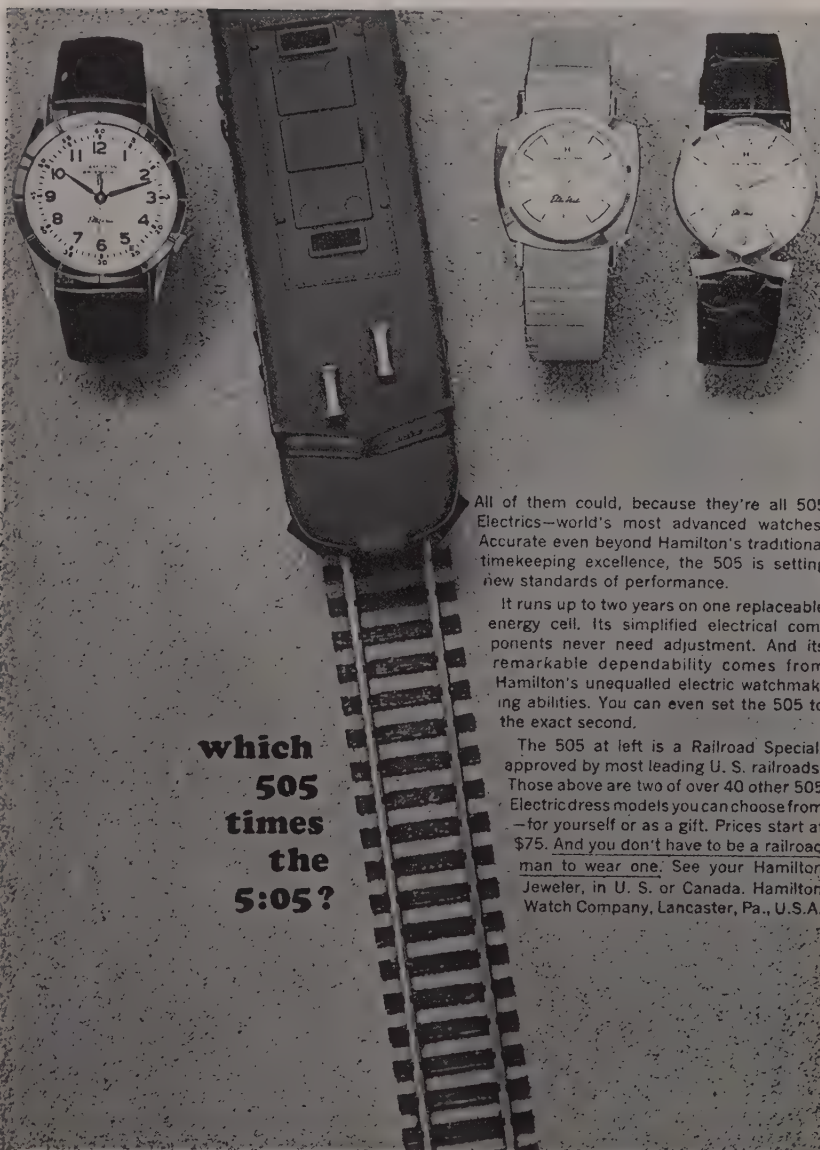

**which  
505  
times  
the  
5:05?**

All of them could, because they're all 505 Electrics—world's most advanced watches. Accurate even beyond Hamilton's traditional timekeeping excellence, the 505 is setting new standards of performance.

It runs up to two years on one replaceable energy cell. Its simplified electrical components never need adjustment. And its remarkable dependability comes from Hamilton's unequalled electric watchmaking abilities. You can even set the 505 to the exact second.

The 505 at left is a Railroad Special, approved by most leading U. S. railroads. Those above are two of over 40 other 505 Electric dress models you can choose from—for yourself or as a gift. Prices start at \$75. And you don't have to be a railroad man to wear one. See your Hamilton Jeweler, in U. S. or Canada. Hamilton Watch Company, Lancaster, Pa., U.S.A.

With the exception from left: R. R. Special \$75; 505 \$79.50. Taxes \$1.10. Pularis \$50. All prices plus tax.

HAMILTON **505** ELECTRIC

## CHAPTER 10:

### *UNFULFILLED DREAMS*

By the mid-1960's Hamilton was rapidly losing ground in the marketplace. The electric watch was no longer a novelty and the legacy of their service problems continued to haunt them. Competing companies, particularly Bulova, had taken a large share of the market for battery-powered watches. (The most aggravating competition came from Timex, which was marketing inexpensive electric watches with movements nearly identical to the Model 505. In 1965 Hamilton was forced to sue for patent infringement.)

Market realities were catching up with them, but Hamilton continued to invest time and money in the electric watch, futilely searching for other segments of the market to penetrate.

### CALENDAR WATCH: MODELS 505C AND 507

Wristwatches with a calendar feature had been around for many years, but in the early 1960's their popularity had reached an all-time high. Hamilton's line of mechanical watches featured a variety of calendar models, however the design of the electric watch made it impossible to adapt a conventional date feature.

In a spring-driven watch the date wheel is moved only once a day, at midnight. For the remaining 23 hours and 59.9 minutes it must be kept firmly locked in position to prevent it from being accidentally indexed by shock or vibration. The excess energy stored in a mainspring is easily transferred to the

## THE WATCH OF THE FUTURE



*Model 505C prototype. Most have the date at 4 o'clock, but some were made with the date window at 3.*

release mechanism, but in an electric watch the delicate floating train lacks sufficient power.

In 1962 researchers began working on a totally new calendar mechanism for an electric watch, called Model 505C. To circumvent the problem of indexing a heavy date ring, Jim Reese devised a shutter mechanism operating in tandem with a continuously driven date ring, rotating at the rate of 1/31 revolutions per day. The spring loaded shutter runs at the same speed, so the date ring numeral always coincides with the opening in the shutter. The date window on the dial is twice as large as the numeral. As the date ring slowly revolves, the numeral moves downward, framed by the shutter, until at the bottom of the window the shutter is triggered to snap up to the top to reveal the next date. The system required very little power to operate, but it was difficult to control the precise time at which the shutter would index to the next date. It also lacked a separate setting mechanism for the date, making it very difficult to adjust the calendar. Consequently the 505C was never marketed.

In 1965 and 1966 a refined calendar movement was devised, called Model 507. It retained the continuously rotating date ring and spring loaded shutter of the 505C, but to solve

## UNFULFILLED DREAMS

the indexing inconsistency the shutter was operated by a cam rather than being linked to the date ring itself. An intermediate stem position was created to allow the date wheel to be advanced separately from the hands.



*The Model 507 reached production, but was abruptly cancelled. An estimated 25 were completed [left]. The factory planned to make many different styles of Electric calendar watches, as can be seen by the variety of calendar dials [right].*

The 507 was unconventional but it did work reliably. Five prototypes were made in 1966, and production was slated to start in March, 1967. There were plans to make a wide variety of styles, and dials were designed and produced for several projected models. The company's new president, Richard Blakinger, was enthusiastic about the watch but the Marketing Committee was not convinced there was a market for it. They also feared a more complicated watch would result in even greater service problems.

Shortly after production was started the company terminated the project. It is reported that approximately 25 of

the Model 507 watches were completed, but none were ever marketed.

(In the 1970's, after the Hamilton watch division had been sold to a Swiss concern, calendar watches fitted with transistorized Swiss-made electric movements were marketed with the Hamilton name. These watches can easily be identified by the small-sized date window and the word "Electronic" rather than "Electric" on the dial. They bear no connection to the original Hamilton Electric series and should not be confused with the Model 505C or 507.)

### THIN ELECTRIC: MODELS 510 AND 511

In the 1950's there was a noticeable trend in the industry toward thin movements. Consumers like the elegant look of wafer-thin watches. In its mechanical line Hamilton had responded with a series of "Thinline" and "Thin-o-matic" watches, but the electric models remained awkwardly chunky.

In 1963 the company began working on a "Thin Electric," Model 508, which was originally to be nearly half as thick as

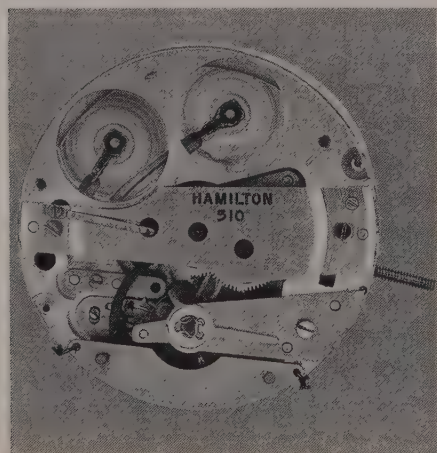

*"Thin Electric" Model 510 reached production before being abandoned.*



## UNFULFILLED DREAMS

The Model 505. A completely new movement was designed, in which the flat coil was replaced by two coils on the rim of the balance wheel and the magnets were placed outside the balance rather than under it. The concept was abandoned because researchers determined that the electrical system could only deliver half the necessary power to operate the watch.

Researchers tried again in 1964 with the Model 510, which used a very small balance wheel and two tiny batteries for power. Engineering drawings were issued and parts production was started in 1965. Several completed movements were constructed but the small balance and tiny contacts proved to be underpowered and unreliable. The project was cancelled.



*Eleven prototypes of the Model 511 [right] were made and submitted to wear-tests before the project was terminated.*

Another attempt was undertaken in October, 1965. This time researchers tried a different approach, adapting the existing Model 505 technology to make as thin a watch as possible. This "thin electric" was named Model 511. In the 511 electrical polarity was reversed, resulting in less contact wear and improved electrical efficiency. The use of smaller magnets and the elimination of several parts also reduced the cost of production. Eleven prototypes were made in 1966 for laboratory and wear tests, and the watch performed well. But, in the

## THE WATCH OF THE FUTURE

end, the Model 511 was only five one-hundredths of an inch thinner than the Model 505. It certainly did not qualify as a "thin" watch in conventional terms.

The 511 thin electric suffered the same fate as the 507 calendar watch. In March, 1967, after nearly two years of development, the 511 was cancelled because the Watch Review Committee felt that it would not fill a need in the market. The Hamilton Electric was quietly being phased out.

### LADIES ELECTRIC

Researchers first started dreaming of making an electric movement small enough to fit in a ladies wristwatch as early as 1953, once a small coil had been developed for the Model 2. The reality was, however, elusive. President Arthur Sinkler

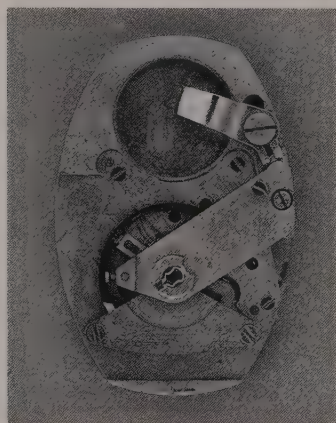

*"Ladies Electric" prototype,  
serial number 1 [1966].*

had been a strong advocate of a ladies electric in the mid-1950's, but work on this project had to take a back seat to the more pressing urgency of completing the Model 500 and 505 movements. During the mid-1960's a great deal of research was undertaken and eventually ten prototypes were assembled, between 1966 and 1968. However, the movement was impracti-

cal and came virtually at the close of Hamilton Electric production.

## **THE VANTAGE SERIES**

The watch market of the 1960's had become extremely price sensitive. American manufacturers were finding it impossible to produce watches to compete with imported models. Many companies, including Hamilton, had established Swiss subsidiaries to manufacture inexpensive mechanical watches. By the middle of the decade imported electric watches had also begun to appear, making it even more difficult for Hamilton to compete.

Like many other manufacturing companies with a long and established reputation for quality, Hamilton was reluctant to make cheap watches under its name, but without a line of inexpensive models it was going to lose even more ground to the competition. The solution was simple: create a distinctly separate line of cheap watches, both mechanical and electric, to be marketed under a different name: VANTAGE.

A subsidiary company called the "Standard Time Company" was established in St. Croix to assemble mechanical watches from imported Swiss parts. Separately, Hamilton contracted with the Ricoh corporation in Japan to produce metric knockoffs of the Model 505 Electric movement, which were fitted into base metal cases in Hamilton's plant in East Petersburg, Pennsylvania. The Vantage electric movements were labelled with the Standard Time Company name.

The bold designs of the Hamilton Electric line were nowhere to be found in the Vantage series, which was marked by bland and unexciting styling. A completely separate sales division was formed to sell Vantage watches, so that the connection to Hamilton would be further blurred.

The concept had merit, given the economics of the time, but it was a failure. Hamilton planned to sell half of the production of Vantage electrics in Japan but that expectation

never materialized. Ricoh had problems in the production of the electric movement, and the watches were not reliable. Even at the low end of the price spectrum the competition from other electric (and electronic) watches was becoming strong, making it impossible for the Vantage to capture a significant share of the market.

Although Hamilton persisted with the Vantage line for a few years, the writing was on the wall. The Hamilton Electric was a watch whose time had come and gone.

## END OF AN ERA

When the Hamilton Electric was introduced in 1957 it was as revolutionary as the company claimed. At the time it appeared as though it really was 'the watch of the future,' but unfortunately for Hamilton the future passed it by faster than anyone could have imagined.

The Hamilton Electric had spanned the decade between the launch of the first satellite into space and man's first step on the moon. Technology and society had moved at breathtaking speed in those years and by 1969, when production ceased, the Hamilton Electric had become a quaint electromechanical relic.

In a very real sense, the Hamilton Electric *was* the watch of the future. As the world's first battery-powered watch it had paved the way for the next major horological breakthrough: the solid-state quartz digital watch.

## CHAPTER 11:

### *COLLECTING HAMILTON ELECTRICS*

More than twenty years after the last Hamilton Electric was made these unique watches have become highly prized collectibles. Even among collectors of 'high grade' European watches models such as the "Ventura" are sought after because of their avant-garde styling. However, a new category of specialists has been growing, collectors who seek out all the myriad variations of the Hamilton Electric watch.

There is no doubt these watches would be even more popular if they were better understood. Asymmetrical watches with mechanical movements from Hamilton and other manufacturers often command higher prices than most Hamilton Electrics because collectors are more comfortable with their conventional movements than with the sometimes troublesome electric movements. Thirty years ago there were few watchmakers who were knowledgeable about the repair and adjustment of the Model 500, and today there are even fewer. However, there still are watchmakers who can and will work on these unique watches, and when properly adjusted they can be surprisingly accurate and more reliable than most people give them credit for.

Ironically, many retailers of antique watches avoid selling Hamilton Electrics for the same reasons jewelers avoided them in the 1950's. Although serious collectors always manage to find watchmakers capable of maintaining their electric watches, retailers who deal primarily with non-collectors worry that they cannot offer the same guarantee as they can with mechanical watches.

Hamilton Electric watches are fascinating to collect. They are inherently interesting, and the asymmetrical models are stunning examples of 1950's styling at its most creative. Most of the eccentric styles are challenging to find, yet by and large they are still relatively inexpensive, making it possible to build a fine collection at modest expense. However, interest in these watches has grown significantly in the past several years and they have become scarcer and more valuable as more people have begun to collect them.

### TIPS FOR THE COLLECTOR

For the average collector, evaluating a potential purchase is more difficult with Hamilton Electrics than mechanical watches. Although visual examination cannot reveal every possible pitfall, there are a number of useful points to consider when inspecting a Hamilton Electric watch.

**CASES:** The cases for Hamilton Electrics were, for the most part, extremely well made. Gold-filled cases normally had a thicker layer of gold than conventional watches, and were less subject to wear. Gold watches should be checked for heavy polishing, which removes design detail. On gold-filled watches look for wear at the corners, particularly on the back. Some watches, particularly "Pacers," often have severe wear on the back. Look for signs of wear-through, leaving a hole through which dust can enter.

**DIALS:** While collectors always prefer original dials in good condition, often dials must be refinished due to staining or other damage. Unfortunately, more often than not these refinished dials are not restored to the exact original appearance, which detracts from the watch.

Refinished dials can often be identified by thick or uneven printing on the logo or lines. Original silver dials were

## COLLECTING HAMILTON ELECTRICS

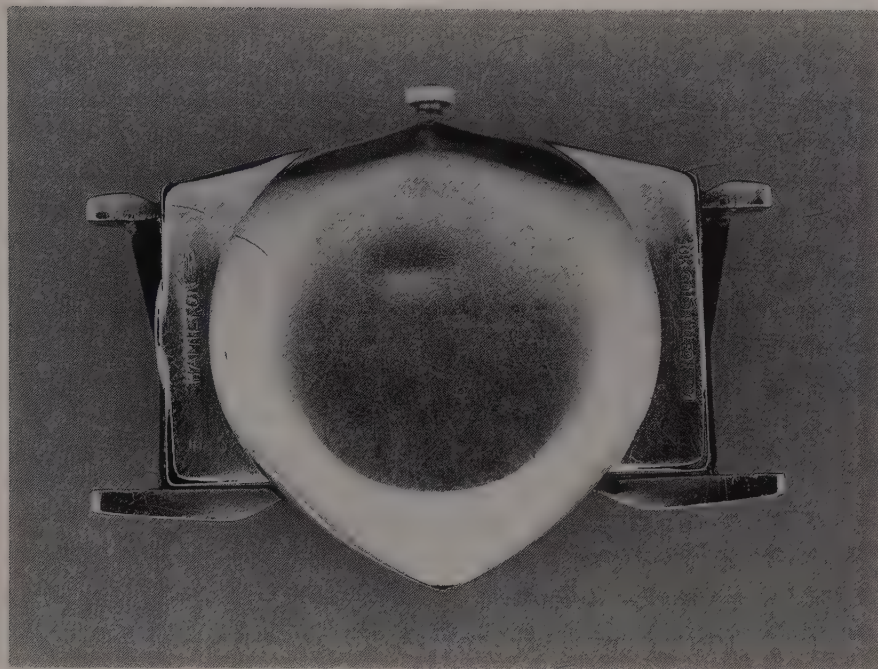

*Gold filled cases, particularly "Pacers", are prone to wear at the corners.*

brushed, either radially or vertically, while most refinished dials have a grainy appearance due to an application of a silvered applique. Hamilton made black dials by plating the blank with black nickel, printing the markings, then finishing the surface with gloss lacquer. The result was a luster which has real depth. Today, most refinishers paint the dial with enamel, which does not have the depth of the original. Some companies do use the black nickel plating technique which, when properly done, is difficult to distinguish from an original. Usually, however, the gold printing is less bright and has less luster than Hamilton's. Some collectors look for the tiny marking "Pat. Pending" on Model 500 watches as an indicator of an original dial, however some refinishers today duplicate the marking quite accurately.

The only sure determination of a refinished dial is to remove the dial from the movement and check the back. Refinishers always mark the dials with a code to identify the customer.

Ultimately, however, if the dial is correctly refinished it does not detract from the watch. Unfortunately, it is all too rare to find a refinished dial which accurately matches the original.

Collectors sometimes find watches with dials that do not appear in Hamilton's catalogs, and which might therefore seem questionable. However, an odd color or design is not necessarily an indication that the dial is not authentic. Hamilton produced many rare but completely authentic dials in small lots or on special order. Steel gray, blue gray, and gold are a few examples of colors which were made in the 1950's and 1960's. Here again, a close examination can determine its authenticity.

Hamilton also produced a number of dials with corporate logos for award watches. Special dials such as these add spice to a collection.

**MOVEMENTS:** The heart of the watch, of course, is the movement, but it requires very close examination to determine its repairability. Unfortunately, many watches have seen extensive wear or mishandling.

**MODEL 500:** The most important feature to examine in a Model 500 movement is the contact system. To determine its condition, a four- or five-power eye loupe must be used. With the stem pointing toward you, look carefully at the wires as they extend underneath the hairspring. The trip wire (on the right as you hold the watch in this position) must have a small box attached near the far end, through which the contact wire is threaded. The contact wire should have a distinct bend at the far end, and must have a small 'button' on the very tip. (Refer to Appendix I, figure 23 for an illustration of these two



## COLLECTING HAMILTON ELECTRICS

wires.) If any of these parts are damaged or missing the watch cannot be repaired without replacing the wire(s).

While holding the watch in the same position, rotate the balance wheel slightly in a counterclockwise direction to inspect the gold contact tab on the balance assembly. This tab is normally dirty with a carbon deposit, but it should not be notched or completely sheared off, which are the result of excessive wear.

The last critical point is the coil, but to determine its condition an ohmmeter is required. Many coils have been damaged by mishandling. If such is the case, an ohmmeter will indicate a short or open circuit rather than the proper resistance of 3100 ohms, plus or minus 400. A damaged coil cannot be repaired.

*MODEL 505:* It is much harder to visually evaluate a Model 505, but without the fragile and exposed contact wires there is less to go wrong in this model. The usual problem with the 505 is excessive wear on the gold contact on the balance wheel, but to inspect this point the balance must be removed. One useful test is to gently rotate the wheel by hand to set it in motion. If the wheel slows down and stops evenly, the contact has a good chance of being sound. If, however, the wheel shudders and stops abruptly it indicates a deep groove has been worn in the contact.

The coil in the 505 is just as susceptible to mishandling as the 500, and an ohmmeter is essential to determine its condition. The correct resistance is approximately 4,400 ohms.

## BATTERIES

*MODEL 500:* The Model 500 was designed to be used with the Union Carbide ("Eveready") number 201 battery cell, a 1.53 volt, low-drain battery with a gold-plated case (for corrosion protection, better contact, and psychological effect).

## THE WATCH OF THE FUTURE

Because of the low demand, this battery was discontinued in 1990 and it is no longer available.

Although any 1.5 volt low-drain battery can theoretically be used in the 500, there are no cells which match the dimensions of the original. Large batteries are difficult to fit into the recess and small batteries have a tendency to shift in the case, often short-circuiting against the pillar plate.



*The original 201 battery [left] is no longer produced. A suitable replacement can be made by fitting a 394 battery into the plastic grommet taken from an old 387.*

There is, fortunately, an answer to the problem, consisting of a hybrid of two batteries, 387 and 394. The 387 cell, designed for the Bulova Accutron, combines a plastic spacer ring and a small battery. In size it is virtually identical to the 201, however it generates only 1.35 volts. (The watch will run at that level, but in a very short period of time the power will drop to 1.3 volts and the watch will become erratic and stop.) The solution is to fit a 394 cell, which generates a full 1.5 volts, into the plastic spacer from a used 387. The resulting combination is a perfect replacement for the 201 in nearly every respect.

(Note: when fitting a battery in the Model 500, extreme care should be taken to avoid accidentally hitting the exposed contact wires.)

**MODEL 505:** The correct battery for this model is number 301, which is still easily obtained. However, the

## COLLECTING HAMILTON ELECTRICS

leading battery manufacturer, Eveready, has altered the dimensions of its 301 cells. The thickness has been marginally increased and the raised 'dimple' in the center of the negative pole has been flattened. These modern Eveready 301 batteries will not fit properly in the Model 505 and will short out against the pillar plate. Other manufacturers, such as Renata, Maxell, and Sony still make 301 cells (or their equivalent under the numbers SR43SW, SR44SW, RW34, and RW14) which fit correctly.

*New Eveready 301 batteries [left] do not have the same dimensions as the original 301 [right] and will not fit the Model 505 correctly.*

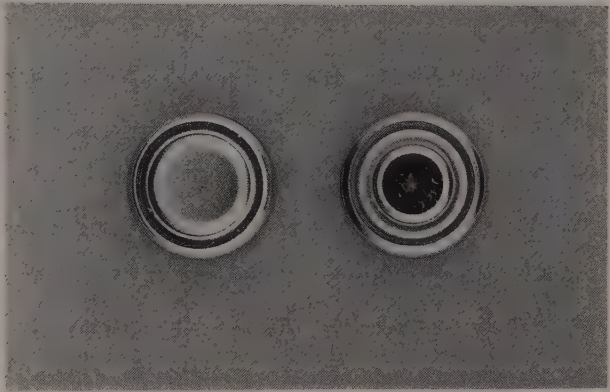

The hybrid cell described earlier (a 394 battery fitted in a 387 spacer) is suitable for the Model 505 if the metal cell lead on the movement is bent upwards very slightly to make firm contact with the negative pole.

**IMPORTANT:** On both the Model 500 and 505 it is strongly advised that the watch be shut off when not being worn. Pulling out the setting stem stops the watch and shuts off the electronic circuitry. The amount of battery power saved is negligible, however stopping the watch prevents unnecessary wear on the fragile contacts. If the watch is not to be worn for a long period the battery should be removed from the case to prevent any possibility of leakage.

## REPAIRING THE HAMILTON ELECTRIC

Over the years the Hamilton Electric has acquired a reputation as a very difficult watch to service. This reputation is not without foundation, as the problems experienced by Hamilton clearly prove. However some of the legendary troubles of the Electric watch have become exaggerated with time. While the Hamilton Electric is admittedly a delicate mechanism, it is capable of running quite accurately and reasonably reliably.

In both the Model 500 and 505 problems can usually be traced to the contact system. Like the points in an automobile engine, the contacts are continually opening and closing -- five times each second in the Hamilton Electric. This constant physical contact inevitably leads to wear and ultimate destruction of the parts.

In the 1950's and 1960's watchmakers could simply order new replacement parts from Hamilton. Unfortunately, we no longer have this luxury and repairs are more difficult now than thirty years ago.

The delicacy of the Model 500 contact system is a mixed blessing for today's collectors. Because the wires tend to go out of adjustment because of friction and normal wear, most watches were not subjected to a great deal of use. If the wires are intact and the coil is not shorted out it is possible to adjust a Model 500 by scrupulously following the detailed adjustment instructions in Appendix I.

For the serious hobbyist or watchmaker there are two excellent (and nearly identical) repair manuals for the Model 500. The first book to be published on this watch was not issued by Hamilton but rather by a brilliant young watchmaking instructor at the Western Pennsylvania Horological Institute, by the name of William O. Smith, Jr. Smith had authored a number of horological repair manuals, specializing in complicated watches. He became intrigued by the Hamilton Electric

## COLLECTING HAMILTON ELECTRICS

and purchased a "Van Horn" to disassemble and study. He later spent a week at the factory and subsequently published a detailed and meticulously illustrated book titled "Hamilton Electric Watch Repair" in 1958. Copies can sometimes be found in old jewelry stores or at collectors' meets.

Smith's book was so comprehensive that Hamilton's management felt they could not improve upon it. They purchased the rights to republish it and issued an official manual, with slight modifications, in 1959. This book was supplied to jewelers as an essential reference. Hamilton's edition includes many drawings and references to the never-marketed Model 501.

What makes the Model 500 so challenging (and sometimes frustrating) is that the contact wires must be adjusted *absolutely precisely*; there is no margin for error in tension, height, or positioning. Even very slight irregularity in the adjustment will cause the watch to run erratically or stop completely. But, when adjusted to the exact factory specifications, the watch can run extremely accurately.

The Model 505 is, fortunately, much simpler. However, the contact pressure in the 505 was much stronger than in the 500 and it is not uncommon for the gold contact on the balance assembly to wear out completely.

There are two types of contacts found on Model 505 balances. The first watches to be released were fitted with a gold half-cylinder fitted behind the index jewel. This type of contact, called a D-pin, was prone to rapid wear. In constant use a groove is worn into the soft gold, causing mechanical binding with the index wheel. To correct that problem the factory developed an improved contact called the Z-pin. This contact consists of a tiny piece of flat gold, made from a harder alloy than the D-pin, mounted to the back of the index jewel and wedged in place by a small block of polyurethane between the balance staff and the jewel.

Compensating for a worn contact is quite difficult. The best solution is to exchange the balance wheel with one from another watch on which the point of wear is at a different position on the pin. If the groove is not extremely deep it is sometimes possible to reduce the mechanical interference by carefully filing the contact. (A 10-power loupe is necessary for this procedure.)

The other key component in the 505 is the index wheel. The bottom hub of this wheel was constructed with a small point, but with time this point wears flat and the wheel no longer has adequate clearance over the positioning magnets. Such worn wheels must be replaced.

Because of the lack of new replacement parts, the life of all Hamilton Electrics is finite. For this reason, the importance of shutting off the watch when it is not being worn cannot be overstressed.

Many collectors build a personal stockpile of parts by buying the less desirable round and stainless steel watches. The movements can then be used in the restoration of rarer models.

The most important advice to the collector is to treat the Hamilton Electric as a fine piece of jewelry; it should not be subjected to hard wear.

Both the Model 500 and 505 can be cleaned in conventional cleaning machines. It is advisable to use fresh solutions to prevent tiny particles of metal from being attracted to the magnets. Metal burrs on the magnets can be removed with scotch tape.

The movement should be oiled very sparingly, just enough to wet the pivots. All bearings and gears should be checked carefully for any binding; the train of the electric watch is more delicate than that of a spring-wound watch and more susceptible to interference.

Unlike mechanical watches, the hairspring should be detached from the balance cock in disassembly. This will avoid

## COLLECTING HAMILTON ELECTRICS

the hairspring from becoming deformed in reassembly, since the magnets will attract the balance staff. The hairspring stud should be reattached after the balance wheel and cock are in place. (Step by step instructions for the repair of the Model 505 are reprinted in Appendix II.) Also, dial washers should *never* be used in the Electric watch.

With care, patience, and practice, and barring irreversible damage to the contact system, Hamilton Electric watches can be repaired by anyone with some basic watchmaking skill.

### QUARTZ CONVERSIONS

It is increasingly common to find asymmetrical Hamilton Electrics with new quartz movements replacing the original electromechanical 500 or 505. Many dealers who sell antique watches to non-collectors routinely do these 'quartz conversions' to make them more reliable.

To quartz or not to quartz is obviously a personal decision, but from a collector's standpoint it is always preferable to keep every watch as original as possible. A quartz movement in a "Pacer" or "Spectra" makes for a very striking and very reliable watch, however, it is no longer authentic. Quartz conversions are akin to installing a new 8-cylinder Chevy engine in a Model A Ford. While it may look and run great, it is a hot rod, not an antique auto.

Still, quartz conversions are not necessarily all bad. Some otherwise unrepairable watches may be saved, and it does at least bring these intriguing watches out of people's drawers and onto their wrists. For travelling or sports a 'quartzed' watch is undoubtedly preferable to an original, and many collectors would admit to owning such a watch for casual wear.

In making the decision whether to do a quartz conversion the collector should consider the rarity of the watch and the quality of the conversion. It is somehow less offensive to

## *THE WATCH OF THE FUTURE*

alter a very common watch, like the "Pacer," than a truly rare watch, like the "Altair." Also, it is usually unnecessary to convert Model 505 watches since these movements are reasonably reliable. The original movement should always be retained in case a later decision is made to restore the watch.

In any conversion the work should be done professionally and no permanent changes should be made to the case or dial. Unfortunately, such reversible conversions are rare. Previously, the modern Hamilton company performed quartz updates using a custom conversion set which fit the dial and case precisely. However, the factory no longer does such conversions and it is now extremely difficult to find movements which will fit in the original case without alterations.

Collecting Hamilton Electrics is both challenging and rewarding. These are watches with unique character, both in their styling and their mechanics. They are fascinating relics of a time when the future was on everyone's mind, and new design and technology went hand in hand.



COLLECTING HAMILTON ELECTRICS



**HAMILTON PRESENTS  
THE WORLD'S FIRST**

*Electric Watch*

VENTURA I, \$200 00, white or black dial.

Price Includes Federal Tax • U. S. and Foreign Patents Pending



## Part 2: The Watches



## *INTRODUCTION TO PART II*

In the following pages all of the production models of Hamilton Electric wristwatches are illustrated. Since neither a chronological nor an alphabetic arrangement seemed appropriate, they have been organized in a somewhat arbitrary order according to 'collectability,' an admittedly vague notion. In some instances models are related by design or name, in which case they are shown together regardless of their date of introduction. Each watch is identified with its model name, the date when it was released, and the original retail price. This information was taken directly from factory records.

Watches made between 1957 and early 1961 were sold with either the Model 500 or 500A movement, while watches produced after May, 1961 were fitted with the more reliable 505 movement. However, it is not unusual for the original movement to have been replaced over the years.

Hamilton frequently recycled obsolete model names by adding the suffix "II." Sometimes these reworked names were used on essentially similar watches, like the "Polaris II" and "Savitar II," however many names were used on watches which bear no resemblance whatsoever to their namesakes, such as the "Victor II," "Spectra II," "Regulus II," etc. The illustrations and descriptions in these pages should clarify the confusion for collectors.

Also, it is not uncommon to find variations in dials and hands. Many are original although not documented in contemporary catalogs. The most significant variations are described or illustrated in the text.

Unfortunately, the information most desired by today's collectors is not available, namely the quantity produced of each style. Several years of research has failed to uncover this tantalizing information. It may turn up in the future, but for the moment it must remain a frustrating mystery.

## "VENTURA"

Release date: January 3, 1957

Retail price: \$200



Along with the "Van Horn," the "Ventura I" was the first electric watch on the market, and it remains the most popular model with today's collectors. Today, as in 1957, the remarkable asymmetrical design symbolizes the unique character of Hamilton Electric watches. The shape reflects the 'boomerang' motif which was so common in coffee tables, ashtrays, and jukeboxes of the era. The design was meant to dramatically reflect the new and innovative technology inside the case. Even the crown made a statement: it was obviously too small to be used for winding.

The "Ventura" was originally offered in a 14K yellow gold case with either a black or silver dial, and a matching strap with a stripe of 24K gold applique to accent the striking appearance of the watch (see page 64). For unknown reasons this strap was discontinued within only a few months, and it is now extremely rare to find a watch with the original strap. To package the new "Ventura" and "Van Horn" models the factory updated their mechanical watch box by adding a yellow ribbon marked "Hamilton Electric Watch" inside the plastic lid, and gluing a blue paper label on the outer cardboard box. A custom box for the Hamilton Electric was introduced shortly thereafter.

## THE WATCHES

A 14K white gold version of the "Ventura" was introduced on October 17, 1958. It is much rarer than the yellow-gold "Ventura."

Hamilton evidently intended to produce a gold-filled version of the "Ventura," to be called "Ventura II." There is no indication that any were actually produced. Evidently the "Pacer" supplanted the "Ventura II." Nonetheless, the designation "Ventura I" appeared in every catalog reference until 1962.



*The "Ventura" with two-tone strap, in the original box.*

Watches which were exported from the U.S. were made of 18K gold because 14K gold did not meet foreign standards of purity for gold jewelry. The 18K yellow gold "Ventura" was released on October 6, 1958 for the European market, and an 18K rose gold version was introduced on June 4, 1959 for export to South America. Both are extremely rare and desirable. Many of these export watches carry patent plates marked "Model 502," as described in Chapter 9.

The "Ventura" was produced until 1963, consequently it can be found with either the Model 500 or 505 movements. Later dials were marked with the Hamilton "H" logo and

## THE WATCH OF THE FUTURE

jagged "electric" script replacing the block letters of the early dials.



Both the white and yellow versions of the "Ventura" were available with a diamond dial, at \$300. These models are quite scarce.

The "Ventura" is not a particularly rare watch. It was an extremely popular model and a great many were sold. Recognizing its continuing popularity, in 1988 the modern Hamilton company introduced a gold-plated reproduction with a quartz movement. This had an immediate impact on the market for original "Venturas."

Because many potential buyers were more interested in appearance than originality, supply quickly outstripped demand. Prices for original watches had been inflated given the fact that the "Ventura" is fairly common, and they quickly collapsed. Within three years the market stabilized, and today the "Ventura" is valued at a level more in keeping with its rarity and intrinsic worth.

The reproduction "Ventura" had another, more positive impact on the market. Many people, who previously had no interest in antique watches, became intrigued by the "Ventura" and have gone on to become collectors of original Hamilton Electrics of all styles.



## THE WATCHES

### "PACER"

Release Date: November 1, 1957

Retail Price: \$125 (metal band); \$110 (leather strap)

Of the more than 70 different case styles in the Hamilton Electric series, by far the most popular was the "Pacer." It was the only watch to appear in every catalog from 1958, one year after the introduction of the Hamilton Electric, until 1969, the end of Electric watch production. That twelve year span is one of the longest of any wristwatch model, mechanical or Electric, made by Hamilton.

The "Pacer" remains the most popular Electric watch today as well, for the same reasons it was so successful thirty years ago: the dramatic styling appeals to collectors and non-collectors alike. (For that reason, many dealers have been converting "Pacers" to quartz movements for the general market.)

With its 10K gold-filled case it was essentially an inexpensive version of the more precious "Ventura." The lugs are plainer, but the basic design is so similar that the average person was unlikely to make any distinction between the two watches.

The "Pacer" is notable for its two-tone case, yellow gold with white gold lugs. It was originally offered with a matching two-tone metal band at \$125 or a leather strap at \$110. The original bands are quite scarce today.

The "Pacer" dial is different from that of the "Ventura," with arrow markings replacing the gold dots, and numerals at 12, 3, 6, and 9. In its most basic form there are two different

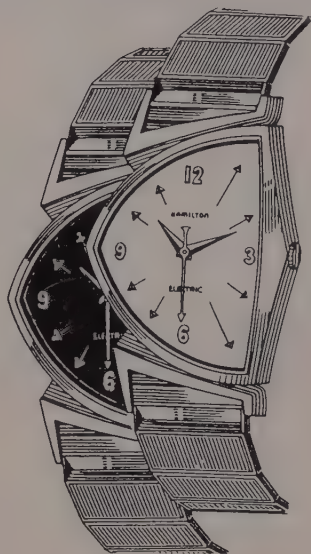

dials, black or silver. However, beyond that there are many subtle variations of the "Pacer" dial and the serious collector can find it challenging and exciting to seek them out. There are some very rare, authentic versions including blue or gray, and there are many different corporate logo dials. The first dials were printed with "Hamilton Electric" in block letters, with a tiny "Pat. Pending" marking below 6 o'clock. After the introduction of the Model 505 the markings were changed, with a new "H" logo, italic "Hamilton," and script "Electric." Patent Pending was removed. Some original dials have lines which extend from 10 to 4 and 8 to 2, crossing in the center. This pattern is fairly scarce.

There are probably more inaccurate dials found on "Pacers" than any other Hamilton Electric. Dials and movements have often been changed over the years, so it is common to find "Ventura" dials, or 505-style dials with Model 500's or vice-versa. Also, many refinished "Pacer" dials have inaccurate markings, notably the electronic resistor symbol from the "Ventura." No original "Pacer" dials were made with this marking. With this model, a close examination of the dial is called for.

The "Pacer" is one of the few Electrics that can be found with either the Model 500 or Model 505 movements. Those made between 1957 and early 1961 have either the 500 or 500A, while all later examples were sold with the superior Model 505.

For the first five or six years the "Pacer" case was manufactured by S&W (Schwab & Wuischpard) Watch Case Company. These examples require a special ring to position the movement. Later cases were retooled so that the movement sits in the case back with no movement ring needed. The external appearance of the cases is identical. By the early 1960's the cases were being made by the Star Watch Case Company.

The design of the "Pacer" makes certain parts extremely prone to wear. The gold fill is frequently found to be worn

## THE WATCHES

through at the 'point' on the case back, and the corners of the back are also commonly worn (see page 99). The amount of wear on the average "Pacer" is a clear indication that these watches saw extensive use.



*"Pacers" with corporate logo dials. (See page 144 for other presentation watches.)*

There are also two very scarce variations which turn up from time to time. One is the "Pacer A" or "Pacermatic," which appeared in only one Hamilton catalog, in 1962. This version was fitted with a Swiss-made self-winding mechanical movement, model 667. The dial is marked "automatic" rather than Electric. Most were sold with a silver dial, which is the only version cataloged, however some were originally made with a black dial. This is a very rare "Pacer," which shows that the Electric movement was more exciting to consumers. (If, as is commonly thought, the mechanical automatic movement was more popular, many more "Pacermatics" would have been sold.)

## THE WATCH OF THE FUTURE

The other rare variation is a 14K solid gold "Pacer," made entirely of yellow gold and released on October 29, 1959. This model was produced for presentation only, and was marketed by Hamilton's Awards & Incentives division directly to corporations. It was never cataloged or sold at retail. Most 14K "Pacers" have a dedication engraved on the back, which was done by a special photo-engraving process in the Hamilton factory. General Electric was, not surprisingly, a particularly important purchaser of Hamilton Electrics. Many of the 14K "Pacers" have GE dials, although this dial is also common on gold-filled models.

Many watch collectors who are not specialists in Hamilton Electrics like to have one example of this pioneering watch in their collection, and the "Pacer" is an obvious choice. The styling is typical of the avant-garde Electric series and the cost is still very modest.



*"Sherwood Pacer" with original mahogany dial. This is a rare prototype; Hamilton released several mechanical watches with wood dials in 1961, but no Electric "Sherwood" watches were marketed.*

## "VAN HORN"

Release Date: January 3, 1957

Retail Price: \$175

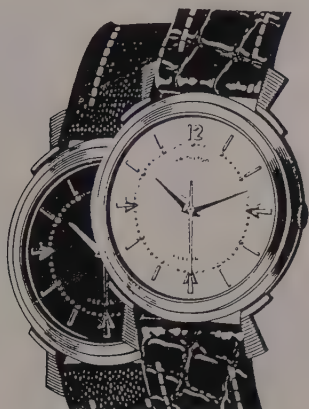

When Hamilton introduced the first Electric watch in 1957, the only models available were the "Van Horn" and the "Ventura." While the "Ventura" was made with a radically styled case meant to announce its difference from ordinary watches, the "Van Horn" was a concession to the more conservative watch buyer.

Named for Dr. John Van Horn, Director of Research and Development at Hamilton, the "Van Horn" was a handsome design with a 14K gold waterproof case with flared lugs. It was sold with either a black or silver dial, priced at \$175. A diamond dial option was offered later, with 12 small diamonds on a black or silver dial. This model cost \$300, a sizeable sum for the time. Export models in 18K yellow or rose gold were also produced; the yellow was introduced on October 7, 1958, and the rose on June 4, 1959. The "Van Horn" was discontinued in 1961, before the Model 505 was released.

*"Van Horn" with 12-diamond dial.*

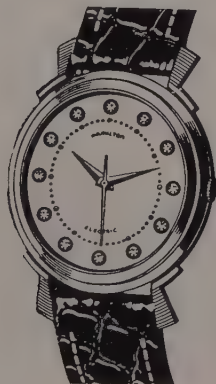

## THE WATCH OF THE FUTURE

### "SPECTRA"

Release Date: July 25, 1957

Retail Price: \$150

The "Spectra" was the third watch in the original Electric series, announced to the public even before it was available for sale. When the first Electric catalog was published the "Spectra" was listed with "price to be announced." The price was ultimately set at \$150.

The case blends a conventional round shape with a modern asymmetrical touch. The radiating lines on the dial expand outward from the 6 o'clock position, leading perfectly into the thick and



## THE WATCHES

broad shape of the upper case. It was available with either black or silver dial in a heavy 14K gold waterproof case. Like the "Ventura," the "Spectra" was also made in 18K gold for export. The 18K yellow gold model was introduced on October 7, 1958, and the 18K rose gold version was released on June 4, 1959.

The "Spectra" was discontinued before the Model 505 was introduced, but the case styling was not abandoned. With a restyled dial and a gold-filled case, it was reissued as the "Saturn."



A black and white advertisement for the Hamilton Spectra Electric Watch. The top half features two watches: one with a white dial and one with a black dial, both with intricate, concentric line patterns on the dials. The watches are set against a background of overlapping, curved lines that create a sense of depth and motion. Below the watches, the text reads: "HAMILTON PRESENTS THE WORLD'S FIRST Electric Watch". The word "Electric" is written in a large, elegant cursive font. At the bottom, it says "SPECTRA . \$150.00 . . . White Dial or Black Dial". A small line of text at the very bottom reads "Price includes Federal Tax, U.S. and Foreign Patent Pending".

HAMILTON PRESENTS  
THE WORLD'S FIRST  
*Electric Watch*  
SPECTRA . \$150.00 . . . White Dial or Black Dial  
Price includes Federal Tax, U.S. and Foreign Patent Pending

## THE WATCH OF THE FUTURE

### "SATURN"

Release Date: June 14, 1960

Retail Price: \$115

Baby brother to the "Spectra," the "Saturn" used the same case design but was made only in 10K gold-fill. Originally offered in either yellow or white gold-fill, the yellow gold model was produced for only a few months. There are several configurations of dial colors. Black center with yellow or white chapter ring, silver or gold center with black chapter ring, and all silver are among the styles produced.

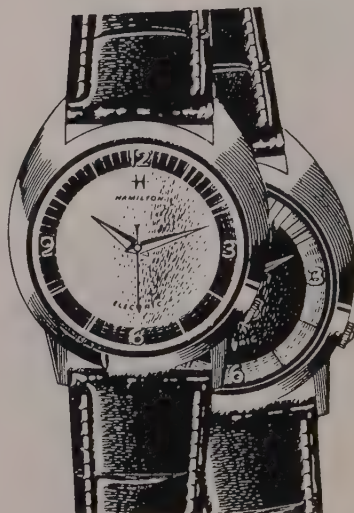

### "REGULUS"

Release Date: December 3, 1958

Retail Price: \$100

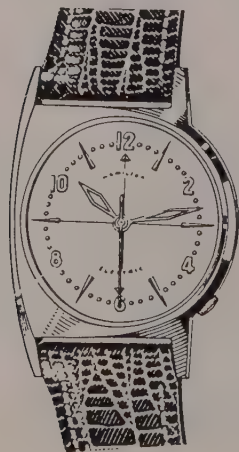

This is a rare Electric with a unique half-square, half-round shape. The case is waterproof stainless steel, and it is fitted with the Model 500 movement. It was only made for about a year and is difficult to find today. A variation of the "Regulus" was also sold, with a self-winding mechanical movement.



## THE WATCHES

### "TITAN"

Release Date: December 1, 1957

Retail Price: \$110 (metal band), \$95 (leather strap)

The original "Titan" was introduced as a less expensive version of the "Van Horn." The case is identical, but it was produced only in 10K yellow gold-fill. It was available with either a silver or black dial, which has different markers than the "Van Horn," and was priced at \$95. It was discontinued by 1959. The "Titan" case was first used in 1956 for the test prototypes described in Chapter 5.

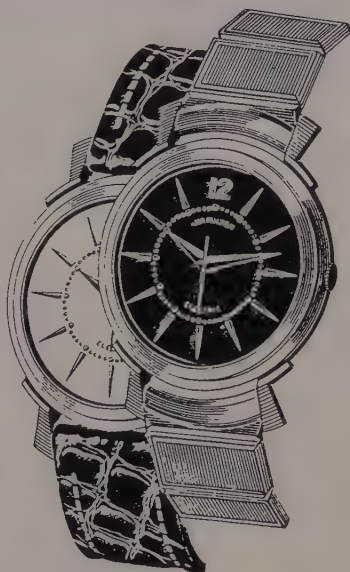

### "VANTAGE"

Release Date: December 9, 1958

Retail Price: \$95



The "Vantage" is striking for a square watch, thanks to the hooded lugs and television-shaped bezel. It was produced in 10K yellow gold-fill with either a black or white dial. Curiously, a 18K rose gold version was produced for export starting on October 28, 1960.

## "ALTAIR"

Release Date: December 15, 1961

Retail Price: \$125 (metal band); \$110 (leather strap)

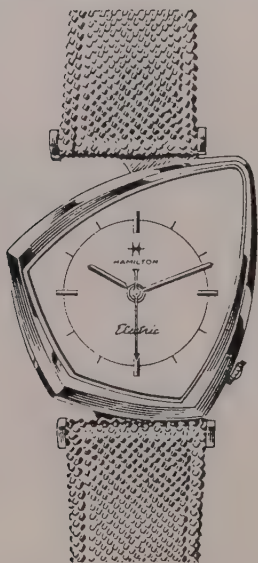

This strikingly unusual model is by far the rarest of all Hamilton Electrics. Often called the 'tomahawk' by collectors and dealers unfamiliar with its true name, the "Altair" was made only in 10K yellow gold-fill with a Model 505 movement and silver dial. It was offered with a mesh metal band or a brown alligator strap.

It is not known exactly how many "Altairs" were made, but it is clear that it had the smallest production run of any Electric watch. Paul Franken-

feld, a Hamilton design manager who was responsible for product specifications and case procurement, recalls that only one order was ever placed for "Altair" cases. Typically, 500 units constituted a normal order for gold-filled cases. While this figure is unconfirmed it is plausible given the few examples which are available today.

Even by today's standards the "Altair" is extremely avant-garde, so it is not hard to imagine how dramatic, if not downright bizarre it must have appeared to the 1960's consumer. The aggressively asymmetrical design was not, however, the principal reason that it was a market failure. The problem was that the detached lugs are very weak and were all too easily bent and broken in normal wear. It is extremely rare to find an "Altair" today which does not show some evidence of damage where the lugs attach to the case. There was also no

## THE WATCHES

provision made for snapping open the case, so the watches frequently have marks on the side from careless opening.

The dial has a round center portion which is brushed radially from the center. The outer portion is brushed in a straight pattern pointed towards 1 o'clock. The effect is quite striking as the light reflects differently on the two portions, giving alternating light and dark gray effects.

Most "Altairs" were sold with straight baton hands as illustrated in the catalog picture, however the factory specifications indicate that long dauphine hands were used as well. Both styles are therefore original.

The "Altair" is a must for any collection of Hamilton Electrics. It is curiously symbolic of the best and worst of these special watches: daring, striking, far ahead of its time, yet fundamentally flawed.



## "VEGA"

Release Date: June 13, 1961

Retail Price: \$110 (metal band only)

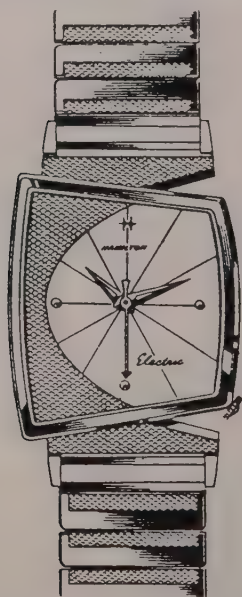

The "Vega" is a very scarce and attractive asymmetrical Electric. First offered in 1961, it was discontinued within only two years. The design is unique, with a cross-hatched motif on the lugs sweeping across the dial of a trapezoidal-shaped 10K yellow gold-filled case. It was offered only with a gold-filled metal band which carried the design around the wrist, making it the most coordinated of all the eccentric designs. The "Vega" can be found with normal gold dauphine hands, or hands with

black insets. Both are authentic. This model is one of the most popular designs among today's collectors. It is rare to find the "Vega" with its original metal band.

## THE WATCHES

### "METEOR"

Release Date: June 1, 1960

Retail Price: \$125 (metal band); \$110 (leather strap)

Another very desirable Hamilton Electric, the "Meteor" was available for only two years. It is one of the most unique styles, with a "meteor's tail" trailing off at 7 o'clock. Produced only in 10K yellow gold-fill, the "Meteor" was offered with a block-style metal band or a leather strap. It is usually found with a two-tone dial with a gold center surrounded by black, which is the only cataloged version. However, it was also made with other dial variations, including brushed silver, brushed gold, and silver surrounded by gold. These variations are extremely rare.



Three variations of the "Meteor" dial: black and gold, gold and silver, and silver.

## THE WATCH OF THE FUTURE

### "EVEREST"

Release Date: February 27, 1958

Retail Price: \$110 (metal band); \$100 (leather strap)

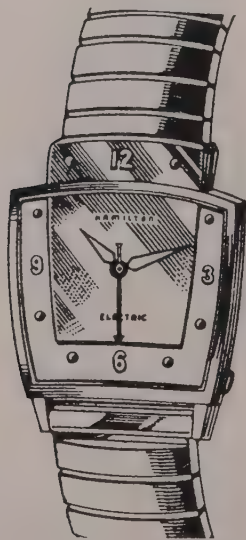

The "Everest" is unquestionably one of the most striking watches in the Electric series, and it remains among the most popular. The design creates an optical illusion, with the dial appearing to break out of the case itself. The bright polished gold center leads into the top bezel, which carries hour markers matching the dial. The "Everest" is most often found with the Model 500 movement, but it was also made with the Model 500A and 505. The hands on the earliest models were gold with radium centers. The effect was perhaps too subtle when seen

against the gold dial, so the hands were changed to radium-filled black. The "Everest" is highly collectible and is currently one of the most undervalued of the entire series.

## THE WATCHES

### "CONVERTA"

Release Date: August 19, 1958

Retail Prices:

CONVERTA I: \$140 (metal band); \$125 (strap)

CONVERTA II: \$130 (metal band); \$115 (strap)

CONVERTA III: \$115 (metal band); \$100 (strap)

CONVERTA IV: \$110 (metal band); \$95 (strap)



Hamilton released four models with the "Converta" name in 1958. There were three different dial configurations available in the series, but otherwise the four "Converta" models differed only in the bezel. All have waterproof stainless steel cases, and three have gold bezels. On "Converta I" the bezel is 18K yellow gold; "Converta II" has a 14K yellow gold bezel; and on "Converta III" the bezel is 10K yellow gold-fill. "Converta IV" is made entirely of stainless steel.

## "VICTOR"

Release Date: May 27, 1957

Retail Price: \$100 (metal band); \$89.50 (leather strap)

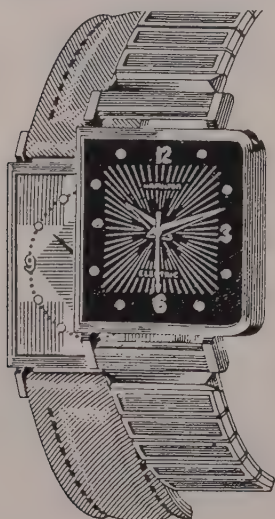

Hamilton released the "Victor" as an inexpensive Electric watch, priced at \$89.50 as opposed to \$200 for the "Ventura" and \$175 for the "Van Horn." The "Victor" has a 10K yellow gold-filled case with off-center lugs and the crown at 1 o'clock. The first "Victor" had a silver dial with a unique diamond pattern made of thin black lines, and a pearled minute track. A black dial version

was offered later, with a starburst pattern. After a few months the white dial was changed to match the existing black dial design, making the original white dial model very scarce. The "Victor" was available with either a leather strap or metal band.





## THE WATCHES

### "POLARIS"

Release Dates: June 30, 1960 (14K yellow gold)  
April 30, 1962 (14K white gold)  
November 10, 1962 (18K rose gold)  
Retail Price (14K): \$150



The "Polaris" is an attractive watch with understated eccentricity. Except for the bow at the bottom, the case is not particularly dramatic. The "Polaris" was available in either yellow or white 14K gold with a brushed silver dial and gold markers. The crystal is an inverted teardrop, conforming to the indentation at the bow. A diamond dial version was also available, the "Lord Lancaster E."

### "POLARIS II"

Release Date: February 1, 1965  
Retail Price: \$150

The "Polaris II" is a waterproof version in one piece case. The hands and dial markers were changed, and the case was modified slightly to accommodate a round crystal.



## "SAVITAR"

Release Date: June 13, 1961

Retail Price: \$175



The "Savitar" was originally released in 14K yellow gold with a brushed silver dial. Although the triangular case is unconventional, the round dial keeps it from looking too avant-garde.

## "SAVITAR II"

Release Dates: January 20, 1965 (white gold-fill)  
November 17, 1965 (yellow gold-fill)

Retail Price: \$125 (metal band); \$110 (leather strap)

The "Savitar II" was a 10K gold-filled version of the "Savitar," in a waterproof case. Both white and yellow gold-filled version were offered. Except that it lacks the reeding around the dial and the hands and markers are slightly different, the "Savitar II" looks essentially similar to the earlier model.



## THE WATCHES

### **"VICTOR II"**

Release Date: December 15, 1961

Retail Price: \$120 (metal band); \$110 (leather strap)

Like several other models with the suffix "II," the "Victor II" is completely unrelated to the original "Victor." The case is fairly elegant for an asymmetrical model, resembling a football tilted slightly to the side. The covered lugs and angled lines complement the rotated dial. It was manufactured in 10K yellow gold-fill with a brushed silver dial and gold markers.

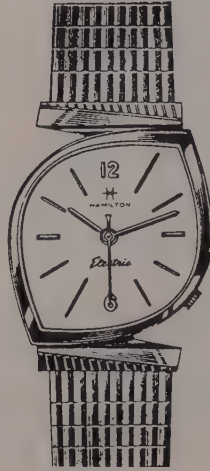

### **"SUMMIT II"**

Release Date: June 9, 1964

Retail Price: \$115



This is a surprisingly scarce watch, with an unusual diamond-shaped dial and textured case. It was not a popular model and was quickly withdrawn.

THE WATCH OF THE FUTURE

**"SEA-LECTRIC I"**

Release Date: June 9, 1958

Retail Price: \$110 (metal band); \$100 (leather strap)

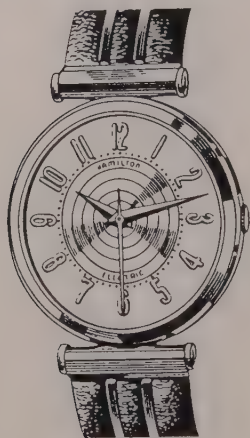

The "Sea-Lectric I" is one of the more appealing round models, with detached lugs and a white dial with a series of concentric circles.

**"SEA-LECTRIC II"**

Release Date: June 9, 1958

Retail Price: \$100 (Metal band); \$89.50 (Strap)



**"SEA-LECTRIC II-B"**

Release Date: November 28, 1962

The "Sea-Lectric II" and "II-B" look essentially similar, with waterproof stainless steel cases which differ only in their construction. The "II" has a screw-back case, while the "II-B" has a one-piece case which opens through the crystal. Both were available with either white or gray dials.

## THE WATCHES



**"TITAN II"**

Release Date: December 15, 1961  
Retail Price: \$125



**"TITAN III"**

January 8, 1964  
Retail Price: \$125

These three watches bear no resemblance to the original Titan. With its coordinated metal band and detached lugs, the "Titan II" appears to float between the ends of the band. The "Titan III" is stylistically similar except that instead of floating lugs the band is attached to fork-like lugs extending from the case. The "Titan III" was sold with a matching metal band, and was available in either yellow or white gold-fill. The original crystal for the "Titan III" is faceted around the inside diameter, giving it a sparkling quality. A diamond dial version was marketed as "Lord Lancaster J." The "Titan IV-B" was one of the last Hamilton Electrics and the most expensive ever sold. The integrated mesh band and case were made of 14K yellow gold. Like the "Titan III," the crystal is faceted.

**"TITAN IV-B"**

Release Date: April 22, 1966  
Retail Price: \$400



THE WATCH OF THE FUTURE

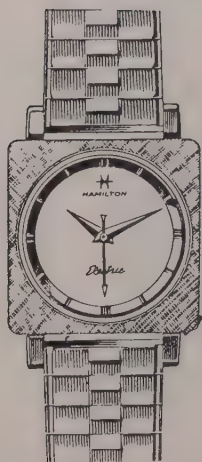

**"SPECTRA II"**

Release Date: June 20, 1963

Retail Price: \$110



**"SUMMIT" (14K gold)**

Release Date: October 25, 1960

Retail Price: \$175



**"REGULUS II"**

Release Date: April 3, 1962

Retail Price: \$89.50



**"TAURUS"**

Release Date: January 15, 1962

Retail Price: \$110

THE WATCHES



**"URANUS"**

Release Date: July 21, 1959  
Retail Price: \$110



**"VELA"**

Release Date: April 22, 1966  
Retail Price: \$115



**"CENTAUR"**

Release Date: July 10, 1965  
Retail Price: \$125



**"SKIP JACK"**

Release Date: Dec. 15, 1961  
Retail Price: \$79.50

THE WATCH OF THE FUTURE



**"LORD LANCASTER E"**

Release Date: May 16, 1963

Retail Price: \$250

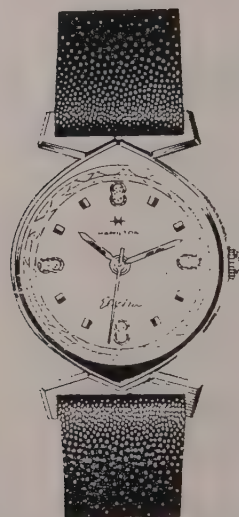

**"LORD LANCASTER J"**

Release Date: April 8, 1965

Retail Price: \$175

Hamilton produced four diamond dial Electric watches, two of which were given special names. (The "Ventura" and "Van Horn" diamond versions were offered under their original titles.) The "Lord Lancaster E" was the name given to the 14K yellow or white gold "Polaris" with 12 small diamond markers. It was fitted with a suede/brocade strap. The "Lord Lancaster J" designated the white gold-filled "Titan III" with four bar markers consisting of two diamonds each at 12, 3, 6, and 9 o'clock. Both are scarce.



## THE WATCHES



**"RR SPECIAL 50"**

Release Date: September 7, 1962

Retail Price: \$89.50



**"RR SPECIAL 51"**

September 7, 1962

Retail Price: \$100

These three Electric watches were 'railroad approved.' All had a special regulator fitted to the balance bridge for close calibration and non-reflecting dials with full markings. They differed only in their case materials: number 50 was made of stainless steel, 51 was stainless steel with a 10K yellow gold-filled bezel, and 52 had a 10K yellow gold-filled case. "RR Special 52" can also be found with a matching gold dial. All were available with either a metal band or leather strap.



**"RR SPECIAL 52"**

Release Date: November 27, 1963

Retail Price: \$110

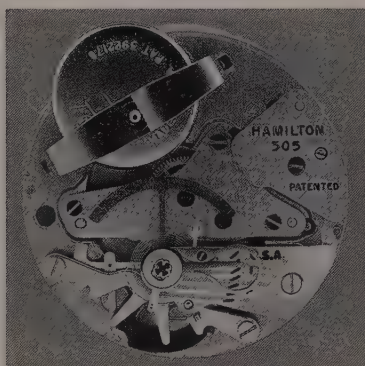

*"RR Special" movement  
with fixed regulator*

THE WATCH OF THE FUTURE

**"CLEARVIEW"**

Release Date: February 18, 1965

Retail Price: \$100



The "Clearview" model is very similar in appearance to the "RR Special 51," with a large stainless steel case and a gold-filled bezel. It was available with either a black or white dial. The "Clearview" is distinguished by its display back; a beveled-edge plastic crystal is fitted into the waterproof screw-back, allowing the normal Model 505 movement to be viewed

in action. This is one of the scarcest and most unusual models in the Electric series.

*The "Clearview" has a display back to view the movement.*



THE WATCHES

**"AQUATEL"**

Release Date: June 15, 1961

Retail Price: \$110

**"AQUATEL B"**

Release Date: August 15, 1962

Retail Price: \$110



The two "Aquatel" watches look identical from the front, differing only in the construction of the case. The earlier model has a screw-back, while the "B" has a one piece case which opens from the crystal.

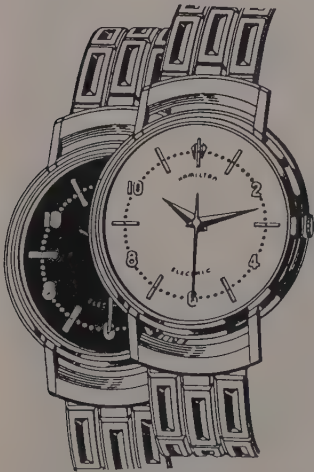

**"ATLANTIS"**

Release Date: October 17, 1958

Retail Price: \$110

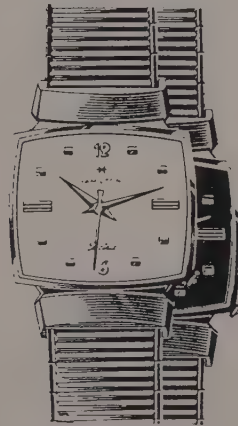

**"EVEREST II"**

Release Date: Dec. 19, 1964

Retail Price: \$99.50

## PRESENTATION WATCHES

In addition to the watches sold by Hamilton retailers, several types of uncataloged presentation watches were also produced. Hamilton had a very active division promoting sales to corporations for incentive and service awards. These special presentation watches (many with custom dials sporting a corporate logo) were not listed in Hamilton catalogs and were not sold through normal retail dealers. The most famous of these presentation watches is the 14K gold "Pacer." Other models were round and simple in styling, but they differ from similar Hamilton Electrics because the cases were often made of solid 10K or 14K gold.

The earliest documented version was given a model name: "Biscayne." This Model 500 watch featured an "Atlantis" dial in a 10K screw-back case. Later models were identified by



*Hamilton presentation watches with corporate logos. See also page 119.*

## THE WATCHES

numbers. For example, for presentation purposes the "Summit" was designated "475." Many of the later Model 505 presentation watches are marked "Masterpiece." Typically such watches have very fine dedication engraving on the cases, which was done at the factory by a special photo-engraving process.

Not all presentation watches were specially cased. Many companies purchased models from retail stock, so corporate logo dials and photo-engraved cases can frequently be found on conventional models.

*Many presentation watches were specially photo-engraved at the Hamilton factory. This example was presented to Hamilton R&D director John A. Van Horn in honor of his fifteenth year with the company.*



THE WATCH OF THE FUTURE



**"GEMINI"**

Release Date: Dec. 7, 1962

Retail Price: \$125

(yellow or white, metal band only)



**"GEMINI II"**

Release Date: Dec. 28, 1964

Retail Price: \$125



**"TRITON"**

Release Date: August 2, 1962

Retail Price: \$85



**"PEGASUS"**

Release Date: May 6, 1965

Retail Price: \$125

## THE WATCHES

### The "NAUTILUS" Series

There are 23 different watches in the "Nautilus" series, not counting variations in dial color. All of the watches were round, and most had matching metal bands. One unusual model was the "403," the only pocket watch Hamilton made with an electric movement. The model numbers give an indication of the metal of the cases: those in the 200 range were made of 14K yellow gold, while the "Nautilus" 400 range were all made of 10K yellow gold-fill (with the exception of "450" which has a gold-filled bezel on a stainless case). The 500 series designates stainless steel models, and watches in the 600 range were made of 10K yellow rolled-gold-plate.



#### "NAUTILUS 200"

Release Date: Dec. 4, 1962

Retail Price: \$160



#### "NAUTILUS 201"

Release Date: August 26, 1964

Retail Price: \$160



#### "NAUTILUS 202"

Release Date: Nov. 28, 1964

Retail Price: \$160

*THE WATCH OF THE FUTURE*



**"NAUTILUS 400"**

Release Date: Dec. 14, 1962

Retail Price: \$115



**"NAUTILUS 401"**

Release Date: June 26, 1964

Retail Price: \$125



**"NAUTILUS 402"**

Release Date: Dec. 28, 1964

Retail Price: \$125



**"NAUTILUS 403"**

Release Date: Dec. 8, 1965

Retail Price: \$130



THE WATCHES



**"NAUTILUS 404"**

Release Date: May 31, 1964

Retail Price: \$125

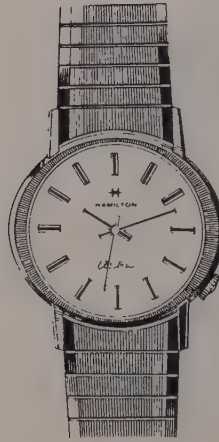

**"NAUTILUS 405"**

Release Date: April 22, 1966

Retail Price: \$125



**"NAUTILUS 450"**

Release Date: Feb. 28, 1963

Retail Price: \$110



**"NAUTILUS 500"**

Release Date: Dec. 18, 1962

Retail Price: \$79.50

THE WATCH OF THE FUTURE



**"NAUTILUS 501"**

Release Date: Dec. 18, 1962

Retail Price: \$89.50



**"NAUTILUS 502"**

Release Date: Jan. 8, 1964

Retail Price: \$89.50



**"NAUTILUS 503"**

Release Date: Jan. 5, 1964

Retail Price: \$79.50



**"NAUTILUS 506"**

Release Date: Apr. 7, 1965

Retail Price: \$89.50

THE WATCHES



**"NAUTILUS 507"**

Release Date: May 5, 1966

Retail Price: \$99.50

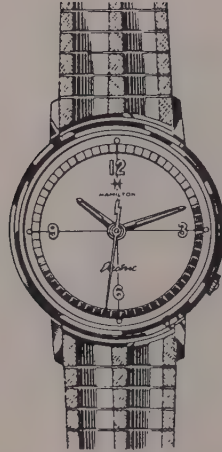

**"NAUTILUS 508"**

Release Date: Dec. 8, 1962

Retail Price: \$79.50



**"NAUTILUS 509"**

Release Date: Apr. 22, 1966

Retail Price: \$89.50

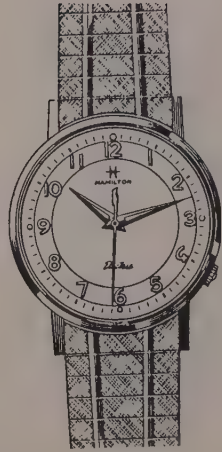

**"NAUTILUS 600"**

Release Date: Dec. 14, 1962

Retail Price: \$110

THE WATCH OF THE FUTURE

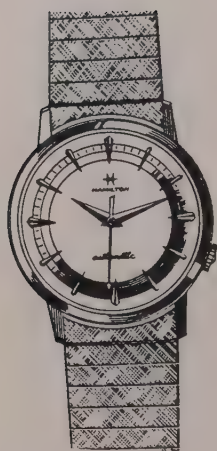

**"NAUTILUS "601"**  
Release Date: July 25, 1963  
Retail Price: \$110



**"NAUTILUS 602"**  
Release Date: April 8, 1965  
Retail Price: \$115



**"NAUTILUS 604"**  
Release Date: April 28, 1965  
Retail Price: \$115

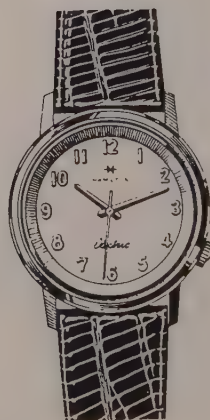

**"NAUTILUS 605"**  
Release Date: Nov. 17, 1965  
Retail Price: \$99.50

## THE WATCHES

### *"FLIGHT I" and "FLIGHT II"*

Technically, these two watches do not belong in this volume because they are mechanical rather than Electric. However, because the styling is so similar to the Electric series their inclusion seems appropriate. They are also among the most desirable watches among collectors.

The design of the Flight I and Flight II is typical of the "forward look" which was meant to imply motion. A similar motif was used in the logo of the Chrysler Corporation.

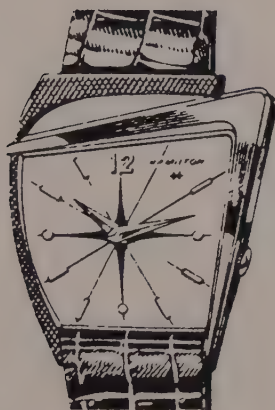

***"FLIGHT I"***

**Retail Price: \$175**

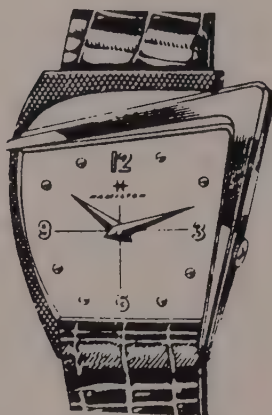

***"FLIGHT II"***

**Retail Price: \$95**

Introduced in late 1960, the "Flight I" was made of solid 14K gold, with a radially brushed silver dial bearing a brown cross in the center and the Hamilton logo at 1 o'clock.

The "Flight II" was produced in 10K gold-fill and was released at the same time as the "Flight I." It was originally offered with a gold ("champagne") colored dial with crossed black lines and the logo at 12 o'clock. A silver dial version was offered shortly thereafter; it is scarcer than the gold dial. Both models were fitted with a high quality 22-jewel movement.



# Appendices

## Step 1

Check condition of gold tab as follows:

Examine the gold tab for uprightness in relation to balance staff. The gold tab may not lean to either side but may be slightly tilted toward the balance staff. The gold tab can easily be straightened with tweezers. The tab is quite soft and caution must be exercised when making adjustments.

## Step 2

Check the contact and trip springs (fig. 1) for proper level and clearance as follows:

- A. Sufficient clearance at point "A" between top of the box and hairspring.
- B. Sufficient clearance at point "B" between top of box and contact spring.
- C. Sufficient clearance at point "C" between contact spring and top of trip jewel.
- D. Sufficient clearance at point "D" between trip spring and balance, so that the coil and gold strip will clear, as they pass under the trip spring.

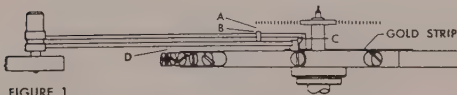

FIGURE 1  
Checking level and clearance of the contact and trip spring.

To adjust the contact and trip springs for proper level and clearance, the posts to which these springs are attached can be bent. You will notice in the watch that both posts have been grooved to weaken them, so that they will bend easily at the weakened points.

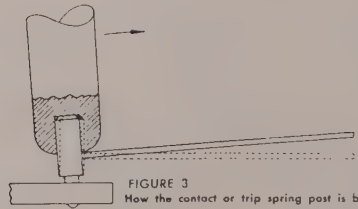
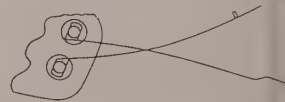

FIGURE 3  
How the contact or trip spring post is bent to level a spring

## Step 3

Check for a bow in the contact or trip spring

In Fig. 4 we show the unstressed form of the contact and trip springs. You will notice that these springs have quite a curve in them. The location and form of the curves are such, that as the springs are made to exert a pressure against one another, they will be relatively straight.



Unstressed contact and trip spring.

FIGURE

In Fig. 5, 6, 7, and 8 we show contact and trip spring that are in good condition and will therefore function satisfactorily in the watch. However, a bow in the springs such as shown in Fig. 9, is unacceptable, and must be straightened.

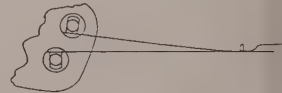

Good — Contact and trip spring are straight.

FIGURE

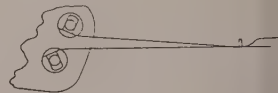

Good — Springs straight but bent inward close to posts.

FIGURE

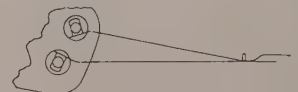

Good — Springs straight but bent outward close to posts.

FIGURE



## APPENDIX 1



FIGURE 8

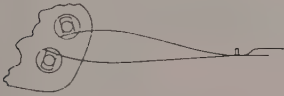

FIGURE 9

### *Straighten a spring that is bowed*

In Fig. 10 we show the method used to straighten a spring that is bowed. This is done by turning the tweezers ever so slightly and sliding it along the spring as illustrated. This method of bending a spring prevents any sharp bends or kinks from occurring. When performing this operation, keep the tweezers upright, so that a twist will not occur in the springs.

When making other adjustments to the contact system, the springs may become bowed again. If this occurs, immediately straighten them as the springs at all times must be kept straight.



FIGURE 10

## Step 4

### *Check for proper lap of contact button over gold tab*

Hold the watch with the stem to your left. The contact system and balance will then appear as illustrated in Fig. 1, page 2. Turn the balance counterclockwise to bring the contact button, Fig. 11, in contact with the gold tab. At the instant the button makes contact with the gold tab, stop the balance and observe how much of the button laps over the gold tab. At the instant of contact,  $\frac{3}{4}$  to  $\frac{7}{8}$  of the button should be over the gold tab as illustrated. If more than  $\frac{3}{4}$  or less than  $\frac{3}{4}$  of the button laps over the gold tab at this time, the post to which the contact spring is affixed must be turned to correct this

condition. You will notice that the contact spring is affixed to the side of the post. See Fig. 12. Due to this, the turning of the post will give the same effect as that of shortening or lengthening the spring. In this illustration we show the effect of turning the post in a clockwise direction. Notice how the spring is moved back from position "A" to "B", thus giving the same effect as that of shortening the spring. Naturally the turning of the post counterclockwise will give the opposite effect.

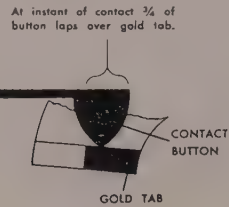

FIGURE 11

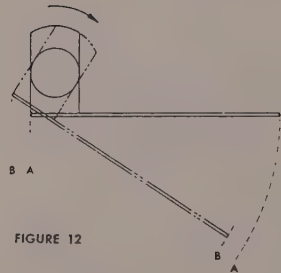

FIGURE 12

It is important to remember that the only time the contact post is to be turned is when the contact button does not properly lap over the gold tab at the instant of contact. There is no other reason for ever turning the contact post.

When turning the contact post, the contact pressure will be changed somewhat. Therefore, after turning the contact post, the contact pressure must be rechecked and a correction made if necessary. As explained in Step 5, the contact pressure is adjusted by bending the contact spring with tweezers close to its post.

## THE WATCH OF THE FUTURE

### Step 5

#### Check contact pressure

Turn the balance 90 degrees counterclockwise from its rest position. This places the gold tab and trip jewel in the relative position shown in Fig. 14. Now with a needle or broach, move the trip spring away from the contact spring until the two springs slightly separate. (For this operation the needle should not be placed close to the base of the spring, as this would permanently bend it.) The contact spring, being completely free of the trip spring, is now unstressed. For proper contact pressure, the end section of the unstressed contact spring should be near the edge of the index hole jewel as illustrated.

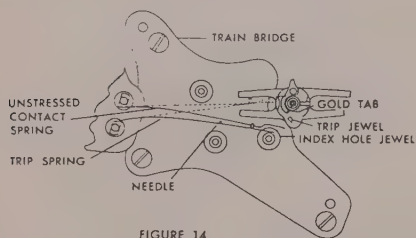

FIGURE 14

There is, however, an acceptance range in regard to the unstressed position of the contact spring. Actually, if the position of the unstressed contact spring is anywhere between the minimum and maximum positions, as shown in Fig. 15, the contact pressure will be satisfactory.

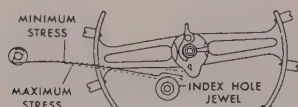

FIGURE 15

If the unstressed position of the contact spring is not within the acceptable range, then the contact pressure will be unsatisfactory. To adjust the contact pressure, the contact spring must be bent. To do this, grip the contact spring close to its post with tweezers and bend the spring in the proper direction. To bend the contact spring, do not just push or bump the side of the spring close to the post, as this will not make a permanent bend. Experience has shown that unless a definite bend is made in the spring with tweezers, it will have a tendency to creep back out of adjustment.

**Caution:** The contact roller is set to its proper position on the balance wheel at the factory. It is positioned so that the trip jewel is 90 degrees from the balance bars. Do not change the position of the contact roller, as certain adjustments to the contact mechanism depend upon the contact roller being in its proper position. Also, any moving of the contact roller may break loose the cement that insulates and holds the gold strip in place.

### Step 6

#### Check trip spring pressure

As you will see later, it would be a waste of time to attempt at this point to set the trip spring pressure accurately. That will be done later. For the present, the trip spring pressure should be such that the contact mechanism will function and nothing more. In Fig. 16 and 17 we show two unsatisfactory conditions due to the trip spring pressure being incorrect. In Fig. 16 we show the trip jewel butting on the end of the trip spring. This is caused by the trip spring exerting too great a pressure against the contact spring. In Fig. 17 we show the gold tab butting on the end of the contact spring. This condition is the result of the trip spring exerting an insufficient pressure against the contact spring. For the present, any position of the springs between the positions shown in Fig. 16 and 17 will be satisfactory.

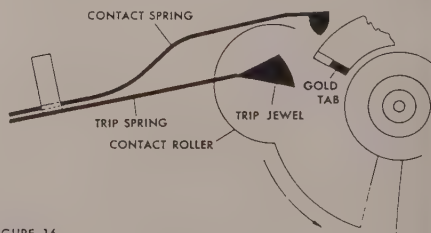

FIGURE 16

Trip spring pressure too strong. Trip jewel butts on end of trip spring.

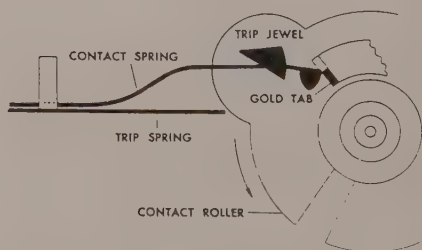

FIGURE 17

Trip spring pressure too weak. Gold tab butts on end of contact spring.

## APPENDIX I

To adjust the trip spring pressure, the trip spring must be bent close to its posts with tweezers. Again we caution against bumping the spring close to the post, as this will not make a permanent bend. Always make a definite bend in the spring with tweezers and the result will be lasting.

**Important:** When making other adjustments to the contact system, a condition such as (or similar to) those shown in Fig. 16 and 17 may be created. If this occurs, the trip spring pressure must be adjusted to correct the condition. Keep in mind that the proper trip spring pressure must be maintained at all times to keep the springs within the range in which they can function.

### Electrical Circuit – make & break

The make and break of the electrical circuit must occur at precisely the correct time, so that the coil when energized will be in its proper position over the permanent magnets. In Fig. 18, we show the position of the coil over the permanent magnets at the instant the electrical circuit is completed, and the coil is energized. In Fig. 19, we show the position of the coil over the permanent magnets at the instant the circuit is broken, which naturally ends the impulse. From the make of electrical contact, Fig. 18, to the break in the electrical circuit, Fig. 19, the balance turns  $22\frac{1}{2}$  degrees.

The position of the coil over the permanent magnets during the time the coil is energized is extremely important.

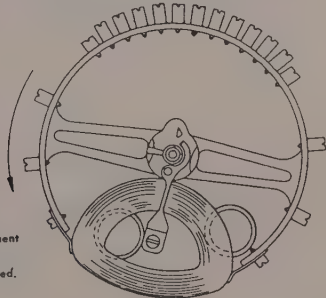

FIGURE 18  
Approximate position of the coil over the permanent magnets at the instant the electrical circuit is completed.

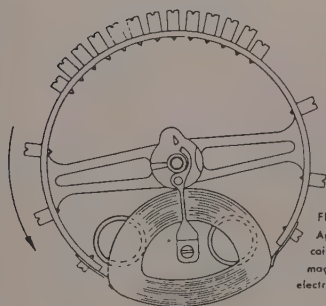

FIGURE 19  
Approximate position of the coil over the permanent magnets at the instant the electrical contact is broken.

To be reasonably accurate in checking this, we will use the balance screw holes as markers, and the trip spring as an indicator. For this purpose you will notice that we have numbered the grouped screw holes in the balance. See Fig. 20. These screw holes are  $7\frac{1}{2}$  degrees apart. We will begin by checking the break in the electrical contact.

### Step 7

#### Check the break in electrical contact

The break in the electrical contact should occur when the trip spring is directly over the third screw hole as shown in Fig. 20. Notice in this illustration that the trip jewel is at a point where any further turning of the balance counterclockwise will break the electrical contact.

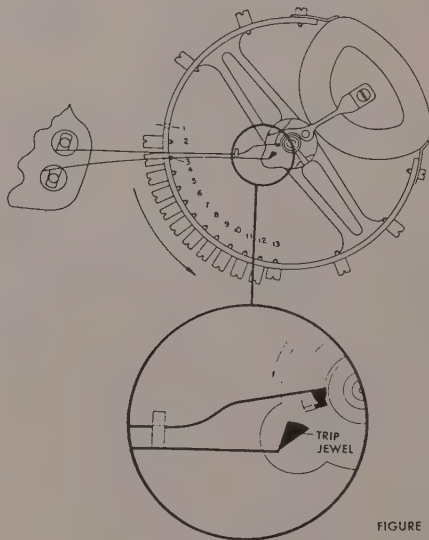

FIGURE 20

The position of the trip spring over the 3rd screw hole at the instant the circuit is broken must be checked very accurately. To do this, hold the watch with the stem toward you and slightly to the left. Tilt the watch so that you are looking down on the contact system. Now, move the balance slowly counterclockwise and observe when the circuit is broken. When this occurs the trip spring is released by the trip jewel and the deflecting of the trip spring is quite noticeable. Do *not* check the location of the trip spring over the balance screw holes after the

## THE WATCH OF THE FUTURE

spring has been deflected, but by repeating the moving of the balance through contact several times the location of the trip spring over the balance screw holes at the instant the circuit is broken can easily be determined.

In Fig. 21 and 22 we show respectively a late and an early break in electrical contact. In Fig. 21 we show the break in electrical contact occurring after the 3rd screw hole has passed by the trip spring. This indicates that the break in the electrical contact is late. To correct this condition, the trip spring post must be turned counterclockwise.

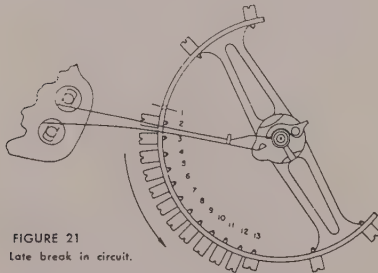

This will decrease the penetration of the trip spring into the path of intersection of the trip jewel, and thereby cause the break in electrical contact to occur earlier. When turning the post counterclockwise, we will in addition be increasing the trip spring pressure. This must be corrected by bending the trip spring close to its post with tweezers. See Step 6. (Fig. 12 illustrates the effect of turning the contact or trip spring post.)

In Fig. 22, the break in electrical contact is about to occur, and the balance has not turned far enough to bring the third screw hole directly under the trip spring. This indicates that the break in contact is occurring early. To correct this condition, the trip spring post must be turned in a clockwise direction. This will give a greater penetration of the trip spring into the path of intersection of the trip jewel, causing the break to occur later.

We must remember that as the post is turned clockwise, the trip spring pressure will be weakened. This can be corrected by bending the trip spring close to its post.

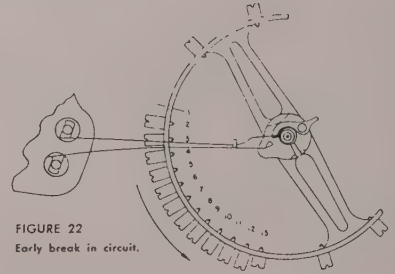

## Step 8

### Check the "Back Pick Up"

As you know, on the clockwise swing of the balance, no electrical contact occurs, and the trip jewel merely trips past the trip spring. This contact of the trip jewel with the trip spring on the clockwise swing of the balance is called "back pick up". To check this, hold the watch with the stem toward you and slightly to the left, so that it is possible to sight in along the right side of the trip spring. Move the balance slowly clockwise until the trip jewel touches the trip spring. Stop the balance at this point and tilt the watch so that you can now look down on the contact system and observe the location of the trip spring over the balance screw holes. The trip spring should now be approximately over the 8th screw hole as shown in Fig. 23. Now, continue moving the balance clockwise until the trip spring is released by the trip jewel. Here again, the trip spring will be deflected slightly when released. When the trip spring is just about to be released by the trip jewel the trip spring should be approximately

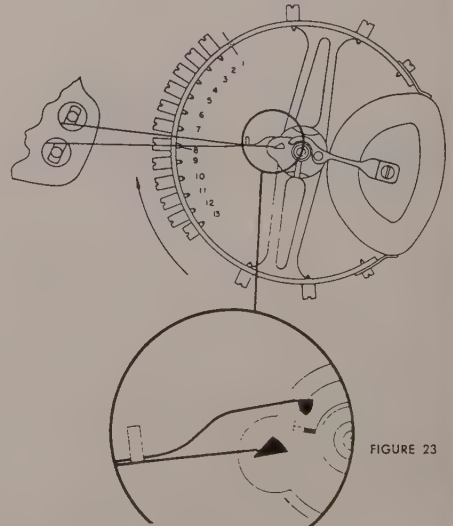

## APPENDIX 1

between the 10th and 11th screw holes as shown in Fig. 24. There should be  $2\frac{1}{2}$  to  $3\frac{1}{2}$  screw holes, or 19 to 27 degrees of back pick up. The back pick up will not always start exactly on the 8th screw hole as shown in Fig. 23 or end between the 10th and 11th screw holes as shown in Fig. 24. However, there must be at least  $2\frac{1}{2}$  or not more than  $3\frac{1}{2}$  screw holes passing under the trip spring from the beginning to the end of the "back pick up" engagement.

The amount of back pick up can be adjusted by increasing or decreasing the trip spring pressure. If the trip spring pressure is too great, the back pick up will be less than  $2\frac{1}{2}$  screw holes. On the other hand, if the trip spring pressure is too weak, the back pick up will exceed  $3\frac{1}{2}$  screw holes.

To adjust the trip spring pressure, the trip spring should be bent close to its post with tweezers. After the back pick up has been adjusted, recheck the break of electrical contact to be sure that everything is still set correctly.

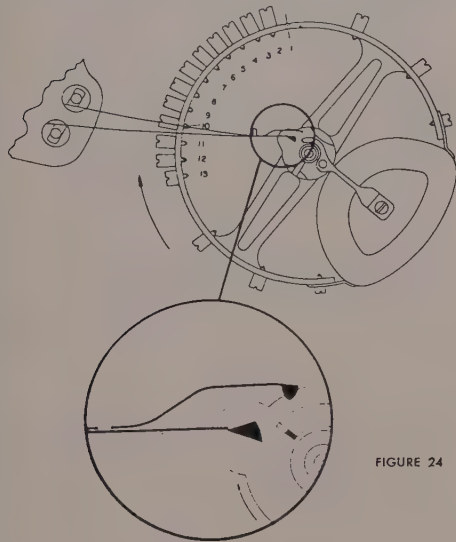

FIGURE 24

### Step 9

#### *Check the make of electrical contact*

At the instant the make of electrical contact occurs, the trip spring should be directly over the 6th screw hole, as shown in Fig. 25. Since it is rather difficult to see exactly when the electrical contact occurs, a 7-power eye loupe should be used.

Later we will show how a multimeter can be used to show the instant the electrical contact occurs. However, if the

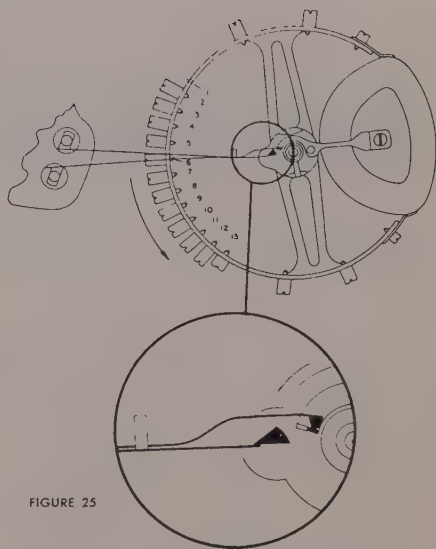

FIGURE 25

watchmaker is careful, he can accurately determine when the electrical contact occurs with the use of a 7-power eye loupe.

It is important to have the make of electrical contact occur at precisely the correct time — that is, at the instant the 6th screw hole is directly under the trip spring. To check this, hold the watch with the stem just slightly to your left and sight in over, or just to the right of the trip spring box. Now, turn the balance counterclockwise slowly and observe the instant the contact button touches the gold tab. As soon as contact is made, stop the balance and observe the position of the trip spring over the balance screw holes. If the make of electrical contact is occurring early, such as shown in Fig. 26, the balance will not have turned far enough to place the 6th screw hole under the trip spring. On the other hand, if the make of electrical contact is late, the 6th screw hole will have passed by the trip spring before the contact button touches the gold tab.

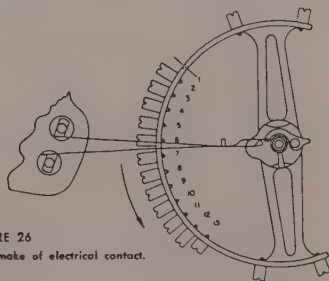

FIGURE 26  
Early make of electrical contact.

## THE WATCH OF THE FUTURE

(Step 9 continued)

To correct an early or late make of electrical contact, the contact spring should be bent slightly just behind the box. A pair of OO overcoil tweezers should be used to bend the contact spring. Fig. 27 shows how the contact spring is bent with overcoil tweezers to correct a late make of electrical contact. Fig. 28 shows how the contact spring is bent to correct an early make of electrical contact.

The make of electrical contact is set so that it occurs when the 6th screw hole is directly under the trip spring. The break in electrical contact is set so that it occurs when the 3rd screw hole is directly under the trip spring. This makes exactly 3 screw holes or  $22\frac{1}{2}$  degrees of electrical contact. It is important to remember never to exceed  $22\frac{1}{2}$  degrees of electrical contact, as this may cause the energy cell to run down in less than a year.

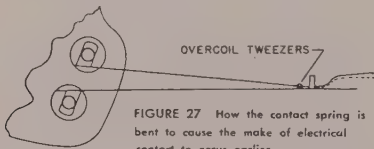

FIGURE 27 How the contact spring is bent to cause the make of electrical contact to occur earlier.

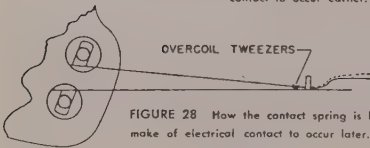
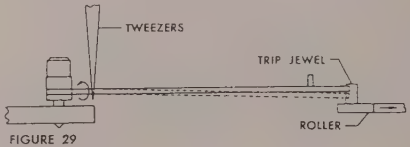

FIGURE 28 How the contact spring is bent to cause the make of electrical contact to occur later.

### Step 10

*Check for a riding contact or trip spring*

As the trip jewel moves the trip spring, there should not be any riding of the trip spring up or down on the trip jewel. A riding trip spring indicates that there is a twist in the spring close to its post. Fig. 29 shows a trip spring that is riding down, which is indicated by the dotted position of the spring. To correct this condition, the trip spring must be bent with tweezers as illustrated. Naturally if the trip spring was riding up, it would be necessary to bend the spring in the opposite direction. Similarly this applies to a riding contact spring.



### Step 11

*Check the motion of the balance*

The minimum motion of the balance should be  $1\frac{1}{4}$  turns in the dial position and  $1\frac{1}{8}$  turns in the pendant positions.

## APPENDIX 2: Model 505 Service Guide

### STEP-BY-STEP PROCEDURE FOR SERVICING THE HAMILTON 505 ELECTRIC

In the "505" the balance is both the regulating standard and the driving force, driving both wheels and hands. Each backward swing moves the hands forward two-fifths of a second, which makes the second hand appear to jump. This is normal. Because

the wheels are moved by the balance, they are known as a floating train—with extremely light pressures against teeth, pinions and pivots. Therefore, in servicing, always look for anything that would prevent the wheels from operating freely.

The following sequence is recommended:

1. **CRYSTAL AND HANDS.** Check for second hand rubbing crystal. Check all hands for interference with dial markers or with each other.
2. **ENERGY CELL.** Replacing the cell is probably the most common service a "505" will require. First, of course, check to see that cell is seated properly. If not, bend clamp (or strap) for firmer contact.

Remove old cell by taking off clamp. Be sure you replace it with a genuine, new, improved Hamilton cell, packaged in a pink envelope. You can identify it in either of two ways: (a) it has a welded metal disc on the negative side and is date-stamped in black, or (b) it has no disc but is date-stamped in red.

Handle the new cell with your fingers, not tweezers. They may "short" the cell and decrease its power. It's a good idea to scratch the date on it, then slip it in place (flat side up) and replace clamp.

How do you know if the cell is good? Easy. If it produces at least  $1\frac{1}{4}$  turns of balance motion in a flat position (dial down), it is good.

Do not use hearing aid batteries. Makers of such cells report that the power is usually gone within 6 months after manufacture, and added precautions are not taken to insure against leakage.

3. **CELL LEAD.** Check at cell end for corrosion from possible cell leakage. If corroded, cell lead should be scraped vigorously and the point stoned lightly.
4. **DIAL AND DIAL TRAIN.** Check for loose dial foot screws. Check hour wheel for proper endshake and freedom. **Never use dial washers!** They add drag and interfere with proper operation. If hour wheel has too much endshake, you can corner or countersink the underside of the minute hand, permitting it to be pressed down over the shoulder of the cannon pinion.

Remove hands and dial. Now, if you find that hour wheel sticks, broach it lightly. Check hour and minute wheels for bent or crushed teeth; change if defective. Then take off cannon pinion.

5. **BALANCE FREEDOM.** Check to insure that balance shock absorber springs are locked. Examine balance for lint, metal chips, hairspring coil sticking or catching in regulator pins—for anything which might interfere with balance motion.

Check green connecting wire to make sure it does not touch shunt bridge above it. If it does, press down with a piece of pegwood—carefully to avoid breaking insulation or connection. **Never touch the coil or green wire with tweezers.**

6. **BALANCE COMPONENTS.**

(a) **STAFF.** Remove balance and check for bent or broken pivots. If staff needs replacing, a complete balance assembly exchange will be provided by Hamilton for only the cost of a staff replacement, about \$2.00. Check balance jewels for oil, dirt or fractures.

(b) **FINGER BLOCK.** The small thin finger on the balance staff between the wheel and roller is the finger block. It prevents excessive motion and double indexing under shock. It must move freely in its narrow slot.

Hold balance wheel in a flat position, by the rim with tweezers. You should see the finger block at the bottom of the slot, resting on the lower collar as shown in Figure 1. Turn balance over and finger block should fall freely, by gravity, to the opposite side of slot and rest on upper collar as shown in Figure 2.

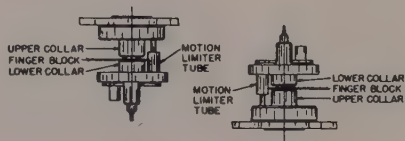

Figure 1

Figure 2

This is a critical point, too frequently overlooked. Don't skip over it hurriedly. A sticky finger block causes very fast rates. If sticky, clean the balance assembly, using a final rinse of isopropyl alcohol or denatured alcohol and drying with heat. If finger block still sticks, use a hand blower. In extreme cases a second rinse may be necessary.

(c) **CONTACT PIN.** Continuing examination of the balance, you will note the contact pin back-to-back to the roller jewel on the roller table. It is of a gold alloy to insure good electrical contact with the platinum contact-wheel teeth. Examine the pin closely from several angles. It may have a wide, clean, smooth groove in it, with a small amount of carbon around the contact area. This is normal wear.

If the gold pin is contaminated or dirty, you will see black deposits around the groove and on the teeth of the contact-index wheel. Clean the pin vigorously with a small glass brush, provided free by Hamilton. Do not use this brush for any other purpose. To clean the contact-index wheel of contamination, carefully roll wheel teeth in a pith block saturated with alcohol.

If the gold pin looks gouged or chewed, the balance should be sent to Hamilton for roller exchange.

7. **TRAIN.** Examine the train for freedom. Push the contact-index wheel lightly with tweezers, one tooth at a time. Teeth are held in position by two small magnets and should position over the center of the magnets. They should snap to each succeeding position. If wheel is sluggish, interference in the train is indicated and it may need cleaning.

Check fourth wheel to insure clearance under train bridge. If not clearing, move fourth wheel jewel.

Remove the train bridge and examine all wheels for rust, bent teeth or bent pivots. Pay particular attention to the gold pivot of the contact-index wheel. Its tip is a fine radius. If excessively flattened or scored, change the wheel.

Look through the contact-index wheel lower jewel and you will see the metal endpiece. It may have a small pit near its center. This is normal and not harmful; do not remove the pit. To clean endpiece, the glass brush may be used.

# THE WATCH OF THE FUTURE

## 8. CLEANING

(a) **MOVEMENT.** Remove cell lead from dial side, being careful not to lose endpiece, insulating washers or insulating strip. The movement may be cleaned with the same solutions you use for other watches, but they should be fresh and clean. Rinse the balance separately in isopropyl alcohol, dry with heat, and use your hand blower in finger block area to make sure it is completely dry and free. The ultrasonic method may also be used to clean all parts of this movement.

(b) **MAGNETS.** Before reassembly, examine the four magnets—two small ones under the contact-index wheel and two larger ones under the balance. They will attract the metal chips left in your cleaning solution, and may look "hairy". Be sure you remove all chips. Cellophane tape is useful here. Touch the sticky side to the tops of the magnets. With tape folded to form a point, wipe chips off sides.

## 9. ASSEMBLY AND OILING

(a) **TRAIN.** Assemble the train in this order: index wheel, center wheel, third wheel (pinion down), fourth wheel. Replace the train bridge. Assemble cell lead on dial side, making sure all insulators are in place. Do not tighten screws. Slip endpiece (flat side down) under tip of cell lead. Tighten screws.

Oil sparingly. The droplet of oil in the balance jewels should be about  $\frac{1}{2}$  the diameter of the endstone. Other jewels and pivots should be barely wet with oil, just enough to keep them from rusting. Hamilton PML 79 oil is recommended. **Never oil lower contact-index jewel.** And, of course, no oil on contact-index wheel or pin.

(b) **BALANCE ASSEMBLY.** Before inserting the balance, observe the finger block. Hold the balance in tweezers, by the rim, with hairspring up and coil toward you. Look down through hairspring at finger block beneath it. Finger block should be pointing toward the coil (as shown in Figure 3) so as to be in proper position, on correct side of guard pin on the train bridge and of the motion limiter tube on the balance. (The green wire passes through this tube).

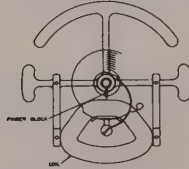

Figure 3

If finger block is not in this position, it may come between the guard pin and tube—and the watch cannot run. While holding balance, lightly tap your tweezers so that finger block will fall, pointing toward the coil. Then place balance wheel pivot in lower balance jewel (stem must be in "running" position so that stop lever is out of way of the balance).

(c) **SHUNT BRIDGE.** When installing shunt bridge, make sure its "horns" are pointed outward. Slide bridge between coil and hairspring, and fasten it. Then place balance cock on the watch. Use shunt bridge to support the stud and manipulate the balance so that stud is under stud hole. It will then enter. Fasten balance cock, raising stud to level the hairspring.

## 10. BEAT POSITION.

To check the beat (energy cell removed), move the balance wheel clockwise with a piece of pegwood. Then allow it to come back gently to rest position. The leading edge of balance arm should stop over fourth jewel (as shown in Figure 4). Anyplace over jewel will do. If it does not stop as shown, turn hairspring collet until this position is obtained. The movement will then be in beat.

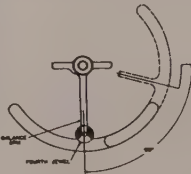

Figure 4



# Index

INDEX

(Bold face denotes illustrations)

- 201 battery: 102  
301 battery: 105  
387 battery: 102  
394 battery: 102  
Alnico 5: 28  
"Altair": 64, 108, 126-127  
"Aquatel": 143  
"Aquatel B": 143  
Arbib, Richard: 59, 62-65  
"Atlantis": 143  
Barber, Eugene: 36, 70  
batteries: 34-36, 51, 53, 101-103  
'beating heart': 36  
Bennett, William: 74  
Biemiller, Philip E: 23, 26, 27, 36,  
41, 43, 46, 47, 48, 79-83  
Biggs Watch Case Co.: 60, 64  
"Biscayne": 144  
Blakinger, Richard: 91  
Bulova "Accutron": 30, 74-76, 102  
calendar watch: 89-92  
"Centaur": 139  
Chrysler Corp.: 153  
"Clearview": 142  
cobalt-platinum magnets: 42, 43  
"Converta I": 131  
"Converta II": 131  
"Converta III": 131  
"Converta IV": 131  
'cordless clock': 89-92  
electromagnetic watch: 30-33 (31)  
Enders, Ray: 23  
D-pin: 105  
Demmy, R.C.: 32  
'Electric Watch Marketing  
Committee': 48, 91  
Elgin Watch Co.: 22, 25, 26, 28  
'EM-1': 31, 32-33  
"Everest": 75, 130  
"Everest II": 143  
Eveready: 101-103  
Fedor, Steve: 59  
Fillinger, Arthur E.: 15-17  
Fillinger prototype: 16, 18  
"Flight I": 153  
"Flight II": 153  
Frankenfeld, Paul: 120  
'Garry Moore Show': 55  
"Gemini": 146  
"Gemini II": 146  
General Electric: 43, 119, 120  
"HARNILTON": 73  
Hartman, R.V.: 39-41  
Hendricks, John: 17  
Henlein, Peter: 51, 54-55  
Hetzl, Max: 74  
Ideal Toy Co.: 36  
Incablock: 79  
Jonell Watch Case Co.: 64  
Kif: 79  
Kirby, Durward: 55  
Koehler, Fred: 17, 18, 23-25, 31,  
33, 74  
'Koehler Clock': 17, 19, 30, 74  
ladies electric: 94-95  
light & motion display: 82-83  
"Lord Lancaster E": 133, 140  
"Lord Lancaster J": 137, 140  
Luckey, George: 14, 39, 40  
marine chronometer: 17-18  
Masterpiece: 145  
"Meteor": 129  
Miller, Bettye: 61  
Model 1, Mark 2: 36-37  
Model 1, Mark 3: 36, 37  
Model 1, Mark 4: 37

## INDEX

- Model 2: 38-41, 42, 44, 67  
Model 500: 42, 43, 44-49 (46-47),  
67, 69-71, 77, 83, 86, 97,  
99, 100-101, 103, 104, 105,  
156-161  
Model 500A: 78-79  
Model 501: 78-79  
Model 502: 81-82, 115  
Model 505: 79-87 (81, 86), 89, 101,  
103, 104-106, 141, 162-163  
Model 505C: 89-90  
Model 507: 89-92 (91)  
Model 508: 92  
Model 510: 92-93  
Model 511: 93-94  
Model 667: 119  
Mutter, William: 74  
National Carbon Co.: 34, 53  
"Nautilus 200": 147  
"Nautilus 201": 147  
"Nautilus 202": 147  
"Nautilus 400": 148  
"Nautilus 401": 148  
"Nautilus 402": 148  
"Nautilus 403": 148  
"Nautilus 404": 149  
"Nautilus 405": 149  
"Nautilus 450": 149  
"Nautilus 500": 149  
"Nautilus 501": 150  
"Nautilus 502": 150  
"Nautilus 503": 150  
"Nautilus 506": 150  
"Nautilus 507": 151  
"Nautilus 508": 151  
"Nautilus 509": 151  
"Nautilus 600": 151  
"Nautilus 601": 152  
"Nautilus 602": 152  
"Nautilus 604": 152  
"Nautilus 605": 152  
New York Times: 33  
'Nuremberg Egg': 54, 55  
"Pacer": 72, 98, 99, 107, 108, 115,  
117-120  
"Pacer A": 119  
"Pacermatic": 119  
"Pegasus": 146  
permanent magnet watch: 28-29  
'PM-1': 28, 29, 31, 33, 38, 67  
'PM-2': 33, 36-37, 41, 67  
"Polaris": 88, 133  
"Polaris II": 113, 133  
Presentation: 144-145  
Presley, Elvis: 56  
quartz conversions: 107  
Reber, John: 32-33  
Reese, James H.: 26, 27, 41-43, 48,  
50, 57, 79-82, 90  
"Regulus" 123  
"Regulus II": 113, 138  
Research & Development Dept.:  
14, 15, 41  
Ricoh Corp.: 95-96  
"RR Special 50": 8, 141  
"RR Special 51": 141, 142  
"RR Special 52": 141  
"Saturn": 122, 124  
Sauers, Don: 87  
"Savitar": 84, 134  
"Savitar II": 113, 134  
S&W (Schwab & Wuischpard): 62,  
64, 118  
"Scimitar": 65  
"Sea-Lectric I": 136  
"Sea-Lectric II": 136  
"Sea-Lectric II-B": 136  
Serling, Rod: 56  
"Sherwood": 120  
Shubrooks, G.E.: 23, 41  
Sinkler, Arthur: 26, 40, 46, 48, 51,  
55, 62, 85  
"Skip Jack": 84, 139  
Slaugh, Richard: 35  
Smith, William O.: 104-105  
Smithsonian Institution: 67-68  
"Spectra": 65, 75, 107, 122-123

*THE WATCH OF THE FUTURE*

- "Spectra II": 113, **138**
- Standard Time Co: 95
- Star Watch Case Co: 64, 118
- "Summit": **138**, 145
- "Summit II": 135
- "Taurus": **84**, **88**, **138**
- "Time for America": 87
- Timex: 89
- 'thin electric': 92-94
- "Titan": 49, 64, **66**, **72**, **125**
- "Titan II": **84**, **137**
- "Titan III": **137**
- "Titan IV-B": **137**
- "Triton": **146**
- Union Carbide: 34, 101
- "Uranus": **139**
- Van Haaften, Egbert: 74
- Van Horn, Dr. John A: 20, **21**, **22**,  
23, 26, **27**, 36, 41, 43, 48,  
50-57, 58-59, 71, 85, 124,  
**145**
- "Van Horn": **54**, **121**, **125**
- Vantage series: 95-96
- "Vantage": **89**, **125**
- "Vega": 61, **128**
- "Vela": **139**
- "Ventura": 40, 57, 61, 62, **63**, **64**,  
65, 66, 67, **75**, **109**, **114**-  
**116**, 117-118
- 'vibrating reed': 30
- "Victor": 72, 132
- "Victor II": 113, **135**
- Walmer, Marlin: 43, 43
- 'Watch Review Committee': 94
- 'wear-test prototypes': **44-49**
- Z-pin: 105





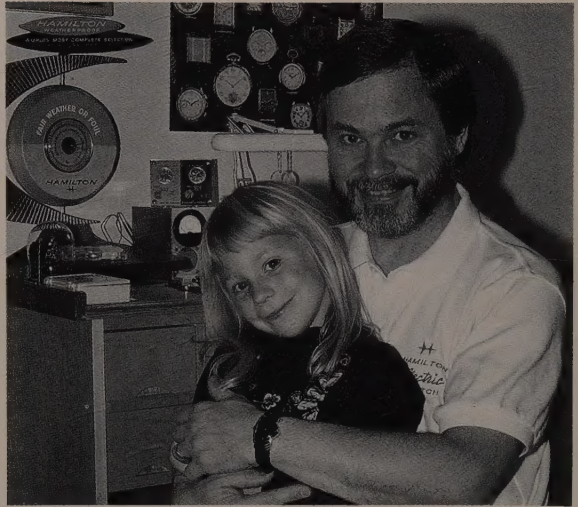

René Rondeau has been specializing in Hamilton Electric watches since 1986. He published the first edition of *The Watch of the Future* in 1989, and has contributed articles about the Hamilton Watch Company to the *NAWCC Bulletin*. He is a member of the National Association of Watch and Clock Collectors and the American Watchmakers Institute.

PRAISE FOR  
*THE WATCH OF THE FUTURE*

*"The Watch of the Future' is excellent; intelligently conceived, well organized and, above all, well written."*

-- Don Sauers, author of *Time for America*

*"The Watch of the Future' tells a big story of the Hamilton Watch Company... Anyone who is even mildly interested in Hamilton's products and history would surely benefit from its well-researched contents."*

--Henry Fried, *Horological Times Magazine*

*"It is one of the rare books which will be of interest not only to those with either wristwatch or electrical horology enthusiasms but also those with just a passing interest."*

-- Dennis Harris, *Antiquarian Horology* (England)

*"Vastly more literate and interesting than most authors. Good work, four stars!"*

--Tony Hyman, author of *"I'll Be There"*

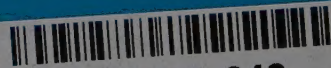

W8-CCA-042

ISBN 0-9622219-1-0