



# The Journal of Gemmology

Volume 27 No. 4

October 2000



**Nephrite  
Jade**



**Treated  
Diamonds**



**Diamond  
Brilliance**



**Spinel from  
Madagascar**



**Brewster  
Angle**



# Gemmological Association and Gem Testing Laboratory of Great Britain



27 Greville Street, London EC1N 8TN

Tel: 020 7404 3334 Fax: 020 7404 8843

e-mail: [gagtl@btinternet.com](mailto:gagtl@btinternet.com) Website: [www.gagtl.ac.uk/gagtl](http://www.gagtl.ac.uk/gagtl)

## **President:**

Professor A.T. Collins

## **Vice-Presidents:**

E.M. Bruton, A.E. Farn, R.A. Howie, D.G. Kent, R.K. Mitchell

## **Honorary Fellows:**

Chen Zhonghui, R.A. Howie, R.T. Liddicoat Jnr, K. Nassau

## **Honorary Life Members:**

H. Bank, D.J. Callaghan, E.A. Jobbins, H. Tillander

## **Council of Management:**

T.J. Davidson, N.W. Deeks, R.R. Harding, I. Mercer, J. Monnickendam,  
M.J. O'Donoghue, E. Stern, I. Thomson, V.P. Watson

## **Members' Council:**

A.J. Allnutt, P. Dwyer-Hickey, S.A. Everitt, A.G. Good, J. Greatwood,  
B. Jackson, L. Music, J.B. Nelson, P.G. Read, P.J. Wates, C.H. Winter

## **Branch Chairmen:**

Midlands – G.M. Green, North West – I. Knight, Scottish – B. Jackson

## **Examiners:**

A.J. Allnutt, M.Sc., Ph.D., FGA, L. Bartlett, B.Sc., M.Phil., FGA, DGA,  
E.M. Bruton, FGA, DGA, S. Coelho, B.Sc., FGA, DGA, Prof. A.T. Collins, B.Sc., Ph.D.,  
A.G. Good, FGA, DGA, J. Greatwood, FGA, G.M. Howe, FGA, DGA,  
S. Hue Williams MA, FGA, DGA, Li Li Ping, FGA, DGA, B. Jackson, FGA, DGA, G.H.  
Jones, B.Sc., Ph.D., FGA, M. Newton, B.Sc., D.Phil., C.J.E. Oldershaw, B.Sc. (Hons), FGA, DGA,  
H.L. Plumb, B.Sc., FGA, DGA, R.D. Ross, B.Sc., FGA, DGA, P.A. Sadler, B.Sc., FGA, DGA,  
E. Stern, FGA, DGA, S.M. Stockmayer, B.Sc. (Hons), FGA, Prof. I. Sunagawa, D.Sc.,  
M. Tilley, GG, FGA, C.M. Woodward, B.Sc., FGA, DGA

## **The Journal of Gemmology**

*Editor:* Dr R.R. Harding

*Assistant Editors:* M.J. O'Donoghue, P.G. Read

*Associate Editors:* Dr C.E.S. Arps (Leiden),

G. Bosshart (Zurich), Prof. A.T. Collins (London), Dr J.W. Harris (Glasgow),

Prof. R.A. Howie (Derbyshire), Dr J.M. Ogden (Hildesheim),

Prof. A.H. Rankin (Kingston upon Thames), Dr J.E. Shigley (Carlsbad),

Prof. D.C. Smith (Paris), E. Stern (London), Prof. I. Sunagawa (Tokyo),

Dr M. Superchi (Milan), C.M. Woodward (London)

*Production Editor:* M.A. Burland



# Two contrasting nephrite jade types

Dr Douglas Nichol

Wrexham, Wales

---

**ABSTRACT:** Two principal types of nephrite jade orebody are now recognized: (1) ortho-nephrite jade bodies associated with serpentinized ultrabasic igneous rocks and exemplified by those of the Canadian Cordillera, British Columbia; and (2) para-nephrite jade bodies associated with metasedimentary strata and exemplified by those of Eyre Peninsula, South Australia. Major-element geochemistry of nephrite jades from the two contrasting geological environments have much in common. However, trace-element geochemical signatures show marked dissimilarity with ortho-nephrites distinguished by high levels of the basic elements Cr, Co and Ni, and para-nephrites characterized by relatively subdued trace-element abundances. Whereas ortho-nephrite jade forms in folded orogenic belts and bears a mantle signature, para-nephrite jade may appear in a variety of tectonic settings but carries a crustal signature. The role of tectonic setting is important but subordinate to that of the composition of the source region in determining the typology of nephrite jades.

---

**Keywords:** Australia, Canada, nephrite jade, ortho-nephrite, para-nephrite

## Introduction

**N**ephrite jade is a microfibrinous, interfelted variety of tremolite. Over the past 25 years much literature dealing with the characteristics and occurrences of nephrite jade in various geological settings has appeared, interest being fostered not only because these rocks represent one of the world's most highly prized ornamental gemstones, but also by the fact that major deposits of relatively recent discovery have changed the traditional pattern of international trade. Indeed, at the present time, world production of raw nephrite jade appears to be dominated by Canada and Australia (Olliver and Townsend, 1993; Ward, 1987).

Nephrite jade studies in recent years have focused on individual occurrences. From straightforward descriptions of producing and newly-discovered deposits, geologists have turned increasingly to discussion regarding their genesis and unifying characteristics. The concept has evolved that two principal, distinctive and contrasting rock associations exist; those nephrite deposits associated with serpentinized ultrabasic igneous rocks, and secondly, those formed within metamorphosed sedimentary strata.

At the present time, however, a variety of names is applied to the nephrite jades from the two rock associations. Leaming (1978) introduced the terms *metasomatic nephrite*



(*serpentine type*) and *metamorphic nephrite (non-serpentine type)* to denote the two geological suites. More recently, Wang (1996) adopted the terms *serpentine-type* and *carbonate-type* and Sekerina *et al.* (1996) referred to them as *aposerpentinite nephrite* and *apomarle nephrite*. The latter terms were subsequently refined by Sekerina *et al.* (1996) to *apohyperbasite nephrite* and *apocarbonate nephrite* respectively.

Despite the diversity in nomenclature already in circulation, possibly *ortho-nephrite* and *para-nephrite* are more acceptable geological terms to denote the two types, a proposal which gains much support from the fact that nephrite jade is a variety of tremolite which in turn is a form of amphibolite and the terms *ortho-amphibolite* and *para-amphibolite* are already entrenched in the geological literature to make precisely the distinction that is sought in this instance (e.g. Leake, 1964). The prefix *ortho-* indicates that the rock was derived from an igneous rock such as peridotite, whereas *para-* signifies derivation from sedimentary material such as dolomitic shale.

Collectors of jade, as well as workers on archaeological jade, frequently wish to determine the original source of specimens and have expressed considerable interest in the use of trace-element signatures as a discrimination tool. The concepts appear generally accepted that the composition of nephrite jades reflect their source regions and that the abundance of certain trace-elements in nephrite jades provides a 'fingerprint' that enables the source to be inferred. However, the extent to which these concepts apply remains uncertain. Elucidation awaits sufficient and adequate data.

The objectives of this paper are to demonstrate the relations between geologic setting and nephrite jade typology, compare trace-element concentrations for samples from exemplars of the two principal types and attempt to establish criteria for initial characterization of geological sources. The nephrite jade deposits selected are from British Columbia, Canada, and Eyre Peninsula, South Australia. They are Mesozoic *ortho-nephrite* and Precambrian *para-nephrite* jades respectively.

### Ortho-nephrite jade of British Columbia, Canada

Numerous *ortho-nephrite* jade occurrences are recorded along a narrow median belt of the Canadian Cordillera through British Columbia (Figure 1). The belt is characterized by serpentinized alpine-type ultramafic rocks and major faults (Fraser, 1972; Leaming 1978) and is traceable southwards into the USA and northwards through the Yukon into Alaska.

Two principal areas of *ortho-nephrite* jade production are Mount Ogden in the Omineca Mountain Range and Dease Lake area in the rugged Cassiar Mountains in the north-central region of the province. At both localities, lenses and pods of *ortho-nephrite* jade have formed either within serpentinite masses or, more commonly, within the contact zone between serpentinite and the country rock.

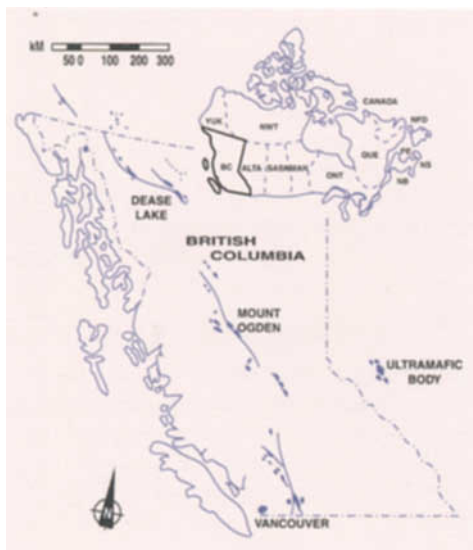


Figure 1: Orientation map of British Columbia, Canada.



The ortho-nephrite jade bodies are typically small, lenticular, fault-bounded and although variable in structure, generally appear to be concordant with neighbouring rock formations (Figure 2). Size ranges up to 100 m long by 10 m wide though most bodies are much smaller. The host ultramafic igneous rocks are mostly peridotite, dunite and pyroxenite. They vary from minor intrusions to major batholiths and whereas the former are almost invariably completely serpentinized, the latter are usually at least partially altered. The predominant sedimentary country rocks are chert, quartzite and argillite of the Cache Creek Group of Permo-Carboniferous age. Typically, the contact alteration zone ranges up to 30 m wide and includes talc schist, tectonic blocks of Cache Creek Group sediments, sheared serpentinite and fine-grained leucocratic rock (rodingite) as well as ortho-nephrite jade bodies.

The ortho-nephrite jade ranges from greyish-yellow-green (5GY 7/2) through olive-green (10GY 2/1) to dusky yellowish-green (10GY 4/2), but is predominantly dusky yellowish-green (10GY 3/2). Accessory minerals, seldom present in appreciable amounts, include picotite, uvarovite, chlorite, talc and pyrite.

As well as those of Canada, ortho-nephrite jade deposits have also been described from South Island, New Zealand (Beck, 1970; Finlayson, 1909; Turner, 1935), the Lake Baikal area, Russia (Kolesnik, 1970; Sekerin *et al.*, 1996), the Tian Mountains, Western China (Wang, 1996), California, USA (Coleman, 1967), the Fengtien and Nanao areas, Taiwan (Tan *et al.*, 1978; Yui *et al.*, 1987), the Great Serpentine Belt of New South Wales, Australia (Hockley *et al.*, 1978) and the Jordonow district, Poland (Heflik, 1968).

### Para-nephrite jade of South Australia

Para-nephrite jade occurs within the Precambrian crystalline basement on the eastern margin of the Australian Precambrian Shield, in the Minbrie Ranges

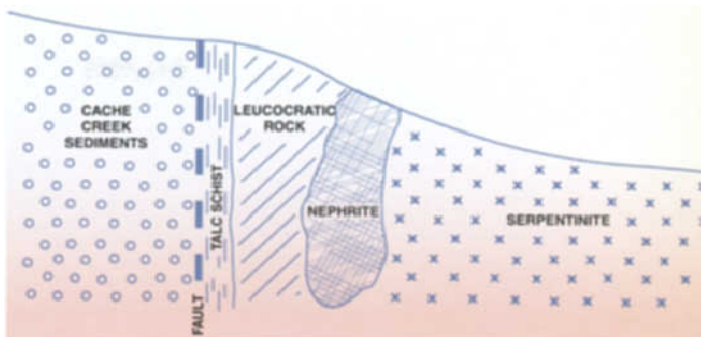


Figure 2: Diagrammatic cross section of nephrite jade orebody at the 'main showing' on Mount Ogden. After Leaming (1978).

near Cowell on Eyre Peninsula, South Australia (Nichol, 1977). The 120 individual outcrops, which extend over an area 6 km by 2 km are hosted exclusively by a

### Nephrite jade samples tested

*British Columbia, Canada:*

- BC1: Yellowish-green (10GY 5/4). Mount Ogden
- BC2: Predominantly dark yellowish-green (10GY 4/4) and dusky green (5G 3/2) with minor speckles of moderate green (5G 5/6). Mount Ogden
- BC3: Dark yellowish-green (10GY 4/4) with minor crystals of pyrite. Dease Lake
- BC4: Moderate yellowish-green (10GY 6/4) and dark yellowish-green (10GY 4/4). Dease Lake

*Cowell, Eyre Peninsula, South Australia:*

- SA1: Dusky yellow green (5GY 5/2) and dusky yellowish-green (10GY 3/2)
- SA2: Dusky green (5G 3/2)
- SA3: Black (N1) and greenish-black (5G 2/1)

NB: Numerical designations of colours are based on the Munsell system of colour identification (Rock-Colour Chart Committee, 1980).

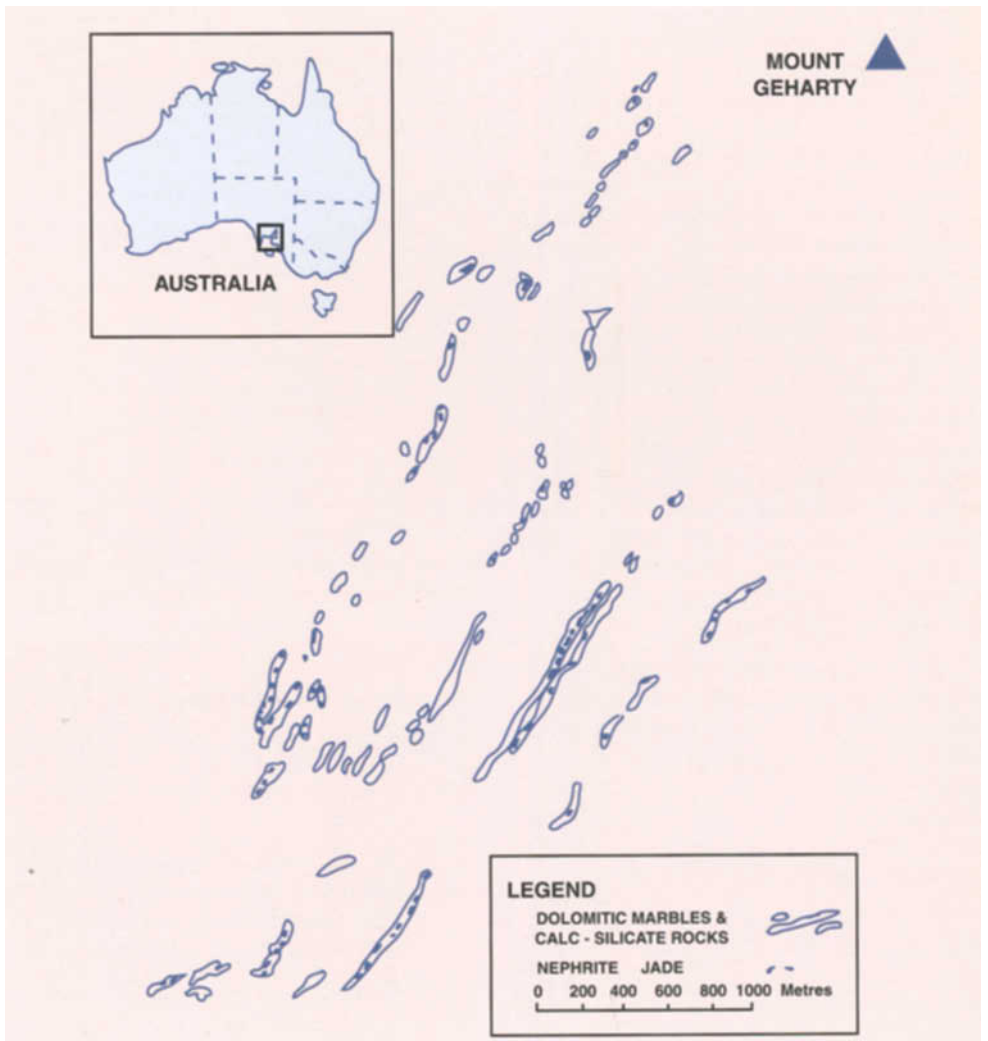


Figure 3: Geological map of Cowell Nephrite Jade Providence, South Australia.

metamorphosed dolomitic marble and calc-silicate rock assemblage. The country rocks are metasedimentary schists, quartzites and quartzo-feldspathic gneisses within which the dolomitic marble and calc-silicate rock assemblage forms a prominent stratigraphic horizon. This index horizon is traceable along the limbs of a series of tight isoclinal antiforms and synforms (Figure 3).

The para-nephrite jade occurs in irregular lenticular and pod-shaped, mainly

concordant bodies that range in size up to 65 m long by 3 m wide. They lie within, between and alongside the dolomitic marble, tremolite and other calc-silicate rocks with which they are intimately associated. Almost invariably, the para-nephrite jade bodies have developed where the host rocks display locally more intense deformation and tectonic disruption. Contacts between nephrite and calc-silicate or carbonate rocks are usually sharp but may be transitional



**Figure 4:** Suite of samples, from left to right, ortho-nephrite jade from Canada (BC1, 2, 3 and 4) and para-nephrite jade from Australia (SA1, 2 and 3).

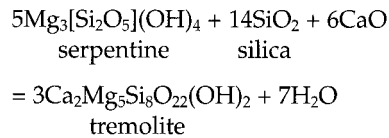
where the adjacent calc-silicate rock is tremolite or talc-chlorite schist.

Colours range from greyish-yellow-green (5GY 7/2), through moderate yellowish-green (10GY 6/4) and dusky green (5G 3/2) to black (N1). Colour variations reflect total iron content; pale tones correspond to low iron content (1-2%) whereas black (N1) para-nephrite jade contains up to 8% total iron (Nichol, 1975). Texture is microcrystalline. Associated mineral inclusions are uncommon but include epidote, tremolite and pyrite.

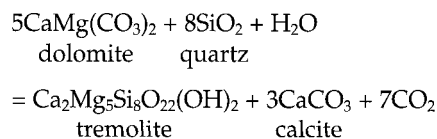
As well as those of South Australia, para-nephrite jade deposits have also been described from the Chuncheon area, Korea (Kim, 1995), the Kunlun Mountains, Western China (Wang, 1996), the Lake Baikal area, Russia (Sekerin *et al.*, 1996; Sekerina *et al.*, 1996), and Wyoming, USA (Sherer, 1969).

### Modes of origin

The petrogenesis of nephrite jade is considered to be a two-stage process. First, the mineralogical transformation to a tremolite end-product either by alteration of serpentinite by hydrous fluids from adjacent rocks with the addition of calcium and silica, and the following reaction applies:



or by reconstitution of impure sedimentary dolomite according to the following equation:





**Table 1:** Chemical analyses of ortho-nephrite jade from Canada (BC) and para-nephrite jade from Australia (SA).

Sample No.	BC1	BC2	BC3	BC4	SA1	SA2	SA3
<i>Analysis (Wt.%)</i>							
SiO <sub>2</sub>	56.23	56.37	54.68	55.15	57.44	58.82	56.09
TiO <sub>2</sub>	0.12	0.11	0.15	0.10	0.04	0.07	0.11
Al <sub>2</sub> O <sub>3</sub>	1.74	1.81	1.93	1.89	0.70	1.38	0.83
Fe <sub>2</sub> O <sub>3</sub>	3.61	3.74	5.77	4.39	1.42	1.75	7.78
MnO	0.09	0.10	0.22	0.19	0.05	0.12	0.07
MgO	21.38	21.44	20.92	21.17	23.26	22.06	20.19
CaO	12.88	12.91	12.23	12.38	13.77	11.24	12.32
Na <sub>2</sub> O	0.10	0.11	0.05	0.06	0.08	0.19	0.07
K <sub>2</sub> O	0.06	0.06	0.03	0.02	0.09	0.11	0.15
P <sub>2</sub> O <sub>5</sub>	0.08	0.06	0.11	0.07	0.07	0.14	0.06
Loss on ignition	3.47	3.53	3.61	3.95	1.98	3.52	1.87
Total	99.76	100.24	99.70	99.37	98.90	99.40	99.54
<i>Trace elements (ppm)</i>							
As	20	20	20	20	10	10	10
Ba	20	20	20	20	20	20	20
Co	80	90	60	50	10	20	25
Cr	4000	5000	9000	7000	20	20	20
Cu	10	15	15	10	50	50	100
Nb	10	10	10	10	10	10	10
Ni	1100	1300	900	800	50	50	100
Pb	20	30	20	20	5	5	5
Sr	15	15	15	15	10	20	10
V	100	200	200	150	10	10	20
Zn	60	70	60	40	50	50	100

**Analyses by Geochem Group Ltd, Chester, UK**

These two reactions by which tremolite develops are generally considered to represent metasomatism and metamorphism respectively, but to assign a particular deposit to one or other such process may prove difficult. The reasons are that the paths taken by metasomatism and metamorphism

are frequently not too dissimilar and, moreover, the influence of various other factors operating within the environment in which the reactions take place are almost invariably poorly understood.

The second step comprises wholesale recrystallization whereby relatively coarse-

grained tremolite is converted to fine-grained, felted nephrite. This tectonic modification is essentially mechanical. It consists of dynamic (shock) metamorphism and involves a sudden release in confining pressures within tremolite bodies that are saturated with water under high partial pressure. The change in earth pressure conditions possibly coincides with some local tectonic event.

## Geochemistry

Laboratory testing was carried out on selected samples collected from *in situ* rock outcrops and believed to be typical of the average quality of nephrite jade from each locality in Canada and Australia (Figure 4). Seven XRF/ICP analyses of whole rock samples for up to 21 main elements are presented in Table I. Sample descriptions are detailed in the box on p.196 and include colours quoted with numerical designation based on the Munsell system of colour identification (Rock-Colour Chart Committee, 1980).

The virtually monomineralic nature of nephrite jade restricts the compositional variation of the gross rock geochemistry. The whole rock chemical analyses approach that of the theoretical pure composition of tremolite, SiO<sub>2</sub>, 59.17%; CaO, 13.80%; MgO, 24.81%; H<sub>2</sub>O, 2.22%. Departures from this ideal composition reflect the presence of accessory mineral constituents as well as variations due to atomic substitutions normally occurring in tremolite. Accordingly, the fields of composition derived from the major-elements appear similar whether the nephrites had formed by the alteration of basic igneous rocks or by the metamorphism of dolomitic sedimentary rocks.

On the other hand, trace-element characteristics reflect greater geochemical diversity. Whereas the overall trace-element concentration of arsenic (As), barium (Ba), niobium (Nb), strontium (Sr) and zinc (Zn) have a fairly narrow range, those of copper (Cu), lead (Pb) and vanadium (V) fall within

wider bands of variation. However, the values for cobalt (Co), chromium (Cr) and nickel (Ni) provide the strongest geochemical contrasts between the two types of nephrite jade, with the principal geochemical distinction being the Cr content. The ortho-nephrites typically contain around 5000 ppm Cr (equivalent to 0.72% Cr<sub>2</sub>O<sub>3</sub>) and show exceptionally high levels over para-nephrites that typically contain only 20-30 ppm Cr. Such a wide difference in absolute concentrations of Cr appears to provide the most useful means of distinction between the two types. These preliminary conclusions concerning the importance of chromium generally accord with the observations of other workers (e.g. Flint *et al.*, 1985; Kovalenko *et al.*, 1985; Tan *et al.*, 1978; Wang, 1996). However, they should be confirmed by testing other para- and ortho-nephrite jade deposits.

## Conclusions

Nephrite jade may be subdivided into two types: ortho-nephrite jade that is associated with serpentized ultrabasic igneous rocks and para-nephrite jade that is associated with metasedimentary strata. Exemplars for each type are the deposits of the Canadian Cordillera, British Columbia and those of the Cowell district on Eyre Peninsula, South Australia respectively.

Although host rock associations are quite different, the two types of nephrite jade appear similar in mineralogy, texture and gross geochemical composition. Also, many of the tectonic features present are similar in both cases. They are frequently affected by multiple phases of folding or dismembered by faulting to form fault-enclosed bodies. Contacts between orebodies and country rock are frequently sharp, zoning appears absent and form is irregular but subparallel to the regional trend. There is every indication that formation of the bodies was not a passive development but rather involved active tectonism and favoured localized sites of relatively intense deformation.

Trace-element analysis provides a useful tool for discriminating the two types of nephrite jade. The principal geochemical distinction is chromium content. Typically, ortho-nephrites have Cr contents around 5000 ppm and at least 100 times greater than those found in para-nephrites. However, this preliminary conclusion concerning the importance of chromium should be tested on para- and ortho-nephrite jade deposits from other parts of the world.

To apply the knowledge, future workers should be advised that the Cr criterion is valid for XRF average analysis but not necessarily for 1  $\mu\text{m}$  points determined by EPMA.

### Acknowledgement

I thank Mrs Jeannie MacCulloch, Jade World, Vancouver, for helpful guidance during my visit to British Columbia as a 1996 Churchill Fellow.

### References

- Beck, R.J., 1970. *New Zealand Jade: The Story of Greenstone*. A.H. and A.W. Reed, Wellington, 106 pp
- Coleman, R.G., 1967. Low-temperature reaction zones and ultramafic rocks of California, Oregon and Washington. *Bulletin, U.S. Geological Survey*, 1247
- Finlayson, A.M., 1909. The nephrite and magnesian rocks of the South Island of New Zealand. *Quarterly Journal of the Geological Society, London*, **65**, 351-81
- Flint, D.J., Dubowski, T., and Olliver, J.G., 1985. Latest report on Cowell jade. *The Bulletin of the Friends of Jade*, **4**, 82-5
- Fraser, J.R., 1972. Nephrite in British Columbia. MSc Thesis, Department of Geology, University of British Columbia, 142 pp
- Heflik, W., 1968. [Mineralogy and genesis of nephrite from Jordonow, Lower Silesia.] *Zapiski Vsesoyuznogo Mineralogicheskogo Obshchestva*, **97**, 96-9
- Hockley, J.J., Birch, W.D., and Worner, H.K., 1978. A nephrite deposit in the Great Serpentine Belt of New South Wales. *Journal of the Geological Society of Australia*, **25**, 249-54
- Kim, W.-S., 1995. Nephrite from Chuncheon, Korea. *The Journal of Gemmology*, **24**, 547-50
- Kolesnik, Yu, N., 1970. Nephrites of Siberia. *International Geology Review, Book Section*, **12**, 107
- Kovalenko, I.V., Cathi, I.P., Kovalenko, V.C., and Cvirilenko, A.F., 1985. [Microstructure and composition of apo-ultramafic nephrites.] *Zapiski Vsesoyuznogo Mineralogicheskogo Obshchestva*, **114**, 707-12
- Leake, B.E., 1964. The chemical distinction between ortho- and para-amphibolites. *Journal of Petrology*, **5**, 238-54
- Leaming, S.F., 1978. Jade in Canada. Geological Survey of Canada, Paper 78-19, 59 pp
- Nichol, D., 1975. The colour of nephrite jade from Cowell. *Quarterly Geological Notes, Geological Survey of South Australia*, **53**, 9-12
- Nichol, D., 1977. Nephrite jade deposits near Cowell, Eyre Peninsula. *Mineral Resources Review, South Australia*, **141**, 11-26. Also reproduced in *The Bulletin of the Friends of Jade*, 1983, **3**, 77-88
- Olliver, J.G., and Townsend, I.J., 1993. *Gemstones in Australia*. Australian Gemstone Industry Council, Australian Government Publishing Service, Canberra, 72 pp
- Rock-Colour Chart Committee, 1980. *Rock-Colour Chart*. Geological Society of America, New York
- Sherer, R.L., 1969. Nephrite deposits of the Granite, the Seminoe and the Laramie mountains, Wyoming. PhD Thesis, University of Wyoming, 194 pp
- Sekerin, A.P., Sekerina, N.V., Lashchenov, Y.A., and Menshagin, Yu. V., 1996. To the problem of nephrite-bearing properties of folded areas. *The Bulletin of the Friends of Jade*, **9**, 147-50
- Sekerina, N.V., Sekerin, A.P., Menshagin, Yu. V., and Lashenov, V.A., 1996. The light-coloured nephrite of East Sayany. *The Bulletin of the Friends of Jade*, **9**, 143-6
- Tan, L.P., Lee, C.W., Chen, C.C., Tien, P.L., Tsui, P.C., and Yui, T.F., 1978. A mineralogical study of the Fengtien nephrite deposits of Hualien, Taiwan. *National Science Council, Republic of China (Formosa), Special Publication*, **1**, 1-81
- Turner, F.J., 1935. Geological investigation of the nephrites, serpentines and related 'greenstones' used by the Maoris of Otago and South Canterbury. *Transactions of the Royal Society, New Zealand*, **65**, 187-210
- Wang, C., 1996. Jade in China. *The Bulletin of the Friends of Jade*, **9**, 121-42
- Ward, F., 1987. Jade – stone of heaven. *National Geographic*, **172**(3), 282-315
- Yui, T.-F., Lo, C.-H., Lan, C.-Y., and Lee, C.W., 1987. Nephrite-rodigite in metamorphosed ophiolite, Nanao, northeast Taiwan. *Proceedings of the Geological Society of China (Taiwan)*, **30**, 22-39



# Investigation of seven diamonds, HPHT treated by NovaDiamond

F. De Weerd and J. Van Royen

*Diamond High Council, Certificates Department, Hoveniersstraat 22,  
2018 Antwerp, Belgium*

---

**ABSTRACT:** An investigation of seven type Ia diamonds, treated at high pressure and temperature (HPHT) by NovaDiamond. UV-VIS-NIR and FTIR spectroscopies reveals some typical characteristics of HPHT-treated diamonds.

---

**Keywords:** HPHT treatment, diamond, spectroscopy

## Introduction

Modern technology is increasing its impact on the diamond sector. Methods for changing the colour, and consequently the value, of diamonds are becoming more and more advanced (a review of such methods is given in reference 1). Specifically, High Pressure and High Temperature (HPHT) treatment of diamond is growing more important. As technology and knowledge are spreading, this technique is becoming more refined and accessible.

The aim of HPHT treatments is to change defects in the crystal lattice under the influence of elevated temperature and pressure. At these temperatures, defects can become mobile and can aggregate, thereby changing the colour of the diamond; other defects may dissociate, again leading to colour changes. The parameters used in these treatments can be similar to the pressure and temperature (1200°C-1300°C) of the environment where diamonds grow in nature. However in order to reduce the long aggregation time, higher temperatures (1400°C -2000°C or higher) and pressures (up to 70 000 atm) are used during HPHT treatments. The detection of these treatments

is a major problem for diamond grading laboratories all over the world.

Press releases of the American company NovaDiamond state that the original brownish colour of type Ia diamonds is changed to yellowish-green by HPHT treatment, without using irradiation.

In the following section, a short introduction is given on the influence of HPHT treatment on defects and defect formation in diamond, to provide the background for the work on the treated diamonds.

## Defects in diamonds

Defects in diamonds (e.g. substitutional nitrogen) are kept in position by the carbon atoms. Because of the high tenacity of carbon atom binding, a large energy barrier reduces the mobility of the defects. During HPHT treatments, the thermal energy allows the defects to overcome that energy barrier and diffuse through the diamond crystal lattice. Although pressure has a negative influence on defect mobility, and therefore on the 'reaction' rate of defect aggregation, it is necessary to keep the diamond stable at the

## Instruments

UV-VIS-NIR optical absorption measurements were performed with a CCD diode array spectrophotometer equipped with a Princeton Instruments ST-121 temperature controller, cooling the diode array down to  $-30^{\circ}\text{C}$ , and a monochromator with a 300 grooves/mm grating. The diamond is placed in a sample holder and illuminated with the full spectrum of a halogen light bulb. The transmitted light from the diamond is then guided to the spectrophotometer unit by a quartz fibre optic. Therefore the fluorescence of the diamond is also included in the measured spectrum. This should be taken into account when analysing the spectrum. FTIR measurements were performed using a Bio-Rad FTS-40 spectrophotometer, equipped with an intergrating mirror accessory. This arrangement makes it possible to measure spectra of polished diamonds. Short wave UV topographic observations were made using a DiamondView instrument on loan from De Beers. Due to differences in growth parameters each diamond has a unique fluorescence pattern, which can be recorded by a camera. Observations with crossed polarization filters were made with the aid of an HRD gemmological microscope (magnification ranging from 10x up to 40x). Cooling to liquid nitrogen temperature ( $-196^{\circ}\text{C}$ ) was not performed as the diamonds were heavily strained and it was feared that the crystals could be damaged.

high temperatures applied (i.e. to prevent diamond turning into graphite).

The presence of other defects, however, can have a positive effect on the reaction rate: vacancies<sup>2</sup> (empty positions or sites in the diamond lattice) and interstitials<sup>3,4</sup> (atoms located between two lattice sites of the diamond crystal) can enhance the aggregation of single substitutional nitrogen (C defect) to groups of 2 N-atoms (A defects)

or 4 N-atoms, surrounding a vacancy (B defect). In natural untreated type Ia diamonds the combination of all three A, B and C defects together in substantial amounts has not been found.

The results of high energy irradiation of diamonds can be observed in the UV-VIS spectrum. Depending on irradiation dose and diamond type, ND1 (393 nm)<sup>5-12</sup> or GR1 (741 nm)<sup>13-18</sup> centres appear. When a type Ia diamond is irradiated and heated to temperatures of about  $300^{\circ}\text{C}$ , the 594 nm line appears<sup>19-21</sup>. When heating these diamonds at higher temperatures in vacuo to  $1100^{\circ}\text{C}$ , the 595 nm line disappears<sup>20-24</sup>, and  $\text{H}_1\text{b}$  ( $4940\text{ cm}^{-1}$ ) and  $\text{H}_1\text{c}$  ( $5170\text{ cm}^{-1}$ ) lines can be seen in the infrared spectrum. The  $\text{H}_1\text{b}$  and  $\text{H}_1\text{c}$  lines are believed to be an aggregate of the 594 nm defect and the A centre and B centre respectively<sup>21-24</sup>. The precise nature of the 594 nm defect is still unclear. When heating the irradiated diamond to  $800^{\circ}\text{C}$  aggregates of defect centres emerge: in type Ib diamonds, nitrogen-vacancy aggregates form (called N-V centres), and when these centres capture an electron from an electron donor, the 637 nm line appears<sup>25-28</sup>. A possible electron donor can be a C centre (ionisation energy of 1.7 eV) or an A centre (ionisation energy of 4 eV). When the N-V centre does not capture an electron, a line at 575 nm is detected<sup>29</sup>. In type Ia diamonds, other defects involving a vacancy appear: when an A centre captures a vacancy, an H3 (503 nm line) defect is formed<sup>29-31</sup>, and when a B centre (4 nitrogen atoms surrounding a vacancy) captures a vacancy, an H4 (496 nm) line appears<sup>32-33</sup>.

During HPHT treatment defects can not only aggregate, but aggregates themselves can also dissociate: for example platelets (large scale defects) can be destroyed by the HPHT treatment<sup>34</sup>. Experiments performed by Brozel *et al.*<sup>34</sup>, Kiflawi *et al.*<sup>35</sup> and Collins *et al.*<sup>36</sup> indicate that at  $1960^{\circ}\text{C}$  (or higher) and a stabilizing pressure of more than 8.5 GPa C centres can be generated by dissociating other nitrogen aggregates, such as the A centre. In these experiments no reduction of A centre absorption was detected, probably



**Figure 1:** The seven HPHT treated diamonds studied in this paper.

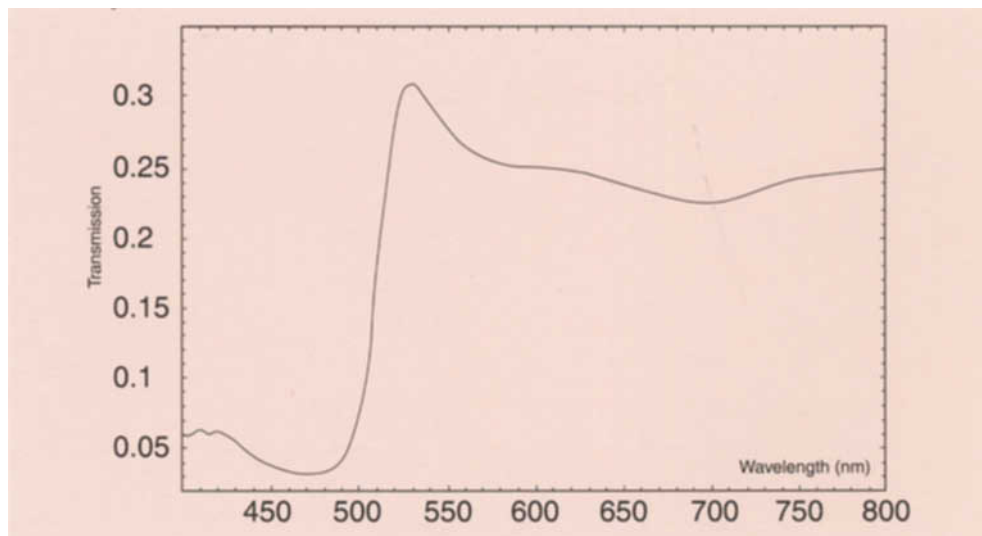
because only a small concentration of C centres was produced. Other defects capable of generating vacancies and interstitials under these extreme circumstances are dislocation planes<sup>36</sup> and large atoms such as Ni or Co in synthetic diamond<sup>37-38</sup>.

When A centres are dissociated at the elevated temperatures used in the HPHT treatment, C centres can diffuse through the diamond lattice. It is also possible that when platelets dissociate, some C centres are released by the platelets. The presence of nitrogen in platelets is however still a point of discussion. C centres act as electron donors, changing H3 to H2 (986 nm line). This explains why the H2 centre is

considered to be a fingerprint of HPHT treatment.

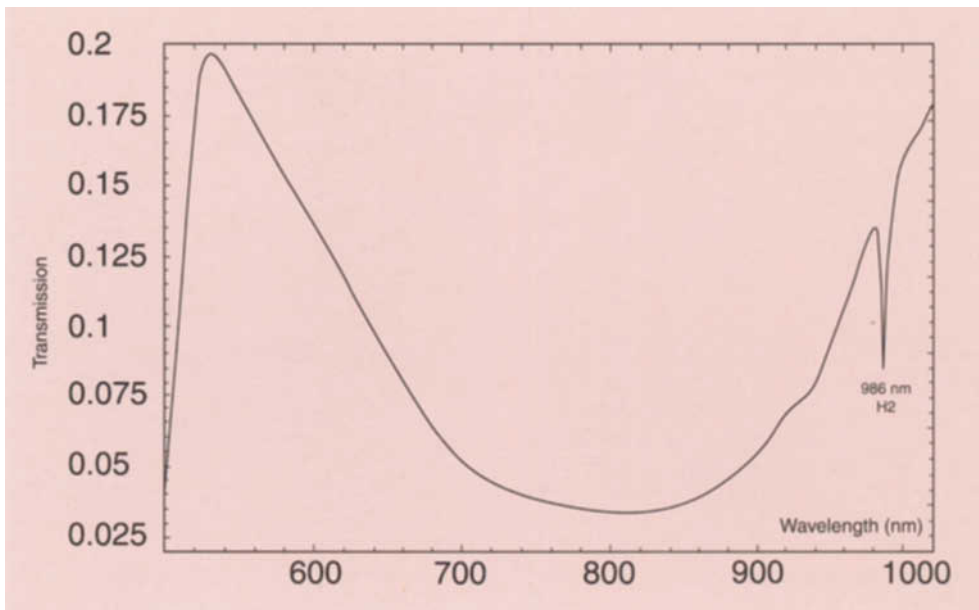
### Sample details

All treated samples are type Ia and yellowish-green to green in colour (*Figure 1*). In the following paragraphs the diamonds will be referred to as numbers 1 to 7. In *Figure 1* from left to right, it is seen that diamond 1 is triangular (0.68 ct), diamond 2 is triangular (0.69 ct), diamond 3 is a radiant cut (0.93 ct), diamond 4 is a round brilliant cut (0.79 ct), diamond 5 is oval (0.86 ct), diamond 6 is pear-shaped (0.73 ct) and diamond 7 is a radiant cut (0.45 ct). In some diamond samples, black cracks can be seen around inclusions.

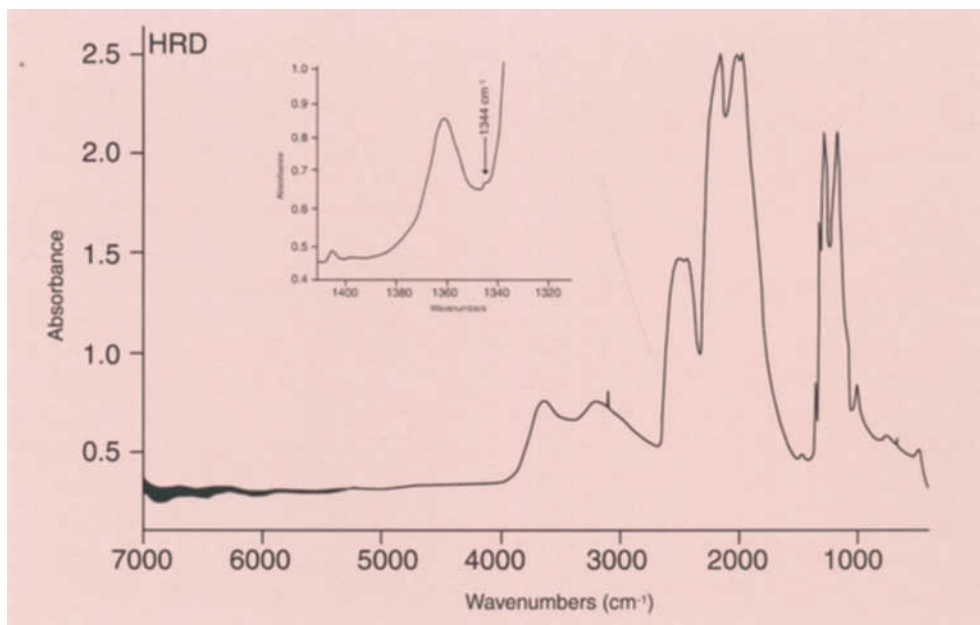


**Figure 2:** UV-VIS-NIR spectrum of a HPHT treated diamond at room temperature. Strong H3 fluorescence is observed with a maximum around 529 nm.





**Figure 3:** NIR spectrum of a diamond with strong H<sub>2</sub> absorption, measured at room temperature. The presence of the strong H<sub>2</sub> side band induces a more intense green colour in the diamond.



**Figure 4:** Room temperature FTIR spectrum for one of the HPHT treated diamonds. The inset shows a small C centre absorption peak at 1344 cm<sup>-1</sup>.

Because the samples have been polished in commercial shapes no estimates of the path lengths of transmitted light could be made, so analytical conclusions which can be drawn from the spectra are restricted to some extent.

## Results

### UV-VIS-NIR spectroscopy

A general trend observed in the UV-VIS spectrum of the treated diamonds is a very strong green H3 fluorescence with a maximum at 529 nm (Figure 2) also seen when illuminating the diamonds with a long wave UV lamp. This causes the colour of the diamonds to be yellowish-green to green. NIR measurements show that the diamonds have a strong to very strong H2 absorption (Figure 3). The strong to very strong absorption sideband of the H2 centre extends to the visible region, causing a more pronounced green colour of the diamond: the maximum of the transmitted light shifts towards the 500 to 600 nm (green to yellow) region.

### FTIR spectroscopy

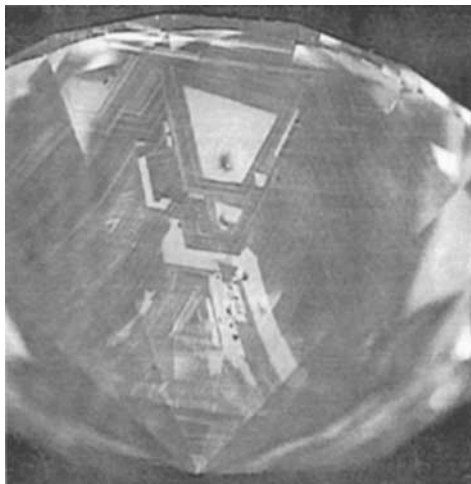
All diamonds show considerable absorption due to A centres and B centres. A relatively weak platelet absorption peak is observed in the spectrum. High resolution measurements (resolution  $1\text{ cm}^{-1}$ ) show that some of the treated diamonds exhibit a small C centre absorption peak at  $1344\text{ cm}^{-1}$  (Figure 4). No absorption due to the so-called amber centre is detectable.

### Short wave UV topographic fluorescence observations

Short wave UV topographic fluorescence observations show that green H3 fluorescence correlates with the strain patterns seen during observations of the diamond through a microscope with crossed polarization filters (Figure 5). In some diamond samples these can be seen in unpolarized light with a microscope.

## Discussion

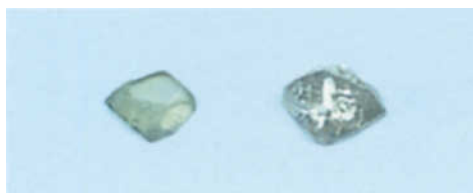
All diamond samples clearly show a strong H3 fluorescence and strong to very



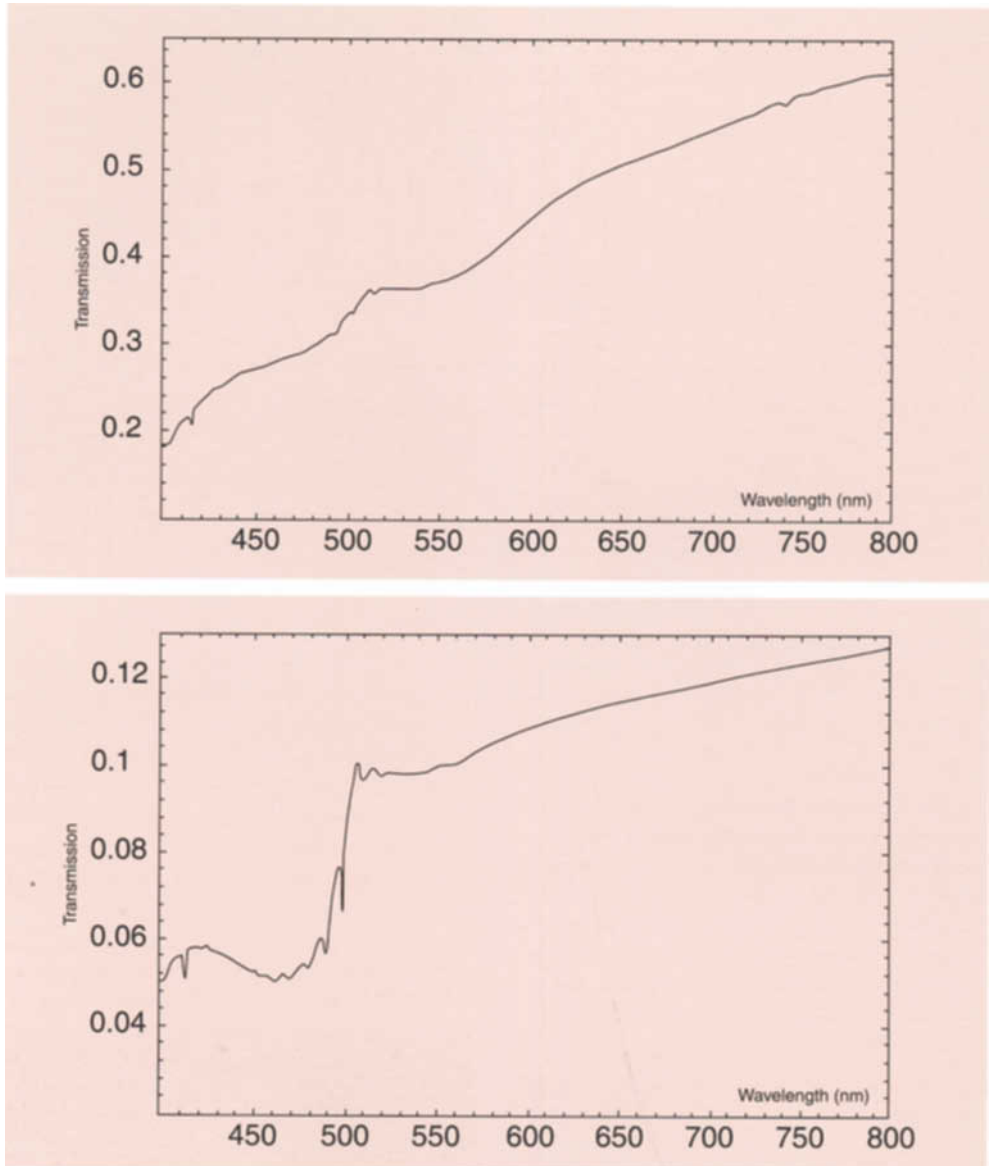
**Figure 5:** A short wave UV topographic image of sample 4. The greenish H3 fluorescence pattern is consistent with the graining pattern observed with a microscope and crossed polarization filters.

strong H2 absorption. Samples 1, 2 and 7 contain C centres detectable with high resolution FTIR measurements. This combination of A, B, C and H2 centres is characteristic of HPHT treatment in natural type Ia diamonds.

For comparison, a brownish Type Ia octahedral diamond from Argyle (which belongs to HRD) was cut in two parts: one part was kept as reference (0.35 ct; sample 8), the other part was HPHT treated (0.17 ct; sample 9). Figure 6 shows the two diamond samples. HPHT parameters were:  $1900\pm 70^\circ\text{C}$  and 7 GPa and these conditions were applied for 10 hours. Figures 7a and 7b show the UV-VIS-NIR spectra of the treated and untreated diamond, recorded at liquid nitrogen



**Figure 6:** The untreated part of an Argyle octahedral diamond (sample 8, right) and the HPHT treated part (sample 9, left).

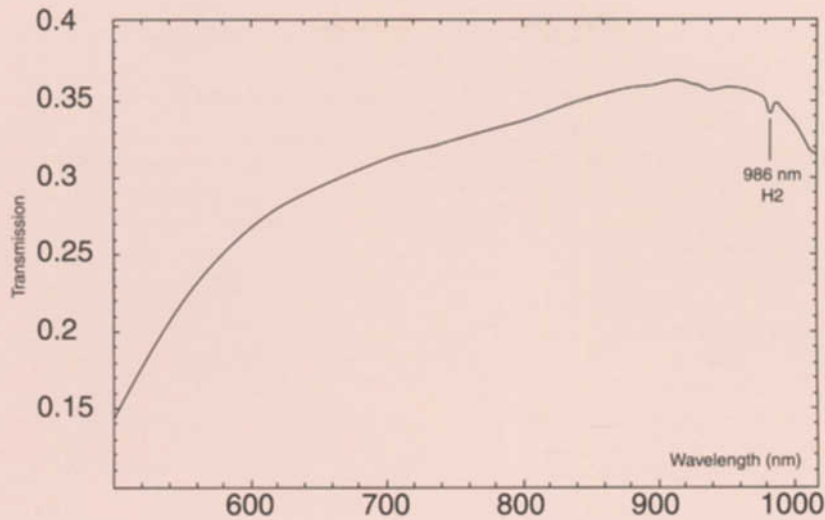


**Figure 7:** UV-VIS-NIR spectra of the untreated (7a, top) and the treated (7b, below) diamond samples 8 and 9 at liquid nitrogen temperature.

temperature. The untreated sample has a weak GR1 absorption peak, consistent with observations in reference 39. This is attributed to natural radiation damage which is located in the outer layer of the rough diamond. However, the concentration of vacancies is not large enough to cause the strong increase of H3 defects seen in the

treated diamond sample. As the samples were not irradiated before HPHT treatment, the source of vacancies must be another defect. Possible vacancy sources could be lattice distortions, releasing vacancies under HPHT conditions. The broad absorption band centred around 550 nm has weakened after treatment. The NIR spectrum of the





**Figure 8:** NIR spectrum at room temperature of an untreated natural type Ib diamond with fairly strong H2 absorption.

untreated sample does not show H2 absorption, but that of the treated sample does show a fairly strong H2 absorption. Neither the treated nor the untreated diamond samples show a detectable C centre concentration in FTIR measurements. Short wave UV topographs show that untreated sample 8 displays a uniform blue N3 fluorescence, and the treated sample 9 displays a green H3 fluorescence, correlating with growth history features of the diamond sample.

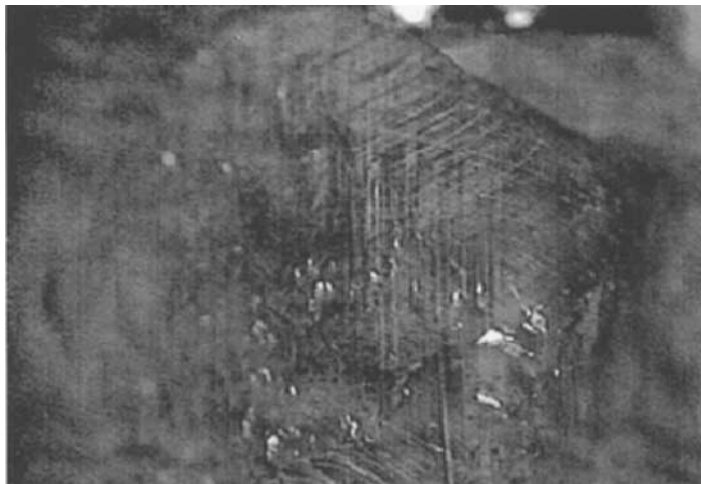
Sample 10 is a rough untreated natural type Ib diamond with a fairly strong H2 absorption (*Figure 8*). Low temperature measurements show very weak [N-V] absorption at 637 nm. No H3 centres were detected by absorption spectroscopy, but were detected by fluorescence spectroscopy and short wave UV topographs (*Figure 9*).

Nearly all H3 centres are converted into H2 centres due to the presence of the relatively high concentration of nitrogen donors (the C-centres). Again, we must state that no analytical conclusions can be made from the spectra due to the impossibility of determining the path length of the transmitted light.

### Conclusion

HPHT treated sample 9 shows a strong H3 absorption but a weak H2 absorption, compared with the NovaDiamond treated samples. The fact that H3 and H2 defects can be detected in natural untreated diamonds, like sample 10, indicates that the presence of

**Figure 9:** Short wave UV topographic observation of sample 10. The H3 absorption is localized near dislocation planes.



the H2 defect cannot be used as absolute proof of HPHT treatment. The strong to very strong H3 fluorescence/absorption and H2 absorption, however, is a very strong indication of HPHT treatment. The simultaneous presence of A, B and C centres in the IR spectrum and H2 absorption in the NIR spectrum is a definite sign of HPHT treatment. The same can be said of the presence of a combination of A, B and H2 centres with other C centre related defects, like the neutral or the negatively charged N-V centre (absorption at 575 nm and 637 nm respectively). Together with strong H3 absorption/fluorescence and H2 absorption, these are a definite sign of HPHT treatment.

### Acknowledgements

We thank NovaDiamond Inc. for providing treated diamond samples, and the researchers at the Institute for Mineralogy and Petrography, Russian Academy of Sciences, Akademgorodok, Siberia for treating our diamond samples.

### References

1. Van Royen, J., Van Esbroeck, V., 1999. Diamond: natural, treated or synthetic? *Antwerp Facets*, September 1999, **32**, 6-15
2. Collins, A.T., 1980. *J. Phys. C: Solid State Phys.*, **13**, 2641-50
3. Fisher, D., and Lawson, S.C., 1998. *Diamond Relat. Mater.*, **7**, 299-304
4. Kiflawi, I., Kanda, H., and Mainwood, A., 1998. *Diamond Relat. Mater.*, **7**, 327-32
5. O'Donell, K.P., 1980. *J. Phys. C: Solid State Phys.*, **13**, L363-7
6. Isoya, J., Kanda, H., Uchida, Y., Lawson, S.C., Yamasaki, S., Itoh, H., and Morita, Y., 1992. *Phys. Rev. B*, **45**, 1436-9
7. Davies, G., Lawson, S.C., Collins A.T., Mainwood, A., and Sharp, S.J., 1992. *Phys. Rev. B*, 13157-69
8. Lowther, J.E., and van Wyk, J.A., 1994. *Phys. Rev. B*, **49**, 11010-15
9. van Wyk, J.A., Tucker, O.D., Smart, V., Newton, M.E., Baker, J.M., Woods, G.S., and Spear, P., 1995. *Phys. Rev. B*, **52**, 12657-67
10. Davies, G., 1977. *Nature*, **269**, 498-9
11. Twitchen, D.J., Hunt, D.C., Smart, V., Newton, M.E., and Baker, J.M., 1999. *Diamond Rel. Mater.*, **8**, 1572-5
12. Steeds, J.W., Charles, S., Davis, T.J., Gilmore, A., Hayes, J., Pickard, D., and Butler, J.E., 1999. *Diamond Rel. Mater.*, **8**, 94-100
13. Collins, A.T., 1978. *J. Phys. C: Solid State Phys.*, **11**, 2453-63
14. Mainwood, A., 1978. *J. Phys. C: Solid State Phys.*, **11**, 2703-10
15. Stoneham, A.M., 1977. *Solid State Comm.*, **21**, 339-41
16. Lawson, S.C., Davies, G., Collins, A.T., and Mainwood, A., 1997. *J. Phys.: Condens. Matter*, **9**, L125-31
17. Mainwood, A., Stoneham, A.M., 1997. *J. Phys.: Condens. Matter*, **9**, 2453-64
18. Novikov, N.V., Ositinskaya, T.D., and Mikhalekov, V.S., 1998. *Diamond Rel. Mater.*, **7**, 756-60
19. Mita, Y., 1996. *Phys. Rev. B*, **53**, 11360-4
20. Woods, G.S., and Collins, A.T., 1986. *J. Gemm.*, **20**, 75-82
21. Davies, G., and Nazare, H.M., 1980. *J. Phys. C: Solid State Phys.*, **13**, 4127-36
22. Woods, G.S., and Collins, A.T., 1982. *J. Phys. C: Solid State Phys.*, **15**, L949-52
23. Collins, A.T., Davies, G., and Woods, G.S., 1986. *J. Phys. C: Solid State Phys.*, **19**, 3933-44
24. Kiflawi, I., Mainwood, A., Kanda, H., and Fisher, D., 1996. *Phys. Rev. B*, **54**, 16719-26
25. Hiromitsu, I., Westra, J., and Glasbeek, M., 1992. *Phys. Rev B*, **46**, 10600-12
26. He, X.-F., Manson, N.B., and Fisk, P.T.H., 1993. *Phys. Rev B*, **47**, 8809-15
27. He, X.-F., Manson, N.B., and Fisk, P.T.H., 1993. *Phys. Rev. B*, **47**, 8816-22
28. Mainwood, A., 1994. *Phys. Rev. B*, **49**, 7934-40
29. Crossfield, M.D., Davies, G., Collins A.T. and Lightowlers, E.C., 1974. *J. Phys. C: Solid State Phys.*, **7**, 1909-16
30. Collins, A.T., 1983. *J. Phys. C: Solid State Phys.*, **16**, 6691-4
31. Collins, A.T., 1999. *Diamond Rel. Mater.*, **8**, 1455-62
32. De Sa, E.S., and Davies, G., 1977. *Proc. R. Soc. Lond. A*, **357**, 231-51
33. Collins, A.T., Thomaz, M.F.M., and Jorge, M.I.B., 1983. *J. Phys. C: Solid State Phys.*, **16**, 5417-25
34. Brozel, M.R., Evans, T., and Stephenson, R.F., 1978. *Proc. R. Soc. Lond. A*, **361**, 109-27
35. Kiflawi, I., and Bruley, J., 2000. *Diamond Rel. Mater.*, **9**, 87-93
36. Collins, A.T., Kanda, H., and Kitawaki, H., 2000. *Diamond Rel. Mater.*, **9**, 113-22
37. Fisher, D., and Lawson, S.C., 1998. *Diamond Rel. Mater.*, **7**, 299-304
38. Kiflawi, I., Kanda, H., and Mainwood, A., 1998. *Diamond Rel. Mater.*, **7**, 327-32
39. Kaneko, K., and Lang A.R., 1993. *Ind. Diam. Rev.*, **6**, 334-37

# Diamond brilliance: theories, measurement and judgement

Michael Cowing

*Crownsville, Maryland, U.S.A.*

---

**ABSTRACT:** The observation of brilliance in a diamond involves a complex interaction of the viewer, the illumination environment, and the manner in which light is processed by a diamond. In order to measure the brilliance of a diamond, a computer simulation of this interaction must model all three of these aspects. The success of any theoretical measure of brilliance is how well it agrees with human judgement.

A study and analysis is reported that contrasts the recent GIA 'analysis of brilliance' findings with the teaching of the GIA Diamond Course and the experience and theories of Tolkowsky and others in the diamond and gem trades. Three-dimensional computer modelling and diamond photography are used to gain a greater understanding of brilliance and arrive at suggestions for improving its measurement.

---

**Keywords:** brilliance, computer model, diamond

## Introduction

The Gemological Institute of America (GIA) and the American Gem Society (AGS) both have common roots in their founder Robert Shipley. For over half a century both have taught the concept of an 'Ideal' round brilliant cut diamond. The GIA attributed the mathematical computations of the best angles and proportions for what they termed the American 'Ideal' or the Tolkowsky cut diamond to Marcel Tolkowsky and his 1919 book *Diamond Design*. In his book, Tolkowsky stated that "the most vivid fire and the greatest brilliancy" is obtained with pavilion main angles of  $40.75^\circ$ , crown main angles of  $34.5^\circ$  and a table size of 53%.

GIA students have been taught: "Most cutters and other experts agree that even a two-degree deviation from Tolkowsky's theoretical pavilion angle will result in a less attractive diamond. An increase of two

degrees in pavilion angle will result in a noticeable darkening of the stone and an obvious loss of brilliance ... a decrease of only two degrees in pavilion angle ... usually shows a reflection of the girdle in the table and is called a 'fish-eye' ... [and] also gives the stone a very 'glassy' appearance" (Diamond Grading Course, 1979, Assignment 21).

In their latest revised course on diamond grading, the GIA adheres even more strictly to Tolkowsky's angles, e.g.: "Today most cutters and other diamond experts agree that varying more than one degree from a pavilion angle of about  $41^\circ$  reduces a diamond's optical efficiency, and thus its beauty ... A crown angle close to  $34.5^\circ$  is the best compromise between optical theory and economic reality" (GIA Diamond Grading Course, 1993, Assignment 6, p.16, 17).

The AGS uses a 0-10 grading system for diamond cuts that is based upon the 'Ideal'.



For discussion purposes, we will use their definition of 'Ideal', which is AGS 0. This AGS 0 grade requires fairly close adherence to Tolkowsky's pavilion and crown angles, but allows his 53% table to range from 52.5% to as large as 57.5%.

Recently, Hemphill *et al.* (1998) reported ongoing research at GIA that has come to some conclusions that mark a significant break with the GIA Diamond Course teaching. The authors use a measure of brilliance known as Weighted Light Return (WLR), which they say "captures the essence of brilliance" (op. cit. p.182). If brilliance were the only factor determining the beauty of a diamond, the GIA believes their measure has captured this essence of beauty. They qualify this by saying that remaining to be analysed for a full understanding of diamond beauty are "fire and scintillation, and probably symmetry deviations and color". They also state that "... the relationship between brilliance and the three primary proportion parameters (crown angle, pavilion angle, and table size) is complex, and that there are a number of proportion combinations that yield high WLR values" (op. cit. p.182) and "The results of this study suggest that there are many combinations of proportions with equal or higher WLR than 'Ideal' cuts" (op. cit. p.158).

Boyajian (1998) concluded that, "Although it is not the GIA's role to discredit the concept of an 'Ideal' cut, on the basis of our research to date we cannot recommend its use in modern times."

Is this GIA brilliance study cause for abandoning the Tolkowsky or American 'Ideal'? To answer this question, we have focused, as did the GIA study, on this single aspect of diamond beauty referred to as brilliance.

Brilliance is defined in the *GIA Diamond Dictionary* (Gaal 1977, p.29) as "the intensity of the internal and external reflections of white light to the eye from a diamond or other gem in the face-up position". The face-up position is the normal viewing position of a diamond with the viewer looking from a

position that is approximately perpendicular to the gem's table.

Has the GIA captured the essence of brilliance in this single WLR measure? We will see that, in order to be useful, a measurement of brilliance such as WLR must agree with human judgement.

What are the necessary features that a computer model needs in order to measure brilliance in a way that is consistent with human judgement of brilliance? Since observation of brilliance in a diamond involves an interaction of the way in which light is processed by the diamond, the diamond's illumination, and the act of viewing by the observer, all three aspects of this interaction should be essential parts of a computer model of brilliance.

In particular, when brilliance only is being measured, as in the GIA study, a simulated illumination is needed that captures the properties of the typical lighting environments in which brilliance is normally judged. If the goal were a more complete computer analysis of diamond beauty, an illumination environment that enhances fire and sparkle as well as brilliance would be needed.

Jewellers know that it is important to display diamonds with illumination that best brings out a diamond's brilliance, fire and sparkle. Because point sources of light bring out a diamond's fire and sparkle as well as brilliance, most diamond-selling areas in jewellery stores have many bright spotlights to illuminate the diamond jewellery. Diamonds displayed in flat, diffuse, fluorescent illumination found in typical office environments may exhibit brilliance but display less fire and sparkle.

Let us now examine the three main features of the computer model of diamond brilliance described by Hemphill *et al.* (1998).

## 1. The diamond

The GIA took great care to create a computer model of the way in which light is

processed in a diamond that is more complete than any before it. Included are three-dimensional effects, a wavelength-dependent refractive index, and the accounting of secondary rays and light polarization. They state that their model differs from its predecessors in that it is three-dimensional and “uses the most detailed existing data on the properties of a colorless diamond” (Hemphill *et al.* 1998, p.182). It would be difficult to improve on this representation of how light is processed by a diamond.

It is necessary to point out that the modelling concerns a colourless, flawless round brilliant-cut diamond with mathematically perfect symmetry. Hemphill *et al.* (1998, p.161) put this in context by saying, “Real diamonds will inevitably differ from the model conditions because of inclusions, symmetry deviations, and the like.” Differences such as symmetry faults and inclusions could also be modelled, but are not addressed in this study. There are varying opinions as to the point at which these imperfections have an impact on diamond brilliance.

## 2. The illumination

A “diffuse hemisphere of even, white light” was selected “to best average the many different ambient light conditions in which diamonds are seen and worn, ... such as a common consumer experience of seeing a diamond worn outdoors or in a well lit room” (Hemphill *et al.*, 1998, p.167). This ‘hemisphere’ illumination provides even lighting from above the girdle but no lighting from below. Visualize the diamond in the centre of a white evenly-illuminated hemisphere mounted in a setting that blocks the light from entering below the girdle.

A computer-generated image of a diamond reveals the effect of this illumination environment (see Figure 2a, excerpt from Figure 2 of Hemphill *et al.*, 1998).



Figure 1: Actual ‘Ideal’ cut photograph from Figure 1, lower left, of Hemphill *et al.*, 1998.

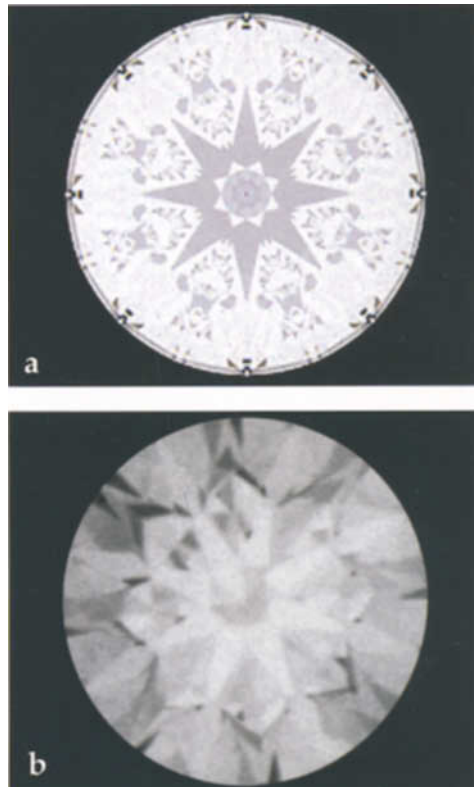


Figure 2: (a) Virtual image of ‘Ideal’ cut, and (b) photo of ‘Ideal’ cut in hemisphere lighting. Both from Hemphill *et al.*, 1998, Figure 2.

Unlike the diamond photograph shown in *Figure 1*, the images obtained using hemisphere lighting look fairly evenly white except for some minor darker areas where the diamond is reflecting and refracting light from below the girdle where there is no light source.

To obtain a photograph that looked similar to the computer generated image of *Figure 2a*, Hemphill *et al.* (1998) photographed the diamond "in diffuse white light using a hemispherical reflector" and noted "diffuse illumination reduces the overall contrast" (see *Figure 2b*).

The images in *Figures 1, 2a* and *2b* show that hemisphere lighting may not give a realistic presentation of the diamond brilliance observed in typical viewing circumstances. The reason for this is that most points on the diamond's crown are refracting and reflecting the same even light from above the plane of the girdle causing all these points to be bright. Consequently, differently proportioned diamonds under hemisphere lighting show smaller differences in brilliance than are seen by an observer in typical lighting environments. The study results of Hemphill *et al.* (1998) indicate that with 'hemisphere illumination' the WLR of known high-brilliance diamonds and those of average brilliance varies from .285 to .275, or about 4%.

When diamonds are judged for brilliance in typical viewing circumstances, the viewer's head and body interfere with the illumination that would otherwise be coming from behind the viewer. Diamond proportions that respond poorly under these circumstances are perceived to have low brilliance. Because the 'hemisphere' illumination does not incorporate this viewer interference, in some important instances these same diamond proportions may have high WLR.

In sections 5 and 6, evidence will be presented to show that greater consistency between the GIA WLR brilliance measure and human observation of brilliance can be obtained by taking explicit account of the

interference in illumination resulting from the physical presence of the viewer.

### 3. The viewer's perception of brilliance

In the Hemphill *et al.* (1998) study the brightness of 65,536 pixels (tiny areas) across the surface of the diamond image is evaluated. This requires up to 65,000,000,000 light rays traced from their hemisphere lighting source through the virtual diamond. This is similar in concept to the approach taken by most investigators from Tolokowsky in 1919 through to the present. Most of the reported research has concerned itself with whether light coming into a diamond's crown from all angles above the girdle (as in hemisphere illumination) is reflected and refracted back through the crown or is lost out of the pavilion. This approach does not concern itself with the impact of the physical presence of the viewer on the illumination environment, or whether the light returned through the crown is seen in the important face-up position by the 'normal' observer.

In the normal face-up observation of a diamond, the viewer sees the portion of light that exits the diamond at approximately 90° to the table. In answer to the question "Should a mathematical definition of brilliance represent one viewing geometry – that is a 'snapshot' – or an average over many viewing situations?", Hemphill *et al.* (1998) chose the average instead of the 'snapshot', as have previous researchers, but with an important difference. Their measure sums the light rays returned through the crown, multiplied by "the square of the cosine function". Recognizing the importance of the face-up viewing position they "wanted the contribution from rays that emerged straight up to be much greater" (op. cit., p.168). Their weighting function emphasizes the face-up, 'normal' observer condition by giving light rays near 90° the greatest weight. They note: this "averaged observer condition ... takes into account the likeliest ways in which a diamond dealer or consumer looks at the stone" (op. cit. p.182).



If the weight given to light rays near  $90^\circ$  were increased to the limit relative to other angles of observation, it would lead to a 'snapshot' of a diamond in the face-up position. Let us consider the suitability of a measure of brilliance using this 'snapshot'. Evaluating the 'snapshot' of brilliance in the face-up, 'normal' position has three important advantages over averaging:

- (i) The single value of WLR obtained by an averaging of viewing angles has lost the detailed knowledge of the relative brilliance occurring at any particular angle of observation such as the most important face-up position. 'Snapshots' can individually measure brilliance at each viewing angle.
- (ii) By analysing the face-up 'snapshot' of a diamond for brilliance, a large economy of computation is realized. Analysing this one 'snapshot' greatly simplifies the search for the most brilliant diamond proportion parameters.
- (iii) There are aspects to the perception of brilliance that go beyond the amount of light returned from the crown of a diamond. Such aspects may be observed and measured from a 'snapshot'. A large amount of intensity variation or contrast between light and dark areas across the surface of a diamond gives it an aspect of brilliance that has been described as 'snappy', 'dramatic', 'hard' or 'sharp'

(Bruton, 1978, p.227). This aspect is the opposite of the brilliance description of 'watery' and 'glassy' used in the GIA Course and the *Diamond Dictionary* (Gaal, 1977) to describe a 'fish eye' diamond, which has a weak appearance due to the lack of contrast as well as lower light return. This contrast aspect of brilliance has properties similar to the contrast variation from bright to dark that occurs with diamond movement called sparkle or scintillation. We will call this aspect 'surface sparkle' to distinguish it from the sparkle that occurs with movement.

Additional aspects to the perception of brilliance are the size and number of these contrasting light and dark areas and how evenly they are distributed over the surface of a diamond. A diamond exhibiting very efficient light return but having little contrast in intensity from facet to facet over the diamond surface is perceived to be 'glassy' or lacking 'snap'. By analysing a 'snapshot' of a diamond, more can be learned about these aspects of brilliance that are lost in a single measure that averages many viewing positions.

Because diamonds are evaluated for beauty in the face-up viewing position, this 'normal' viewing angle is of paramount importance. The principal concern in deciding to use this 'normal' snapshot for brilliance, instead of averaging viewing angles, is whether a diamond will retain its

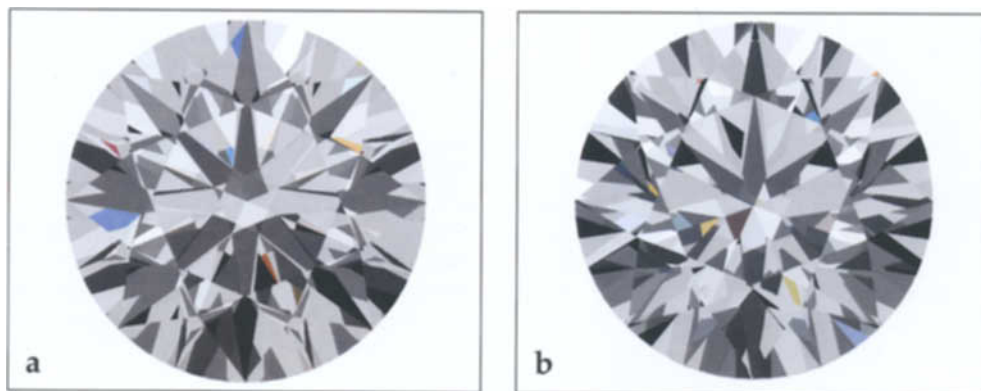


Figure 3: 'Ideal' cut diamond (a) face-up view, and (b) tilted  $10^\circ$ .

brilliance when it is tilted slightly from the perpendicular. To answer this concern, diamond proportions with the highest face-up brilliance should be evaluated at other viewing angles. Our experience has shown that diamonds with near 'Ideal' proportion parameters maintain superior brilliance when viewed at angles off the perpendicular. Brilliance is essentially undiminished through 15° of tilt, only slightly at 25° and slightly more at 45°. Owing to its relatively high refractive index (RI), maintaining brilliance when tilted is one of the properties that distinguishes diamonds from white gemstones that have lower RI. The tendency of diamond imitations such as YAG, GGG, white topaz or spinel to lose brilliance when tilted can be used to separate them from diamonds.

Let us look at two views of an 'Ideal' cut diamond, one face-up and the other tilted 10° (*Figures 3a* and *3b*). These were generated with the Russian DiamCalc software (OctoNus Software <http://www.gemology.ru/octonus>). They illustrate that the brilliance of the 'Ideal' cut is retained at angles off the perpendicular.

We will see later through the use of ray tracing diagrams, such as those in *Figures 5a* and *5b* of section 5 of a 'nail head' diamond, that certain paths of light from the illumination source back to the viewer remain basically unchanged in spite of normal amounts of diamond tilt.

Both examples illustrate that we are on safe ground by evaluating the face-up 'snapshot' of diamond brilliance.

#### 4. Understanding brilliance in diamonds

It is clear from sections 2 and 3 that more can be learned about diamond brilliance if the analysis is done in a lighting environment that accounts for the viewer interference. The important viewing angle is the face up, 'normal' viewing position.

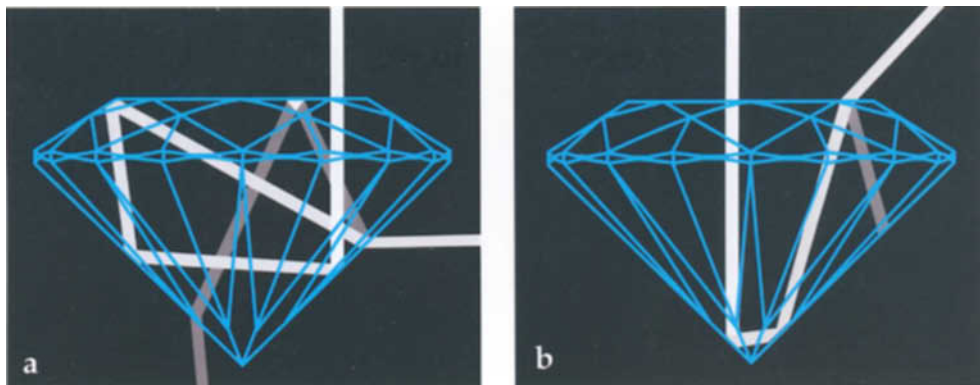
To study this single important viewing geometry, the 'normal snapshot', we only have to consider those light rays that emerge from the diamond's crown directly to our eyes along a path approximately perpendicular to the diamond's table. (The following discussion extends to any 'snapshot'.)

Each pixel or tiny area of a diamond can be thought of as refracting and reflecting light to our eyes from some angle and position in the space around the diamond. This is a good first order approximation. (That position varies slightly with the colour and polarization of the light ray, and there are additional secondary positions.)

Let us follow the path of light in reverse from the eye, along the perpendicular into the diamond through that tiny area in order to determine where it emerges. Because light follows the same path moving in either direction, that point of emergence and direction is the primary path along which light would have to enter the diamond in order to be seen in that pixel by the 'normal' viewer.

If that path of light emerges from the diamond below the girdle where there is no light, as in *Figure 4a*, no light will be seen in that pixel's area. (Notice that a weaker, secondary path of light reflection also exits below the girdle.) If the light path emerges in a direction above the girdle, as in *Figure 4b*, that pixel will be bright if light exists in that direction, as it is bound to under hemisphere lighting. However, as will be seen in the 'nail head' diamonds of *Figures 5a, 5b, 8c* and *9b*, if the viewer's head and body block some of the light, as they would in close-up examination of the diamond, the pixels reflecting light from the direction of the viewer will also be dark.

Because of multiple reflections and transmissions of each of these rays, there are other secondary paths from which light can reach the eye from any particular pixel (note *Figure 4a* for example). Strickland and Long's



**Figure 4:** (a) This point on the diamond's table will be dark because little or no light enters below the girdle. (b) This point on the diamond will be bright if there is light in the direction of this ray.

(pers. comm., 1999 and 2000) measure of brilliance defines the sum of all these contributions as the brilliance for that pixel, and summing across all the pixel areas gives the total brilliance of a diamond for the 'normal' viewing position.

When evaluating diamond proportion parameters for brilliance, it is important to consider where light rays would have to originate in order to reach the viewer's eyes. Diamond proportion parameters that cause most of the tiny pixel areas to refract and reflect light from directions where illumination exists will result in a brilliant diamond. The next two sections will contain examples of diamonds that exhibit inferior brilliance owing to areas on the diamond that refract and reflect light to the observer from directions where little light exists.

The methodology is to determine where each pixel or point on a diamond gets its light for each set of diamond proportions, and then to choose combinations of pavilion and crown angles that reflect the least light from the direction of the observer or from below the gemstone's girdle, where there is little or no source of illumination. This concept was first advanced by Harding (1975) and has had a significant impact on the determination of optimum angles for cutting gemstones. Glen and Martha Vargas published a portion of the work in chart form in *Faceting For Amateurs* (1977). However,

Harding's concepts appear to have been largely overlooked, or not understood, by those in the diamond and jewellery industry concerned with optimum angles for cutting diamonds.

Harding's work did not have all the answers, but he showed that good brilliance depends on avoiding combinations of crown and pavilion angles that reflect light to the viewer from his/her direction, as well as from below the gemstone's girdle. Instead of searching for ideal angles, Harding eliminated combinations of crown and pavilion angles that were clearly not ideal from this perspective. This process of elimination is a useful tool in narrowing the search for the possible range of ideal diamond proportions.

The computer faceting design software of Strickland, such as Gemcad, Gemray, Gemframe and Gemflick, can be used to simulate and measure diamond brilliance and explore these concepts. Strickland employs three-dimensional gemstone modelling with several illumination environments. His work and the work of others such as Long and Steele have taken faceting design to new levels of technological sophistication. In the present study, programs and work done by a group in Russia associated with Moscow State University have also been employed. This parallel effort in Russia has culminated in the

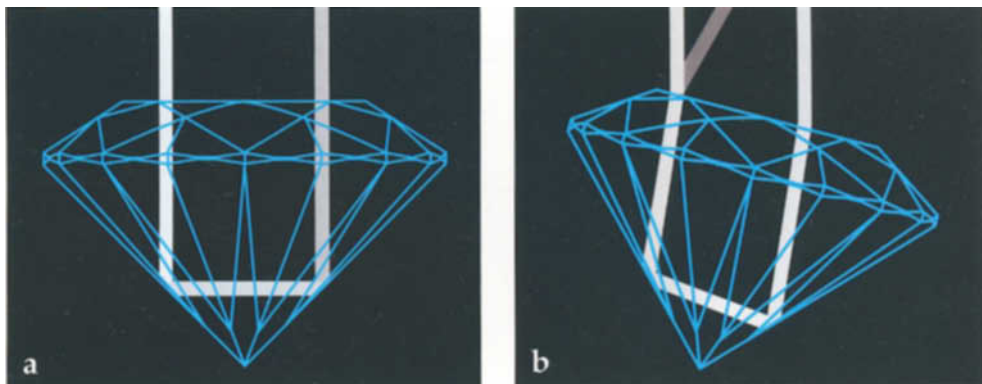


Figure 5: 'Nail head' diamond with pavilion angle of 45° (a) upright and (b) tilted 15°.

computer aided, diamond cut design software called DiamCalc and the MSU Diamond Cut Study. Led by Sergey Sivovolenko, OctoNus Software, Yurii Shelementiev, Gemology Center of MSU, and Anton Vasiliev, this Russian effort grew from work by Vasiliev that expanded on Harding's original work. The diamond cutting community could with advantage consider all these contributions and ideas in the quest for the proportions of the most beautiful round brilliant-cut diamonds.

## 5. The classic case of the 'nail head' diamond

Perhaps the best case to illustrate the need for incorporating the effect of the viewer's physical presence on brilliance is a diamond with pavilion main facets between 43° and 45°. This is known as the 'nail head' diamond owing to its dark appearance under the table relative to areas outside the table. Assignment 8 of the GIA Diamond Grading Course (1993), states: "If the pavilion is very deep, much of the light is leaking out. Then the table reflection and star facets look almost black, and the stone is called a 'nail head'."

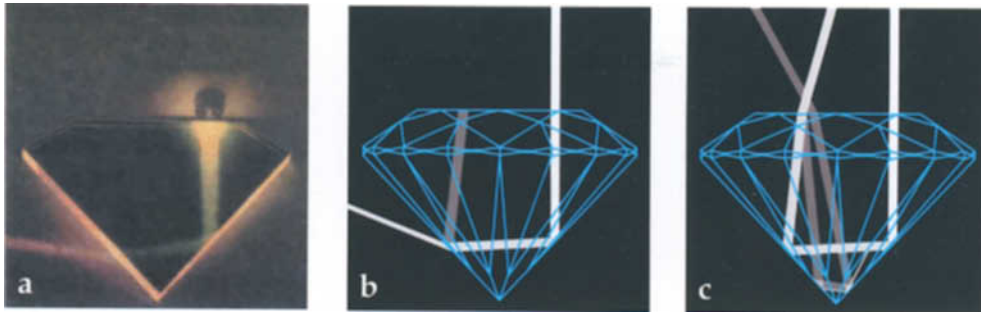
Pavilion main facets of 45° exactly mirror light from above through the table in those main facets sending light straight back towards its source. A viewer of such a diamond could observe a mirror image of

him/herself in those pavilion main facets. Furthermore, the head obscures any illumination from behind, causing those main facets to darken under the table. The pavilion girdle facets, which are cut between 1° and 2° steeper than the mains, also darken under the table giving the whole table area a darkness relative to areas outside the table.

Figures 5a and 5b, generated by the Russian computer software, illustrate light passage in a 'nail head' diamond with a pavilion angle of 45°. 'Nail head' diamonds reflect light from the direction of the viewer's head even when the diamond is tilted. Compare these to the diamond in Figure 4b, which has an 'Ideal' pavilion angle, causing light to reflect from an angle safely away from the viewer's head.

Much course and textbook literature attributes the undesirable 'nail head' appearance to light leakage out of the pavilion. Primary and secondary leakage (leakage at the first and second points of internal reflection) occurs to a greater extent in gemstones with lower refractive indices such as quartz, beryl or the plastic used in the GIA GEM Instruments' Proportion Comparator demonstration tool. Compare the Figure 6a photograph of the demonstration tool (courtesy of the Gemological Institute of America) and Figure 6b derived from the Russian computer software. They are similar and illustrate the secondary, pavilion light leakage that occurs





**Figure 6:** (a) Demonstration tool showing pavilion light leakage in a 'nail head' diamond (see text); (b) Path of light in plastic with a lower RI; (c) Path of light in diamond, (RI 2.42).

with steep pavilion angles in the plastic demonstration tool.

In diamond with its relatively high refractive index, the pavilion angle would have to approach  $52.5^\circ$  before this type of leakage became apparent in the pavilion mains in the table in the face-up viewing position. The 'nail head' appearance is evident in diamonds with pavilion angles between  $43^\circ$  and  $45^\circ$ . Thus, as we see in Figures 5a, 5b and 6c, the dark 'nail head' appearance is due not to loss of light through the pavilion, as was commonly believed and taught. Rather, it is due to a steeper than 'Ideal' pavilion that is reflecting light to the 'normal' observer from the area of his head rather than from an unobscured source of illumination.

A computer model of the 'nail head' diamond will not show the darkening caused

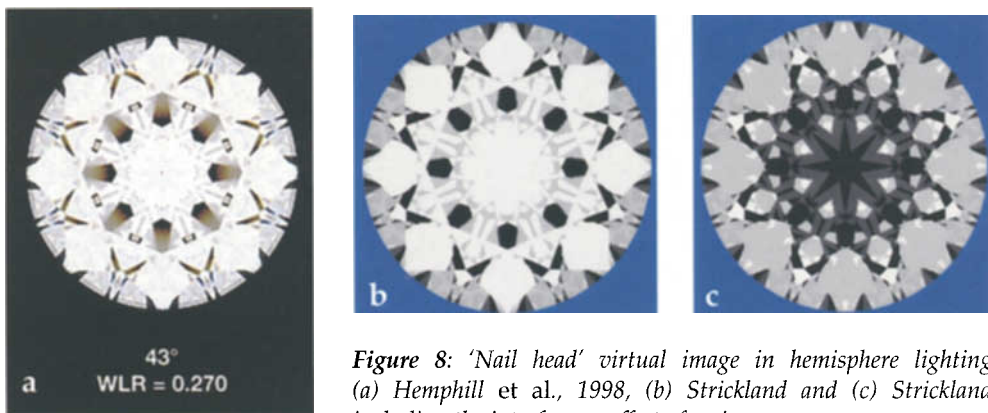
by the observer's head if the illumination model does not take into account the way light is blocked by the physical presence of the observer. To support this, note that Hemphill *et al.* (1998, p.171) state:

*"Pavilion Angle.* This is often cited by diamond manufacturers as the parameter that matters most in terms of brilliance ... Images of virtual diamonds with low, optimal, and high pavilion angles (again, see Figure 5) are consistent with the appearances that we would expect for actual diamonds with these pavilion angles ('fish-eye', normal, and 'nail head')."

When we look at these virtual images in Figure 7, the 'nail head' example on the right does not appear consistent with the appearance of 'nail head' diamonds. Instead of being dark under the table, the virtual image shown is extremely bright in the



**Figure 7:** From GIA study Figure 5 (Hemphill *et al.*, 1998).



**Figure 8:** 'Nail head' virtual image in hemisphere lighting: (a) Hemphill et al., 1998, (b) Strickland and (c) Strickland, including the interference effect of a viewer.

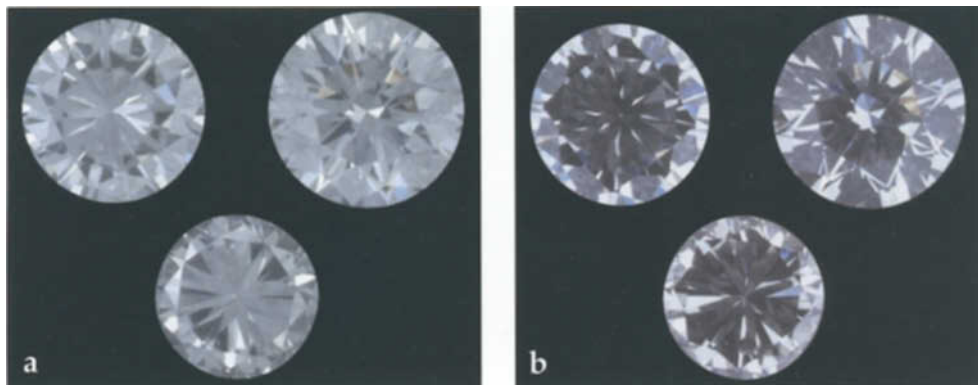
centre two-thirds of the table. Compare the virtual image of the 'nail head' diamond in *Figure 8a*, reproduced from Hemphill *et al.* (op. cit.) with the virtual image of the same 'nail head' diamond in *Figure 8b* that has been generated by a new version of Strickland's Gemray computer software and uses hemisphere lighting similar to that described by Hemphill *et al.* (op. cit.).

Though Strickland's model uses only one RI and averages the ray polarization, the *Figure 8a* and *8b* images depict a similar bright centre that is unlike the appearance of a 'nail head' diamond. By introducing the effect of the viewer blocking some of the light from above, a new virtual image is generated (*Figure 8c*). This looks darker under the table and is much more like the familiar appearance of a 'nail head' diamond. Also the light return falls off more as expected when compared to the 'Ideal'. In hemisphere lighting, Hemphill *et al.* (1998) found only a 0.282 to 0.270 = 4.25% drop-off in WLR between an 'Ideal' cut and this 'nail head' diamond. The truly dark 'nailhead' appearance is more apparent in diamonds with a pavilion depth of 48% to 50%, which corresponds to pavilion main angles of 44° to 45°. The 'nail head' discussed and pictured here, with 43° pavilion, is only beginning to darken under the table. It took a large amount of light blockage, simulating close-up inspection, to produce *Figure 8c*.

To further demonstrate the importance of the type of illumination, we created a

photographic set-up using three actual diamonds: a close to 'Ideal' cut and two 'nail heads'. Two lighting environments were used. The first approximates hemisphere lighting with diffuse illumination in a 180° hemispherical arc above the diamond's girdle plane. The second also approximates hemisphere lighting but with light blocked in an area above these diamonds to simulate the close-up viewing situation. In both cases, the three diamonds were photographed simultaneously. Interchanging them produced essentially no change in appearance, verifying that, for comparative purposes, each was illuminated in the same manner. (In both cases the diffuse illumination was not as even as in the computer model due to use of two diffused fibre optic light sources.)

In the diffuse hemisphere lighting photograph (*Figure 9a*), all three diamonds have similar even brilliance. There is slightly more brilliance in the near 'Ideal' cut due to some dark areas in the outer table region of the 'nail head' diamonds. However, the two 'nail heads' are very bright in the middle portion of their tables, just as in *Figures 8a* and *8b*. Contrast this with the dramatic darkening of the whole table and star facet areas of both 'nail head' diamonds in *Figure 9b*. This appearance is consistent with Strickland's virtual image of the 'nail head' diamond in *Figure 8c*, because it has accounted for the viewer blocking light directly over the diamond in the 'normal' viewing position.



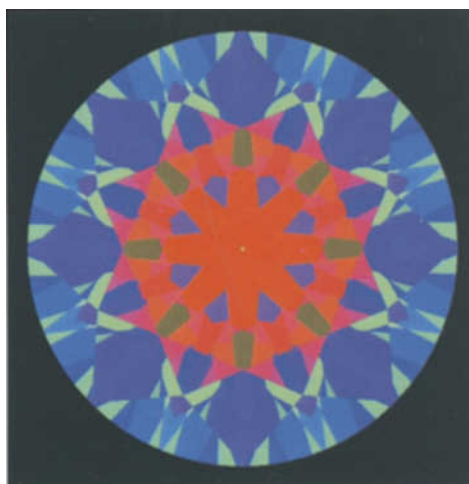
**Figure 9:** 'Nail heads' vs. near 'Ideal' cut diamonds (a) in hemisphere lighting created by diffusing two fibre optic light sources, and (b) in hemisphere lighting partially blocked as in close-up inspection.

**Table I:** Proportions of diamonds in Figures 9a and 9b.

Position	Diamond	Weight (ct)	Colour	Table Size (%)	Crown Angle (°)	Pavilion Angle (°)
Top left	'Nail head' 1	0.58	H	69	30.0	42.6
Top right	Near 'Ideal'	0.74	G	56	36.0	40.9
Bottom	'Nail head' 2	0.49	I	74	37.6	43.7

This is photographic evidence that the typical 'nail head' appearance in a diamond with deep pavilion angles is not seen in hemisphere lighting. It is observable in lighting environments where little or no light is available in the area above the diamond such as occurs in the case of close-up inspection by the 'normal' viewer.

The following demonstration was inspired by a jeweller's deduction that if his head were truly causing the darkness, rather than light leakage being the cause, looking close up at a 'nail head' diamond with a red bag over his head should turn the diamond's table to red instead of it simply looking dark. Employing the Russian DiamCalc software, the Hemphill *et al.* (1998) example of a 'nail head' diamond has been illuminated with blue hemisphere lighting above the girdle. Instead of having no light below the girdle plane, we have added a lower hemisphere of green illumination. The effect of the jeweller's head, covered with the red bag,



**Figure 10:** GIA's 'nail head' example in the reflection source detector.

has been simulated by a circle of red illumination over the diamond. The pattern of colours seen in the computer simulation of the face-up appearance of the 'nail head' illuminated in this manner shows from where each point on the diamond's surface is reflecting its light.

A green table would verify the occurrence of light leakage from the pavilion, because the green illumination would follow the reverse path to the 'normal' observer through the area which was leaking and turn it green. A red table would verify that the viewer's head interference is the cause of the 'nail head' diamond appearance. Areas of blue would have neither of these problems.

As the jeweller with the red bag on his head learned, the table shows red rather than green (see *Figure 10*) providing further support for the cause of table darkening in a 'nail head' diamond. Outside the diamond's table there are green spots indicating light leakage in those regions of the diamond. The blue spots within the table show small regions that do not have either the problem of light leakage or viewer interference. In a 'nail head' cut with very good symmetry one would predict that these small spots within the table should be bright. If we refer again to the actual photograph of the 'nail head' diamond in the upper left of *Figure 9b*, those bright points, which this demonstration predicts, are apparent. The predictive ability of this reflection source detector adds verification of its utility.

## 6. The case of shallow crown main angles

While examining many diamonds in various lighting environments, it has been noticed that diamonds with shallow crown angles below 33° are darker and less brilliant than an 'Ideal' cut when viewed close-up. This observation seems to conflict with GIA Gem Trade Lab Reports concerning crown angles.

In their diamond grading reports, the GIA Gem Trade Lab adds the comment, "crown angles less than 30 degrees" when

appropriate. The Laboratory allows a 4.5° variation below Tolkowsky's 34.5° before this critical comment is included. The comment, "crown angles greater than 35 degrees" is added if they exceed 36° (pers. comm., 'Gem Trade Lab', June 1999). This only allows 1.5° of variation above the 'Ideal' and implies that as little as 0.5° upward variation above 34.5° is detrimental. To avoid these critical comments, diamond cutters and dealers must maintain the diamond's crown angle between 30° and 36°. This sends the message that relative to Tolkowsky's 34.5° 'Ideal' crown angle, shallower crown angles are more acceptable than steeper ones.

Hemphill *et al.* (1998) reinforce the idea that shallow crown angles are better in relation to a diamond's brilliance. Their study reported: "In general, WLR increases as crown angle decreases. ... These results suggest that, at the reference proportions, a diamond with a 23° crown angle is brighter than a stone with any other crown angle greater than 10°. ... Ironically, the highest WLR values are obtained for a round brilliant with no crown at all" (p.170).

These results run contrary to the present analysis of close-up viewing of diamonds with shallow crown angles between 28° and 32° compared to those between 33° and 36°. Diamonds with shallow crown angles appear darker and less brilliant when viewed close-up. Diamonds with as little as a 2.5° lower crown angle look less brilliant than those with crown angles of 34.5°. The same variation in the opposite direction does not appear to produce this loss in brilliance compared to the 'Ideal'.

Watermeyer (1982) made the following observation when viewing a diamond's mains:

"When the crown is cut on 30° the area outside the table reflection becomes a darker grey. At 29° the diamond appears blackish in colour with only the table reflection remaining white."

In this paraphrase of his words, Watermeyer was referring to a diamond



Figure 11: 'Ideal' vs. slightly shallow crown angle diamonds.



Table II: Proportions of diamonds in Figures 11a, 11b and 11c.

Position	Diamond	Weight (ct)	Colour	Table Size (%)	Crown Angle (°)	Pavilion Angle (°)	Pavilion Depth (%)	Girdle
Top	AGS 0 'Ideal'	0.47	E	54	35.3	41.2	43.8	thin
Bottom	Near 'Ideal'	0.46	G	56	32.6	41.0	43.5	thin

“when in full eight sides” (before the 40 star and girdle facets are cut). We will see that his observations still apply to a completed diamond in the pavilion main facet areas of the diamond.

To demonstrate this, two diamonds in the ‘normal’ viewing position under three different lighting conditions were photographed. The diamonds are a close match in most respects, except for crown angle (see Table II). This presents a valuable opportunity to document how variations in the crown angle alone affect the brilliance in differing lighting environments. The top diamond meets AGS 0 tolerances for ‘Ideal’,

while the bottom diamond has an ‘Ideal’ pavilion angle and table size, but has a lower 32.6° crown angle.

The first lighting environment approximates hemisphere lighting, having diffuse illumination in a 180° hemispherical arc above the diamond’s girdle. In this lighting both diamonds appear to the eye and the camera lens to be similar in brilliance (see Figure 11a).

The second lighting environment (Figure 11b) has more the flavour of jewellery store lighting. In addition to hemisphere lighting, it contains two ‘hot spots’. Like jewellery store spotlights, these improve dispersion or



**Figure 12:** Reflection source detection of simulation of bottom diamond in Figure 11c with 32.6° crown angle.

fire in the diamond. In this lighting, both diamonds appear to the eye to be equally brilliant, although the photography makes the 'Ideal' cut (top) look slightly better. Both diamonds exhibit similar dispersion.

The third lighting environment approximates hemisphere lighting but with little light in an area directly above to simulate a close-up viewing situation (Figure 11c). There is now a dramatic decrease in brilliance in the diamond with a shallower crown angle compared to the 'Ideal'. The bottom diamond's eight main facets have gone dark everywhere except for the central bright circular area, which is the table reflection. This is the area where light, which has entered the table, reflects to the 'normal' viewer. The pattern of darkness in the main facet areas is just as observed by Watermeyer (1982) when he described the appearance of diamonds with crown mains cut on 30° and below.

This is photographic documentation that when viewed close-up in real lighting environments, shallow crown angles produce less brilliance than Tolkowsky's 34.5°, just as diamond cutters such as Watermeyer and others have observed. Photography or computer modelling can only capture this fact using an illumination environment where little or no light is available directly above the diamond to

simulate the circumstances of close-up inspection.

The red head reflection source detection can be employed to further document the cause of the darkening of the eight mains in the diamond with shallower than 'Ideal' crown angles. As observed in Figure 12, the red areas show that the close-up viewer's head interference is the cause of the darkening in the main facet areas outside the table reflection. The blue table reflection correctly predicts that the diamond will remain bright in that inner circle as it does in the diamond of Figure 11c (bottom) with a halo of darkness surrounding it.

As the viewer looks at an 'Ideal' cut diamond, from closer distances, there is a point where it too will darken in the main areas. As the crown angle is decreased, the point at which the viewer's interference causes the mains to darken occurs at farther viewing distances.

Darkening of the mains due to the blocking of light from above the diamond is also illustrated with devices such as the Firescope®. This diamond viewing instrument was developed in Japan in 1977 to demonstrate diamond brilliance. This device reveals the well-known, eight-rayed arrows pattern which characterizes the Eightstar® and subsequent 'hearts and arrows' type diamond cuts. Figure 13 (courtesy of Eightstar® Diamond Co.) shows a photograph of the Firescope® view of the arrow pattern in an 'Ideal' cut diamond. In place of the red head of the model is the darkness due to the Firescope's® viewing lens. Instead of green illumination from below, the Firescope® has white light, and red illumination exists in place of the blue computer illumination. Besides colour, the main causes of the differences in the pattern of these images are the diamonds' proportion parameters and the proximity of the viewer interference.

This comparison illustrates a similarity in properties between the reflection source detector and the Firescope®. The Firescope® may be used to analyse light reflection in



**Figure 13:** Firescope® image of 'Ideal' cut diamond with 34.5° crown angle (courtesy of Eightstar® Diamond Co.)

diamonds in a fashion similar to the reflection source detector. Extensions of this hardware device for more detailed analysis of diamond light return was the idea of gemmologist A. Gilbertson in 1996, who is using multi-coloured lighting devices to study the efficiency of light return in diamonds and other gemstones (pers. comm.).

## 7. The wisdom of Marcel Tolokowsky

Can the optimum range of pavilion, crown and table proportions be worked out with a simpler model than the complete 3D model? Can a 2D model such as Tolokowsky's establish the range of ideal combinations of crown, pavilion and table proportions, or was his analysis inadequate because it was only two-dimensional?

To begin answering these questions, compare the diamond model images published by Tolokowsky in 1919 with those appearing in recent times (see *Figures 14a, b* and *15a, b*).

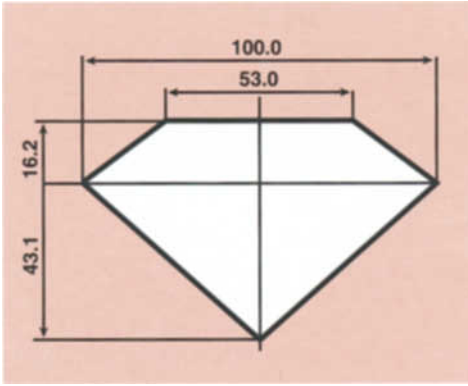
There are three principal differences reflecting the changes in 'Ideal' diamond cutting from Tolokowsky's time until today. First, Tolokowsky did not consider girdle thickness but assumed a knife-edge girdle. Secondly, his table is 53%, which is smaller

than is normally cut today. Thirdly, the pavilion (or lower) girdle facets extend only 50% of the way to the culet of Tolokowsky's drawing from 1919, while they extend at least 75% down the pavilions of diamonds cut today.

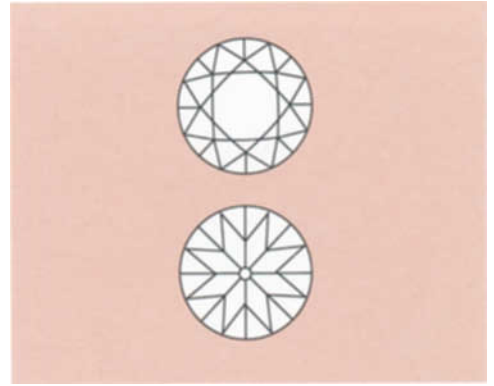
It is important to understand that the three parameters (pavilion main facet angle, crown main facet angle and table percentage) were all that Tolokowsky was attempting to optimize for brilliance. Other proportion parameters such as total depth percentage are a result of the choice of these three and the choice of a reasonable girdle thickness. Tolokowsky knew, as do most gemstone cutters, that the interaction of the pavilion angle, crown angle and to a lesser extent the table percentage has the greatest influence on brilliance. The other proportions, such as the lower-girdle facet angles (which are cut between 1° and 2° steeper than the pavilion main angle), are chosen relative to these three parameters.

Thus, obtaining optimum brilliance and beauty in a round brilliant-cut diamond simplified to finding the best combination(s) of these three most important cutting parameters. This is what Tolokowsky endeavoured to accomplish. Because his model was two-dimensional, he only considered a cross-section or plane through the diamond perpendicular to the pavilion mains and crown mains, so only rays of light travelling in that plane were studied. This covers a more significant portion of the diamond than one might imagine. Because the round brilliant-cut has four-fold, mirror image symmetry, that cross-section repeats in eight positions around the diamond. In *Figure 11c*, for example, the eight dark main facet areas in the bottom diamond are where Tolokowsky's analysis would apply, since his two-dimensional model plane was a slice through the mains and table.

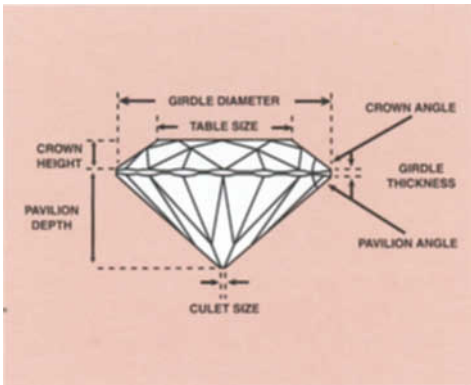
Tolokowsky is credited with revolutionizing diamond cutting with publication of his book *Diamond Design* in 1919, and his crown and pavilion angles are



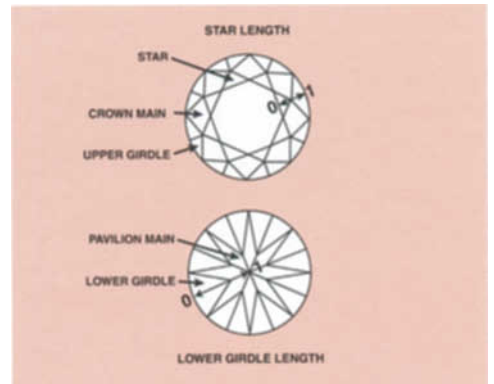
**Figure 14a:** *Tolkowsky's drawings from Diamond Design (1919).*



**Figure 14b:** *Tolkowsky's drawing of the round brilliant-cut top and bottom views from Diamond Design (1919).*



**Figure 15a:** *Profile diagram of a modern round brilliant.*



**Figure 15b:** *Top and bottom diagrams of modern brilliant.*

still considered 'Ideal' today. Both are indications of the validity of his conclusions relating to those two angles. Tolkowsky (1919) says:

"The gradual shrinking-in of the corners of an old-cut brilliant necessitated a less thickly-cut stone with a consequent increasing fire and life, until a point of maximum brilliancy was reached. This is the present-day brilliant", and he goes on to say, in a footnote, "Some American writers claim that this change from the thick cut to that of maximum brilliancy was made by an American cutter, Henry D. Morse."

Then he says: "In the next chapters the best proportions for a brilliant will be calculated without reference to the shape of a rough diamond and it will be seen how startlingly near the calculated values the modern well-cut brilliant is polished."

While many credit Tolkowsky with the development of the 'Ideal' cut diamond, we see from his own words that diamond cutters such as Henry D. Morse had been cutting maximum brilliance diamonds (as defined by Tolkowsky) for years before he wrote his book. We also see that Tolkowsky placed great importance on ensuring that his results



agreed with what the best cutters of diamonds had been practising for years before his book. When his mathematical analysis verified these proportions he declared the following in his Mathematics Chapter:

“In the course of his connection with the diamond-cutting industry the author has controlled and assisted in the control of the manufacture of some million pounds’ worth of diamonds, which were all cut regardless of loss of weight, the only aim being to obtain the liveliest fire and the greatest brilliancy. The most brilliant larger stones were measured and their measures noted. It is interesting to note how remarkably close these measures, which are based upon empirical amelioration [improvement] and rule-of-thumb correction, come to the calculated values.”

Tolkowsky’s words indicate that he was acutely aware and in awe of the diamond cutters’ skill in developing the proportions that had been in use for many years to produce optimum brilliance and dispersion. Because his mathematics confirmed these proportions he concluded: “We may thus say that in the present-day well-cut brilliant, perfection is practically reached; the high-class brilliant is cut as near the theoretical values as is possible in practice, and gives a magnificent brilliancy to the diamond.”

The last words in his book are: “It seems likely that the brilliant will be supreme for, at any rate, a long time yet.”

Although there have been changes such as increases in table size and girdle thickness and lengthening of the lower girdle facets, his basic findings concerning the best pavilion and crown angles have held up for eighty years.

## Conclusions

The GIA is making a concerted effort with its computer modelling to explore the extent to which the proportion parameters may be

varied and still retain or exceed the beauty of the current ‘Ideal’. Hemphill *et al.* (1998) state that their study results “do not support the idea that all deviations from a narrow range of crown angles and table sizes should be given a lower grade”.

The study, computer modelling and diamond photography presented above demonstrate that, with an illumination that accounts for interference from the ‘normal’ viewer, the possible range of deviations from ‘Ideal’ proportions can be narrowed. In summary:

- (i) A measure of brilliance must agree with human judgement. Observations of the effects of diamond proportions on brilliance by diamond cutters from Tolkowsky to Watermeyer, and observations by people in the diamond trade and consumers provide the litmus test for conclusions drawn from computer modelling of brilliance in diamonds.
- (ii) An illumination that takes into account the observer’s physical presence is necessary to reveal the loss in brilliance in the ‘nail head’ and diamonds with shallow crown angles.
- (iii) Diamond cutters and the GIA Diamond Course are correct in their adherence to close to a 41° pavilion angle as the single most important proportion. The present work shows that the 43° to 45° pavilion angles lower brilliance under close-up inspection by a greater amount than hemisphere lighting revealed. (There are further reasons why the pavilion angle should have a smaller tolerance than 2° around 41° that may be demonstrated in a continuation.)
- (iv) With the pavilion angle held close to 41°, crown angles below Tolkowsky’s 34.5° yield decreasing brilliance under close-up observation in spite of the fact that they show increasing WLR in hemisphere illumination. With a



**Figure 16:** Parker's cut with a 55.9% table, 25.5° crown angle, and 40.9° pavilion angle.



**Figure 17:** 'Ideal' cut resulting from increasing the Parker's cut crown angle by 9°.

pavilion angle near 41°, shallow crown angles are not a direction to go in search of greater brilliance.

- (v) When a diamond is graded for cut, crown and pavilion angles are the important proportions that should be measured along with table size, rather than total depth or even crown height and pavilion depth percentages. As gemstone cutters know, these angles most directly affect the gemstone brilliance. Many diamonds that possess an 'Ideal' total depth have thin crown heights and shallow crown angles with a deep pavilion depth to compensate. This yields an 'Ideal' depth even though the brilliance and beauty of the diamond is negatively affected owing to the faults discussed in section 5 and section 6. Also, a greater than 'Ideal' pavilion angle, producing a deep pavilion, can be made to measure within AGS tolerance of the 'Ideal' pavilion depth by cutting a medium culet facet.
- (vi) The illumination of the diamond has as much influence on the measure of brilliance as the diamond's proportions do. In *Figures 1 and 2b*, the differing illumination environments have caused the diamond in *2b* to have greater light return, but the diamond in *Figure 1* would normally be judged to be more

brilliant because of the 'surface sparkle' or 'snappy' contrast between its facet reflections. Although both of these diamonds are 'Ideal' cut, the illumination has made them appear dissimilar. Illuminating a diamond from enough different angles can cause even the most poorly proportioned diamonds to have high light return. By employing typical rather than averaged illumination environments, and by including consideration of the physical presence of the viewer, a measure of brilliance can better separate diamonds of 'Ideal' proportions from those of poor proportion.

- (vii) Computer modelling programs, such as those of Hemphill *et al.* (1998), Strickland (1992, 1993) and Sivovolenko *et al.* (2000), are effective tools for exploring diamond brilliance. For a final illustration supporting this the Parker's cut is examined. This was the diamond that Hemphill *et al.* (1998, p.178) calculated to have "the highest WLR (0.297)". The diamond images of *Figures 16 and 17* were generated with the Russian DiamCalc software using a representation of jewellery store lighting, which included the effect of a close-up viewer. Parker's cut appears in *Figure 16*. By increasing the crown angle by 9°, the Parker's cut becomes the AGS

0 'Ideal' pictured in Figure 17. Visual comparison of these leave little doubt as to which is more brilliant in this lighting environment.

These images support the idea that aspects of brilliance including the amount of light return and 'surface sparkle' can be effectively studied with computer modelling using a face-up 'snapshot' generated using illumination representative of normal viewing conditions.

## Acknowledgements

Thank you to Bruce Harding, William Day, Robert Strickland, Martin Haske and Donald Dietz for many hours of intense discussion, peer review, ideas and suggestions gratefully received which contributed greatly to this work. Thank you to Sergey Sivovolenko and Anton Vasiliev for personal communication of their work and all at Octonus for custom modifications to their software product enabling the fine computer imaging.

## References

- Boyajian, W., 1998. Editorial. *Gems & Gemology*, 34(3), 157
- Bruton, E., 1978. *Diamonds*. Chilton Book Co., PA, 532pp
- Eulitz, W., 1975/76. The variable effects of faceted gemstones. *Gems & Gemology*, 15(4), 98
- Gemological Institute of America, 1979 and 1994. Diamond Grading Courses
- Harding B., 1975. Faceting limits. *Gems & Gemology*, 15(3), 78
- Hemphill, R., Reinitz, I., Johnson, M., and Shigley, J., 1998. Modeling the appearance of the round brilliant cut diamond: an analysis of brilliance. *Gems & Gemology*, 34(3), 158-83
- Gaal, R., 1977. *The Diamond Dictionary*. Gemological Institute of America, California, 342 pp
- Sivovolenko, S., OctoNus Software, and Shelementiev, Y., Gemology Center of MSU, and Vasiliev, A., 'LAL' Optics, 'MSU Diamond Cut Study', personal communication, March, 2000. DiamCalc Software and Internet Site <http://www.gemology.ru/octonus>
- Strickland, R., 1992. *GemCad User's Manual*. © 1992 Robert W. Strickland, 69 pp

- Strickland, R., 1993. *Gemray, GemFrame and GemFlick Users' Guide*. © 1992, 1993 Robert W. Strickland, 12pp
- Tolkowsky, M., 1919. *Diamond Design*. Spon & Chamberlain, New York, 104 pp
- Vargas, G. and M., 1977. *Faceting For Amateurs*. 2nd edn. Published by the authors, California, 345 pp
- Watermeyer, B., 1982. *Diamond Cutting*. 2nd edn. Centaur, Johannesburg, 406 pp

## LONDON DIAMOND REPORT



The  
Gem Testing  
Laboratory



Diamond grading service  
established in 1980

Each diamond graded by  
three experienced graders

Report based on the current  
international grading  
procedures for colour and clarity

Whether buying or selling,  
the London Diamond Report  
assures the prestige of your stone

The Gem Testing Laboratory of Great Britain  
GAGTL, 27 Greville Street, London EC1N 8TN  
Telephone: 020-7405 3351 Fax: 020-7831 9479

## Gem Diamond Diploma Programme

# Your DGA in only four months!

Take the course and examinations at GAGTL's  
London Gem Tutorial Centre. Theory and practical tutorials every  
Thursday from 10 a.m. to 5 p.m.

### The fee of £1670 includes:

Tuition fees, course notes and examination fees  
GAGTL membership for 2001

A basic kit, including 10x lens, stone tongs, stone cloth and a diamond model

### Course start date: 8 February 2001

Exam date: Theory 13 June 2001 (practical on same or subsequent day)

For further details and an application form contact the  
Education Department on 020 7404 3334 (Fax: 020 7404 8843)

## SYNTHETIC MOISSANITE MEGGER TESTER

The easy way to distinguish synthetic moissanite from diamond



- User friendly
- Portable - battery operated
- Can test mounted and loose stones

Normally Priced at £125

**SPECIAL OFFER TO GAGTL MEMBERS  
of only £105\***

plus VAT, postage and packing  
\*offer ends 31 December 2000

*To be used in conjunction with a LW ultraviolet lamp  
(Cat. No. ULV 0004 £12.25 plus VAT, postage and packing).*

It is recommended that stones be tested with a thermal tester to eliminate  
other diamond simulants before the Megger Tester is used.

### Gemmological Instruments Ltd.

27 Greville Street (Saffron Hill entrance), London EC1N 8TN  
Tel: 020 7404 3334 Fax: 020 7404 8843



# Oriented inclusions in spinels from Madagascar

Dr Karl Schmetzer<sup>1</sup>, Prof. Dr Eduard Gübelin<sup>2</sup>, Dr Heinz-Jürgen Bernhardt<sup>3</sup>,  
and Dr Lore Kiefert<sup>4</sup>

1. Taubenweg 16, D-85238 Petershausen, Germany,

2. Haldenstr. 4, CH-6002 Luzern, Switzerland,

3. Institut für Mineralogie, Ruhr-Universität, D-44780 Bochum, Germany,

4. SSEF Swiss Gemmological Institute, CH-4001 Basel, Switzerland

---

**ABSTRACT:** Orientated inclusions in bluish-grey gem spinels from Madagascar were determined by a combination of qualitative and quantitative electron microprobe analysis with laser Raman microspectroscopy as enstatite, MgSiO<sub>3</sub>. A possible origin of the spinels from the sapphire and spinel-bearing deposits of Andranondambo and Ilakaka, southern Madagascar, is briefly discussed.

---

## Introduction

Oriented needle-like inclusions in cubic host minerals are responsible for the six-rayed and/or four-rayed stars in asteriated spinels and garnets (see e.g. Kumaratilake, 1998). This inclusion pattern is frequently observed in spinels and especially in garnets from different localities. Lamellar inclusions in cubic gem minerals, on the other hand, are quite rare. As an example, the determination of högbomite lamellae that are oriented parallel to octahedral {111} faces of Tanzanian spinels has been described by Schmetzer and Berger (1992).

In Madagascar, large quantities of gem-quality spinels are now recovered from the gem gravels around Ilakaka (Hänni, 1999; Schmetzer, 1999, 2000), but spinel was also mentioned from the skarn-related sapphire deposit of Andranondambo in southern Madagascar (Kiefert *et al.*, 1996; Gübelin and Peretti, 1997).

## Gemmology of the spinels

The lamellar and needle-like inclusions in gem-quality spinels to be described in this paper were observed in a parcel of six light bluish-grey faceted samples ranging from 0.15 to 0.50 ct. The owner of this parcel indicated that these spinels originate from an unknown locality in southern Madagascar and were faceted in their country of origin. He also indicated that this parcel had been purchased about four years ago on a local gemstone market.

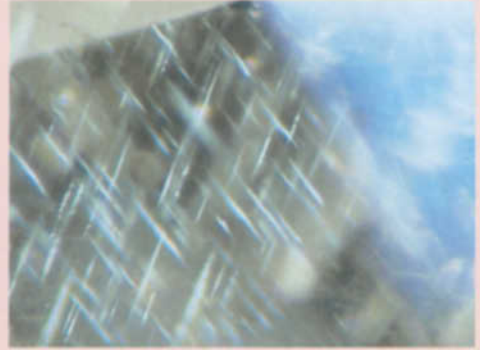
Gemmological properties of the samples are normal for natural gem spinels, and the absorption spectra in the visible and ultraviolet range are typical for spinels containing iron.

Several sets of lamellar inclusions were observed by microscopic examination in three of the samples. In one specific orientation of the hosts, an equilateral triangular network of three sets of birefringent lamellae was observed (Figure 1).

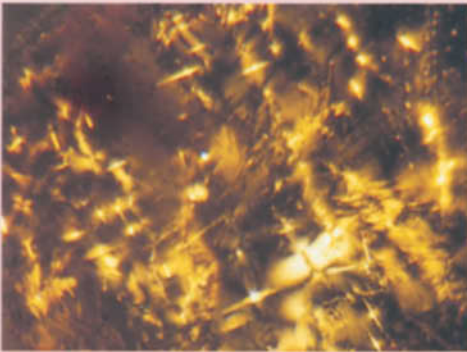
## Inclusions in spinel from Madagascar



**Figure 1:** Three sets of birefringent lamellae that form an equilateral triangular pattern are observed in a view parallel to one of the three-fold axes of the host. Immersion, crossed polarizers, magnified 80x. Photomicrograph by K. Schmetzer.



**Figure 2:** Two sets of birefringent lamellae that are inclined to each other are observed in a view parallel to one of the three-fold axes of the host. Dark field, fibre optic illumination, magnified 65x. Photomicrograph by E. Gübelin.



**Figure 3:** Birefringent crystals with various shapes are oriented parallel to specific planes within the host. Immersion, crossed polarizers, magnified 70x. Photomicrograph by K. Schmetzer.



**Figure 4:** Oriented lozenge-shaped or needle-like crystals, some with a distinct jagged outline. Dark field, fibre optic illumination, magnified 100x. Photomicrograph by E. Gübelin.

Occasionally, lamellae that are inclined about  $60^\circ$  to each other were observed only in two of these three orientations (Figure 2). In another direction of view, two sets of lamellae were found that formed a rectangular inclusion network. These microscopic observations indicate that the lamellae are oriented parallel to the dodecahedral  $\{110\}$  faces of the host spinels. The observation of a triangular pattern of three or two sets of parallel lamellae that are inclined to each other is consistent with a

view of the samples parallel to one of the three-fold  $\langle 111 \rangle$  axes, and the observation of a rectangular pattern of two sets of parallel lamellae is consistent with a view parallel to one of the four-fold  $\langle 100 \rangle$  axes of the cubic spinels.

The remaining three samples showed an inclusion pattern, which can be described as 'incomplete lamellae'. Again, inclusions are oriented parallel to distinct planes. Some of these inclusions are small fragments of a

lamella with irregular or jagged boundaries, others were developed as lozenge-shaped or needle-like crystals, but with all elongated axes of the birefringent inclusions orientated parallel to specific crystallographic directions within the spinel hosts (Figures 3 and 4).

Three of the six samples mentioned (designated A, B and C) revealing a dense pattern of lamellar to needle-like inclusions were selected for further examination. For the determination of inclusions in these three spinel host crystals, electron microprobe analysis and laser Raman microspectroscopy were applied. We tried to analyse inclusions that were exposed on the tables of the spinels, sometimes after having repolished these faces to avoid contamination in small cavities. One of the samples (spinel B) was cut into slices and after repolishing the surfaces, the inclusions exposed were examined by both techniques. All procedures were rather time consuming, and because the inclusions are close to 1  $\mu\text{m}$  across - the diameter of the electron or laser beams - it was extremely difficult to find inclusions that gave conclusive results.

By microprobe analysis of samples A and C we were unable to separate the signals of the inclusions from the characteristic Mg-Al X-ray pattern of the host spinel. For all inclusions of this type examined, we only observed one additional characteristic X-ray line of Si (together with the lines of Mg and Al). This result indicates that the inclusions are magnesium-, aluminium- or magnesium-aluminium-silicates.

On slices of sample B we observed some 'larger' inclusions with thicknesses up to 5  $\mu\text{m}$ , which allowed us to perform quantitative microprobe analysis of the crystals. We found that these birefringent minerals were magnesium silicates with smaller percentages of iron and aluminium (Table I). The quantitative data indicate that the inclusions are enstatites  $\text{MgSiO}_3$ .

These results were confirmed by Raman analysis. In all samples, a strong fluorescence of the host spinels interfered with the Raman spectra of the inclusions.

**Table I: Chemical properties of enstatite inclusions in spinel**

Wt%	Crystal 1	Crystal 2
	Mean of 4 anal.	Mean of 2 anal.
$\text{SiO}_2$	58.30	58.56
$\text{Al}_2\text{O}_3$	2.54	2.61
MgO	38.11	38.34
FeO	1.26	1.22
CaO	0.06	0.08
Total	100.27	100.81
<i>Cations based on 6 oxygens</i>		
Mg	1.904	1.905
Fe	0.035	0.034
Ca	0.002	0.003
Al	0.100	0.103
Si	1.954	1.953
Total	3.997	3.997

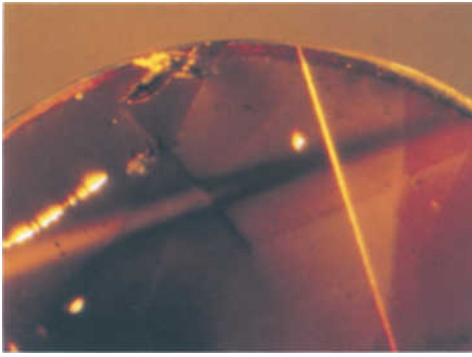
Nevertheless, we obtained Raman lines typical for enstatite from several inclusions of samples B and C.

In summary, we were able to perform qualitative chemical analysis of inclusions of samples A and C and we even obtained quantitative chemical data of two crystals in sample B. Significant Raman spectra were measured for inclusions in samples B and C. All data indicate that the orientated inclusions in the spinel were enstatite.

The literature was searched for data relating to the co-existence of spinel and enstatite but none were found which described an exsolution of enstatite in spinel or an oriented intergrowth of both minerals. Determination of the mode of origin of the enstatite lamellae must await further experimental data.

### Source of the spinels

Spinel occurs within the rocks of the sapphire- and spinel-bearing skarn area of southern Madagascar, but enstatite was not



**Figure 5:** Lamella in purple spinel from Ilakaka, Madagascar, consisting of polycrystalline rutile. Immersion, crossed polarizers, magnified 50x. Photomicrograph by K. Schmetzer.

reported from these mineral assemblages (Rakotondrazafy *et al.*, 1996; Kiefert *et al.*, 1996; Schwarz *et al.*, 1996; Gübelin and Peretti, 1997; see also Pezzotta, 1999).

The spinel samples examined were purchased at least two years before the new Ilakaka deposit in southern Madagascar was discovered and intensely exploited. In about 120 blue, bluish-green, violet, purple or pink spinels from Ilakaka recently examined by one of the authors (see Schmetzer, 2000), only one rough sample with a lamellar inclusion was found. After faceting of this dark purple spinel, the lamella was exposed on the surface of one smaller facet (Figure 5) determined by the Raman technique to be rutile. A careful microscopic examination showed that the lamella consists of numerous small rutile crystals.

Consequently, there is no indication that the spinels with various forms of enstatite inclusions might come either from the Andranondambo or from the Ilakaka area in southern Madagascar and the exact location of the samples remains unclear.

## References

- Gübelin, E.J., and Peretti, A., 1997. Sapphires from the Andranondambo mine in SE Madagascar: evidence for metasomatic skarn formation. *Journal of Gemmology*, **25** (7), 453-70
- Hänni, H.A., 1999. Gem News. ... and other gems from near Ilakaka. *Gems & Gemology*, **35**(2), 150
- Kiefert, L., Schmetzer, K., Krzemnicki, M.S., Bernhardt, H.-J., and Hänni, H.A., 1996. Sapphires from Andranondambo area, Madagascar. *Journal of Gemmology*, **25**(3), 185-209
- Kumaratilake, W.I.D.R.A., 1998. Spinel and garnet star networks: an interesting asterism in gems from Sri Lanka. *Journal of Gemmology*, **26**(1), 24-8
- Pezzotta, F., 1999. Die Mineralien der basischen Skarne. In: Glas, M. (Ed), Madagaskar. Chr. Weise Verlag, München; *extraLapis*, **17**, 26 - 33
- Rakotondrazafy, M.A.F., Moine, B., and Cuney, M., 1996. Mode of formation of hibonite (CaAl<sub>12</sub>O<sub>19</sub>) within the U-Th skarns from the granulites of S-E Madagascar. *Contrib. Mineral. Petrol.*, **123**, 190-201
- Schmetzer, K., 1999. Ruby and variously coloured sapphires from Ilakaka, Madagascar. *Australian Gemmologist*, **20**(7), 282-4
- Schmetzer, K., 2000. Gem news. Spinel from Ilakaka, Madagascar. *Gems & Gemology*, **36** (2), 169-70
- Schmetzer, K., and Berger, A., 1992. Lamellar inclusions in spinels from Morogoro area, Tanzania. *Journal of Gemmology*, **23** (2), 93-4
- Schwarz, D., Petsch, E.J., and Kanis, J., 1996. Sapphires from the Andranondambo region, Madagascar. *Gems & Gemology*, **32** (2), 80-99



# Critical angle vs. deviation angle vs. Brewster angle

R.H. Cartier

46 Kappel Avenue, Toronto, Canada M4N 2Z3

---

**ABSTRACT:** The limitations inherent in each of the three convenient approaches to refractive index determination available to the gemmologist at the end of the twentieth century are described. A light-ray diagram for each approach centres upon the vibration direction(s) that are tested. It is shown that the refractometer can be used to measure all vibration directions but the required contact liquid sets a limit of usability; the deviation angle approach is free of contact liquid limitations but vibration directions that are tested are somewhat reduced; the Brewster-angle approach is also free of contact liquid limitations but vibration directions that are tested are much reduced.

---

**Keywords:** Brewster angle, critical angle, deviation angle, refractive index, vibration direction

## Introduction

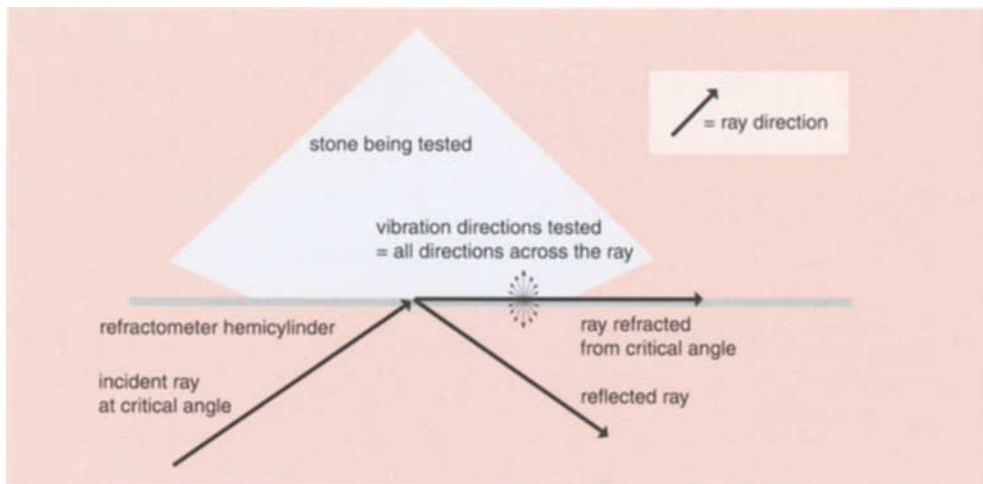
As this century and millennium draws to a close, we must admire the clever ingenuity, indeed the genius of those who developed the non-destructive tools and methods we use to identify gems. The greatest respect we can show our gemmology pioneers is to use their tools and methods with a clear understanding of how they work to interpret unusual or exceptional results sensibly, and not treat instruments as 'black boxes' giving magical results. With the introduction of the Brewster-angle meter<sup>1</sup> there are now three distinct approaches convenient to the gemmologist for determination of refractive index. In the order of their introduction they use the following optical properties: the critical angle, using the refractometer; the deviation angle, as used in visual optics (also known as the Hodgkinson technique); and

Brewster's angle utilised with the new Brewster-angle meter.

Ray diagrams are particularly helpful if it is considered that the propagation direction (ray direction) is *where* the light interacts with the medium, while the electric vector (vibration direction) controls *how* the light interacts with the medium. In the following diagrams the vibration directions shown inside each tested stone indicate vibration direction(s) in the medium that can yield a reading using the testing approach under discussion.

## The refractometer

The refractometer is undoubtedly the most important of the tools available to the practising gemmologist. For a well polished gem having an RI within the limits of the unit one can determine RI, birefringence, optical character, and optic sign from



**Figure 1:** Different propagation directions can be tested by horizontally rotating the stone on the test facet, therefore, all possible vibration directions can be tested.

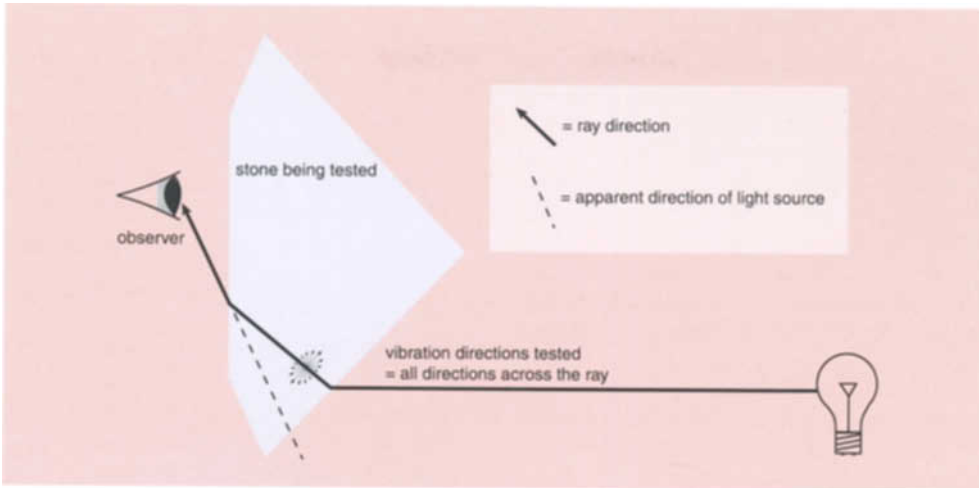
measurements on a single facet. There have been suggestions that for some special cases it may be necessary to check readings on a second or even a third facet, but it has been known for more than half a century that these special cases can be resolved using a polarising filter over the eyepiece<sup>2</sup> without going to another facet, a particularly helpful technique since the facet chosen for refractometer testing is usually the largest, most accessible and well polished facet on the stone.

The greatest advantage of the refractometer is that within equipment limits, every vibration direction within the medium can be tested on a single facet. The position of the stone on the window of the instrument and horizontal rotation through various orientations allow the minimum and maximum RI for each direction along the surface to be observed (*Figure 1*).

The effective limit of standard gemmological refractometers is the refractive index of the fluid which provides optical contact between the instrument and the specimen. Stones with RI over 1.79 (1.81 with the older more toxic fluid) will yield a 'negative' (i.e. over-the-limit) result with no specific values indicated for the RI.

### Visual optics

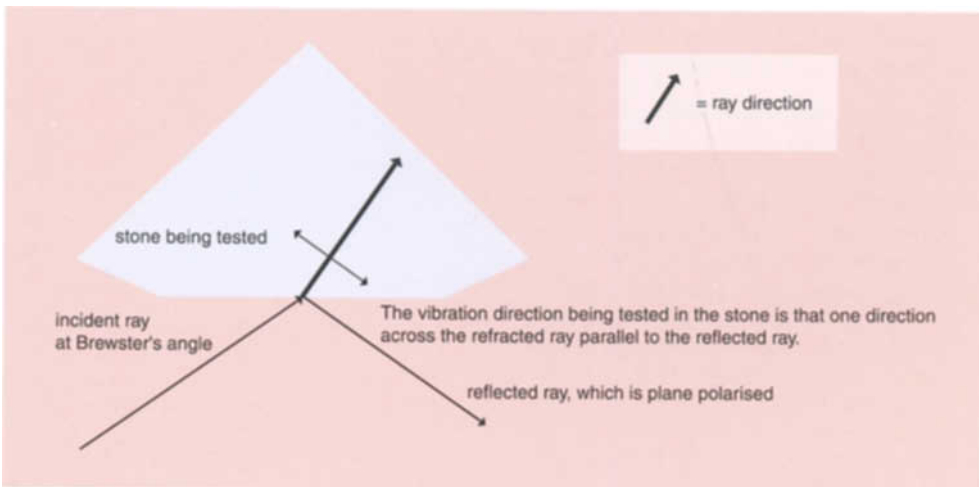
Visual optics is an experimentally developed technique of testing a faceted stone by observing a light through it<sup>3,4</sup>. It can give a very quick approximation of refractive index and birefringence /dispersion ratio with no instruments or aids whatever and, with a facet-angle measuring template and a sheet of paper marked in degrees<sup>5</sup>, can yield reproducible two-decimal place refractive indices. The technique is best understood by comparison to the light ray deviation method<sup>6</sup> even though it does not require the elaborate apparatus of the minimum deviation method so lucidly explained by Webster. One of the limits of deviation angle methods arises when total internal reflection takes place, which means that the stone's RI cannot be obtained if the angle between the two faces is more than twice the critical angle of the medium<sup>7</sup>. This problem is virtually eliminated when immersion fluids are used, as in Nelson's Pavilion Facet Fingerprinter or the Hanneman Refractometer<sup>8</sup>. Another limit of the deviation angle methods is that only one propagation direction can be tested through each pair of test facets, although there is no limit to the vibration directions being tested across the direction of travel (*Figure 2*).



**Figure 2:** Visual optics: different propagation directions can be tested by looking through the table at light coming through different pavilion facets, therefore many different vibration directions can be tested.

The number of transmission directions that can be tested on a faceted stone, typically at least eight and often more, can yield RI readings for many different vibration directions. The minimum and the maximum RIs for all vibration directions between those parallel to the table and those 90° to the directions of travel through the

stone (in the plane perpendicular to the table) can be observed. How close the observed birefringence comes to the full birefringence of the stone under examination depends upon how close the principle vibration direction of the highest or lowest RI comes to being perpendicular to the table of the stone.



**Figure 3:** Different propagation directions can be tested by horizontally rotating the stone on the test facet so all the vibration directions that can be tested will form an elliptical cone shape at the critical angle(s).

## Brewster-angle meter

The new Brewster-angle unit actually can measure refractive index (refractive index is simply the tangent of the Brewster angle) but, because the laser light source it uses provides monochromatic red light of 670 nm wavelength rather than monochromatic yellow light at 589 nm, the developers wisely decided to calibrate in angles rather than refractive indices to save confusing this new red wavelength standard with the traditional yellow wavelength standard. Some early discussions about the concept of a Brewster angle refractometer suggested that it could be a particularly powerful tool which, without the limits imposed by a contact fluid, would render the critical angle refractometer entirely obsolete. The difficulties in living up to this expectation seem to be more than simply problems of technical development.

The limits for the Brewster angle approach to refractive index measurement, aside from those imposed by the level of precision engineered into the measuring unit, are that the only vibration directions that can be tested are those actually at the Brewster angle for the facet being tested. Although some birefringence may be measured, it is somewhat unlikely that the full birefringence will be seen because of the very limited number of vibration directions that can be tested (*Figure 3*).

As pointed out by Webster<sup>9</sup>, at the Brewster angle the plane polarized reflected ray must be at 90° to the refracted ray, so it is the refracted ray which establishes the Brewster angle (the polarized reflected ray must follow Snell's law of reflection). The vibration direction tested using the Brewster angle is therefore the vibration direction of the polarized component of the refracted ray.

## References

1. Harding, R.R., Read, P.G., and Deeks, N.W., 1999. A new Brewster-angle meter for gem identification. *Journal of Gemmology*, **26**(8), 539-42
2. Burbage, E.J., and Anderson, B.W., 1942. *Mineralogical Magazine*, **XXVI**, p.251
3. Hanneman, W.W., 1980. *Lapidary Journal*, **18**(3), 221-8
4. Nelson, J.B., 1985. *Journal of Gemmology*, **20**(1), 49-51
5. Hodgkinson, A., 1995. *Visual optics*. Gemworld International, USA, p.26
6. Webster, R. 1994. *Gems*. 5th edn. Edited by P.G. Read. Butterworth-Heinemann, pp.722-8
7. Webster, R. 1994. *Gems*. 5th edn. Edited by P.G. Read. Butterworth-Heinemann, p.726
8. Hanneman, W.W., 2000. *Journal of Gemmology*, **27**(3), 155-60
9. Webster, R. 1994. *Gems* 5th edn. Edited by P.G. Read. Butterworth-Heinemann, p.721



## Diamonds

## Gems and Minerals

## Synthetics and Simulants

## Instruments and Techniques

## Diamonds

### Détection des diamants GE POL: une première étape. (Detection of GE POL diamonds: a first stage.)

J.-P. CHALAIN, E. FRIJSCH AND H.A. HÄNNI. *Revue de gemmologie*, 138/139, 1999, 24-33. Illus. in colour. (French and English versions)

Type IIa diamonds with the colour grade E and F have the letters GE POL lasered on the girdle. They show apparently colourless crossed strain patterns under polarized light and crystalline inclusions are surrounded by expansion islands reminiscent of similar effects in high-temperature treated corundum. Raman spectroscopy has showed several fluorescence bands, one at 637 nm indicating the presence of N-V centres. A detection instrument, the SSEF IIa Diamond Spotter, works in conjunction with a SWUV source. M.O'D.

### Nature, origin and age of diamonds: a state-of-the-art report.

V. FERRINI AND G. SASSANO. *Periodico di Mineralogia*, 68(2), 1999, 109-26.

Solid inclusions in diamonds are as small as 150-200 µm and show that diamonds invariably are derived from peridotitic and eclogitic rocks. The kimberlite and lamproite hosts to diamonds are more recent and not necessarily linked with the origin of the diamonds, merely acting as their transport to the surface. Diamonds associated with peridotitic rocks are ~ 3300 m.y. old, whereas those associated with eclogitic rocks range in age from 1600 to 1000 m.y. Isotopic studies have shown that diamonds originating in peridotitic rocks appear to have been generated in fairly homogeneous zones of the mantle, whereas those from eclogitic rocks have apparently been generated from crustal plates transported at depth by subduction phenomena related to continental drift. Kimberlite and lamproitic rocks are only diamondiferous if, prior to ascent, they intersected those sectors of the mantle where peridotitic or eclogitic diamond-bearing rocks originate. It is possible for some diamondiferous diatremes to contain diamonds of different ages. R.A.H.

### Spectroscopic evidence of GE POL HPHT-treated natural type IIa diamonds.

D. FISHER AND R.A. SPTIS. *Gems & Gemology*, 36(1), 2000, 42-9.

Results from spectroscopic analyses of GE POL high-P-high-T annealed nominally Type IIa diamonds are presented and compared with results for untreated diamonds of similar appearance and type. Absorption spectroscopy reveals that any yellow coloration in such HPHT-treated diamonds is due to low concentrations of single nitrogen, not observed in untreated Type IIa diamonds. Laser-excited photoluminescence spectroscopy reveals the presence of nitrogen-vacancy centres in most, but not all, HPHT-treated stones. When these centres are present, the ratio of the 575:637 nm luminescence intensities offers a potential means of separating the HPHT-treated from untreated Type IIa diamonds. R.A.H.

### Crown angle estimation for diamond using a 'tilt test'.

G. HOLLOWAY. *Australian Gemmologist*, 20(9), 2000, 374-5, 4 illus. in black-and-white.

The crown angle of a brilliant-cut diamond can be estimated by viewing the image of its culet through one of the kite facets as the diamond is tilted about its vertical axis [this should be horizontal axis - ed.] A brilliant with a shallow crown will require a considerable tilt before the image of the culet becomes visible. Brilliants with an 'ideal' crown angle require less tilt before the culet becomes visible. However, the size of the table should be taken into account. If the table is large, the angle of tilt will be more than if the table is small. P.G.R.

### Raman barometry of diamond formation.

E.S. IZRAELI, J.W. HARRIS AND O. NAVON. *Earth & Planetary Science Letters*, 173(3), 1999, 351-60.

Diamond and source region P-T conditions are commonly estimated using chemical equilibria between coexisting mineral inclusions. Here, another type of geobarometer, based on determination of the internal P in olivine inclusions and the stresses in the surrounding diamond, is presented. Using Raman spectroscopy, P of 0.13-0.65 GPa were measured inside olivine inclusions in

## Abstractors

J. Flinders	J.F.	R.A. Howie	R.A.H.	P.G. Read	P.G.R.
R.K. Harrison	R.K.H.	M. O'Donoghue	M.O'D.	I. Sunagawa	I.S.

For further information on many of the topics referred to, consult *Mineralogical Abstracts*

three diamonds from the Udachnaya mine, Siberia. Stresses in the diamond surrounding the inclusions indicated similar  $P$  (0.11–0.41 GPa).  $N_2$  contents and aggregation state in two of the diamonds gave mantle residence  $T$  of  $\sim 1200^\circ\text{C}$ . Using this  $T$  and the bulk moduli and thermal expansion of olivine and diamond, gives a calculated source  $P$  of 4.4–5.2 GPa. The general dependence of the source  $P$  ( $P_0$  GPa) on source  $T$  ( $T_0$   $^\circ\text{C}$ ) and measured internal  $P$  in the inclusion ( $P_i$ ) is given by:  $P_0 = (3.259 \times 10^{-4}P_i + 3.285 \times 10^{-3})T_0 + 0.9246P_i + 0.319$ . Raman barometry in combination with IR determination of the mantle residence  $T$  of the diamond allows estimation of the  $P$  at source using non-destructive examination of a single inclusion within a single diamond. J.F.

### New Ca-silicate inclusions in diamonds - tracers from the lower mantle.

W. JOSWIG, T. STACHEL, J.W. HARRIS, W.H. BAUR AND G.P. BREY.  
*Earth & Planetary Science Letters*, 173(1-2), 1999, 1-6.

Diamonds from the Kankan district of Guinea, which commonly contain ultra-high  $P$  majoritic garnet and ferropericlasite mineral inclusions, similar to those from São Luiz in Brazil, also contain inclusions of Ca silicates. One diamond contained walstromite-structured  $\text{CaSiO}_3$ , and three others the mineral assemblage  $\text{CaSi}_2\text{O}_5$  (titanite-structured) with larnite ( $\beta\text{-Ca}_2\text{SiO}_4$ ). The first two phases have not before been identified in natural occurrences. The phase diagram for mantle  $\text{CaSiO}_3$  indicates that primary  $\text{CaSiO}_3$ -perovskite underwent successive retrograde phase transformations. Development of equilibrium textures implies slow exhumation. Ca-silicates are possibly important carriers of Sr, P and K, and hence contain part of the inventory of radioactive elements in the transition zone and the lower mantle. Coesite (formerly stishovite) in two of the diamonds containing Ca-silicates indicates they belong to an 'eclogitic' suite, whereas ferropericlasite together with  $\text{CaSiO}_3$  and  $\text{MgSiO}_3$  in the third diamond may imply a 'peridotitic' environment. J.F.

### The Merlin diamond mining project. Part 1: an introduction.

An editorial review. *Australian Gemmologist*, 20(9), 2000, 382-5, 2 colour illus., 1 map.

Ashton Mining's Merlin diamond mining project in the Northern Territory consists of twelve kimberlite pipes named after the Arthurian legends Merlin, Bedevere, Ector, Excalibur, Gareth, Gawain, Kay, Launfal, Palomides, Sacramore, Tristram and Ywain, which are located some 600 km south-east of Darwin. Early in 1999 commercial mining operations commenced and the first sale of diamonds from the Merlin Project was completed in Antwerp in May of that year. Forecast production for the first year of operation is approximately 200,000 carats from the treatment of 550,000 tonnes of ore, rising to 300,000 carats from 700,000 tonnes of ore for the second year. P.G.R.

### Gem Trade Lab notes.

T. MOSES, I. REINITZ AND S.F. MCCLURE (eds). *Gems & Gemology*, 36(1), 2000, 60-65.

Notes are given on greenish-yellow 'chameleon' diamonds with blue-to-violet 'transmission' luminescence, and light blue synthetic brilliant-cut diamonds. R.A.H.

### Diamonds and accompanying minerals from the Arkhangel'sk kimberlite, Russia.

T.V. POSSOUKHOVA, G.P. KUDRYAVITSEVA AND V.K. GARANIN.  
*Mineral Deposits: Processes to Processing*, 1999, 667-70.

A study of > 200 diamond crystals, as well as garnets, spinels, ilmenites, pyroxenes and olivines, from three kimberlite fields in the Arkhangel'sk diamondiferous province is reported. The characteristics of the diamonds and their accompanying minerals change from one field to another, according to the depth of formation of the parent kimberlite melts. R.A.H.

## Gems and Minerals

### Rare Australian gemstones - stichtite.

R.S. BOTTRILL AND G. BROWN. *Australian Gemmologist*, 20(9), 2000, 391-3, 2 colour illus., 1 map.

A summary of the history of discovery, occurrences, associated minerals and gemmological properties of this rare Australian stone. Stichtite was first found on Stichtite Hill, about 500 m east of the Adelaide Proprietary mine, Dundas, Tasmania. This deposit is currently being mined for stichtite for lapidary purposes. P.G.R.

### Gems around Australia: Part 15.

H. BRACEWELL. *Australian Gemmologist*, 20(9), 2000, 378-81, 9 colour illus., 1 map.

This final part of a fossicking survey of Australian gem sources describes locations and gem materials in the south west of the country. Included are soapstones from Bridgetown, microcline feldspar, petalite, beryl, columbite and lepidolite mica from the Londonderry quarries, pink tourmaline from Ravensthorpe and Catlin Creek, and moss opal from near Norseman. P.G.R.

### A new deposit of smoky quartz crystals from the Torrington area.

H. BRACEWELL. *Australian Gemmologist*, 20(9), 2000, 388-90, 5 colour illus., 1 map.

More than 8000 prismatic smoky quartz crystals with lengths which ranged from 1 to 30 cm were recovered from a small collapsed clay-filled vugh at Silent Grove north of Torrington in the New England district of New South Wales. P.G.R.

### La liste de Mogok.

M. BRULEY. *Revue de gemmologie*, 138/139, 1999, 62-6.

Account of a journey to Mogok and of the working of the ruby mines. M.O'D.

### Mise à jour sur la détermination des substances de remplissage dans les émeraudes.

J.-P. CHALAIN. *Revue de gemmologie*, 138/139, 1999, 18-21. Illus. in colour.

Oil, Canada balsam and artificial resins used as

fillings in emerald are reviewed. An artificial ageing test showed that artificial resins turn yellow from colourless. Clove oil can be distinguished from artificial resins and C-H chemical bonds present in some of the inclusions in natural emerald can be detected by infrared spectrometry. Spectra from emerald fillers can be affected by the presence of refractometer fluid and by liquid soap.

M.O'D.

### Lapis lazuli from the Coquimbo Region, Chile.

R.R. COENRAADS AND C. CANUT DE BON. *Gems & Gemology*, 36(1), 2000, 28-41.

Lapis lazuli has been mined since 1905 in the Coquimbo Region of central Chile, near the border with Argentina. It occurs in contact metamorphosed limestone later metasomatized with the introduction of sulphur, the deposit consisting of blue lazurite with wollastonite, diopside, calcite, haüyne and pyrite. The Chilean material varies in quality and tends to be more spotted or less pure than Afghan material. The mines are at a height of 3500 m and produce some 150 tonnes annually.

R.A.H.

### Découvertes récentes sur l'opale.

E. FRITSCH, B. RONDEAU, M. OSTROUMOV, B. LASNIER, A.-M. MARIE, A. BARRAULT, J. WEY, J. CONNOUÉ AND S. LEFRANT. *Revue de gemmologie*, 138/139, 1999, 34-40.

A number of opals from new localities are described with respect to their microstructure and coloration. These include mauve opal from Androy in the south of Madagascar; blue-green opal from Acrari, Arequipa, Peru; blue opal from Var, France; pink opal from Montana, U.S.A., Quincy, Cher, France, and Mapimi, Mexico; and yellow opal from Saint-Nectaire, Puy-de-Dôme, France.

M.O'D.

### Historique des gisements d'émeraude et identification des émeraudes anciennes (part 1).

G. GIULIANI, M. CHAUSSIDON, H.-J. SCHUBNEL, D.H. PIAT, C. ROLLION-BARD, C. FRANCE-LANORD, D. GIARD, D. DE NARVAEZ AND B. RONDEAU. *Revue de gemmologie*, 138/139, 1999, 22-3.

First part of a review of emerald locations known in classical and later times.

M.O'D.

### In defense of gemmologists: a different view on nomenclature.

W.W. HANNEMAN. *Australian Gemmologist*, 20(9), 2000, 370-3.

In responding to E.L. Steven's article 'The nomenclature of gemstones with special reference to the garnet and tourmaline group' (*Australian Gemmologist*, 20(7), 1999, 277-9), the author defends the gemmologists' trade-orientated naming of traditional gem varieties and criticises the stricter method imposed by the mineralogists' nomenclature committee.

P.G.R.

### Les grenats gemmes.

H.A. HÄNNI. *Revue de gemmologie*, 138/139, 1999, 50-4.

Review of the gem garnets with discussion of their atomic structure, properties and colour.

M.O'D.

### Classification of the minerals of the tourmaline group.

F.C. HAWTHORNE AND D.J. HENRY. *European Journal of Mineralogy*, 11(2), 1999, 201-15.

A systematic classification of the tourmaline-group minerals, general formula  $XY_3Z_6O_{18}(BO_3)_3V_3W$ , is proposed, based on chemical composition and ordering at the different crystallographic sites of tourmaline structure. There are currently 13 accepted tourmaline species, each of which is defined. A feature that extends the number of possible end-members is the anion occupancy of the W site (dominated by OH, F or O<sup>2-</sup>) and the V site (dominated by OH<sup>-</sup> or, more rarely, O<sup>2-</sup>), thus giving hydroxy-, fluor- or oxy-end-members; the presence of dominant O<sup>2-</sup> at the W site commonly requires local cation-ordering at the Y and Z sites. The tourmaline group minerals can be classed into three principal groups based on the dominant species at the X site: alkali tourmalines (Na), calcic tourmalines (Ca) and X-site-vacant tourmalines (□). These groups are further divided, firstly on the occupancy of the W site, then by the (actual or inferred) occupancy of the V site, followed by the (actual or inferred) occupancy of the Y site, and finally by the (actual or inferred) occupancy of the Z site. Several examples are used to illustrate the application of this procedure.

R.A.H.

### Burmese jade: the inscrutable gem.

R.W. HUGHES, O. GALIBERT, G. BOSSHART, F. WARD, T. OO, M. SMITH, TAY THYE SUN AND G.E. HARLOW. *Gems & Gemology*, 36(1), 2000, 2-26.

Jade (primarily nephrite) has been prized in China for thousands of years, but the finest jade - jadeite - has been part of Chinese culture only since the late 18th century, when the mines in north-central Myanmar were opened. The authors were the first Western gemmologists to visit the remote jadeite mining area in the Hpakan/Tawmaw region and provide graphic descriptions of tens of thousands of miners working the river boulders, Uru conglomerate and *in situ* deposits, where jadeite dykes intrude serpentized peridotite. Colour, clarity, transparency and texture are the key considerations in evaluating fine jadeite. The finest Imperial jadeite is a rich 'emerald' green colour and is highly translucent to semi-transparent with a good lustre.

R.A.H.

### Gem news.

M.L. JOHNSON, J.I. KOIVULA, S.F. MCCLURE AND D. DEGHIONNO (eds). *Gems & Gemology*, 36(1), 2000, 66-78.

In a report on the Tucson 2000 show, descriptions are given of cabochons of 'Siberian blue nephrite' (also called 'Dianite' in Russia); EPMA showed this to be a submicroscopic mixture of quartz, tremolite and the blue amphibole potassian magnesio-arfvedsonite, nearly all the Fe is in the ferric state and the blue colour is attributed to Fe<sup>2+</sup>-Fe<sup>3+</sup> charge transfer. New commercial emerald deposits are reported from La Pita and Pulveros, Colombia, and examples are shown of faceted ruby from Chimwadzulu Hill, in S. Malawi, and of a cabochon of tugtupite from Greenland.

R.A.H.

### Les grenats du Millénaire.

T. LIND. *Revue de gemmologie*, 138/139, 1999, 45-9. Illus. in colour.

Update of the garnet gemstones with notes on recent discoveries. M.O'D.

### Ruby mineralization in southwest Madagascar.

A. MERCIER, M. RAKOTONDRAZAFY and B. RAVOLOMIANDRINARIVO. *Gondwana Research*, 2(3), 1999, 433-8.

The primary ruby deposits in the Ejeda-Fotadrevo area in SW Madagascar are closely associated with basic/ultrabasic complexes within the high-grade metamorphic terrain of the Precambrian Vohibory unit. Ruby is recovered from amphibolite and anorthosite veins within these complexes. Petrographical data and *P-T* estimates indicate that the ruby-bearing rocks crystallized under granulite-facies conditions of 750–850°C and 9–11.5 kbar. These Malagasy ruby deposits present many similarities with those of East Africa, particularly Tanzania, indicating a similar geological context and suggesting that ruby formation in both these areas resulted from the same mineralizing event when Madagascar was still adjacent to East Africa in the Gondwanaland assembly at the end of the Proterozoic. R.A.H.

### L'état actuel de la commercialisation des émeraudes.

J.-C. MICHELOU. *Revue de gemmologie*, 138/139, 1999, 10-14. Illus. in colour.

Overview of the colour enhancement of emerald by various methods and of the disclosure vocabulary proposed to and by the gemstone trade. M.O'D.

### Gem Trade Lab notes.

T. MOSES, I. REINITZ AND S.F. MCCLURE (eds). *Gems & Gemology*, 36(1), 2000, 60-65.

Notes are given on a 0.79 ct dark blue emerald-cut dumortierite from Sri Lanka, and a 12 cm statuette of pink hydrogrossular (*n* 1.71). R.A.H.

### A propos de l'opale australienne.

F. PAYETTE. *Revue de gemmologie*, 138/139, 1999, 67-71. Illus. in colour.

Description of some Australian opal locations with notes on geology and mining. M.O'D.

### La tourmaline.

E. PETSCH. *Revue de gemmologie*, 138/139, 1999, 41-4. Illus. in colour.

General survey of tourmaline with particular reference to Brazilian and Namibian deposits. M.O'D.

### Purple to purplish-red chromium-bearing taaffeites.

K. SCHMETZER, L. KIEFERT AND H.-J. BERNHARDT. *Gems & Gemology*, 36(1), 2000, 50-9.

Gemmological, chemical and spectroscopic properties are provided for eight purple to purplish-red Cr- and Fe-bearing taaffeites all believed to be from Sri Lanka, together with two greyish-violet Fe-bearing but Cr-free samples. These extremely rare purple taaffeites have Cr<sub>2</sub>O<sub>3</sub> ≤ 0.33, Fe<sub>2</sub>O<sub>3</sub> 2.59 and ZnO 2.24 wt. %. Other features include apatite and zircon inclusions, and healed fractures consisting of negative crystals with multiphase fillings that contain magnesite. R.A.H.

### Fluid inclusion characteristics of sapphires from Thailand.

B. SRITHAI and A.H. RANKIN. *Mineral Deposits: Processes to Processing*, 1999, 107-11.

Three main types of fluid inclusion occur in Bo Ploi sapphires: (1) vapour-rich CO<sub>2</sub> with *D* ≤ 0.86 g/cm<sup>3</sup>, (2) multiphase inclusions with several daughter minerals, hypersaline brine and a CO<sub>2</sub>-rich vapour phase, and (3) (silicate ?)-melt inclusions with immobile vapour bubbles in an isotropic/weakly anisotropic phase of low relief. The bubbles move when heated to > 800°C. These results suggest magmatic sources for these sapphires. R.A.H.

## Instruments and Techniques

### Raman spectroscopic study of 15 gem minerals.

E. HUANG. *Journal of the Geological Society of China (Taiwan)*, 42(2), 1999, 301-18.

The Raman active modes of each of 15 gem minerals have been collected in the low-wavenumber (150–1500 cm<sup>-1</sup>) and high-wavenumber (2800–3800 cm<sup>-1</sup>) regions. Typical Raman spectra are presented for beryl, chrysoberyl, corundum, diamond, grossular, jadeite, kyanite, nephrite, olivine, quartz, spinel, tourmaline, zircon and tanzanite. A flow chart is suggested to assist in the verification of these minerals from their characteristic Raman modes. M.O'D.

### A warning: beware of 1.815 refractometer contact fluid.

T. LINTON. *Australian Gemmologist*, 20(9), 2000, 373.

A warning is given that a refractometer contact fluid, which is claimed to have an RI of 1.815 and which has become available via the internet from an obscure source, is in fact toxic and potentially dangerous. The viscous and very dark liquid has an odour similar to that of acetic acid, and severely etches the surface of standard glass refractometer prisms after only a few minutes' contact. Inhalation of fumes from the fluid rapidly causes headaches and nausea. It is surmised that the liquid could possibly be a solution of sulphur in arsenic tribromide, and gemmologists are advised not to use any unbranded and unlabelled refractometer contact fluids that display these characteristics. P.G.R.

### D-limonene: a useful immersion liquid for gemmology.

T. LINTON. *Australian Gemmologist*, 20(9), 2000, 386-7, 3 colour illus.



Historically, immersion liquids used by gemmologists to estimate refractive indices and reduce surface reflections have included a range of colourless to near colourless liquids of known RI. Over recent years, the search for a new chemically stable and relatively non-toxic liquid for immersion purposes has indicated that d-limonene, a synthetic citrus fruit oil, may be suitable. D-limonene (or 4-isopropenyl-1-methylcyclohexene) is a clear slightly oily pale yellowish liquid with an SG of 0.838-0.843 and an RI of 1.47. It is virtually insoluble in water, but readily soluble in common organic solvents including methyl alcohol (methylated spirits). It is recommended that d-limonene is employed where user sensitivity or the potential toxic-carcinogenic qualities of commonly used immersion liquids prevent their safe application in gem testing. P.G.R.

### Diamond Proover II

T. LINTON, A. CUMMING AND K. HUNTER. (GAA Instrument Evaluation Report.) *Australian Gemmologist*, 20(9), 2000, 367-9, 1 illus. in black-and-white.

The new Diamond Proover II tested by the GAA's Instrument Evaluation Committee uses both thermal conductance and reflectance techniques to discriminate between diamond and its simulants (including synthetic moissanite). When the built-in thermal conductance probe is in use, the appropriate display 'Diamond/Moissanite, Cubic zirconia' or 'Others' will appear (if the probe touches the metal of a mounted stone, 'Metal' will be displayed). In its reflectance mode, the test unit is programmed to display either a limited range of appropriate diamond simulant names, or 'Others' to cover stones outside this range. However, a warning is given in the Committee's report that the Diamond Proover may give a 'Diamond' reflectance readout with a synthetic moissanite which has been heat treated to lower its RI to the region of diamond's 2.417 (although such a stone was heated by the Evaluation Committee to 1300°C for thirty minutes, this did not appear to reduce the reflectivity of the synthetic moissanite). The Committee also reported that when testing small mounted stones for thermal conductance, the sensitivity of the unit was insufficient to change the display reading from 'Diamond/Moissanite' to 'Metal', and suggested that a metal contact plate with supporting electronics (as incorporated in other thermal conductance probes) could be added. P.G.R.

### Elements pratiques de recherche du traitement des émeraudes par analyse spectrométrique infrarouge.

P. MAITRALLET. *Revue de gemmologie*, 138/139, 1999, 15-17. Illus. in colour.

The use of infrared techniques to detect filling matter in emeralds is discussed: graphs and a table are given. M.O'D.

### A preliminary investigation of precious opal by laser Raman spectroscopy.

A. SMALLWOOD. *Australian Gemmologist*, 20(9), 2000, 363-6, 7 graphs, 1 table.

This account of an investigation of precious opal provides an introduction to the use of Raman spectroscopy as a non-destructive identification technique. Raman spectra are obtained by irradiating the sample with an intense monochromatic light (usually laser generated) and then examining the resulting characteristic wavelengths scattered by the sample's molecular structure. The Raman scattered wavelengths are detected, computer analysed and recorded as a graph whose pattern of peaks characterize the molecular structure of the material being examined. In this preliminary investigation a group of selected natural, synthetic and imitation opals were examined using Raman spectroscopy. By attaching a confocal optical microscope to the Raman spectroscopy, very small sample areas can be analysed, and this arrangement was used to identify specimens of sedimentary and volcanic opal from various sources in Australia, Mexico and the USA, and to discriminate between them and the types of synthetic and imitation opals used in the manufacture of composite stones. P.G.R.

## Synthetics and Simulants

### Diamond formation by thermal activation of graphite.

A.V. PALNICHENKO, A.M. JONES, J.-C. CHARLIER, A.S. ARONIN AND J.-P. ISSI. *Nature*, 402(6758), 1999, 162-5.

The production of high-purity cubic diamond particles (10-100 µm) formed in a highly concentrated, dense C-vapour phase, and followed by deposition of crystal on the substrate, is reported. The C vapour phase was generated by thermal activation of graphite using a short, intense heat pulse. The initial growth rates of diamond (100-500 µm/sec) are ≥ two orders of magnitude higher than previously reported. R.K.H.

# BOOK REVIEWS

## **Pearl Museum. Human involvement with pearls through the ages**

Mikimoto Pearl Island, 1998. Mikimoto Pearl Island, Tobu City, Japan. pp 64, illus. in colour. Price on application.

This is more than a guide to the Pearl Museum on Mikimoto Pearl Island. It is a well-illustrated and informative little book. Starting with the history of pearls through the ages from Roman times until the appearance of the cultured pearl, it then covers Mikimoto's role in the industry and in jewellery. This is followed by descriptions of different pearl types, their structures and the culturing process used in Japan. Little mention is made of pearls from other countries, but the photographs are excellent, the diagrams clear and the text is simple and concise. A very pleasing and high quality publication.

M.C.P.

## **Jewellery reference and price guide. 2nd revised edn.**

M. POYNDER, 2000. Antique Collectors' Club, Woodbridge. pp 359, illus. in colour. Hardcover ISBN 1 85149 309 3. £35.00.

In a welcome re-appearance of a book first published in 1976, prices have been revised and incorporated by Michèle Rowan. As in the previous printings, the text is arranged by periods, types and styles after a short introduction to the major gem species. All items illustrated are described and priced and there is a bibliography and a short glossary. As might be expected with so large a text, there are a few errors and perhaps the backgrounds used for some of the photographs add

unwanted colour to colourless stones (especially diamonds) but when the amount of information given is considered the usefulness of the book is not impaired.

M.O'D.

## **Precious gems; jewellery from eight centuries**

Catalogue of an exhibition shown at the Nationalmuseum, Stockholm, 9 June to 15 October 2000 (reviewed in *Gem & Jewellery News*, 2000, 9, 4). The Museum, Stockholm, 2000. pp 239, illus. in colour. Hardcover ISBN 91 7100 619 2. £40.00.

This is a beautifully-produced catalogue which covers medieval to 1930s' jewellery and accompanies an exhibition which opened in Stockholm in June 2000. Many of the pieces shown and described come from Royal collections in Sweden and England; full captions to the photographs, details of the pieces and their provenance and citations to other publications and exhibitions are now *de rigueur* for a book of this kind and this example meets all possible criteria of this sort. To cover eight centuries of any of the decorative arts is a formidable task: the writers of the seven chapters into which the introduction is divided are well chosen. Göran Tegnér writes on medieval monarchs (from mark of favour to royal emblem): Diana Scarisbrick on the jewellery of Mme Pompadour: Magdalene Ribbing on pearls: Brigitte Marquardt on jewellery of the 19th century in mid-Europe: Fritz Falk on Art Nouveau jewellery as art and Derek E. Ostergard on the radiance of perfection (Parisian jewellery between the world wars). There is a bibliography of 68 entries and a comprehensive index. It would be good to see the exhibition as a whole in London.

M.O'D.

242

## **BOOK SHELF – NEW TITLES**

- |  |               |
|--|---------------|
| <i>Jewellery reference and price guide</i> by M. Poynder                           | <b>£35.00</b> |
| <i>Tiffany jewels</i> by John Loring   | <b>£38.00</b> |
| <i>Rough diamonds: A practical guide</i> by Nizam Peters                           | <b>£65.00</b> |
| <i>Earrings from antiquity to the present</i> by Daniela Mascetti & Amanda Triossi | <b>£19.95</b> |
| <i>Gold and platinum jewelry buying guide</i> by Renée Newman                      | <b>£12.95</b> |

(Prices exclude postage and packing)

Gemmological Instruments Limited,  
27 Greville Street,  
London EC1N 8TN.  
Tel: 020-7404 3334  
Fax: 020-7404 8843

# Proceedings of the Gemmological Association and Gem Testing Laboratory of Great Britain and Notices

## OBITUARY

Charles J. Beraet (D.1931 with Distinction), Harrow, Middlesex, died peacefully on 22 January 2000 aged 91. Mr Beraet's career in the retail jewellery trade spanned almost 60 years, his last position being with Dibbins in Sloane Street where he had worked until his retirement at the age of 81.

Donald R. Cartwright (D.1975), Little Bookham, Surrey, died on 11 June 2000. An engineering consultant, he had worked with W.S. Atkins, Epsom, and was associated with the Guildford Gem, Mineral and Lapidary Club.

Mr Alan Rowlands (D.1991), Calgary, Alberta, Canada, died recently.

Mr Ishiwatari Tamotsu (D.1982), Tokorozawa City, Saitama Pref., Japan, died recently.

## MEMBERS' MEETINGS

### London

On 12 July at the Gem Tutorial Centre, 27 Greville Street, London EC1N 8TN, Roger Young gave a talk entitled *Faceting revolution*.

On 26 July at the Gem Tutorial Centre, Robert Weldon, Director of Photography and Senior Writer for the *Professional Jeweler* based in Philadelphia, USA, gave an illustrated lecture on *Gemstone photography with a 35 mm camera*.

On 13 September at the Gem Tutorial Centre, Dr Judith Kinnaird gave an illustrated lecture entitled *From geology to jewellery - the platinum millennium*.

### Midlands Branch

On 24 June the Midlands' Branch annual summer supper was held at Barnet Green.

### North West Branch

On 20 September at Church House, Hanover Street, Liverpool 1, Peter McIvor spoke on *The history of English watches from verge to lever*.

## Scottish Branch

On 5 September at the British Geological Survey, Murchison House, West Mains Road, Edinburgh, Roy Huddleston gave a talk on *The History of diamond grading*.

## ANNUAL GENERAL MEETING

The Annual General Meeting of the GAGTL was held on Monday 26 June 2000 at 27 Greville Street, London EC1N 8TN. Michael O'Donoghue chaired the meeting and welcomed those present. The Annual Report and Accounts were approved and signed.

The Council had nominated Professor Alan Collins for the office of President for the term 2000-2002 and the nomination was unanimously carried. Alan Collins is Professor of Physics at King's College London. His main research interest lies in the optical properties of diamond and he has published more than 170 papers on the subject. In addition to a six-month spell at the De Beers Diamond Research Laboratory, Johannesburg, over the last 12 years he has given 33 invited lectures at international meetings. He is an Associate Editor of *The Journal of Gemmology* and of *Diamond and Related Materials*, and is on the Review Board of *Gems & Gemology*. Alan Collins thanked the outgoing President, Professor Howie, for generous support and commitment to the GAGTL during his four years as President.

Professor Robert A. Howie was elected a Vice-President of the Association. Dr Roger Harding and Vivian Watson were re-elected to the Council of Management. Colin Winter was re-elected to the Members' Council; Richard Shepherd did not seek re-election to the Members' Council. Hazlems Fenton were re-appointed Auditors.

Responding to a question from the floor, Dr Roger Harding stated that, as a result of the loss made in 1999, efforts were being made to reduce

# GIFTS TO THE ASSOCIATION

The Association is most grateful to the following for their gifts for research and teaching purposes:

**Dennis Durham**, Kingston upon Hull, East Yorkshire, for a prism spectroscope with a wavelength scale and mirror attachment.

**Peter Dwyer-Hickey**, South Croydon, Surrey, for an imitation tortoiseshell box.

**John R. Führbach**, Amarillo, Texas, U.S.A., for rough samples of peridot, oligoclase, amethyst and augite.

**Marc Jobin**, Buckhurst Hill, Essex, for a rough specimen of orthoclase from Madagascar.

**Janice Kalischer**, Finchley, London, for a ring set with four garnet-topped-doubles and a pearl.

**The Midlands Branch of the GAGTL** for a cash donation of £775.00.

**W. Nagel**, London, for a GIA Synthetic Diamond wallchart.

**Bernard D. Shindler**, Stanmore, Middlesex, for two Shindler Scales.

**Peggy Smithers**, London, for faceting equipment, and tumbling and grinding machines, bequeathed by her late husband.

**Ian Thomson**, Thomson (Gems) Ltd, London, for 13 chipped diamonds.

**Pierre Vuillet**, Villards d'Heria, France, for a 2.95 ct langasite, a yellow-green synthetic stone.

**Vivian Watson** of P.J. Watson Ltd., London, for a display case.

costs in the current year and three redundancies had been made. Income was slightly above that for the same period in 1999 and it was hoped that by the end of the year some benefit would be felt.

Following the Annual General Meeting, a Reunion of Members and Bring and Buy Sale were held. The winners of the 2000 Photographic Competition were announced and entries displayed.

## GEM DIAMOND EXAMINATIONS

In June 2000, 105 candidates sat the Gem Diamond Examination, 85 of whom qualified, including 11 with Distinction. The **Bruton Medal** for the candidate who submitted the best set of answers in the Gem Diamond Examinations of 2000 which, in the opinion of the Examiners, are of sufficiently high standard, was awarded to Neil Rose of Wetherby, North Yorkshire. The names of the successful candidates are listed below:

### *Qualified with Distinction*

Dower, Dan G., London

Forbes, Victoria E., Portadown, Co. Armagh,  
Northern Ireland

Haden, Claire L., Halesowen, Birmingham, West  
Midlands

Harrison, Tarn J., Leamington Spa, Warwickshire

Hue Williams, Sarah, London

Isacsson, Johanna, Stockholm, Sweden

Qingliang Yang, Wuhan, Hubei, P.R. China

Rythen, L.A. Carolina, Stockholm, Sweden

Wu Weizheng, Beijing, P.R. China

Yan Xuejun, Wuhan, Hubei, P.R. China

Young, Geoff W., Surbiton, Surrey

### *Qualified*

Antoniadis, Antonis, Rhodes, Greece

Axarlian, Sergio, Piraeus, Greece

Barker, Nicola, Tunbridge, Kent

Bicknell, Tim, London

Bolissian, Inge Sahr, Bow, London

Boustany, Denise M., St Johns, Antigua

Brady, John J., Swadlincote, Derbyshire

Chan Har Wei Carrio, Kowloon, Hong Kong

Cheng Youdi, Beidajie, Beijing, P.R. China

Christoulakis, Theodore, Athens, Greece

Damalis, George H., Winchmore Hill, London

Davenport, N. Tristan, Oxford

Ding Weijing, Beidajie, Beijing, P.R. China

Fadlun, Lucy R., Hendon, London

Fukui, Eriko, Tokyo, Japan

Garcia Oliver, Eugenia, London

Giurgiu, Anda, Wanstead, London

Hairong Ye, Wuhan, Hubei, P.R. China

Harrison, Helen Tynan, Yellowknife, North West  
Territories, Canada

Hill, Stephen E., Croxley Green, Rickmansworth,  
Hertfordshire

Ho Ka Kit, Frankie, Kowloon, Hong Kong

Hua Deng, Wuhan, Hubei, P.R. China

Jian Weng, Wuhan, Hubei, P.R. China

Jin Wu, Wuhan, Hubei, P.R. China

Jingyu Tu, Wuhan, Hubei, P.R. China

Jones, Adrian M., Harrow, Middlesex

Jue Peng, Wuhan, Hubei, P.R. China

Kaprili, Maria, Athens, Greece



# FORTHCOMING EVENTS

## GAGTL ANNUAL CONFERENCE

Sunday 29 October - Barbican Conference Centre, London

**Keynote speaker: Professor Al Levinson, Calgary, Alberta, Canada**  
*Diamonds in Canada - Geology to Gemmology*

**Paul Spear, DTC Research Centre, Maidenhead**  
*Synthetic and treated diamonds*

**Dr Judith Kinnaird, University of Witwatersrand, South Africa**  
*The sparkle in Somaliland*

**Robert Fawcett, The Cultured Pearl Company Ltd.**  
*The cultured pearl trade today*

**Harry Levy, President of the CIBJO Diamond Commission**  
*What's in a name?*

### VISITS

Visits to **De Beers** (Friday 27 October) and guided tours of the **Gilbert Collection at Somerset House** (Monday 30 October) available as optional extras to Conference delegates.

Full details and application forms available from the GAGTL on 020 7404 3334

245

- 27 October Midlands Branch. *The works of Peter Carl Fabergé. Stephen Dale*
- 30 October London. Presentation of Awards
- 31 October Scottish Branch. *Diamonds in Canada - geology to gemmology. Professor Al Levinson*
- 15 November North West Branch. AGM followed by Gem collection and anecdotes. *John Pyke Sur*
- 17 November London. *A new process to modify colour of natural (and synthetic) diamonds. Greg Sherman and Branko Deljanin*
- 23 November London. *Amber - has the bubble burst? Helen Fraquet*
- 24 November Midlands Branch. *The minerals of Pakistan. Michael O'Donoghue*
- 2 December Midlands Branch. Annual Branch Dinner
- 2001
- 26 January Midlands Branch. Gemmology Quiz and Bring and Buy
- 23 February Midlands Branch. *What's new in gemmology? Alan Hodgkinson*
- 30 March Midlands Branch. *The Toyshop of Europe. Shena Mason*

For further information on the above events contact:

- London Mary Burland on 020 7404 3334
- Midlands Branch: Gwyn Green on 0121 445 5359
- North West Branch: Deanna Brady on 0151 648 4266
- Scottish Branch: Catriona McInnes on 0131 667 2199

Kunvovsky, Martin R., Cardiff, S. Glamorgan  
 Lao Ieng Kit, Hong Kong  
 Latsoudis, Sofia, Heraklion, Crete, Greece  
 Lau Lai Fong, Kowloon, Hong Kong  
 Lazaridis, Lazarus, London  
 Lee Hing Fan, Kowloon, Hong Kong  
 Lee King Fan, Kowloon, Hong Kong  
 Li Ding, Wuhan, Hubei, P.R. China  
 Li Chong, Beidajie, Beijing, P.R. China  
 Liang Wang, Wuhan, Hubei, P.R. China  
 Lindsay, Tony P., Maidstone, Kent  
 Liu Yongchao, Beidajie, Beijing, P.R. China  
 Long Sin Sai, Kowloon, Hong Kong  
 McCormick, Michelle, Stourport-on-Severn,  
 Worcestershire  
 Makri, Eleni, Thessaloniki, Greece  
 Ng Mei Hang, Kowloon, Hong Kong  
 O'Neill, Michelle, Northfield, Birmingham, West  
 Midlands

Panidis, Lydia, Elefsina, Greece  
 Petropoulos, Andreas, Athens, Greece  
 Pollatos, Evonne-Eftyhia, London  
 Ratiu, Alexandra, London  
 Roche, Patrick, Hackney, London  
 Rongjun Cui, Wuhan, Hubei, P.R. China  
 Rutter, Fay, Walsall, West Midlands  
 Seitanidis, Nikolaos, Kterini, Greece  
 Shen Feng, Beidajie, Beijing, P.R. China  
 Shi Wei, Beidajie, Beijing, P.R. China  
 Stamatakis, Zoe, Athens, Greece  
 Stubbs, Annaliese J.C., London  
 Tai Wai Yee, Hong Kong  
 Thompson, Mary T., Offerton, Stockport, Cheshire  
 Tong Tat Wah, Kowloon, Hong Kong  
 Tsuen Sin Charn, Hong Kong  
 Waghela, Sunita, London  
 Ward, Julie E., Upper Belvedere, Kent  
 Waterfall, Mary C., Tooting, London  
 Williams, Lorraine A., London  
 Xiaogang He, Wuhan, Hubei, P.R. China  
 Xinhai Yu, Wuhan, Hubei, P.R. China  
 Yang Yuan Yuan, Beidajie, Beijing, P.R. China  
 Ying Lu, Wuhan, Hubei, P.R. China  
 Ying Zhou, Wuhan, Hubei, P.R. China  
 Yue, Louisa, Kew, Richmond, Surrey  
 Zagana, Aphrodite, Athens, Greece  
 Zhang Xiaohu, Beidajie, Beijing, P.R. China  
 Zhiqiang Liu, Wuhan, Hubei, P.R. China

## EXAMINATIONS IN GEMMOLOGY

In the Examinations in Gemmology held worldwide in June 2000, 145 candidates sat the Preliminary Examination of whom 117 qualified. In the Diploma Examination 231 sat of whom 100 qualified.

The **Anderson Bank Prize** for the best non-trade candidate of the year in the Diploma Examination was awarded to Louise Joyner of London.

The **Diploma Trade Prize** for the best candidate of the year who derives her main income from activities essentially connected with the jewellery trade was awarded to Mina Shin of Seoul, Korea.

The **Anderson Medal** for the best candidate of the year in the Preliminary Examination and the **Preliminary Trade Prize** for the best candidate of the year who derives her main income from activities essentially connected with the jewellery trade were awarded to Helen Dimmick of London.

The Tully Medal was not awarded.

## Diploma

### Qualified

Abdulrazzaq, Anwar A.H., Muharraq, Bahrain  
 Al-Alawi, Abeer T., Manama, Bahrain  
 Anderson, Meredith, Chertsey, Surrey  
 Ascot, Leon, Urdorf, Switzerland  
 Ayukawa, Yasuyo, London  
 Berner, Peter, Gelterkinden, Switzerland  
 Berry, Shoshana, Salisbury, Wiltshire  
 Blachier, Helene M.A., Ponnas, France  
 Blomquist, Eva, Jonkoping, Sweden  
 Bruce-Lockhart, Simon D., London  
 Cai Shimei, Guilin, Guangxi, P.R. China  
 Checkley, Emma L., Warley, Birmingham, West  
 Midlands  
 Chen Hsi Hung, Taichung, Taiwan, R.O. China  
 Chen Jijuan, Guilin, Guangxi, P.R. China  
 Chen Peijia, Guilin, Guangxi, P.R. China  
 Chen Qing Ye, Singapore  
 Chiu Hsiao Hui, Taichung, Taiwan, R.O. China  
 Chokshi, Shivang R., Ahmedabad, Gujarat, India  
 Chow Suet Lai, New Territories, Hong Kong  
 Cooke, Caroline M., St Margarets, Middlesex  
 Cropp, Alastair, Brookmans Park, Hertfordshire  
 Cubbins, Graham, Blackpool, Lancashire  
 de Landmeter, Edward, Aagtekerke, The  
 Netherlands  
 Dolomidou-Panoutsopoulou, Georgia, Athens,  
 Greece  
 Donnelly, Lee-ona F., Ayr, Scotland  
 Dowling, Siobhan L., London  
 Droesser, Niklas, Leverkusen, Germany  
 Fang Liang, Guilin, Guangxi, P.R. China  
 Faustmann, Alexandra, Quezon City, Philippines  
 Fok Ki Yu, Lantau Island, Hong Kong  
 Gravier, Denis, Saint Jean le Vieux, France  
 Greslin-Michel, Valerie, London  
 He Jiamu, Guilin, Guangxi, P.R. China

# GAGTL GEM TUTORIAL CENTRE, LONDON

## SHORT COURSES AND WORKSHOPS

### COLOURED STONE UPDATE

Tuesday 24 October

#### The treatments, the simulants, the synthetics

Are you aware of the various treated and synthetic materials that are likely to be masquerading amongst the stones you are buying and selling? Whether you are valuing, repairing or dealing, can you afford to miss this day of hands on investigation? This course will cover ruby, sapphire and emerald, as well as other stones including chrysoberyl, opal, jade and tanzanite.

GAGTL member price £99 + VAT (£116.33)

Non-member price £110 + VAT (£129.25)

### DIAMOND - PAST, PRESENT, FUTURE

Tuesday 31 October

A valuable day of in-depth investigation of diamonds, their treatments, simulants and synthetics. What factors have affected the manufacture of this most prized gemstone in the past and what are the factors which will become more and more of a concern in the future? Includes a presentation by De Beers on how they are facing challenges head on.

GAGTL member price £114.90 + VAT (£135.00)

Non-member price £127.66 + VAT (£150.00)

### SKETCHING FOR SALES

Wednesday 1 November

This introduction to drawing aims to show participants how to turn an idea into a sketch. The session begins with line drawing and during the day will work towards achieving perspective and shading in jewellery. Anyone can learn to draw. Gain the confidence to put your ideas on paper.

GAGTL member price £66 + VAT (£77.55)

Non-member price £76 + VAT (£89.30)

### TWO-DAY STONE FACETING WORKSHOP

Saturday and Sunday, 4 and 5 November

Ever wanted to try faceting? This two-day hands-on workshop will enable you to walk away with a stone you have cut yourself! A faceting machine for each participant and expert advice from cutters Roger Young and Jim Finlayson, will ensure that the workshop is both productive and enjoyable for everyone. This faceting weekend is a delight and not to be missed.

Price £175 + VAT (£205.63)

### SKETCH II

Wednesday 22 November

This one-day workshop aims to build on the basic ground-work of perspective, shading and use of colour so that participants can apply these skills to their own design ideas. Areas covered will include effective use of colour, getting the most out of your chosen medium, presentation drawings, and troubleshooting any areas of difficulty on a one-to-one basis.

GAGTL member price £66 + VAT (£77.55)

Non-member price £76 + VAT (£89.30)

### STUDENT WORKSHOPS 2001

Weekend diamond Grading Revision

Saturday and Sunday, 6 and 7 January

Two-day Diploma Practical Workshop

Saturday and Sunday, 6 and 7 January

For further details and a booking form contact Shelley Keating at the GAGTL on 020 7404 3334.



Ho, Anna, New Territories, Hong Kong  
 Ho Sau Lan, Hong Kong  
 Ho Sau Wa, Hong Kong  
 Ho Siu Kei, Paulie, Kowloon, Hong Kong  
 Holdsworth, Christopher J., Armadale, Victoria,  
 Australia  
 Hugo, Philippe A.M., Kortrijk, Belgium  
 Hung Tin Man, New Territories, Hong Kong  
 Hynes, Lola, Dun Laoghaire, Co. Dublin, Ireland  
 Ito, Eiko, New Southgate, London  
 Jo, Midori, Haginodai, Ikoma Shi Nara, Japan  
 Jung Shin Kim, South Croydon, Surrey  
 Ladak, Nelina, London  
 Lamarre, Claude, Lasalle, Quebec, Canada  
 Lei Shi, Wuhan, Hubei, P.R. China  
 Li, Mary W.Y., Vancouver, British Columbia,  
 Canada  
 Lichtsteiner, Patrick, Ormalingen, Switzerland  
 Limei Kong, Wuhan, Hubei, P.R. China  
 Lin Yeong Leh, Taipei, Taiwan, R.O. China  
 Linjun Fu, Wuhan, Hubei, P.R. China  
 Lo Hung Kin, Kowloon, Hong Kong  
 Loe She-Mon, Taipei, Taiwan, R.O. China  
 Long Changzheng, Guilin, Guangxi, P.R. China  
 Loxton, Sam C., Herne Hill, London  
 Ma Rui, Guilin, Guangxi, P.R. China  
 Mason, Stephen R., Sutton Coldfield, Birmingham,  
 West Midlands  
 Matheson, Eric R., Vancouver, British Columbia,  
 Canada  
 Maulave, Xavier R.L., Yangon, Myanmar  
 Ndirangu, Joseph K., Nairobi, Kenya  
 Ng, Bianca Suen Lam, Hong Kong  
 Oksanen, Tarja, Helsinki, Finland  
 Pagan, Sabine, Berne, Switzerland  
 Pajor, Matthias V., Gelterkinden, Switzerland  
 Price, Sharron A., Rowley Regis, Warley, West  
 Midlands  
 Qi Chen, Wuhan, Hubei, P.R. China  
 Rathwell, Eden L., San Francisco, California,  
 U.S.A.  
 Roberts, Jennifer L., York  
 Rockman, Gary, Bromley, Kent  
 Roelofs, Esther W., Schoonhoven, The Netherlands  
 Saikyo, Kunihiro, Hirakata City, Osaka, Japan  
 Sheppard, Gary R., Kilbirnie, Wellington,  
 New Zealand  
 Shi Kai, Guilin, Guangxi, P.R. China  
 Shin Hyun-Sook, Daejon, Korea  
 Shirasaki, Tadahiro, Fukui City, Fukui Pref., Japan  
 Smith, Wendy, London  
 Solomou, Andreas, Nicosia, Cyprus  
 Song Xiaohua, Guilin, Guangxi, P.R. China  
 Su Nan, Guilin, Guangxi, P.R. China  
 Telfer, Corin, Rickmansworth, Hertfordshire  
 Terrell, Celia J.W., Atherstone, Warwickshire

Thompson, Mary T., Offerton, Stockport, Cheshire  
 To, Flora L.H., Kowloon, Hong Kong  
 To Kwan, Causeway Bay, Hong Kong  
 Tuckwell, Alice E., Newcastle-under-Lyme,  
 Staffordshire  
 Uhlin, Christophe R., Leytonstone, London  
 Verhoeven, P.M.C., Nijmegen, The Netherlands  
 Williams, Johanna, London  
 Williams, Lorraine A., London  
 Winter, Nikki, Herne Hill, London  
 Wong, Rebecca Lai King, Scarborough, Ontario,  
 Canada  
 Wu Sung-Mao, Taichung, Taiwan, R.O. China  
 Xiusong Ding, Wuhan, Hubei, P.R. China  
 Xu Minyan, Guilin, Guangxi, P.R. China  
 Yihua Wu, Wuhan, Hubei, P.R. China  
 Yiren Wang, Wuhan, Hubei, P.R. China  
 Yorke, Anabel, London  
 Zhenhong Wu, Wuhan, Hubei, P.R. China  
 Zhu Yalin, Guilin, Guangxi, P.R. China

### Preliminary

#### *Qualified*

Abeid, Ahmed, Southall, Middlesex  
 Amliwala, Panna, Solihull, West Midlands  
 Balzan, Darlene P., Mill Valley, California, U.S.A.  
 Bolter, Rachel L., Swindon, Wiltshire  
 Borruso, Alessandro, Harrow, Middlesex  
 Bourke, Mary B., Kilkenny, Ireland  
 Brunt, Emily F., Fivemiletown, Co. Tyrone, N.  
 Ireland  
 Carter, Andrew, Crewe, Cheshire  
 Cedeno, Leonor, Sutton, Surrey  
 Chan Hin Tung, Tony, Hong Kong  
 Chan Kwong Chi, Hong Kong  
 Chater, Melanie D., Spratton, Northamptonshire  
 Cheung Yuet Diana, New Territories, Hong Kong  
 Christianos, Melina Z., Sydney, New South Wales,  
 Australia  
 Clayton, Harriet B.E., Edinburgh, Scotland  
 Cohen, Vanessa, London  
 Collins, Madeline A., Preston, Lancashire  
 Cristol, Agata, Marseille, France  
 Cross, Alice, Warminster, Wiltshire  
 Cruse, Toby, Eastbourne, East Sussex  
 Dennis, Roger A., Elstree, Hertfordshire  
 Dimmick, Helen M., East Putney, London  
 Dorrell, Clare G., Perth, Scotland  
 Downes, Lisa E., Handsworth Wood, Birmingham,  
 West Midlands  
 Eineljung, Lars E., Lannavaara, Sweden  
 Elliott, Caroline E., Ruislip, Middlesex  
 Evans, Sarah, Homerton, London  
 Farrer, Alison M., Stonehouse, Gloucestershire  
 Field, Karen M., Harborne, Birmingham, West  
 Midlands



Fischer, Karin, Wettingen, Switzerland  
 Formosis, Dimitris, Athens, Greece  
 Gregory, Kerry H., Newport, Wales  
 Gregory, Pauline A., Bishop Auckland, Co. Durham  
 Griffiths, Victoria C., Cradley Heath, West Midlands  
 Groves, David A., Hall Green, Birmingham, West Midlands  
 Hamano, Yumi, West Hampstead, London  
 Heath, Daniel, Kilkenny, Ireland  
 Ho Pui Cheung Feony, Kowloon, Hong Kong  
 Hong Liu, Guilin, Guangxi, P.R. China  
 Horton, Sophie E., Sevenoaks, Kent  
 Hsieh Tien Heng, Taichung, Taiwan, R.O. China  
 Ingridsson, Anna-Lis, Lannavaara, Sweden  
 Jones, Lorraine D., Farnworth, Bolton, Lancashire  
 Kato, Ayumi, Nishinomiya City, Hyogo, Japan  
 Kim Yu-Mi, Kwangju, South Korea  
 Ko Ji Hea, Kwangjoo, South Korea  
 Kokkinoy, Anna, A. Glifada, Greece  
 Kuroda, Makiko, Hirakata City, Osaka, Japan  
 Kyaw Kyaw Soe, Tarmwe Township, Yangon, Myanmar  
 Lakshminarayan, S.S., Tamil Nadu, India  
 Lam Kwi-Peng, Singapore  
 Lam, Victoria L., Carnforth, Lancashire  
 Lamarre, Claude, Lasalle, Quebec, Canada  
 Langdale, Jason, Kowloon Tong, Hong Kong  
 Leake, Nigel P., Weddington, Nuneaton, Warwickshire  
 Lee, Helen, London  
 Lee Wai Kwok, Simon, Kowloon, Hong Kong  
 Lee Sui Kam, Monita, New Territories, Hong Kong  
 Leung Hung Wai, Hong Kong  
 Leung Wing Yee, Hong Kong  
 Li Xue Ming, Guilin, Guangxi, P.R. China  
 Li Ting-Ting, Shanghai, P.R. China  
 Li Yuan-Yuan, Shanghai, P.R. China  
 Llinares, Luis, Geneva, Switzerland  
 Lo Pak Sun, Kowloon, Hong Kong  
 Loukaides, Nicolas, P. Faliro, Greece  
 Love, Anne C., Glasgow, Scotland  
 Lowe, Mimi J., San Francisco, California, U.S.A.  
 Lui, Janice, Manchester  
 Ma Li Ke, Guilin, Guangxi, P.R. China  
 Mate, Nikhil S., Mumbai, India  
 Matsubara, Midori, Osaka City, Osaka, Japan  
 Mattsson, Simon, Lannavaara, Sweden  
 McDonagh, Robert, Cairns, Queensland, Australia  
 Mehta, Jeeta, Braunstone, Leicester, Leicestershire  
 Moe Moe Shwe Daw, Bahan Township, Yangon, Myanmar  
 Monney, Christelle V., Chambesy, Switzerland  
 Morrish, Rachel, Sutton Coldfield, West Midlands  
 Myo Thant, Pabedan Township, Yangon, Myanmar  
 Naing Saw, Ahlone TSP, Yangon, Myanmar  
 Naing Oo Naing, Kyauk Taga Town, Bago Div, Myanmar  
 Nakayama, Akira, Osaka City, Osaka, Japan  
 Nuna, Philippe, Montreal, Quebec, Canada  
 O'Connor, Anne M., Kilkenny, Ireland  
 Ou Yang Chung Meing, Taichung, Taiwan, R.O. China  
 Pace, Howard M., Ecceshall, Stafford, Staffordshire  
 Paraskevopoulos, Michael, Athens, Greece  
 Parnell, Alexander J., Finchley Central, London  
 Parr, Louise, Blackburn, Lancashire  
 Pol, Noelia, Florence, Italy  
 Ram, Satyen, Richmond, Surrey  
 Roussou, Zoi-Kiriaki, Athens, Greece  
 Salt, Sebastian J., Salisbury, Wiltshire  
 Sasaki, Takako, Hirakata City, Osaka, Japan  
 Shadbolt, Emma T., Crawley, West Sussex  
 Shin Whan-Ho, Taejon, R.O. Korea  
 Sipsen, Ian, Trowbridge, Wiltshire  
 Symes, Evelyn R., Bath  
 Tang Wai Ling Ng, Elaine, Pinner, Middlesex  
 Teramae, Ikumi, Ealing, London  
 Trudel-DeCelles, Maureen E., Hudson, Quebec, Canada  
 Tsang May Yuk, Rebecca, Causeway Bay, Hong Kong  
 Tun, Maung Myint, Lannavaara, Sweden  
 Vikstrom, Jens, Timra, Sweden  
 Vodden, Ross J., Surbiton, Surrey  
 Voutsinas, Dimitris, Athens, Greece  
 Wada, Natsuko, Takarazuka City, Hyogo Pref., Japan  
 Wang Chun-Chou, Taipei, Taiwan, R.O. China  
 Warner, Rachel F., Padworth Common, Reading, Berkshire  
 Wasim, Baber, Karachi, Pakistan  
 Wong Lai Ching, Candy, Kowloon, Hong Kong  
 Wu Lai Ngor, Kowloon, Hong Kong  
 Xu Jing, Guilin, Guangxi, P.R. China  
 Yang Hui-Ju, Taipei, Taiwan, R.O. China  
 Yu Chien-Wen, Taipei, Taiwan, R.O. China  
 Zhan Ni, Guilin, Guangxi, P.R. China  
 Zhou Ke, Shanghai, P.R. China

**MEMBERSHIP**

The following have been elected to membership during June, July and August 2000:

**Fellowship and Diamond Membership (FGA DGA)**

Hsu Miao-Chu, Taichung, Taiwan, R.O.C., 2000

Osborne, Sean J., Temple Bar, Dublin, Ireland,  
1989/1990

#### **Fellowship (FGA)**

Fu Sheng, Sushau, R.O.C., 2000  
Gao Yuan, Mr, Shanghai, P.R. China, 2000  
Naotunne, Kusum S., Ratnapura, Sri Lanka, 1982

#### **Diamond Membership (DGA)**

Chen Shu-Chen, Kaohsiung, Taiwan, RO China,  
2000  
Keating, Shelley, Surrey Quays, London, 2000  
Panagopoulou, Anastasia, Athens, Greece, 1998

#### **Ordinary Membership**

Aziz, Rauther, Enfield, Middlesex  
Befi, Riccardo, New York, U.S.A.  
Bensimon, Maurice, Vaerlose, Denmark  
Clayton, Robin Edward, Oxford  
Clayton, Roy, Barton-on-sea, Hampshire  
Gadd, Craig Allan, Bristol  
Harper, Nina, York  
Ismail, Talat, Cheltenham, Gloucestershire  
Leibenberg, Jeanine, Cape Town, South Africa  
McMahon, Norma, Thornton Heath, Surrey  
Olivier, Adriaan Dirk, Richards Bay, South Africa  
Pollatos, Evonne-Eftyhia, London  
Pornsawat, Wathankul, Bangkok, Thailand  
Randall, Peter E., Filey, North Yorkshire  
Reza, Shahab, Stanmore, Middlesex  
Robbins, Gerald, Philadelphia, P.A., U.S.A.  
Sanders, Laurreta, Beaconsfield, Buckinghamshire  
Simonassi, Jucelino, Poplar, London  
Sims, Amanda, Stoke-on-Trent, Staffordshire  
Slaughter, Monica, Worcester Park, Surrey  
Stedman, Honour Thomasin, Newhaven, East  
Sussex  
Sutton, Collette Stefania, Solihull, West Midlands  
Waldron, Mark, Neasden, London  
Warner, Rachel Fleur, Nr. Reading, Berkshire  
Williams, Cara, Jefferson City, Missouri, U.S.A.

#### **Laboratory Membership**

H. Chalfen Ltd., London EC1N 8AT  
Cry for the Moon, Guildford, Surrey GU1 3QT

### **ISLAND OF GEMS**

An exhibition on the gems and gem industry of Sri Lanka is to be held from 14 to 16 December at the St Albans Centre, Baldwin's Garden, London EC1N 7AB, in the vicinity of Hatton Garden.

The main objective of the exhibition, as in previous years, is to give a wider publicity to Sri Lanka's gem industry in Europe.

All visitors will be given a chance to examine for themselves some typical Sri Lankan gemstones using many gem testing instruments. There will be

### **SUBSCRIPTIONS 2001**

The following are the membership subscription rates for 2001. Existing Fellows, Diamond Members and Ordinary Members will be entitled to a £5.00 discount for subscription paid before 31 January 2001.

	<i>Fellows, Diamond Members and Ordinary Members</i>	<i>Laboratory Members</i>
UK	£62.00	£250.00 plus VAT
Europe	£68.00	£250.00
Overseas	£74.00	£250.00

five units which include geology, gem mining, gem cutting and polishing, gemstones and education. Over 30,000 gemstones will be displayed, including sapphires of many colours, many of the stones commonly found in Sri Lanka and some rare gemstones.

The entrance fee, which includes a free gemstone and a souvenir brochure, is £3.00 (children under 12 free of charge). To celebrate this first exhibition on the Sri Lankan gem industry to be held overseas in the new millennium, the organizers have donated up to £1000 worth of gems and jewellery.

For further information contact D.H. Ariyaratna on 020 8807 8252 (telephone and fax), e mail sri@lankagems.co.uk, website www.lankagems.co.uk

### **ERRATUM**

On p.158 above, first column, line 15, for (687 - 381) read (687 - 431)

# Letters to the Editor

Maw-sit-sit from Myanmar

## *From Win Htein and Aye Myo Naing*

We refer to the recent article by Colombo, Rinaudo and Trossarelli (2000).

Dr Gübelin (1965a, b) was the first author to describe the gemmological account of maw-sit-sit. In his article there is a coloured photograph showing five polished samples of maw-sit-sit. All his pieces reveal typical colours and patterns of maw-sit-sit which are described as:

'... while strolling around in Mogaung, watching the jade lapidaries and their curious implements (Fig. 1) [i.e. the above-mentioned photo], I noticed a few polished slabs and buttons of an unusual, very bright and pleasant green hue, nicely patterned by dark green to black spots and veins ... They appeared completely unlike any other green opaque gemstones that I had seen before ...'

The mineral composition and coloured photographs of a few maw-sit-sit samples were more recently given by Win Htein and Aye Myo Naing (1995). The proportions of the constituent minerals are greatly variable from one sample to another.

The colour, pattern and appearance in two coloured photographs (Figs 1a and 1b) of the sample studied by Colombo *et al.* (2000) do not look like a maw-sit-sit and also do not meet with Dr Gübelin's description. It is more similar to jade-like material, locally called 'palwan' or 'palun'. The so-called palwan also occurs in the jade mine areas of Myanmar and is mainly composed of albite, quartz and minor epidote with or without other minerals. Judging from the relatively low RI (1.54) and low SG (2.7) values and its dissimilar appearance from maw-sit-sit, the studied sample is more likely to be a palwan. It is probably a misnomer.

*Dr Win Htein*

*Geology Department, Yangon University, Myanmar*

*Aye Myo Naing*

*Myanmar VES Joint Venture Co. Ltd, No. 66, Kaba Aye Pagoda Road, Yangon, Myanmar*

## *Reply from C. Rinaudo*

We are pleased to respond to the letter by Dr Win Htein and Ms Aye Myo Naing concerning the features of maw-sit-sit.

The remarks they make in their letter sound interesting. Unfortunately, in the articles we consulted, only hints could be found regarding the palwan stone, essentially quoted as a curiosity (*Gems & Gemology*, 1964-65, 11(8), and *J.Gemm.*, 1995, 24(5), the latter paper giving a list of the constituent minerals).

Our project started because we were attracted by the plaque and were induced to investigate it, since it really appeared like maw-sit-sit despite the seeming lack of the typical features of this stone, namely the spots and veins from very deep green to black in colour. This absence, hard to cope with, puzzled us from the beginning of the investigation. On the other hand, had these features been visible to the naked eye, the plaque could have been a subject for exchange of aesthetic opinions between its owner, Mr Scardina, and ourselves.

However, study under the polarising microscope revealed the texture typical of the constituent minerals of maw-sit-sit, and also enabled us to detect a (metallic-dark) spot of chromite; this combination induced us to name the plaque maw-sit-sit.

It was our omission not to produce a photograph of the area where the spot of Fig. 4 of our article is visible, taken at low magnification and with an illumination suitable to illustrate its dark appearance, typical of the maw-sit-sit spots reported by Gübelin (1965a, b).

Finally, from all the above, we wonder whether the palwan stone cannot be considered as a 'variety' of maw-sit-sit if the following is considered:

- the qualitative composition of the palwan stone reported by Win Htein and Aye Myo Naing is seemingly the same as maw-sit-sit with only the ratios of the constituents varying;
- the texture of our stone is identical, under the microscope, to that of maw-sit-sit;

- according to the above quoted authors, the inhabitants assign the name 'palwan' after the *macroscopic* appearance (visible to the naked eye) of the stone;
- the quantity of the constituents of maw-sit-sit is variable and apropos of this fact, we refer to Manson (1979) who stated that the composition is essentially natrolite + kosmochlor, implying variation in the constituents of maw-sit-sit. Therefore the stone studied by us might be considered as maw-sit-sit variety particularly poor in spots.

As for the disagreement between the specific gravity of the maw-sit-sit samples studied by Gübelin (1965) (SG = 2.77) and that of our stone (SG = 2.7), it has to be noted that Gübelin's figure gives an *average*. This allows the possibility that the value 2.7 may be close to the lowest value found by Gübelin. The lesser value found by us may be attributed to the lower content in chromite crystals (SG = 4.5-4.8) and kosmochlor (SG = 3.60, calc.). Similarly, our refractive index (1.54) coincides with the higher values found by Gübelin.

In conclusion, the aforesaid is not to say that our position is definite but is presented in a

constructive way to advance the discussion about maw-sit-sit and jade.

We welcome the important observations in the letter by Dr Win Htein and Ms Aye Myo Naing and would be very interested to establish collaborative research with them.

*Professor C. Rinaudo*  
 Dipartimento di Scienze e Tecnologie Avanzate,  
 Università degli Studi del Piemonte Orientale, Corso  
 Borsalino, 54, 15100 Alessandria, Italy

Colombo, F., Rinaudo, C., and Trossarelli, C., 2000.

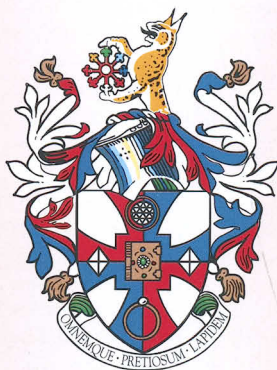
The mineral composition of maw-sit-sit from Myanmar. *J.Gemm.*, 27(2), 87-92

Gübelin, E., 1965a. Maw-sit-sit - a new decorative gemstone from Burma. *J.Gemm.*, 9(10), 329-44

Gübelin, E., 1965b. Maw-sit-sit proves to be jade-albite. *J.Gemm.*, 9(11), 372-9

Manson, V., 1979. Recent activities in GIA's Research Department. *Gems & Gemology*, 16(7), 217-19

Win Htein and Aye Myo Naing, 1995. Studies of kosmochlor, jadeite and associated minerals in jade of Myanmar. *J.Gemm.*, 24(5), 315-20



## COAT OF ARMS Fellows and Diamond Members

Members of the GAGTL having gained their Diploma in Gemmology or the Gem Diamond Diploma (FGA or DGA) may apply for the use of the Coat of Arms on their stationery, within advertisements and on their website.

### **New! The Coat of Arms is now available in colour on disk.**

It is a requirement of the GAGTL that written permission be granted by the Council of Management before use.

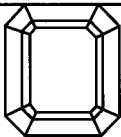
An application fee of £35 is payable with an annual renewal fee of £15.

For further information and an application form contact Mary Burland at the GAGTL  
 27 Greville Street, London EC1N 8TN (Tel: 020 7404 3334; Fax 020 7404 8843)



Pearls Coral Amber Bead Necklaces Carvings Cameos Mineral Specimens

The World



of Gemstones

Opal Precious Topaz Ruby Star Ruby Sapphire Star Sapphire Tourmaline

Gemstones Aquamarine Alexandrite Amethyst Emerald Jade Lapis-Lazuli

## Ruppenthal (U.K.) Limited

Gemstones of every kind, cultured pearls, coral, amber, bead necklaces, hardstone carvings, objets d'art and 18ct gold gemstone jewellery.

We offer a first-class lapidary service.

By appointment only

1a Wickham Court Road, West Wickham, Kent BR4 9LN

Tel: 020-8777 4443, Fax: 020-8777 2321, Mobile: 07831 843287

e-mail: roger@ruppenthal.co.uk, Website: www.ruppenthal.co.uk

Modern 18ct Gem-set Jewellery

## PROMPT LAPIDARY SERVICE!

Gemstones and diamonds cut to your specification and repaired on our premises.

Large selection of gemstones including rare items and mineral specimens in stock.

Valuations and gem testing carried out. Mail order service available.

### R. HOLT & CO. LTD

98 Hatton Garden, London EC1N 8NX  
Telephone 020-7405 0197/5286  
Fax 020-7430 1279

## The Journal of Gemmology

### ADVERTISING

The Editors of the Journal invite advertisements from Gemstone and Mineral dealers, publishers and others with interests in the gemmological, mineralogical, lapidary and jewellery fields.

Rates per insertion, ex. VAT, are as follows

Whole page	Half page	Quarter page
£180	£100	£60

Enquiries to Mary Burland, GAGTL, 27 Greville Street, London EC1N 8TN



## We look after all your insurance PROBLEMS

For nearly a century T.H. March has built an outstanding reputation by helping people in business. As Lloyds brokers we can offer specially tailored policies for the retail, wholesale, manufacturing and allied jewellery trades. Not only can we help you with all aspects of your business insurance but also we can take care

of all your other insurance problems, whether it be home, car, boat or pension plan.

We would be pleased to give advice and quotations for all your needs and delighted to visit your premises if required for this purpose, without obligation.

Contact us at our head office shown below.



**T.H. March and Co. Ltd.**

Walker House, 89 Queen Victoria Street, London EC4V 4AB

Telephone 020 7651 0600 Fax 020 7236 8600

Also at Birmingham, Manchester, Glasgow, Plymouth and Sevenoaks.

Lloyd's Insurance Brokers

*You can't beat  
Experience*

## SSEF develops a new device for Type IIa Diamond Identification

Type IIa diamonds are those which are regarded as free from nitrogen; they represent less than 1% of the world diamond production. The identification of Type IIa diamonds has two interesting aspects. Firstly, the estimated origin of Golconda is frequently related to Type IIa diamonds. It is, however, well known that the deposit of Golconda also produces all other kinds of diamonds, and that Type IIa diamonds are also found in other deposits worldwide.

Secondly, the GE POL colourless treated diamonds are almost all of Type IIa.

SSEF has built a simple device to test diamonds which can be used together with a short wave ultraviolet (254 nm SWUV) light source in a darkened room. Since Type IIa diamonds are transparent to SWUV the transmitted radiation can be used to create fluorescence reaction on a material sensitive to SWUV, such as scheelite or synthetic spinel.

### Type IIa diamonds identified with the SSEF Type IIa Diamond Spotter

As the vast majority of GE POL colourless diamonds are Type IIa, it is important for those in the trade to be able to separate these near-colourless diamonds,

potentially GE POL treated, from those of other types. Laboratories do this on the basis of infrared absorption; however, most jewellers do not have an infrared spectrometer. In addition, the original definition of Type I and Type II diamonds is based also on transparency to SWUV radiation. When putting a diamond on top of the SSEF Type IIa Diamond Spotter and illuminating it with SWUV, Type IIa stones will transmit the radiation, exciting a green fluorescent screen placed underneath the stones. If the screen remains inert, the stone is not Type IIa.



This is a quick and easy way of recognizing Type IIa stones without infrared spectrometry. There will also be the even rarer Type IaB diamonds, that transmit.

**Warning:** Be sure to protect your eyes from the SWUV when working with the SSEF Type IIa Diamond Spotter and SWUV radiation.

For further details see:

Chalain *et al.*, 1999. Detection of GE POL diamonds: a first stage. *Revue de Gemmologie*, 138/139, 27-30

Chalain *et al.*, 2000. Identification of GE POL diamonds: a second step. *Journal of Gemmology*, 27(2), 73-8

The SSEF Type IIa Diamond Spotter is available from the SSEF at US\$ 150 (plus shipment)

SSEF Swiss Gemmological Institute

Falknerstrasse 9, CH-4001 Basel, Switzerland

Tel: +41 61 262 06 40 Fax: +41 61 262 06 41 email: [gemlab@ssef.ch](mailto:gemlab@ssef.ch) website: [www.ssef.ch](http://www.ssef.ch)

# ROCK 'n' GEM SHOWS

*Exhibitors displaying and  
selling a huge range of Rocks,  
Gemstones, Minerals,  
Fossils, Books and Jewellery.*



## 2000

### NEWCASTLE RACECOURSE

High Gosforth Park, Newcastle, Tyne & Wear  
**28-29 OCTOBER**

### NEWMARKET RACECOURSE

Newmarket, Suffolk  
**11-12 NOVEMBER**



## 2001



### HATFIELD HOUSE

Hatfield, Hertfordshire (Jct 4 of A1(M))  
**20-21 JANUARY**

### THE HOP FARM

Beltring, Paddock Wood, Kent  
**27-28 JANUARY**

### BRIGHTON RACECOURSE

Freshfield Road, Brighton, E. Sussex  
**24-25 FEBRUARY (prov.)**

*Shows Open 10am - 5pm  
Trade & Public*

*Refreshments ~ Free Parking ~ Wheelchair Access*

*Adults £2.25, Seniors £1.75,  
Children (8-16 yrs) £1.00*

*THE EXHIBITION TEAM LTD 01628 621697*

*Pearls  
Gemstones*

*Lapidary Equipment*

**GENOT L**

Since 1953

*CH. De Wavre, 850  
B-1040 Bxl - Belgium*

*Tel : 32-2-647.38.16*

*Fax : 32-2-648.20.26*

*E-mail : gama@skynet.be*

[www.gemline.org](http://www.gemline.org)  
[www.geofana.net](http://www.geofana.net)

### Museums, Educational Establishments, Collectors & Students

I have what is probably the largest range of genuinely rare stones in the UK, from Analcime to Wulfenite. Also rare and modern synthetics, and inexpensive crystals and stones for students. New computerised lists available with even more detail. Please send £2 in 1st class stamps refundable on first order (overseas free).

**Two special offers for students:**  
New Teach/Buy service and free stones on an order.

A.J. French, FGA  
82 Brookley Road, Brockenhurst,  
Hants SO42 7RA  
Telephone: 01590 623214



# Guide to the preparation of typescripts for publication in *The Journal of Gemmology*

The Editor is glad to consider original articles shedding new light on subjects of gemmological interest for publication in *The Journal*. Articles are not normally accepted which have already been published elsewhere in English, and an article is accepted only on the understanding that (1) full information as to any previous publication (whether in English or another language) has been given, (2) it is not under consideration for publication elsewhere and (3) it will not be published elsewhere without the consent of the Editor.

**Typescripts** Two copies of all papers should be submitted on A4 paper (or USA equivalent) to the Editor. Typescripts should be double spaced with margins of at least 25 mm. They should be set out in the manner of recent issues of *The Journal* and in conformity with the information set out below. Papers may be of any length, but long papers of more than 10 000 words (unless capable of division into parts or of exceptional importance) are unlikely to be acceptable, whereas a short paper of 400–500 words may achieve early publication.

The abstract, references, notes, captions and tables should be typed double spaced on separate sheets.

On matters of style and rendering, please consult *The Oxford dictionary for writers and editors* (Oxford University Press, 1981).

**Title page** The title should be as brief as is consistent with clear indication of the content of the paper. It should be followed by the names (with initials) of the authors and by their addresses.

**Abstract** A short abstract of 50–100 words is required.

**Key Words** Up to six key words indicating the subject matter of the article should be supplied.

**Headings** In all headings only the first letter and proper names are capitalized.

## A This is a first level heading

First level headings are in bold and are flush left on a separate line. The first text line following is flush left.

## B This is a second level heading

Second level headings are in italics and are flush left on a separate line. The first text line following is flush left.

**Illustrations** Either transparencies or photographs of good quality can be submitted for both coloured and black-and-white illustrations. It is recommended that authors retain copies of all illustrations because of the risk of loss or damage either during the printing process or in transit.

Diagrams must be of a professional quality and prepared in dense black ink on a good quality surface. Original illustrations will not be returned unless specifically requested.

All illustrations (maps, diagrams and pictures) are numbered consecutively with Arabic numerals and labelled Figure 1, Figure 2, etc. All illustrations are referred to as 'Figures'.

**Tables** Must be typed double spaced, using few horizontal rules and no vertical rules. They are numbered consecutively with Roman numerals (Table IV, etc.). Titles should be concise, but as independently informative as possible. The approximate position of the Table in the text should be marked in the margin of the typescript.

**Notes and References** Authors may choose one of two systems:

(1) The Harvard system in which authors' names (no initials) and dates (and specific pages, only in the case of quotations) are given in the main body of the text, e.g. (Gübelin and Koivula, 1986, 29). References are listed alphabetically at the end of the paper under the heading References.

(2) The system in which superscript numbers are inserted in the text (e.g. ... to which Gübelin refers.<sup>3</sup>) and referred to in numerical order at the end of the paper under the heading Notes. Informational notes must be restricted to the minimum; usually the material can be incorporated in the text. If absolutely necessary both systems may be used.

References in both systems should be set out as follows, with *double spacing* for all lines.

**Papers** Hurwit, K., 1991. Gem Trade Lab notes. *Gems & Gemology*, 27, 2, 110–11

**Books** Hughes, R.W., 1990. *Corundum*. Butterworth-Heinemann, London. p. 162

Abbreviations for titles of periodicals are those sanctioned by the *World List of scientific periodicals* 4th edn. The place of publication should always be given when books are referred to.





# Contents

The Journal of  
Gemmology

Two contrasting nephrite jade types	193
<i>D. Nichol</i>	
Investigation of seven diamonds, HPHT treated by NovaDiamond	201
<i>F. De Weerd and J. Van Royen</i>	
Diamond brilliance: theories, measurement and judgement	209
<i>M. Cowing</i>	
Oriented inclusions in spinels from Madagascar	229
<i>K. Schmetzer, E. Gübelin, H.-J. Bernhardt and L. Kiefert</i>	
Critical angle vs. deviation angle vs. Brewster angle	233
<i>R.H. Cartier</i>	
Abstracts	237
Book Reviews	242
Proceedings of the Gemmological Association and Gem Testing Laboratory of Great Britain and Notices	243
Letters to the Editor	251

#### Cover Picture

Lamella in purple spinel from Ilakaka, Madagascar, consisting of polycrystalline rutile.

*Photomicrograph by  
K. Schmetzer*

(see 'Oriented inclusions in spinels from Madagascar', pp.229-232)

Copyright © 2000

The Gemmological Association and  
Gem Testing Laboratory of Great Britain

Registered Office: Palladium House, 1-4 Argyll Street, London W1V 2LD