

Gems & Gemology

VOLUME XXI

SPRING 1985



The quarterly journal of the Gemological Institute of America

Gems & Gemology

TABLE OF CONTENTS

EDITORIAL	1	The Gems & Gemology Most Valuable Article Award <i>Alice S. Keller</i>
FEATURE ARTICLES	3	Gem Pegmatites of Minas Gerais, Brazil: The Tourmalines of the Araquai Districts <i>Keith Proctor</i>
	20	Sapphire from the Mercaderes-Río Mayo Area, Cauca, Colombia <i>Peter C. Keller, John I. Koivula, and Gonzalo Jara</i>
	26	Altering the Color of Topaz <i>Kurt Nassau</i>
NOTES AND NEW TECHNIQUES	35	A Preliminary Report on the New Lechleitner Synthetic Ruby and Synthetic Blue Sapphire <i>Robert E. Kane</i>
	40	Interesting Red Tourmaline from Zambia <i>John I. Koivula and C. W. Fryer</i>
REGULAR FEATURES	43	Gem Trade Lab Notes
	49	Gemological Abstracts
	56	Book Reviews
	57	Gem News
	62	Suggestions for Authors

ABOUT THE COVER: Because of the wide variety of colors in which it occurs, and its attractiveness and availability as a gem material, tourmaline has gained great popularity in recent years. Two articles in this issue deal with tourmaline: one with the area that has produced more tourmaline than anywhere else in the world—Minas Gerais, Brazil; the other with a new locality for red tourmaline—Zambia. The pendant shown here well illustrates why this material has become so popular. It is composed of two green tourmalines (7.68 ct total weight), two pink tourmalines (9.60 ct), and one bicolored tourmaline (12.90 ct), all from the Himalaya mine (California). The stones were faceted by Pala International, Fallbrook, California; the pendant, by Ludolf Duhrsen, is from a private collection. Photo ©1985 Harold & Erica Van Pelt—Photographers, Los Angeles.

Typesetting for Gems & Gemology is by Scientific Composition, Los Angeles, CA. Color separations are by Effective Graphics, Compton, CA. Printing is by Waverly Press, Easton, MD.

Gems & Gemology

EDITORIAL STAFF

Editor-in-Chief

Richard T. Liddicoat, Jr.

Associate Editors

Peter C. Keller
D. Vincent Manson
John Sinkankas

Technical Editor

Carol M. Stockton

Editor

Alice S. Keller
1660 Stewart St.
Santa Monica, CA 90404
Telephone: (213) 829-2991

Editorial Assistant

Sally A. Thomas

Subscriptions

Janet M. Fryer, Manager
Lisa Hebenstreit, Assistant Manager

Editor, Gem Trade Lab Notes

C. W. Fryer

Editor, Gemological Abstracts

Dona M. Dirlam

Editor, Book Reviews

Michael Ross

Contributing Editor and

Editor, Gem News

John I. Koivula

PRODUCTION STAFF

Art Director

Susan Kingsbury

Production Assistant

Lisa Joko

Production Assistant

John McCloy

EDITORIAL REVIEW BOARD

Robert Crowningshield
New York, NY

Pete Dunn
Washington, DC

Dennis Foltz
Santa Monica, CA

Chuck Fryer
Santa Monica, CA

C. S. Hurlbut, Jr.
Cambridge, MA

Anthony R. Kampf
Los Angeles, CA

Robert E. Kane
Los Angeles, CA

John Koivula
Santa Monica, CA

Henry O. A. Meyer
West LaFayette, Indiana

Sallie Morton
San Jose, CA

Kurt Nassau
Bernardsville, NJ

Glenn Nord
Los Angeles, CA

Ray Page
Santa Monica, CA

George Rossman
Pasadena, CA

James E. Shigley
Santa Monica, CA

SUBSCRIPTIONS

Subscriptions in the U.S.A. are priced as follows: \$29.50 for one year (4 issues), \$82.50 for three years (12 issues). Subscriptions sent elsewhere are \$40.00 for one year, \$115.00 for three years.

Special annual subscription rates are available for all students actively involved in a GIA program: \$24.50 U.S.A., \$35.00 elsewhere. Your student number *must* be listed at the time your subscription is entered.

Single issues may be purchased for \$8.00 in the U.S.A., \$11.00 elsewhere. Discounts are given for bulk orders of 10 or more of any one issue. A limited number of back issues of G&G are also available for purchase.

Please address all inquiries regarding subscriptions and the purchase of single copies or back issues to the Subscriptions Manager.

MANUSCRIPT SUBMISSIONS

Gems & Gemology welcomes the submission of articles on all aspects of the field. Please see the Suggestions for Authors for preparing manuscripts in this issue of the journal or contact the Managing Editor for a copy. Letters on articles published in *Gems & Gemology* and other relevant matters are also welcome.

COPYRIGHT AND REPRINT PERMISSIONS

Abstracting is permitted with credit to the source. Libraries are permitted to photocopy beyond the limits of U.S. copyright law for private use of patrons. Instructors are permitted to photocopy isolated articles for noncommercial classroom use without fee. For other copying, reprint, or republication permission, please contact the Editor.

Gems & Gemology is published quarterly by the Gemological Institute of America, a nonprofit educational organization for the jewelry industry, 1660 Stewart St., Santa Monica, CA 90404.

Application to mail at second class postage rates is pending in Santa Monica, CA 90404 and at additional mailing offices.

Postmaster: Return undeliverable copies of *Gems & Gemology* to 1660 Stewart St., Santa Monica, CA 90404.

Any opinions expressed in signed articles are understood to be the views of the authors and not of the publishers.

THE GEMS & GEMOLOGY MOST VALUABLE ARTICLE AWARD

ALICE S. KELLER Editor

The field of gemology, like the people who comprise it, encompasses a broad range of interests and concerns. This message was brought home to us once again with the results of this year's voting for the most valuable article published in the journal in 1984.

The winning article, "Freshwater Pearls of North America," by James L. Sweaney and John R. Latendresse, provided a comprehensive review of the history, harvesting, and classification of the pearls found in so many of America's lakes and streams. The second-place article, by Keith Proctor, took us several thousand miles south, to the "Gem Pegmatites of Minas Gerais." The first in a series (which continues in this issue), this article explored the mines of a fascinating area that is undisputably one of the most important producers of fine aquamarine, tourmaline, and topaz in the world today.

With the award for third place, our voters demonstrated their concerns about the sophisticated synthetics and treatments that can cause havoc in the gem market (and headaches for the gemologist). Again this year we had a tie for this award: it will be shared by John I. Koivula and C. W. Fryer for "Identifying Gem-Quality Synthetic Diamonds: An Update," and Robert E. Kane, for "Natural Rubies with Glass-Filled Cavities."

Cash prizes of \$500, \$300, and \$100, respectively, will be awarded to these first, second, and third-place winners. Brief biographies of the winning authors appear on the following page.

Mr. Liddicoat and I would also like to take this opportunity to thank the members of the editorial staff, the Gemological Abstracts staff, and especially, the editorial review board for giving their time and effort to help guarantee another strong year for *Gems & Gemology*. The willingness of Peter Flusser and David Atkinson to serve as guest reviewers is also greatly appreciated, as is—once again—the kindness of Harold and Erica Van Pelt for donating so much of their time and expertise to provide many fine photographs for each issue of the journal.



JAMES L. SWEANEY

Now a practicing jeweler-gemologist with Mardon Jewelers in Riverside, California, Mr. Sweaney spent a number of years in the pearl industry as executive vice-president of American Pearl Creations, Camden, Tennessee. With several articles to his credit, he is as comfortable writing as he is working at the bench or identifying stones.

Mr. Sweaney has a B.A. from California State University, Fullerton, and is both a graduate gemologist and a fellow of the Gemmological Association of Great Britain.



JOHN R. LATENDRESSE

Mr. Latendresse is chief executive officer of Tennessee Shell Company, Inc., American Pearl Company, and American Pearl Creations. He is widely recognized as an authority on natural and cultured pearls, and as such is a popular speaker and consultant. Several years ago, Mr. Latendresse began experiments in the lakes of Tennessee to culture freshwater pearls; the results of his years of research—the first American freshwater cultured pearls—will soon be ready for harvesting.

Mr. Latendresse is a native of South Dakota and attended the University of Nevada.



KEITH PROCTOR

As president of Keith Proctor, Fine Gems, of Colorado Springs, Colorado, Mr. Proctor is actively involved in the wholesale importing of colored gemstones and the design of custom-made jewelry. Mr. Proctor has collected mineral specimens since his childhood, and in recent years he has become internationally known for his collection of museum-quality minerals with a special emphasis on gem crystals. Many of these crystals were obtained during his extensive travels in the mining regions of Brazil.

Mr. Proctor received an M.S. in molecular biology from the University of Colorado.



JOHN I. KOIVULA

Mr. Koivula is senior gemologist in the Applied Gemology Division at GIA Santa Monica and *Gems & Gemology's* Gem News editor. A specialist in the study of inclusions and photomicrography, Mr. Koivula won the 1984 Nikon International Small World competition. He also lectures extensively, and is currently working on a book on inclusions in gemstones that is scheduled for publication in late 1985.

Mr. Koivula has a B.A. in chemistry and a B.S. in mineralogy from Eastern Washington State University. In addition, Mr. Koivula is both a graduate gemologist and a certified gemologist, and holds a fellowship diploma from the Gemmological Association of Great Britain.



C. W. FRYER

After serving 14 years as director of the GIA Gem Trade Laboratory, first in Los Angeles and then in Santa Monica, Mr. Fryer is now chief gemologist in the Applied Gemology Division at GIA Santa Monica and editor of the Gem Trade Lab Notes section of *Gems & Gemology*. He is a noted lecturer on the use of gemological instruments and identification techniques, and has appeared as an expert witness in several court cases.

A native of St. Louis, Missouri, Mr. Fryer is a graduate gemologist, a certified gemologist, and a fellow of the Gemmological Association of Great Britain.



ROBERT E. KANE

Mr. Kane is research and gem identification supervisor at the GIA Gem Trade Laboratory in Los Angeles, as well as a contributing editor for the Gem Trade Lab Notes section of *Gems & Gemology*. His research specialty is treated and synthetic gemstones, on which he has written and lectured extensively. He has also traveled to many of the major gem localities and visited several of the key synthetics manufacturers worldwide.

Mr. Kane, a native of Albuquerque, New Mexico, is a graduate gemologist.

GEM PEGMATITES OF MINAS GERAIS, BRAZIL: THE TOURMALINES OF THE ARAÇUAÍ DISTRICTS

By Keith Proctor

The first article in this series discussed the history of gem mining in Minas Gerais from the colonial period to the present, the nature of granitic pegmatites and derived deposits yielding gemstones, and the important deposits of aquamarine and other gem beryls. The present article describes the major tourmaline deposits in the Araçuaí-Itinga and Araçuaí-Salinas districts of Minas Gerais, focusing on the Virgem da Lapa mines, the Salinas mine, and the Ouro Fino mine. Some of the finest green, blue, red and multicolored tourmalines ever produced originated from these mines.

ABOUT THE AUTHOR

Mr. Proctor is president of Keith Proctor Fine Gems, a wholesale gem import firm in Colorado Springs, Colorado.

Acknowledgments: The author thanks the following people, only some of the many who helped with this article: for providing information on heat treatment, F. Bastos, K. Elawar, GEMINAS Co., A. Millah, K. Nassau, A. Sabbagh, J. Sauer, D. Sauer, H. Stern, A. Tavares, N. Tergeleni; for helpful information on the mines, C. Barbosa, P. Desautels, C. Key, P. Laville, L. Necessian, J. G. Neto, O. Neto, E. Swoboda, R. de Vasconcelos, and C. de Vasconcelos. The Benson Latin American Collection at the University of Texas (Austin) also provided useful information. Thanks also go to J. Sinkankas and J. Shigley for help in editing, to Lyn Moffitt for typing the manuscript, and especially to Mauna Proctor for her help in translating and editing and for her constant support.

Unless otherwise noted in the figure legends, the location photos are by the author. Also, the mineral specimens shown in figures 1, 4, 7, and 16—and the faceted stones in figures 1 and 12—are the property of the author.

© 1985 Gemological Institute of America

In the history of gemstones, tourmaline is a latter-day Cinderella. Whereas aquamarine was known to the Egyptians over 5,000 years ago, tourmaline was not discovered until the mid-1500s, in Brazil. Even then, it was mistakenly heralded as emerald. Over a hundred years passed until, in 1793, it was recognized as a distinct mineral species and named for *toramalli* (from Sinhalese, a term applied to waterworn gem pebbles from Ceylon gravels) by Dutch merchants (Ball, 1930; Zara, 1973). Because the finest shades of red, blue, and green tourmaline may resemble ruby, sapphire, and emerald, the relatively abundant tourmaline has gained popularity as a comparatively inexpensive alternative to these prized colored gems as well as for its own unique attributes.

In the more than 400 years since tourmaline was first discovered in Brazil, millions of carats of fine gem-quality tourmaline have been mined from thousands of granitic pegmatites in northeast Minas Gerais. Virtually every color variety of tourmaline*—red, blue, green, and multicolored (figure 1)—is found in this area. Most of this production has come from two major pegmatite regions: (1) the Araçuaí-Itinga and Araçuaí-Salinas districts, which encompass the cities of Taquaral, Araçuaí, Coronel Murta, and Barra de Salinas; and (2) farther south, the broad area surrounding the city of Governador Valadares. This article, the second in a series on the gem pegmatites of Minas Gerais (see Proctor, 1984, for part 1) describes the first

*Of the complex minerals that make up the tourmaline group, only one species—the lithium-bearing elbaite—is found in gem quality in Brazil. Elbaite has many varieties based on color, including rubellite (red), indicolite (blue), verdolite (green), and achroite (colorless). If more than one color is found in a single crystal, the stone is referred to as a bicolored or multicolored tourmaline. For the sake of simplicity in this article, I will use the group name tourmaline with the color variety as a prefix (e.g., red tourmaline, blue tourmaline, etc.). The term rubellite will occasionally be used to describe the bright red variety.

region; discussion of the Governador Valadares district will follow in the third article in this series.

While countless mines in this area have produced gemstones and mineral specimens, 20 mines are frequently credited with having contributed most to the quality or quantity of gem tourmalines that have made Minas Gerais world famous (figure 2). Of these, the mines in the Virgem da Lapa group, the Salinas mine, and the Ouro Fino mine are especially noteworthy and are described in detail below. Much of the information is based on visits made by the author as recently as 1983. The reader is referred to part 1 of this series for a detailed description of the geological development of the pegmatites of this region, the terminology used to describe these gem deposits, and the mining methods used.

As is the case with the aquamarine described in the first part of this series, it should be kept in mind that much of the blue tourmaline and green tourmaline is heat treated after it is cut. In the case of tourmaline, however, heat treatment serves only to lighten and brighten the original color. Also, unlike aquamarine, only the maximum temperature reached is important, not the amount of time at which the stone is kept at that temperature. In addition, the best colors do not appear exactly when the maximum temperature is reached but only as the stone cools; the rate of cooling can also be important. Thus, heating is an added risk, and requires extreme sophistication and experience to get the best colors without overly lightening the stone. Also, unlike aquamarine, tourmaline cannot be heat treated if it has inclusions, which is why most rubellite is not heated. Rose tourmaline also becomes lighter if heated, so most natural rose stones are not heat treated. However, a pleasing "rose" color frequently is produced by heating the brownish purple tourmaline called *batata roxa* (purple potato) at approximately 250°–400°C (Bastos, 1972).

To produce the more desirable lighter and brighter colors in green and blue tourmaline, the cut stones are commonly heated to between 600° and 700°C. This process is referred to as "opening the color" (*abrir a cor*). Possibly 10% must be heated to as high as 750°C (with greater risk), and a few are heated (with much risk) to 780°C, but recrystallization sometimes occurs on the surface of these stones at the higher temperatures so that they must be repolished. In the author's experi-

ence, the colors produced in tourmaline as a result of heat treatment are totally stable. It has been reported that some tourmalines are irradiated to develop or intensify either a red or yellow color (Nassau, 1984), but the author did not encounter such a treatment operation in this area during his research.

ARAQUAÍ-ITINGA DISTRICT

This pegmatite belt runs from Itinga on the east to Araçuai on the southwest, encompassing the Piauí River valley to the south and the Jenipapo River valley to the north. A striking feature of the terrain is the many smoothly rounded granite domes, or *inselbergs*, that are characteristic of this pegmatite region (figure 3). Pegmatite mines in this district were being exploited as early as the late 1800s and early 1900s, with the city of Araçuai (once a commercial center for diamond-mining activity in the region) serving as the central supply and trading point. According to Dr. Hermann Bank, whose father lived in the then-hamlet of Araçuai from 1909 to 1912 and exported tourmaline to Germany, conditions were so primitive that it took five weeks to travel the 720 km (450 mi.) to Rio de Janeiro.

The pegmatites of this district are characteristically altered, and both primary (in situ) and secondary (resulting from erosion and transport) deposits are exploited for gemstones, especially for the green, blue-green, and blue tourmalines that are among the finest of their kind in all of Brazil. Some superb red tourmaline is also obtained from time to time, for example, from the Jenipapo and Olho d'Água mines, but generally not in the quantity produced in the pegmatite belt immediately to the west. The Araçuai-Itinga district is an important source of lithium minerals (lepidolite, spodumene, petalite, and amblygonite) as well as gem tourmaline (José and Svizeros, 1976; Sa, 1977; Afgouni and Sa, 1977; Cassedanne and Cassedanne, 1978, 1980). In fact, it is the largest lithium-tin pegmatite district in Brazil.

Large crystal-lined gem pockets have been found in some of the primary pegmatite bodies, and large concentrations of crystals in some of the secondary deposits, with the result that there have been a number of incredibly rich finds of tourmaline. For example, in 1963, 150 kg (330 lb.) of crystals were found in one deposit; while in January 1966, another pegmatite yielded an astounding 300 kg (660 lb.) of crystals. Large numbers of



Figure 1. This 7.5-cm-long multicolored tourmaline crystal and the accompanying 26.25-ct faceted tourmaline represent some of the best gem material found at the Salinas mine, in the Araçuaí-Salinas area of northeastern Minas Gerais, Brazil. Photo © Harold & Erica Van Pelt.

spodumene crystals (including a few fine kunzites) were also found in this district, in the Neves mine (Lindner, 1966, 1967; Lindner and Rolff, 1968; Rolff, 1969, 1971). Most of the finest gem tourmalines from this region have been recovered in the last 20–25 years.

The most productive tourmaline deposits in this district have been found in the valleys of the Piauí and Jenipapo rivers; six mines, all located within a few kilometers of the city of Taquaral (see figure 2), have been singled out for the quality of the tourmaline they produced. The green and blue-green tourmaline from the *Pirineus mine* is among the best ever found in Brazil, but only 50 kg

total of the finest cutting material was found (Levon Nercessian, pers. comm., 1985). The *Piauí mine* also produced fine green and blue-green rough, approximately two to three times that found at Pirineus. In addition, tourmaline crystals from this mine often exhibit four different shades of green within the same crystal. Tourmaline from both of these mines was prized for another very important reason: the better-quality gems could be cut perpendicular to the c-axis of the crystal with practically no change in the quality of color, unlike much green tourmaline from other deposits which exhibits a disagreeable olive hue when cut in any direction other than parallel to the crystal prism.

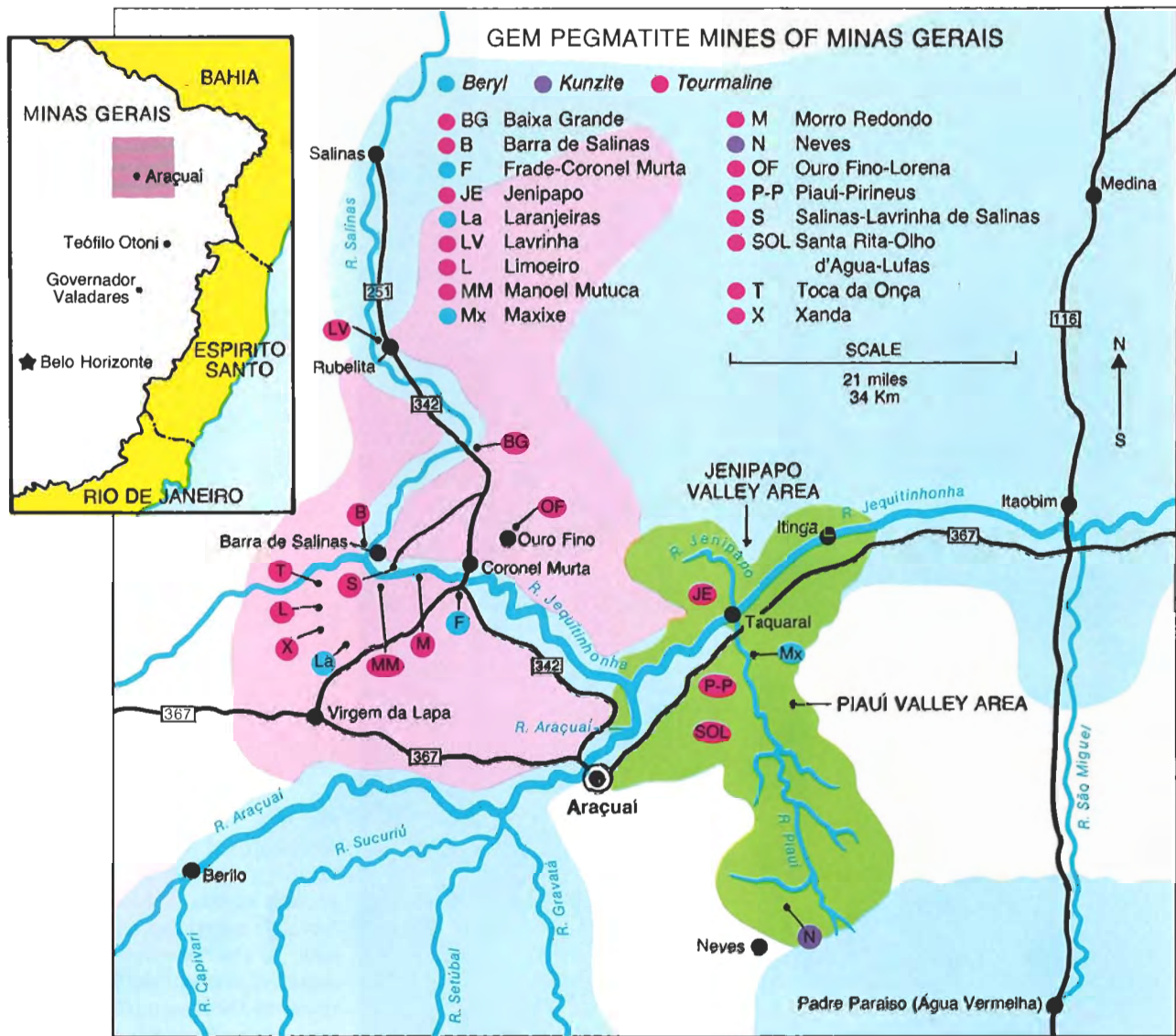

Figure 2. The Araçuaí area of northeastern Minas Gerais, Brazil, is noted for its production of fine tourmalines. The two major gem pegmatite districts are Araçuaí-Itinga (here shaded in green because it produces predominantly green and blue tourmaline) and Araçuaí-Salinas (here shaded in pink because it is noted primarily for the red and multicolored tourmalines found there). The major mines are identified. Some beryl is also found in these two districts, as well as in those shaded in blue which were discussed in the first article in this series (Proctor, 1984; see this article for a map of all the major gem pegmatite mines of northeastern Minas Gerais). Artwork by Lisa Joko.

Consequently, larger stones could be cut from the tourmalines found at this mine than from other tourmalines in the district.

The *Jenipapo* mine (named after a type of fruit), is one of the most productive tourmaline mines in the region, having produced hundreds of kilograms of good rough. Some red tourmaline has been found, along with larger amounts of green and blue tourmaline. In addition, multicolored stones, in which as many as six or seven distinct hues can be seen, are common. The *Olho d'Água* (eye of water) mine has produced superb blue and green tourma-

lines as well as some small quantities of red tourmalines that rival those from the famous Ouro Fino mine. Fine bicolored crystals have also been found there. The nearby *Santa Rita* and *Lufas* mines have produced small quantities of what many dealers consider the finest blue tourmalines of the district, as well as occasional pockets of rubellite.

For the most part, the history and geology of the mines in this district have been lost; few of the original mine owners or *garimpeiros* (independent miners) remain to recount the events surrounding



Figure 3. Inselbergs dominate the landscape in this view looking west toward Itinga from a spot near the Jequitinhonha River. Gem deposits are frequently found in the immediate vicinity of these giant batholiths. Photo by Charles Key.

the periods of greatest activity. Because heavy machinery and blasting are required to work these gem deposits, many of which are found in the unaltered primary pegmatite (e.g., the Pirineus, the Piauí, and the Olho d'Água), production costs are high. Unless pockets of gemstones are encountered consistently, the mines are quickly abandoned. The Jenipapo (an altered, secondary deposit) is the only mine being worked at present.

The Araçuaí-Itinga district overlaps portions of the Jequitinhonha River district (Proctor, 1984), so aquamarine is also found in this region. Another notable gem material, Maxixe beryl, was first found in the valley of the Piauí River in 1917 (Wood and Nassau, 1968; Nassau and Wood, 1973; Nassau et al., 1976).

ARAÇUAÍ-SALINAS DISTRICT

This is the richest tourmaline-producing district in all of Brazil and perhaps in the world. The most productive pegmatites, which lie between the two cities of Araçuaí and Salinas, have yielded many splendid crystals in a variety of colors. Pegmatites in this district characteristically contain much less lithium mineralization than noted in Araçuaí-Itinga; but they produce a greater variety of other gem crystals, including beryls and topazes, as well as tourmalines and especially rubellites (Cassedanne and Lowell, 1982). The Araçuaí-Salinas district overlaps the west end of the Jequitinhonha River pegmatite belt, and fine aquamarine is found along the Araçuaí, Jequitinhonha, and Salinas rivers from Araçuaí

north to Salinas. Three of the most famous tourmaline localities in Brazil—Virgem da Lapa, Salinas, and Ouro Fino—lie in this area (again, see figure 2) and are discussed in detail below. Not only are these three localities notable for their production of fine gemstones, but they also illustrate three different degrees of mineralogical complexity, chemical decomposition, erosion, and dispersal common to the gem pegmatites of Minas Gerais.

Virgem da Lapa. The Virgem da Lapa (virgin of the cave) mines may be reached by traveling west on Diamantina dirt road MG-367 about 43 km (27 mi.) from Araçuaí to the city of Virgem da Lapa (which derived its name from a religious statue located in a small grotto near the town church). From Virgem da Lapa, continue on MG-367 north-northwest and climb continuously for about 13 km (8 mi.) to reach the flat plateau where the airport is situated. At this point, a rough bush road takes you north to the various mines. At best, the last few kilometers of this road are passable by a four-wheel-drive vehicle. They are totally impassable during the rainy season.

The Virgem da Lapa group of mines consists of a series of near-horizontal tabular or lens-shaped bodies of unaltered complex granitic pegmatite. Five mines exploit the pegmatites, which are geologically the most differentiated and heterogeneous gem pegmatites yet discovered in Brazil. While these unaltered pegmatites imposed great difficulties in mining, the yields from pockets contain-

ing gem crystals and matrix mineral specimens in their pristine state has more than compensated the miners for their efforts. Since 1974, for example, miners have found superb crystals of green tourmaline, some as long as 33 cm (13 in.) and weighing as much as 2.4 kg, also crystals of deep blue tourmaline up to 1.2 kg, and blue topaz crystals weighing as much as 30 kg, as well as numerous other rare minerals and matrices of perfect feldspar and lepidolite crystals. In addition, 7-cm-long purple gem hydroxyl-herderite crystals of unequalled size and quality were found (Moore, 1973; Dunn et al., 1979; photo in Bancroft, 1984, p. 210), as well as 15-cm (6 in.) green gem beryl crystals on well-crystallized feldspar matrix (photo in Bancroft, 1984, p. 205).

The five major mines of the Virgem da Lapa group are the Limoeiro (lemon tree), Xanda, Manoel Mutuca, Toca da Onça (cave of the jaguar), and Laranjeiras (orange tree). The first three will be discussed in detail here; the Toca da Onça and Laranjeiras are no longer being worked, and little information is available on them specifically. We do know that some pockets at the Toca da Onça yielded fine green tourmaline and gem green beryl crystals. The Laranjeiras mine is the source of the 15-cm gem green beryl crystals as well as of some blue tourmaline. The pegmatites in this area were first mined during World War II for commercial beryl on land owned by the family of Servio Getulio Ursine (nicknamed "Xanda"). When demand for beryllium, mica, and quartz dropped after the war, all of the mines were virtually abandoned for many years. Open pits near the present Xanda mine produced commercial beryl almost continuously from 1960 to 1973 when a new demand for beryllium again encouraged pegmatite mining. In 1974, underground tunnels were driven to follow the pegmatite veins in what is now the Xanda mine. Rich discoveries resulted in the exploitation of other bodies nearby, as described below.

Limoeiro Mine. The Limoeiro pegmatite is a flattened, lens-shaped body, 2 to 4 m thick, intruded into a host rock consisting of dark gray, finely banded quartzitic biotite schist. It strikes N 30° E and dips gently NW. The 200-m-long outcrop is exposed on the northwest slope of a steep valley wall, and the body was first exploited via a series of roughly parallel adits along the outcrop that were eventually developed into numerous galleries and

branching tunnels. The structure of the Limoeiro is typical of that of a primary pegmatite (Shigley and Kampf, 1984). A thin, light-colored layer of muscovite mica formed the pegmatite contact with the surrounding schist. The miners then tunneled through a 4- to 10-cm-thick feldspathic border zone made up of the three main constituents of all pegmatites: feldspar, quartz, and muscovite mica. These crystals were fine grained when first encountered and became coarser as the miners progressed toward the core of the pegmatite. The core of the pegmatite consisted of milky quartz. Gem pockets occurred near the core and were (atypically for most pegmatites) very common, averaging about one per square meter. They varied widely in shape as well as in dimension, with some pockets measuring only a few centimeters and others a cavernous 2 m in diameter. The miners could tell when they were close to success because the walls near the gem-bearing pockets were composed of massive lepidolite and albite, embedded with black tourmaline. The pockets were lined with albite, quartz, microcline, and lepidolite crystals on which were perched long green tourmaline prisms and well-formed crystals of topaz, hydroxyl-herderite, and other species. One of the best gem-quality green tourmaline crystals ever found occurred in one of these pockets (figure 4). However, the need for explosives to penetrate the hard-rock pegmatite at this and the nearby Xanda mine undoubtedly destroyed many such crystals.

In 1975, 200 garimpeiros worked this mine, but by mid-1976 easily accessible pockets had been cleaned out and only 30 miners remained (Cassedanne and Lowell, 1982). The mine has since been abandoned, its adits closed by chaotic bulldozer stripping.

Xanda Mine. The Xanda pegmatite and its numerous mine workings are located 2.5 km south-southwest of the Limoeiro (figure 5). Intensive work on the 135-m outcrop of the pegmatite was first begun in 1974, and eventually hundreds of garimpeiros invaded and worked the pegmatite.

The lens-shaped body strikes NW and dips 20°–25° NE, with an average thickness of 7 m. It is imbedded in a tourmaline-rich quartz-biotite schist and displays sharp contacts with the host rock (figure 6). The mineralogy of the pegmatite is very similar to that of the Limoeiro body except that the fine-grained border zone contained three

additional minerals: tourmaline, garnet, and biotite mica. Beryl was found near the lens-shaped milky quartz core (Neves et al., 1980).

Since the mine was opened, cave-ins have occurred at many adits: the southeast part of the deposit is presently buried beneath a massive landslide. The newest and very limited workings are near the center of the body. In the northwest section, where the bulk of large gem crystals and crystals of other minerals were originally found, the adits are now inaccessible and back-filled with waste. Some tunnels in the Xanda extended 150 m within the body, often turning sharply with no apparent reason for such changes in direction. At the ends of these "s" turns, however, gem pockets containing the largest and best blue topaz crystals from this deposit were found. Apparently the miners had a sixth sense for locating the gems (Bancroft, 1984).

The Xanda mine, like the others in this group, is on private land and is not operated under a government concession. The land is rented to a tenant, who buys the mining equipment and in turn rents it to the garimpeiros who work the pegmatite, with the understanding that the tenant has first choice in buying whatever is mined, generally at his own price. Little bargaining is available to the garimpeiro. Possibly because of these arrangements, many specimens disappeared during the course of mining, even though the workings were closed whenever the miners were not busy (Lucio, 1980). The garimpeiro who sells his crystals secretly to avoid commission or other payments is called a *curiango*, a Brazilian bird that busies itself only during the night. Such curiingos were more prevalent in these mines than at most others in Brazil.

According to the mine owner, the Xanda pegmatite outcrop was so rich that fine green tourmalines were found almost immediately after pick-and-shovel work began. Even before systematic tunneling was started, local farmers had encountered a number of blue topaz crystals as well. Not recognizing them as having any value, however, they just threw them on the dumps—damaging or destroying what were later deter-

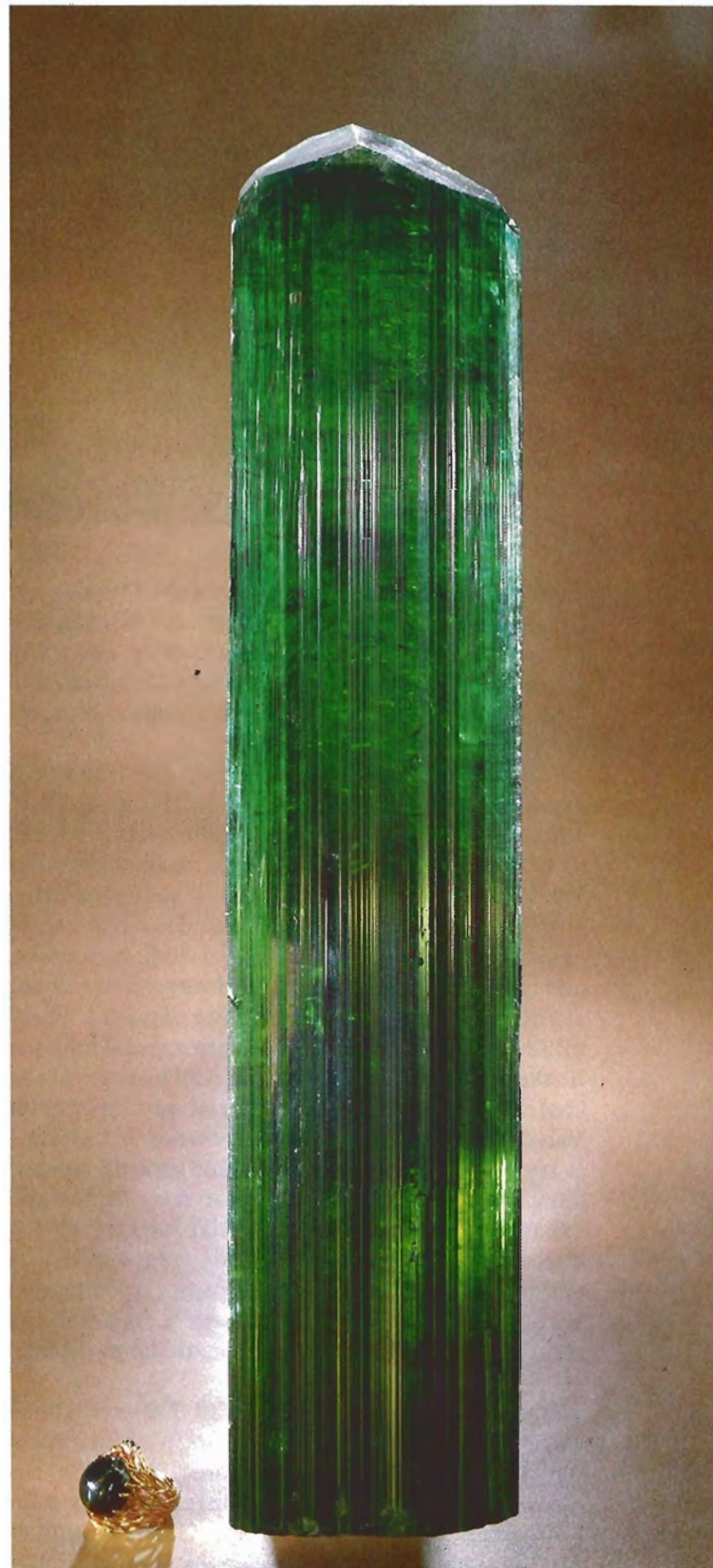

Figure 4. This gem-quality green tourmaline crystal is from the Limoeiro mine, in the Virgem da Lapa group. This specimen is 33 cm long \times 7 cm in diameter and weighs 2.4 kg. Photo \copyright Harold \oplus Erica Van Pelt.



Figure 5. One entrance and the waste dumps at the Xanda mine in the Virgem da Lapa group. Note the miners' huts at the top of the hill. Photo by Richard Gaines.

mined to have been superior crystals. On another occasion, a group of miners, after celebrating at a party, stuffed a stick of dynamite into the pegmatite—blowing into an adjacent pocket and destroying at least 10 superb topaz crystals (Bancroft, 1984).

Of the five mines in this group, the Xanda has been the steadiest in production. From 1979 to 1982, however, the mine was completely closed down. When the author visited it in September 1983, it had been reopened for a year, operating with a crew of only four men. The expense of equipment, maintenance, diesel fuel, dynamite, and the like is reflected in the slow pace of mining at this and many other pegmatite deposits. Three hundred tons of high-quality commercial feldspar lie on the dumps but cannot be sold because of the cost of transporting the material to Governador Valadares. At present, the mine owner, Mr. Ursine, is trying to acquire a government mining concession, which will make it easier to raise capital and expand operations. The potential for further discoveries is great throughout this area, but the far greater costs of hard-rock mining (as compared with alluvial or strip mining) make it doubtful that mining for gem material alone could be profitable.

Manoel Mutuca Mine. The 18,000-acre ranch owned by Manoel Mutuca lies south of the city of Barra de Salinas and immediately south of the Jequitinhonha River; the workings are only 8 air kilometers from the Xanda and Limoeiro mines. This mine is very near the famous 1940 workings

of the Barra de Salinas mine (across the river from the town of Barra de Salinas), which produced superb rubellite crystals. The Manoel Mutuca mine has produced incredibly fine, "sapphire"-blue gem-quality tourmaline, with some crystals up to 15 cm long × 12 cm wide and weighing as much as 1.2 kg. Most of these deeply etched crystals occurred in colluvial deposits, but at least one in-situ pegmatite also yielded specimens, as illustrated in figure 7 (E. Swoboda, pers. comm.). Because fine blue tourmaline is in greater demand and even shorter supply than red tourmaline, this discovery came as a welcome surprise to gem dealers.

Figure 6. Another of the main entrances of the Xanda mine. Notice the sharp contact zone between the red schist above and the lighter colored pegmatite below, with the pegmatite pinching out on the right. Photo by Jack Lowell.



Figure 7. This 10-cm-long intense blue tourmaline crystal on quartz was found at the Manoel Mutuca mine of the Virgem da Lapa group. Photo © Harold & Erica Van Pelt.

Interestingly, many of the Mutuca blue crystals themselves seem pale; however, when the rough is cut *across* the c-axis of the crystal, an intense, highly desirable, "sapphire"-blue hue appears; when most other blue tourmalines are cut perpendicular to the c-axis, the color produced is usually too harsh or dark. Besides, such cutting is impossible with most blue tourmaline crystals, often referred to as "pencils," because they are too narrow. But the Mutuca prisms are sometimes nearly as thick as they are long and so enable the lapidary to produce superb faceted gems of substantial size, 50+ ct (figure 8). This rough also demonstrates a unique reaction to heat treatment. With dark blue tourmalines from most mines, heat treatment produces a blue-green tint; the dark blue Manoel Mutuca stones, however, develop a "sapphire"-blue tint when brightened by heat treatment. Of all the deposits in Minas Gerais that produce blue tourmaline—e.g., Taquaral (the Piauí

Figure 8. Representative of some of the fine large gems that have been cut from Manoel Mutuca rough, this blue tourmaline weighs 52 ct. From the collection of Decarly Rosa Xavier. Photo courtesy Peter Bancroft (Bancroft, 1984), © Harold & Erica Van Pelt.

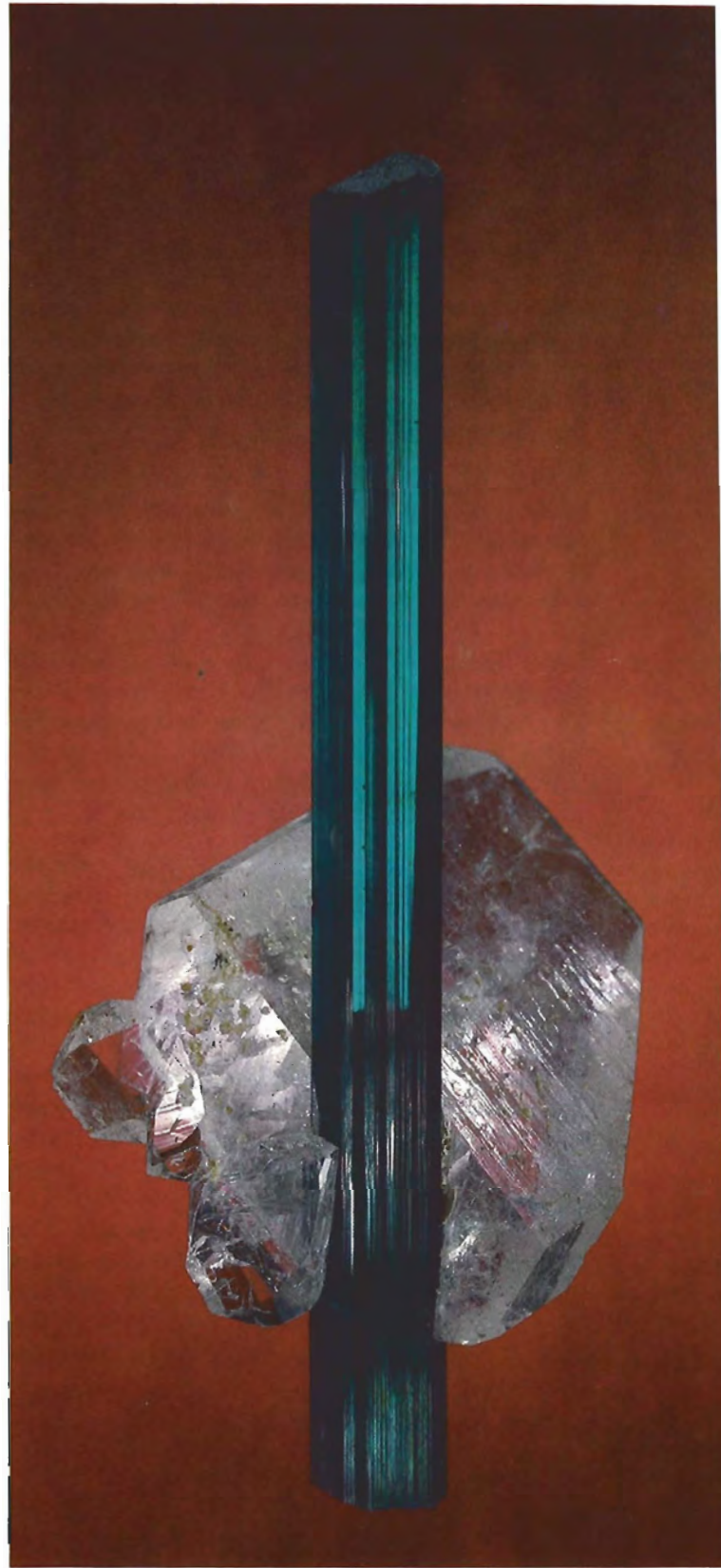
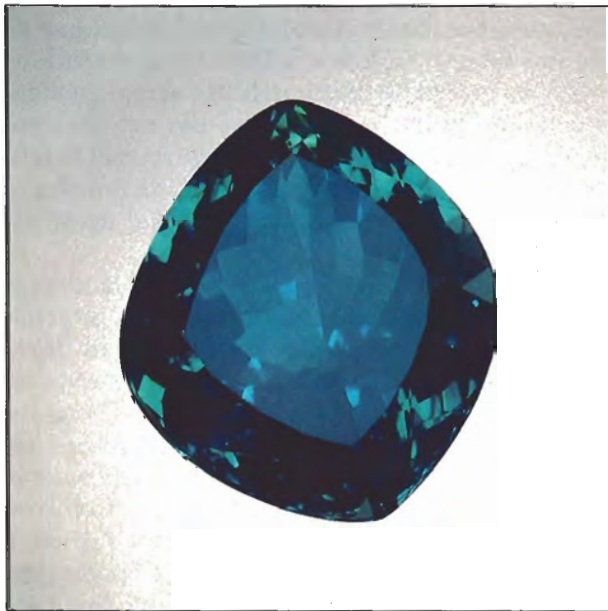

Valley deposits), Sapucaia, Golconda, Marcello, Chia, etc.—Manoel Mutuca has produced the best large gems for fine jewelry (see Bancroft, 1984, p. 210).

Geochemistry. This series of pegmatites is geochemically one of the richest in all of Brazil. Evidence was found of relatively large quantities of several elements: fluorine, phosphorus, calcium, sodium, potassium, iron, tin, niobium, tantalum, lead, antimony, arsenic, bismuth, and sulfur. Uranium and copper were also present, in addition to the expected aluminum and manganese as well as beryllium, boron, and lithium (Lucio, 1980; Cassedanne and Lowell, 1982).

Production. The Virgem da Lapa mines produced many tons of predominantly green and bicolored tourmaline for use as collectors' specimens and faceted gems. Most of the material was taken out over the course of four years, approximately 1974–1978 (Levon Nercessian, pers. comm., 1985). The Manoel Mutuca mine also produced a significant amount of the finest blue tourmaline. The Limoeiro, Toca da Onça, and Laranjeiras mines are currently closed. The Xanda and the Manoel Mutuca are the only mines that have been systematically worked over the last few years.

Salinas Mine. The main Salinas mine* and the Virgem da Lapa mines present a study in sharp contrasts. Both are primary (unmoved) deposits, but because of the chemical alteration of most of the Salinas body, the gem "pockets" bear little resemblance to those found in the hard rock of the Virgem da Lapa bodies.

The Salinas mine lies about 42 km northwest of Coronel Murta, the site of the famous Frade aquamarine mine (Proctor, 1984). The mine can be reached by first taking dirt road MG-342 north 24 km from Coronel Murta toward Rubelita. Then turn a sharp left (west) onto an unnumbered dirt road and travel 18 km straight across an almost completely flat plateau, stopping right after the road drops over the Salinas ridge toward the Jequitinhonha River. The last half-kilometer to the mine must be traveled by foot.

*Frequently called "Barra de Salinas," this mine should not be confused with the Barra de Salinas rubellite mine, which lies near the mouth of the Salinas River, approximately 5 km away.

The deposit was discovered about 100 years ago by a certain Mr. Pego, whose descendents still reside in the area. Ownership passed through a number of hands until 1945, when a group headed by Telesco de Mattos began the first serious exploitation of the deposit. Within five years, Telesco struck a gem "pocket" (called a *vieirinho*), that yielded a bonanza of more than 1,000 kg (2,240 lb.) of tourmaline crystals. Most of this production was purchased by local farmers, although Telesco's son Paulo received 120 kg of the best rough and spent five years cutting it into gems. In 1950, Telesco sold the mine to Antonio Pinheiro, who expanded exploration and made many improvements in the operation. He recognized that the enormous pegmatite body (actually made up of a number of pegmatite intrusions) was one of the largest in Brazil (only the Cruzeiro-Aricanga complex and the Jonas-Cascalho-Itatiaia complex, to be discussed in the next article in this series, rival it in size) and was rich in kaolin, mica, beryl, and quartz as well as 55,000 kg of commercial beryl. Much of the kaolin proved to be eminently suitable for coating paper and making ceramics.

The mine was purchased in August 1973 by its present owner, Halley Batista, who initiated the period of greatest productivity. Batista found that the pegmatite had been cut in two at an earlier time by a local river, with the other part on a nearby ridge, much closer to (and overlooking) the Jequitinhonha River. This second section, which became known as the Lavrinha (small washings) de Salinas mine, was owned by Klaus Treuherz of Germany, but is now closed. Curiously, this part of the pegmatite is far less weathered than the Salinas mine (Baker, 1975). Although the actual production of the Lavrinha de Salinas has not been reported, as is typical of gemstone statistics in Brazil, we do know that this mine has yielded a number of fine multicolored tourmaline crystals, many on matrix.

Most of the original Salinas body is almost completely altered: that is, the feldspars have decomposed to white kaolin, leaving as hard parts quartz, loose gem crystals, and some surviving mica and shattered black tourmaline. There are few "pockets" in the usual sense of that term. Yet, unlike the secondary aquamarine deposits at Marambaia Valley, which have moved from the original pegmatite, the gem materials at Salinas, a primary pegmatite, remain in situ. The pegmatite itself appears to be tabular in form and dips very



Figure 9. More than 30 years of bulldozing through the pegmatite at the Salinas mine has produced a "canyon" that is 30 m deep in some areas. Here a garimpeiro works a "pocket" where gem material was spotted when the bulldozer made its most recent pass. The box on the side of his diggings was provided by the mine owner to safeguard any crystals found. On the right wall, the sharp contact between the kaolin of the pegmatite and the red lateritic soil that covers it is evident.

steeply with a north-south strike. The main body is approximately 600–1,000 m long and, according to the mine owner, may be as deep as 100 m; it reaches a width of well over 30 m in some places. Despite weathering, the predominantly quartz core is evident.

Because of the kaolinized nature of this elongated outcrop, the mine operators began bulldozing the top of the body along its length in the early 1950s, closely examining the turned-over material and using hand tools whenever concentrations of crystals from collapsed pockets were encountered. Such strip mining has been carried on now for over 30 years, with the result that a "canyon," as much as 30 m deep in places, has been excavated within the pegmatite (figure 9). Waste dumps form roadways at both ends.

Within the "canyon," the quartz core blocks easy mining in the center, but bulldozing is not seriously impeded. Starting at either end, the bull-

dozer scrapes a thin (5–10 cm) layer of kaolin on each pass. Miners following the bulldozer look for pink lepidolite and smoky quartz as indicators of nearby gem pockets. When detached pocket contents are found, the workers move in to dig out the valuable crystals by hand (again, see figure 9). To prevent any daylight forays by curiangos, the mine owner provides a portable safety deposit box with an ingenious grooved cylinder on the top. Crystals placed in the groove drop securely into the box when the cylinder is rotated.

Bulldozing has exposed the pegmatite wall rock (composed of black tourmaline, quartz, and mica in a kaolin matrix). The contacts between the pegmatite and the enclosing schist (figure 10), and the cap of red lateritic soil (figure 9) are very sharp. Waste material at the south end of the cut is bulldozed over the side of a hill, but at the north end it is moved via a primitive but effective tramway. In a few places, high-pressure water cannons are

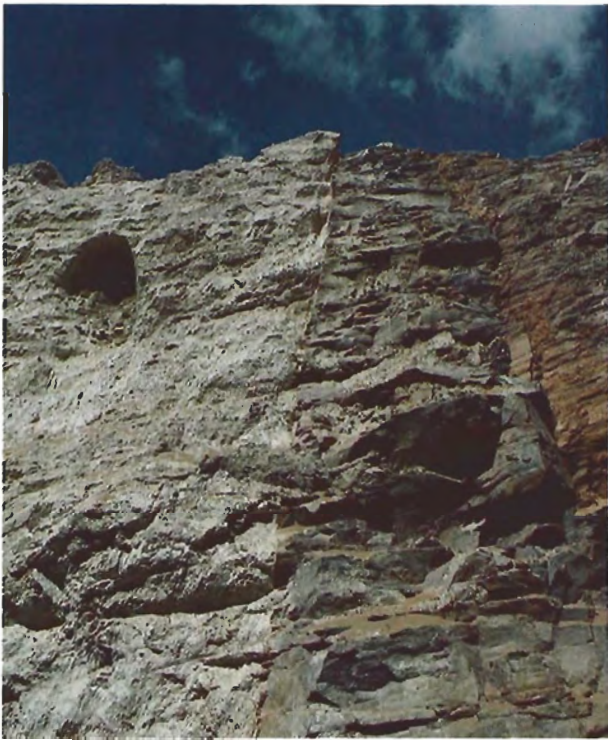

Figure 10. This wall at Salinas "canyon" shows the sharp contact between the kaolin of the pegmatite on the left and the schist on the right. Note the gem "pocket" that has been cleaned out of the kaolin at the upper left.

directed at the soft, kaolinized walls of the pegmatite to release desirable minerals.

The gem material found in the Salinas mine consists primarily of multicolored tourmaline crystals. In fact, the Salinas and smaller mines in the vicinity represent one of the most important sources of multicolored tourmaline in the world (figure 1). Some "pockets" contain only one color of tourmaline, while others may produce tourmalines of many different colors as well as cat's-eyes, fine morganite (in fact, this mine has been a consistent producer over the years), and even medium-quality aquamarine—all in the same pocket. One of the best pockets ever found contained 20 kg of tourmaline, among which were rubellite crystals as well as green, blue, purplish brown, and colorless stones, and a superb bicolored crystal. In 1977 another pocket yielded 25 kg of fine pink tourmaline crystals, all 2.5 to 5 cm long. In August 1980, still another major find produced 6 kg of superb emerald-green tourmaline crystals from 5 to 15 cm long.

According to Batista, the Salinas mine currently produces (from 15 tons of pegmatite) approximately 10–15 kg of crystals in a good week, but only a small fraction of this total (500 g) will cut better-quality gemstones. The operation consists of 25 garimpeiros supported by heavy machinery. Mr. Batista is optimistic that this mine area, which at 2,471 acres is one of the largest in Brazil, will continue to produce medium quantities of fine tourmaline and morganite beryl for several decades to come. The author, however, is more doubtful of the "several decades" potential of the mine, since the mine owner is assuming a uniform pocket distribution throughout the depth of the altered mass, which is seldom—if ever—the case with pegmatites.

Ouro Fino Rubellite Mine. In the last few years, much of the best red tourmaline, or rubellite, produced in Brazil has come out from one small mine, the Ouro Fino (fine gold), which is only 21 km from the city of Coronel Murta and the Frade aquamarine mine. These "cherry"- to "ruby"-red gems rival the best from Namibia (at Otjimbingue) in hue and clarity (figures 11 and 12). In fact, the reputation of the Ouro Fino material is so good that it has essentially become a trade name for fine red tourmaline from any source.

To get to Ouro Fino, take dirt road MG-342 north from Coronel Murta for about 4 km before detouring over another (unnumbered) dirt road to the right some 15 km to the hamlet of Ouro Fino. The mine is an easy 2 km across meadows and low, rolling, residual hills.

The first gem rubellites were found by garimpeiro Manoel Cardoso in November 1979, on a farm owned by two descendants of the founder of Coronel Murta, Francisco Murta and his son Antonio Wilson Murta. For a year and a half after the first few pieces of rough were discovered in red lateritic soil at the base of a small hill, both the operation and production remained small. In late spring of 1981, however, a tremendous number of superb red tourmalines were found deeper in the hill. Within a matter of weeks, over 1,000 garimpeiros had moved into the area. In what must be one of the most amazing excavation projects in the history of Brazil, they literally devoured the 50-m-high hill, hauling it off, in sacks, buckets, and wheelbarrows, to a washing pond they had built only 400 m away (A. Wilson Murta, pers. comm.). The quality of the material found, though,



Figure 11. This 12.35-ct rubellite represents the finest color produced at the Ouro Fino mine. The necklace was designed by Kim Lilot of St. Eligius European Goldsmiths and Gemologists, San Francisco. Photo © Harold & Erica Van Pelt.

Figure 12. These rubellites (total weight 39.64 ct) illustrate some of the deeper "cherry" colors recovered from the Ouro Fino deposit. Photo © Harold & Erica Van Pelt.



seemed to justify this activity. In 1981, one 5-kg lot of rubellite crystals sold for several hundred thousand dollars (80,000,000 cruzeiros).

Most of the finest red material was found in an eluvial deposit deep inside the original hill. No lepidolite or albite was found associated with the rough, only some residual gravels and red soil. When the miners went deeper and eventually reached the primary pegmatite, what little tourmaline rough they found was highly fractured, as was most of the quartz and black tourmaline associated with it; also as would be expected for a decomposed pegmatite, much of the feldspar had been altered to soft kaolin. The various stages of pegmatite decomposition were evident throughout the mine: hard unaltered feldspar, feldspar altered to kaolin, and the eluvial red soil. Aside from the rubellite and some fine rose-colored tourmaline, only some small pieces of blue, green, and multicolored tourmaline and poor-quality aquamarine were found.

This mine represents a degree of decomposition and dispersal that is far greater than that encountered at the Salinas mine. The Ouro Fino hill, like many of the low "residual" hills common to this region of Minas Gerais, had survived erosion only because the hard-rock pegmatite intrusion had acted as a solid foundation. With the gradual



Figure 13. Picks and shovels are used by the garimpeiros, in this case an entire family, to mine the eluvial deposit at Ouro Fino. The material extracted by the father and son is placed in a sieve; the sieves are shaken by the three women above to concentrate the hard nodules of red clay from the remainder of the eluvial soil. Many of these "nodules" contain fractured pieces of fine Ouro Fino rubellite which can be freed by a washing operation.

erosion of the pegmatite, in response to the chemical weathering that is so characteristic of a tropical region, the foundation had started to "rot," causing the hill to erode and gradually sink, spilling its durable gem contents into the surrounding red soil.

The soft eluvial deposit is mined primarily by pick and shovel. Sieves are used to separate the pieces of gem material encased in "nodules" of red clay from the loose soil both at the mine itself (figure 13) and at the man-made washing ponds close to the excavation site (figures 14 and 15). The garimpeiros (who receive 80% to the owner's 20% for all stones sold) will then sell the sorted gem material either on the spot or in a nearby city.

For the most part, the rough rubellite found at Ouro Fino is small and highly fractured. Antonio Wilson Murta (pers. comm.) claimed that only about 10 euhedral crystals of rubellite, 7 cm wide × 10 to 15 cm long, were ever recovered intact from this deposit. Because of the size of the pieces of rough and the extent of fracturing, large faceted stones are almost impossible to obtain. Few clean dark red stones over 8 ct have ever been cut. The best intact crystal with which the author is familiar is a highly fractured 15-cm rubellite in the collection of Kalil Elawar of Teófilo Otoni.

The land owners report that since 1981 more than 1,000 kg (one ton) of low-quality tourmaline has been found, and approximately 50 kg of fine faceting-quality material has been sold (plus, of course, whatever was scavenged by the curiangos—one reason why production statistics in Minas Gerais are usually so vague). Of the divulged sales, the owners estimate that only about 10 kg was prime, almost flawless, "cherry"- or "ruby"-red tourmaline.

The original hill was literally leveled by the army of garimpeiros who invaded it, and now appears as a low depression—several acres in size—on the horizon. Currently, only 20 garimpeiros work what remains of the unturned red soil in the hope that part of the primary pegmatite might continue below the present level. The author feels that the prospects for the discovery of new, major deposits of red tourmaline at Ouro Fino are not good, but some small production may continue.

OTHER TOURMALINE DEPOSITS IN THE ARAÇUAÍ AREA

The mines described above are only a few, but in many ways the most notable, of the many hundreds that have been worked in this region. In 1940, José Biri of Rubelita discovered several large crystals—one weighing 8 kg—of fine, relatively unfractured rubellite in a primary pegmatite (later named the Lavrinha mine) near the Corrego de Papera stream 1 km northwest of Rubelita. The



Figure 14. Washing ponds were created downhill from the main excavation site at Ouro Fino to separate the small pieces of tourmaline from the hardened soil in which they had been encased.

superb 100+-ct blood-red tourmaline in the Eduardo Guinle collection is from this mine (E. Swoboda and O. Neto, pers. comm.).

The reputation of the region surrounding the town of Barra de Salinas was also first gained in the 1940s, when superb rubellite crystals were found in a primary pegmatite only 150 m west of the Salinas River. According to Ed Swoboda, who visited the mine in the mid-1940s, this pegmatite appeared to be cut by the Salinas River; another part was found within the limits of the town, which stood on the opposite bank. Some of the

tourmaline crystals produced at Barra de Salinas were as long as 13 cm and were multicolored, but most were among the reddest of rubellite (many attached to quartz crystals).

Another source of fine-quality multicolored tourmaline is a series of three mines near Coronel Murta. Two of these primary pegmatite mines, the Baixa Grande and the Morro Redondo, are now closed; the third, the Lorena (on a hillside within sight of the Ouro Fino), is currently operating with only a skeleton crew. While active, these three mines produced remarkably clean and sharp

Figure 15. Once the clay and soil have been removed, the garimpeiro carefully sorts through the remaining rock in his search for gem material.





Figure 16. This 13-cm four-color tourmaline crystal on quartz has been traced to the area of the Lorena and Morro Redondo mines, near Coronel Murta. Note the pyramidal (pointed) termination on the main crystal and the basal pinacoid (flat) termination on the lower crystal, an extremely unusual combination in the same specimen. It is representative of some of the best material found in this gem locality. Photo ©Harold Erica Van Pelt.

three-, four-, and even five-color gem crystals as much as 5 cm thick and 12 to 15 cm long (figure 16).

SUMMARY AND CONCLUSION

The Araçuaí districts of northeast Minas Gerais have provided much of the world's supply of tourmaline over the last 20 years. Whereas the Araçuaí-Itinga area has produced predominantly green and blue material, the Araçuaí-Salinas area has also produced significant quantities of red and multicolored stones. In particular, the deposits at Virgem da Lapa have yielded hundreds of kilos of large green tourmalines and blue tourmalines, the Salinas mine produces tourmaline in a galaxy of colors, and the choice rubellite from Ouro Fino has

become the touchstone for "cherry"- or "ruby"-red tourmaline throughout Brazil.

Interestingly, the Virgem da Lapa, Salinas, and Ouro Fino mines also represent three distinct degrees of pegmatite decomposition, erosion, and dispersal. The Virgem da Lapa deposits are predominantly hard-rock primary pegmatites, with the pristine crystals appearing in situ within unaltered gem pockets. The Salinas stones also occur in primary pegmatites, but in altered "pockets" within the almost completely decomposed host rock. Most of the Ouro Fino material has been found mixed with red lateritic soil in an eluvial deposit some distance away from the highly eroded primary pegmatite. As is true with most pegmatite minerals, the sharper, cleaner crystals

have been found in unaltered pockets, while the material in a secondary deposit is more likely to be broken into small pieces and fractured.

Like the aquamarine discussed in the first article of this series, blue and green tourmaline is commonly heat treated. Whereas aquamarine is heated to drive off the yellow hue, tourmaline is heated only to lighten or brighten the color. Rubellite is not usually heated because included material tends to be destroyed by the higher temperatures required for this heating process.

Currently, there is a fairly steady supply of green, blue-green, and rose tourmaline from this area; however, the "Manoel Mutuca" blue and the "Ouro Fino" red gems are very scarce. As was noted with the beryls, because of the shortage of garimpeiro labor, relatively little systematic mining in secondary deposits is going on at the present time. In the future there will be an ever greater dependence on the production from primary deposits. However, the expense of purchasing and maintaining the equipment needed to attack the primary pegmatites will be a key factor in the amount of gems produced and their ultimate cost.

The next article in this series will examine tourmaline mines in the southern pegmatite region of Minas Gerais, around the city of Governador Valadares. This area has a long history of tourmaline production and has hosted some spectacular finds in recent years.

Author's Note: Since the first article in this series, on aquamarine and other beryls from Minas Gerais, was published, another major deposit of aquamarine was found in this area. Specifically, in mid-1984 the Lavra da Invreja was opened within view of the old Pinheiro mine (where the Quarto Centenario aquamarine was found), approximately 6 km west of Ponto de Marambaia. Over the course of three weeks, 400 garimpeiros dug 30 tunnels (a total of 200 m) in this eluvial deposit. Only two of the tunnels reached gem material: two 10-m² deposits found only 20–30 m apart. Approximately 350 kg of medium-quality aquamarine was found before the mine was abandoned (Rex Nash and Pierre Laville, pers. comm., 1984).

REFERENCES

- Afgouni K., Sa J.H. (1977) Minerio de litio do Brasil. *Mineração et Metalurgia*, Vol. 41, pp. 60–66.
- Baker E. (1975) A gem and mineral tour. *Lapidary Journal*, Vol. 29, No. 2, pp. 496–507.
- Ball S.H. (1930) Historical notes on gem mining. *Economic Geology*, Vol. 26, pp. 681–738.
- Bancroft P. (1984) *Gem and Crystal Treasures*. Western Enterprises/Mineralogical Record, Fallbrook, CA.
- Bastos F.M. (1972) Brazil: land of tourmalines. *Lapidary Journal*, Vol. 26, No. 8, pp. 1224–1229.
- Cassedanne J.P., Cassedanne J.O. (1978) La petalite de Itinga (Minas Gerais). *Revue de Gemmologie a.f.g.*, No. 55, pp. 14–16.
- Cassedanne J.P., Cassedanne J.O. (1980) Itinéraires minéralogiques au Brésil, d'Itaobim à Araçuaí (dans l'État de Minas Gerais). *Monde et Minéraux*, No. 38, pp. 4–10.
- Cassedanne J.P., Lowell J. (1982) Famous mineral localities: the Virgem da Lapa pegmatites. *Mineralogical Record*, Vol. 13, No. 1, pp. 19–28.
- Dunn P.J., Wolfe C.W., Leavens P.B., Wilson W.B. (1979) Hydroxyl-herderite from Brazil and a guide to species nomenclature for the herderite/hydroxyl-herderite series. *Mineralogical Record*, Vol. 10, No. 1, pp. 5–11.
- José H.S., Svizero D.P. (1976) Polucita em pegmatite do Município de Araçuaí, M.G., *Anais XXIX Congresso Brasileiro de Geologia, Resumos dos trabalhos*, p. 378.
- Linder P.H. (1966) Large bucket dredging operations for diamonds started in Brazilian rivers. *Lapidary Journal*, Vol. 20, No. 4, pp. 566–571.
- Linder P.H. (1967) Petalite and turquoise discovered in Brazil. *Lapidary Journal*, Vol. 21, No. 1, pp. 196–201.
- Linder P.H., Rolff A. (1968) Hunting Brazil's gems and wealth of minerals. *Lapidary Journal*, Vol. 22, No. 6, pp. 790–800.
- Lucio A. (1980) Review of history and survey of present and future mining in Brazil. Report at the 7th Annual Rochester Mineralogical Symp., Rochester, New York (unpublished).
- Moore P.B. (1973) Pegmatite phosphates: descriptive mineralogy and crystal chemistry. *Mineralogical Record*, Vol. 4, No. 3, pp. 103–130.
- Nassau K. (1984) *Gemstone Enhancement*. Butterworths, London, England.
- Nassau K., Wood D.L. (1973) The nature of the new Maxixe-type beryl. *Lapidary Journal*, Vol. 27, No. 7, pp. 1032–1034, 1036, 1038, 1052–1058.
- Nassau K., Prescott B.E., Wood D.L. (1976) The deep blue Maxixe-type color center in beryl. *American Mineralogist*, Vol. 61, Nos. 1 and 2, pp. 100–107.
- Neves C.J.M., Soares A.C.P., Valle R.R. (1980) Geoquímica e genese do pegmatito Limoeiro (Virgem da Lapa, Minas Gerais). *Anais XXXI Congresso Brasileiro de Geologia, 4 Baln. Camboriu SC*, pp. 2134–2148.
- Proctor K. (1984) Gem pegmatites of Minas Gerais, Brazil: exploration, occurrence and aquamarine deposits. *Gems & Gemology*, Vol. 20, No. 2, pp. 78–100.
- Rolff A. (1969) A new spodumene find in northeast Brazil. *Lapidary Journal*, Vol. 24, No. 11, pp. 1450–1455.
- Rolff A. (1971) Pink minerals from Brazil. *Lapidary Journal*, Vol. 24, No. 10, pp. 1300–1302, 1304–1307.
- Sa J.H. (1977) Pegmatitos litíferos da região de Itinga-Araçuaí, Minas Gerais. *Tese Dout. Inst. Geoc. USP*, São Paulo (unpublished).
- Shigley J.E., Kampf A.R. (1984) Gem-bearing pegmatites: a review. *Gems & Gemology*, Vol. 20, No. 2, pp. 64–77.
- Wood D.L., Nassau K. (1968) The characterization of beryl and emerald by visible and infra-red absorption spectroscopy. *American Mineralogist*, Vol. 53, Nos. 5 and 6, pp. 777–800.
- Zara L. (1973) The tourmaline. *Mineral Digest*, Vol. 5, Winter, pp. 33–46.

SAPPHIRE FROM THE MERCADERES–RÍO MAYO AREA, CAUCA, COLOMBIA

By Peter C. Keller, John I. Koivula, and Gonzalo Jara

Commercially important quantities of gem-quality sapphire are being recovered from stream beds and terrace gravels near the Colombian village of Mercaderes, about 143 km southwest of Popayán. The area is currently subject to a high degree of political unrest; nevertheless, about 100 people are said to be sporadically mining the deposit. Sapphire crystals average about one centimeter in length and occur in a variety of colors. Color-change stones are also common. Three inclusions were found to be characteristic: apatite, rutile, and boehmite. The parent rock for the sapphires has not been established, but it is probably one or more of the alkalic basalt members of the Cretaceous-age Diabase Group which outcrops in the area.

ABOUT THE AUTHORS

Dr. Keller is a research associate with the Mineralogy Section and project manager of the new "Gemstones and Their Origins" gallery at the Los Angeles County Museum of Natural History, Los Angeles, California; Mr. Koivula is senior gemologist in the Applied Gemology Department at the Gemological Institute of America, Santa Monica, California; and Mr. Jara is purchasing advisor and consultant for Kawai (a major emerald firm) in Bogotá, Colombia.

Acknowledgments: Our thanks to the people who made this study possible: Bill Kerr faceted the first sapphire used in the research; Harold and Erica Van Pelt provided the rough and cut photograph; the Garzon family of Popayán, Colombia, supplied study material and first-hand knowledge; and George Rossman provided chemical data. John I. Koivula took the photos in figures 4–8.

©1985 Gemological Institute of America

Over the last several years, small amounts of gem-quality sapphire, said to originate in Colombia, have occasionally surfaced in the gem trade. Until now, however, little information has been available on their exact source or mode of occurrence and there have not been enough stones available to undertake a meaningful study of the material. Codazzi (1927) noted pale gem-quality sapphire and ruby from the sands of the Río Mayo, which forms part of the border between the departments of Nariño and Cauca. The Río Mayo is the southern limit of the area presently being exploited. The first mention of these sapphires in the gemological literature was a report on a color-change specimen by Bank et al. (1978). Schmetzer et al. (1980) also include a Colombian color-change sapphire in a table of data on color-change sapphires from various localities worldwide.

During a recent visit to the colonial town of Popayán, capital of the Department of Cauca, two of the authors visited a small cutting shop where they examined several hundred carats of rough sapphire and 43 faceted stones averaging about 2 ct each. From this parcel a sample of 16 rough sapphires and two faceted stones were obtained for study. One of the rough crystals was exceptionally sharp; the two faceted stones weighed a total of 4.03 ct (figure 1).

It was hoped that this article would be a comprehensive report on the occurrence as well as the properties of the Colombian sapphires. Since our visit to Popayán in September 1984, however, a great deal of political unrest has erupted in the area, precluding a planned visit to the mine site itself and, consequently, a detailed report on the geology, occurrence, and mining of these Colombian sapphires. Until the authors can gain access to the locality, the purpose of this article is to provide preliminary data regarding the location of, and access to, the sapphire deposit, to discuss the occurrence of the sapphire based on what is known of the local geology, and, finally, to describe in



Figure 1. This rough sapphire crystal and the two faceted sapphires are all from the Mercaderes–Río Mayo area of Cauca, Colombia. The total weight of the two faceted stones is 4.03 ct. Photo © Harold and Erica Van Pelt.

detail the gemological characteristics of these Colombian sapphires.

LOCATION AND OCCURRENCE

The deposit is located on the border of the departments of Cauca and Nariño, near the village of Mercaderes, approximately 143 km southwest of Popayán (figure 2). From Popayán, access to the town of Mercaderes is gained by taking the Popayán to Pasto highway south through the Río Patia valley for approximately 129 km. Near this point, a small road forks SSE some 14 km to Mercaderes. Sapphires are currently being recovered from stream beds and terraces of small tributaries to the Río Patia, a major river whose headwaters are about 25 km west-southwest of Popayán. Most mining activity is in an approximately 50-km² area to the south and west of Mercaderes. Mining has been taking place for about six years, with never more than about 100 people working the deposit at one time. Current production is said to be about 10,000 ct of sapphire per year (S. Garzon, pers. comm., 1984). Most of the faceting is done in Popayán and Bogotá.

The original (in situ) source of the Colombian sapphires has yet to be determined, but the geology around Mercaderes suggests that these may be similar to occurrences in basalt recorded from other countries. Many major sapphire deposits around the world originated in alkalic basalts, including the deposits in Cambodia (Jobbins et al., 1981), Thailand (Keller, 1982), and Australia (Thompson, 1982). In most of these deposits, accessory minerals include black spinel, ilmenite, zircon, olivine, pyrope garnet, and augite. All of these, with the exception of zircon, have been

identified by the authors in gem concentrate from the Mercaderes workings. It is, therefore, reasonable to assume that the ultimate source for the Colombian sapphires is an alkalic basalt. According to Marin and Paris (1979), who extensively mapped and studied the geology of the Department of Cauca, the only alkalic basalts in the region belong to the Diabase Group of Cretaceous age. Their geologic map shows some outcrops of this unit in the Río Patia area. Until further field work can be undertaken, it can only be speculated that the original source for the Colombian sapphires is a basalt of this group.

DESCRIPTION

Visual Appearance. The crystals examined for this study are simple hexagonal prisms, typically tabular to elongate, exhibiting well-developed parting parallel to {0001}. Pyramidal and bipyramidal forms are rare. The crystals are commonly rounded as a result of extensive stream wear. A few very sharp crystals were observed, however; apparently these were collected close to their source. The crystals range in size from under 1 mm to over 3 cm, with 1-cm pieces being most common. The largest faceted sapphire reported to date is an almost flawless 16-ct light blue stone. The color range of the Colombian sapphires is reminiscent of material from the Umba Valley in Tanzania. Blue stones and green stones with a brownish cast are most common, but yellows, pinks, and even reds were observed in lesser quantities. Very typically, the sapphires are color-zoned with a brownish yellow core that is the result of their unusually high iron content, which will be discussed later in this article. Some asteriated material has been ob-

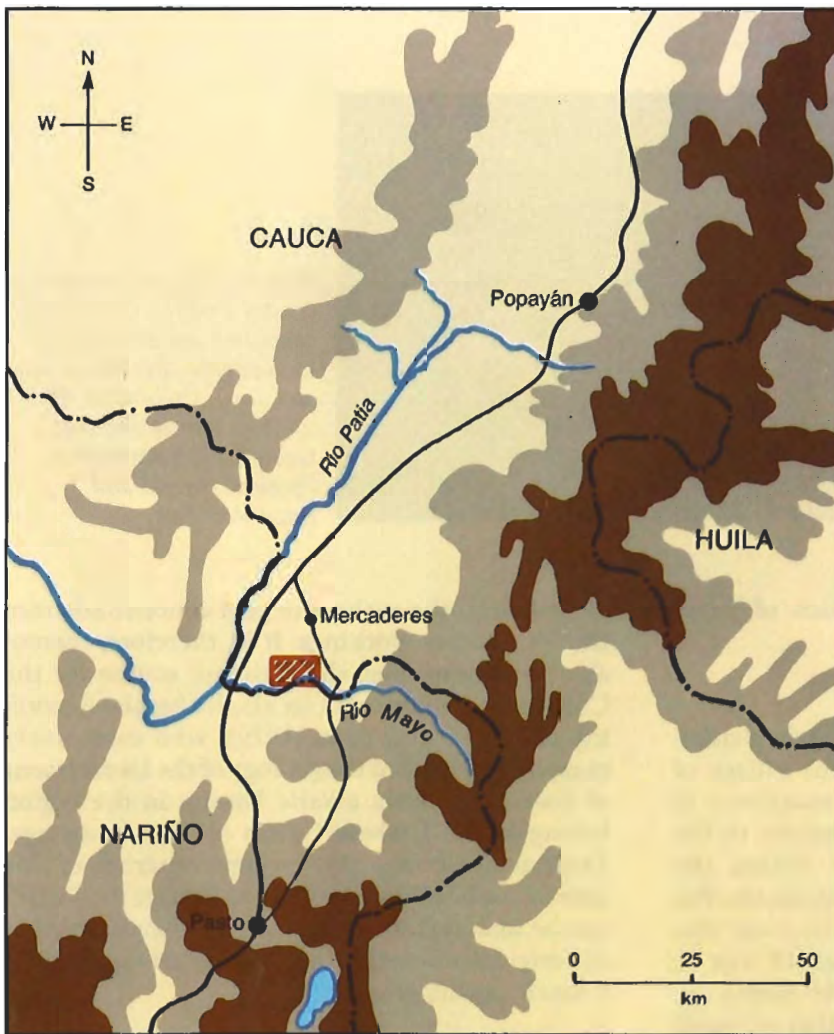

Figure 2. Location map for the Mercaderes–Río Mayo sapphire deposit in Cauca, Colombia. Sapphires have been found throughout the general area shaded in red, on both sides of the Río Mayo. Artwork by Lisa Joko.

served. Although the blue stones are usually somewhat paler than their counterparts from Thailand, Cambodia, and Australia, some very attractive stones have been faceted from this pastel material (figure 3).

The most interesting feature of the Colombian sapphires is the relative abundance of color-change stones, from bluish purple in daylight to violetish red in incandescent light. One such stone was described by Bank et al. (1978). Preliminary chemical (XRF) analysis by George Rossman of the California Institute of Technology on three of the stones (two color-change faceted stones and one blue crystal, the same shown in figure 1) revealed Cr_2O_3 contents of 0.02 to 0.05 (table 1), with stones containing the greater amount having the greater color change. This supports the contention of Schmetzer et al. (1980) that the intensity of the color change depends on the concentration of the chromium present. Table 1 also shows that the

Figure 3. A 1.48-ct blue sapphire from the Mercaderes–Río Mayo deposit. Photo © 1985 Tino Hammid.





Figure 4. A sample of the 16 rough sapphire crystals examined in this study. Note the rounding, which suggests extensive alluvial wear, in most of the stones.

sapphires are very poor in titanium content and exceedingly rich in iron. No vanadium was found. Heat treatment experiments were also undertaken by George Rossman on a number of pale blue stones. As would be expected from a titanium-poor sapphire, the heat treatment resulted in the oxidation of the iron to produce a golden color (Keller, 1982) rather than a deeper blue.

All of the 16 sapphire crystals, some of which are shown in figure 4, were tested using standard gemological techniques. The results are described below.

Refractive Index. Three of the crystals were tested for refractive index using a sodium vapor monochromatic light source and a GIA GEM Instruments Duplex II refractometer. All three subjects gave refractive indices of 1.762–1.770 with a birefringence of 0.008 and a uniaxial negative optic character.

Specific Gravity. A Voland double-pan balance, modified for hydrostatic specific-gravity determinations, was used to determine a range of 3.99 to

4.02 in the 16 crystals. The crystal with the greatest number of rutile inclusions gave the highest value.

Ultraviolet Fluorescence. All of the crystals were inert to short-wave ultraviolet radiation, but they varied in their reactions to the long-wave lamp. Seven of the crystals (all of which showed a color change) exhibited orange to red, weak to moderate, long-wave fluorescence; four (grayish to brownish green) stones were almost inert; five distinctly color-zoned crystals showed small, irregular orange fluorescent patches.

Spectroscopic Examination. Using a GIA GEM Instruments spectroscope unit, we determined that all of the specimens except one showed a medium to strong absorption line at 457 nm. The one exception was a muddy green crystal, with blue, gray, and brown overtones, of moderate color intensity that showed an absorption band from 455 to 468 nm. Several of the crystals also showed weak absorption lines at 475 and 481 nm. Those crystals with a distinct bluish to purplish red-orange color that displayed a color change from fluorescent (day) light to incandescent light also had an absorption band of moderate strength situated from 540 to 590 nm and absorption lines in the deep red at 680 and 690 nm, attributable to chromium as per the chemical analyses (table 1). These spectra overlap with those observed in sapphires from other localities, and so are not distinctive of Colombia.

Microscopic Observation. The 16 sapphires were examined carefully under magnification using a

TABLE 1. Minor-element analytical data (in wt.%) for three Colombian sapphires.^a

Element	Color change no. 1	Color change no. 2	Blue crystal
TiO ₂	0.04	0.003	—
Cr ₂ O ₃	0.05	0.02	—
Fe ₂ O ₃	0.77	0.22	0.36

^aThe XRF analyses reported here represent bulk analyses of the entire sample; the error factor is ±20% of the figure reported.

Figure 5. Hexagonal color and growth zoning is observed parallel to the *c*-axis of this crystal. The orange color is the result of heat-treatment experiments. The small, rounded, crystals are believed to be apatite. Shadowing, magnified 40 \times .

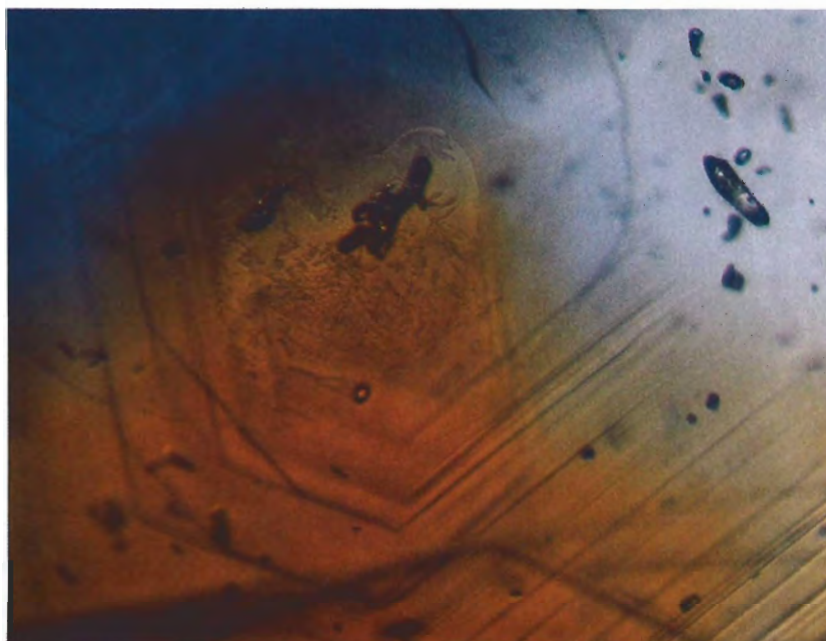

gemological stereo microscope. Several notable internal features were observed.

Color Zoning. All 16 sapphires showed some color zoning that ranged in intensity from very weak to strong. Commonly, the color zones were oriented perpendicular to the *c*-axis, parallel to the pinacoid. However, the most prominent color zoning was displayed by two pale bluish purple crystals with bright orange cores of hexagonal to trigonal cross sections that ran parallel to *c*. One of these color-zoned crystals is shown in figure 5.

Growth Zoning. One of the two crystals that had a strong orange-colored core showed prominent hexagonal growth zoning as well. This growth zoning is also evident in the stone shown in figure 5.

Twinning. Some traces of lamellar twinning were present in six of the crystals. The most prominent evidence of twinning was the presence of fine needles of boehmite (figure 6) interspersed along the twin planes.

Mineral Inclusions. In addition to the boehmite inclusions, two of the Colombian sapphires were found to contain transparent, deep brownish red to opaque gray, elongated prisms with a submetallic luster that suggest rutile (figures 7 and 8). Undercutting during polishing showed that the inclusions are softer than the host sapphire; microscopic hardness testing placed these inclu-

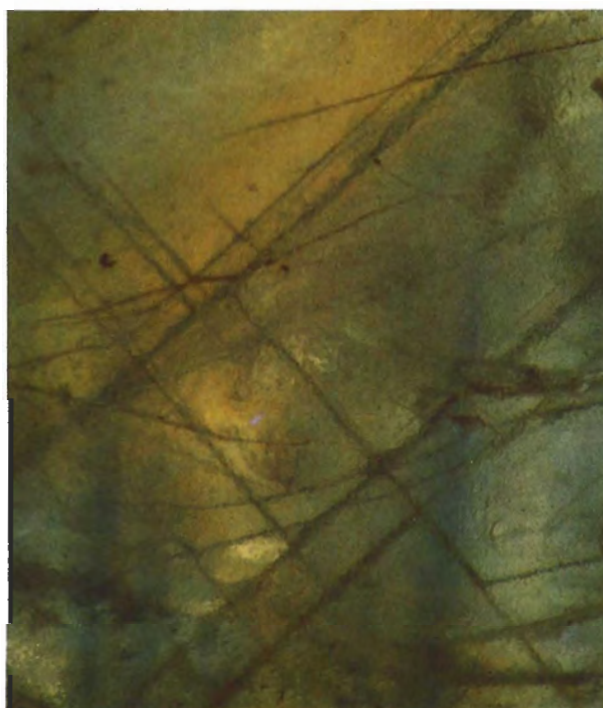

Figure 6. These fine needles of boehmite delineate twin planes in a Colombian sapphire. Transmitted and oblique illumination, magnified 25 \times .

sions between 6 and 6.5 on the Mohs scale. Several of the inclusions reaching the surface were scraped with the fine edge of a tiny diamond cleavage fragment epoxied into the end of an aluminum rod. The resulting powder was removed carefully and

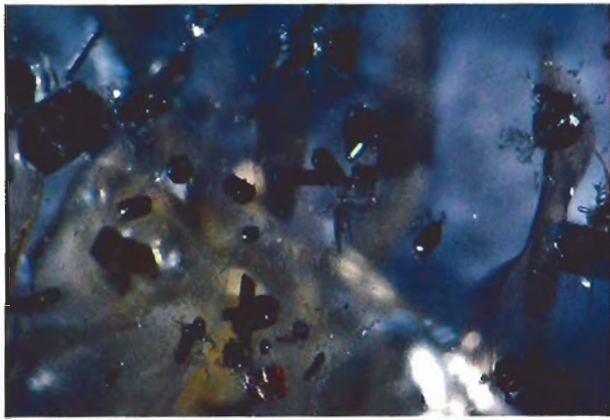

Figure 7. A typical scene of the interior of a Colombian sapphire, showing random orientation of numerous submetallic, elongated rutile prisms. Transmitted and oblique illumination, magnified 20x.

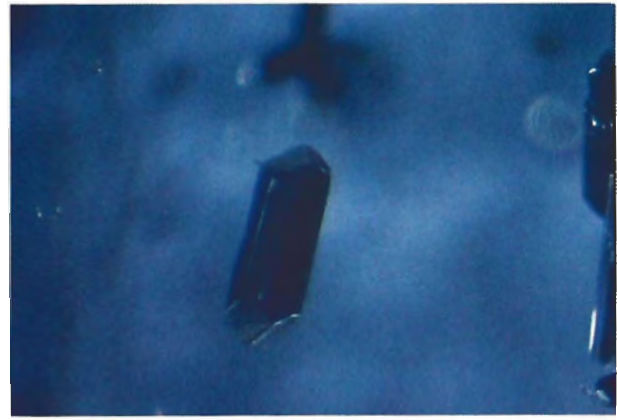

Figure 8. Under higher magnification (50x), the faces of one of the rutile crystals in the stone shown in figure 7 are apparent. Transmitted and oblique illumination.

fused on a charcoal block with an equal portion of anhydrous sodium carbonate. Then a droplet of concentrated sulphuric acid and an equal portion of distilled water was mixed with the powdered fused inclusion in a test tube. Lastly, a tiny droplet of hydrogen peroxide was placed in the solution of powdered inclusion and liquid H_2SO_4 (for more information on this classic technique for chemical analysis, see Brush, 1898). The resulting yellowish color of the solution suggests that titanium is present. Microprobe analysis by Carol Stockton of GIA confirmed the predominance of titanium.

Two of the sapphires also contained short, stout, rounded hexagonal prisms that are transparent and colorless (figure 5). Their external morphology suggested that they may be apatite. A thin slice containing several of these inclusions was cut from the end of one of the crystals. The excess corundum was first ground away. The slice was then crushed into a coarse powder and placed on a glass microscope slide. No cleavage of the inclu-

sions was noted during crushing. Using the Becke line method, we found that the powdered fragments had a refractive index near to, but slightly higher than 1.630, the index of the immersion fluid. Under polarized light, the fragments proved to be doubly refractive, although no optic figure could be resolved. These optic constants suggest fluorapatite (R.I. 1.633–1.636).

FUTURE OF THE DEPOSIT

Political problems aside, the Mercaderes sapphire deposit shows great potential. The quality of the sapphire is generally good, and there is ready availability of the material in commercially useful sizes. The unusually high concentration of stones exhibiting color change will be of particular interest to gem collectors. The presence of very sharp edges on some of the crystals suggests that the current alluvial mining is close to the source, and in-situ sapphire mining is a distinct possibility in the future.

REFERENCES

- Bank H., Schmetzer K., Maes J. (1978) Durchsichtiger, blau-rot changierender Korund aus Kolumbien. *Zeitschrift der Deutschen Gemmologischen Gesellschaft*, Vol. 27, No. 2, pp. 102–103.
- Brush G.J. (1898) *Manual of Determinative Mineralogy with an Introduction on Blow Pipe Analysis*. John Wiley & Sons, New York.
- Codazzi R.L. (1927) *Los Minerales de Colombia*. Biblioteca del Museo Nacional, Bogotá, Colombia.
- Jobbins A.E., Berrangé J.P. (1981) The Pailin ruby and sapphire gemfield, Cambodia. *Journal of Gemmology*, Vol. 17, No. 8, pp. 555–567.
- Keller P.C. (1982) The Chanthaburi-Trat gem field, Thailand. *Gems & Gemology*, Vol. 18, No. 4, pp. 186–196.
- Marin P., Paris G. (1979) *Generalized Geologic Map of the Department of Cauca*. National Institute of Geological and Mineralogical Investigations, Bogotá, Colombia.
- Schmetzer K., Bank H., Gübelin E. (1980) The alexandrite effect in minerals: chrysoberyl, garnet, corundum, fluorite. *Neues Jahrbuch für Mineralogie Abhandlungen*, Vol. 138, pp. 147–164.
- Thompson D. (1982) *Sapphires in New South Wales*. Department of Mineral Resources, Sydney, Australia.

ALTERING THE COLOR OF TOPAZ

By Kurt Nassau

The various techniques in use today to alter colorless topaz to produce brown, pink and, most commonly, blue stones are discussed. Special attention is given to the three irradiation sources—gamma rays, high-energy electrons, and neutrons—used to convert the colorless stones to hues in the yellow to brown range and the subsequent heat treatment required in most cases to turn the irradiated stones blue. The blue color produced by irradiation and subsequent heat treatment is stable to light. Currently, no routine gemological tests are available that can definitively determine whether the color of the topaz is natural or the result of treatment.

ABOUT THE AUTHOR

Dr. Nassau is a research scientist residing in Bernardsville, New Jersey.

Acknowledgments: The author is grateful for information provided by many irradiation experts, including J. H. Borden, M. Bressler, A. Chin, G. P. Drake, P. Flusser, J. Kean, C. L. Key, H. Neiman, F. H. Pough, W. Weiss, M. A. Welt, and C. B. Williams.

© 1985 Gemological Institute of America

Topaz is an aluminum fluorosilicate usually containing some hydroxyl; the formula can be written as $\text{Al}_2\text{SiO}_4(\text{F},\text{OH})_2$. Topaz occurs naturally in a wide range of colors: most commonly it is colorless, but the yellow to brown series, which includes the highly desirable gold to sherry ("imperial") colors, is perhaps best known. Topaz also occurs in blue and, more rarely, in green, orange, violet, and pink. The last of these is considered to be the most valued of all topaz colors. Natural pink topaz, however, is extremely rare; this color is usually obtained by heating certain yellow to reddish brown Brazilian material that contains the chromium required to produce pink. Some natural yellow to brown topaz, such as is found in Utah and in some Mexican locations, fades on exposure to bright light and is therefore not used in jewelry. In blue topaz, it is the depth of the color and the absence of a steely gray or a greenish tint that is considered desirable (see Webster, 1984, for a general discussion of gem topaz).

While natural blue topaz is available from a variety of localities, the successful treatment of colorless topaz to produce attractive shades of blue has greatly enhanced the availability and, consequently, the popularity of these stones during the course of the last decade. Although irradiation can convert most colorless topaz into the yellow to gold to sherry to brown sequence, these colors are usually unstable, and the stone will return to colorless in just a few hours of exposure to bright light. When this colorless topaz is irradiated and (in most cases) subsequently heated, however, an attractive blue stone may be produced (figure 1).

The production of blue topaz from colorless by irradiation was first reported by F. H. Pough in 1957 as one of a large number of color changes observed in a variety of materials subjected to such treatment, but little note appears to have been made of this in the years that followed. This same reaction was accidentally rediscovered by the



Figure 1. This 57.3-ct topaz derives its color from irradiation (in a linear electron accelerator) and subsequent heat treatment. It originally resembled one of the white topaz preforms on which it sits. Stones courtesy of P. Flusser, Overland Gems, Los Angeles, CA; photo © Tino Hammid.

present author in a faceted topaz that had been purported to be quartz. When this was reported in 1974 by Nassau, and in 1975 by Nassau and Prescott, many in the gemstone trade felt that it explained the large number of deeply colored blue topaz crystals that had recently appeared on the market without any new mines or significant new developments in existing mines to account for the abundance. Since that time, a number of firms have become involved in the treatment of blue topaz, with the result that literally hundreds of thousands of carats of blue topaz have entered the world market during the last 10 years. Also, the

technique has been refined to the point that the blue color produced by treatment is often deeper and more intense than that seen in nature (figure 2).

Very little is known about the causes of the colors in topaz. Only the chromium-caused origin of pink, stable to both light and heat, is certain. There are at least three types of yellow to brown colors; two fade in light, the other is stable. The former two can also be bleached by heating for a short time to 200°–300°C, the latter by a somewhat longer heating to 200°–400°C. The natural blue color and the blue produced with irradiation

Figure 2. A natural-color blue topaz (left) is notably lighter than its electron-irradiated counterpart (right). Although a wide variety of yellow to brown colors occur naturally or are produced by treatment, the two shades of brown produced by a short dose of gamma rays in the stones on the bottom left provide an interesting comparison with the natural-color yellow topaz on the bottom right.



are stable to light and are lost on heating to about 500°C. The yellow to brown and the blue colors are all clearly color centers (Nassau, 1983 and 1984) produced by the interaction of radiation with electrons on defects of unknown nature; what little is known has been summarized elsewhere (Nassau, 1974 and 1984; Nassau and Prescott, 1975). Not all colorless topaz will respond to treatment; in some cases one part of the crystal will be altered while the rest will remain unchanged. For the gemstone treater, it is very much a matter of trial and error.

The various heating and irradiation processes used on topaz are summarized in figure 3. Surpris-

Figure 3. The changes in color produced by the treatment—irradiation and/or heat (or, in some cases, sufficient exposure to light)—of topaz.

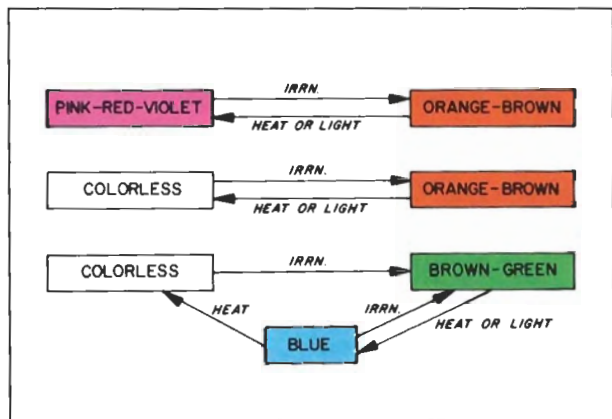

ingly, none of the many enhancement processes used on other gemstones appears to have been applied to topaz, except for the dyeing of water-worn pebbles in indigo dye pots as reported in Webster (1984). The following account of the major processes used to alter the color of topaz is based on a critical comparison of the author's own experiences, published data, and information provided by many experts in the field.

THE IRRADIATION OF TOPAZ

Several types of irradiation can be used to alter the color in topaz: X-rays, gamma rays, neutrons, and high-energy charged particles such as electrons, protons, and the like. Some of these are not in common use: X-rays of the usual low energies have only a very shallow penetration, and high-energy particles other than electrons are more costly to generate and provide no advantage over electrons.

Further details on irradiation techniques and their application to gemstones are given in *Gemstone Enhancement* (Nassau, 1984). The comparative advantages and disadvantages of using gamma rays, high-energy electrons, and neutrons to convert colorless topaz to brown or blue are examined below.

Gamma Rays. Gamma rays are produced within a gamma cell, a device containing a quantity of a radioactive material, such as the mass 60 isotope of cobalt (Co-60), which emits these rays. Such

devices are commercially available in large sizes, require little upkeep, and continuously produce the rays with only a slow decay over many years. The rays are very penetrating and will produce uniform coloration if the material is uniform. Relatively little heat is generated during this process and this heat is produced uniformly throughout the specimen, so that cracking is not a problem; to avoid excessive temperatures, the rate of irradiation is kept at a reasonable level, usually less than 5 megarads per hour, depending on the size of the specimen.

When colorless or pale-colored topaz is exposed to gamma rays, a color in the sequence yellow to brown to reddish brown to very dark brown is usually produced, with significant color already appearing at quite low radiation doses (e.g., less than one megarad of Co-60). Because of variations in the nature of the topaz (impurities and other defects), these colors are frequently not uniform and will vary even among zones within a single crystal. The larger the dose of radiation used, the darker the color of any region up to a point controlled by the nature of that region. Different parts of a crystal may show different rates of coloration as well as different color limits. These yellow to brown colors usually fade on exposure to light, and can also be removed by heating to 200°–300°C for as little as a few hours.

If gamma irradiation is extended to relatively high doses (say, a few tens to many thousands of megarads of Co-60), then an olive-green component may be visible in the yellow to brown range of colors. The greenish component is derived from the presence of a light absorption which by itself leads to a blue color. If the stone is then heated to about 200°–300°C to remove the yellow to brown component, there may then be revealed a blue color, which is produced much more slowly by the gamma rays than is the brown color. This blue color is stable to light, and is destroyed by heat only if a relatively high temperature of about 500°C for a few hours is used; at this temperature, natural blue topaz will also turn colorless.

The blue color produced in colorless or pale topaz by practical doses of gamma rays (i.e., a few hundred to a few thousand megarads at most) and subsequent heating is usually not very intense; some topaz may show hardly any blue color even on extended gamma irradiation. There is no relationship between the rate of coloration and the maximum depth of the brown color and the rate

of coloration and the maximum depth of the blue color. When the color is very intense, however, a "steely" blue may result (figure 4).

High-Energy Electrons. Electrons are accelerated to high energies in a variety of machines, including linear accelerators (linacs), Van de Graaff generators, and betatrons, among others. After reaching the selected energy, the beam of electrons is electrically deflected in a zig-zag pattern to cover an area, typically a few to many centimeters across, or a sample container is moved in such a way as to expose the whole specimen holder to the electrons. Such high-energy-electron facilities are large, complex, expensive to build, expensive to operate, and must be well shielded, hence the higher cost of electron irradiation versus gamma irradiation. For the coloration of blue topaz, irradiation energies in the 10 to 20 mega-electron-volt range are most commonly used.

High-energy electrons act quite differently from gamma rays. They produce considerable heat, with much of the heat generated at the surface of the specimen. The samples are usually cooled with cold running water during the radiation procedure; even so, cracking is common if

Figure 4. This 6-ct topaz illustrates the "steely" blue color that is often produced in stones subjected to gamma or neutron irradiation.

Photo © Tino Hammid.





Figure 5. "Internal lightning," caused by an internal electrical discharge during irradiation in a linear accelerator, is evident when this 52.3-ct blue topaz is viewed through the table with the unaided eye (left) as well as with 3× magnification (above). Stone courtesy of P. Flusser, Overland Gems, Los Angeles, CA; photos © Tino Hammid.

certain inclusions or defects are present, and melting can occur if the water supply is interrupted or the beam of electrons remains fixed in one spot. A large amount of negative electricity is also carried by the beam into the specimen, and an internal electrical discharge or "internal lightning" (also referred to as "treeing effect" or "Lichtenburg figure" in other contexts) can occur as shown in figure 5, and may cause severe damage. If the energy used is high enough, most of the beam can be made to pass through the specimen to avoid damage from this effect.

Because the energetic electrons have limited penetration, the coloration effect, like the heat, is most intense at the surface. The penetration depth can be increased by raising the energy of the electrons, but then induced radioactivity may occur. This last factor depends on the specific impurities present in a specimen, and for topaz it usually sets in above an energy of about 15 mega electron volts. A "cooling off" period of a few days to a few weeks may be necessary, during which time the induced radioactivity decays to an acceptable level.

A significant advantage to the use of electrons is that the dose rates available are much higher than those in gamma cells. It is practical, therefore, in reasonable time periods of a few hours to reach doses of many tens of thousands of megarads of energetic electrons, while it may take many days to achieve just a few thousand megarads of gamma rays. A high dose may be required

since the coloration does not vary in a linear fashion with the dose.

Like gamma rays, high-energy electrons can produce both the brown and the blue colors in topaz, and heating is used to remove the brown if blue is desired. Since higher doses are practical, electrons can usually produce a more intense blue than gamma rays; the "inky" or "steely" blue often seen in stones treated with gamma or neutron irradiation does not seem to occur. In view of the potential electrical discharge problems and the tendency for greater interaction at the surface, the production by electrons of a deep blue color in specimens much larger than about 150 ct or much thicker than about 15 mm is usually not practical.

Neutrons. Neutrons, produced in nuclear reactors, can also induce radioactivity in all but the purest of topaz crystals. However, they have excellent penetration, so there are no surface heating or coloration problems, and the colors produced are usually uniform and deep. Because there is no risk of cracking, size is not the problem it is with high-energy electron irradiation. The neutrons in a nuclear reactor can be of varying energy and are also accompanied by gamma rays and other rays and particles. By placing the material to be irradiated into a cadmium-lined iron container, the thermal neutrons that do essentially all of the activating are absorbed by the metals, which then also generate additional gamma rays (Bastos, 1984). To use neutron irradi-

ation, however, the treater must have access to a reactor facility that is able to handle the very high radioactivities involved with the special cadmium-lined iron container. Doses of up to 1,000 megarads are said to be adequate to produce, after heating, a deep blue. The color may be darker than that produced by electrons, often "inky" or "steely." Zoning of color can be expected to be similar to that observed with other irradiation techniques used for the blue product.

The Restoration of Color. Irradiation can also be used to restore the natural yellow to brown or blue color in a topaz when this has been accidentally destroyed by overheating. Although irradiation will usually produce an additional yellow to brown component as well, this can be removed by a gentle heating or exposure to bright light, thus producing a restoration of the original color. The final color will be just as stable (or unstable) as the original natural one. It is also possible in this same way to return heated pink topaz back to its original color if, for example, the pink is too pale.

THE HEAT TREATMENT OF TOPAZ

A heating step is usually required to remove the yellow to brown color and reveal any blue that may be present. Just as not all colorless topaz will alter to the yellow to brown range with irradiation, not all irradiated yellow to brown stones

will alter to blue; and variations in color from stone to stone, or even within a single stone, are possible (figure 6). While gamma and neutron irradiation in themselves can be conducted on quite large pieces of topaz, this is not true of high-energy-electron irradiation because of the three factors discussed above: limited penetration depth, heat generation, and the build-up of electrical charge. Heating, too, cannot be performed on large topaz specimens without loss.

It is well known that most topaz is very heat sensitive and often breaks, cleaves, or shatters on heating, even if temperatures as low as 200°C are applied very slowly and carefully. The presence of strains, flaws, inclusions (particularly liquid-filled ones), and cracks makes a specimen especially prone to damage.

The solution is obvious: perform these processes on faceted stones, or at least preforms (gemstones that have been roughed out but not finished) that are fashioned so that they do not contain stresses, flaws, or inclusions. An added advantage to using preforms is that irradiation fees are based on weight, and there is a large reduction in weight from the rough to the preformed or faceted stone. The yield of faceted product intended to become blue topaz is less than that for most other gemstone materials because all but the smallest of strains, flaws, and inclusions must be eliminated.

Figure 6. These topaz preforms are shown after they have been irradiated in a linear accelerator and just before (left) and after (right) heat treatment at 220°C for approximately one and a half hours. Note the variations in color within this lot of stones both before and after heating. Stones and furnace courtesy of P. Flusser, Overland Gems, Los Angeles, CA; photos © Tino Hammid.





Figure 7. Heat treatment over an open flame turned a yellow topaz from the same lot as the 2.5-ct stone on the lower right into the attractive pink topaz on the upper left. Stones courtesy of P. Flusser, Overland Gems, Los Angeles, CA; photo © Tino Hammid.

For the heating step used to remove the brown color from irradiated topaz (and possibly to improve the "steely" blue of the gamma- and neutron-irradiated products) temperatures in the 200°–300°C range are used, usually for one to two hours. At higher temperatures, about 500°C, the blue color itself begins to fade. The fading occurs as the electrons return to the original location from which they were displaced by the irradiation that had formed the color center (Nassau, 1983; Nassau, 1984). A wide variety of different color centers can form in topaz (Nassau, 1984), including slowly and rapidly fading yellows to browns, stable yellows to browns, a stable blue, and the "steely" blue—causing component. Although formation rates of these color centers can be quite different even in different parts of the same crystal, the temperature-induced fading be-

havior is usually quite consistent: the unstable yellow to brown colors require only a short time (an hour or less) at temperatures as low as 200°C, the stable yellow to brown colors require a longer time (a few hours) at 200°–400°C, and the stable blue requires about 500°C to make it fade.

Any type of furnace can be used, and heating in air is perfectly adequate. Heating may be performed with the topaz wrapped or buried in some inert substance such as clean dry sand. This is placed into a cold furnace and heated to the treatment temperature very gradually; the larger the stones, the slower the heating rate that needs to be used. After the required time at temperature, the furnace is often cooled at an equally slow rate and the stones are not removed until they have returned to room temperature.

In an original modification (C. Key, unpublished observation) of the electron irradiation and heating process described above, the rough topaz is first heated without any of the usual precautions so that all of the potential fracturing occurs before the cutting, irradiation, and subsequent heating steps. In this way there is essentially no cracking in these later steps, leading to a considerable economy in the processing.

Heating of yellow to reddish brown topaz from Ouro Preto, Brazil, has been long practiced (Webster, 1984) to develop a salmon-pink to purple-red color (figure 7) that appears only if chromium is present in the topaz. By heating in the 400°–500°C range, the yellow to brown component is bleached. There is little doubt that a similar heating can be used on green topaz, for example, from the Urals, to produce blue. It also can be used to convert purplish or bluish pinks to a pure pink by removing the blue component, the latter at perhaps a somewhat higher temperature.

COMMERCIAL FACTORS

The supply of treated blue stones has remained strong since the early 1970s, when they were first identified in the marketplace, until the present. It might have been expected that the existence of the irradiation process would cause a significant increase in the value of colorless topaz but this has not happened, possibly for two reasons. First, the costs of cutting and irradiation are sufficiently greater than the cost of the colorless topaz itself, so that these steps appear to account for 90% or more of the entire cost of the blue topaz produced.

Second, the supply of mined colorless topaz, even though not large, is apparently still larger than the past and current demand for blue topaz; in addition, there are believed to be sufficient amounts of unmined (because of the lack of previous demand) colorless topaz suitable for treatment should any additional demand arise. As discussed above, there is much variability in the behavior of topaz on irradiation; colorless material that could be guaranteed to turn a deep blue would obviously command a premium.

The irradiation of gemstones is such a small fraction of the total irradiation business that there are no dedicated facilities. Industrial irradiation facilities are commonly used for such purposes as medical supply sterilization, food preservation, the modification of plastic products, semiconductor treatment, and so on; gemstone irradiation is carried out between such activities (Nassau, 1984). Commercial gemstone irradiation firms frequently act only as intermediaries; they accumulate material and then have the irradiation performed at an industrial facility.

It is probably true that for most topaz the impurities or defects that provide the potential to form blue are the same for the different forms of irradiation; the impurities or defects giving the potential to form brown are different from these. By a preliminary low-cost, medium-dose gamma-ray irradiation and subsequent heating to the blue stage, the fraction of material least likely to yield a more intense blue color could be eliminated from the more costly electron irradiation without, however, any significant change in the overall yield of the deep- and medium-blue products.

IDENTIFICATION OF NATURAL AND TREATED TOPAZ

The properties used to distinguish topaz from other gemstone materials are well known (Webster, 1984). The necessity for distinction from a synthetic does not arise, since so far only tiny topaz crystals have ever been grown in the laboratory and these have been done by the hydrothermal method, which is slow and costly (Nassau, 1980).

The identification of the origin—natural or treated—of the various shades of pink, brown, and blue presents many difficulties. The “burned” pink is reported to have a much greater dichroism (dark cherry red and honey yellow) than the very

rare natural pink topaz (Bauer, 1968), but the origin of the color cannot be established concretely by routine gemological methods. Both the irradiated brown and the blue colors show the same absorption spectra as the equivalent natural stone (Nassau, 1974; Nassau and Prescott, 1975; Petrov et al., 1977; Petrov and Beredinski, 1975). With the blue material there is a difference in the thermoluminescence as reported by Petrov et al. (1977); as the temperature is raised, there is an emission of light in the irradiated blue topaz that is not present in the natural blue topaz. Similar thermoluminescence results have been reported by Rossman (1981). Such a test could be performed on a microscopic specimen scraped from the girdle of a stone, but extensive research would be required to ensure that this is a consistent and reproducible test which could not be negated by a selective preliminary heating of the stone. Also, the equipment required makes the test impractical for the average jeweler/gemologist. Although the origin of color (treated) appears to be obvious in the deepest of blue topaz, it is not possible to definitively establish the origin of the blue color with certainty using routine gemological tests.

Finally, for the yellow to brown shades of topaz, there is the problem of distinguishing the stable from the fading colors, either natural or irradiated. At present, no gemological test is known for this identification other than a direct fade test; this should always be performed if there is any question as to the permanence of the color.

As mentioned above, radioactivity can be induced into topaz during irradiation; such radioactive material was indeed found in the trade in 1981 (Crowningshield, 1981), its origin traced to irradiation operations in Brazil, but no additional occurrences have been reported since that time.

CONCLUSION

Although topaz has been subjected to heating alone (to turn yellow to reddish brown stones pink to red) and some dyeing, by far the most common technique used on topaz today is irradiation and subsequent heat treatment to alter colorless stones to blue. Literally hundreds of thousands of carats of attractive blue topaz have been produced in this fashion during the last 10 years.

Irradiation has also been used on other gemstones to effect a variety of color changes. In some instances, such as Maxixe beryl and irradi-

ated yellow sapphire, these colors are unstable and will fade on exposure to light, as does the irradiated yellow to brown topaz color. In other instances, such as irradiated smoky quartz and irradiated diamond, the color is stable to light, as is the irradiated blue topaz (Nassau, 1984). Blue topaz, however, is currently the most common gemstone being irradiated. The blue color that results after heating is stable and has shown wide consumer acceptance. The treated material cannot be distinguished from its natural blue counterpart by gemological testing at this time.

REFERENCES

- Bastos F.M. (1984) Irradiated topaz and radioactivity. *Gems & Gemology*, Vol. 20, No. 3, p. 179.
- Bauer M. (1968) *Precious Stones*. Dover Publications, New York.
- Crowningshield R. (1981) Irradiated topaz and radioactivity. *Gems & Gemology*, Vol. 17, No. 4, pp. 215-217.
- Liddicoat R.T. Jr. (1967) Irradiated topaz. *Gems & Gemology*, Vol. 12, No. 5, p. 155.
- Nassau K. (1974) The effects of gamma rays on the color of beryl, smoky quartz, amethyst, and topaz. *Lapidary Journal*, Vol. 28, No. 1, pp. 20-26, 30, 36-40.
- Nassau K. (1980) *Gems Made by Man*. Chilton Book Co., Radnor, PA.
- Nassau K. (1983) *The Physics and Chemistry of Color*. Wiley & Sons, New York.
- Nassau K. (1984) *Gemstone Enhancement*. Butterworths, London.
- Nassau K., Prescott B.E. (1975) Blue and brown topaz produced by gamma irradiation. *American Mineralogist*, Vol. 60, No. 7/8, pp. 705-709.
- Petrov I., Beredinski W. (1975) Untersuchung künstlich farbveränderter blauer Topase. *Zeitschrift der Deutschen Gemmologischen Gesellschaft*, Vol. 24, No. 2, pp. 73-80.
- Petrov I., Beredinski W., Bank H. (1977) Bestrahlte gelbe und rotbraune Topase and ihre Erkennung. *Zeitschrift der Deutschen Gemmologischen Gesellschaft*, Vol. 26, No. 3 pp. 148-151.
- Pough F.H. (1957) The coloration of gemstones by electron bombardment. *Zeitschrift der Deutschen Gesellschaft für Edelsteinkunde*, No. 20, p. 71.
- Rossmann G. (1981) Color in gems: the new technologies. *Gems & Gemology*, Vol. 17, No. 2, pp. 60-71.
- Webster R. (1984) *Gems: Their Sources, Descriptions and Identification*, 4th ed. Revised by B. W. Anderson. Butterworths, London.

A SPECIAL THANKS

The Gemological Institute of America wishes to extend its sincerest appreciation to all of the people who contributed to the activities of the Institute through donations of gemstones and other gemological materials. We are pleased to acknowledge many of you below:

- | | | |
|------------------------------|----------------------------|----------------------------|
| Mr. and Mrs. Robert Anderson | Mr. William Hofer, Jr. | Mr. Jorge Saavedra |
| Mr. George Ashley | *Ms. Leona Hyding | Dr. Ronald Saldino |
| Mr. Gordon Bailey | Inamori Laboratory, Ltd. | Mr. and Mrs. Hyman Savinar |
| Mr. Marcelo de O. Bernardes | Dr. and Mrs. Ralph Kennedy | Mr. Harry Schukar |
| Mr. Curt Berreman | Mr. William Larson | Serengeti Company |
| Mr. Gary Bowersox | Mr. Luis Lau | Dr. James Shigley |
| Mr. and Mrs. Louis Coccomo | *Ms. Sabine Loiseau | Mr. David Sigler |
| Ms. Jean Coutts | Mr. Steve Lukinuk | Mr. Ronald Tanaka |
| Mr. I. Z. Eliezri | Dr. D. Vincent Manson | Mr. W. Taylor |
| Mr. and Mrs. Thomas Fletcher | Ms. Judy Mayfield | Mr. Leonard Thomas |
| Dr. and Mrs. Joseph Farrar | Mr. Robert McGrane | Vacuum Ventures, Inc. |
| Mr. James Gallagher | *Mr. E. F. Montgomery | Mr. Scott Vandersade |
| Mr. Gilbert Gautier | Mr. John Ng | Mr. Rene Vandervelde |
| Mr. Jeffrey Gendler | Mr. Julius Petsch, Jr. | Mr. Marius Van Dyke |
| Dr. Samuel Gendler | Mr. A. M. Poultney | Mr. Norman Yett |
| Mr. and Mrs. Larry Goodman | Ms. Ann Renaldi | Mr. Mohammed Zafarullah |
| Mr. Niels Hansen | Ms. Yvonne Rose | Zale Corporation |
| Dr. William Harville | Die Rohsteinquelle | |

*Denotes book donation to GIA Library.

NOTES · AND · NEW TECHNIQUES

A PRELIMINARY REPORT ON THE NEW LECHLEITNER SYNTHETIC RUBY AND SYNTHETIC BLUE SAPPHIRE

By Robert E. Kane

A new synthetic ruby and synthetic blue sapphire have been synthesized by Johann Lechleitner of Innsbruck, Austria. This article reports on the examination of one sample of each of these new synthetics and discusses means of identification. Although most of the gemological properties of these two synthetics overlap with those of their natural counterparts, they can be easily identified from natural corundum and from other synthetics by their distinctive internal characteristics: inclusions that are typical of both the flux-growth and the Verneuil processes.

Very recently, the author examined two new synthetic gem materials (synthetic ruby and synthetic blue sapphire) reported to have been produced by J. Lechleitner of Innsbruck, Austria. Lechleitner is well known for his commercial production (since 1959) of emerald substitutes that consist of a faceted colorless, or very lightly colored, natural beryl "seed" that is completely coated with a thin layer of synthetic emerald (Holmes and Crowningshield, 1960). Lechleitner has also produced emeralds that are completely synthetic.

The material examined in this study included one 0.47-ct round modified brilliant cut synthetic ruby and one 0.69-ct round modified brilliant cut synthetic blue sapphire (see figure 1). Although the two samples examined and discussed here were not obtained directly from J. Lechleitner, he confirmed that he has been growing synthetic ruby and synthetic blue sapphire since late 1983 (J. Lechleitner, pers. comm., 1985). Lechleitner also



Figure 1. Faceted Lechleitner synthetic ruby (0.47 ct) and synthetic blue sapphire (0.69 ct). Photo ©Tino Hammid.

reported that all of the synthetic ruby and synthetic blue sapphire that he has produced to date has been turned over to H. Bank of Idar-Oberstein. Professor Bank (pers. comm., 1985) has stated that Mr. Lechleitner has produced corundum in the

following colors: blue, red, "padparadscha," colorless, "alexandrite-color," yellow, green, and pink. According to Professor Bank, the production is "more or less experimental." He did note, however, that a few stones have been sold in Japan, which is where the stones examined by the author were obtained.

The intent of this article is to inform the gemological community of the existence of this new synthetic ruby and synthetic blue sapphire and to provide the gemological properties of these new synthetics, based on the examination of the two above-mentioned samples, as well as indicate means to identify them from their natural counterparts.

GEMOLOGICAL CHARACTERISTICS

The faceted Lechleitner synthetic ruby and synthetic blue sapphire were first examined for color, transparency, and clarity. With regard to color, the Lechleitner synthetic ruby studied is purplish red in hue, with medium tone and strong saturation. The Lechleitner synthetic sapphire examined is

blue in hue, with medium tone and moderately strong saturation.

Both synthetics are transparent with areas that appear to be hazy. When judged with the unaided eye, both synthetics also appear to be relatively free of inclusions; when examined with magnification, however, numerous flux inclusions become readily apparent, which accounts for the haziness.

Also examined was the direction of optic axis orientation. In the synthetic ruby, the optic axis is oriented nearly parallel to the table. In the synthetic blue sapphire, the optic axis is oriented about 20°–30° from the plane parallel to the table.

The other gemological characteristics (refractive index, pleochroism, luminescent reactions when exposed to long-wave and short-wave ultraviolet radiation as well as X-rays, absorption spectra as viewed through a hand-held type spectroscope, and specific gravity) of the Lechleitner synthetic ruby and synthetic blue sapphire were obtained using routine gemological methods. These characteristics are summarized in table 1;

TABLE 1. The gemological properties of Lechleitner synthetic ruby and synthetic blue sapphire.^a

Material tested	R.I. and biref.	Pleochroism	Luminescence			Absorption spectrum ^b (400 nm–700 nm)	S.G. ^c	Inclusions
			Long-wave ultraviolet radiation	Short-wave ultraviolet radiation	X-rays			
Lechleitner synthetic ruby	$\epsilon = 1.760$ $\omega = 1.768$ 0.008	Strong purple-red parallel to the c-axis; pale orangy pink perpendicular to the c-axis	Strong red; no phosphorescence	Moderate red, with slightly chalky white overtone; no phosphorescence	Moderate chalky red; no phosphorescence	Absorption lines at 475.0, 476.5, 468.5, 659.2, 668.0, 692.8, and 694.2 nm; broad absorption blocking out all of the violet and some of the blue, all of the green and yellow, and a small area in the orange portion of the visible spectrum	4.00 ±0.03	Flux "fingerprints" and wispy veils that range from nearly transparent to opaque and from near-colorless to white; as well as from thin, minute, tightly arranged patterns to loosely arranged, flat, mesh-like patterns; very low to moderate relief; curved striae
Lechleitner synthetic blue sapphire	$\epsilon = 1.760$ $\omega = 1.768$ 0.008	Strong violetish blue parallel to the c-axis; pale greenish gray-blue perpendicular to the c-axis	Inert; no phosphorescence	Very weak chalky whitish blue; no phosphorescence	Very weak, opaque chalky white; no phosphorescence	No visible lines or bands; broad absorption of moderate intensity in a portion of the violet and far red area of the visible spectrum	4.00 ±0.03	Same as for the synthetic ruby but in greater amounts; moderate to high relief; curved color banding

^aThese properties were obtained by testing one faceted sample of each synthetic.

^bThe visible-light absorption spectrum as observed through a "hand-held" type of gemological spectroscope unit.

^cSpecific gravity was estimated using heavy liquids and indicator stones of known specific gravity.

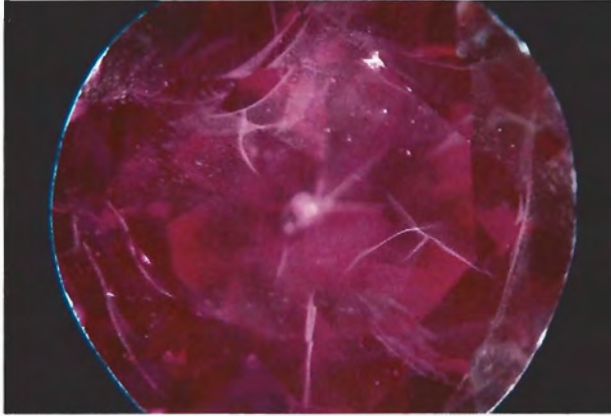

Figure 2. Numerous white, wispy veils, very fine to moderate in texture, reduce the transparency of this Lechleitner synthetic ruby. Dark-field illumination, magnified 20 \times .

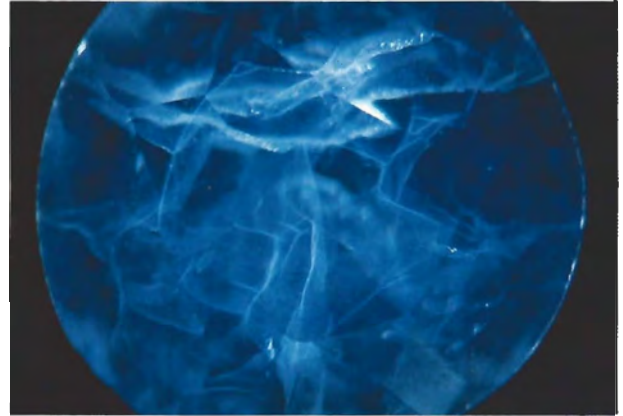

Figure 3. Low magnification is all that is required to reveal the dense concentrations of flux, in the form of wispy veils, that betray the synthetic origin of this Lechleitner synthetic blue sapphire. Dark-field illumination, magnified 15 \times .

all except the internal characteristics overlap to some extent with their natural counterparts.

IDENTIFICATION

Because of the overlap in most gemological characteristics between the two Lechleitner synthetics and natural corundum, an extensive microscopic examination of the two samples was undertaken. It was determined that the inclusions would provide the most effective means of identification; in fact, there are several easily recognizable inclusions that are diagnostic of synthesis.

Flux. As both the synthetic ruby and the synthetic blue sapphire are examined with low magnification through the table and crown facets, flux in the form of wispy veils and "fingerprints" is readily apparent (figures 2 and 3). In the synthetic ruby, the flux veils range from nearly transparent to opaque and from near-colorless to white in very low to moderate relief. The flux "fingerprints" and veils range from thin, minute, tightly arranged patterns to more loosely arranged mesh-like patterns, both of which frequently intersect (again, see figure 3). At the edges of a few of the flux "fingerprints" or veils are thicker, long channels or voids that are filled or partially filled with flux. This type of inclusion is commonly observed in many flux-grown synthetics and forms when the molten flux is trapped within the rapidly growing crystal and crystallizes or partially crystallizes as the synthetic crystal cools. In the Lechleitner synthetic

ruby, a nearly opaque, frosted, white appearance has resulted at the edges of the channels. Some of these small inclusions also exhibit a two-phase-like appearance; however, as with similar-appearing features observed in some Kashan and Ramaura synthetic rubies, these inclusions are probably not truly two-phase but, rather, are completely solid in nature (Kane, 1983).

The Lechleitner synthetic blue sapphire contains flux "fingerprints" and wispy veils that are similar in many respects to those observed in the Lechleitner synthetic ruby. The most notable differences are the larger quantity and higher relief of these flux inclusions (again, see figure 3). As shown in figure 4, one of the "fingerprints" is very similar to those observed in some Chatham flux-grown synthetic blue sapphires (Kane, 1982; Gübelin, 1983).

Curved Growth Features. Easily visible in several portions of the Lechleitner synthetic ruby are curved growth features, also referred to as curved

ABOUT THE AUTHOR

Mr. Kane is research and gem identification supervisor of GIA's Gem Trade Laboratory, Inc., Los Angeles, California.

Acknowledgments: The author is grateful to Judith Osmer for the loan of the synthetic material, to Johann Lechleitner and Hermann Bank for information provided, and to Karin Hurwit for translations of the German literature. All photographs, unless otherwise indicated, are by the author.

© 1985 Gemological Institute of America



Figure 4. Flux ranging from semitransparent to opaque and from near-colorless to white occurs in wide, mesh-like patterns intersected by thin, tightly arranged white "fingerprints" in a Lechleitner synthetic blue sapphire. Dark-field illumination, magnified 35 \times .

striae, a commonly encountered inclusion by-product of the Verneuil method of growing synthetic crystals and sometimes observed in rubies grown by the Czochralski pulling method.

The Lechleitner synthetic blue sapphire also contains curved growth features. Although not as readily apparent as in the synthetic ruby, the curved color banding in the synthetic blue sapphire is faintly visible with high magnification (approximately 40 \times) and diffused illumination.

METHOD OF SYNTHESIS

The characteristic appearance of the flux inclusions in the two Lechleitner synthetics indicates that this material was at least partially manufactured in a flux-growth environment. On the basis of his own investigations and discussions with crystal growers, the author has developed two theories to explain the presence of both curved growth features and various forms of flux-type inclusions in a single stone:

1. A small Verneuil seed crystal could have been placed in the flux growth chamber (crucible), with the intended purpose of starting and/or controlling the size and direction of the flux growth. The curved growth features observed in the two synthetic stones studied could be in the actual Verneuil seed crystal, which was not removed during cutting and thus became part of the faceted synthetic gemstone.
2. A larger Verneuil synthetic corundum (colorless or doped with added impurities to produce ruby or blue sapphire) could have been placed in a flux-growth environment for a sufficient length of time to enable flux-grown corundum to completely encase the Verneuil synthetic, while also inducing flux inclusions within the Verneuil material.

Both of these methods have been applied to synthetic ruby growth in the past, in experiments conducted by Chatham Created Gems of San Francisco, California (Thomas Chatham, pers. comm., 1981). Figure 5 shows examples of synthetic ruby grown by Chatham several years ago using the latter of the above-mentioned growth techniques. A slightly different experiment involving a highly fractured Verneuil synthetic ruby placed in a flux-growth environment for 42 days was recently conducted (Koivula, 1983). Although it was difficult to determine whether or not the curved features extended completely throughout the Lechleitner synthetic sapphire and synthetic ruby (in both stones they were only visible through the pavilion), there was no discernible division between the Verneuil portion and the flux portion of these synthetics; the flux appeared to have been induced into the Verneuil material. Such a division was observed in the experimental Chatham synthetic rubies.

Professor Bank (1983 and pers. comm., 1985) has confirmed that Lechleitner is producing several different combinations of synthetic overgrowth, including synthetic pink corundum over synthetic Verneuil colorless corundum, synthetic ruby over synthetic Verneuil ruby, and synthetic ruby over natural corundum. It is important to note that the process used to manufacture the Lechleitner synthetic corundums examined for this study is completely different from that used by Lechleitner to produce his synthetic emerald overgrowth. Neither the synthetic ruby nor the synthetic blue sapphire showed any of the characteristics that are typically associated with the Lechleitner imitation emerald, such as the "stress" cracks at the interface of the synthetic overgrowth and the natural emerald seed.

CONCLUSION

The Lechleitner synthetic ruby and synthetic blue sapphire appear to represent a new method of syn-

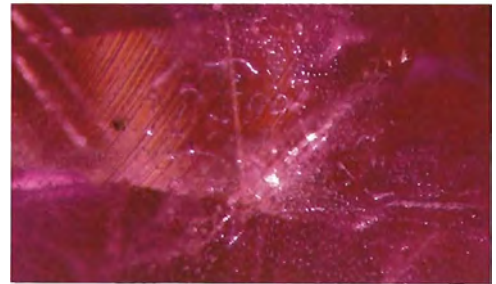

Figure 5. Synthetic ruby crystals grown by Chatham, Inc., using a technique by which Verneuil synthetic rubies are placed in a flux-growth environment. Like the Lechleitner synthetics, these crystals contain both curved striae and flux. Photo on left ©Tino Hammid; photomicrograph, dark-field illumination, magnified 40 \times .

thesis that thus far has not been widely available commercially. As with essentially all other synthetic corundum, the gemological properties of the Lechleitner synthetic ruby and synthetic blue sapphire examined in this study overlap to some extent with those of their natural counterparts, with the exception of inclusions. Various forms of white flux ("fingerprints" and wispy veils) and curved growth features were observed in the two samples examined, and provide a definitive means of identification.

It is very unlikely that a synthetic grown by this method would be devoid of inclusions. It is possible, however, that a synthetic stone of this manufacture could be cut from the exterior of the synthetic crystal so that it would contain only flux inclusions, and thus be devoid of curved growth features. This report is based only on one Lechleitner synthetic ruby and synthetic blue sapphire; it is probable that when more material is examined in the future, a wider variety of charac-

teristics will be present. However, if the gemologist is aware of these new synthetics and their characteristic inclusions, and uses careful microscopic examination, these materials should be readily identified.

REFERENCES

- Bank H. (1983) Neue synthetische Rubine nach LECHLEITNER als Überzug auf natürlichen und synthetischen Rubinen sowie farblosen Korunden der Verneuil synthese. *Zeitschrift der Deutschen Gemmologischen Gesellschaft*, Vol. 32, Part 4, p. 207.
- Gübelin E. (1983) Identification of the new synthetic and treated sapphires. *Journal of Gemmology*, Vol. 18, No. 8, pp. 677-706.
- Holmes R.J., Crowningshield G.R. (1960) A new emerald substitute. *Gems & Gemology*, Vol. 10, No. 1, pp. 11-22.
- Kane R.E. (1982) The gemological properties of Chatham flux-grown synthetic orange sapphire and synthetic blue sapphire. *Gems & Gemology*, Vol. 18, No. 3, pp. 140-153.
- Kane R.E. (1983) The Ramaura synthetic ruby. *Gems & Gemology*, Vol. 19, No. 3, pp. 130-148.
- Koivula J.I. (1983) Induced fingerprints. *Gems & Gemology*, Vol. 19, No. 4, pp. 220-227.

INTERESTING RED TOURMALINE FROM ZAMBIA

By John I. Koivula and C. W. Fryer

This note describes the study of five small, gem-quality crystals and crystal fragments of a brownish red to red tourmaline from a new locality near Chipata, Zambia. The mineralogical nature of these tourmalines is briefly discussed. X-ray diffraction indicates that these tourmalines belong to the schorl-dravite series. Refractive indices, birefringence, specific gravity, and other gemological properties are given, as well as comments on the inclusions. This material is very similar in appearance, gemological characteristics, and chemistry to the red tourmalines from Kenya.

The Gemological Institute of America recently received a gift of five small (1.17–3.44 ct) transparent, gem-quality crystals and crystal sections of a most unusual, deep red to brownish red, tourmaline that was reportedly mined near Chipata, Zambia (E. Petsch, pers. comm.). These specimens strongly resemble tourmalines from Kenya. Two of the crystals are terminated with trigonal pyramids. The others, although broken, show a few sharp, well-defined prism faces that suggest an eluvial or in-situ, rather than alluvial, source.

The fact that the intense red to brownish red color (figure 1) is almost identical to the red tourmalines previously reported from Kenya (Bank, 1974; Dunn et al., 1975), and the fact that this material came from a new locality approximately 1,000 km south of where the Kenyan material was discovered (Dunn et al., 1975), suggests that there might be a connection between the two occurrences. Accordingly, a number of tests were conducted on the Zambian crystals both to provide further information about this material and to compare it with the red tourmalines of Kenya.

GEMOLOGICAL PROPERTIES

The refractive indices were measured with a monochromatic light source and a Rayner Dialdex refractometer as 1.624 and 1.654. This birefringence, 0.030, is fairly high for tourmaline and is usually associated with the schorl-dravite series. Refractive indices varying from 1.623–1.654 to 1.626–1.657 (birefringence 0.031) were reported for the Kenyan dravite (Dunn et al., 1975).

Specific gravities of the five samples were de-



Figure 1. Of the five tourmaline samples used in this study, the one shown here (8.5 mm long) exhibited the best crystal form.

termined hydrostatically on a Voland double-pan balance at room temperature. They ranged from 3.03 to 3.07; the average specific gravity of the five samples was 3.05. Again, these results do not differ significantly from those obtained by Dunn et al. on dravite from Kenya; these authors found a specific gravity range of 3.07 to 3.08 in the material they examined.

The tourmalines were next studied with a Beck prism spectroscope to determine if any characteristic absorption lines were visible. In the optic axis direction, extreme absorption precluded a spectral analysis. Perpendicular to the optic axis,

however, we observed a strong broad band between 520 nm and 590 nm, another weaker band between 460 nm and 470 nm, and a 445 nm cutoff of the blue and violet (figure 2).

The pleochroic colors observed with the dichroscope are a dull, dark brownish red and a bright red. The stones appeared inert when exposed to both long-wave and short-wave ultraviolet radiation.

Although one of the authors had previously examined tourmalines found as inclusions in Zambian emeralds (Koivula, 1982), this was our first opportunity to study larger tourmaline crystals from Zambia. X-ray diffraction of the dark orangy brown to black tourmaline inclusions in emerald proved that the inclusions are from the schorl-dravite series. Interestingly, the X-ray diffraction pattern of the red dravite crystals studied in this report closely resembles the dravite pattern obtained from the schorl-dravite inclusions found in the Zambian emeralds.

None of the studies published to date on the dravite from Kenya reported on the inclusions in this material; even so, we decided to examine the Zambian crystals under magnification to study any associated minerals that might be found adhering to the crystals, and to see if any inclusions could be resolved. Two of the crystal fragments have small white to pale brown patches of an associated mineral on them. The X-ray diffraction pattern obtained from a powder sample of this mineral matches that of talc. One of the two specimens with this talc also has a colorless crystalline material attached to one end; X-ray diffraction proved this mineral to be quartz. The largest crystal fragment contains two-phase inclusions. The fourth piece has no associated minerals or inclusions visible at 50× or lower magnification. The best terminated crystal, shown in figure 1, contains inclusions of what appear to be tourma-

Figure 2. Diagram of the absorption spectrum shown by the tourmaline crystal illustrated in figure 1.

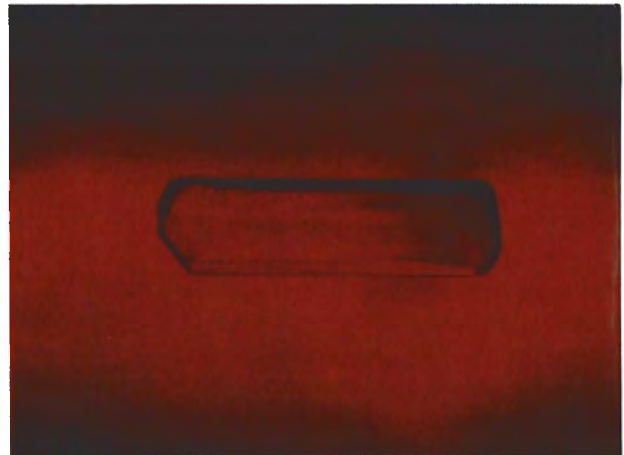
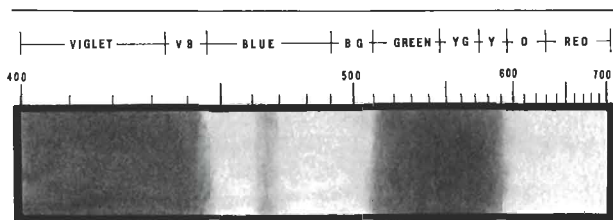

Figure 3. An inclusion of tourmaline in the tourmaline shown in figure 1. Even with shadowing, the relief is quite low. Magnified 50×.

line as well as a small grouping of very fine acicular inclusions. We decided to polish a window in this crystal so that we could study these inclusions more closely.

First, we observed included euhedral crystals of a hemimorphic form that appeared to have very low relief, which indicates a refractive index very close to the host tourmaline. The most easily visible of these inclusions is shown in figure 3. The crystal habit (hemimorphic terminations) together with the low relief serve to identify these inclusions as tourmaline. Also scattered throughout the host, isolated and in groups, are very short, extremely fine, acicular inclusions of high relief (figure 4). These inclusions remain unidentified, although they may be fibrous talc. Phantom growth zones that trace the developmental stages of the host were also observed throughout the crystal, although they could be seen only at certain angles.

ABOUT THE AUTHORS

Mr. Koivula is senior gemologist, and Mr. Fryer is chief gemologist, in the Applied Gemology Department of the Gemological Institute of America, Santa Monica, California.

Acknowledgments: The authors would like to thank Julius Petsch for donating the tourmalines used in this study, and Dr. Peter Keller for helping arrange the donation. Thanks also go to William Kerr for polishing the flats on one of the crystals for the refractive index and inclusion studies. Chemical analysis was provided by Dr. George Rossman and Stephanie Mattson of the California Institute of Technology, Pasadena, California.

©1985 Gemological Institute of America

CHEMISTRY

After detailed gemological examination and X-ray diffraction were completed, the tourmalines were given to Dr. George Rossman, of the California Institute of Technology, for chemical analysis on the electron microprobe. Dr. Rossman had previously analyzed the tourmaline from Kenya, and his analyses agree with those previously reported in the gemological literature (Bank, 1974; Dunn et al., 1975). His findings on the Zambian tourmaline are very similar to the previous analyses on the Kenyan dravites. Table 1 compares the chemical compositions of the Kenyan and Zambian dravites.

CONCLUSION

All of the physical and optical properties of this Zambian tourmaline indicate that it is very simi-



Figure 4. A small group of extremely fine acicular inclusions found in the crystal shown in figure 1. Transmitted light, magnified 50 \times .

TABLE 1. Partial chemical comparison (in wt.%) of dravite from Kenya^a and Zambia.^b

Location	Element										
	K ₂ O	Na ₂ O	CaO	MgO	MnO	FeO	TiO ₂	SiO ₂	Al ₂ O ₃	Cr ₂ O ₃	V ₂ O ₃
Kenya	0.06	2.7	0.06	9.4	0.03	4.4	0.3	37.9	31.1	* ^c	* ^c
Zambia	0.02	2.3	0.14	10.0	0.05	2.1	0.2	36.7	33.9	** ^d	** ^d

^aAs provided by Dunn et al., 1975.

^bElectron microprobe analysis of one specimen by George Rossman, of the California Institute of Technology.

^cData not included in the analysis.

^dBelow the detection limit (0.02%).

lar to a rare type of gem-quality red dravite previously found only in one small locality in Kenya. This similarity suggests that a common geologic origin exists between these two areas even though they are a thousand kilometers apart. The localities are situated at opposite ends of the East African Mozambique belt. In studying the general geology of eastern Africa, it becomes apparent that these two areas are linked by a system of major faults known as the Great Rift System, extending as far north as Ethiopia and as far south as Zimbabwe (Derry, 1980). The fact that both types of tourmalines are so rare and yet so similar, in conjunction with the geologic evidence available, suggests that perhaps the Kenyan and Zambian dravites were generated by the same geologic event. If so, similar areas of mineralization might exist along the entire length of the fault system.

The discovery of gem-quality tourmalines in Zambia is gemologically exciting. If this new source for red dravite should produce even larger cuttable pieces of rough, another unusual and beautiful color of tourmaline could appear in the world's gem markets.

REFERENCES

- Bank H. (1974) Rote Turmaline mit hoher Licht—und Doppelbrechung aus Kenya. *Zeitschrift der Deutschen Gemmologischen Gesellschaft*, Vol. 23, No. 2, pp. 89–92.
- Derry D. (1980) *World Atlas of Geology and Mineral Deposits*. John Wiley and Sons, New York, NY.
- Dunn P.J., Arem J.E., Saul J. (1975) Red dravite from Kenya. *Journal of Gemmology*, Vol. 14, No. 8, pp. 386–387.
- Koivula J.I. (1982) Tourmaline as an inclusion in Zambian emeralds. *Gems & Gemology*, Vol. 18, No. 4, pp. 225–227.

Gem Trade LAB NOTES

EDITOR

C. W. Fryer
GIA, Santa Monica

CONTRIBUTING EDITORS

Robert Crowningshield
Gem Trade Laboratory, New York
Karin N. Hurwit
Gem Trade Laboratory, Los Angeles
Robert E. Kane
Gem Trade Laboratory, Los Angeles

AMETHYST, Heat Treated

The fact that the color of some amethyst is unstable to prolonged exposure to sunlight is well known to amethyst miners. Amethyst rough waiting for shipment to cutting factories is frequently shielded from the heat and ultraviolet rays of the sun. Moreover, the color of some amethyst may also be unstable to other sources of heat, such as that produced by a jeweler's repair torch. Using this potential color instability to their advantage, some amethyst dealers occasionally subject very dark faceted amethysts to heat treatment in order to lighten the color. In Brazil, as well as in other world gem centers, it is reportedly a common practice to place dark amethysts in a test tube and heat them over an alcohol flame for several minutes (see figure 1).

The heat treatment of amethyst may cause various other color changes, depending on such variables as the locality of origin, the chemical composition of the amethyst, the temperature of the heat treatment, and the length of exposure to such treatment. Besides lightening the tone of the purple, heat treating amethyst may change the color to green (see *Gems & Gemology*, Summer 1983, p. 116), reddish brown (*Gems & Gemology*, Winter 1983, p. 236), near-colorless, or other hues of yellow and brown.

Editor's note: The initials at the end of each item identify the contributing editor who provided that item.

©1985 Gemological Institute of America



Figure 1. Amethyst being heated over an alcohol flame to lighten.

The Los Angeles laboratory recently had the opportunity to examine the 55.65-ct faceted quartz shown in figure 2. The owner of the stone explained that after faceting, his dark but otherwise attractive amethyst had been subjected to heat treatment in an attempt to lighten the color. The large amethyst was inadvertently left in the furnace for an extended period of time (the client did not indicate the precise amount), resulting in a complete change of the purple amethyst color to a brownish yellow citrine color. Instead of increasing the value of the stone by lightening it, the unsuccessful attempt to lighten the color by heat treatment produced a citrine worth considerably less than the original amethyst. R.K.

Figure 2. A dark 55.65-ct amethyst was altered to this brownish yellow citrine by an unsuccessful attempt to lighten the original color.



GARNET

Almandite, Exhibiting both Chatoyancy and Asterism

The Los Angeles laboratory recently identified a 7.49-ct garnet that displayed an unusual phenomenon. The gemological properties of the stone were typical of a star garnet: a 1.76 spot refractive index, inert reaction to long- and short-wave ultraviolet radiation, and the strong absorption spectrum of almandite garnet. Besides the inclusions causing the phenomenon, some other typical garnet inclusions were observed as well. The unusual characteristic of this stone was the orientation of the apex of the cabochon to the inclusions causing the phenomenon. Although the cabochon was cut so that a cat's-eye was seen on the apex of the stone (as shown in figure 3), a star effect was visible when the cabochon was viewed from its end (see figure 4). If

Figure 3. The apex of this 7.49-ct almandite garnet displays a prominent cat's-eye.

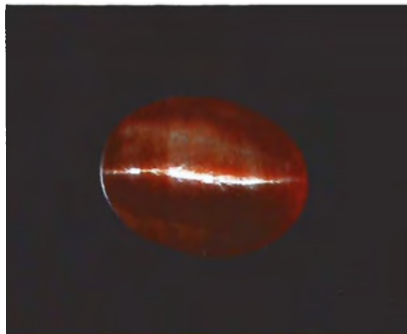
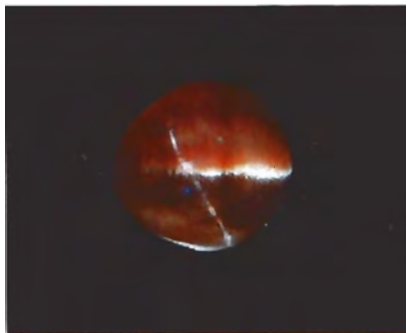

Figure 4. Asterism is visible when the stone in figure 3 is examined on its end.



the cabochon had been oriented so that the asterism was evident on the apex, it would have been considered a star garnet. R.K.

Massive Grossularite Carving

An intriguing carving of two dragons holding a ball (7 × 6 × 2 cm) was sent to the Los Angeles laboratory for identification. The carving, shown in figure 5, was predominantly semitranslucent and mottled green in color, but had an opaque, dark gray area on the back. Although only a limited number of gemological tests could be performed on the massive material, the results allowed us to make a preliminary determination of its identity.

We were able to obtain a refractive index reading of 1.72 on the

fairly well polished base. The specific gravity was estimated with heavy liquids to be approximately 3.5, since the carving sank moderately fast in methylene iodide (S.G. 3.32). These properties, along with the appearance of the main green portion, indicated translucent green grossularite garnet. Because this type of garnet shows a characteristic yellowish orange fluorescence to X-radiation, we tested the carving in an X-ray fluorescence unit. A faint orangy glow was observed in the translucent green area. Lastly, X-ray diffraction performed on a small scraping taken from the green portion of the carving confirmed that the material was grossularite garnet. Massive grossularite garnet of this size is extremely rare. K.H.

Figure 5. Grossularite garnet carving measuring 7 × 6 × 2 cm.



PEARLS

Damaged Mabe

Assembled cultured blister pearls, known as Mabe pearls, are composed of three or four pieces: a thin nacre blister pearl top and a wax-type filler (with or without a mother-of-pearl bead) cemented to a mother-of-pearl base (see figures 6 and 7). The combination of what in some cases is an extremely thin nacre top and the soft wax-like filler does not always make for a very durable product.

The Los Angeles laboratory had the opportunity to examine the damaged Mabe pearl illustrated in figure 8. Our client had purchased this pendant believing that it was set with a cultured pearl. However, when the pearl became damaged, our client was surprised to learn that it was in fact a Mabe pearl. Jewelry manufacturers and buyers alike should be aware of the fragile nature of Mabe pearls. The recently introduced cultured 3/4 blister pearls should provide a much more durable product (see *Gems & Gemology*, Spring 1982, p. 38). R.K.

Pearl Simulants, Shell Hinges

At one time, a number of items of jewelry appeared in the New York market advertised as being set with "French River Pearls." More recently, some items have been fraudulently sold as baroque freshwater pearls. Certain species of both fresh- and saltwater bivalve mollusks have hinges that, when carefully sawed out, have been used to create these inexpensive pearl substitutes. Figure 9 illustrates two worked saltwater hinges from the same valve. The worked backs and characteristic shape are strong clues to their identity.

We were recently provided with complete shells of one rare mussel that has large nacreous hinges. The right hinge protuberance actually forms a better pearl substitute than the double left hinge. These shell hinges have occasionally been offered as "hinge pearls"—a misnomer

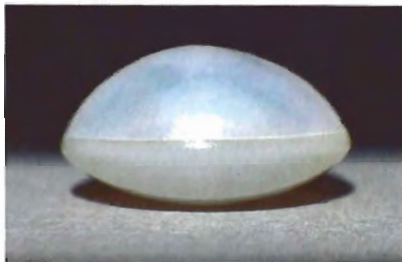

Figure 6. Profile of a Mabe pearl showing nacre shell cemented to a mother-of-pearl base.

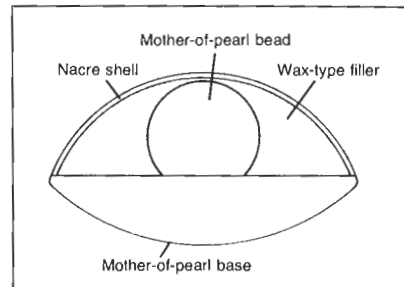

Figure 7. Diagram showing the construction of a Mabe pearl.

since that term has traditionally been used for elongated sac pearls found growing near the hinge. Figure 10 shows the left valve, with its double hinge, of a mussel (a member

of the *Lampsilis* group, *Unio* family) known as the "thick mucket." Figure 11 shows a right hinge that has been worked to resemble a baroque pearl. R.C.



Figure 8. A damaged Mabe pearl (approximately 14 mm) with a very thin nacre shell over a wax-type filler.

QUARTZ, Multi-Star

The New York lab recently had the opportunity to examine a very unusual large (approximately 25 mm) blue-gray, multi-star quartz from eastern Alabama. We also received a gift of several preforms of the same material for our collection. When the stone is viewed in the direction of the optic axis, it exhibits a 12-ray star (figure 12). Figure 13 shows that the same stone has secondary stars as well, a phenomenon that until now had only been known to occur in quartz from Sri Lanka (see *Gems & Gemology*, Summer 1984, pp. 110-111). Whether the asterism is

Figure 9. These right and left hinges from one valve of a saltwater pearl-producing mollusk have been worked to resemble baroque pearls.



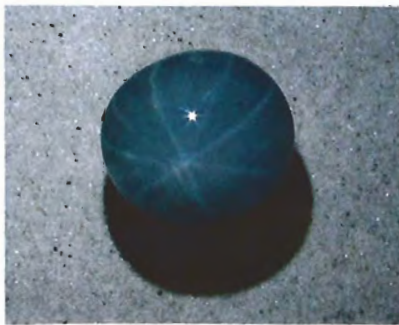

Figure 10. The double hinge from the left valve of a pearl-producing mollusk.



Figure 11. The right hinge (approximately 20 mm) of a mollusk similar to that shown in figure 10 has been worked to resemble a baroque pearl.

Figure 12. A 12-ray star is evident in this approximately 25-mm quartz cabochon from Alabama.



due to sillimanite, as is the case with the star quartzes from Sri Lanka, is unknown. In addition to the inclusions causing the asterism, several of the preforms contained coarse, un-oriented, blade- or needle-like inclusions that resemble rutile. R.C.

RUBY, with Unusual Inclusions

Recently in the New York lab we have noted several natural rubies with unique inclusions. One ruby in particular exhibited an irregular plane with numerous bubble-like inclusions that, at first glance, resembled the gas bubbles in a

Figure 13. Secondary multiple stars are visible in the star quartz shown in figure 12 when it is viewed from a different orientation.

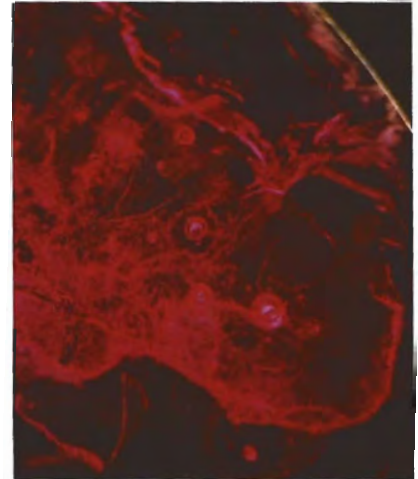
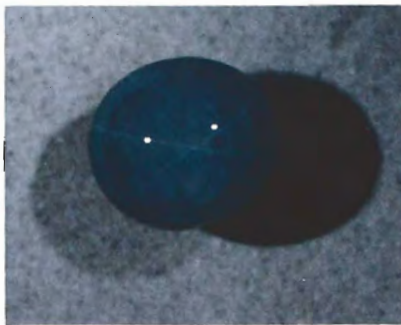

Figure 14. These negative crystals included in ruby are typical of stones of Thai origin, although at first glance they were thought to resemble the gas bubbles often seen in glass-filled cavities. Magnified 15x.

glass-filled ruby. However, on closer inspection, the triangular "faces" visible in the larger "bubbles" (figure 14) indicated that the inclusions were negative crystals typical of Thai rubies. R.C.

SAPPHIRE Simulant, Synthetic Green Spinel and Synthetic Blue Sapphire Doublet

The Los Angeles laboratory received for identification the 6.73-ct dark blue oval mixed cut shown in figure 15. Examination of the stone with the microscope revealed a separation plane at the girdle with flattened gas bubbles and an irregular waxy contact zone parallel to the table. We frequently encounter blue sapphire simulants in the form of doublets consisting of a natural green sapphire crown and a synthetic blue sapphire pavilion. However, when examining this stone with the microscope, we also observed in the crown an irregular cluster of gas bubbles, typical of those formed in some synthetic spinels. Further testing proved that this particular stone consisted of a

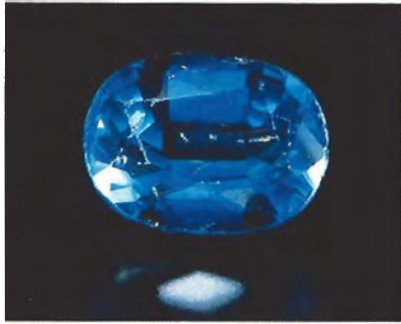

Figure 15. A 6.73-ct assembled stone with a synthetic green spinel crown and a Verneuil synthetic blue sapphire pavilion.

synthetic green spinel crown and a Verneuil synthetic blue sapphire pavilion. Table 1 summarizes the characteristics observed in both portions of this doublet.

Closer examination with the microscope using dark-field illumination, fiber-optic illumination, and immersion in methylene iodide failed to reveal the type of cement layer that is typical of most assembled stones. It is unlikely that the two materials were fused together by heat because of the very high melting temperatures of synthetic spinel (2135°C) and synthetic sapphire

(2050°C). Therefore, this stone was probably assembled with a type of cyanoacrylate cement layer that is commonly marketed under several different trade names, including Krazy Glue and Super Glue.

This is the first assembled stone consisting of a synthetic green spinel crown and a Verneuil synthetic blue sapphire pavilion that we have encountered, although the New York Gem Trade Laboratory reported in

the Winter 1984 issue of *Gems & Gemology* on a large doublet that consisted of a colorless synthetic spinel crown cemented to a Verneuil synthetic ruby pavilion. R.K.

TURQUOISE Simulant, Dyed Magnesite

Recently sent to the Los Angeles laboratory was the single-strand neck-

Figure 16. Dyed magnesite beads (10 mm in diameter) were used to simulate turquoise in this necklace.

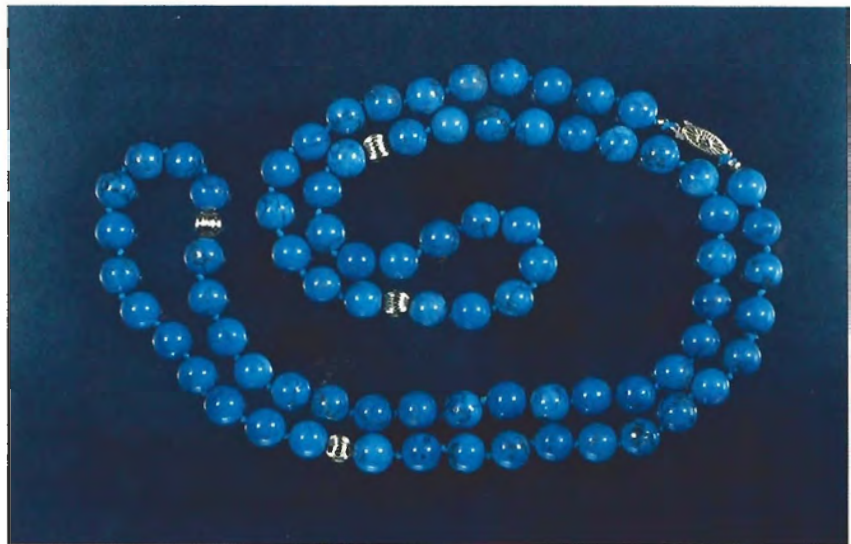

TABLE 1. Gemological characteristics of a synthetic spinel and Verneuil synthetic sapphire doublet.

Material and area tested	R.I.	Luminescence			Absorption spectrum ^a (400nm–700nm)	Magnification
		Long-wave U.V. radiation	Short-wave U.V. radiation	X-rays		
Synthetic green spinel crown	1.728	Moderate chalky red	Strong chalky whitish green	None visible	No bands or lines	Various sizes of spherical and thread-like "gas bubbles." One large cluster of intertwined irregular "thread-like" gas bubbles.
Synthetic blue sapphire pavilion	$\epsilon = 1.760$ $\omega = 1.768$	Inert	Weak chalky whitish blue	Patchy moderate chalky orange; no phosphorescence	No bands or lines	Prominent curved color banding; flattened circular gas bubbles at the separation plane; numerous parallel and randomly oriented fractures of various shapes extending from the separation plane slightly into the synthetic sapphire. Irregular, melted-appearing contact zone visible only from the pavilion.

^aThe visible-light absorption spectrum as observed through a normal "hand-held" type of gemological spectroscopy.

lace shown in figure 16, which consisted of 78 uniform, opaque, blue round drilled beads averaging approximately 10 mm in diameter. Also submitted were two loose beads from the same lot that was used to make the necklace. All of these blue beads had been sold as untreated turquoise. However, damage to one of these beads had revealed that the blue color was confined to an area near the surface (figure 17), so our client asked the laboratory to identify the material. When the broken surface of the bead was examined with the unaided eye or with magnification, it was obvious that the bead was made from a heavily dyed, porous material. The structural appearance of the bead's broken portion (the existence of both white and colorless areas) suggested the possibility that the bead consisted of two different minerals, and the overall appearance and lack of color in the center portion indicated that the bead was not made of turquoise, or even dyed turquoise.

After receiving permission from the client, we polished a portion of the broken bead to test for the refractive index; readings of approximately 1.51 and 1.70 were obtained. The extremely high birefringence

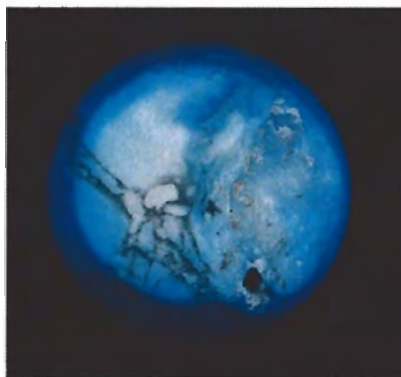

Figure 17. Note the penetration of the dye in this polished cross section of one of the beads shown in figure 16.

(0.19) suggested a carbonate. Magnesite, calcite, and dolomite are all substances that, when they occur in massive form, are soft and porous; all three materials have been known to be dyed blue for use as turquoise substitutes. However, a specific gravity measurement of approximately 3.0 obtained by the hydrostatic method was too high for calcite (2.71) or dolomite (2.85). Additional testing revealed that the bead was inert when exposed to X-rays or long-wave ultraviolet radi-

ation (366 nm). However, when exposed to short-wave ultraviolet radiation (254 nm), the dyed portion of the bead remained inert but the undyed center exhibited a weak dull violet fluorescence.

When a drop of room-temperature 10% hydrochloric acid (HCl) solution was placed on the undyed portion of the magnesite, no reaction was observed. If the acid is slightly warmed, however, the magnesite will effervesce; this is typical of magnesite. When the dyed portion was rubbed with a cotton swab soaked in either acetone or a 10% hydrochloric acid solution, none of the dye could be removed. Using hardness points, we estimated the hardness to be approximately 4½ on the Mohs scale. X-ray diffraction analysis performed on both the white and the colorless portions of this bead confirmed that it was magnesite. R.K.

PHOTO CREDITS

Shane McClure took the photos in figures 1-5, 9-11, and 15-17. Tino Hammid is responsible for figures 6 and 8. Ricardo Cardenas supplied figures 12-14. Susan Kingsbury did the artwork for figure 7.

A SPECIAL Offer from GEMS & GEMOLOGY

All 1982-1983-1984 issues plus File Case for only \$55.00

Are your back issues of *Gems & Gemology* all dog-eared? Have a few been taken by well-meaning friends? Do you only get to see the office copy—and that you share with six other people? For those of you that want a complete set, in mint condition, of the most recent issues of *Gems & Gemology* for your own bookshelf (or to give to one of those well-meaning friends), we are offering a special package of all 12 issues—three full volumes—from 1982, 1983, and 1984 plus a custom gold-embossed file case for only \$55.00 (\$60.00 outside the U.S.). Almost 800 pages (with 600 color photos) of the most important articles, lab information, and news items in gemology today.

Individual volumes (four issues each) for

1982, 1983, and 1984 are also available for only \$19.50 (\$22.50 outside the U.S.). And single back issues can be purchased for \$6.00 each (\$8.00 outside the U.S.). File cases are available separately for \$11.95 (\$13.95 outside the U.S.).

Supplies are limited, so please send your check or money order (all prices include shipping) **now** with a note indicating "special three-volume package" or the individual volumes or issues you wish to receive to:

GEMS & GEMOLOGY
1660 Stewart St.
Santa Monica, CA 90404

Or call TOLL-FREE 800-421-7250 (in CA, AK, HI, and outside the U.S., call 213-829-2991, ext. 389).

GEMOLOGICAL ABSTRACTS

Dona M. Dirlam, Editor

REVIEW BOARD

William E. Boyajian
GIA, Santa Monica
Jeffrey M. Burbank
GIA, Santa Monica
Stephanie L. Dillon
San Clemente, California
Bob F. Effler
GIA, Santa Monica
Joseph O. Gill
Gill & Shortell Ltd., San Francisco
Fred L. Gray
Richter's, Georgia
Mahinda Gunawardene
Idar-Oberstein, Germany

Gary S. Hill
GIA, Santa Monica
Steve C. Hofer
Kensington, Connecticut
Karin N. Hurwit
Gem Trade Lab, Inc., Los Angeles
Robert C. Kammerling
GIA, Santa Monica
Neil Letson
Palm Beach, Florida
Shane F. McClure
Gem Trade Lab., Inc., Los Angeles
Elise B. Misiowski
GIA, Santa Monica

Michael P. Roach
Andin International, New York
Gary A. Roskin
GIA, Santa Monica
James E. Shigley
GIA, Santa Monica
Franceye Smith
GIA, Santa Monica
Carol M. Stockton
GIA, Santa Monica
Sally A. Thomas
GIA, Santa Monica
Jill M. Walker
GIA, Santa Monica

COLORED STONES

Chrysoberyl from Anakie, Queensland. R. Brightman, *Australian Gemmologist*, Vol. 15, No. 7, 1984, pp. 241–242.

The gemological properties of a transparent chrysoberyl discovered in a parcel of yellow-green sapphires from Anakie, Queensland, are described in this article: R.I.— $\alpha=1.756$, $\beta=1.761$, $\gamma=1.768$; birefringence—0.012; optic character—B+; pleochroism—indistinct yellowish green and greenish yellow; S.G.—3.74; spectrum—strong, broad band from 425 to 458 nm; SWUV and LWUV fluorescence—inert; Chelsea and Sterek filter reactions—inert; magnification—large fingerprint, several partially healed fractures; and three or four rod-like crystals.

This section is designed to provide as complete a record as possible of the recent literature on gems and gemology. Articles are selected for abstracting solely at the discretion of the section editor and her reviewers, and space limitations may require that we include only those articles that will be of greatest interest to our readership.

Inquiries for reprints of articles abstracted must be addressed to the author or publisher of the original material.

The reviewer of each article is identified by his or her initials at the end of each abstract. Guest reviewers are identified by their full names.

© 1985 Gemological Institute of America

The author points out that great care must be taken when determining the values on the refractometer and observing the spectrum; otherwise, the chrysoberyl could be mistaken for a yellow-green Australian sapphire, which it closely resembles. RCK

Grüne Sphalerite aus Zaire (Green sphalerite from Zaire). C. Hofmann and U. Henn, *Zeitschrift der Deutschen Gemmologischen Gesellschaft*, Vol. 33, No. 1/2, 1984, pp. 72–74.

Although allochromatic sphalerite is a colorless cubic mineral in its purest state, yellow, reddish, and green colors may be caused, respectively, by the following trace constituents: Ge, Ca, Cu, Hg and Ce; Sn, Ag and Mo; and Co and Fe. The remarkable dark green material from Kipushi, Zaire, that is described in this article reveals higher amounts of Co (740–890 ppm) and Fe (620–800 ppm), according to neutron activation and microprobe analyses. The sample described in this paper has an absorption maximum at 670 nm in its optical spectrum that is attributed to a ${}^4A_2 \longrightarrow {}^4T_1(P)$ transition of Co^{2+} in the tetrahedral crystal field of sphalerite. MG

The hydrous component in garnets: pyralspites. R. D. Aines and G. R. Rossman, *American Mineralogist*, Vol. 69, No. 11/12, 1984, pp. 1116–1126.

The hydrous component of natural pyralspite garnets was determined primarily by infrared spectrometry in

this study of 75 gem-quality specimens. Concentrations of H₂O were found to range from 0.01 to 0.25 wt.%, but the infrared spectra also indicated that the hydrous component occurs primarily as H₄O₄⁴⁻ in the tetrahedral site, or as other substitutions that involve multiple OH⁻ groups, rather than as molecular H₂O. Spessartines and spessartine-almandines from igneous pegmatites were found to be the most hydrous of the pyralspites studied. The low level of this hydrous component in pyralspite garnets has minimal effect on this stone's gemological properties, unlike the more extensive hydrogarnet substitution that occurs with grossulars.

CMS

Mineral inclusions in Zambian emeralds. J. I. Koivula, *Australian Gemmologist*, Vol. 15, No. 7, 1984, pp. 235–239.

The author reports on his investigation of four emeralds from the biotite-phlogopite schist deposits of Miku-Kafubu, Zambia. Detailed descriptions of inclusions are provided. These include tourmaline (in all specimens) in the form of dark brown prisms of dravite up to 10 mm in length and 2 mm in diameter. These are striated lengthwise in the c-axis direction and surrounded by numerous tension fractures, some of which are limonite-stained. Also noted are magnetite grains, both singly and in groups; biotite and phlogopite mica, as very thin platelets and as thicker booklets (the most common inclusion noted); orange-red elongated prisms of rutile, commonly striated parallel to the c-axis; metallic-appearing crystals of hematite; and short hexagonal prisms of near-colorless apatite (possibly fluorapatite).

Gemological properties were noted as follows: bluish green color, medium to dark tone; R.I. of 1.581–1.588; birefringence of 0.007; U– optic character; S.G. of 2.71 and 2.82 for two specimens tested (the latter highly included with tourmaline and other minerals); inert to long-wave and short-wave radiation; and spectra that exhibit 479, 610, 638, and 670 nm lines plus 682 and 580–610 nm bands in the c-axis direction, and 638, 650, 670, and 690 nm lines at 90° to the c-axis.

A referenced listing of all inclusions noted to date in Zambian emeralds is provided. Mr. Koivula notes that the inclusions in the Zambian emeralds are similar in many respects to those reported for emeralds from other schist-type deposits, which suggests very similar stages of geologic genesis at all such localities. The article contains seven exceptional photomicrographs. RCK

Report on the investigation of an emerald from the Kitwe District, Zambia. G. Graziani, E. Gübelin and S. Lucchesi, *Australian Gemmologist*, Vol. 15, No. 7, 1984, pp. 227–234.

The authors report on their thorough investigation of a single transparent emerald from the Kitwe mining area of Zambia. This specimen was determined to have a refractive index of 1.580 (+0.004)–1.586 (+0.003), a

birefringence of 0.006, and a specific gravity of 2.794 ± 0.006 g/cm³. X-ray powder diffraction revealed unit cell parameters of $a = 0.9209 \pm 0.003$ nm, $c = 0.9194 \pm 0.004$ nm, $a/c = 0.998$, and $V = 2.0258 \pm 0.0004$ nm³. Electron microprobe analyses revealed relatively high FeO and MgO contents for beryl from this area and a low alkali content. The amount of chromium (0.08%) was also quite low compared to emeralds from the Miku District in Zambia.

A number of inclusions were identified: reddish brown prisms of rutile, transparent colorless crystals of chrysoberyl, flakes of muscovite and margarite mica, tiny acicular crystals of apatite (that occur parallel to the c-axis), and quartz crystals. Other crystals were tentatively identified as hydroxylapatite. The contents of partially healed fractures were also analyzed and determined to contain beryl crystals, iron oxide scales (hematite or goethite), and rutile crystals.

On the basis of the chromium content and the distribution of inclusions throughout the stone, the authors conclude that the emerald formed in a stratum associated with sericitic schists. The morphology and distribution of inclusions suggest metamorphic formation, while pressure-temperature parameters indicate medium grade metamorphism. The partially healed fractures suggest sudden temperature or pressure variations during growth. RCK

Zusammensetzung, Eigenschaften und Herkunft eines neuen Hämatitmaterials (Composition, characteristics and origin of a new type of hematite). K. Schmetzer and H. Bank, *Zeitschrift der Deutschen Gemmologischen Gesellschaft*, Vol. 33, No. 1/2, 1984, pp. 75–78.

The authors compare the chemical and physical characteristics of hematite with a similar, new material reported to be of Brazilian origin. The new "hematite" from Brazil has a higher Fe (69%) content and is composed primarily of magnetite, martite, and gangue minerals. However, the red streak characteristic of hematite is absent in the new material, which shows a dark brownish streak. This granular material is known in the trade as "high grade hematite" and is said to originate from the Quadrilatero Ferrifaro area near Ouro Preto, Minas Gerais, Brazil. This material has also been reported in *Gems & Gemology* (Vol. 20, No. 1, pp. 46–47). MG

A terrestrial source of ureyite. C. M. O. Yang, *American Mineralogist*, Vol. 69, No. 11/12, 1984, pp. 1180–1183.

The terrestrial occurrence of ureyite in maw-sit-sit from Burma is fully documented and characterized for the first time in this article. Ureyite (also known as cosmochlore, in various spellings) was previously known only as a constituent of meteorites. The author also identified chromite, jadeite, albite, and two amphiboles

as accessory components of the maw-sit-sit specimens examined, which range from 50%–95% ureyite.

The author rather disconcertingly refers to maw-sit-sit as jade, but jadeite ($\text{NaAlSi}_2\text{O}_6$) and ureyite ($\text{NaCrSi}_2\text{O}_6$) are both sodium pyroxenes (sometimes referred to as the "jadeite group") and form a solid-solution series. Ureyite is very deep green in color, with refractive indices of 1.722, 1.734, and 1.745; specific gravity of about 3.51–3.52; and occurs as a fine-grained fibrous aggregate intergrown with its accompanying minerals. Chemical, diffraction, and Mössbauer data are also provided.

This terrestrial occurrence of another solid-solution series that involves jadeite may complicate the identification of that gem material even further. Gemologists should be aware of this potential problem. CMS

DIAMONDS

Diamondiferous lamproites. B. H. Scott Smith and E. M. W. Skinner, *Journal of Geology*, Vol. 92, 1984, pp. 433–438.

The traditional view of kimberlites as the sole source of diamonds is now being challenged by recent discoveries of a new type of primary diamond occurrence. Several newly discovered diamond deposits, notably those in Western Australia, have been classified as kimberlites by some miners, but the authors of this article suggest that they should more correctly be classified as a different rock type known as lamproite. Lamproites are dark, potassium- and magnesium-rich volcanic rocks with a texture that consists of large crystals set in a finer-grained matrix. Prominent mineral constituents of lamproites include leucite, phlogopite, diopside, richterite, olivine, and sanidine feldspar. Other minerals that may be present are perovskite, apatite, spinel, and other phases. Glass may also be an important constituent in some instances. Lamproites display a wider range of mineralogical and textural variations than do kimberlites.

In addition to their chemical, mineralogical, and petrologic differences from kimberlites, lamproites have a different mode of occurrence. Kimberlites are typically found as narrow, breccia-filled volcanic pipes that extend to depths greater than 2 km. While lamproites also occur as volcanic pipes, they are much shallower (only several hundred meters in depth) and have a very different vertical cross section that consists of a large, irregular crater filled primarily with pyroclastic material and solidified magma. Occurrences of diamond-bearing lamproites include volcanic pipes in the Prairie Creek region of Arkansas and the recently discovered Argyle deposit in the Kimberley area of Western Australia. Summary information on both occurrences is provided. The authors conclude that lamproites may carry significant quantities of diamonds, but possible differences in the nature of the diamonds from these two source rocks have yet to be described in detail. JES

Kimberlite redefined. C. R. Clement, E. M. W. Skinner and B. H. Scott Smith, *Journal of Geology*, Vol. 92, 1984, pp. 223–228.

The term *kimberlite* was originally introduced into the geologic literature in the late 1800s to describe the host rock of diamond at Kimberley, South Africa. Since that time, numerous attempts have been made to establish sound criteria for the recognition and classification of kimberlites at other localities, and have resulted in many proposed definitions of this rock type.

Unfortunately, according to the authors, the diversity of opinions on the nature of kimberlites has had some unfortunate consequences with respect to an accurate overall definition. Some definitions are too narrow and fail to indicate the wide petrographic range exhibited by kimberlites. Others are too ambiguous and thereby allow the term *kimberlite* to include many rock types that should be placed within the framework of other petrologic classification schemes. Incorrect identification of kimberlite, based in part on these faulty definitions, has resulted in some unwarranted geologic implications with regard to the nature of kimberlites.

In this article, the authors propose an alternative, and hopefully more consistent and more practical, definition of kimberlite. The new definition is based on both a review of the relevant geologic literature and detailed field observations at several hundred kimberlite occurrences. According to this study, kimberlite is defined as a volatile-rich, potassium-bearing, silica-poor igneous rock that occurs as small volcanic pipes, dikes, and sills. It has a distinctly heterogranular texture that results from the presence of large anhedral crystals set in a finer-grained matrix. The large crystals are olivine and sometimes other minerals such as spinel, ilmenite, garnet, and pyroxene. Prominent constituents of the finer-grained matrix include olivine, serpentine, pyroxene, spinel, perovskite, ilmenite, apatite, montecellite, and calcite. Late-stage deuteric alteration processes that accompany the consolidation of the kimberlite magma (such as serpentization and carbonatization) often affect the large crystals and early-formed matrix minerals. Kimberlites commonly contain upper mantle-derived ultramafic rocks. They may also contain diamonds, but only as a very rare constituent.

The article concludes with a discussion of the details of this revised definition that compares and contrasts it to earlier definitions. JES

GEM LOCALITIES

The Jensen Quarry, Riverside County, California. F. DeVito, A. Ordway, Jr., *Mineralogical Record*, Vol. 15, No. 5, 1984, pp. 273–290.

In the introduction, DeVito and Ordway contend that the Jensen Quarry is one of the most underrated mineral localities in the U.S., despite the fact that it has produced excellent tourmaline specimens. The Jensen

Quarry was mined for cement-grade marble and dolomitic marble for roofing granules, but was closed in 1979 when the last of the high-quality cement-grade marble was removed.

The quarry is located in the Jurupa Mountains about 72 km east of Los Angeles. The range consists of Paleozoic gneisses, schists, marbles, and quartzites which have been intruded by Cretaceous rocks that range from gabbros to granodiorites. Pegmatite dikes are abundant throughout the crystalline rocks. The mineral-producing areas of the quarry are in the pegmatites, along the marble contacts with tonalite and pegmatite, and in the marble body itself.

The authors describe the occurrence of the major minerals found in the quarry. A table of almost 90 minerals found in the Jensen quarry (including gems such as beryl, garnet, and tourmaline) gives brief descriptions, references, and best locations of the minerals. *GSH*

Pektolith aus der Dominikanischen Republik (Pectolite from the Dominican Republic). K. Schmetzer, *Zeitschrift der Deutschen Gemmologischen Gesellschaft*, Vol. 33, No. 1/2, 1984, pp. 63–64.

The chemical and physical properties of a bluish white to light blue pectolite from the Dominican Republic are described. This triclinic mineral has the chemical formula $\text{Ca}_2\text{NaH}(\text{SiO}_3)_3$, but the physical constants vary according to the percentages of Fe and Mn incorporated. The refractive indices (measured) vary from n_x 1.592 to 1.610, n_y 1.603 to 1.615, and n_z 1.630 to 1.645 for the three crystal axes. Dr. Schmetzer also gives a birefringence range of 0.032–0.038 and a specific gravity of 2.74–2.90. The compact material is used as an ornamental stone and in cabochon form for jewelry. *MG*

Zur Genese ostafrikanischer Grossularvorkommen (On the origin of the East African grossular occurrence). B. Sarbas, U. Goerg, G. C. Amstutz, K. Schmetzer, and H. Bank, *Zeitschrift der Deutschen Gemmologischen Gesellschaft*, Vol. 33, No. 1/2, 1984, pp. 48–62.

During the last 20 years, many new gemstones have been discovered in the East African gemfields. Most of the finds lie in the "Mozambique belt," a regionally metamorphosed Precambrian rock type that extends from Egypt to Mozambique. From among the well-known gemstones found in this belt, garnet (particularly grossular) and zoisite are examined in detail with respect to their origin.

Petrographic as well as geochemical analyses were done on grossularite and zoisite from Kenya (Lualenyi and Mangari) and Tanzania (Komolo and Merelani). The green and bluish violet colors of grossular garnet and zoisite are caused by vanadium oxide contents of 0.68–3.3 wt.% and about 0.12 wt.%, respectively. These

gem minerals occur extensively in a graphite schist that consists mainly of quartz and potassium. Grossularite is surrounded by two reaction rims, with zoisite, quartz, V-grossular, and an Al_2SiO_5 -phase in the inner rim, and scapolite and V-grossular in the outer rim. This information can be used to derive the metamorphic history of the surrounding schist.

During an early metamorphism in the kyanite-almandine-muscovite subfacies of the amphibolite facies, grossularite, graphite, diopside, and kyanite are said to be formed (550°C, 3–5 kilobars). A later metamorphic action in the sillimanite-muscovite subfacies of the amphibolite facies may lead to the formation of microcline, sillimanite, scapolite, and the outer rim of the garnets (650°C, 3 kilobars). Zoisite formed during a third metamorphic phase. X-ray fluorescence analyses of Cr and V contents give the following results for the graphite schists from Lualenyi: 63 wt.% Fe_2O_3 , 329 ppm Cr, and 1157 ppm V. The results for Komolo were: 65 wt.% Fe_2O_3 , 2716 ppm Cr, and 1763 ppm V. These geochemical data clearly reveal that the graphite schists from Lualenyi have a higher V content compared to Cr, and those from Komolo have higher Cr concentrations. *MG*

INSTRUMENTS AND TECHNIQUES

Rating the diamond testers. H. Huffer, *Jewelers' Circular-Keystone*, Vol. 155, No. 7, 1984, pp. 90–98.

Helene Huffer reports test results obtained by two jewelers using eight different diamond testers. Each jeweler read all instructions for the various instruments, and then performed the tests according to those instructions. The eight diamond testers were: Ceres CZeckmate, Ceres CZecker, Ceres Diamond Probe, Culti Diamond Selector, Eickhorst Thermolyzer, GIA GEM Duotester, GIA GEM Mini DiamondMaster, and the JSP Security III.

The instruments were tested for the following: ease of positioning the test point on the stone, amount of pressure required for the reading, length of the cable, readability of the results, time period between measurements, appearance to consumer, availability of user recalibration if needed, audible indication of diamond simulant, visual indication of diamond simulant, audible indication of contact with metal, visual indication of contact with metal, adaptability for overseas current, battery operation available, travel container included, and price.

The Ceres CZecker was rated the best and least expensive desk-model unit, while the GIA GEM Mini DiamondMaster was considered the best portable (battery-operated) unit tested. While the data collected are extensive, the fact that only two jewelers tested the instruments should be taken into consideration when evaluating the findings. *JMW*

JEWELRY ARTS

The golden ax of Asante. M. D. McLeod, *Natural History*, Vol. 93, No. 10, 1984, pp. 62–73.

Malcolm D. McLeod presents a fascinating glimpse into the Asante kingdom (modern Ghana) that ruled the interior of Africa's Gold Coast from the 17th century until the British takeover in 1896. The large Asante empire thrived for a number of reasons: a warm tropical climate, fertile land, and an abundance of gold that could be traded for metal, cloth, alcohol, tobacco—and weapons. The Asante also conquered neighboring peoples and sold them into the international slave market, a lucrative business that brought them much wealth.

Amazingly, the Asante empire functioned without the use of the written word. The large, complex political bureaucracy was cemented together by word-of-mouth and an elaborate system of checks and balances. Gold regalia played a pivotal role in Asante culture: A person's status could be immediately identified by the type and amount of golden objects he carried, such as disks, stools, headbands, canes, umbrellas, and decorative swords. Such objects were often carved with scenes that depicted tribal fables full of subtle shades of meaning and double entendres designed to reinforce the status quo. The Asante relied so heavily on objects for communication that the first Englishmen to visit the kingdom compared its material wealth to that found in the fictional *Arabian Nights' Entertainments*.

The British eventually seized Asante in 1896 and exiled its powerful leaders. When the leaders were permitted to return in the 1920s, they found that "the power of writing and of the white man's inflexible written laws" was firmly entrenched. Sadly, today many of the school-educated descendants of the Asante kingdom do not understand the full significance of the impressive, symbolic ornaments of their ancestors. SAT

A life of their own. J. Watts, *Connoisseur*, Vol. 214, No. 872, 1984, pp. 122–125.

Six clear color photographs by Dmitri Kasterine give a good understanding of London jewelry designer Elizabeth Gage's style—bold and inventive with unusual combinations of materials such as 18th-century intaglios with rose quartz beads. This short presentation whets one's appetite for more information about a remarkable artist and businesswoman. FS

Profile: Elizabeth Treskow. *Aurum*, J. Wolters, No. 16, 1983, pp. 18–28.

This article is a profile of the life and accomplishments of Elizabeth Treskow. Born in Germany in 1898, her professional career as a goldsmith, beginning at age 15, spans 70 years.

The author chronicles Treskow's steady progress by listing her awards and accolades. In the early 1920s,

independent of other jewelers, "she took part in the search for mastery of the ancient technique of granulation and obtained her first successful results in 1928." The author goes on to state that the rediscovery of granulation has been wrongly attributed solely to H. A. P. Littledale of England. A footnote at the end of the article offers proof by stating that Elizabeth Treskow and J. M. Wilm were present at Littledale's lecture on the recently rediscovered art of granulation in London in 1936. There, examples of Treskow's and Wilm's work utilizing granulation were exhibited. It is Wolters' belief that Littledale, Treskow, and Wilm reached their results "independently without influencing each other."

Illustrated with many photographs of Ms. Treskow's work and punctuated with passages from her writings, the article gives us insight into the character of this prolific and innovative goldsmith. Examples of Elizabeth Treskow's jewelry, as well as a collection of antique and medieval jewelry assembled by her as specimens for study, can be found in the Kunstgewerbemuseum in Cologne. The author also lists various other museums, cathedrals, and city halls where more of her work is in use or on display. EBM

Robert von Neumann: master metalsmith. C. S. Fisher, *Metalsmith*, Vol. 4, No. 3, 1984, pp. 14–19.

Robert von Neumann entered metalsmithing in the 1940s, when the craft and its craftsmen were almost unknown to art circles or the media. This article shows how von Neumann's professional growth parallels the growth of the craft, and reveals his contribution to the art of metalsmithing as it is known, and appreciated, today.

Von Neumann taught himself the basic metalsmithing techniques, and then went on to receive his BFA from the School of the Art Institute of Chicago. In 1948, as the first candidate in the new Masters program in metals at the University of Wisconsin, he had the distinction of both being enrolled in and teaching several graduate metalsmithing classes.

Metalsmithing helped von Neumann express his love of natural history and mythology. His work in gold and silver won constant international praise and focused media attention on the blossoming art form. In addition, he dedicated much of his energy to teaching and writing, encouraging students to believe in their "self," warning that "the temptation to be influenced by popular fashion and to cash in on the vogue is great, but it is always a 'catch up' game." Von Neumann also advocated the humanities as a source of artistic inspiration: "Jewelry should have humanity. It should enhance, not diminish, the wearer. Unfortunately, there seems to be a current abhorrence for the decorative, the unabashedly delightful . . . Reading folklore, myths of all lands, science fiction—things that stimulate inner vision—can bring humanity back into art." SAT

RETAILING

It's "buyer beware" in a boom market. W. G. Shuster, *Jewelers' Circular-Keystone*, Vol. 155, No. 8, 1984, pp. 268–288.

Mr. Shuster has done a real favor for jewelers. By discussing the problems of choosing jeweler-specific computer software, he points out the major needs that any jeweler *must* examine before shopping for software. Computers are not wonder cures for all the ailments of a store, but they can help solve some problems most jewelers have. As an indication of how fast-moving the industry is and how careful a jeweler must be, some of the firms listed in Shuster's article no longer sell software, only a few months after the article was published.

H. David Morrow

New rules for advertising diamonds. *Canadian Jeweller*, Vol. 105, No. 8, 1984, pp. 32–36.

A set of Canadian "Gemstone Guidelines on Diamonds" was issued by the Federal Department of Consumer and Corporate Affairs. The committee that developed these guidelines represents a cross-section of the Canadian jewelry industry. The guidelines provide uniform terminology and uses of terminology to advertise or market diamonds. Although they are not legally enforceable, stronger regulations to control advertising excesses may result.

The guidelines begin with a definition of diamond, describing its chemical, physical, and optical properties. Diamond terminology is then defined and covers shape, proportion, finish, color, purity, clarity, and weight. Misuses of the word *diamond* and other diamond terminology are described in detail. Highlights of this section are: (1) use of the terms *diamond*, *synthetic diamond*, *imitation diamond*, etc.; (2) use of terms such as *rough diamond* and *diamond chip*; (3) words that describe proportion, cut, and finish; (4) phrases commonly used in the trade or phrases that indicate to a customer that the diamond has some special or unusual characteristics; (5) proper words to describe body color, tint, and color in a diamond (including a definition of the word *fancy*); (6) clarity (*flawless* and *internally flawless* are defined); (7) acceptable and unacceptable terminology to describe clarity; and (8) representation of the weight of the diamond using the metric carat.

These guidelines are similar to those issued by the Federal Trade Commission in the United States and should be filed for future reference by jewelers and appraisers who have Canadian clientele. Marcia Hucker

SYNTHETICS AND SIMULANTS

Is it natural or . . . ? Identifying the new synthetics. P. Read, *Canadian Jeweller*, Vol. 105, No. 8, 1984, pp. 25–26.

Peter Read states that the most useful service that the science of gemology has provided the jewelry industry is

in the identification of synthetic gemstones. He traces the history of synthetic gem identification from the early Verneuil products to the most recent sophisticated corundum synthetics. In doing so, the author discusses the various gemological tests that have been used to identify synthetic gems. He concludes by emphasizing that for the everyday identification of synthetics by the jeweler-gemologist, inclusions remain the key distinguishing features. WEB

Synthetics and other man-made gem materials. G. I. Hemrich, *Gems and Minerals*, No. 563, 1984, pp. 114–125.

Gerald I. Hemrich begins his article with a summary that distinguishes synthetics, imitations, and other man-made gem materials, and adds very interesting information about synthetics in general. There are approximately 30 different man-made materials that are used or have a potential for use as gemstones, not counting the varieties within those materials.

The bulk of the article is devoted to detailing information about individual man-made gemstones. Those discussed are synthetic corundum (ruby and sapphire), synthetic spinel, synthetic beryl (emerald and Morganite), synthetic garnets (YAG and GGG), cubic zirconia, synthetic quartz, and "Victoria stone."

The author concludes by stating that synthetics and other man-made gem materials are here to stay. Given the needs of science and industry, gem and jewelry hobbyists, and amateur lapidaries, as well as the lower prices and greater availability of man-made products when compared to natural gems, he sees no loss of importance in synthetics and other man-made gem materials in the future. WEB

Synthetische Diamanten (Synthetic diamonds). K. Recker, *Zeitschrift der Deutschen Gemmologischen Gesellschaft*, Vol. 33, No. 1/2, 1984, pp. 5–34.

A review of the fundamentals and progress of diamond synthesis processes is provided in this article, including the commercial, scientific, and technical aspects. The basic methods of manufacturing synthetic diamonds (catalyst-solvent process, direct graphite-to-diamond transformation) and the growth of large crystals are discussed. Professor Recker suggests that gemologists should anticipate the mass production of synthetic gem diamonds in the near future. MG

TREATED STONES

Irradiated diamonds: a cure for the coming cape diamond glut? D. Federman, *Modern Jeweler*, Vol. 83, No. 9, 1984, pp. 54–60.

Federman believes that the irradiation and subsequent heat treatment of unattractive light brown and light yellow diamonds to produce green, yellow, orange, blue-green, and blue stones will create a market for the

increasingly large quantities of this material that have become available in recent years. The acceptance of gemstone treatment in general, such as the irradiation and/or heat treatment of topaz, corundum, and aquamarine, seems to indicate that the market is ready to accept diamond irradiation. By improving the image of this practice, the jeweler's need for "affordable" quality colored diamond jewelry could be answered.

Federman reviews the history of diamond bombardment from the 1904 Crookes experiment with radium salts to current electron and neutron treatment. Accompanying charts examine the various types of treatments as well as prices for treated diamonds.

In conclusion, Federman suggests that the market for treated diamonds will not compete with the market for natural fancy colored stones, but rather will offer an alternative to off-color diamonds and other colored gemstones.

Sheryl Stewart

See no evil, speak no evil. C. Kremkow, *Goldsmith*, Vol. 165, No. 4, 1984, pp. 50–55.

Kremkow discusses the controversial "evils" that surround the disclosure of gem treatment. When, what, and how treatment should be disclosed is an ongoing dispute among federal agencies, trade organizations, and colored-stone dealers. There are two main issues. First, are jewelers aware of which stones are treated and, if so, have they been trained to recognize the various methods of treatment? Second, gemstone treatment may or may not be detectable or permanent. If the treatment is detectable, should it be disclosed in all cases, particularly if it is permanent? If treatment is not detectable, but assumed because of the peculiar color it creates, should it be disclosed—in a court case, how would the material be represented?

A special subcommittee of the Jewelers Vigilance Committee has been working on revising the Federal Trade Commission *Guides for the Jewelry Industry*. As of May 22, 1984, the committee recommended that the guidelines be changed as follows: "NOTE: With the exception of diamond, treatment need not be disclosed if either of the following conditions applies: (1) treatment, as of that time, is not detectable by a qualified gemological laboratory, or (2) the results of treatment do not revert under normal wear and display conditions." The final umbrella clause, however, dilutes the impact: "(It is recommended that treatment be disclosed to avoid confusion and liability which could attach from failure to disclose.)"

CIBJO has also outlined a set of definitions and rules for the disclosure of gem treatment. They exclude from their list of gems to be disclosed "the gemstones and ornamental stones . . . which have undergone a permanent irreversible colour transformation by thermal treatment or by effect of acid only: agate (veined agate, carnelian, onyx, green agate, blue agate), beryl (aquama-

rine, morganite), quartz (citrine, prasiolite), topaz (pink topaz), tourmaline (all colours), zoisite (blue tanzanite), and corundum."

Oiled emeralds pose a problem of their own. Does the routine oiling of emeralds with a colorless substance constitute a treatment if the oil does not impart color to the stone, although it helps conceal fractures and cracks?

Overriding all of the above questions is the legal question of whether failing to disclose a treatment can be considered deceptive. Kremkow concludes the article by explaining the tests that are available to detect irradiation, oiling, dye, and diffusion treatment. Kremkow's conclusion is that the ultimate responsibility lies with the jeweler.

JMW

Editor's Note: The JVC committee submitted final revision recommendations to the FTC on October 5, 1984.

MISCELLANEOUS

A new look at Idar-Oberstein. W. D. Hadley, *Rock & Gem*, Vol. 14, No. 10, 1984, pp. 48–51.

Wayne D. Hadley furnishes an excellent overview of Idar-Oberstein in this article. Thought by many to be the hub of the colored-stone cutting industry, Idar-Oberstein certainly carries with its name the traditions of generations of skilled craftsmen in gemstone fashioning and carving.

The author traces the history of gem cutting and carving in this unique community back to the Middle Ages, citing key dates and statistics of gem sources, mining and cutting processes, and foreign influences. He also elaborates on the many sights to see in and around Idar-Oberstein, such as the new Diamond and Gem Exchange and the "Deutsches Edelsteinmuseum" housed within, the Steinkaulenberg stone mine, the reconstructed and preserved grinding mill on the upper Nahe River, the Heimatmuseum (also known as the Museum Idar-Oberstein), and the Church of the Rock.

WEB

Travels by netsuke. R. Bushell, *Arts of Asia*, Vol. 14, No. 2, 1984, pp. 104–109.

The Japanese have traditionally been recognized for their "insatiable" wanderlust and love of adventure. However, during the almost three centuries of the Tokugawa period (1603–1868), the *shoguns* (military governors) prohibited travel outside the country and severely restricted trade. Undaunted, the Japanese traveled throughout their own land, often saving their money for a once-in-a-lifetime trip or pilgrimage. Author Raymond Bushell presents photos and stories of these Japanese travelers as viewed through the *netsuke*, a miniature carving of wood or ivory worn at the kimono sash. These tiny art forms depict many different travelers—some real, some legendary—in minute detail, and reveal many interesting facets of Japanese history and culture during those turbulent times.

SAT

DIAMOND

By Gordon Davies, 255 pp., illus., publ. by Adam Hilger Ltd., Bristol, England, 1984. US\$28.00*

The author's stated purpose is "to present . . . the flavor of man's interest in diamond" and "to describe the properties and uses of diamond." While he succeeds splendidly on the latter goal, the flavor is unavoidably affected by the scientific nature of the work. The reader is made aware at the outset that this is a serious, scholarly, and at times complex book when the author begs the forgiveness of his academic colleagues for "oversimplifying" certain scientific aspects in the interest of readability.

After briefly surveying some historic uses and references to diamond, Davies traces the evolution of theories and experiments which led to the present-day conclusion that diamond is composed of carbon. Throughout the book he leads the reader through all the steps and missteps of scientific investigation. Thus, we come to see not only where we are but how we got here.

Davies does an excellent job of explaining the atomic structure of diamond. He includes a complete account of early experiments in the field of diamond synthesis. One cannot help appreciating a diamond more after having read in this book of the knowledge, frustrating failures, and sheer determination of the people involved in its first successful synthesis. The diamond/graphite stability diagram and modern synthesis is interestingly presented and well illustrated. Exhaustive coverage of the uses of diamond in science and industry is followed by an inclusion study which focuses on chemistry rather than appearance. A final chapter gives an account of world diamond sources and a collage of miscellaneous subjects such as diamond prospecting, distribution, cutting—and even simulants. While this last chapter is too diversified to be very significant, we can read plenty about such subjects elsewhere.

On rare occasions Davies seems a bit too approximate, for example, when describing the Cullinan rough

BOOK REVIEWS

Michael Ross, Editor

as weighing 3,000 ct (vs. 3,106 ct) on page 10, or when describing ". . . ruby which absorbs all but the red part of the spectrum" on page 144. Overall, however, the book is well organized, and the author states himself clearly, giving surprisingly simple analogies to explain what are otherwise complex subjects. A case in point is on page 98, where the growth and final shape of diamond is explained in terms of the sprinkling of sand.

The lightest moments in the book come on page 103, where "cunningly designed" synthetic diamond crystals by De Beers are likened to "stone age tools"; and on page 210, where, after describing the ruggedness and incredible hardships of life in the South African diamond fields in the 1870s, Davies summarizes by saying ". . . prospectors were, necessarily, individualists." Heavier moments (hours) come as one takes up such subjects as electron-nuclear double magnetic resonance. (This requires some "individualism" on the part of the average reader.)

The approximately 100 black-and-white photographs and line drawings are not beautiful, but they serve their purpose. The quality of production, editing, paper, and printing are all excellent.

Readers of *Gems & Gemology* who have an interest in the scientific aspects of diamond will consider this fine book a valuable addition to their collection.

JAMES R. LUCEY
Resident Diamond Supervisor
GIA Santa Monica

*This book is available for purchase at the GIA Bookstore, 1660 Stewart Street, Santa Monica, CA 90404.

GEMSTONE ENHANCEMENT

By Kurt Nassau, 221 pp., illus., publ. by Butterworths, London, England, 1984. US \$34.95*

Dr. Nassau presents his new book as a compilation of information on gemstone treatments "which are obvious, which have been published, or which can be deduced from information that has been published." He has pursued his writing task with the mind of a scientist and the diligence of a first-rate detective. The product is *Gemstone Enhancement*, an important addition to the gemological literature.

In his introductory chapter, Nassau outlines the material to follow and issues "a warning" that also serves as a disclaimer: he advises users of the book to read certain sections before attempting any of the treatments listed in chapter seven. He also suggests experimenting on a small fragment of little value before treating more valuable materials.

Chapter two, "The History of Treatments," is one of the most interesting. Here we take a journey through time and learn that an amazing number of gemstone treatments, often thought of as modern, were actually developed two thousand or more years ago. Through Dr. Nassau's diligence we gain a glimpse of C. Pliny's *Natural History* (circa 80 A.D.) and the heretofore virtually unknown *Stockholm Papyrus* (circa 400 A.D.), which contains a list of 74 recipes for "falsifying" pearls and gemstones. The chapter ends in the 20th century, with a brief discussion of gemstone irradiation.

Chapter three deals with heat treatments. Again, Dr. Nassau traces the history of the practice, citing examples such as heat-treated chalcedony (which dates back to 2000 B.C.), and the equally ancient quench cracking of quartz in preparation for dyeing. He then describes modern heat-treating methods in detail, including the chemical reactions and probable mechanisms involved in color alteration.

Because artificial irradiation is a modern phenomenon, chapter four, *Continued on page 61*

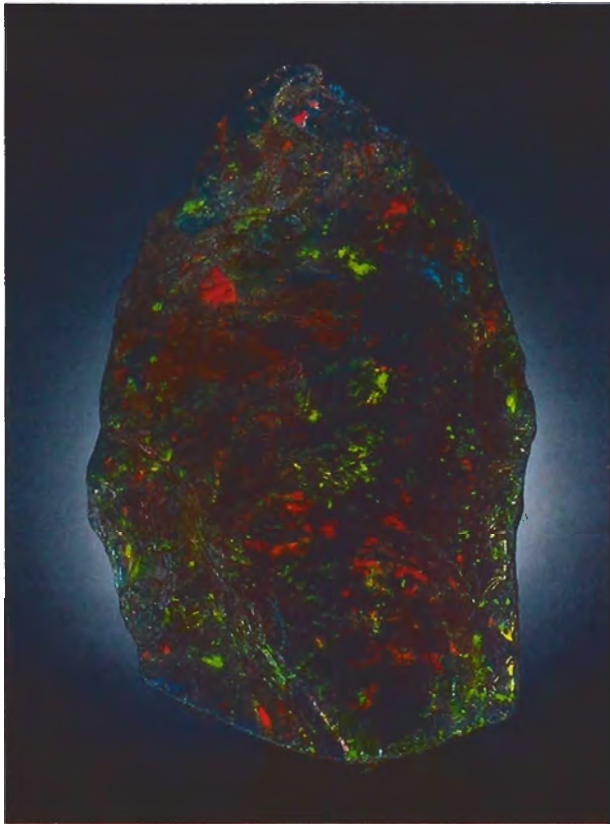

Figure 1. The 574.09-ct "Big Black" emerged from a new opal locality in northern New South Wales, Australia. Stone courtesy of Campbell Bridges; photo ©Harold & Erica Van Pelt.

Sri Lanka looks at mechanized gem mining. The government of Sri Lanka is evaluating a proposal given by Western Australia's Haoma North West Group to mechanize the Sri Lankan gem mining industry. Recently, Haoma has been working in partnership with the Sri Lankan government to increase the efficiency of the gem mining industry, which is currently based on manual methods. Under their present agreement, Haoma, together with the State Mining and Mineral Development Corporation, would provide the exploration and mining expertise while the Sri Lankan government would make available the lands for mining. (*Mining Magazine*, December 1984)

World's largest diaspore? In the summer 1984 issue of *Gems & Gemology* (p. 113), C. A. Schiffman reported on the existence of a large faceted gem-quality diaspore from a deposit in Turkey. Terry Coldham, of Sapphex Pty. Ltd. in Sydney, Australia, recently allowed us to photograph this stone along with a smaller faceted diaspore and two large crystals from this same locality: Mamaris, Yatagan, in the Mugla Province of Turkey (figure 2). He reports that the deposit was found in a

200–300 m vein within aluminum-rich rocks. The material characteristically shows a very distinct color change from green in daylight to pinkish red in incandescent light.

PRECIOUS METALS

Colombian gold. Colombia's Mines and Energy Ministry has announced that an important gold deposit has been discovered in the eastern area of Guainia, near the Brazilian border. No further details of the deposit were provided at this time. However, a technical study of the area done by the Mines and Energy Institute has shown that the geology is similar to that of South Africa's Witwatersrand Basin. (*Mining Journal*, January 11, 1985)

Gold exploration in Nova Scotia. A new mineral exploration consortium, called Scotian Mineral Exploration, plans to spend \$3 million over the next three years exploring for gold and other valuable minerals in Nova Scotia, Canada. Exploration will occur in areas licensed by the Province of Nova Scotia and on lands acquired through joint ventures with local mining groups. A subsidiary of Inco, Canadian Nickel Company Ltd., will manage the exploration efforts. (*Mining Magazine*, January 1985)

Gold in Finland. Gold has been discovered at Laivakangas, near the city of Raahe, on the Gulf of Bothnia. Outokumpu Oy is currently investigating the discovery. So far, diamond drilling has shown the gold to be confined to narrow quartz veins. Values of 5 g of gold per ton have been reported. (*Mining Magazine*, January 1985)

Gold in Mali. Gold production will begin this year at Kalana, in Southern Mali. Mali Geology and Mining Services report that they expect to produce 1,800 kg of gold per year. Other gold deposits and also diamonds have reportedly been discovered during exploration in this area. (*Mining Magazine*, September 1984)

Improved gold-sampling technique. The CSIRO Division of Energy Chemistry in Sutherland, N.S.W., Australia, has developed an ultra-sensitive method for determining trace amounts of gold in water. This new method should rekindle interest in direct hydrogeochemical prospecting for gold, an exploratory technique that uses the gold content of water as an indicator of gold deposits.

The amount of gold found in water in direct contact with gold-bearing rocks usually does not exceed 15 parts per trillion (ppt). An analytical technique useful for measuring gold in water must therefore be able to detect gold down to at least 1 ppt. The new CSIRO technique involves the preconcentration of gold onto charcoal and subsequent neutron activation analysis (NAA); gold in samples can be measured down to 0.3 ppt. For further



Figure 2. The 157.66-ct gem-quality diaspore shown here may be the world's largest. The 26.97-ct diaspore and the two diaspore crystals also shown came from the same locality in Turkey. Stones courtesy of Terry Coldham; photo by Shane McClure.

information, contact Mr. John Fardy, CSIRO Division of Energy Chemistry, Private Mail Bag 7, Sutherland, N.S.W. 2232, Australia. (*Queensland Government Mining Journal*, August 1984)

Loans offered to Chinese gold miners. According to the official *China Daily*, the government of China is offering loans to private groups and individual miners to encourage gold exploration and mining in mainland China. Since China changed its policies in 1978, it is reported that as many as 80,000 individuals have turned to gold mining. These individuals now produce about half of China's production of gold, which is currently estimated at approximately 45 tons per year. (*Mining Magazine*, January 1985)

SYNTHETICS

More news on the growth of synthetic gem diamonds. In response to the article on identifying synthetic diamonds that appeared in the Fall 1984 issue of *Gems & Gemology* (Koivula and Fryer), Dr. R. C. DeVries, of General Electric's Research and Development Department in Schenectady, New York, supplied the following additional information concerning the production of cuttable gem-quality synthetic diamonds.

With regard to other growers of synthesized diamond, it is public knowledge that Sumitomo and the National Institute for Research on Inorganic Materials in Japan have grown large gem-quality diamonds. The latter organization recently announced that it had succeeded in growing a 1-cm (3.5 ct) crystal; the stone was grown at 1550°C under 60 kb pressure for 200 hours. De Beers has also grown large single crystals.

More on Russian hydrothermal synthetic emeralds. Dr. Frederick H. Pough, noted mineralogist and gemologist, supplied Gem News with the following information concerning the Russian hydrothermal synthetic emeralds that have recently appeared on the colored-stone market. The emeralds show a refractive index of 1.574–1.580 with a birefringence of 0.006. They do not fluoresce to either long-wave or short-wave ultraviolet radiation, and their color-filter reaction is negative. The specific gravity is above 2.67, as would be expected from a hydrothermal synthetic emerald. The emeralds show a unique chevron-shaped internal growth pattern (figure 3), which has not been observed in any natural emeralds. The emeralds are doped with iron which masks the

Figure 3. Chevron-shaped growth zoning in a Russian hydrothermal synthetic emerald. Castor oil immersion. Photo by Dr. Frederick H. Pough, magnified 20x.

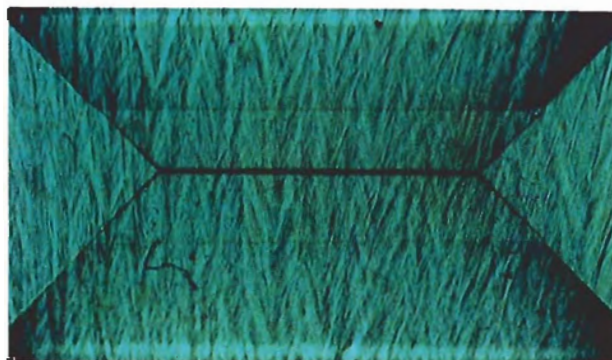

GEM NEWS

John I. Koivula, *Editor*
Elise Misiorowski, *Contributing Editor*

DIAMONDS

Australia

Another new Australian diamond find. Australian Diamond Exploration NL, ADE, has reported the discovery of a potentially major new diamond find in the Coanjula area of the Northern Territory of Australia. Diamonds have been found in 15 of the 22 kimberlite pipes discovered so far in the area. Altogether, 37 geophysical targets termed "first priority" have been outlined. The \$8 million exploration program was begun by the ADE Joint Venture five years ago. During exploration, an 847,000-km² band stretching virtually across the entire width of the northern territory was covered. The companies in the ADE Joint Venture are Aberfoyle Ltd., AOG Minerals Ltd., and Ashton Mining NL. (*Mining Magazine*, January 1985)

Canada

Diamonds in Canada. The Geological Survey of Ontario, Canada, is trying to encourage exploration geologists to include diamond prospecting in their mineral search efforts. Renewed interest in diamond exploration has been stimulated by the recent discovery of kimberlite boulders in glacial gravels from the vicinity of Hearst Township. Diamonds have been found periodically in Canada for over 60 years, including one early discovery of a gem-quality 33-ct stone from near Peterborough, Ontario.

Most of the diamonds discovered in Canada have been found in alluvial gravel deposits; the great extent to which glacial moraine covers the Canadian shield has caused major problems in geologists' efforts to trace the origin of the kimberlite boulders and the few diamonds found within the gravels.

Some small diamonds have been recovered from kimberlite pipes on Somerset Island in arctic Canada, and kimberlite bedrock has been recognized at Gauthier. However, the exact source of the larger diamonds so far recovered from the gravels remains a mystery. At present, two mining companies are active in diamond exploration in Northeastern Ontario: Monopros Ltd. (a Canadian subsidiary of De Beers), and BP Resources (Canada) Ltd. (*Mining Magazine*, January 1985)

Israel

Israeli diamond industry exports 2.3 million carats in 1984, smaller cuts dominate production. The Israeli diamond industry is entering 1985 on the wave of a

recovery that is said to be stabilizing its traditional markets and opening new ones for this country's largest export branch.

Worldwide sales of diamonds polished in Israel reached \$1.035 billion in 1984, compared to \$1.001 billion in 1983, or an increase of 3.5%. Most important for the industry's renewed growth in 1985 is a 4.7% increase in the volume of gem diamonds exported, to 2,285,000 ct. The increased production of such diamonds in Israel has resulted in an almost 10% increase in the production work force, to almost 8,500 cutters, as well as an influx of new customers.

The American market continues to grow in importance for Israel, the United States accounted for almost half (49%) of all net exports in 1984, compared to 36% only two years ago. The distribution centers of Belgium and Hong Kong accounted for \$147.5 million and \$140 million, respectively, while Japan is the second largest consumer market with diamond imports from Israel of \$133.7 million in 1984. (Burton Halpern News Release, Tel Aviv, Israel, January 1985)

Sierra Leone

Sierra Leone buys out British Petroleum. According to a recent official statement, the government of Sierra Leone has purchased British Petroleum's 49.5% share in Sierra Leone's National Diamond Mining Company for a sum of \$8.5 million. The government of Sierra Leone now has total control of the country's diamond-mining industry, which is its main foreign-exchange earner. (*Mining Magazine*, December 1984)

COLORED STONES

Australia produces 500+-ct opal from a new locality.

Campbell Bridges, of Bridges Exploration Ltd. in Nairobi, Kenya, sends news of a large black opal that was recently found at a new locality in northern New South Wales, Australia (figure 1). Nicknamed the "Big Black," the spearhead-shaped opal weighs 574.09 ct and measures 3¼" × 2⅜" × 1⅛" (9.5 × 6 × 3 cm). The stone displays all of the primary colors, with red predominating, as well as an unusual range of patterns. The exact location of the discovery, as well as the mining prospects for this new source of black opal, have not yet been released. The "Big Black" is scheduled to be placed on display at the Los Angeles County Museum of Natural History in the near future.

fluorescence. The Gem News Editor also has examined some of these Russian synthetic emeralds and his observations support those of Dr. Pough.

TUCSON 1985

Once again, in early February, the city of Tucson, Arizona, was transformed into a mineral and gem fancier's paradise. The show spread from a hub consisting of the Convention Center and the Holiday Inn Broadway, outward to most of the other hotels and motels in the area. A convenient, frequent, and free shuttle service transported visitors throughout this maze of temporary show and sales rooms. The Holiday Inn Broadway was a mix of minerals, cut gems, jewelry, and jewelry findings, while hotels such as the Desert Inn were devoted mainly to minerals and fossils. The largest number of colored-stone dealers were in the Doubletree Inn at the American Gem Trade Association's show.

Aside from the usual trays of rubies, sapphires, emeralds, tourmalines, topazes, etc., we saw a number of new and/or different materials that we felt we should bring to the attention of our readers.

Natural Materials Noted

Beryl. Aquamarines from a relatively new source in Nigeria, both cut and rough, were in abundance. Also noted were aquamarines and golden beryls from Afghanistan, although there seemed to be less of this material than last year.

Diamond. This year at Tucson a surprising number of diamond dealers had booths. They reportedly did very well, especially in the smaller sizes suitable for use as accent stones in fine jewelry.

Garnet. Small andradite (demantoid) garnets of a yellowish green to a beautiful rich green are being mined both in southern Mexico and in New Mexico. Rhodolite garnets were present in large quantities this year. Most of this material is reportedly from Africa, although a few dealers claimed Sri Lanka as the origin for some of their stones. Pyrope-almandine garnets are being found in

Colombia, in the same area that is now producing gem corundum.

Opal. Three unusual types of opal were present at Tucson this year. One type is a faceted transparent stone that is almost pure red with little or no play-of-color. Another type was described as having a fine chrysocolla blue color with just a hint of green. The third type is light purple and transparent.

Parisite. About a dozen large crystals of the rare mineral parisite were offered for sale at Tucson. Found at the Muzo Mine in Colombia, they are many times larger (one weighs 385.66 ct) than any such crystals seen in the past, even those from the state of Montana. Parisite is a rare associate of Muzo emeralds, and these crystals were discovered during the course of emerald mining.

Tourmaline. A relatively new yellow tourmaline from Zambia was more prominent this year than last. This type of tourmaline, a very manganese-rich member of the group, was first found at Tsilazina, in Madagascar, about 1910. Recently, a number of articles have been written about manganese-rich tourmalines, but none of those reported so far have contained enough manganese to be considered a new species in the tourmaline group. Unfortunately, even though the name has not been approved by the International Mineralogical Association, and the manganese contents reported have been far short of end-member status, many dealers were offering the Zambian material as tsilaisite.

Synthetics

In addition to the Russian hydrothermal synthetic emeralds reported on elsewhere in this Gem News column, many other synthetic materials were also offered for sale. Synthetic amethyst in particular was in abundance.

The Gem News Editor wishes to thank the following individuals who provided some of the information used in this Tucson Report: Bill Boyajian, Dino DeGhionno, Chuck Fryer, Steve Hofer, Robert Kammerling, Robert Kane, James Shigley, and Carol Stockton.

ANNOUNCEMENTS

ISA to host first North American meeting of F.G.A.s and G.G.s. The first North American meeting of fellows and ordinary members of the Gemmological Association of Great Britain, and graduate gemologists of the Gemological Institute of America will be hosted by the International Society of appraisers

during its annual conference May 5-8, 1985, at the Hyatt Regency Hotel in Atlanta, GA. Both David J. Callahan and Richard T. Liddicoat, Jr., will address gemologists and appraisers on the international role of the association. A formal dinner will be held on Tuesday, May 7, with proceeds to benefit the GIA Research

Fund and the British Basil Anderson Fund. For reservations and information, contact ISA at (312) 882-0706.

New gemological journal from Sri Lanka. The Gemmologists Association of Sri Lanka has introduced a new professional

gemmological journal, *Journal of the Gemmologists Association of Sri Lanka*. Issue number 1 was published in October 1984; it is formatted in the style of the British *Journal of Gemmology* and contains color, which is certainly a plus. The printing is good and the articles are of a high standard. After looking over the premier issue of this new journal, the Gem News Editor wishes the association every success and recommends their periodical to all serious gemologists. For further information, write: *Journal of the Gemmologists Association of Sri Lanka*, "Professional Centre," 275/75, Bauddhaloka Mawatha, Colombo 7, Sri Lanka.

World Congress of Jewelry Appraisers to convene. The National Association of Jewelry Appraisers announced that it will sponsor a "World Congress of Jewelry Appraisers" in New York City in 1986. The three-day event will include all major international organizations that address the

subject of jewelry valuation. Preliminary plans call for an international consortium of participants who will present a variety of papers addressing topics of major concern to the jewelry appraisal profession. The program also will include several workshops, as well as an international exhibition/trade show of gemological equipment and appraisal-related products and services.

Additional details may be obtained by writing the National Association of Jewelry Appraisers at 4120 North Brown Ave., Suite A, Scottsdale, AZ 85251.

Hong Kong Jewelry & Watch Fair.

The 1985 fair has been scheduled for September 10–13, 1985. Three venues—the Regent Hotel, the New World Hotel, and the Golden Mile Holiday Inn—will highlight every major line of the jewelry, watch and clock, and gemstone industry. The Holiday Inn will be reserved for watches and clocks and related

accessories. For details, please contact the organizer: Headway Trade Fairs Ltd., 628 Star House, 3 Salisbury Rd., Kowloon, Hong Kong.

"Gemesis"—Gemstones and Their Origins, a new permanent exhibit, opens May 3 at the Los Angeles County Museum of Natural History, Los Angeles, CA. Using exciting graphics and a variety of fine rough and cut gems, this unique exhibit explains the major processes by which gemstones are formed. For more information, call (213) 744-3411.

ICA to sponsor colored gemstone congress. The International Colored Gemstone Association (ICA) will sponsor a colored gemstone congress to be held in Idar-Oberstein, West Germany, on May 20–22, 1985. For further information, please contact Maureen E. Jones, ICA Administrator, 22643 Strathern St., Canoga Park, CA 91304; (818) 716-0489.

Continued from page 56

dealing with irradiation treatments, contains no historical discussion. Instead, it delves into the causes of irradiation-altered color in gem materials and describes the radiation sources and apparatuses used in such treatments. This chapter ends with a discussion of radioactive gemstones, one of today's "hottest" topics.

Treatments other than heating and irradiation are the subject of chapter five. These include dyeing, impregnation, bleaching, and surface modifications such as glossing and painting. This chapter also covers laser drilling, synthetic overgrowths (such as the Lechleitner emerald-over-beryl product), and assembled gemstones.

Chapter six contains an overview of testing for treatment and black-and-white illustrations of the testing equipment. Treatment disclosure is also mentioned. The FTC

and CIBJO rulings are outlined, and treatment disclosure as practiced in the trade is tabulated.

Chapter seven, which deals with specific gemstone treatments, is both the longest (84 pp.) and the last chapter in the book. The entries in this section are arranged alphabetically—abalone through zoisite. The method(s) used to treat each gem, as derived from the existing literature, are spelled out here. Again, Nassau issues the warning to try out treatment processes on insignificant samples before applying them to anything of value.

Four useful and lengthy appendices titled "More on Heating," "More on Irradiation," "Color," and "Purveyors of Supplies and Services," together with a subject index close the volume.

This work is illustrated with many tables and line drawings, 41

black-and-white photos, and an eight-page section containing 28 fine color photographs. As a bonus, each chapter and appendix contains a list of references called out in the text. Aside from a few typographical errors that sneak past any author, there is nothing to criticize about this book. It is a top-quality production.

Dr. Nassau's writing style and organizational skills have made the book easy to read and understand without sacrificing its necessary technical content. With the publication of *Gemstone Enhancement*, Kurt Nassau has provided the gemological community with a long-needed and already indispensable text that is sure to become a classic.

JOHN I. KOIVULA
Senior Gemologist
GIA Santa Monica

GEMS & GEMOLOGY is an international publication of original contributions (not previously published in English) concerning the study of gemstones and research in gemology and related fields. Topics covered include (but are not limited to) colored stones, diamonds, gem instruments, gem localities, gem substitutes (synthetics), gemstones for the collector, jewelry arts, and retail management. Manuscripts may be submitted as:

Original Contributions—full-length articles describing previously unpublished studies and laboratory or field research. Such articles should be no longer than 6,000 words (24 double-spaced, typewritten pages) plus tables and illustrations.

Gemology in Review—comprehensive reviews of topics in the field. A maximum of 8,000 words (32 double-spaced, typewritten pages) is recommended.

Notes & New Techniques—brief preliminary communications of recent discoveries or developments in gemology and related fields (e.g., new instruments and instrumentation techniques, gem minerals for the collector, and lapidary techniques or new uses for old techniques). Articles for this section should be about 1,000–3,000 words (4–12 double-spaced, typewritten pages).

MANUSCRIPT PREPARATION

All material, including tables, legends, and references, should be typed double spaced on 8½ × 11" (21 × 28 cm) sheets. The various components of the manuscript should be prepared and arranged as follows:

Title page. Page 1 should provide: (a) the article title; (b) the full name of each author with his or her affiliation (the institution, city, and state or country where he/she works); and (c) acknowledgments.

Abstract. The abstract (approximately 150 words for a feature article, 75 words for a note) should state the purpose of the article, what was done, and the main conclusions.

Text. Papers should follow a clear outline with appropriate heads. For example, for a research paper, the headings might be: Introduction,

Previous Studies, Methods, Results, Discussion, Conclusion. Other heads and subheads should be used as the subject warrants. For general style, see *A Manual of Style* (The University of Chicago Press, Chicago).

References. References should be used for any information that is taken directly from another publication, to document ideas and facts attributed to—or facts discovered by—another writer, and to refer the reader to other sources for additional information on a particular subject. Please cite references in the text by the last name of the author(s) and the year of publication—plus the specific page referred to, if appropriate—in parentheses (e.g., Liddicoat and Copeland, 1967, p. 10). The references listed at the end of the paper should be typed double spaced in alphabetical order by the last name of the senior author. Please list only those references actually cited in the text (or in the tables or figures).

Include the following information, in the order given here, for each reference: (a) all author names (surnames followed by initials); (b) the year of publication, in parentheses; (c) for a *journal*, the full title of the article or, for a *book*, the full title of the book cited; and (d) for a *journal*, the full title of the journal plus volume number and inclusive page numbers of the article cited or, for a *book*, the publisher of the book and the city of publication. Sample references are as follows:

Daragh P.J., Sanders J.V. (1976)
Opals. *Scientific American*, Vol. 234, pp. 84–95.

Liddicoat R.T. Jr., Copeland L.L.
(1967) *The Jewelers' Manual*, 2nd ed. Gemological Institute of America, Santa Monica, CA.

Tables. Tables can be very useful in presenting a large amount of detail in a relatively small space, and

should be considered whenever the bulk of information to be conveyed in a section threatens to overwhelm the text.

Figures. Please have line figures (graphs, charts, etc.) professionally drawn and photographed. High-contrast, glossy, black-and-white prints are preferred.

Submit black-and-white photographs and photomicrographs in the final desired size if possible.

Color photographs—35 mm slides or 4 × 5 transparencies—are encouraged.

All figure legends should be typed double spaced on a separate page. Where a magnification is appropriate and is not inserted on the photo, please include it in the legend.

MANUSCRIPT SUBMISSION

Please send three copies of each manuscript (and three sets of figures and labels) as well as material for all sections to the Editorial Office:

Gems & Gemology, 1660 Stewart Street, Santa Monica, CA 90404.

In view of U.S. copyright law, a copyright release will be required on all articles published in *Gems & Gemology*.

No payment is made for articles published in *Gems & Gemology*. However, for each article the authors will receive 50 free copies of the issue in which their paper appeared.

REVIEW PROCESS

Manuscripts are examined by the Editor, one of the Associate Editors, and at least two reviewers. The authors will remain anonymous to the reviewers. Decisions of the Editor are final. All material accepted for publication is subject to copyediting; authors will receive galley proofs for review and are held fully responsible for the content of their articles.

Suggestions for Authors