

# GEMS & GEMOLOGY

VOLUME XXXIV

SPRING 1998



THE QUARTERLY JOURNAL OF THE GEMOLOGICAL INSTITUTE OF AMERICA

# GEMS & GEMOLOGY

VOLUME 34 NO. 1

SPRING 1998

## T A B L E O F C O N T E N T S



pg. 7



pg. 30



pg. 42

pg. 46

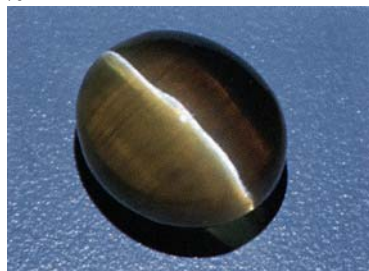

### EDITORIAL

- 1** The Dr. Edward J. Gübelin Most Valuable Article Award

### FEATURE ARTICLE

- 4** The Rise to Prominence of the Modern Diamond Cutting Industry in India  
*Menahem Sevdermish, Alan R. Miciak, and Alfred A. Levinson*

### NOTES AND NEW TECHNIQUES

- 24** Leigha: The Creation of a Three-Dimensional Intarsia Sculpture  
*Arthur Lee Anderson*
- 34** Russian Synthetic Pink Quartz  
*Vladimir S. Balitsky, Irina B. Makhina, Vadim I. Prygov, Anatolii A. Mar'in, Alexandr G. Emel'chenko, Emmanuel Fritsch, Shane F. McClure, Lu Taijing, Dino DeGhionno, John I. Koivula, and James E. Shigley*

### REGULAR FEATURES

- 44** Gem Trade Lab Notes
- 50** Gem News
- 64** *Gems & Gemology* Challenge
- 66** Book Reviews
- 68** Gemological Abstracts

---

*ABOUT THE COVER: Over the past 30 years, India has emerged as the dominant supplier of small cut diamonds for the world market. Today, nearly 70% by weight of the diamonds polished worldwide come from India. The feature article in this issue discusses India's near-monopoly of the cut diamond industry, and reviews India's impact on the worldwide diamond trade. The availability of an enormous amount of small, low-cost Indian diamonds has recently spawned a growing jewelry manufacturing sector in India. However, the Indian diamond jewelry-making tradition has been around much longer, as shown by the 19th century necklace (39.0 cm long), pendant (4.5 cm high), and bracelet (17.5 cm long) on the cover. The necklace contains 31 table-cut diamond panels, with enamels and freshwater pearls. The pendant shows rose and crescent moon motifs, formed by table-cut diamonds and fringed by nephrite jade, enamel, and freshwater pearls. The bracelet contains table-cut diamond flowerheads with triple-stone intersections. Photo courtesy of Christie's Images.*

*Color separations for Gems & Gemology are by Pacific Color, Carlsbad, California. Printing is by Fry Communications, Inc., Mechanicsburg, Pennsylvania.*

© 1998 Gemological Institute of America All rights reserved. ISSN 0016-626X



# THE DR. EDWARD J. GÜBELIN MOST VALUABLE ARTICLE AWARD

For *Gems & Gemology* the past year can best be summed up with this one word: Diamond. Issues related to diamonds continue to be of great interest to our industry and the winning articles for the Dr. Edward J. Gübelin Most Valuable Article Award reported on three major aspects: gemological properties, grading, and simulants. First place was awarded to "Synthetic Moissanite: A New Diamond Substitute." Second place went to "A Contribution to Understanding the Effect of Blue Fluorescence on the Appearance of Diamonds," and third place was awarded to "Gemological Properties of Near-Colorless Synthetic Diamonds." The first and second place articles appeared in the Winter 1997 issue, and third place was published in the Spring 1997 issue.

The authors of these three articles will share cash prizes of \$1,000, \$500, and \$300, respectively. The following are photographs and brief biographies of the winning authors.

Congratulations also to Verl McCown of Reno, Nevada, whose ballot was randomly chosen from the many entries to win a five-year subscription to *Gems & Gemology*.

## First Place

### *Synthetic Moissanite: A New Diamond Substitute*

Kurt Nassau, Shane F. McClure, Shane Elen, James E. Shigley

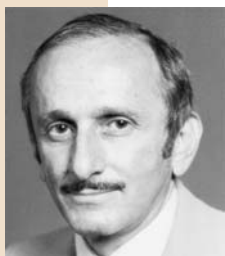

Kurt Nassau

Shane Elen



**Kurt Nassau**, retired from his position as distinguished research scientist at AT&T Bell Laboratories, has written numerous books and articles. Today he resides in Lebanon, New Jersey, and serves as a consultant and expert witness. A native of Austria, Dr. Nassau earned his Ph.D. in chemistry at the University of Pittsburgh. **Shane McClure** is manager of identification services at the GIA Gem Trade Laboratory in Carlsbad. Mr. McClure has 19 years of experience in gemology and is an editor for two sections of *Gems & Gemology*. He is also an accomplished gem and jewelry photographer. **Shane Elen** is a research gemologist at GIA Research, Carlsbad. He holds an engineering degree from the Camborne School of Mines, Cornwall, U.K. With 14 years' experience in solid state materials analysis, he has a strong interest in developing new identification methods for gem materials. **James Shigley** is

director of GIA Research in Carlsbad. He received his Ph.D. in geology from Stanford University and has written many articles on natural, treated, and synthetic gems. He also directs research on all aspects of identifying and characterizing gem materials.

Shane McClure and James Shigley



## Second place

### ***A Contribution to Understanding the Effect of Blue Fluorescence on the Appearance of Diamonds***

Thomas M. Moses, Ilene M. Reinitz, Mary L. Johnson, John M. King, James E. Shigley



Mary Johnson

**Thomas Moses**, with over 20 years of trade and laboratory experience, is vice president of identification services at the GIA Gem Trade Laboratory in New York City. He attended Bowling Green University, Ohio, and is an editor of the Gem Trade Lab Notes section. He specializes in pearl identification and the properties of diamond.

**Ilene Reinitz** is manager of Research and Development at GIA GTL New York. Dr. Reinitz received her Ph.D. in geochemistry from Yale University. She is also an editor of Gem Trade Lab Notes, and has co-authored numerous articles. **Mary Johnson** is manager of Research and Development at GIA GTL Carlsbad. Dr. Johnson, who has also authored and co-authored articles for G&G, is editor of the Gem News section. She holds a Ph.D. in mineralogy and crystallography from Harvard University. **John King**, from GIA GTL New York, is a laboratory projects officer. Mr. King holds an

M.F.A. from Hunter College, City University of New York. With 19 years of laboratory experience, he frequently lectures on colored diamonds and various aspects of laboratory grading procedures. Please see the first-place entry for biographical information on **James Shigley**.

Thomas Moses, Ilene Reinitz, and John King



## Third place

### ***Gemological Properties of Near-Colorless Synthetic Diamonds***

James E. Shigley, Thomas M. Moses, Ilene M. Reinitz, Shane Elen, Shane F. McClure, Emmanuel Fritsch



Emmanuel Fritsch

**James Shigley**, who also co-authored the first- and second- place articles, is profiled in the first-place entry. **Thomas Moses** and **Ilene Reinitz** were also co-authors of the second-place article, and **Shane Elen** and **Shane McClure** also co-authored the first-place article. **Emmanuel Fritsch** is a professor in the Continuing Education Department at Nantes University in France,

where he teaches an advanced gemology degree program. He holds a Ph.D. from the Sorbonne in Paris. His research specialties are advanced techniques applied to gemology, origin of color and luminescence, treated and synthetic gems, and twinned crystals. He has published several articles in *Gems & Gemology* over the years.

---

# THE RISE TO PROMINENCE OF THE MODERN DIAMOND CUTTING INDUSTRY IN INDIA

By Menahem Sevdemish, Alan R. Miciak, and Alfred A. Levinson

*The modern diamond cutting industry in India began slowly in the late 1950s but did not gain momentum until the mid-1960s. In the 30 years from 1966 to 1996, the industry grew at a remarkable rate: 82-fold by polished weight and 249-fold by polished (wholesale) value. Today, India accounts for about 70% by weight and 35% by (wholesale) value of the diamonds polished annually worldwide (excluding the effects of recent temporary surpluses of Russian rough diamonds in the market), and it has a near-monopoly in smaller (less than 7 pt) stones. Using production, sales, and other statistics, this article reviews the rise of the modern diamond cutting industry in India and its impact on the world diamond trade. India has had a profound effect on this trade because of the enormous quantities of small, low-cost diamonds manufactured there.*

## ABOUT THE AUTHORS

Mr. Sevdemish, FGA, author of *The Dealer's Book of Gems and Diamonds (1997)*, is founder and president of *The European Gemological Center and College, Ramat Gan, Israel*; e-mail, smenahem@netvision.net.il. Dr. Miciak is associate professor of marketing in the Faculty of Management, and Dr. Levinson is professor emeritus in the Department of Geology and Geophysics, University of Calgary, Alberta, Canada.

Please see acknowledgments at the end of the article.

Gems & Gemology, Vol. 34, No. 1, pp. 4–23  
© 1998 Gemological Institute of America

Undoubtedly one of the main dynamics in the world diamond market over the past three decades has been the rise of the diamond cutting industry in India (figure 1). Characteristically, India has focused on cutting and polishing only small (typically 7 pt and less when finished), low-quality “near-gems” for export to jewelry manufacturers around the world.

Initially the “make” (quality of proportions and finish) of Indian polished diamonds was poor, but by about 1970 the quality had improved to the point that competition from this source was being felt in Antwerp and Israel (Goldwasser, 1970). Soon thereafter, almost all the small, low-quality polished diamonds in the world market were cut in India. Attempts by other Asian countries to capture this market (e.g., Sri Lanka, Thailand, China; “Technical training,” 1994) have met with only limited success. In 1993, for example, factories in Sri Lanka exported 700,000 carats of small polished diamonds (“Sri Lanka keeps a steady pace,” 1995), but this represents only 5% of India’s production for that year.

India’s importance as a diamond cutting center has not been well documented in the gemological literature. For example, the second edition of Bruton (1978, p. 200) devoted exactly four *words* to the Indian cutting industry: “India also cuts ‘smalls’.” Yet, in the same year that book was published, India exported 4.32 million carats (Mct) of polished diamonds, which represented 52% of the world’s polished supply by weight and 16% by value.

The strengths and characteristics of cutting centers are important to gemologists because of their implications for supply of (and, ultimately, demand for) gems. Thus, the purpose of this article is to trace developments in the important Indian diamond manufacturing industry as they relate to the gemological community. One implication of these develop-



Figure 1. One indication of the growth of the Indian diamond cutting industry is the development of a jewelry manufacturing sector. This bib-style necklace designed by Priya Sewani of India, sponsored by Su-Raj Jewellery India Ltd., was a winning entry in the 1998 Diamonds International Awards Competition (one of four Indian pieces to be so honored). The piece is set with 1,210 diamonds weighing a total of 120.23 ct.



ments is the emergence of a whole new class of "cuttable" diamond, that is, "near-gems": small, low-quality stones that are commercially feasible as gems only because of the availability of good, inexpensive labor such as in India.

#### BACKGROUND

Diamonds have been mined in India since before the fourth century BC, although mining virtually ceased there about 1750, shortly after the discovery of major deposits in Brazil. The locally mined diamonds were fashioned in India, possibly as early as the late 14th century (Bruton, 1978). However, the modern era of diamond cutting and polishing (henceforth, "cutting") in India has been totally independent of the local mines (Sevdermish and Mashiah, 1996).

**Early Developments.** In 1909, a fortuitous event laid the organizational foundation for the modern diamond cutting industry in India. In the city of Palanpur (Gujarat State), about 600 km (375 miles)

north of Bombay (figure 2), some urban mercantile families (now called Palanpuris) entered the trade as import agents for polished diamonds, largely to supply European dealers operating in India. These individuals were followers of the Jain religion, which emphasizes close family ties and cooperation, maintains strict rules of business conduct, and has a high percentage of arranged marriages within the community. Because of the strength of their community, and their business acumen, the Jains tend to prosper in any business into which they venture (Shor, 1993). By the beginning of World War II, the Jains, among whom Kirtilal M. Mehta, Maftalal Mehta, and S. G. Jhaveri are patriarchs, had established international contacts and buying offices in Antwerp and other diamond centers.

When India became independent in 1947, industrial development took precedence over most other pursuits, so little foreign exchange was available for the importation of polished gems. Therefore, as early as 1949, some Palanpuri entrepreneurs ventured away from strictly import-



Figure 2. India's diamond sector flourishes in the states of Gujarat, Maharashtra, and Goa. Key urban areas where diamond cutting and polishing are major industries are also shown.

ing finished goods and went into manufacturing, establishing a few small factories to polish diamonds for the local market (Chhotalal, 1984). They selected the city of Surat as the initial manufacturing site because of its proximity to Bombay, an international trade center. With time, numerous other cutting centers developed, mostly in the western part of the country and particularly in Gujarat (now the "diamond state" of India; figure 3).

**Industry-Government Relations.** The industry developed very slowly through the 1950s and early 1960s, primarily because the supply of rough was erratic (the result of foreign currency restrictions and other reasons discussed below) and, perhaps even more significant, because of a strained relationship with the government (Shor, 1993). Notwithstanding the existence of a few small factories, the Indian government frowned on the nascent diamond industry, because importing rough dia-

monds meant exporting foreign currency ("Small diamonds, big business," 1995); further, diamonds were being used domestically as a hedge against inflation, a practice not in line with government objectives. To overcome this obstacle to importing rough, the Palanpuris devised a solution that would not only eliminate domestic consumption but also create enormous employment opportunities.

They proposed that the diamond companies would import only rough diamonds and manufacture them into polished for export at a mandated percentage of added value. This would create jobs and generate foreign exchange, a dual benefit to the nation. The government accepted this concept (officially known as the "Replenishment Scheme"), and in 1955 it granted the first formal licenses for the import of rough based on the level of polished diamond exports. As logical as the idea was, mistrust continued between the government and the diamond trade. The licensing system was cumbersome and difficult, government corruption was always a problem, and some in the industry were involved in smuggling and in fiscal and licensing irregularities (see Shor, 1993, for details).

Over time, the relationship between the government and the industry improved, as the dual objectives of job creation and increased foreign earnings materialized. Subsequently, the government helped the industry in several ways, for example: (1) with more flexible regulations for the importation of rough; (2) by relaxing foreign currency regulations (i.e., permitting qualified companies to have overseas foreign currency accounts); (3) by eliminating in 1983 the prevailing 5% duty on rough imports; (4) by setting up the Gem & Jewellery Export Promotion Council (GJEPC; see below) and the Hindustani Diamond Company (to help small producers obtain rough); and (5) with tax incentives, particularly exempting export profits from taxation (Scriven, 1997). The success of job creation can be gauged by the fact that in the 1990s as many as 600,000–800,000 workers were employed in diamond cutting, some part-time, both in modern factories and in the cottage industry sector (Sharma, 1992; Jhaveri, 1994; Pandya, 1997).

**The Search for Rough.** But the Indian cutting industry faced other obstacles. In their earliest years, Indian cutting establishments had great difficulty obtaining rough. Their fortunes were helped by two events.

First, two African countries—Ghana in 1962



and Zaire during most of the period 1973 to 1981—stopped selling their diamonds through the CSO (“Putting the Argyle story. . .,” 1996; Sevdermish and Mashiah, 1996), which made it possible for India to obtain needed rough (albeit, sometimes through illicit channels) from primary sources. Because Ghanaian production (like that of Zaire) was frequently of very poor quality, some dealers and cutters such as Jasani (1971, p. 25), were led to bemoan that “the rough diamonds that are imported are mostly industrial and industrial sand. . .” and that “We fail to understand as to how industrial diamonds could be cleared [as] gem variety [sic].” These industrials would, in time, gain a modicum of respectability as near-gems.

Second, in 1964, the first indigenous Indian sightholder was appointed (“Diamond trading over fifty years,” 1984), which attested to recognition by De Beers of India’s growing diamond industry (although the first Indian sightholder, based in Antwerp, was appointed in 1959). By 1970 this number had risen to 12, and in recent years there have been about 45 indigenous Indian sightholders (“India expands on all fronts,” 1989; “Recovery waiting in the wings,” 1994) out of about 160–170 sightholders worldwide (Miller, 1995; “Five new sightholders appointed,” 1997). During the period 1965–1984, most of the low-value stones purchased from De Beers probably originated from De Beers mines in South Africa (e.g., Premier and Finsch), from the Soviet Union (the vast majority of which were marketed through De Beers at that time), and later from Botswana (Orapa, with a high proportion of near-gems, opened officially in 1972 with production of 2.5 Mct [million carats] annually; Jwaneng started production in 1982 with 5 Mct annually). As this period ended, India was receiving about 25–30 Mct of rough annually (table 1, column 2).

From 1973 to 1988, the amount of rough supplied directly by De Beers varied from approximately 25% to 50% of India’s annual rough imports; however, De Beers typically supplied an additional 15% to 20% indirectly through Antwerp sightholders who received rough solely for India (Chhotalal, 1984; “India expands on all fronts,” 1989).

Perhaps the single greatest influence on the Indian cutting industry was the 1979 discovery of the Argyle mine in Western Australia. The mining of alluvials associated with this mine started in 1983, and 6.2 Mct were recovered that year. Mining of the Argyle (lamproite AK1) pipe proper started in December 1985, and ushered in the greatest expan-



*Figure 3. Gujarat State grew quickly into a diamond “boom town” during the 1970s and 1980s, and informal street markets where traders bought and sold rough and polished diamonds proliferated around the city. This market on Rampura Road was the city’s largest. Photo by Russell Shor.*

sion in the annual production of rough diamonds the world has ever seen. Nevertheless, the vast majority of the stones from Argyle are small, low-quality near-gems that can only be cut economically in India (or some other low-wage country). Concurrently, on the demand side, there was a great expansion of retailing formats in mass merchandising throughout the world, but primarily in the United States, that has provided a broad market outlet for inexpensive, mass-produced diamond jewelry (Boyajian, 1988; Shor, 1993). Thus, the favorable dual factors of supply and demand were instrumental in stimulating the explosive growth of the Indian diamond cutting industry.

From figure 4 (see also table 1, column 2), it can be seen that with the growth of mining at Argyle, the import of rough into India approximately doubled from 1984 (about 26 Mct) to 1991 (about 55



**TABLE 1.** Diamond cutting production in India from 1966 to 1996, on a weight basis.<sup>a</sup>

<sup>1</sup> Year	<sup>2</sup> Imports of rough diamonds into India (Mct)	<sup>3</sup> Exports of polished diamonds from India (Mct)	<sup>4</sup> Yield for diamonds cut in India (%)	<sup>5</sup> Total world polished production, or amount sold at wholesale (Mct)	<sup>6</sup> Percentage of the world's diamonds polished in India
1966	<i>1.35</i>	<i>0.23</i>	(17)	<i>3.9</i>	6
1967	<i>1.70</i>	<i>0.29</i>	(17)	<i>4.1</i>	7
1968	<i>3.24</i>	<i>0.55</i>	(17)	<i>4.2</i>	13
1969	<i>2.82</i>	<i>0.48</i>	(17)	<i>4.6</i>	10
1970	3.08	0.53	17.2	<i>4.8</i>	11
1971	3.94	0.66	16.8	<i>4.8</i>	14
1972	4.36	0.80	18.3	<i>5.1</i>	16
1973	5.96	1.69	28.4	<i>6.0</i>	28
1974	3.71	1.07	28.8	<i>5.5</i>	19
1975	5.57	1.00	18.0	<i>5.1</i>	20
1976	8.82	1.92	21.8	<i>5.8</i>	33
1977	16.89	3.10	18.4	<i>7.0</i>	44
1978	19.33	4.32	22.3	<i>8.3</i>	52
1979	15.80	4.46	28.2	<b>7.9</b>	56
1980	18.71	4.15	22.2	<b>7.5</b>	55
1981 <sup>c</sup>	26.36	4.06	15.4	<b>7.8</b>	52
1982 <sup>c</sup>	25.40	4.66	18.3	<b>7.9</b>	59
1983 <sup>c</sup>	28.38	5.65	19.9	<b>8.5</b>	66
1984 <sup>c</sup>	26.28	5.07	19.3	<b>9.2</b>	55
1985	34.64	5.41	15.6	<b>9.9</b>	55
1986	39.92	7.52	18.8	<b>11.4</b>	66
1987	46.52	8.49	18.3	<b>13.2</b>	64
1988	54.06	11.03	20.4	<b>14.5</b>	76
1989	59.70	10.11	16.9	<b>14.7</b>	69
1990	37.13	8.34	22.5	<u>14.2</u>	59
1991 <sup>d</sup>	54.59	8.72	16.0	<b>13.6</b>	64
1992 <sup>d</sup>	72.29	11.03	15.3	<b>15.0</b>	74
1993 <sup>d</sup>	69.61	13.99	20.1	<u>16.6</u>	84
1994 <sup>d</sup>	69.17	15.98	23.1	<u>18.2</u>	88
1995 <sup>d</sup>	89.90	19.21	21.4	<b>19.7</b>	98
1996 <sup>d</sup>	101.28	18.88	18.6	<b>20.5</b>	92

<sup>a</sup>Numbers in italics are calculated, in parentheses are estimated, underlined are extrapolated, and (in column 5) in bold are actual reported values. Mct = millions of carats.

<sup>b</sup>The Indian financial year runs from April through March. Hence, Indian annual diamond statistics that appear, for example, as 1970/71 or 1989/1990 (e.g., Chhotalal, 1984, table 3) are shortened here to 1970 and 1989, respectively. However, because no other data for the diamond industry in the rest of the world are reported in this manner, the "years" in this paper are not exactly comparable with others worldwide.

<sup>c</sup>The period 1981–1984 was characterized by a decrease in De Beers's sales, "destocking," and an increase in demand for small diamonds cut in India (see, e.g., Boyajian, 1988).

<sup>d</sup>The period 1992–1996 was characterized by imports of large amounts of Russian near-gem rough, and stockpiling of some exported but unsold polished goods.

<sup>e</sup>Sources of information for columns 2 and 3:

- 1966–1969: Column 2 is calculated (column 3 ÷ column 4) x 100.
- Column 3 is calculated from financial data (value of exports in rupees) in Directory of Exporters 1983 (1984), and based on the number of carats (0.53 million) and their value

exported from India in 1970 (Chhotalal, 1984). Allowance has been made for the rupee being worth 16% more in 1966 than in 1967–1970 (as reported in "International financial statistics," 1988).

- 1970–1979: Chhotalal (1984, table 1)
- 1980–1994: "India's rude awakening" (1996)
- 1995–1996: "Gems & jewellery exports record-downtrend in 1996–97" (1997)

<sup>f</sup>Obtained by the formula:

$$(\text{column 3} \div \text{column 2}) \times 100$$

The yield for 1966–1969 was estimated at 17%, comparable to values obtained for 1970–71.

<sup>g</sup>For 1966–1978, calculated values were obtained with the following formula:

$$\text{Total world polished production} = \text{world production of rough [carats]} \times 0.25 [\% \text{ gems}] \times 0.40 [\text{estimated average yield}] + \text{Indian polished exports.}$$

Annual world production of rough diamonds was obtained from U.S. Bureau of Mines (1966–1978). The formula is used only for years prior to 1979, when there was no "Argyle factor," i.e., large amounts of near-gems and industrials, to consider. The fact that before 1979 about 25% of the world's diamonds were gems and thus cuttable (i.e., the "0.25" factor), and the average yield from such rough was about 40% (the "0.40" factor), can be found in Levinson et al.,

(1992) and in Diamonds: A Cartel and Its Future, (1992), respectively. The polished production originating from India is obtained from near-gem rough with low average yield (averaging 20%; see column 4) and is not covered in the first part of the equation. Hence, the amount of Indian polished (from column 3) is added to that obtained by calculations from the traditional gem material to obtain the world total.

For 1979–1996, boldface values reflect the number of carats sold at wholesale for manufacture into jewelry (excluding stockpiled goods), for which there are data for most years since 1979. Thus, we are assuming that the amount of diamonds polished worldwide was approximately equal to the amount sold.

References:

- 1979: Johnson et al. (1989, table 7)
- 1980–1987: "Value of diamond jewelry sold..." (1988)
- 1988–1989: "World diamond jewellery consumption" (1991, table 6)
- 1991: De Beers (1992, p. 33)
- 1992: Even-Zohar (1993, p. 78)
- 1995: "World diamond jewelry sales" (1996)
- 1996: "1996: Diamond content equals record 1995" (1997)

<sup>h</sup>Obtained by the formula:

$$(\text{column 3} \div \text{column 5}) \times 100$$

Mct). About 30 Mct of Argyle's annual production of 40 Mct apparently went to India (e.g., "India's rude awakening," 1996). Through June 1996, most Argyle diamonds were marketed by De Beers. Now all of these stones are marketed independently through Argyle's office in Antwerp, but most continue to be cut in India.

**The Indian Industry.** As the Indian diamond industry expanded, so did the influence of the Palanpuris. As the major indigenous sightholders, they supply most of the rough to the cutting factories, many of which they own. Further, they enjoy a near-monopoly in the international sale of polished stones by virtue of their control of a sprawling sales network for polished diamonds, which Lakhi (1997) estimates exceeds 1,000 offices worldwide. In recent years, there has been considerable vertical integration of the diamond industry, which now includes jewelry manufacturing (figure 5). Most of this also is dominated by the Palanpuris. Since the early 1990s, however, a new entrepreneurial class of diamantaires, who learned the diamond business mainly as employees of the Palanpuris, has emerged: the Kathiawaris. Their name is derived from Kathiawar, an agricultural region also in Gujarat, but they differ significantly from the Palanpuris with whom they now compete. Not only are they of rural origin and modest financial means, but they also are Hindus. At least four have become sightholders (Lakhi, 1997).

Notwithstanding the aforesaid, it was the economic viability of cutting low-quality, low-yield rough with low-cost labor by skillful and industrious artisans that formed the basis for the modern diamond cutting industry in India (figure 6). Stuyck (1969, p. 20) described the cutting industry in the early days as "almost exclusively a cottage industry. From five to ten persons work together in their own cottages. They have had no formal training. They learn by doing." These workers were not covered by general labor legislation and were paid on a piece-rate basis. Even recently labor costs have been described as "infinitesimal" ("Small diamonds, big business," 1995, p. 38) or one-sixth ("Maintaining its global position," 1994, p. 68) compared to those of the cutting centers of Belgium and Israel. Interestingly, the cost of polishing small stones in India has not changed much over the last two decades in terms of dollar amount, averaging about \$1 each (Lawrence, 1996). This is largely because the rupee has been depreciating against the dollar at an annual rate of about 10%, which has been

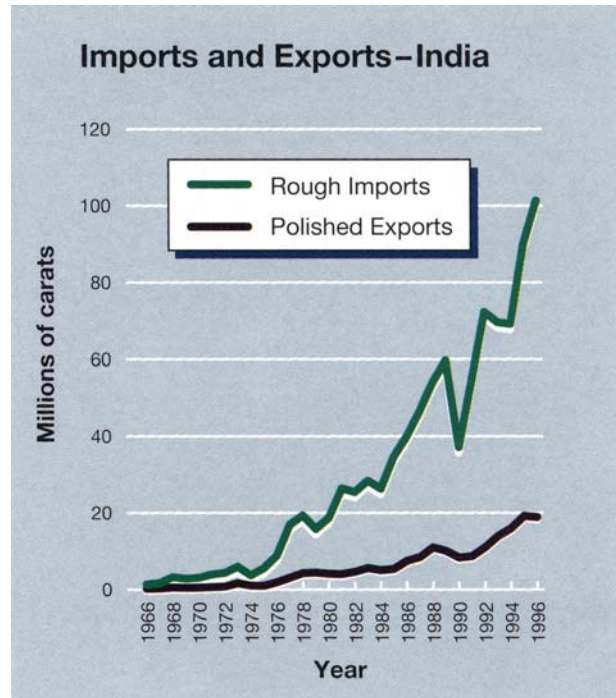

Figure 4. This graph plots, in millions of carats, the amount of rough diamonds imported into—and polished diamonds exported from—India from 1966 through 1996. It is based on data in columns 2 and 3 of table 1. (Note: The slope of the polished exports curve is dependent on the cutting yield, which was generally 15%–23% of the weight of the rough; hence, although both curves in this figure represent increasing quantities, they are not parallel on an arithmetic scale.)

enough to counterbalance the local rate of inflation.

Over the decades, however, there has also been a shift toward the formal training of diamond cutters ("Technical training," 1994) and the establishment of large, automated factories to keep pace with the vast amounts of rough coming into the country (figure 7). This has resulted in a rise in productivity and yield levels, as well as in improved "make"; automation has also had an offsetting effect on rising labor costs. Nevertheless, the cottage-industry sector still flourishes, as evidenced by the fact that there are "an estimated 30,000 small, medium, and large diamond cutting and polishing units" ("India's rude awakening," 1996, p. 92), but only about 5,500 of these are large enough to be called companies (Scriven, 1997). Further, about 50% of India's workforce is made up of "contract workers" (Lawrence, 1996), who generally do not work in modern factories. Attesting to the skill of the experienced Indian worker is the fact that full automation, relative to the good artisan workforce,



Figure 5. In recent years, India has developed a significant jewelry manufacturing industry for the small, inexpensive diamonds cut there. These typical pieces, from Simplex Diam Inc., were developed specifically for the large chains and mass merchandisers that have dominated the American market in the 1980s and 1990s. Courtesy of the Indo Argyle Diamond Council.

would probably boost yield only by one or two percentage points (Lawrence, 1996).

After about 1966, the Indian cutting industry grew rapidly but approximately in step with the rest of the world diamond industry, except for two periods: 1981–1984, when it was stronger than the rest of the industry; and 1992–1996, when it was weaker.

1981–1984. For the four years following the 1980 collapse of the speculative boom in diamonds, De Beers's sales averaged only about 55% of what they had been in 1980. Yet the total value of world retail diamond sales (as measured in billions of U.S. dollars) was unaffected (discussed below). This phenomenon is explained by "destocking" (i.e., retailers sold from stock but were not restocking to the same levels, so suppliers were not selling and thus were not buying from the major polishing centers; Boyajian, 1988). Although some retailers (such as some traditional stores) suffered losses, others

(specifically the discount stores and mass merchandisers in the United States, whose business was primarily based on low-cost Indian-cut stones) even thrived. During these turbulent times, there was actually a dramatic increase in demand for jewelry containing inexpensive diamonds produced in India.

1992–1996. Since 1992, the rough near-gem market has been destabilized (as have other categories of diamonds to a lesser extent; Pearson, 1996b) by the "dumping" of diamonds from Russia. Following the breakup of the former Soviet Union, the new nation of Russia needed foreign currency. One source of such revenue were the diamond stockpiles (rather than new mine production) that had been built up over more than three decades ("Flooding the diamond markets," 1993; Shor, 1994). In 1992, Russia began to "leak" large quantities of these diamonds outside established channels, a practice that continues today. The arrival (often referred to as "dumping") of these millions of carats of Russian rough diamonds on the world markets outside the contractual arrangements between De Beers and Russia soon weakened the price of polished Indian goods. It also constituted a serious challenge to De Beers's regulation of the rough diamond market (e.g., "Leakages hit CSO market share," 1996).

Pearson (1996b) reported that Russian stockpile reductions of "technical goods" (which includes near-gems) increased in 1995. Estimates are that Russian stockpile reductions (all categories) were 18.5 Mct and 12.3 Mct in 1995 and 1996, respectively; in both years new mine production worldwide was about 111 Mct ("A year of overfeed," 1996; "Supply set to be outstripped . . .," 1997). We believe that the vast amounts of rough diamonds available since 1992 have had a greater impact on the Indian segment of the diamond industry than on the rest of the gem cutting industry, although we do not know exactly how much of this Russian rough was near-gem destined for India. From the data in table 1 (column 2), however, it appears that since 1992 no more than 60 Mct (after subtracting Russian leakage) of rough imports annually could have been obtained by India through normal channels, that is, from the CSO either directly or indirectly, or through normal "outside (non-CSO) sources" in Antwerp. Amounts in excess of 60 Mct are assumed to have come from various other outside (open market) sources, but primarily from Russia. Today, about 30% of India's rough is supplied directly by De Beers (to indigenous Indian sight-holders), about 30% is from sight-holders in



Antwerp and Israel, and the remainder is obtained on the open market (Mehta, 1997).

### INDIAN DIAMOND CUTTING PRODUCTION

The development of the Indian diamond cutting industry from 1966 through 1996 (the most recent year for which data are available), and the critical role it has played in the world diamond trade, can be traced by looking at the statistics for production by weight (table 1) and by value (table 2) during these three decades. These data form the basis for the balance of the discussion in this article.

**Sources of Data.** The data for this article were taken from the published literature. Where data for certain years are not available, we resorted to estimation by means of extrapolation or calculation. All such cases are clearly identified in the tables.

Data found in different published sources often contradict one another. Moreover, occasionally it has been claimed that certain data, frequently from official sources, are in error. A case in point is the statement that official Indian export figures (dollar value) for 1988–1989 are significantly underreported and, as a consequence, that author has supplied the “real figures” (“India expands on all fronts,” 1989). Similar statements have been made with respect to the official Indian rough import and polished export figures for 1993 (Miller, 1995). Notwithstanding the good intentions of the authors of such information, and even the strong possibility that they are correct, for consistency we always use the official figures. Wherever possible, the data (e.g., amount of imported rough, polished production, and sales statistics) presented in tables 1 and 2 come from the Gem & Jewellery Export Promotion Council (GJEPC), a nonprofit, autonomous organization of diamond merchants established in 1966 and operated under the supervision of the Ministry of Commerce of India. These data were usually not available to us directly from GJEPC, but rather we obtained them from secondary sources, which we reference. We consider these data on the Indian gem industry to be the best available. We also consider data in certain journals (e.g., *Diamond International*, *Mazal U’Bracha*) to be highly reliable and use these where appropriate. However, we are aware that errors of 10%–15% are a distinct possibility for reasons that we discuss at various places within the text.

**Production by Weight (Table 1).** *Imports of Rough Diamonds into India.* There was a dramatic 75-fold



Figure 6. In 1985, workers at this brutting contractor shop in Surat still used manual equipment and sat on the floor. Photo by Russell Shor.

increase (by weight) in the import of rough diamonds into India from 1966 to 1996, as is evident in column 2 of table 1 and is shown graphically in figure 4. (We have assumed, as have others who have written on this aspect of the Indian diamond industry [see, e.g., Sharma, 1991, 1992; Jhaveri, 1994; “India’s rude awakening,” 1996; Lakhi, 1997], that all the imported rough was cuttable (predominantly near-gems) although it is likely that the yield from some of this material is extremely low and that a

Figure 7. Shrenuj Co. was one of the first companies to develop a modern, semi-automated diamond factory in Bombay in 1988. Photo courtesy of Shrenuj Co.



---

small percentage of industrial stones is included in the import figures.) The increase is characterized by quantum jumps in imports at certain times, and one interval with a significant decline.

- **1976–1977 (91% increase).** Rough imports almost doubled during the speculative boom of 1976–1979 (see Boyajian, 1988). Although this boom primarily involved “investment” and “certificate” goods because of high inflation worldwide, demand also increased for lower-priced diamonds.
- **1980–1981 (41% increase).** After the end of the speculative boom, demand for less-expensive diamonds increased relative to that for more expensive grades.
- **1984–1989 (127% increase).** During this period, the world market grew rapidly for all kinds of polished diamonds, including the cheaper goods from India (particularly because of the expanding Japanese market, caused by the strong yen; Boyajian, 1988). India responded by sharply increasing its cutting capacity, which peaked in 1989. To feed this greater capacity, Indian manufacturers increased the amount of rough imported, more than doubling it between 1984 and 1989, to about 60 Mct.
- **1989–1990 (38% decrease).** Starting in 1989, the demand for Indian polished diamonds began to decline, and by 1990 imports of rough fell to about 37 Mct, that is, to about the level of 1986. The main reason given for this decline was an economic downturn (“World market trends,” 1991). This downturn affected the low-value Indian goods more than it did the better-quality goods, which is opposite to what had occurred during the downturn of 1981–1984 discussed in the “Background” section. World retail diamond jewelry sales, as measured in U.S. dollars, were stable during the period under discussion (see below).
- **1991–1992 (32% increase).** Notwithstanding the difficulties encountered by the Indian polishing industry in 1989–1990 (plus a major financial and political crisis in India in 1991 that temporarily restricted foreign exchange transactions; “Diamonds today. Part 2,” 1992), vast amounts of low-quality rough began to be imported from Russia.
- **1994–1996 (46% increase).** The dramatic increase in the import of rough can again be

attributed primarily to Russia’s sale of vast amounts from its stockpile (Pearson, 1996b). The magnitude of the 101 Mct of rough imported into India in 1996 is put into perspective when it is recognized that the world’s total production of newly mined diamonds for that year was about 111 Mct (“Supply set to be outstripped . . .”, 1997). As a result of the overstock situation, the Indian diamond community debated imposing a moratorium on the import of rough, but none was enacted (“Indians debate import moratorium,” 1996).

*Exports of Polished Diamonds from India.* Imported rough is polished and then exported to jewelry manufacturers as rapidly as feasible. Indian export normally lags behind import only for the time needed to cut and polish the goods (about three months, or an additional one to two months if the rough is handled by a dealer who is not a sightholder, rather than by a sightholder who is a cutter (*Diamonds: A Cartel and Its Future*, 1992). Hence, the amount of polished diamonds exported from India (table 1, column 3; figure 4) approximately follows the amount of rough imported.

The world economy, particularly as it is affected by the U.S. and Japan, is the main determining factor in how rapidly newly polished diamonds are sold. Thus, since the economic downturn (except for the U.S. and a few other countries) that started in 1989, India generally has been cutting more diamonds than could be consumed in the marketplace. Since 1993 especially, significant amounts of Indian polished diamonds have been exported and then stockpiled abroad at foreign sales offices or with affiliates and/or major dealers so that inventory would be closer to the eventual end user (Lakhi, 1997). Nevertheless, from 1966 to 1996, the 82-fold increase in polished exports from India is qualitatively consistent with the 75-fold increase in rough imports during the same period (table 1).

*Yield for Diamonds Cut in India.* The yields (weight retained after cutting, expressed as a percentage of the rough weight; also called retention) for the polished exports are presented in column 4 of table 1 and are evident in figure 4 by the gap between the rough and polished quantities; again this assumes that all rough imported into India was cuttable. Yields range from 15.3% to 23.1% (average, 18.7%). (Excluded are 1973, 1974, and 1979, for which the values are over 28%. These high values are explained by the large amounts of stones that

were unofficially imported from Zaire and thus were not recorded in import data but were reported in polished exports; see "Background" for further details.) Similar yields have been reported by others for near-gems; for example, Johnson et al. (1989) reported weight loss as ranging from 75% to 85% (yield 15%–25%).

*Total World Polished Production (or Amount Sold at Wholesale).* To place the contribution of India in perspective with respect to polished diamond production worldwide, it is necessary to know the total amount of polished produced in the world annually. Unfortunately, such data are not available in the literature, so we have estimated them using two methods. First, total world production of polished can be equated to the amount (number of carats) of polished diamonds sold at wholesale, for which there are data for most years since 1979. This is based on the assumption that, as a generalization, most diamonds are sold at wholesale in the year they are polished; exceptions exist for certain years (particularly since 1993) when there were oversupplies of polished, but these will not materially affect our conclusions. Second, it is possible to calculate the approximate amount of diamonds polished in any year—the formula and explanation for which are given in the table 1 footnotes. Similar formulas have been used in the past (e.g., Komkommer, 1965). We used this approach for 1966–1978. Our estimates are presented in column 5 of table 1.

*Percentage of the World's Diamonds that Are Polished in India.* The amount of diamonds polished in India (table 1, column 6; figure 8) probably was only 6% of the world's supply in 1966. In slightly more than a decade (by 1978), India had experienced a nine-fold increase, to more than 50% of the world's supply (on a weight basis). This percentage has continued to rise, but at a much slower rate. By 1989, at the peak of the period 1984–1989 (mentioned above) during which the world diamond market grew rapidly, we estimate that India was polishing 69% of the world's diamonds. This was due to strong demand and further downtrading (i.e., more use of less-expensive diamonds) in the U.S. and Japan, which made it possible for the Indian industry to use the lower grades and smaller sizes of Argyle rough that became available in this period.

Since the late 1980s, there has been a common perception throughout the diamond industry that India has supplied about 70% of the world's polished diamonds by weight (e.g., Sharma, 1992;

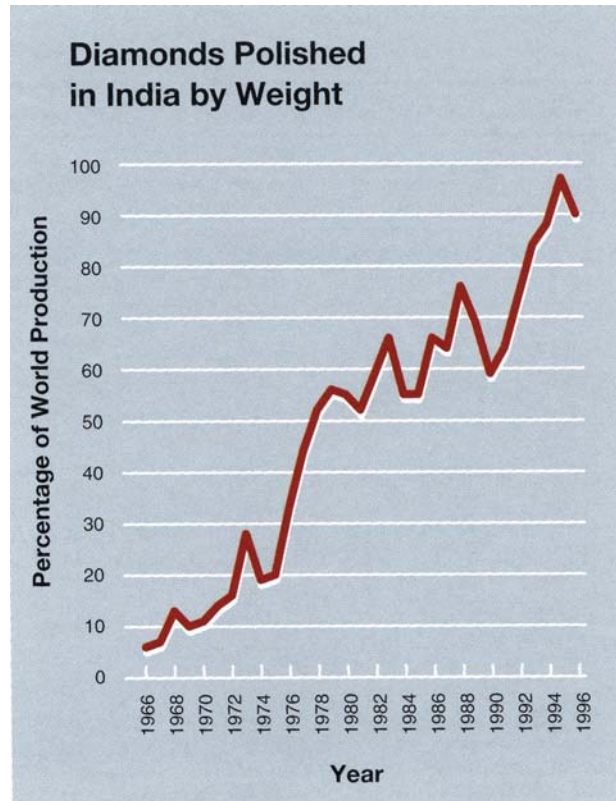

Figure 8. For 20 years now, India has been responsible for polishing more than 50% (by weight) of the world's supply of polished diamonds. Although the calculations on which this graph is based suggest that this percentage might have risen to as high as 98% in recent years, the authors believe that these are aberrations and that 70% is more realistic overall. Data are shown in table 1, column 6.

"India's rude awakening," 1996). During 1992–1996, our calculations suggest that India produced 74%–98% of the world's supply of polished diamonds (table 1, column 6). We believe that the incremental percentages above 70% are aberrations. They probably result from the export and storage abroad of polished near-gems, comparable to amounts "dumped" by the Russians during this period, for which there was no immediate sale. Such large percentages will not be sustainable into the significant future because of the expected depletion of the Russian stockpile in a few years.

**Production by Value (Table 2).** *Value of World Polished Diamond Sales.* To determine the value of the diamonds polished in India since 1966 in comparison with the rest of the world, we first compiled the total annual polished wholesale value of diamonds worldwide for the period 1966–1996 (table 2, column 2). Because published data were only avail-



**TABLE 2.** Diamond cutting production in India and global jewelry statistics from 1966–1996, on a value basis.<sup>a</sup>

1 <sup>b</sup> Year	2 <sup>e</sup> Value of world polished diamond sales (wholesale, millions of US\$)	3 <sup>f</sup> Export value of polished diamonds from India (wholesale, millions of US\$)	4 <sup>g</sup> India's share of the world polished diamonds (wholesale, % of the diamond market)	5 <sup>h</sup> Value of India's polished exports on a per-carat basis (wholesale, US\$ per carat)	6 <sup>i</sup> World retail diamond jewelry sales (billions of US\$)	7 <sup>j</sup> Value of diamond content in world jewelry (% of retail sales)
1966	872	17	1.9	74	n.a.	-
1967	859	21	2.4	72	n.a.	-
1968	1,048	40	3.8	73	n.a.	-
1969	1,208	34	2.8	71	n.a.	-
1970	926	37	4.0	70	n.a.	-
1971	1,094	50	4.6	76	4.5	24
1972	1,486	78	5.2	98	5.4	28
1973	2,314	101	4.4	60	6.9	34
1974	2,195	106	4.8	99	7.2	30
1975	1,866	118	6.3	118	8.7	21
1976	2,721	258	9.5	134	8.7	31
1977	3,628	498	13.7	161	10.8	34
1978	5,104	846	16.6	196	13.8	37
1979	5,196	677	13.0	152	16.1	32
1980	5,446	703	12.9	169	20.7	26
1981 <sup>c</sup>	2,760	797	28.9	196	20.3	14
1982 <sup>c</sup>	2,357	945	40.1	203	19.1	12
1983 <sup>c</sup>	2,998	1,109	37.0	196	20.8	14
1984 <sup>c</sup>	3,024	1,002	33.1	198	22.3	14
1985	3,418	1,065	31.2	197	23.6	14
1986	4,794	1,511	31.5	201	31.1	15
1987	5,766	1,877	32.6	221	37.7	15
1988	7,823	2,904	37.1	263	44.0	18
1989	7,700	2,986	38.8	295	45.7	17
1990	7,813	2,641	33.8	317	45.4	17
1991 <sup>d</sup>	7,609	2,500	32.9	287	46.5	16
1992 <sup>d</sup>	6,663	2,867	43.0	260	47.0	14
1993 <sup>d</sup>	8,710	3,657	42.0	261	48.3	18
1994 <sup>d</sup>	10,600	4,032	38.0	252	50.1	21
1995 <sup>d</sup>	10,800	4,662	43.2	243	52.7	20
1996 <sup>d</sup>	11,000	4,235	38.5	224	51.5	21

<sup>a</sup>Numbers in italics are calculated; n.a. = not available; - = not calculated.

<sup>b</sup>See footnote b in table 1.

<sup>c</sup>See footnote c in table 1.

<sup>d</sup>See footnote d in table 1.

<sup>e</sup>Published data for this column are available for the following years:

1989: "World market trends" (1991, p. 10)

1991: De Beers (1992, p. 33)

1994: "Leakages hit CSO market share" (1996, p. 22)

1995: Schnitzer (1996, p. 59)

1996: Even-Zohar (1997, p. 40)

For other years, it was necessary to calculate an approximate value using the formula:

$$\text{Value of world polished diamond sales} = \text{De Beers's annual sales} \times \text{CF1} \times \text{CF2}$$

The first conversion factor (CF1) normalizes the value of De Beers's annual sales of rough to the value of all rough diamonds produced in the world. For 1966–1991, CF1 = 1.25, based on De Beers's traditional 80% control of the rough diamond market:  $1 \div 0.80 = 1.25$ . For 1990–1996, CF1 gradually changes from 1.30–1.50 to account for De Beers's decreasing control of the rough diamond market, to about 70% in mid-1996 (Pearson, 1996a) and even less

since July, 1996, when the production from the Argyle mine was marketed independently of De Beers.

The second conversion factor (CF2), also a multiple of De Beers's annual sales, takes into account: (a) cutting costs (generally 5% to 20% of the cost of rough); and (b) other costs (including profit, handling charges, etc.) which we estimate at about 25% of cost of the rough. For 1966–1986, when more expensive rough was cut on average, CF2 = 1.4 ( $1.10 [\text{cutting costs}] \times 1.25 [\text{other costs}] = 1.375$ ). However, in the speculative period of 1978–1980, when profits (of 10–30%) were made on rough before it was cut, the CF2 rises to 1.6. From 1987 onwards when the amount of near-gems cut in India increased greatly, CF2 is 1.5 ( $1.20 [\text{cutting costs}] \times 1.25 [\text{other costs}] = 1.50$ ). The relative cost of cutting lower quality (near-gem) diamonds is more than it is for cutting better quality goods.

Calculations using conversion factors similar to those above have been used in the past (e.g., Komkommer, 1965). Further information is available upon request to the authors.

<sup>f</sup>References:

1966–1969: Directory of Exporters, 1983 (1984)

1970–1979: Chhotalal (1984)

1980–1995: "India's rude awakening" (1996)

1996: "Gems & jewellery exports record downturn in 1996–97" (1997)

Note: For 1966–1969 and 1970–1979, conversion of rupees to US\$ was made using conversion rates from "International financial statistics" (1988).

<sup>g</sup>Obtained by the formula:

$$(\text{column 3} \div \text{column 2}) \times 100$$

<sup>h</sup>Obtained by the formula:

$$\text{column 3} \div \text{column 3 in table 1}$$

<sup>i</sup>References:

1971–1978: Diamonds: Past, Present & Future (1992, p.16)

1979: Johnson et al. (1989)

1980–1995: "Japan holds the key" (1997, p. 42).

Note: These data are higher than those reported in the past, and represent new revised figures, although this is not specifically stated. "About 10–12 per cent of the American diamond jewellery market [in smaller stones] at polished wholesale value was not accounted for under De Beers's traditional research methods" ("Marketing to the masses," 1996, p. 3).

1996: "1996: Diamond content equals record 1995" (1997).

<sup>j</sup>Obtained by the formula:

$$(\text{column 2} \div \text{column 6}) \times 100$$

able for five years (1989, 1991, and 1994–1996), we had to calculate most of this information. Details of how these values were calculated are presented in the footnotes to table 2.

*Export Value of Polished Diamonds from India.* The value of Indian polished production was negligible before the mid-1960s. In the 24-year period 1966 through 1989, the value of polished exports rose steadily from \$17 million to \$2,986 million—a 175-fold increase (table 2, column 3; figure 9). Even during the post-speculative-boom period of 1981–1984, when diamond sales worldwide declined, there was no downturn in demand for the small diamonds cut in India. In fact, the export of polished diamonds increased from \$797 million in 1981 to \$1,002 million in 1984 (table 2, column 3).

The decline in the export of polished diamonds by weight during 1990–1991 from the period immediately preceding is reflected in a similar decline in the total value of polished exports, from \$2,986 million in 1989 to \$2,500 million in 1991 (table 2, column 3). Following the low of 1991, however, the value of polished exports rose rapidly, and by 1995 they were up 86%. Again, this is due primarily to the export of large amounts of polished Russian near-gems, some of which were not sold but were stored as inventory abroad. It is interesting to observe that between 1995 and 1996 exports dropped, but they dropped much more in terms of value (9%) than of weight (1.7%; see table 1, column 3), which attests to the perils of oversupply. Nevertheless, between 1966 and 1996, the total value of polished diamonds exported annually from India increased 249-fold overall.

*India's Share of the World's Polished Diamonds.* India accounted for only 1.9% by value of the world's (wholesale) polished production in 1966 (table 2, column 4; figure 10). In general, this percentage increased gradually (at an average of about 1.5% per year) until 1989, when it reached 38.8%. During the speculative era of 1979–1980, the percentage declined slightly, primarily because the price of larger, higher-quality gem diamonds had risen considerably (see Boyajian, 1988). The major jump from about 29% in 1981 to 40% in 1982 can be attributed to the fact that sales of more traditional gem diamonds declined significantly following the speculative period.

Since the late 1980s (1988–1996), India's contribution to the world polished diamond market by

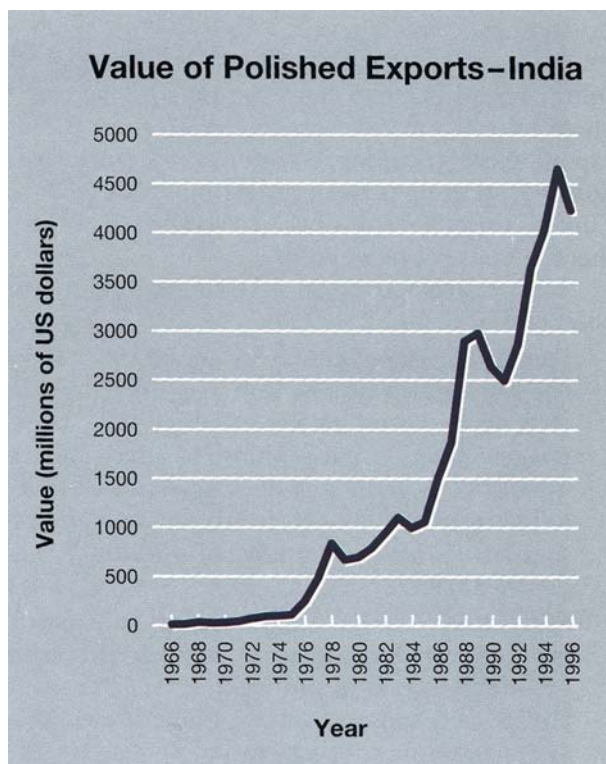

Figure 9. During most of the period 1966–1996, the value of India's polished exports increased steadily, 249-fold overall. The plot is based on data in table 2, column 3.

dollar value (table 2, column 4) has averaged 38.6%. This is lower than some industry estimates of around 40% (e.g., "Technical training," 1994) but higher than the most recent estimate of 30% (Scriven, 1997). Necessarily, this value will vary over time depending on the relative value of diamonds cut in India as compared to those cut elsewhere, as well as on the relative amounts of each type sold at the wholesale level. Values above 40% (table 2, column 4) for the years 1992, 1993, and 1995 (the highest being 43.2% for 1995) are explained by the fact that large quantities of rough originating in Russia were polished in India and exported. (As indicated earlier, not all were necessarily sold, especially since 1993, when many were stockpiled [inventoried] abroad.) When these excesses are excluded, we suggest that India cut about 35% of the world's diamonds on a value basis in 1996 (and the trend is downward).

*The Wholesale Value of India's Polished Exports on a Per-Carat Basis.* The annual values for India's polished diamond exports on a per-carat basis (column 5 of table 2) show more scatter than do other

columns in this table. However, they do indicate a clear overall increase up to 1990 (when Indian exports were valued at \$317 per carat). Since then, however, there has been a decline totaling 29%. This is clearly a result of the excess polished goods that the market cannot absorb.

Noteworthy in these data are the following observations:

- During the postspeculative era of 1981–1984, the per-carat value of Indian polished goods showed an overall increase relative to the previous few years, whereas values of larger, higher-quality gem diamonds decreased (much more dramatic was the decrease in value of investment-size, investment-grade diamonds; see Boyajian, 1988).
- Since 1990, the per-carat value of Indian polished exports has decreased, whereas the value of larger gem diamonds has increased (“Antwerp Diamond Index,” 1997), a reversal of the situation that prevailed in the period 1981–1984.

Figure 10. For most of the last three decades, India’s overall contribution to the world’s supply of polished diamonds has risen in terms of value. However, in recent years there have been erratic fluctuations; based on data in table 2, column 4.

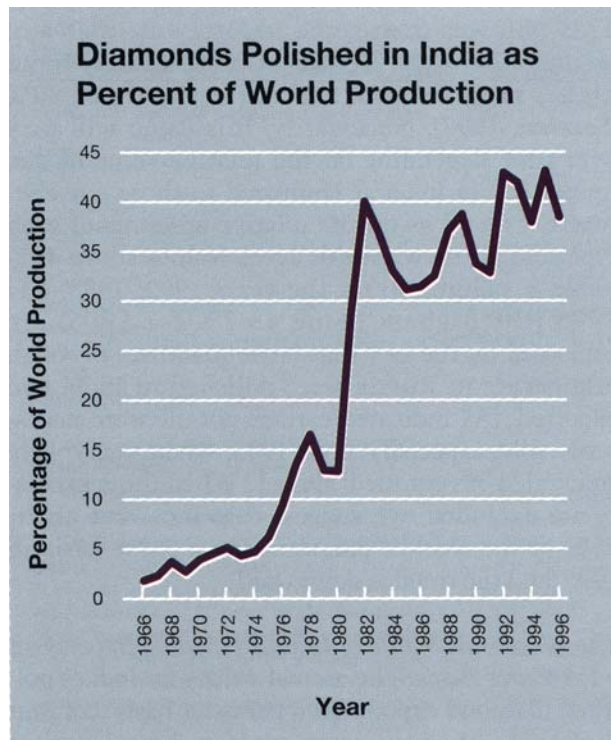

Although both trends have some basis in world economics for the particular time periods, the decline in the per-carat value of Indian goods since 1993 has been exacerbated by the glut of polished resulting from the huge amounts of rough imported from Russia.

### Indian Component of World Diamond Jewelry Sales.

*World Retail Diamond Jewelry Sales.* World retail diamond jewelry sales (i.e., what the consumer paid; column 6 of table 2 and figure 11) were compiled primarily to enable us to illustrate the important effect small, low-valued diamonds polished in India have had on the average value of the diamond content in world jewelry (table 2, column 7; figure 12). However, these sales data also provide other useful information.

Specifically, the retail value of world diamond jewelry sales has increased 11-fold since 1971. When the data are viewed in terms of world population, it can be seen that in 1971 annual diamond jewelry sales averaged almost \$1.20 for each person on Earth; by 1996 this had increased to almost \$9.00 per person (world populations for 1971 and 1996 estimated at 3.8 and 5.8 billion, respectively). Even allowing for inflation, this clearly demonstrates the recent strength of the world diamond jewelry market.

Figure 11 shows that world retail diamond jewelry sales increased by 86% between 1985 and 1988. This correlates with several significant events in the diamond industry, including a major expansion of the Indian cutting industry (again, see figures 4 and 8) and the Argyle mine’s achievement of full production in 1986 (discussed further below).

*Diamond Content (Polished Wholesale Value) in World Diamond Jewelry.* Diamonds typically constitute only a relatively small part of the total retail price of the average piece of jewelry, although higher-quality goods (and solitaires) will have a higher diamond value as a percentage of the retail price than will lower-quality goods. The “diamond content” of jewelry is expressed as polished wholesale value (pwv), which is the wholesale value (in US\$) of the diamonds contained in a piece of jewelry purchased at retail (“World diamond jewellery consumption,” 1991). Diamond content can be expressed as a percentage of the retail value of a piece of jewelry. Thus, if the pwv in a piece is \$23, and the consumer paid \$100 retail for that item, then the pwv is 23%. For this article, world wholesale polished diamond sales (column 2) are expressed



as a percentage of world retail diamond jewelry sales (column 6) to obtain the diamond content (pwv) of jewelry, on a worldwide basis, for each year (column 7). Variations in the value of the diamond content (pwv) are plotted in figure 12. Three major groupings are evident.

- **1971–1980.** During this period, the diamond content (pwv) of jewelry worldwide averaged 29.7% of retail. This value, although typical in the past, is high by today's standards. For most of this period, Indian polished goods constituted less than 50% of total world diamond production (by weight; see table 1, column 6). At this time, however, mass marketers of diamond jewelry, whose products are characterized by low-value diamond contents, had not yet made a significant impact on the retail trade (Boyajian, 1988), even though a number of American retail chains had forged links with Indian diamond manufacturers as early as 1965 (Shor, 1993).
- **1981–1984.** The diamond content (pwv) averaged 13.5% of retail value during this period, but this low value is primarily an artifact of the way in which pwv is calculated. World wholesale polished sales (column 2), one of the two components in the calculation, were abnormally low because of "destocking" by retailers following the end of the 1979–1980 "boom," which resulted in values for pwv ranging from 12% to 14% (column 7).
- **1985–1996.** During this most recent period, diamond content (pwv) averaged 17.2%. Similar low values (compared to those from 1971–1980) are reported elsewhere; for example, values of 18% have been reported for both 1988 and 1989 ("World diamond jewellery consumption," 1991). Occasionally these values were somewhat higher: Pearson (1996a) reported 22%. These low values clearly reflect the changing character of the diamond jewelry market since 1985, and they unquestionably illustrate the strong influence of low-valued Indian goods in the marketplace.

## DISCUSSION

Given the data presented above, we can now shed more light on the nature of the Indian diamond-cutting industry. As our template for this discussion, we will examine the three commonly accepted ideas that most of the diamonds cut in India are:

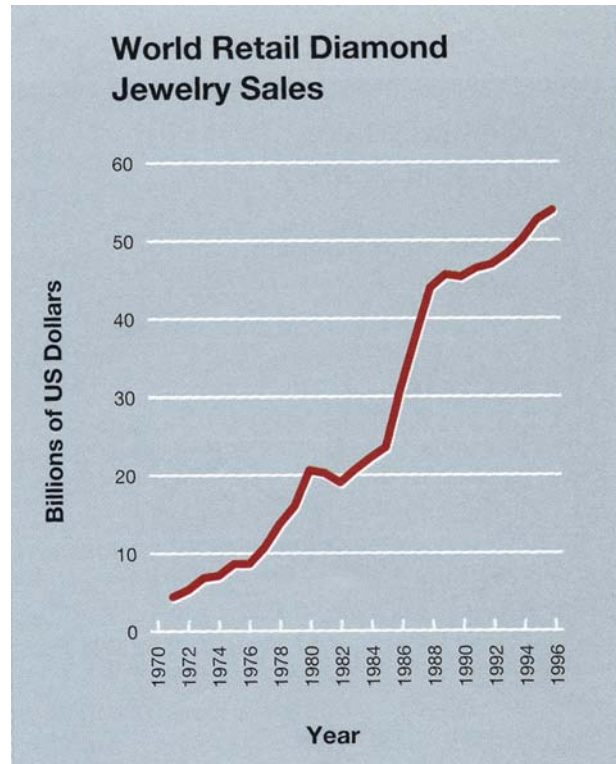

Figure 11. From 1971 to 1996, the retail value of world diamond jewelry sales increased 11-fold. This is due in part to the availability of an enormous quantity of diamonds from India. Data are shown in table 2, column 6.

- (1) exported unset to foreign jewelry manufacturers,
- (2) small, and
- (3) of low quality.

**Consumption of Diamonds Polished in India.** *Local Diamond Consumption.* Historically, there has been a tradition of diamond consumption within India (Shor, 1993). In modern times, this has continued, particularly during periods of world chaos and stress. For example, in 1936 during the Great Depression, the United States and India were the principal buyers of polished diamonds (Ball, 1937; Shor, 1993). In the 1950s, diamonds were also used in India as a hedge against the deflating rupee ("Small diamonds, big business," 1995).

Yet there are very few published (and no official) data indicating that any of the diamonds polished in India since the start of the modern diamond cutting industry there (i.e., the late 1950s) are retained for local use by the Indian population, in general, or the wealthy in particular. Officially it is assumed that all imported rough diamonds are polished and then exported.

However, statements in the literature indicate

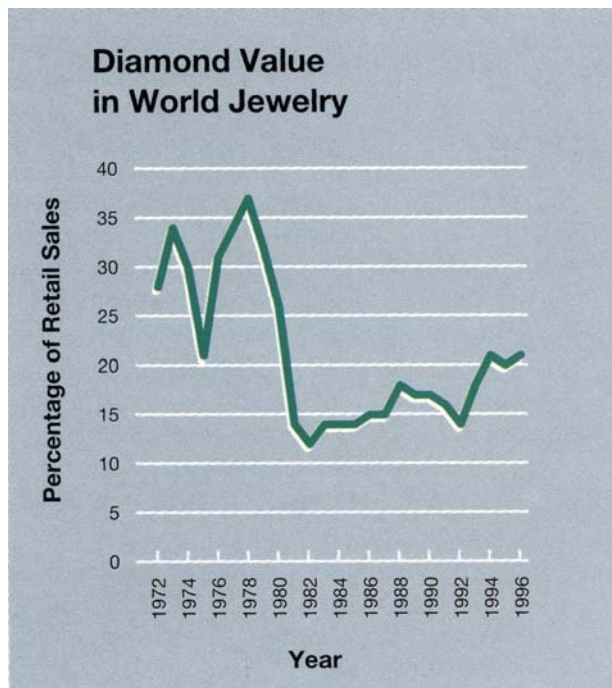

Figure 12. The diamond content (polished wholesale value) as a percentage of world retail diamond jewelry sales dropped from an average of 29.7% in 1971–1980 to a low of 13.5% in 1981–1984. Since then, it has averaged 17.2%. Based on data in table 2, column 7.

that there is a thriving local market not only for the local polished production but also for larger, good-quality stones (e.g., “The sweat behind the glitter,” 1988) that may not have been polished locally. One estimate is that in the late 1980s, 10% (by weight) of diamonds polished in India were diverted into the local jewelry trade (“India expands on all fronts,” 1989). According to our calculations from data presented by Sharma (1991), in 1989 this figure was about 6% (800,000 ct out of 13 million ct), or about 4% of the world total.

In our discussions with Indian diamond dealers (who wish to remain anonymous), we get the impression that today a figure of 10%–15% by value is realistic for the amount of local diamond production that is diverted for domestic consumption; many of these are of good quality. Thus, we conclude that India presently has a vibrant domestic market for diamond jewelry. We estimate that it is about 10% by value of its exports, which includes foreign polished goods as well; by weight, it is probably about 5%, as better qualities are sought for the local market.

It is interesting to note that even if only 5% of India’s population of about 900 million has sufficient wealth to purchase diamonds, an estimated 45 million people would be potential buyers of diamonds. The purchase of gold and silver jewelry for special occasions is a cultural tradition in India, and there is no doubt that diamond jewelry has great potential for use in this regard in the domestic Indian market. In fact, a recent report (“Indian fact-file,” 1997) indicates that India is presently the sixth largest diamond jewelry market in the world, which would be about 2%–3% of the world market, and comparable to the individual markets in Germany, Great Britain, and France.

In light of these observations, India should have appeared in every compilation of worldwide diamond jewelry markets; however, this has not been the case. One compilation published for 1992 (“U.S., Japan fuel diamond jewelry market,” 1994) is typical of those for the previous several decades: It lists the diamond market share for 25 countries worldwide, with no mention of India. In 1995, for the first time, India was listed in 10th position, with 1% of the world’s retail diamond jewelry sales (“Japan holds the key,” 1997). Given the likelihood that India is indeed the sixth most important retail market for diamonds in the world, the question arises: “How could this omission have occurred?”

*The “Gray Market.”* Several examples in the literature (e.g., “India expands on all fronts,” 1989; Miller, 1995) indicate that import and/or export figures may not be accurately reported. Above we gave evidence that there likely is a large (about 10%) “gray market” of diamonds manufactured in India, that is, a “leakage” of Indian polished diamonds to the local market (both retail and wholesale, probably), although some may be exported subsequently through unofficial channels. However, there has been no import duty on rough since 1983, and there are no taxes on exports or on profits from export earnings (see Background), so relatively little is to be gained from unofficial exports.

There are, however, taxes on other profits, and various methods are used to avoid them. Thus, some lapidaries may overinvoice on rough (or underinvoice on the cut diamonds) to offset some of the income on the polished goods, or they may report less yield than they actually get (Kaye, 1988). If, for example, in 1996 the polished yield from rough manufactured in India was actually 19.6% instead of the reported 18.6%, an extra 1,000,000

carats of polished diamonds could enter the gray market without appearing in official statistics. This would represent about 5% (by weight) of the world's total polished production for that year! The stones that are not reported often do enter this gray market. As in many countries worldwide, the small size and high value of diamonds makes them an extremely portable—and easily hidden—source of wealth, particularly useful when investing abroad or trying to minimize tax liabilities.

*Diamonds Used in Manufacturing Jewelry for Export.* Before 1989, essentially all diamonds cut in India (except those kept for local consumption and/or the gray market) were exported unset to foreign jewelry manufacturers. However, this situation is changing, as there is now a jewelry manufacturing industry in India designed for the foreign market (figure 13). Much of this activity (figure 14) is located in the Santacruz Electronics Export Promotion Zone, commonly known as SEEPZ (Shor, 1994; "From strength to strength," 1996). The amount of Indian polished consumed since 1989 by this jewelry manufacturing industry is relatively small—8% or less of total diamond production by weight (Shor, 1997)—but this is likely just the beginning of a long growth phase that will consume increasing amounts of locally polished diamonds. As the jewelry manufacturing industry expands, even fewer polished diamonds will be exported unset.

#### **Sizes and Number of Diamonds Polished in India.**

Contemporary India has typically manufactured very small polished diamonds, some even smaller than 400 stones per carat (spc; e.g., Gupta, 1988). Most of the recent reports indicate that the smallest stones are in the range of 200 spc (e.g., Shor, 1993), the cutting of which clearly requires extraordinary skill. In the early days (since the late 1950s) of the modern Indian cutting industry, 30%–35% of the Indian output was single cuts (Stuyck, 1969). More recently, however, even the smallest sizes are likely to be full cut (e.g., McDonald, 1993). During the 1990s, the average size of all stones cut in India has been given as anywhere from 50 spc (i.e., the average stone is 2 pt; Miller, 1995) to 38.5 spc (i.e., the average is 2.6 pt; calculated from Sharma, 1991, who stated that India produced 500 million polished stones totaling 13 million carats). For our general purposes, we assume that in the 1990s the average is 40 spc, that is, 2.5 pt.

Notwithstanding these small average sizes, in

recent years Indian factories have been cutting some larger and better qualities of rough. By 1989, about 10% of rough imports were said to be large enough to be sawables ("India expands on all fronts," 1989). Thus, the size of rough polished in India has increased over the past three decades. We believe that, overall, this results in larger cut sizes (even though we recognize that because sawables yield two stones per crystal, and thus have a higher yield, they may not produce as large a cut stone as a nonsawable of the same weight from which only one stone is obtained). Pravin Mehta, of New York's Occidental Gems, estimated in 1988 that 20% of the diamonds (by weight) polished in India were over 10 pt ("The sweat behind the glitter," 1988). Evidence for this can also be found in imports into the United States, the main buyer of polished (unset) diamonds from India. In the six-year period 1978–1983 (the earliest years for which we have the appropriate data), a total of 114,927 carats of polished (unset) diamonds over 0.5 ct were imported into the U.S. from India. During the 1991–1996 period, that total reached 1,004,950 carats—an almost 10-fold increase. (Numbers calculated from data in U.S. Bureau of Mines, 1979–1984, 1992–1994, 1995; U.S. Geological Survey, 1996, 1997.)

If we accept the fact that Indian polished diamonds average about 2.5 pt (40 spc), we can combine this information with the total number of carats that are polished each year (see table 1, column 3) to estimate the number of diamonds polished annually in India. Specifically, for 1996, the 18.88 Mct of polished goods that India exported represent about 755 million stones.

#### **Quality (Dollar Value) of Stones Polished in India.**

There are many statements in the literature to the effect that the quality, and hence value, of stones polished in India is low, although there are few quantitative data on this subject. Sharma (1991), for example, states that most of the Indian polished diamonds have poor clarity (I grades) and color (M-N grades are common). The fact that India exported 18.88 Mct in 1996 (table 1), for a total value of \$4,235 million (table 2), indicates an average value of \$224 per carat (table 2). For all of 1996, the "high cash asking" price (from the monthly *Rapaport Diamond Report*) for small stones (1–3 pt) in the lowest category (M-N color, I<sub>3</sub> clarity) was \$170 per carat; this rose to \$350 per carat for K-L, I<sub>1</sub>. (In recent months, prices for these categories have fallen dramatically. In the January and February 1998 issues of





Figure 13. Many companies are now involved in India's jewelry manufacturing industry. These rings were produced by, from top to bottom: Simplex Diam Inc., Precise Gem & Jewel Pvt. Ltd., Kama Jewellery (India) Ltd., Ornamentations (India) Pvt. Ltd., Sanghavi Diamonds Inc., C. Mahendra Jewels, Uni-Creation Inc., Titan Jewelry, Uni-Creation Inc., and Su Raj Jewelry. Courtesy of the Indo Argyle Diamond Council.

the Rapaport Diamond Report, the asking prices were \$100 and \$270, respectively.)

Allowing for the usual 25% "selling" discount from the above 1996 "high cash asking" prices, the resulting prices per carat (\$127.50 and \$262.50) are consistent with the conclusion that, by far, the largest portion of Indian diamonds (average of \$224 per carat in 1996) are of the lowest qualities (K-N, I<sub>1</sub>-I<sub>3</sub>), although there is a substantial portion, perhaps as much as 10%, of better-quality goods.

#### **FUTURE SOURCES OF ROUGH DIAMONDS FOR THE INDIAN DIAMOND CUTTING INDUSTRY**

The cutting industry in India is almost entirely dependent on imported rough diamonds for export

product. By the time diamond mining started in Brazil in 1730, production from India had declined to insignificance because the mines were worked out. Although organized diamond mining resumed at India's Panna mine in 1961, modern production has never exceeded 20,000 carats annually. Even if that entire quantity were cuttable, it would be consumed by the present cutting industry in about 1.7 hours! (Based on the import of 101 Mct of rough in 1996, the industry presently consumes 11,500 ct/hour, or almost 200 ct/minute.)

For India to maintain its position as the largest supplier of polished diamonds in the world, with a near-monopoly in smaller stones, a constant supply of appropriate rough is required. The availability of such supplies will depend on the discovery of new deposits to replace those that become exhausted.

Several publications have predicted that the Russian stockpile is nearly depleted (see, e.g., Miller, 1995; Picton, 1997). One of these ("Russian diamond stockpile. . .," 1997) states that it has not been replenished since 1991 and will be gone by mid-1998. This should reduce the current surplus of near-gems for the Indian cutting market.

The Argyle mine is expected to produce about 35 Mct of diamonds annually from 1997 ("No need to fear. . .," 1996) until about 2003, but beyond that its future is uncertain. In 2003, the open-pit mine (figure 15) will have reached its economic limit, about 300 m below the original surface. There are two plausible options for mining to continue. One involves some type of underground mining, but the diamond content (grade) of the ore below 300 m is 3.7 carats per tonne ("Ore reserves . . .," 1996). This is significantly less than the grade from current production (about 6 ct/tonne) and portends an uneconomic mine. The second option involves extending the present open pit to access deeper ore ("Underground operations in doubt . . .," 1997). In either event, annual production after 2003 will decline, perhaps to about 20 Mct annually, and will last for about five to 10 years depending on the mining method selected. It is also possible that the Argyle mine could close earlier should there be, for example, a severe erosion in the price brought by Argyle rough.

At present, more than 90% of Argyle's rough reportedly ends up in India, with 70% of the approximately 250,000 people in the diamond cutting industry in Ahmadabad alone reportedly employed in manufacturing Argyle diamonds ("Argyle Diamonds industry review 1997," 1997). This is

particularly interesting, inasmuch as in the past only about 40%–45% of Argyle diamonds were considered near-gem with 5% gem and the rest industrial (Boyajian, 1988). Clearly, Indian manufacturers are cutting ever-lower qualities of diamonds, probably with lower yields, especially those originating at Argyle that were previously classified as industrial.

There is no doubt that at the present time the near-gem market is still burdened with a huge stockpile of rough (as well as polished) diamonds. For example, Even-Zohar (1997) estimates the inventory of Argyle at 80–90 Mct. Nevertheless, we foresee a shortage of near-gem rough for the Indian cutting industry, perhaps as early as 2003, when the Argyle mine may close. At best, it will produce at about half its present rate. Others (e.g., "Diamond demand set to outstrip supply," 1996) predict a shortage of rough in general (as opposed to near-gems only) by the year 2000.

There is no major new mine in an advanced stage of development that could produce the volume of near-gem rough needed to replace that of the Argyle mine within six years. The announcement by De Beers that production will increase at the Orapa mine in Botswana ("Orapa capacity to double," 1996) may mean that they, likewise, anticipate a shortage of lower-quality diamonds, as the production at Orapa is over 92% near-gem or industrial ("Diamonds today. Part 1," 1992). This expansion will add about 6 Mct annually to the world's supply, but it will only partially replace Argyle's much larger contribution. Similarly, the Diavik mine, likely to start operations in 2002 as Canada's second diamond mine, should add about 8 Mct annually of quality similar to that of Orapa for 16–22 years ("Aber spends big," 1998). However, as the value of the diamonds produced at Orapa (\$50 per carat; Janse, 1996) and Diavik (\$56 per carat; "Aber spends big," 1998) is far greater than that of the Argyle diamonds (\$9 per carat; Janse, 1996), a direct comparison cannot be made based solely on the volume of rough production.

The prospect of a possible shortage of near-gem rough for the Indian cutting industry in the early part of the next century raises numerous ancillary concerns and implications. These include: the social implications of additional unemployment in a society that can ill afford it; the likelihood that there will be a negative impact on the foreign exchange generated by the diamond cutting industry (presently one-fifth of India's total; Pandya,



Figure 14. Today, India's leading diamond companies manufacture finished jewelry in such modern, well-equipped factories as this one at SEEPZ (Santacruz Electronics Export Promotion Zone). Photo by Russell Shor.

1997); the prospect of higher prices for some Indian goods; the possibility that synthetic diamonds may be cut and sold in place of natural diamonds; and the possibility that India will start to cut larger, higher-quality rough diamonds, such as those that will originate from the Orapa and Diavik mines. However, the potential effect on the world retail diamond jewelry industry is of greatest concern, because the fastest-growing segment of the diamond jewelry market—low-priced diamond jewelry—depends on the small, inexpensive stones that have been the foundation of the modern diamond cutting industry in India.

## CONCLUSIONS

Aside from the discovery of large diamond deposits in Russia, Botswana, and Australia, we believe that nothing has had a more fundamental impact on the diamond industry in the latter half of the 20th century than the spectacular growth of diamond cutting in India, which was essentially nonexistent 35 years ago. Today, primarily as a result of a large supply of low-wage, skillful workers, India is the premier cutting center for small, low-quality diamonds: It accounts for about 70% of the world's polished diamonds by weight and about 35% by wholesale value (excluding the effects of recent surpluses of Russian rough in the market).





Figure 15. The influx of small, low-quality near-gems from the extraordinarily productive Argyle mine has helped supply the growing diamond cutting industry in India. The large open pit at Argyle, shown here, will probably not be workable by present means after the year 2003, which raises important questions for the future of the Indian diamond cutting industry. Photo courtesy of Argyle Diamonds.

In 1996, Indian cutters produced about 750 million polished diamonds (about 9 out of every 10 polished diamonds in the world), the vast majority of which were less than 3 pt. If the cutting industry in India had not developed, most diamonds now classified as “near-gems” probably would have been used for industrial purposes. These small, low-quality polished diamonds have spawned a new segment of the diamond jewelry market that is characterized as readily affordable and amenable to mass marketing. The future of the Indian cutting industry (and, thus, of the low-priced diamond jewelry segment of the world diamond industry) appears to be secure at least

into the early years of the 21st century. It depends, though, on a reliable and abundant supply of near-gem rough produced in other countries.

---

*Acknowledgments: Mr. Sevdermish thanks Mr. C. Even-Zohar, and Dr. Levinson thanks Prof. S. R. Sreenivasan, for sharing their thoughts and experiences on several topics covered in this article. We all sincerely thank the staff at the Richard T. Liddicoat Library and Information Center, GIA, for their helping in obtaining reference materials. Russell Shor of Jewelers' Circular-Keystone and Judi Shechter-Lankford of the Indo Argyle Diamond Council kindly supplied photographs.*

## REFERENCES

- Aber spends big (1998) *The Financial Post* (Canada), March 7–9, pp. 1–2.
- Antwerp Diamond Index (1997) *Antwerp Facets*, Annual Report for 1996, March, p. 107.
- Argyle Diamonds Industry Review 1997* (1997) Argyle Diamonds and Indo Argyle Diamond Council, 18 pp.
- Ball S.H. (1937) Gem stones. In *Minerals Yearbook 1937*, U.S. Bureau of Mines, U.S. Department of the Interior, Washington, DC, pp. 1435–1440.
- Boyajian W.E. (1988) An economic review of the past decade in diamonds. *Gems & Gemology*, Vol. 24, No. 3, pp. 134–153.
- Bruton E. (1978) *Diamonds*, 2nd ed. Chilton Book Co., Radnor, PA.
- Chhotalal K. (1984) *Diamond from India* (revised). The Gem & Jewellery Export Promotion Council, Bombay.
- De Beers* (1992) James Capel Mining Research, London, 36 pp. [Investment Analysis]
- Diamond demand set to outstrip supply (1996) *Diamond International*, No. 44, p. 31.
- Diamond trading over fifty years (1984) *Optima*, Vol. 32, No. 1, pp. 38–48.
- Diamonds: A Cartel and Its Future* (1992) The Economist Intelligence Unit, Special Report No. M702, 83 pp.
- Diamonds: Past, Present & Future* (1992) Anderson, Wilson, and Partners, Inc., Johannesburg [Investment Report].
- Diamonds today: Annual reference review of the diamond industry, Part 1—Diamond supplies (1992) *Europa Star* (U.S.A. & Canada Edition), Vol. 154, No. 6.
- Diamonds today: Annual reference review of the diamond industry, Part 2—Manufacturing (1992) *Europa Star* (U.S.A. & Canada Edition), Vol. 154, No. 6.
- Directory of Exporters, 1983* (1984) The Gem & Jewellery Export Promotion Council, Bombay.
- Even-Zohar C. (1993) Optimism returns. *Mazal U'Bracha*, Vol. 9, No. 55, pp. 75–122 passim.
- Even-Zohar C. (1997) A calculated risk: Estimating Argyle's and



- other producers' rough stock. *Mazal U'Bracha*, Vol. 14, No. 87, pp. 24–40 passim.
- Five new sightholders appointed (1997) *Diamond Intelligence Briefs*, Vol. 13, No. 237, p. 1472.
- Flooding the diamond markets (1993) *Mazal U'Bracha*, Vol. 9, No. 55, pp. 54–55, 58.
- From strength to strength (1996) *Jewellery International*, India 1996 Supplement, No. 31, pp. 1–3.
- Gems & jewellery exports record downtrend in 1996–97 (1997) *Diamond World*, Vol. 24, No. 3, pp. 41–42.
- Goldwasser M. (1970) The diamond industry and its problems. *Diamant*, Vol. 13, No. 130, p. 24.
- Gupte P. (1988) The big world of small diamonds. *Asian Finance*, Vol. 14, No. 3, pp. 78–81.
- India active in diamond cutting and mining (1970) *Diamant*, Vol. 13, No. 133, pp. 26–27.
- India expands on all fronts (1989) *Diamond International*, No. 1, pp. 29–31, 33–36.
- India's rude awakening (1996) *Diamond International*, No. 43, pp. 89–92, 95.
- Indian factfile (1997) *In-Sight*, Fall, p. 5.
- Indians debate import moratorium (1996) *Diamond World Review*, No. 92, pp. 12, 14.
- International financial statistics (1988) *Supplement on Trade Statistics*, Series No. 15, International Monetary Fund, Washington, DC.
- Janse A.J.A. (1996) A history of diamond sources in Africa: Part II. *Gems & Gemology*, Vol. 32, No. 1, pp. 2–30.
- Japan holds the key (1997) *Diamond International*, No. 45, pp. 41–44.
- Jasani S.R.L. (1971) India: The role of N.M.D.C. *Diamant*, Vol. 14, No. 137, p. 25.
- Jhaveri K.C. (1994) India needs more, better rough for successful diversification. *Diamond World*, Vol. 21, No. 4, pp. 48–49.
- Johnson C.J., Marriott M., von Saldern M. (1989) World diamond industry: 1970–2000. *Natural Resources Forum*, Vol. 13, No. 2, pp. 90–106.
- Kaye L. (1988) Sticks and carats. *Far Eastern Economic Review*, Vol. 139, No. 7, pp. 64–65.
- Komkommer J. (1965) Diamonds in world economy. *Diamant*, Vol. 8, No. 75, pp. 5–6.
- Lakhi M.V. (1997) Understanding India. *Diamond International*, No. 45, pp. 49–50, 53, 54.
- Lawrence J. (1996) Automation v cheap labor. *Diamond International*, No. 44, pp. 87–88.
- Leakages hit CSO market share (1996) *Diamond International*, No. 39, pp. 21–23.
- Levinson A.A., Gurney J.J., Kirkley M.B. (1992) Diamond sources and production: Past, present, and future. *Gems & Gemology*, Vol. 28, No. 4, pp. 234–254.
- Maintaining its global position (1994) *Diamond International*, No. 30, pp. 67–76 passim.
- Marketing to the masses (1996) *Diamond International*, No. 44, p. 3.
- McDonald H. (1993) All that glitters. *Far Eastern Economic Review*, Vol. 156, No. 32, p. 74.
- Mehta A.K. (1997) Developments in the Indian market. The 2nd *Financial Times* Diamond Conference, London, October 27, 1997, 9 pp.
- Miller P. (1995) *Diamonds: Commencing the Countdown to Market Renaissance*. Yorkton Securities, London, 64 pp.
- 1996: Diamond content equals record 1995 (1997) *Mazal U'Bracha*, Vol. 14, No. 88, pp. 23–32 passim.
- No need to fear a price war (1996) *Jewellery News Asia*, No. 144, pp. 142–152 passim.
- Orapa capacity to double (1996) *Mining Journal*, Vol. 327, No. 8392, p. 137.
- Ore reserves: Argyle AK1 pipe (1996) *Australian Gemmologist*, Vol. 19, No. 6, p. 277.
- Pandya P.S. (1997) Child labour allegation strongly refuted by India. *Diamond World*, Vol. 25, No. 1, pp. 23–25.
- Pearson C. (1996a) A look into the crystal ball: Diamonds to the year 2000. *New York Diamonds*, No. 33, pp. 84–85, 88–89.
- Pearson C. (1996b) A walk on the supply side. *Jewelers' Circular Keystone*, Vol. 167, No. 6, pp. 351–352, 354, 356–358.
- Picton J. (1997) De Beers' place in the sun. *Mining Journal*, Diamond Supplement, Vol. 329, No. 8452, pp. 5–6.
- Putting the Argyle story into proper perspective (1996) *In-Sight*, Summer, pp. 4–5.
- Recovery waiting in the wings (1994) *Diamond International*, World Diamond Business Review 1993, pp. 29–42 passim.
- Russian diamond stockpile almost depleted (1997) *Diamond Intelligence Briefs*, Vol. 13, No. 239, p. 1485.
- Schnitzer M. (1996) Defend polished prices. *Diamond World Review*, No. 92, pp. 58–60.
- Scriven S. (1997) India: A multiple channel case study. *Mazal U'Bracha*, Vol. 14, No. 88, pp. 70, 71, 74, 75.
- Sevdermish M., Mashiah A. (1996) *The Dealer's Book of Gems and Diamonds* (Vols. 1 and 2). Kal Printing House, Israel.
- Sharma S.N. (1991) The diamond industry in India. Audiotope of lecture presented at the International Gemological Symposium, Los Angeles, June 1991, GIA, Santa Monica, CA.
- Sharma S.N. (1992) The diamond industry of India. In Keller A.S., Ed., *Proceedings of the International Gemological Symposium 1991*, GIA, Santa Monica, CA, p. 49.
- Shor R. (1993) *Connections: A Profile of Diamond People and Their History*. International Diamond Publications Ltd., Ramat Gan, Israel, 247 pp.
- Shor R. (1994) India courts U.S. with diamond jewelry. *Jewelers' Circular Keystone*, Vol. 165, No. 3, pp. 62–63.
- Shor R. (1997) Argyle bets on U.S. retail trade & Indian manufacturers. *Jewelers' Circular Keystone*, Vol. 168, No. 1, pp. 154–159.
- Small diamonds, big business (1995) *New York Diamonds*, No. 29, pp. 34–44 passim.
- Sri Lanka keeps a steady pace (1995) *Diamond International*, No. 33, pp. 79–82, 84.
- Stuyck R. (1969) Rise of the Indian diamond cutting industry. *Diamant*, Vol. 12, No. 113, pp. 20–21.
- Supply set to be outstripped by demand (1997) *Diamond International*, No. 45, pp. 57–59, 61–62, 64.
- The sweat behind the glitter (1988) *Asian Finance*, Vol. 14, No. 3, pp. 80–82.
- Technical training (1994) *Diamond International*, No. 30, pp. 76, 79–80, 82.
- Underground operations in doubt at Argyle (1997) *Jewelers' Circular Keystone*, Vol. 168, No. 12, p. 16.
- U.S. Bureau of Mines (1966–1978; 1979–1984; 1992–1994) Gemstones. In *Minerals Yearbook*, U.S. Department of the Interior, Washington, DC.
- U.S. Bureau of Mines (1995) Gemstones. In *Mineral Industry Surveys*, U.S. Department of the Interior, Washington, DC.
- U.S. Geological Survey (1996) Gemstones. In *Mineral Industry Surveys*, U.S. Department of the Interior, Washington, DC.
- U.S. Geological Survey (1997) Gemstones. In *Mineral Industry Surveys*, U.S. Department of the Interior, Washington, DC.
- U.S., Japan fuel diamond jewelry market (1994) *Jewelers' Circular Keystone*, Vol. 165, No. 3, pp. 32–33.
- Value of diamond jewelry sold in U.S. up 117% since 1980 (1988) ADIA [American Diamond Industry Association Inc.] *Newsletter*, Summer, p. 1.
- World diamond jewellery consumption (1991) *Diamond International*, World Diamond Industry Review 1991, pp. 65–82 passim.
- World diamond jewelry sales (1996) ADIA [American Diamond Industry Association Inc.] *Newsletter*, Fall, p. 3.
- World market trends (1991) *Diamond International*, World Diamond Industry Review 1991, pp. 7–22 passim.
- A year of overfeed (1996) *Diamond International*, No. 39, pp. 61–62, 64–66, 68.

# LEIGHA: THE CREATION OF A THREE-DIMENSIONAL INTARSIA SCULPTURE

By Arthur Lee Anderson

---

*Traditional gem intarsia, essentially flat interlocking mosaic work, is generally restricted to two-dimensional surfaces. Taking intarsia into three dimensions “in the round” requires the use of new techniques. This article illustrates the process of creating a contemporary three-dimensional intarsia sculpture. The skirt in Leigha was executed with over 800 separate pieces that averaged 1 to 2 mm in thickness. As the skirt is over 12 inches (30 cm) long, the necessary tensile strength to hold the pieces together required the use of the relatively new ultraviolet-curing cements, as well as structural design elements that would not be concerns in two-dimensional work. Inspired by an ancient Minoan motif, this intarsia sculpture illustrates some of the expanding possibilities for gem materials in the realm of gemstone objets d’art.*

---

**O***bjets d’art*, the French term meaning “art objects,” have captured the imagination of the lapidary throughout history. As the many examples in the tombs of ancient Egypt illustrate, such art objects—often inspired by religious beliefs—are among the oldest known uses for gem materials. For the gem artist, gemstone *objets d’art* are the natural marriage of the finest artistic materials and the vision of the artisan.

#### ABOUT THE AUTHOR

Mr. Anderson is an award-winning lapidary and gemologist whose business, Speira Gems (P.O. Box 849, Ashland, Oregon), deals in a variety of gem-related activities. E-mail: Zliff@aol.com.

Please see acknowledgments at end of article.

Gems & Gemology, Vol. 34, No. 1, pp. 24–33.

© 1998 Gemological Institute of America

Traditions for the creation of *objets d’art* vary from the single artisan working in solitude to execute a personal vision to, in the case of some ancient Chinese jade carvings, 50 carvers working for 10 years on a single piece (Thomas and Lee, 1986). Current practices include “houses” in Germany and elsewhere that draw on the skills of many stone artists to execute various parts of a single piece.

Whatever the approach used, the common link to the successful execution of all gem material *objets d’art*, in addition to artistic aesthetic, is engineering. With the advent of newer adhesives, broader dimensions of design and combinations of materials may be employed, resulting in creations that were structurally impossible in the past. This is particularly true of adhesives such as ultraviolet (UV) light-curing cements that have come into common usage in the lapidary field only in the last decade (L. Wackler, pers. comm., 1998).

Figure 1. Leigha, a contemporary intarsia sculpture, is based on an ancient Minoan figure from the island of Crete. It is shown here against a backdrop of the doorway to the Queen's Room in the palace at Knossos, the center of the Minoan civilization. The statue stands 27 inches (68 cm) tall; the skirt, which contains more than 800 pieces of gem materials, is a unique example of three-dimensional intarsia that could not have been constructed without contemporary adhesives and techniques. Photo © Harold & Erica Van Pelt.



This article describes the creation of a contemporary intarsia sculpture called *Leigha* (figure 1), which is based on an ancient Minoan figurine from the island of Crete circa 1700 BC. Although the lapidary technique of intarsia has been known for many centuries now, this statue illustrates some of the effects made possible by new technologies combined with precise engineering. For example, the skirt contains more than 800 separate pieces of garnet, smoky quartz, obsidian, black jade, and epidote, averaging 1 to 2 mm thick; it measures over 12 inches (30 cm) from waist to hem. A work such as this could not have been considered with adhesives

from lapidary traditions of the past. The statue has a total finished height of 27 inches (approximately 68 cm); it was executed by the author over a period of two years. The inspiration for this statue, both the Minoan motif and the historic technique of intarsia, are discussed below. This discussion is followed by a description of the specific materials and techniques used to produce this distinctive object.

#### BACKGROUND

**The Minoan Motif.** The Minoan culture flourished from approximately 2600 BC to about 1150 BC on the islands of Crete and Thera (present-day



Santorini), in the Aegean Sea between Greece and Egypt (Cotterell, 1979). It appears that this civilization never recovered from the devastating earthquakes and tidal waves that followed the eruption of the volcanic island of Thera in 1400 BC (Durant, 1939). These natural disasters destroyed the palace of King Minos at Knossos, remembered in mythology for the labyrinth thought to be hidden there and the minotaur, half bull-half man, who was said to live in the center of it.

Much of what is known or conjectured about the Minoans comes from excavations that have revealed their art. Extensive frescoes reveal a society in which women were highly esteemed for, among other things, their physical prowess. For example, Minoan frescoes reveal women acrobats “bull jumping”—a sport in which a person grabbed the horns of a charging bull and performed an acrobatic flip over the bull’s back (Cotterell, 1979; Castleden, 1990). Women are also prominently portrayed as priestesses, often holding snakes in their hands, the snake and the bull being common totems among the Minoans (Cotterell, 1979).

The colors and designs of the frescoes suggest a culture with a keen artistic appreciation. The dolphin fresco over the entrance to the Queen’s Room in the palace of Knossos in Crete (illustrated here in the background to figure 1) is an example of this. Other frescoes reveal the Minoan style of dress (Canby and Ross, 1961): The men often wore little more than codpieces, whereas the women are portrayed in finery, generally long pleated dresses open at the breasts and some of the earliest known representations of corsetry. Long braids adorned both men and women. The women wore makeup, especially eyeliner (kohl), and apparently esteemed physical beauty (Cotterell, 1979).

Much has been written about the Minoans in a somewhat idyllic vein—an island society, steeped in the arts (e.g., Durant, 1939). However, glimpses of another side to the idyll were revealed in excavations in the 1980s that uncovered the remains of two women in the act of sacrificing a young man when the palace roof collapsed during the earthquakes (Castleden, 1990). To this day, the Minoans remain an enigmatic culture.

Many statuettes with the motif of a woman holding two snakes have been discovered in the ruins of ancient Minoa, fashioned from various materials ranging from clay (e.g., in the Athens Museum; Hammond, 1988) to ivory (Boston Museum; Durant, 1939). This image has been

described as a “household deity” (Durant, 1939) and is commonly referred to as the Snake Goddess (Castleden, 1990). However, because the ancient Minoan language (Linear A) has never been successfully translated, the significance of the figure of a woman, bare breasted in the Minoan fashion, holding two snakes has never been conclusively established. The author’s inspiration came from a faience figurine of the Snake Goddess discovered in the ruins of Knossos (Cotterell, 1979; figure 2). He chose this subject both for the opportunity it presented to reinterpret an ancient image through contemporary gem work, and for its suggestion of primal strength in a feminine form.

**Intarsia.** Derived from the Italian *intarsiare* (to inlay), which descended from the Arabic *tarsi* (an inlay, incrustation; *Webster’s Encyclopedic Unabridged Dictionary*, 1996), intarsia encompasses many forms of inlay, although wooden mosaic work is perhaps the best known. For the most part, traditional gem intarsia incorporates flat surfaces, with the design executed in two dimensions, that is, as inlay of gem materials on a tabletop or on the top or sides of a box or pendant. Scrutiny of ancient pieces of gem inlay from the Cairo museum reveals no stone-adjacent-to-stone construct; there is always a border of metal, generally gold, securing stones in those designs. This early style of gem inlay mosaic work could be considered a precursor to modern intarsia (Saleh, 1987). The more contemporary, stone-fitted-to-stone intarsia is exemplified by the mosaics from Florence, Italy, where masters of flat intarsia work have reigned since the 1700s. Intarsia work with gem materials flourished from the late 1600s to the mid-1800s in western Europe, commonly in snuff boxes and other decorative items (Elliott, 1986).

Although gem intarsia is traditionally confined to two-dimensional representations, there were some earlier departures from these models, such as the peasant and other lifelike figurines executed by the artisans of Peter Carl Fabergé (Von Habsburg, 1983) at the turn of the century. Although carved in realistic detail, these figures are relatively simple in engineering. Generally, they represent the marriage of three or four separately carved pieces of stone, not actually a mosaic, or intarsia style, so perhaps they are better described as multistone gem carvings.

New technologies, especially the availability of new adhesives, have greatly expanded the creative and technical possibilities for current intarsia

artists. Today, a master such as Russian-American artist Nicolai Medvedev incorporates hundreds of individual pieces in his gem intarsia boxes; typically the only metal is that used for the hinge of the box or other mechanics. The rest is composed strictly of gem materials bonded to other gem materials with, in some cases, an ornamental wooden lining inside the box (Elliott, 1986). Medvedev prefers using five-minute-setting epoxies that the manufacturers claim will last up to 1,200 years. He also uses cyanoacrylate glues (i.e., Instant Glue or Krazy Glue or similar commercially available instantly bonding glues). Both types of adhesive create a durable bond, but the epoxies have a gap-filling property, whereas the cyanoacrylates are useful only for areas of very tight fit (N. Medvedev, pers. comm., 1998). Another innovator in gem inlay is Montreal gem cutter Yves St.-Pierre, who has used ultrasonic drilling techniques to literally vibrate a harder stone *into* a softer one, creating a flush inlay of one stone into the other (Y. St.-Pierre, pers. comm., 1996).

Virtually all traditional intarsia work uses opaque gem materials exclusively (Sinkankas, 1962). This is because most pieces must be backed with some material, which would show through if transparent gem pieces were used. The only way transparent materials could be used effectively would be in a panel style, similar to stained glass work, with no backing and suspended in three-dimensional space. The pieces would have to be finished front and back, unlike traditional intarsia work which is only finished on the exposed side. Without a backing material to add stability to the construct, only very strong adhesives could achieve the necessary strength to create larger pieces; and, as the pieces in intarsia are cut very thin, the adjoining edges would have to fit together perfectly in a pattern conducive to tensile strength. In the statue described in this article, Leigha, just such techniques were used to take intarsia into the round, in three dimensions, with transparent gem materials (figure 3). To the best of the author's knowledge, this has not been attempted before in gem intarsia.

#### MATERIALS USED

Gem materials are the palette of the lapidary executing an art object. Considerations in selecting materials include availability in sufficient sizes and quantities for completion of the piece, as well as consistency of color tones and diaphaneities to meet the design criteria of the finished object.

The author's conceptualization of this piece



Figure 2. The contemporary intarsia sculpture, Leigha, was inspired by this faience (painted clay) statuette of the Minoan Snake Goddess, which was excavated from the palace at Knossos and is thought to come from the middle Minoan period, around 1700 BC. It is currently in the National Museum in Athens. Photo from Cotterell (1979).

required the creation of a transparent skirt over a fully sculpted figure. Consequently, a material was needed for the body of the statue that would be available in sufficient size to execute the entire initial figure. A 200 pound (91 kg) block of marble from the Carrara Mountains in Italy was selected as the starting point for the creation of the four separate components of the body: one section from the waist down, another for the torso and head, and two for the arms.

Materials for the clothing were chosen for their "earth tones" (to suggest the ancient use of vegetable dyes) and for their various diaphaneities. The materials for the skirt and headdress consist of transparent orange grossular garnet from California,



Figure 3. This view of the statue shows the contours in the three-dimensional intarsia work. Such lapidary work requires engineering beyond the two-dimensional considerations of flat mosaic intarsia. Photo © Harold & Erica Van Pelt.

epidote from Pakistan, and smoky and colorless Brazilian quartz, as well as translucent sheen obsidian. Materials used for the bodice, girdle, hair, and snakes include black jade from Wyoming, sheen and rainbow obsidian from Mexico, Baltic amber, malaya and orange grossular garnet from California, basalt, and green jadeite from Alaska.

Faceted gems incorporated into the figurine include original gemstone designs by the author: a 14.50 ct “halo cut” citrine (figure 4), a 4.25 ct “iris cut” citrine (figure 5; see also Anderson, 1991), and a 4.30 ct oval “blossom cut” malaya garnet (figure 6). Obsidian, magnesite, indicolite, black agate, and

clear quartz were used to fashion the eyes. Ringlets of 14k gold adorn the braids.

Additional considerations of hardness and toughness influenced the selection of some materials. For example, a material such as amber, cut into thin slices, is only suitable if backed by another material. Consequently, amber was selected for the bodice and the headdress, where it would be backed by the marble. As essentially all the pieces used in the clothing of the figure are thin cuts, the engineering of the construction was more important than the hardness or toughness of the material used in most cases. In fact, the materials in the skirt are supported more by the way they are cross-braced and interlocked than by the strength of the materials themselves. However, because the girdle area around the hips is the contact point between the marble of the body and the skirt, a tougher material—in this case, black jade—was essential.

The base of the statue consists of a laminated oak bowl, black lacquered and filled with Portland cement, in which the marble of the main figure has been inserted. An ornamental covering of silica sand constitutes the ground on which the figure appears to stand.

#### GENERAL CUTTING AND ASSEMBLY CONSIDERATIONS

The execution of this work involved a combination of stone-working techniques: traditional lapidary techniques for the gem materials, and marble working for the body of the statue. Nearly all types of lapidary methods were used: from sawing, lapping, and grinding, to faceting, carving, and hand polishing. As space considerations preclude discussion of general lapidary techniques, the reader is advised to consult reference books on the subject for more detailed information (see, e.g., Sinkankas, 1962; Hunt, 1996).

The marble work required the use of power saws with carbide blades, handheld power grinders, and traditional hand chisels. Although ultimately all stone work is executed by the same principle of cutting softer materials with harder ones, the chief difference between lapidary work and marble sculpting is that, because marble is relatively soft, steel tools may be used, whereas gem materials usually require diamond and silicon carbide abrasives. However, the marble was given a final treatment using diamond burrs in flex-shaft machines, which is more typical of lapidary carving than traditional marble sculpting.





Figure 4. The headdress includes a 14.50 ct “halo cut” citrine inlaid in a smoky quartz crown. Amber and obsidian define the brim, and the top of the crown is embossed with an appliqué of garnet, citrine, and epidote. A close view of the face reveals the composite nature of each eye, including obsidian pupils, indicolite irises, magnesite whites, and black agate eyeliner. The cornea is clear quartz. Photo © Harold & Erica Van Pelt.

In creating a gem work of this nature, engineering considerations were paramount from the outset. Because the final object would have numerous fragile features that would make it impractical to transport safely as one piece, it had to be designed so that it could be disassembled. Thus, the statue had to be constructed in sections that could be fitted together by pegs. The final work is in six separate sections: the upper torso and head, the two arms, the legs and lower torso, the skirt, and the base.

Another critical structural consideration was the selection of adhesives for the different areas. Generally speaking, 330 epoxy (which contains a resin and hardener) was used throughout the piece in areas where opaque materials were bonded to opaque areas; cyanoacrylate glues were used in areas where smaller bonds were required, such as in the assembly of the eyes; and an ultraviolet-curing cement was used wherever transparent materials were joined and the bond would be visible.

Although the epoxies and cyanoacrylates both have the durability and strength to bond most of the

opaque areas, there are situations where an epoxy is preferable, such as when some slight movement is needed to position a piece, or in an area where one might wish to build up the surface behind the piece being glued, as was the case of the amber over the marble. As a 330 epoxy sets in about 15 minutes, there is plenty of time to adjust a misaligned placement; a cyanoacrylate glue, however, bonds instantly. With the UV-curing cements, the artist can adjust the fit until he or she is satisfied, at which point the cement is exposed to UV light to secure the bond. Throughout this piece, the individual area dictated the most expedient bonding method.

The skirt of the statue, which was intended to be a composite of transparent materials that would enable the legs of the figure to show through, required the use of UV-curing adhesives. Not only were the length and thickness of the skirt important considerations, but also the fact that the skirt had to be a separate three-dimensional construct that could be removed from the figure for transport. It required a transparent glue that would bond not only hard and rigid, but also strong enough to hold the pieces together. (Epoxy, for example, would have been too malleable.)

Duro Crystal Clear™ UV-curing cement was chosen on the recommendation of a jewelry supply

Figure 5. Highlighting the back of the waist is this 4.25 ct “iris cut” citrine. By scalloping the embroidery motif of garnet and epidote, the overall surface area connecting to the lower part of the skirt is increased, adding strength to the construct. Photo © Harold & Erica Van Pelt.

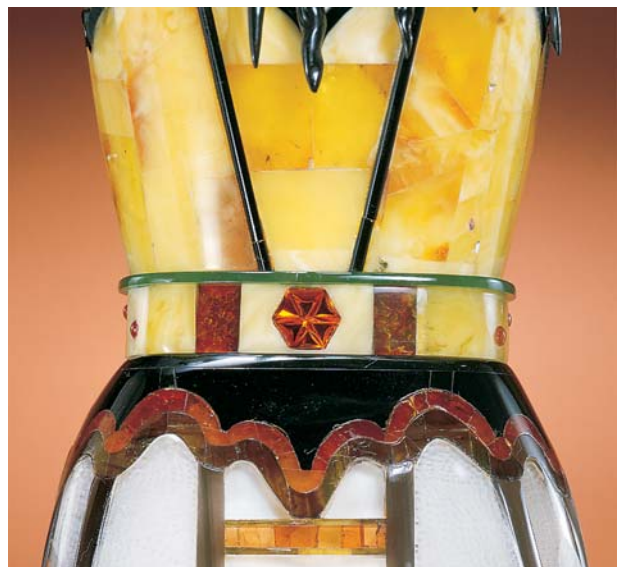



Figure 6. On the front, the belt features a 4.30 ct oval “blossom cut” malaya garnet. The numerous textures in the belt, bodice, and skirt help expand design elements in the clear quartz panels. The varying directions of the interlocking pieces add to the structural stability of the skirt. Photo © Harold & Erica Van Pelt.

house, which had been getting good reports on it from other users. To test the appropriateness of this UV-curing cement to the structural problems posed by the skirt, several pieces of different gem materials (including the quartz, garnet, and epidote planned for use in the skirt) were cut approximately 1–2.5 cm long and 2 mm thick. They were then bonded end-to-end, resulting in three sets that each connected different materials. Once the bond had set and cured for 24 hours, attempts were made to break the pieces along the joint with finger pressure. The gem plates themselves broke, but not the cemented joints. Then the pieces were put in a tumbler with comparable-size beach rocks and tumbled for approximately two weeks. Two out of the three sample sets held along the bond. On this basis, the author decided that this product would provide the necessary tensile strength.

Another consideration was discoloration of the adhesive, since a joint between transparent materials requires an invisible bond. The UV-curing cement selected is sold primarily for its “crystal clear” bond, which is recommended for use in repairing dishes that are washed in a dishwasher.

The author was unable to locate scientific information on the long-term durability of this cement. The fact that UV-curing cements are used exten-

sively in dental work, however, led him to believe that its durability has been well established.

In most instances, midday sun was used to cure the ultraviolet cement. Such cements will lock hard in seconds on exposure to strong UV light, although full curing takes 24 hours. Sunlight between the hours of 11:00 a.m. and 2:00 p.m. was found to be most effective in my southern Oregon locale. A portable UV light was also used for tabletop curing, although the bonding with the artificial light was slow: about five times the exposure time needed with strong daylight. Note that the exposure time and strength of the bond varied with the intensity of the UV radiation. Some bonds achieved in direct sunlight earlier or later in the day subsequently separated when the pieces were worked. One New York colleague reported a higher failure rate for the same cement during his experiments using sunlight there (J. Hatleberg, pers. comm., 1997). Where there is any question about what effects smog and geographic position might have, it is recommended that the UV lamp be used and/or that additional time be allotted for bonding and curing.

This cement was used to bond the more than 800 pieces that form the skirt. As figure 7 illustrates, the cement does not affect the appearance of the skirt’s transparent materials. In fact, because UV cements must be exposed to UV light to cure, they can be used only on materials that allow UV rays to permeate the stone (Hunt, 1996). These adhesives are a relatively recent innovation for the lapidarist, so it can be argued that a construct such as this skirt would not have been possible even 20 years ago.

Also important to the structural integrity of the piece was the engineering of the freestanding components in the skirt so they would cross-brace themselves, with each piece supported by the adjacent piece. To this end, the pattern was designed to incorporate triangulation, in which diagonals alternate with parallel edges (again, see figures 6 and 7). The stability and strength of triangulation was popularized by Buckminster Fuller in his geodesic domes and “tensegric” tower, which are composed of triangular supports that achieve superb structural stability (Fuller and Marks, 1960); these have become the basis for radio and television towers, as well as for long-span roof designs in large buildings.

## CREATING LEIGHA

**The Body.** The central concept of a freestanding figure wearing a transparent skirt required that the

ntire figure of the body be carved first, and then the clothing fit to the figure. Initially, a clay figure was constructed to scale to provide the dimensions for the marble. As noted earlier, the marble was cut and carved in four sections: the lower half, from the waist down; the torso, from the waist up and including the head; and the two arms. A horizontal bar of marble was retained across the base as a cross-tie to connect the feet (figure 8). This triangulation gave strength to the ankles, which support the weight of the completed statue. Because the feet were carved slightly raised, this tie was easily hidden beneath the ornamental sand, giving the impression of a freestanding figure. To keep the center of gravity perfectly vertical, the author periodically checked the piece by balancing the base of the lower section on a pencil laid flat on a table. By repeatedly checking the balance and then carving and removing material as needed, the artist maintained the center of gravity throughout the carving process. The torso and the lower half were drilled, and an aluminum peg was inserted to connect the upper and lower body. The arms were likewise drilled and attached to the torso via aluminum pegs.

**The Skirt.** With the marble body as the form, the skirt was assembled from the waist down. First, a girdle was constructed around the waist and hips (again, see figures 5 and 6). Composed of several pieces of black jade that were carved and then epoxied to one another, this scalloped girdle established the reference points for the later alignment of the skirt panels. To create the skirt, several pieces at a time were cut and glued, then finished completely front and back, before the next section was begun. An “embroidery” of orange grossular garnet and green epidote followed the scallop pattern in the jade. Because the garnet was transparent, UV-curing cement was used to attach it to the opaque girdle. (Only one of the two components must be transparent for the UV light to permeate and bond the cement, although bonding is substantially slower than when both pieces are transparent.) This embroidery was chosen both for aesthetic considerations and to create an interlocking structural support for the black jade of the girdle. Interlocking support is achieved any time there is a break from the symmetry of parallel joints. By joining at a curve or line that is diagonal to parallel joints, the artisan creates a triangulated support that increases the tensile strength of the construct. The scalloped curves of the embroidery motif also add strength by

increasing the surface area connecting the skirt to the girdle.

Next, a panel was created that ran from waist to hem down the front of the skirt. Dominating the panel was a pattern of diamond shapes formed from transparent colorless quartz, smoky quartz, grossular garnet, epidote, and obsidian. The two types of quartz were carved and sandblasted on the back to create a stippled translucency as an aesthetic counterpoint to the more transparent areas of the skirt. The striped effect on the colorless quartz was achieved by the blade of a diamond band saw, which left a rippled cut on the back of the stone; alternating ripples were then sanded and polished (again, see figures 6 and 7).

As with the embroidery to the girdle, the rest of the skirt was designed to change the angles at

*Figure 7. The skirt is composed of garnet, obsidian, epidote, smoky quartz, clear quartz, and black jade. It is 12 inches (31 cm) long, and the individual pieces average 1–2 mm thick. A UV-curing cement both provided the strongest bonds and maintained the transparency of the gem materials. Photo © Harold & Erica Van Pelt.*





which pieces adjoined, mixing diagonal and weaving patterns with straight parallel pieces, edge-glued to create a structural stability that would have been absent with purely parallel or right-angle fits (figures 5–7). Building from the central front panel, additional panels were cut, sandblasted, fitted, and cemented. An average thickness of 1–2 mm was maintained for the transparent-to-translucent pieces; the obsidian rods used as dividing pleats were made slightly thicker to allow some adjustment of fits.

The back of the skirt was completed with panels of transparent colorless quartz, accented by garnet and epidote. Clear panels were chosen to allow light transmission when the figure was backlit, so the legs would be silhouetted through the skirt.

**The Belt and Bodice.** Once the skirt was completed, the belt was assembled by veneering Baltic amber to the marble. The front and back were inlaid with the specially cut malaya garnet (front) and deep orange citrine (back; figures 5 and 6). All the faceted gems in the piece were secured by a thin layer of UV-curing cement along the girdle of the stone, so that the pavilion was suspended in a cavity. Smaller cabochons of grossular garnet were added to each side as accents, and a line of green jade was used to separate the belt from the bodice.

The bodice/corset was formed by a veneer of Baltic amber placed over partially incised marble. A border of black jade accents the upper edge.

*Figure 8. The triangulation provided by the marble base between the feet provided structural support to the finished work. Photo by the author.*



**Eyes, Hair, and Headdress.** Each eye contains seven pieces of gem material (figure 4). Constructing outward from the obsidian pupil, the artist used indicolite tourmaline for the irises, magnesite for the whites (each iris and “white” portion was composed of two separate halves), and black agate for the eyeliner. A clear quartz cap was added over each eye to give positive curvature to the cornea. Each eye was backed with white-gold leaf before it was inset, so that any light shone directly into the eyes would be slightly reflected from behind the indicolite iris, creating a subtle brightening.

The headdress was constructed on a headband of obsidian and amber. The cap was cut from a piece of smoky quartz, and a specially cut citrine was inlaid in the center front as a crowning effect (figure 4). Careful use of internal reflection in the smoky quartz hat created the impression of a solid headdress, when in fact it is transparent. The top was accented by a thin veneer of garnet, epidote, and citrine.

The braids were carved from basalt and given a satiny finish. Each braid was attached to the head under the rim of the headdress with epoxy (figure 3). The gold rings were simply bent into place without soldering, to suggest the plaits that were the Minoan fashion.

**Armbands and Snakes.** The armbands were constructed from two pieces of black jade sandwiching a slice of amber. In addition to being decorative, the armbands conceal the joint where the arms slide into the torso. The upper and lower half of each snake was carved separately, and the figure’s hands were partially drilled to fit the snakes in place. Rainbow obsidian was selected for the snakes to suggest fluidity of movement (figure 9).

**Base.** Portland cement was poured into the oak bowl around a mold of the bottom of the marble legs. After the cement had set, the mold was removed, leaving a space into which the marble tie between the feet fits snugly, so the legs can be removed easily. The cement (and marble tie) are covered with a thin layer of sand so that the feet appear to be standing on the sand.

## CONCLUSION

When the medium of hard stone is married to artistic creation, engineering becomes integral to the design. The larger the piece and more numerous the components, the more involved the process becomes. In the design for *Leigha*, a central consideration was that the weight had to be evenly dis-



Figure 9. Rainbow obsidian from Mexico was chosen for the snakes, to suggest fluidity of movement. Photo © Harold & Erica Van Pelt.

tributed so that the relatively thin ankles could safely support the entire figure. In addition, the three-dimensional intarsia of the skirt—which is composed of 800 pieces—required cross-sectional support, through manipulation of the design itself (the skirt panels, diagonals, etc.) and the use of ultraviolet-curing cements that would be strong and durable enough. By distributing the weight, manipulating gravity and balance, and identifying new technologies (such as UV-curing cements), the artist was able to create a freestanding sculpture that uses extensive three-dimensional intarsia, but still has both structural integrity and aesthetic beauty.

In creating an *objet d'art*, the starting point is always the inspiration, what the feel of the piece is to be, and what it is to convey aesthetically. The next step is consideration of what is possible in a given medium, what engineering is necessary, and what the palette of materials is to be. To take intarsia work out of its traditional two dimensions and into a freestanding, three-dimensional, curved surface entailed techniques the author could not find in books or in existing examples of *objets d'art* in museums or contemporary galleries. Consequently, much of the creative process involved devising new techniques and making them work.

There is an inherent excitement in recreating a vision from 4,000 years ago in a way that could never have been imagined by the original artist. While working on the piece, the author often thought of the original artist working to create his or her faience figure. Both of us strove to execute the most beautiful representation of the same image, but in different eras, carrying the same vision forward through time and space.

The techniques devised for this statuette represent one more step in providing a broader range of artistic possibilities within the lapidary field. Increasingly, lapidary arts and gem sculpture are only limited by the artist's imagination.

*Acknowledgments:* The author thanks lapidary Lew Wackler for his observations on UV-curing cements; Nicolai Medvedev, a contemporary intarsia master, for information on glues and techniques; Yves St.-Pierre, a gem artist from Montreal, for information on ultrasonic gem inlay; and gem artist John Nels Hatleberg for anecdotal information. The author also acknowledges the invaluable instruction he received in marble-working techniques from the late master sculptor Bruce Hoheb of Ashland, Oregon, who was kind enough to share some of his 50 years of experience before his death in 1996. Special thanks to Martha Wilhelm and her family for their support.

## REFERENCES

- Anderson A.L. (1991) Curves and optics in nontraditional gemstone cutting. *Gems & Gemology*, Vol. 27, No. 4, pp. 234–239.
- Canby C., Ross N., Eds. (1961) *The Epic of Man*. Time Inc. Book Division, New York.
- Castleden R. (1990) *Minoans: Life in Bronze Age Crete*. Routledge, London.
- Cotterell A. (1979) *The Minoan World*. Charles Scribner's Sons, New York.
- Durant W. (1939) *The Story of Civilization: The Life of Greece*. Simon and Schuster, New York.
- Elliott J. (1986) Contemporary intarsia: The Medvedev approach to gem inlay. *Gems & Gemology*, Vol. 22, No. 4, pp. 229–234.
- Fuller R.B., Marks R. (1960) *The Dymaxion World of Buckminster Fuller*. Anchor Press/Doubleday, New York.
- Hammond (1988) *Past Worlds: The Times Atlas of Archeology*. Times Books Ltd., London.
- Hunt H. (1996) *American Lapidary: Designing the Carved Gemstone*. Desert Press, Arizona City, AZ.
- Saleh M. (1987) *Official Catalogue: The Egyptian Museum Cairo*. Organisation of Egyptian Antiquities, Cairo.
- Sinkankas J. (1962) *A Lapidary's Manual*. Van Nostrand Reinhold, New York.
- Thomas S.A., Lee H.W. (1986) Gemstone carving in China: Winds of change. *Gems & Gemology*, Vol. 22, No. 1, pp. 24–34.
- Von Habsburg G. (1983) *Fabergé: A Loan Exhibition for the Benefit of the Cooper-Hewitt Museum*. Vendome Press, New York.
- Webster's Encyclopedic Unabridged Dictionary of the English Language* (1996). Gramercy Books, New Jersey.

---

# RUSSIAN SYNTHETIC PINK QUARTZ

By Vladimir S. Balitsky, Irina B. Makhina, Vadim I. Prygov, Anatolii A. Mar'in, Alexandr G. Emel'chenko, Emmanuel Fritsch, Shane F. McClure, Lu Taijing, Dino DeGhionno, John I. Koivula, and James E. Shigley

---

*Transparent crystals of facet-grade synthetic pink quartz, produced by hydrothermal growth from a fluoride solution and subsequent treatment, have been commercially available since 1994. The characteristic properties that distinguish this material from its natural counterpart are a tabular crystal morphology with two large, well-developed basal faces; color bands parallel to the basal faces and the seed plate; two-phase inclusions adjacent and perpendicular to the seed plate; and an intense broad band around  $3420\text{ cm}^{-1}$  in the infrared spectrum. Color stability and cause of color in synthetic pink quartz are briefly discussed.*

---

The past few years have witnessed the appearance of a variety of synthetic gem materials from Russia, including synthetic emerald, spinel, opal, ruby, sapphire, and alexandrite. The production of transparent synthetic pink quartz in a Russian laboratory was first reported in 1992 (Balitsky et al., 1992, 1993; Makhina et al., 1992). The material has been commercially available since 1994, and is currently

produced near Moscow at the Russian Research Institute for Synthesis of Materials. At present, production is 200 kg per year, in crystals measuring up to  $150 \times 40 \times 20$  mm. This material (figure 1) is sold under the trade name "Flamingo Quartz" through HRI International Corp. of Midtown, New York.

The visible spectrum of this synthetic pink quartz is identical to that of natural transparent pink quartz (Rossman, 1994), and the growth conditions and cause of color are very similar (Balitsky et al., 1996). Therefore, we conducted a systematic investigation to establish gemological means to distinguish this new synthetic from its natural counterpart. This material and its natural equivalent will be referred to here as "pink quartz," to distinguish them from natural and synthetic "rose quartz."

## BACKGROUND

Pink-colored quartz is found in nature in two forms: massive and crystalline. Massive "rose" quartz is relatively common in nature; it originates in granitic pegmatites together with large crystals of potassium feldspar, typically without other gem minerals (see, e.g., Frondel, 1962; Larson and Honert, 1977; Cassedanne and Cassedanne, 1978). This material inevitably appears slightly to very cloudy because of inclusions and its aggregate

### ABOUT THE AUTHORS

Professor Balitsky (balvlad@iem.ac.ru) is head of the Laboratory of Mineral Synthesis, and Mr. Prygov and Mr. Emel'chenko are postgraduate students, at the Institute of Experimental Mineralogy, Russian Academy of Sciences (IEM RAS) in Chernogolovka, Moscow District, Russia. Dr. Makhina is a senior researcher in, and Dr. Mar'in is head of, the Department for Experimental Mineralogy at the Russian Research Institute for Synthesis of Materials (VNIISIMS). Dr. Fritsch is professor of physics at the Gemological Laboratory, Physics Department, University of Nantes, France. Mr. McClure is manager of Identification Services, Mr. DeGhionno is a staff gemologist, and Mr. Koivula is chief gemologist, at the GIA Gem Trade Laboratory, Carlsbad, California; Dr. Lu is a research scientist, and Dr. Shigley is director, at GIA Research, Carlsbad.

Please see acknowledgments at end of article.

Gems & Gemology, Vol. 34, No. 1, pp.34-43.

© 1998 Gemological Institute of America



Figure 1. Transparent synthetic pink quartz is now being manufactured commercially in Russia. These crystals (132.25–193.76 ct) and faceted samples (7.30–15.97 ct) of synthetic pink quartz are some of the samples used in this study. Photo by Maha DeMaggio.



nature. Semi-transparent to translucent rose quartz can be polished as cabochons, some of which show asterism. Occasionally, rose quartz is even faceted.

Unlike massive rose quartz, transparent single-crystal pink quartz is very uncommon in nature (see, e.g., Rossman, 1994). The crystals form in pockets toward the end of the granitic-pegmatite evolution process, often accompanied by gem tourmaline and phosphate minerals. Facetable material has been discovered in only two countries: Brazil (three deposits in Minas Gerais) and Madagascar (Maschmeyer and Lehmann, 1983; Cassedanne and Alves, 1990). In addition to its geologic formation, transparent pink quartz differs from massive rose quartz in terms of visible absorption spectra, stability to light, and origin of color (Balitsky et al., 1992; Rossman, 1994).

Typically, the crystals of natural pink quartz are small and available in limited supply. The only natural material encountered by GIA researchers in sizes large enough to yield 1+ ct faceted stones is from the Araçuaí region of Minas Gerais (Kammerling and Fritsch, 1993); the Russian researchers have not encountered any faceted natural pink quartz outside of a museum in Russia. Although the samples examined to date are predominantly colorless, they have distinct planar bands or zones of intense pink color that can be oriented to give faceted stones an overall pink coloration when viewed table up.

Small (less than 3 cm), thin crystals of semi-transparent synthetic rose quartz have been produced in Japan, for research purposes only, since the mid-1980s. According to Hosaka et al. (1986), this

material was grown hydrothermally from concentrated titanium-bearing alkaline solutions ( $\text{NaOH}$ ,  $\text{Na}_2\text{CO}_3$ , or  $\text{K}_2\text{CO}_3$ ) in steel autoclaves at a temperature around  $330^\circ\text{C}$  and a pressure around 1 kbar. Plates of synthetic quartz cut parallel to the rhombohedral faces were used as seed crystals. The Japanese synthetic quartz was near-colorless in its as-grown state. The pink color was developed through subsequent heat treatment, which was carried out at  $1200^\circ\text{C}$  in a platinum crucible in which  $\text{CaCO}_3$  powder containing about 0.5 wt.% iron was used. The pink coloration has been attributed to a charge-transfer mechanism involving Ti-Fe ion pairs: The Ti was introduced into the quartz during growth, and the Fe was introduced during heat treatment. Hosaka et al. (1986) also state that the growth conditions and origin of color of this synthetic rose quartz are relatively close to those of natural massive rose quartz. However, the Russian product described here is the first commercially available *transparent* synthetic pink quartz.

#### GROWTH AND IRRADIATION CONDITIONS

The Russian synthetic pink quartz crystals are grown in steel autoclaves by a thermal-gradient hydrothermal method, from a solution containing ammonium fluoride ( $\text{NH}_4\text{F}$ ) and silica (Balitsky and Tsinober, 1969; Balitsky et al., 1974, 1996). The autoclaves vary in volume from 300 to 500 ml. Phosphorus is added to the solutions in the form of either orthophosphoric acid or its salts. The growth temperature ranges from  $220^\circ$  to  $350^\circ\text{C}$ , and the pressure may attain 0.3 kbar. The interior of each autoclave is coated with a protective anticorrosion



Figure 2. Natural pink quartz is very rare. Small quantities have been found in the Araçuaí region of Minas Gerais, Brazil. Note the color zoning evident in many of the natural stones shown here, which weigh from 2.27 to 7.63 ct. Photo by Maha DeMaggio.

layer (Teflon™ for experimental runs conducted at temperatures below 300°C, and platinum for runs above 300°C).

Two kinds of rectangular plates, cut parallel to  $c$  {0001} from synthetic colorless single-crystal quartz, are used as seeds. One type of plate is elongated in the hexagonal prism [10 $\bar{1}$ 0] direction (known as the “YZ-cut”), and the other is elongated in the trigonal prism [11 $\bar{2}$ 0] direction (the “XZ-cut”). Seed plates cut in these two orientations have produced the best results for growing high-quality synthetic quartz crystals.

The crystals used to produce synthetic pink quartz grow at a slower rate (only 0.1–0.2 mm/day) than those for normal colorless synthetic quartz. A 20-mm-thick tabular crystal of the former requires more than two months to grow. Crystals up to 150 × 40 × 20 mm, weighing as much as 700 ct, have been successfully produced by this method. About 200 kg of such crystals are grown annually, but production could be increased to 500 kg per year.

All as-grown crystals are colorless; the pink color is developed by subsequent irradiation and heating. The intensity of the color depends on both the concentration of phosphorus in the fluoride solution and the irradiation and heating conditions. Generally, the higher the phosphorus concentration, the more intense the pink color. The deepest pink is obtained when the phosphorus concentra-

tion is about 9 to 13.5 grams per liter in the growth solution. When the phosphorus concentration exceeds 13.5 grams per liter, the intensity of color does not change. The crystals are gamma-irradiated at a dose of  $5 \times 10^6$  rads, using the isotope cobalt-60 as the source (Balitsky et al., 1996); other details of the irradiation and heating process are proprietary.

## MATERIALS AND METHODS

More than 100 synthetic pink quartz crystals were examined by the Russian authors and their staff, and the GIA authors conducted a systematic gemological study of four crystals, nine faceted samples, and four polished cubes of similar material. The largest crystal studied at GIA was 46.40 × 25.80 × 14.90 mm and weighed 193.76 ct; the faceted samples, cut in cushion and oval shapes, ranged from 3.69 to 15.97 ct (see, e.g., figure 1).

For comparison, three rough and six faceted samples of natural transparent pink quartz from Brazil (see, e.g., figure 2) also were investigated at GIA to determine their internal features, ultraviolet fluorescence, and absorption spectra. To explore any dependence of gemological properties on crystallographic orientation, the three rough samples were cut and polished in different orientations.

In Russia, the samples of synthetic pink quartz were examined with an MBS-9 stereomicroscope, and were analyzed with SPECORD M40 and Perkin-Elmer 983 spectrophotometers (visible and infrared spectra, respectively). Color stability to light was tested in Moscow by placing approximately 100 crystals next to a window, where they were exposed to sunlight for three years. The crystals were periodically compared to a control sample that was kept in a darkened container throughout this period. Color stability to heat was tested on 35 samples at various temperatures up to at least 500°C.

Standard gem-testing equipment and methods, as well as several advanced techniques, were used to characterize all of the samples examined at GIA. The equipment included a Duplex II refractometer with a near-monochromatic, sodium-equivalent light source; a polariscope; a calcite dichroscope; a Chelsea color filter; a GIA GEM Instruments combination long-wave and short-wave ultraviolet lamp unit; a Beck desk-model prism spectroscope mounted on an illumination base; and a binocular gemological microscope. Specific gravity values were determined by hydrostatic weighing on a Mettler AM100 electronic balance (three sets of readings were taken for each sample and then averaged).

The visible-range spectra of all GIA samples were recorded with either a Hitachi U4001 or a Pye-Unicam 8800 spectrophotometer. Polarized absorption effects were also investigated using the Hitachi spectrophotometer with a calcite polarizer. Infrared spectra were recorded for all rough and fashioned samples examined at GIA with a Nicolet Magna-550 FTIR spectrometer.

Qualitative chemistry for all the GIA samples was obtained by energy-dispersive X-ray fluorescence (EDXRF) analysis with a Tracor Northern Spectrace TN 5000 system. Two sets of analytical conditions were used to detect as wide a range of trace elements as possible. Quantitative chemical analyses by electron microprobe were obtained on two of the four polished cubes of synthetic pink quartz; each had distinct color zoning, consisting of a pink layer and two colorless layers. The analyses were obtained using a JEOL Superprobe 733 instrument at the Division of Earth and Planetary Sciences, California Institute of Technology, Pasadena. The operating conditions were 20 kV voltage, 100 nA current, and a 600 second count time. The elements P, Al, Fe, Ti, K, Na, Si, and F were analyzed to investigate the chemical composition of each layer and the cause of the pink color.

## RESULTS AND DISCUSSION

**Color and Color Distribution.** The faceted synthetic samples ranged from light to medium-light pink (figure 3), while the synthetic crystals were medium pink (figure 4). The samples showed weak (rarely moderate) dichroism, in two tones of pink.

The coloration of the faceted synthetic pink quartz was uneven, in that it was confined to distinct pink bands that were visible in some samples without magnification. These bands were oriented parallel to the colorless synthetic quartz seed plate (figure 5). In some samples, the pink bands located farthest from the seed plate were darker than those nearer the seed plate.

The lighter-colored faceted samples were inert to the Chelsea filter (i.e., they appeared the same color as the filter); the deeper-colored faceted samples and the crystals showed a very weak reaction (i.e., they appeared slightly pink to orange-pink).

**Crystal Morphology.** All the crystals examined at GIA were euhedral single crystals. The well-developed basal surfaces were very rough, with abundant triangular growth hillocks (figure 6). The morphology of the synthetic pink quartz strongly depends



Figure 3. The faceted samples of synthetic pink quartz studied (here, 7.30–15.97 ct) ranged from light to medium-light pink. Photo by Maha DeMaggio.

on the shape of the seed plate and the relative growth rates of the major faces (Balitsky et al., 1992, 1993, 1996). Since rectangular seed plates elongated in either hexagonal (YZ-cut) or trigonal (XZ-cut) prism directions were used as seeds, and the growth rates of the major faces (except  $c$  {0001}) were very slow, the crystals have largely inherited the shape of the seed plate. Thus, all crystals were tabular. In addition to the well-developed basal  $c$  faces, also present were smaller positive rhombohedral faces  $r$  {10 $\bar{1}$ 1}, negative rhombohedral faces  $z$  {01 $\bar{1}$ 1}, hexag-

Figure 4. These synthetic pink quartz crystals (70–80 mm long and 10–18 mm thick) are representative of the samples studied in Russia and at GIA. Photo by Mikhail A. Bogomolov.

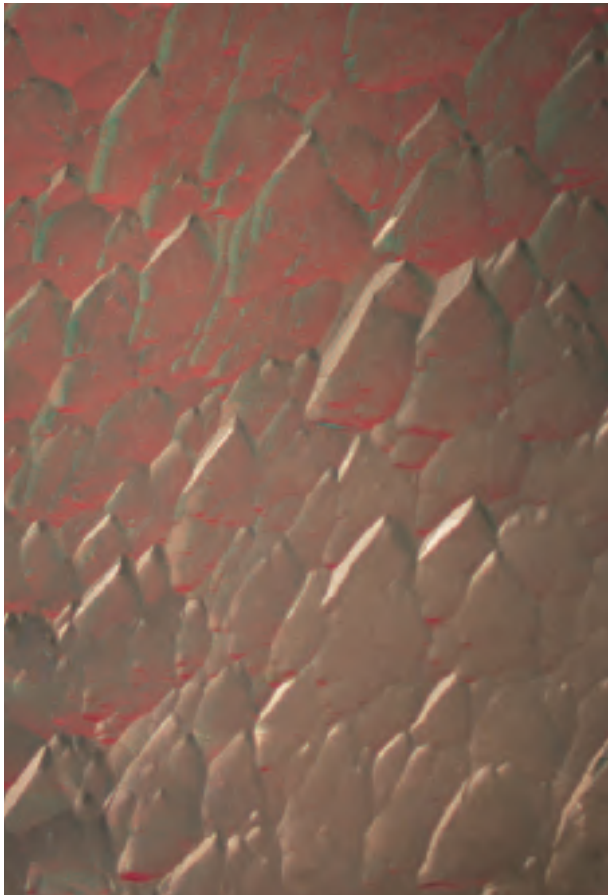





Figure 5. Prominent light to dark pink bands are visible in this faceted synthetic pink quartz. The color banding parallels the orientation of the colorless seed plate in the center. Photomicrograph by Shane F. McClure; immersed, diffused light, magnified 11 $\times$ .

Figure 6. Triangular growth hillocks are typically present on the basal *c* faces of Russian synthetic pink quartz crystals. Photomicrograph by Lu Taijing; magnified 7.5 $\times$ .



onal prism faces  $m$   $\{10\bar{1}0\}$ , trigonal prism faces  $+x$   $\{11\bar{2}0\}$  and  $-x$   $\{2\bar{1}\bar{1}0\}$ , and trigonal dipyrmaid faces  $+s$   $\{11\bar{2}1\}$  and  $-s$   $\{\bar{1}\bar{1}21\}$ . Figure 7 illustrates the crystal habits and the relationships between the seed plate and various growth sectors in the synthetic pink quartz. In comparison, natural crystals more commonly show a form with well-developed rhombohedral faces (Fron del, 1962).

**Gemological Properties.** Table 1 summarizes the gemological properties of the Russian synthetic pink quartz, as compared to natural pink quartz. The R.I., birefringence, and S.G. values are identical. All of the synthetic samples were inert to both long- and short-wave UV radiation. In two of the crystals, however, we noted that the seed fluoresced a faint to weak yellow-green to both long- and short-wave UV.

**Microscopic Characteristics. Color and Growth Zoning.** As mentioned above, some of the specimens displayed eye-visible, straight, light and dark pink bands when viewed parallel to the plane of the seed plate. With magnification, we saw these bands in all the synthetic pink quartz samples (again, see figure 5). In some samples, the bands were extremely fine and closely spaced, whereas in others they were coarser and more distinct. Some additional, faint, parallel growth bands could be seen within the pink layers. The color bands, growth bands, and *c*  $\{0001\}$  faces are parallel to one another (and, therefore, perpendicular to the optic axis). This suggests that the inhomogeneous color is caused by fluctuations in the growth conditions. In some specimens, the color bands were separated from one another by a plane showing a wave-like structure or appearance (figure 8). This feature has not been reported in the natural material.

Some samples displayed a stream-like structure that is typical of synthetic quartz grown in a fluoride-bearing solution (e.g., synthetic amethyst [Balitsky and Tsinober, 1969]). The stream-like structure is seen as faint lines that are oriented perpendicular to the color bands.

Although natural pink quartz also may display color bands and faint perpendicular stream-like structure lines (figure 9), orientation of these features in the two materials is different. In the natural material, the color bands are parallel to the rhombohedral faces (and therefore oblique to the optic axis), whereas in the synthetic material, the color bands are parallel to the basal faces (and therefore perpendicular to the optic axis). Also, the edges of color

zones in natural pink quartz have a feathery appearance when viewed perpendicular to the direction of the color banding (figure 10). This feature is distinctive for natural material, and was not observed in any of the synthetic specimens.

**Inclusions.** Some of the synthetic pink quartz samples contained minute pinpoint and/or “bread-crumbs” inclusions (figure 11), similar to those seen in other hydrothermal synthetic quartz (e.g., see figure 16 in Crowningshield et al., 1986). These inclusions were randomly distributed throughout the sample, or were concentrated along the contact of the seed crystal and the synthetic quartz over-

**TABLE 1.** Properties of Russian synthetic pink quartz as compared to natural pink quartz.

Property	Synthetic	Natural
Color	Light to medium-light pink	Light to medium-light pink
Pleochroism	Weak (rarely moderate) dichroism in two tones of pink	Weak
R.I. ( $n_o$ )	1.540–1.541	1.540–1.541
R.I. ( $n_e$ )	1.550	1.550
Birefringence	0.009–0.010	0.009–0.010
S.G.	2.65	2.65
Fluorescence	Inert <sup>a</sup> to both long- and short-wave UV	Inert to both long- and short-wave UV
Optic character	Uniaxial positive	Uniaxial positive
Twinning	None observed	Brazil-law twinning in all samples
Visible absorption spectrum	Band near 520 nm	Band near 520 nm
IR absorption spectrum	Broad band near 3420 $\text{cm}^{-1}$	Sharp, intense band at about 3580 $\text{cm}^{-1}$ ; broad peak at 3415 $\text{cm}^{-1}$
Color and growth zoning	Color bands parallel to basal faces (and seed plate), perpendicular to the optic axis; wave- and stream-like structures	Color bands parallel to rhombohedral faces, oblique to the optic axis; feathery appearance at the edges
Inclusions	Breadcrumb inclusions; elongate two-phase (liquid-gas) inclusions confined to a colorless seed plate	Liquid and two-phase (liquid-gas) inclusions in curved planes that cross the color bands at random angles

<sup>a</sup>The synthetic quartz seed plate sometimes fluoresces a faint to weak yellow-green to both long- and short-wave UV.

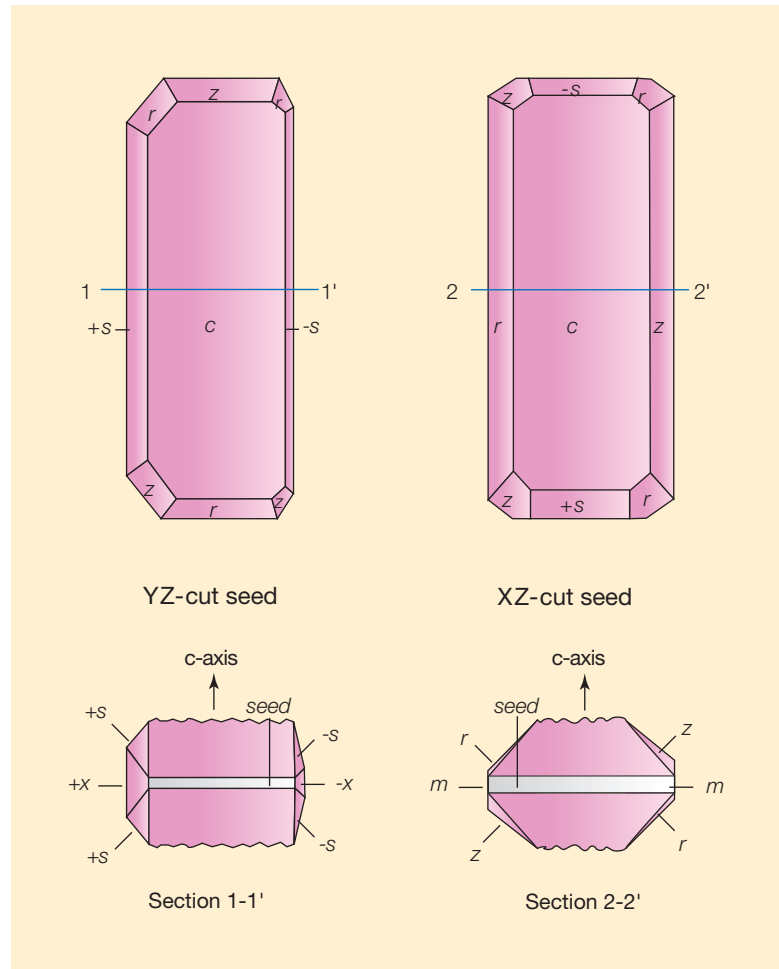

Figure 7. The Russian synthetic pink quartz crystals studied revealed two variations in the tabular crystal habit, depending on the type of seed plate used (YZ-cut or XZ-cut).

Figure 8. A wave-like appearance is visible on the planar surface between color bands in this 7.30 ct faceted synthetic pink quartz. The blue color is due to diffraction of light through the stone. Photomicrograph by Shane F. McClure; magnified 40 $\times$ .





Figure 9. Faint stream-like structure lines are oriented perpendicular to the prominent color bands in this 7.63 ct faceted natural pink quartz from Brazil. Photomicrograph by Shane F. McClure; magnified 16 $\times$ .

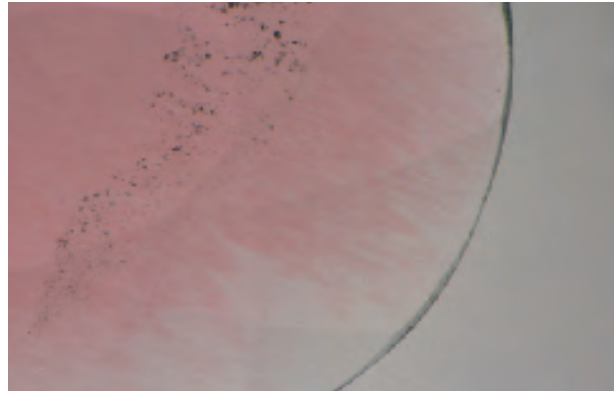

Figure 10. When viewed perpendicular to the color banding, the color zones in natural pink quartz commonly show a feathery appearance at the edges. Photomicrograph by Shane F. McClure; magnified 10 $\times$ .

growth. In some samples, elongate two-phase inclusions were present within the seed plate, oriented perpendicular to the seed and the color zoning (figure 12).

The natural pink quartz we examined contained only liquid and two-phase (liquid and gas) inclusions. The liquid inclusions were confined to irregular curved planes and extended in virtually any direction, crossing the color bands at any angle (figure 13). In contrast, the two-phase inclusions in the synthetic pink quartz were arranged in flat

planes that never crossed the boundary of the seed plate (again, see figure 12). Individual two-phase inclusions within these flat planes were elongated perpendicular to the color bands.

**Other Optical Properties.** As is characteristic of most other types of synthetic quartz, no evidence of twinning was seen when the synthetic pink quartz specimens were examined in an immersion cell between crossed polarizing filters. This feature is significant because all of the natural transparent pink quartz we examined had strong Brazil-law twinning, in much the same manner as most natural amethyst.

Using the polarizing filters and a condensing lens, we could see a uniaxial "bull's-eye" interference figure in all specimens.

Figure 11. "Breadcrumb" inclusions, typical of synthetic quartz, were seen in some samples of synthetic pink quartz. Photomicrograph by Shane F. McClure; magnified 40 $\times$ .

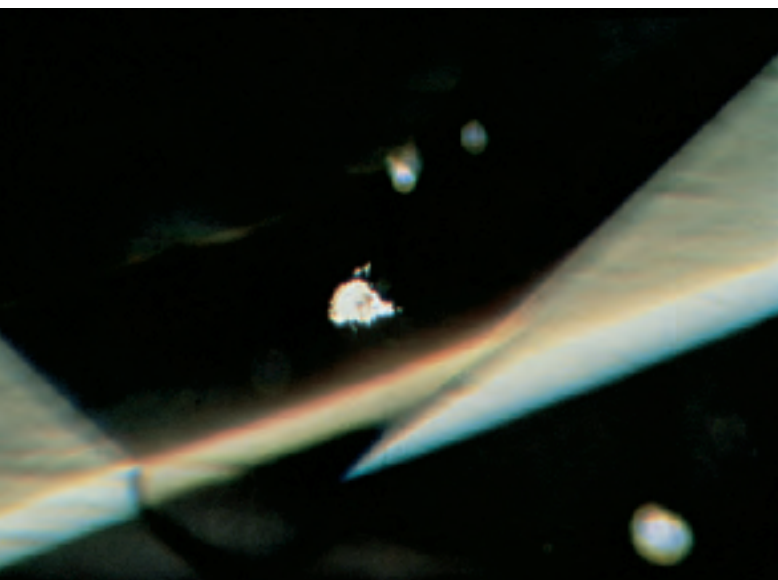

**Spectroscopic Features.** No absorption features were noted in the synthetic pink quartz with the desk-model spectroscope. When the samples were positioned above the light source of the spectroscope, no luminescence to visible light could be seen.

The visible absorption spectrum of the synthetic pink quartz (as measured with a spectrophotometer) exhibits a broad band centered at about 520 nm, as well as increasing absorption toward the ultraviolet (figure 14). This is identical to the visible-range spectrum of natural pink quartz (Rossman, 1994).

Figure 15 compares representative infrared absorption spectra recorded for a synthetic pink quartz and natural pink quartz from Brazil. Spectral features below 3000  $\text{cm}^{-1}$  are common to both specimens, but there are differences in features above this value. Natural pink quartz (spectrum A) dis-



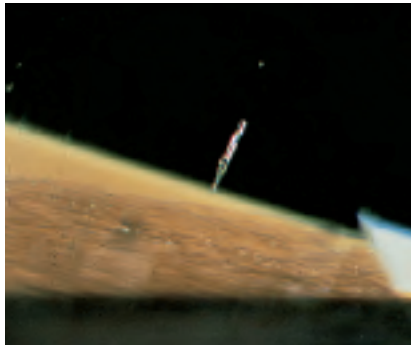
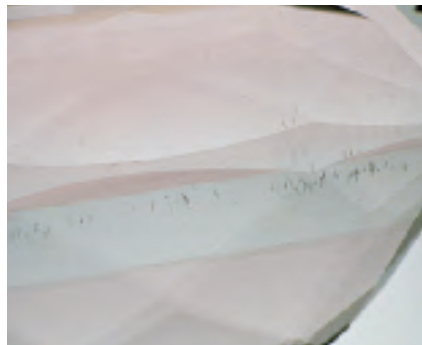

Figure 12. Elongate two-phase inclusions were seen in flat planes confined to the seed plate in some samples (left). These inclusions were always perpendicular to the seed plate, and commonly appeared spike-shaped (right). Photomicrographs by Shane F. McClure; magnified 10× (left) and 28× (right).



Figure 13. Curved planes of liquid and two-phase inclusions crossed the pink color bands at random angles in this natural pink quartz from Brazil. Photomicrograph by Shane F. McClure; magnified 10×.

plays a sharp, intense peak at  $3587\text{ cm}^{-1}$ , a small peak at  $3542\text{ cm}^{-1}$ , and a broader peak at  $3415\text{ cm}^{-1}$ . In contrast, the synthetic sample exhibits a broad absorption feature centered at  $3420\text{ cm}^{-1}$ , and weaker features between  $3500$  and  $3650\text{ cm}^{-1}$ .

The broad band at about  $3420\text{ cm}^{-1}$  is due to molecular  $\text{H}_2\text{O}$  (Rossman, 1988); the tiny peaks at  $3607\text{ cm}^{-1}$ ,  $3572\text{ cm}^{-1}$ , and  $3542\text{ cm}^{-1}$  may be related to structural fluorine-hydrogen complexes (Balitsky et al., 1974). By comparison, the intense peak at  $3587\text{ cm}^{-1}$  and the broad peak at  $3415\text{ cm}^{-1}$  in the natural material are due to hydroxyl group stretching vibrations (Katz, 1962; Rossman, 1988). These differences suggest that synthetic pink quartz contains relatively more molecular water than the natural material.

**Chemical Composition.** EDXRF analysis revealed potassium, iron, calcium, and chromium in both rough and fashioned samples of the synthetic pink quartz. Electron microprobe analysis of the two polished cubes revealed phosphorus (P) and potassium

(K) as the main trace elements. The concentrations of phosphorus and potassium in the dark pink band (P: 390 ppm [parts per million], K: 270 ppm) were much higher than in the light pink band (P: 140 ppm, K: 20 ppm) of the same sample. The concentration of sodium (Na) was much lower than that of potassium (Na: 10 ppm, K: 270 ppm) in the dark pink layer. Aluminum, iron, titanium, and fluorine were not detected by microprobe in either sample.

**Cause of Color.** The high concentrations of phosphorus and potassium in the pink bands suggest that these elements are related to the coloration of synthetic pink quartz. In particular, it is believed that phosphorus—which is added to the growth solution—plays a very important role (Balitsky et al., 1993, 1996). This is supported by chemical data

Figure 14. These visible absorption spectra were recorded using polarized light for orientations parallel (||) and perpendicular ( $\perp$ ) to the optic axis (c-axis) of the synthetic pink quartz. The two spectra are not scaled vertically with respect to one another. The 520 nm broad band is more intense in the spectrum that is perpendicular to the optic axis. Increasing absorption below 400 nm is visible in both spectra.

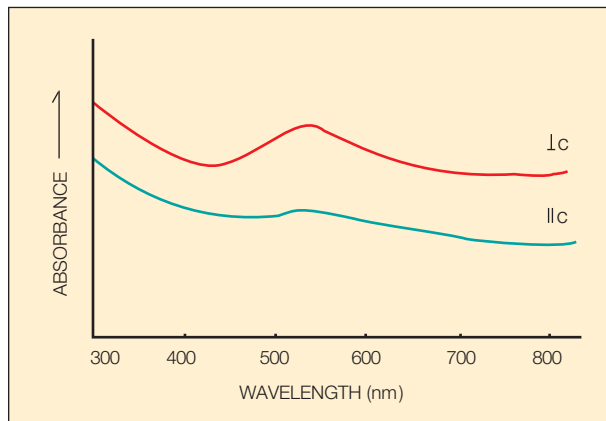

presented here and by electron paramagnetic resonance spectra on synthetic quartz from Russia (Maschmeyer and Lehmann, 1983; Rossman, 1994). Ionizing radiation can produce a complex color center from phosphorus and/or other elements present. This complex center is probably the origin of the color in the synthetic pink quartz, but its details and the coloration mechanism remain to be investigated.

**Color Stability.** Within two weeks of gamma-ray irradiation, up to 15% of the pink color fades under normal lighting conditions (i.e., the material retains about 85% of its original color). After this period, however, the color stabilizes, as was evident by comparison of the samples exposed to sunlight for three years (see, e.g., the smaller piece in figure 16,

Figure 15. Note the differences between these representative infrared absorption spectra for a natural pink quartz from Brazil (A) and a Russian synthetic pink quartz (B) above 3000  $\text{cm}^{-1}$ . In particular, the synthetic pink quartz shows an intense broad band at 3420  $\text{cm}^{-1}$ .

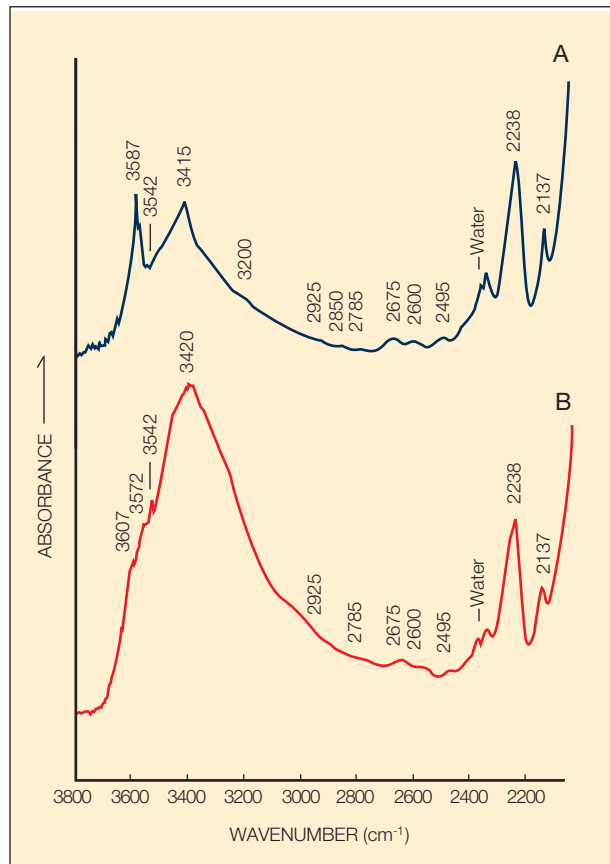

Figure 16. These two samples of synthetic pink quartz are shown here three years after they were irradiated, at which time they were both the same color. However, the crystal on the right (52 mm long  $\times$  10 mm thick) was kept in the dark for the three years, whereas the crystal segment on the left (23 mm long and 12 mm thick) was one of several that were exposed to sunlight throughout this period. The fact that there is very little difference in color between the two samples indicates that the color appears to be stable over time. Photo by Mikhail A. Bogomolov.

on the left) to the control sample kept in the dark for the same period (the larger crystal in figure 16). Color stability was maintained at temperatures below 180°–200°C, but above this range the color disappeared quickly. However, the color could be fully restored by irradiation if the material was not heated above about 350°C, and could be partially restored if it was not heated above 450°C; above 500°C, the color could not be restored.

## CONCLUSION

Although there are many similarities between natural pink quartz and synthetic hydrothermal pink

quartz grown in Russia, we found sufficient differences between the samples we examined to allow separation by standard gem-testing methods. Advanced testing techniques provide supporting evidence for this separation. The synthetic crystals display a characteristic tabular morphology with two large, well-developed basal faces. Color bands are always parallel to the basal faces (and perpendicular to the optic axis) in the synthetic pink quartz, whereas the color bands are always parallel to the rhombohedral faces (and oblique to the optic axis) in the natural pink quartz. The color zones in the natural material showed feathery edges when observed perpendicular to the banding, which were not seen in the synthetics. Small, elongate two-phase inclusions are sometimes seen within and perpendicular to the seed. Curved planes of liquid and two-phase inclusions that crossed the parallel color banding were only seen in the natural material. Unlike most natural material, all of the synthetic pink quartz we examined lacked twinning.

The intense broad band at about  $3420\text{ cm}^{-1}$  in the infrared absorption spectrum of synthetic pink

quartz conclusively separates this material from its natural counterpart. The pink color is thought to result from a phosphorus-related complex color center created by ionizing radiation.

Currently, about 200 kg of this material is produced annually, in crystals up to  $150 \times 40 \times 20\text{ mm}$ . Production capacity could be significantly increased if warranted by market demand.

---

*Acknowledgments: The authors thank Jerry Romanella of Commercial Mineral Company, Scottsdale, Arizona, for donating samples of natural, color-zoned pink quartz from Araçuaí, Brazil. The late R. C. Kammerling, of the GIA Gem Trade Laboratory, made contributions to earlier versions of this manuscript. Sam Muhlmeister of GIA Research prepared the EDXRF spectra. Dijon Douphner, formerly of the GIA Gem Trade Laboratory, prepared the infrared absorption spectra. Paul Carpenter, of the California Institute of Technology, carried out the electron microprobe analysis. Drs. Ilene Reinitz and Mary Johnson of the GIA Gem Trade Laboratory made useful comments on the original manuscript. This study was supported by a grant (97-05-64805) from the Russian Basic Research Foundation.*

---

## REFERENCES

- Balitsky V.S., Tsinober L.I. (1969) Some peculiarities of quartz recrystallization from fluoride-bearing hydrothermal solutions. *Doklady Akademii Nauk SSSR*, Vol. 187, No. 5, pp. 1142–1145 (in Russian).
- Balitsky V.S., Makhina I.B., Tsinober L.I. (1974) About the presence of fluoride impurities in synthetic quartz crystals. *Geokhimiya*, Vol. 3, pp. 487–491 (in Russian).
- Balitsky V.S., Makhina I.B., Prygov V.I. (1992) *Proceedings on quartz mineralogy: Created rose quartz*. Komi Institute of Geology, Ural Scientific Center of the Russian Academy of Sciences, Syktyvkar. pp. 65–66 (in Russian).
- Balitsky V.S., Makhina I.B., Prygov V.I., Mar'in A.A. (1993) Man-made rose quartz. *Proceedings, 24th International Gemological Conference*, 12–15 October 1993, Paris, France.
- Balitsky V.S., Makhina I.B., Emel'chenko A., Mar'in A.A., Shigley J., Fritsch E., Koivula J. (1996) Formation of rose phosphorus-bearing quartz and causes of its rarity in nature: An experimental study. *Geokhimiya*, Vol. 34, No. 11, pp. 1074–1081 (in Russian).
- Cassedanne J.-P., Cassedanne J.-O. (1978) La pegmatite o quartz rose du Alto Feio. *Revue de Gemmologie a.f.g.*, No. 57, pp. 11–14.
- Cassedanne J.-P., Alves J. (1990) Crystallized rose quartz from Alto da Pitorra, Minas Gerais, Brazil. *Mineralogical Record*, Vol. 21, No. 5, pp. 409–412.
- Crowningshield R., Hurlbut C., Fryer C.W. (1986) A simple procedure to separate natural from synthetic amethyst on the basis of twinning. *Gems & Gemology*, Vol. 22, No. 3, pp. 130–139.
- Frondel C. (1962) *Dana's System of Mineralogy*, 7th ed., Vol. 3, *Silica Minerals*. John Wiley & Sons, New York.
- Hosaka M., Miyata R., Shimizu Y., Okuyama O. (1986) Synthesis of rose-quartz crystal. *Journal of Crystal Growth*, Vol. 78, pp. 561–562.
- Kammerling R.C., Fritsch E. (1993) Gem trade lab notes: Color-zoned pink quartz. *Gems & Gemology*, Vol. 29, No. 3, pp. 203–204.
- Katz A. (1962) Hydrogen in alpha-quartz. *Philips Research Reports*. Vol. 17, No. 1–2, pp. 133–168.
- Larson P., Honert J. (1977) Rose quartz of the Black Hills. *Lapidary Journal*, Vol. 31, No. 2, pp. 534–538.
- Makhina I.B., Mar'in A.A., Khadzi V.E. (1992) Rose quartz and aventurine synthesis. *Razvedka I Okhrana Nedr*, Vol. 9, pp. 10–11 (in Russian).
- Maschmeyer D., Lehmann G. (1983) A trapped-hole center causing rose coloration of natural quartz. *Zeitschrift fur Kristallographie*, Vol. 163, pp. 181–196.
- Rossmann G.R. (1988) Vibrational spectroscopy of hydrous components. In F.C. Hawthorne, Ed., *Spectroscopic Methods in Mineralogy and Geology*, Mineralogical Society of America, *Reviews in Mineralogy*, Vol. 18, Chap. 6, pp. 193–206.
- Rossmann G.R. (1994) Colored varieties of the silica minerals. In P.J. Heaney, C.T. Prewitt, G.V. Gibbs, Eds., *Silica—Physical Behavior, Geochemistry, and Materials Applications*, Mineralogical Society of America, *Reviews in Mineralogy*, Vol. 29, Chap. 13, pp. 433–467.



**Editors**

Thomas Moses ♦ Ilene Reinitz  
Shane F. McClure

*GIA Gem Trade Laboratory*

**Contributing Editors**

*GIA Gem Trade Laboratory, East Coast*  
G. Robert Crowningshield

*GIA Gem Trade Laboratory, West Coast*  
Karin Huwit ♦ Mary L. Johnson  
Cheryl Y. Wentzell

## EMERALD, An Interesting "Daughter" Crystal

Emeralds from Colombia are known to gemologists for their three-phase inclusions, which typically contain a brine solution, a gas bubble, and a cube of halite (a "daughter mineral," sodium chloride). For decades, these distinctive inclusions have served as a valuable means of separating such emeralds from their numerous synthetic counterparts, since such inclusions have never been observed in a laboratory-grown emerald.

Although gemologists have become accustomed to the cube form for the daughter crystals in the three-phase inclusions in Colombian emeralds, other isometric forms for these salt crystals have also been seen. For example, in plate 2 of his monograph "Composition of Fluid Inclusions" (U.S. Geological Survey Professional Paper 440-JJ, 1972), Dr. Edwin Roedder showed a photomicrograph depicting octahedral halite crystals in a three-phase inclusion in an emerald from the Muzo mine.

Consequently, the triangular crystal observed in the three-phase inclusion shown in figure 1, in an emerald sent to the West Coast GIA Gem Trade Laboratory for identification, was unusual but not totally unexpected. At first glance, one might think that this crystal was from the trigonal crystal system. But polarized light did not show any evidence that this material was doubly refractive. It behaved as one would expect of an isometric, unstrained crystal such as halite. We conclude that its triangular form was due to space restrictions,

because the crystal was actually a highly modified octahedron showing growth preference to one octahedral face. Examining the photomicrograph by Roedder, one can easily see the source of the triangular form: A single octahedral face is a perfect triangle.

The world of synthetic gemstones also provides us with an example of such modification in the isometric system. Although the element platinum crystallizes in the isometric system, it forms distinct triangles and hexagons in manufactured gems such as synthetic rubies and synthetic alexandrites. This is no accident. In the case of a triangular platelet, the crucible-derived platinum has shown preference to one octahedral face over all other faces in the presence of the host material. In the case of a hexagon, a combination of an octahedral face with its edges modified by cube faces is the dominant form.

The cube is the most common isometric form shown by salt crystals in the fluid inclusions in Colombian emeralds. However, any of the other isometric forms cannot be discounted, and the gemologist should remember that modifications of these forms are a distinct possibility.

*John I. Koivula*

## HEMIMORPHITE, Rough and Fashioned

Many of the gem materials listed on GIA's "B Gem Property Chart" are seldom seen in either the East or West Coast labs. Thus, it was quite a coincidence last winter when a 234 ct piece of greenish blue fibrous rough

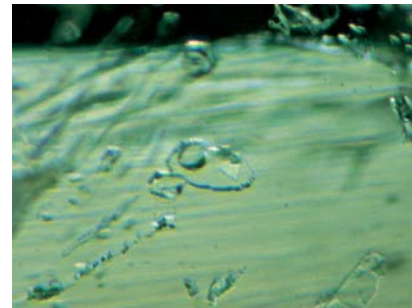

*Figure 1. The 0.7-mm-long three-phase inclusion in the center of this photomicrograph of a Colombian emerald contains a triangular daughter crystal of salt.*

received for identification in the West Coast lab, and an 8 x 6 mm greenish blue cabochon sent to the East Coast lab a few weeks later, turned out to be the same "B Chart" material.

The cabochon, which was mounted in a white metal ring (from which the client later removed it for advanced testing), was translucent (figure 2); magnification revealed a fibrous, banded structure. We obtained a spot refractive index of 1.62. The stone was inert to ultraviolet radiation, and showed no lines in the hand spectroscope. In the polariscope, it gave an aggregate reaction.

The piece of rough showed similar properties, with the same fibrous, banded structure that was evident in the cabochon (figure 3). A discreet

*Editor's note: The initials at the end of each item identify the editor(s) or contributing editor(s) who provided that item.*

*Gems & Gemology, Vol. 34, No. 1, pp. 44-49*  
©1998 Gemological Institute of America

hardness test revealed that the material was rather soft, with a Mohs value less than 5. Although the refractive index, aggregate nature, and greenish blue color were not sufficient to identify the cabochon, the additional property of hardness narrowed the choices down to two likely possibilities: smithsonite, a zinc carbonate; or hemimorphite, a hydrated zinc silicate.

Chemical analysis by EDXRF showed the same results for both the rough and the cabochon: large quantities of Si and Zn, with small amounts of Fe, Cu, and Pb. The presence of silicon as a major element indicated that both samples were hemimorphite. The last time either lab recalls receiving a sample of hemimorphite for identification was in 1971 (Winter 1971–1972 Lab Notes, pp. 383–384), when the properties offered the same two choices and we were able to make the distinction on the basis of specific gravity. This test should still provide the key discrimination in cases where it is practical.

*IR and MLJ*

#### **JADEITE, With Inclusions of Zircon**

As the practice of bleaching and impregnating jadeite has become more common over the last few years, the amount of jadeite we test in the laboratory has increased significantly. During the microscopic examination of one variegated green jadeite cabochon for possible evidence of treatment, we noted that the stone contained a number of small crystal inclusions, some of which reached the surface (figure 4). These surface-reaching crystals appeared to be somewhat harder than the surrounding jadeite, and in reflected light they had a higher surface luster. With the recent acquisition of GIA's Renishaw Raman Imaging Microscope System, we were able to examine two of these crystals nondestructively.

By focusing the argon laser through the 50x objective of the Leica targeting microscope and running several continuous scans, we



Figure 2. This 8 x 6 mm cabochon proved to be the rare gem mineral hemimorphite.

obtained clear spectra of the two "inclusions." A computer search of our data base revealed that these spectra matched the spectrum for zircon. Visible characteristics of the inclusions (e.g., crystal form, color, transparency, and relative hardness) were consistent with this identification. This is the first time that we have encountered zircon crystals as inclusions in jadeite. Coincidentally, about a month prior to our discovery, a zircon inclusion in a jadeite cabochon was also identified by means of the same technique at the Center for Gemstone Testing in Bangkok (Kenneth Scarratt, pers. comm.).

*John I. Koivula and TM*

#### **MOTHER-OF-PEARL Doublet**

Pearl and shell are often used to make various assemblages, the most common of which are mabe pearls. The relatively subtle differences in physical and gemological properties between a pearl, mother-of-pearl, and the shell from pearl-forming mollusks can make the complete identification of some assemblages from these materials especially challenging. The animals that make pearls secrete calcium carbonate (as either aragonite or calcite) and conchiolin (a brown to black substance composed of various proteins) to create their shells. Control over whether calcite or aragonite is produced has been attributed to a variety of factors (see, e.g., A. M. Belcher et al., "Control of Crystal Phase Switching and Orientation by



Figure 3. A fibrous, banded structure is typical of hemimorphite. Magnified 30x.

Soluble Mollusc-Shell Proteins," *Nature*, Vol. 381, 1996, pp. 56–58).

For the most part, the differences in properties between pearl, mother-of-pearl, and shell are caused by differences in the arrangement of the calcium carbonate and the conchiolin. The bulk of a shell is composed of columns of calcium carbonate, with small areas of conchiolin between them; mother-of-pearl is composed of long, thin sheets of aragonite alternating with thin layers of conchiolin; and a pearl is composed of overlapping thin curved layers of aragonite and conchiolin (see J. Taburiaux's *Pearls: Their Origin, Treatment, and Identification*, Chilton Book Co., Radnor PA, 1985, pp. 107–113, for more details and some excellent sketches). The thin, alternating layers of conchiolin and aragonite produce a phenomenon known as orient. The curved geometry of these layers causes a pearl to have orient from all

Figure 4. Raman microanalysis of the two largest included crystals in this jadeite cabochon showed that they were zircon. Magnified 15x.



viewing angles, while the flat arrangement found in mother-of-pearl allows orient to be seen from only one direction. The underlying shell does not show orient.

The 0.55 ct orangy pink cabochon shown in figure 5 presented just such an identification challenge to the West Coast laboratory. The assembled nature of the piece was apparent with magnification. The top was transparent and primarily colorless, although magnification revealed scattered red spots; it gave a range of spot R.I. values, from 1.50 to 1.65. This material also melted readily when the thermal tester was applied to an inconspicuous spot, emitting a strong odor of burning plastic.

The translucent white base of the assemblage showed a parallel, undulating, fibrous structure when viewed with magnification. It yielded a refractive index of 1.53 with a weak birefringence blink, and it effervesced to dilute HCl. The blink and effervescence pointed to a carbonate, and the refractive index indicated aragonite, rather than calcite. The piece showed an aggregate reaction between crossed polarizers, consistent with either shell or mother-of-pearl. The determination finally rested on the appearance of the base to the naked eye: Orient was seen from one angle in this piece of mother-of-pearl.

The position of the pink color just under the plastic top reminded us of the "treated" mabe pearls reported

*Figure 5. Magnification revealed that this 0.55 ct cabochon was assembled from a mother-of-pearl base and a plastic top.*



in the Fall 1991 Lab Notes section (p. 177). In that case, a mother-of-pearl base was covered with a plastic dome and a highly reflective coating, then placed in an oyster to receive a thin layer of nacre. All of these components were visible in a sample that our client cut open. We were not permitted to destroy the present cabochon, so we could not determine exactly where and how the pink color had been applied. *IR and MLJ*

#### **Cat's-Eye OPAL**

In spring 1997, the West Coast lab received for identification the brownish yellow cat's-eye shown in figure 6. The chatoyancy in this 9.00 ct oval double cabochon resulted from numerous parallel "needles"—both fine and coarse—which were oriented across the width of the stone. A spot R.I. of 1.45 and a specific gravity of 2.08, obtained hydrostatically, pointed to opal as the bulk material, notwithstanding that brown is an unusual color for opal. Opal is singly refractive, but phenomenal opal often exhibits anomalous double refraction between crossed polarizers. In this case, observation down the length of the cabochon revealed an indistinct uniaxial optic figure. The gem also displayed distinct dichroism, with one color more yellow and the other more brown. The cabochon was inert to long-wave ultraviolet radiation and fluoresced weak red to short-wave UV. It had a slightly resinous luster.

These properties closely match those of a chatoyant opal described in the Fall 1990 Gem News (pp. 232–233). In that report, the authors suggested that the opal could be a pseudomorph after a fibrous iron-bearing mineral, and that the inclusions were most likely remnants of goethite. GIA Research analyzed the present cabochon using EDXRF and found silicon, iron, potassium, calcium, and zinc. The presence of iron supports the idea that the inclusions could be goethite.

The brownish yellow color of this cabochon (which appears to be directly related to the inclusions) is

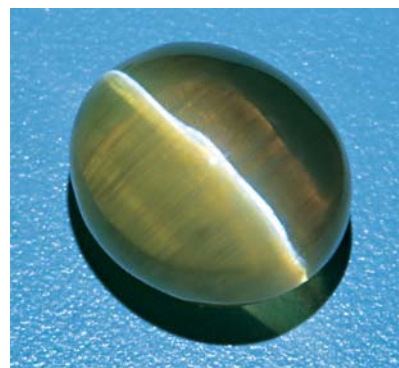

*Figure 6. The unusual color and rare chatoyancy of this 9.00 ct opal are caused by inclusions of fine and coarse "needles," possibly goethite.*

similar to the dark brown color described for the treated-color cat's-eye chrysoberyls that made news last fall because of their residual radioactivity (see, e.g., Fall 1997 Gem News, pp. 221–222). However, the properties of opal are very different from those of chrysoberyl. In particular, the differences in luster (vitreous to resinous for opal, subadamantine to vitreous for chrysoberyl), refractive index (1.45 versus 1.74), and specific gravity (2.15 as compared to 3.73) are so large that the two minerals can be readily distinguished. Cat's-eye opal is not known to be irradiated, or to show any residual radioactivity.

*CYW and IR*

#### **RUBY, with Surface Evidence of Treatment**

Rubies and sapphires often show obvious signs of high-temperature heat treatment after being subjected to temperatures of 1500°C or more during the treatment process. Much of this evidence is internal and cannot be removed through normal lapidary techniques. In certain cases, however, the surface of the treated gemstone retains at least some of the visible signs of heat treatment, such as surface-sintered residue, glass fillings, near-surface solid and fluid inclusions that have ruptured through—and spread out onto—the surface, or par-



tial melting of the surface itself if the treatment temperature is high enough (this last indication, "fireskin," is described on p. 140 of the Summer 1997 Lab Notes). Although usually the surface features can be completely removed by repolishing, it is also true that any cavities, pits, and other depressions in a surface that might contain evidence of heat treatment are likely to be missed during the repolishing process.

Recently, in the West Coast lab, we encountered two instances of repolishing after heat treatment that were unique to our experience. Both of the gems were mixed-cut rubies with brilliant-cut crowns and step-cut pavilions, one over 8 ct and the other just over 1 ct. They were sent in by different clients at different times.

Not only did both of these rubies contain what we have come to consider obvious internal signs of heat treatment (such as melted and exploded crystals surrounded by glassy "fingerprint" inclusions, discoid fractures, etc.), but both also had surface pits (up to 2.6 mm long on the 8 ct stone) that had been partially repolished (figure 7). When the stones were viewed with magnification in surface-reflected light, semi-circular grooves were readily apparent near the edges of these pits. The only way such marks could have been made on the surface of a gemstone as hard as ruby would have been by the use of a rotary tool and, probably, a diamond compound as the abrasive polishing agent. These attempts to remove the surface evidence of treatment in the tell-tale pits were not particularly successful, as other evidence of heat treatment was still visible. In addition, the presence of the curved grooves provided evidence that the indented surfaces in the cavities had been polished in an attempt to conceal the treatment. It is possible that the repolishing was intended to remove the glass-like fillings deposited in surface depressions that are often a by-product of the heat treatment of rubies.

*John I. Koivula*



*Figure 7. A rotary tool was used to partially repolish this 2.6-mm-long pit in the surface of a ruby, probably to remove evidence of heat treatment. Notice the curved grooves made by the tool in the faceted surfaces near the edge of the pit.*

#### **SAPPHIRE, Internal Diffusion Revisited**

From time to time during the mid-1980s to early 1990s, we encountered transparent spherical clouds of intense blue color surrounding dark crystal inclusions in heat-treated sapphires. These stones were all from alluvial deposits in Montana, such as Rock Creek and Eldorado Bar, and the spherical blue clouds were important evidence of heat treatment. (In our experience, sapphires from the primary deposit at Yogo Gulch are not heat treated, and hence do not show such clouds.) For the last several years, however, we have not seen any sapphires with these vivid blue spheres. We were therefore surprised to observe such inclusions in a round-brilliant-cut sapphire submitted for identification last fall to the East Coast laboratory (figure 8).

These spherical blue clouds are caused by internal diffusion of color-causing elements from solid inclusions, which happens during heat treatment at temperatures that approach the melting point of sapphire. In effect, the host corundum cannibalizes the inclusions for their chromophores, diffusing those elements away from the inclusions, and creating more-or-less spherical clouds

of color. Internal diffusion was first described in a 1987 report in the *Journal of Gemmology* (J. I. Koivula, "Internal Diffusion," Vol. 20, No. 7–8, pp. 474–477). The smaller the inclusions were, the smaller—and generally less intense—the blue spherical clouds appeared. This makes such spheres more difficult to recognize.

An excellent example of this more subtle form of internal diffusion is found surrounding tiny, dust-like needles of rutile and ilmenite in heat-treated sapphires from many different localities. The clouds of color produced in this manner consist of very small pale yellow or blue spots, often

*Figure 8. These blue spherical clouds surrounding dark crystal inclusions in a heat-treated sapphire are caused by internal diffusion. Magnified 20x.*

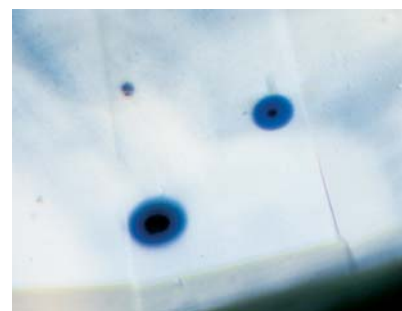

causing a subtle mottled appearance in the sapphire. This form of internal diffusion is best observed in diffused transmitted white light, and is a useful indication of heat treatment.

John I. Koivula

### SCAPOLITE, Showing Asterism

Scapolite is an unusual gem, more common in collections than in jewelry. Found in a variety of colors in Tanzania, Myanmar, Madagascar, Brazil, and Sri Lanka, scapolite often contains interesting inclusions. In some stones, masses of long, slender inclusions lead to chatoyancy or, more rarely, to asterism.

Recently, a dealer shared two large reddish brown scapolite cabochons from Tanzania with the West Coast laboratory. Both were mined in the mid-1980s, the 30 ct cabochon from the Dodoma area in central Tanzania and the 17.04 ct cabochon from Umba, in northern Tanzania. The Dodoma scapolite showed strong chatoyancy, and the Umba cabochon (figure 9) displayed a strong chatoyant band that provides the central arms of an otherwise weak, but well-formed, eight-ray star. Asterism in scapolite is quite rare, especially in such a distinct star with so many rays; we have previously reported on a weak four-ray star in a gray scapolite from Sri Lanka (Fall 1990 Gem News, p. 233) and a distorted, six-ray star in reddish-brown scapolite from Kenya (Spring 1984 Lab Notes, pp. 49–50).

Both cabochons showed properties typical for scapolite: a spot refractive index of 1.55 and a specific gravity of 2.66, measured hydrostatically. They were inert to long-wave ultraviolet radiation, and fluoresced weak red to short-wave UV. The chatoyancy in the 30 ct Dodoma scapolite was caused by long, thin, reddish brown inclusions (figure 10), similar to the goethite in scapolite illustrated in the *Photoatlas of Inclusions in Gemstones* (E. J. Gübelin and J. I. Koivula, 1986, ABC Edition, Zurich, p. 370). The inclusions in the asteriated stone were similar in color, but much shorter and more densely concentrated (fig-

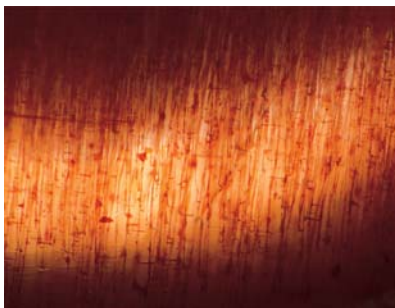

Figure 9. Note the strong chatoyant band and six additional weak, but distinct, rays in this 17.04 ct star scapolite from Tanzania's Umba Valley.

ure 11). Although scapolite is uniaxial, the inclusions in both specimens created a pseudobiasial figure in the polariscope. These inclusions were also the cause of the face-up color in these stones. Because of the relatively precise parallel alignment of the brown needle-like inclusions in the larger cabochon, it was easy to see between them when looking at the piece in profile view. This allowed us to see the true body color of the stone, which was light yellow, a common color for scapolite.

In the early 1980s, Graziani and others investigated a small number of specimens of reddish brown scapolite

Figure 10. These long, slender, reddish brown inclusions are responsible for both the chatoyancy and the overall color of this 30 ct scapolite cabochon. Magnified 20x.



from Tanzania to determine the exact identity of the phenomenon-causing inclusions (G. Graziani and E. Gübelin, "Observations on Some Scapolites of Central Tanzania," *Journal of Gemmology*, 1981, Vol. 17, No. 6, pp. 395–405; and G. Graziani, E. Gübelin, and S. Lucchesi, "Observations on Some Scapolites of Central Tanzania: Further Investigations," *Journal of Gemmology*, 1983, Vol. 18, No. 5, pp. 379–381). They found long, thin growth tubes filled with both small scapolite crystals and crystals of an iron oxide or hydroxide. By bracketing the temperature history of their samples, these authors concluded that—along with the small crystals of scapolite—lepidocrocite [ $\gamma\text{-FeO(OH)}$ ] had originally grown in these tubes, rather than goethite [ $\alpha\text{-FeO(OH)}$ ], and that these inclusions had dehydrated at modest temperatures ( $\sim 350^\circ\text{C}$ ) to the magnetic mineral maghemite ( $\gamma\text{-Fe}_2\text{O}_3$ ).  
SFM and IR

### TOPAZ, Natural-Color Green

The unusual 2.59 ct light bluish green oval brilliant shown in figure 12 was submitted to the West Coast laborato-

Figure 11. The reddish brown inclusions in the star scapolite shown in figure 9 are shorter and more densely concentrated than those in the 30 ct cat's-eye stone, and they are oriented in four different directions, rather than just one. The more intense central arms result from even denser concentrations of the inclusions. Magnified 20x.





Figure 12. A natural-color green topaz, such as this oval brilliant, is quite rare. This color usually arises from irradiation treatment.

ry for identification. The measured refractive indices (1.611–1.620) and the biaxial optic character indicated topaz. Specific gravity obtained by the

hydrostatic method and with the DiaMension noncontact measuring device resulted in values of 3.55 and 3.56, respectively. The stone fluoresced green, weakly to long-wave UV and with medium intensity to short-wave UV. These properties confirmed the identification. Two distinctive features were seen with magnification: (1) a cluster of parallel, small, thread-like inclusions; and (2) straight and angular growth lines that delineated a zone of more saturated color deep in the pavilion.

Green is an unusual color for topaz. Like the saturated blue colors most commonly seen on the market today, green typically results from irradiation in a nuclear reactor, although at higher temperatures than those that produce blue (see C. E. Ashbaugh III and J. E. Shigley, "Reactor-Irradiated Green Topaz,"

*Gems & Gemology*, Summer 1993, pp. 116–121). Such irradiation causes residual radioactivity, which decays over time. The presence of radioactivity is proof of treated color, but the absence of it is ambiguous; this gemstone displayed no radioactivity above normal background to a handheld Geiger counter. However, the neutrons from a reactor completely penetrate a gemstone such as topaz, resulting in even coloration, whereas this stone showed marked color zoning with magnification. Thus, we concluded that this stone was a rare natural green topaz. *IR and CYW*

PHOTO CREDITS

John Koivula photographed figures 1, 4, 7, and 8. Maha DeMaggio took photos 2, 5, 6, and 12. Shane F. McClure provided figures 3 and 9–11.

## CALL FOR POSTERS

The Gemological Institute of America will host the International Gemological Symposium in San Diego, California, from June 21 to 24, 1999. More than 2,000 people are expected to attend this pivotal event. The Symposium's dynamic program will feature technical sessions and panel discussions on topics of vital interest to all members of the gem and jewelry industry. In addition, there will be an open Poster Session featuring original presentations on topics such as new gem materials, synthetics, treatments, gem identification and grading, instrumentation and techniques, gem localities and exploration, jewelry manufacturing, and jewelry design.

Contributions are being solicited for this Poster Session. To be considered, please submit a preliminary abstract of no more than 250 words to one of the Poster Session organizers listed below. Space is limited, so please submit early. The final deadline is October 1, 1998.

For more information on the Poster Session or the Symposium, please contact the individuals below, or write them at: GIA, 5345 Armada Drive, Carlsbad, CA 92008.



## International Gemological Symposium

San Diego

June 21–24, 1999

### ADDITIONAL INFORMATION:

Poster Session

**James Shigley**  
760.603.4019  
760.603.4021 (FAX)  
jshigley@gia.edu

**Dona Dirlam**  
760.603.4154  
760.603.4256 (FAX)  
ddirlam@gia.edu

Symposium

**Carol Moffatt**  
760.603.4406  
760.603-4405 (FAX)  
igs@gia.edu



# GEM NEWS

Editors • Mary L. Johnson and John I. Koivula

Contributing Editors

Dino DeGhionno and Shane F. McClure,  
GIA GTL, Carlsbad, California

Emmanuel Fritsch, IMN, University of Nantes, France

Henry A. Hänni, SSEF, Basel, Switzerland

Karl Schmetzer, Petershausen, Germany

## TUCSON '98

We always hope that the Tucson shows will unfold like a great novel, with one resounding gemological theme tying together all the disparate subplots. If there was one great theme this year, gemstone treatment certainly earned that title, although it was a subject for education rather than resolution in Tucson. The International Colored Gemstone Association (ICA) and the American Gem Trade Association (AGTA) sponsored a pre-AGTA-show "summit" meeting on treatments with representatives from various gemological laboratories. AGTA also put together an informative display on the main show floor concerning some better-known treatments in emeralds (clarity enhancement) and rubies (glass filling). Conversation throughout the shows often centered on the need for treatment disclosure and the efforts being made by AGTA, ICA, and other organizations to promote such disclosure.

Again, though, Tucson produced many new and/or different gem materials, or ways of using gem materials. We thank Giulia Goracci and Dr. Ilene Reinitz of the GIA Gem Trade Laboratory in New York, and Carlsbad GIA Gem Trade Laboratory regulars Maha DeMaggio, Cheryl Wentzell, and Philip Owens, in addition to our usual contributors, for their help in providing the following report. More information from the Tucson shows will be presented in upcoming Gem News sections.

### DIAMONDS

**Gem crystals from Russia and China.** Because the Tucson shows concentrate on colored stones—or mineral specimens—rather than diamond as a gem material, diamonds at Tucson are commonly sold as mineral specimens, that is, as loose crystals or crystals in matrix (see,

e.g., Spring 1996 Gem News, p. 52). Continuing this tradition, Jack and Elaine Greenspan, of Woody Creek, Colorado, had crystals that displayed several different shapes, including cuboids, octahedra, dodecahedroids, and macles, that were reportedly from Russia (figure 1) and other sources. In addition, diamonds stated to be from China were also available (again, see figure 1) from Ande Jewelry and Mineral Co., of Tucson.

*Figure 1. Diamonds were once again available at Tucson as natural crystals. The 0.84 ct dodecahedroid on the left is reportedly from the Mir Pipe, Russia; the 0.17 ct octahedron on the right is believed to be from China. Photo by Maha DeMaggio.*

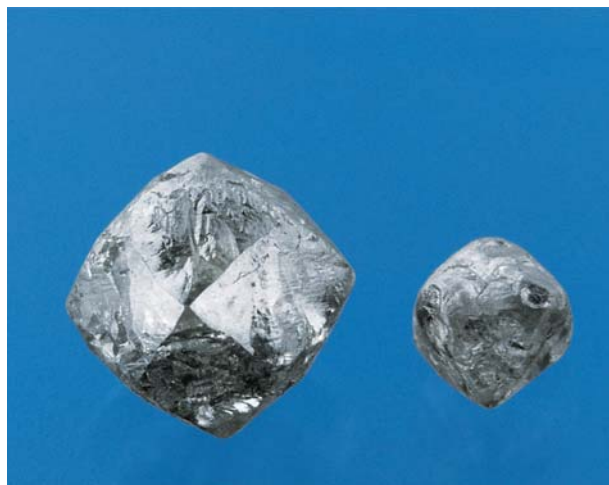

## COLORED STONES AND ORGANIC MATERIALS

**Andalusite (chiastolite) sphere.** Andalusite is usually seen in the gem trade as green to orangy brown faceted stones showing strong pleochroism. However, andalusite is also an important rock-forming mineral, and most crystals in nature are opaque and included. One variety is named for its inclusions: Opaque carbonaceous inclusions form a cruciform pattern in the variety *chiastolite*, which is usually cut into cross-sections to display this pattern. Ande Jewelry and Mineral Co. was offering chiastolite from China fashioned in a different way, as spheres. We examined one 26.33-mm-diameter sphere (figure 2) and found the following gem properties: color—mottled purplish pinkish brown bodycolor with black “spokes”; diaphaneity—opaque; refractive index—1.63 (spot reading); and specific gravity—3.13 (measured hydrostatically).

The four-spoked pattern is typical for this variety of andalusite, and it is a strong clue to the identity of the piece. The dark material (remnants of the host rock) in chiastolite is concentrated at the center of the crystal and along the boundaries between prism faces; the usual explanation for this feature is that these remnants were swept aside by the rapidly growing prism faces (see, e.g., W. A. Deer et al., *Rock-Forming Minerals, Volume 1A: Orthosilicates*, 1982, Longman Group Ltd., London, p. 770).

**Coral with a blue sheen from Alaska.** Usually when we think of coral, what comes to mind is the white-to-red material produced by colonies of tiny invertebrates (*Corallium rubrum*) in warm waters. This material is pri-

*Figure 2. This 148.50 ct (26.33 mm diameter) sphere has been fashioned from the chiastolite variety of andalusite, which is distinctive for the cross-shaped pattern formed by carbonaceous inclusions. Photo by Maha DeMaggio.*



*Figure 3. This yellowish brown coral (12.34 ct; 40.91 x 9.90 x 5.54 mm), which has areas with blue sheen, is from Alaskan waters. Photo by Maha DeMaggio.*

marily made of carbonate minerals. However, there are also black, blue, and golden corals that are produced by different coral species, many of which are threatened or endangered; these materials are composed of conchiolin (a protein), and resemble horn in their gem properties. These latter types are also mainly found in tropical waters off central Africa and Hawaii, as well as Australia and Tasmania. (For more on corals, see R. Webster and P. G. Read, *Gems: Their Sources, Descriptions, and Identification*, 5th ed., 1994, Butterworth-Heinemann, Oxford, England, pp. 559–564.)

Bill Gangi of Bill Gangi Multisensory Arts, Tucson, showed the Gem News editors another variety of coral that is yellowish brown and horn-like in appearance; many samples have areas with a pronounced blue sheen (figure 3). Also unlike other coral materials, it was harvested from depths of 1,000 feet (more than 300 m) in the relatively cold waters of the Gulf of Alaska. According to Mr. Gangi, the source animal is the coral *Primus willemyi*. He is marketing the material as “Alaska Gem Coral.” His stock was legally harvested by a fisherman who was dredging in the 1970s. Mr. Gangi acquired about 100 kg from the tons of material recovered.

**Bicolored corundum.** Gillian Fitch Inskeep of Gilliana, Sonoma, California, showed the *Gems & Gemology* editors a faceted corundum that poses an interesting nomenclature problem. The 2.11 ct opposed-bar cushion cut was red on one end and blue on the other (figure 4). We have seen the terms *bicolored corundum* (see, e.g., C. P. Smith et al., “Rubies and Fancy-Color Sapphires from Nepal,” *Gems & Gemology*, Spring 1997, pp. 24–41), *bicolored sapphire*, and even *bicolored ruby/sapphire* attached to similar material. Ms. Inskeep believes



Figure 4. One end of this 2.11 ct corundum, reportedly from Vietnam, is blue sapphire, and the other is ruby. Photo by Maha DeMaggio.

that this particular example, which measures 9.12 × 5.26 × 4.38 mm, came from Vietnam.

**Emerald from Tocantins, Brazil.** Bear and Cara Williams of Bear Essentials, Jefferson City, Missouri, showed the editors several samples of emeralds from a new deposit in Tocantins State, Brazil, about 30 km from Paraíso. According to Mr. Williams, the deposit was found in mid-1996 and has been exploited intensively by *garimpeiros* (independent miners) since mid-1997. The emeralds occur in a schist “pipe” that is 2.5 km long, about 400–500 m wide, and dips downhill to the northwest at 24°. Although Mr. Williams did not know the total production from this new location, he commented that the deposit had been exploited only to a depth of about 1 m thus far. The largest faceted stones produced to date weigh about 5 ct. In the February 27, 1998, issue of *Mining Journal, London* (p. 165), it was stated that Verena Minerals of Toronto, Canada, has acquired an emerald claim near Paraíso for \$212,000 plus royalties. This may be the same property, although the *Mining Journal* describes the deposit as being a “series of pegmatite dykes” rather than a schistose source rock.

Mr. Williams described this material as being very similar in appearance to typical emeralds from Africa: that is, somewhat bluish and dark in color, with inclusions similar to those seen in Sandawana and Zambian emeralds. The stones we saw at his booth appeared bluish green, relatively dark (compared to Colombian stones), and slightly desaturated.

We examined two emeralds from Tocantins in detail, a 5.00 ct oval modified brilliant and a 1.12 ct emerald cut (figure 5). Gemological properties of the stones were as follows: color—green; diaphaneity—transparent; pleochroism—yellowish green to bluish green; optic character—uniaxial; (Chelsea) color filter reaction—very weak orange; refractive indices—1.591–1.600; birefringence—0.009; specific gravity—2.77 (large stone), 2.78 (small stone); very faint yellow luminescence to long-wave UV radiation in feathers only (large stone), or

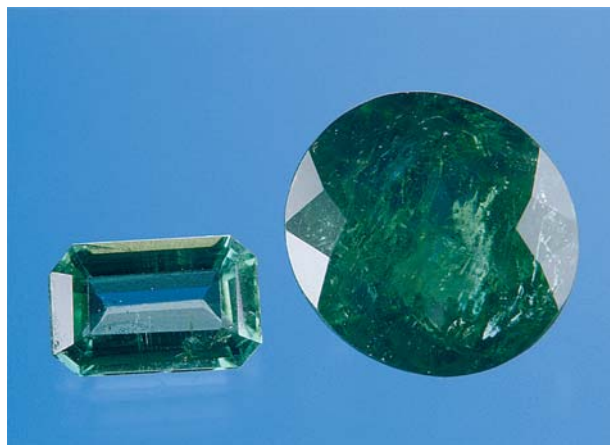

Figure 5. The 5.00 ct oval emerald is reportedly one of the largest stones to have come from the new deposit in Tocantins State, Brazil. The 1.12 ct emerald cut is representative of the cleaner material available from Tocantins State. Courtesy of Bear Essentials; photo by Maha DeMaggio.

inert (small stone); inert to short-wave UV; no visible luminescence; typical emerald spectrum when viewed with a handheld spectroscope (see, e.g., R. T. Liddicoat, Jr., *Handbook of Gem Identification*, 12th ed., 1993, GIA, Santa Monica, California, pp. 139–140). These properties are similar to those that have been recorded in Brazilian emeralds, but somewhat higher than those from other similar environments (see, e.g., J. C. Zwaan et al., “Update on Emeralds from the Sandawana Mines, Zimbabwe,” *Gems & Gemology*, Summer 1997, table 3, p. 97). Both stones contained blocky two-phase (liquid and gas) inclusions and “fingerprints”; the smaller stone also contained needle-like inclusions in parallel orientation, and the larger had iron-stained fractures. Both showed evidence of clarity enhancement.

**Spessartine garnet from Madagascar.** Spessartine from Madagascar was prominent in Tucson this year. Yellowish to reddish orange to orangy brown garnet from Maevatanana in north-central Madagascar was being marketed by Allerton Cushman & Co., Sun Valley Idaho, and—as “Fireball garnet”—by Hargem Ltd., of Ramat Gan, Israel. According to Mr. Cushman, the garnets are alluvial in origin and are found as a by-product of gold mining in the region. Samples analyzed by Colgem Ltd., of Ramat Gan, Israel, have a composition of 94 mol.% spessartine, 4–6 mol.% almandine, and 1–2 mol.% grossular, with no significant pyrope component.

One Hargem stone was particularly notable for its large size and workmanship. Beginning with a “windowed” block of rough weighing 98.51 ct—which had probably weighed over 100 ct before the window was cut—lapidarist Glenn Lehrer of Lehrer Designs, San Rafael, California, fashioned a 63.14 ct fantasy-cut stone (figure 6, left). This exceptional yield from the rough was due to at least two factors: the free-form shape, and the use of curved facets on the pavilion of the stone (figure 6,



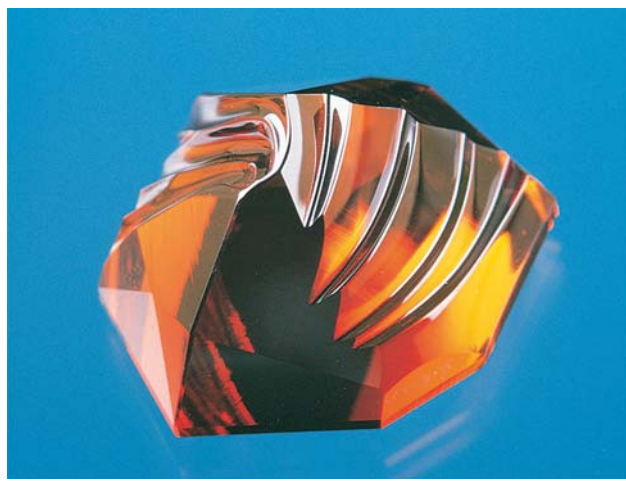
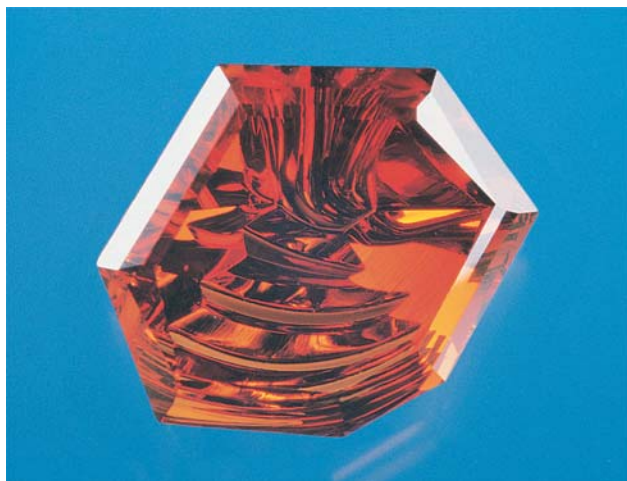

Figure 6. Glenn Lehrer fashioned a 98.51 ct piece of spessartine garnet from Madagascar into this 63.14 ct fantasy cut (left). The curved facets on the pavilion (right) carry the light into the stone. Courtesy of Hargem Ltd.; photos by Maha DeMaggio.

right), which also brought out the color and liveliness of the material. This cutting style is slightly reminiscent of the hollow cabochons in which dark garnets traditionally are cut, but it shows far greater sophistication.

**Sphene from Madagascar.** Large, gemmy pieces of green to yellowish brown sphene are being recovered from a new deposit in northern Madagascar. According to Tom Cushman, the Emily mine is at the northernmost point of Madagascar, in the region between Antsiranana and Vohemar. The sphene occurs with epidote and quartz crystals in Alpine-type veins cutting calc-silicate host rock; it must be removed using hard-rock mining techniques. A few tens of kilograms of gem material have been recovered since mining began about a year ago. The sphene is notable for its size (figure 7); the largest cut stone seen so far is about 29 ct. Much of the material

Figure 7. This 21.79 ct cushion cut was fashioned by Buzz Gray from a sphene mined recently in northern Madagascar. Courtesy of Allerton Cushman & Co.; photo by Maha DeMaggio.



looks pink when viewed through a (Chelsea) color filter, which suggests that it contains chromium.

**Spinel from Vietnam.** High-quality pink-to-red spinel was once again available from Luc Yen, in northern Vietnam (figure 8). According to Kent Pham, of International Marketing Consortium (IMC) in Placentia, California, the spinel is recovered as a by-product of ruby mining, so the production is unpredictable. However, some of the crystals are quite large. Mr. Pham displayed over 100 carats of fashioned spinel that were reportedly

Figure 8. These red and pink spinels were recovered recently in the course of ruby mining in the Luc Yen region of northern Vietnam. The crystal at the top weighs 12.81 ct, and the faceted stones weigh 4.46 ct (left) and 3.58 ct (right). Courtesy of IMC; photo by Maha DeMaggio.



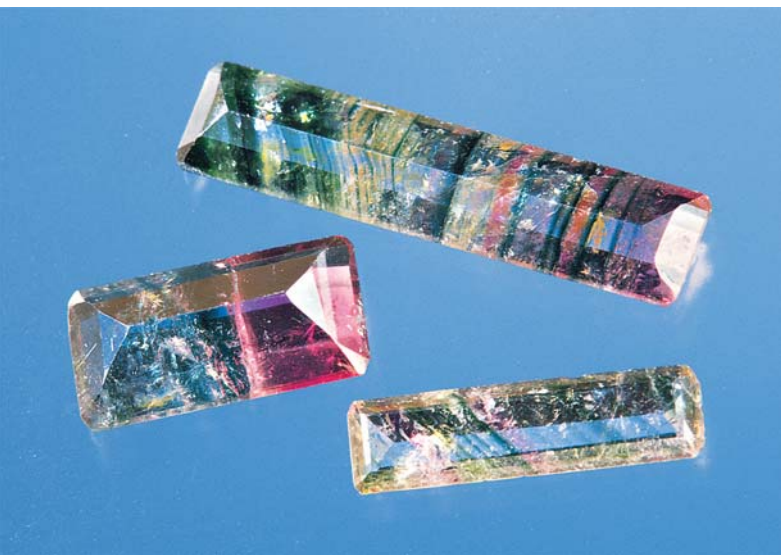

Figure 9. These three faceted liddicoatite tourmalines have been cut to emphasize their color zoning. The stone farthest to the left measures 12.68 x 6.61 x 3.71 mm and weighs 2.84 ct. Courtesy of Allerton Cushman & Co.; photo by Maha DeMaggio.

cut from a single 10 kg piece of rough from this locality. The largest stone faceted thus far weighed 27.25 ct; however, this rough is still being cut. Although we could not obtain gemological data on the stones shown in figure 8, spinel from this locality was described in the Fall 1993 Gem News section (pp. 213–214). The availability of this “by-product” spinel is also significant in that it shows that mining is continuing in the Luc Yen area.

**Parti-colored faceted liddicoatite tourmaline.** Liddicoatite from Madagascar is not new, but in general it has limited use as a gem material, because most crystals show pronounced color zones that would combine to “muddy” the color of a finished gem. (Because of this zoning, however, slices cut perpendicular to the c-axis are often dramatic, and therefore are sometimes used in jewelry.) Among the many gems from Madagascar that he was displaying, Tom Cushman also had liddicoatite that had been step-cut to emphasize the color zoning (figure 9), with an effect reminiscent of that seen in some fashioned parti-colored fluorite (see, e.g., Summer 1995 Gem News, p. 131). Mr. Cushman had about 50 examples of this material at Tucson, including several matched pairs.

**Another tourmaline source in Namibia.** Marc Sarosi of Marc Sarosi Co., Los Angeles, had several slightly bluish green faceted tourmalines that reportedly came from a single pocket found on a farm near Windhoek, Namibia (see, e.g., figure 10), which he showed at the booth of Andrew Sarosi. The locality was supposedly discovered by a farmer who was burying his dead dog. These tourmalines were very uniform in color (as was all the rough Mr. Sarosi saw) and quite transparent; the color was less

blue than most of the Neu Schwaben tourmaline described last year (Spring 1997 Gem News, pp. 66–67). About 3 kg of the rough material was recovered in April 1997, of which Mr. Sarosi managed to purchase about 1 kg; none has been discovered at this site since then.

## SYNTHETICS AND SIMULANTS

**Synthetic amethyst grown over round seeds.** For more than a decade, the gem market has been inundated with synthetic amethyst. Again this year, a great deal of this material was available at the Tucson shows. Recently, however, we were informed of a new type of synthetic amethyst, seen in Beijing, China, that was grown on dome-shaped seed crystals. (As a consequence of this shape of seed crystal, the seed would not show an obvious flat plane when the crystals were examined from the side.) Ms. Shen Meidong, of the National Gemstone Testing Center (NGTC) in Beijing, reported on the examination of purple crystals that were recently sent to the Identification Department of the NGTC. All were deep purple and showed “natural” quartz crystal faces (figure 11), including those in the forms  $r$  {10 $\bar{1}$ 1},  $m$  {10 $\bar{1}$ 0}, and  $z$  {01 $\bar{1}$ 1}. The crystals measured about 12 x 10 x 8–9 mm. Their gemological properties (as determined at the NGTC) were consistent with amethyst, both natural and synthetic.

Although all four samples looked like natural amethyst crystals, each had a dome-shaped colorless central region. These central regions contained two-phase (liquid and gas) inclusions typical of natural quartz. However, the purple overgrowths contained numerous “nailheads”: nail-like inclusions that extended from

Figure 10. This 30.57 ct green tourmaline is from a pocket found on a farm near Windhoek, Namibia. Courtesy of Marc Sarosi; photo by Maha DeMaggio.





small plates on the surfaces of the dome-shaped seeds (see inset figure 11); in addition, many white and brown “breadcrumb” inclusions were seen scattered on the surface of each dome. FTIR spectroscopy confirmed that the amethyst layers were synthetic (by, e.g., the presence of a  $3545\text{ cm}^{-1}$  peak in the infrared spectrum; T. H. Lind and K. Schmetzer, “Infrarot Spektroskopie geschliffener Edelstein, dargestellt am Beispiel von echten und synthetischen Amethysten,” *Zeitschrift der Deutschen Gemmologischen Gesellschaft*, Vol. 31, No. 3, 1982, pp. 143–150). Since the crystal forms looked natural, this material could easily confuse all but the most careful observers.

**“Glass stones”: Imitation agates.** One serendipitous result of the multiplicity of shows that overlap in Tucson in February is the opportunity to visit with our colleagues of the art-glass-making community, who are usually found at the bead shows there. In last year’s Tucson report, we wrote of glass cabochons that resembled opal (see Spring 1997 Gem News, p. 69). This year, we saw glass cabochons that resembled agate. Marilyn Jobe of Ellenton, Florida, makes what she calls “glass stones”: glass cabochons and beads that resemble agate, brecciated jasper, and tortoise shell. Two examples, measuring  $37.65 \times 22.35 \times 6.44\text{ mm}$  and  $31.06 \times 19.78 \times 6.59\text{ mm}$ , are shown in figure 12. Ms. Jobe made these cabochons by fusing old glass that she acquired from an estate sale; the multi-layered appearance makes these agate imitations particularly realistic.

**Synthetic moissanite from Russia.** In Tucson, Ted Themelis of Gemlab (USA) Co., Athens, Greece, showed us a sample of synthetic moissanite from a source other than C3, Inc., the manufacturers of the material studied by Dr. Kurt Nassau and GIA investigators (see K. Nassau et al., “Synthetic Moissanite: A New Diamond

Figure 12. These 36.95 and 48.82 ct cabochons are not agate, but rather are imitations made from fused glass. Photo by Maha DeMaggio.

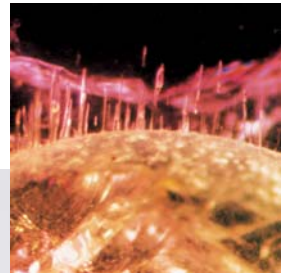

Figure 11. The shape of this approximately 1 cm wide synthetic amethyst crystal, one of several examined recently in China, resembles that of a natural crystal. Because these crystals are grown on dome-shaped seeds, there was no obvious seed plane. Inset: These “nail-head” inclusions extend from the curved seed into the synthetic amethyst. Macro photo by Zhang Tao, NGTC; photomicrograph by Shen Meidong, magnified 25x.

Substitute,” *Gems & Gemology*, Winter 1997, pp. 260–275). The faceted oval (figure 13) we saw in Tucson appeared brown and nearly opaque; with a microscope, we observed a yellow body color and abundant linear opaque black inclusions. Like the C3 material, however, it was still doubly refractive. According to Mr. Themelis, this sample was made in Russia using a vapor deposition technique. Although the sample is not particularly attractive, it indicates that other producers are getting involved in the creation of synthetic moissanite.

## INSTRUMENTATION AND TECHNIQUES

**Buff-top faceted stones cut from quartz spheres.** Gem cutter Arthur Grant of Coast-to-Coast Rare Stones, Martville, New York, is best known for his ability to facet unusual gem materials (such as neodymium pentaphosphate: see, e.g., “Reversible Twinning in an Unusual Synthetic Material,” Winter 1997 Gem News, pp. 307–308). However, he informed the Gem News editors that his favorite material to facet is quartz, and he showed us some unusual cuts that he had designed, starting with fashioned quartz spheres. Figure 14 shows two examples of these “buff-top” stones. The 4.41 ct stone on



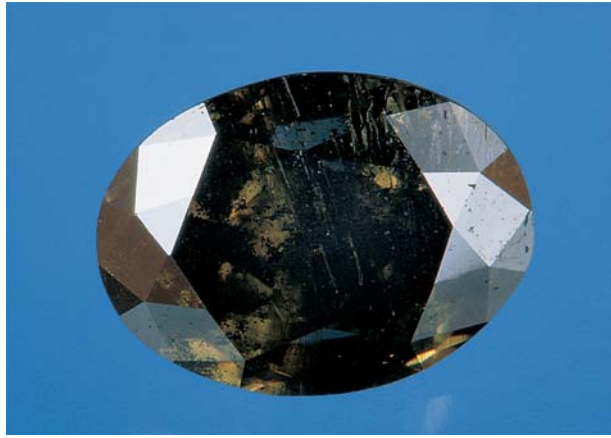

Figure 13. This heavily included faceted synthetic moissanite (approximately 8 mm long) was reportedly made in Russia using a vapor deposition process. Courtesy of Ted Themelis; photo by Maha DeMaggio.

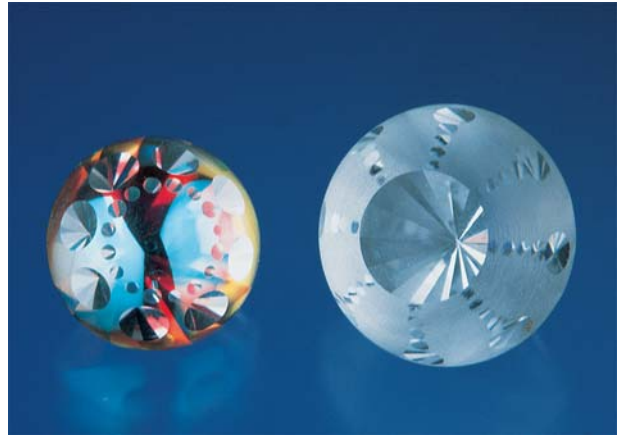

Figure 14. These buff-top fashioned stones (4.41 ct and 7.89 ct, respectively) were cut by Art Grant and his students from quartz spheres. Photo by Maha DeMaggio.

the left—called “Celestial quartz” by Mr. Grant—was fashioned from a sphere that had been coated with a dichroic optical material that transmitted red light and was light greenish blue in reflected light (for more on gems with dichroic coatings, see “‘Tavalite,’ Cubic Zirconia Colored by an Optical Coating,” Summer 1996 Gem News, pp. 139–140). None of the optical coating remained on the faceted pavilion of the sample, and Mr. Grant polished windows through the coating on the crown. The 7.89 ct piece on the right began as a conven-

tional polished sphere; to achieve the effect shown here, Mr. Grant “frosted” the crown surface with sandpaper mounted on a handheld Dremel tool before polishing the windows in the crown.

Mr. Grant is using simple pieces such as these to teach faceting to local high school students; in fact, the pavilions of these pieces were fashioned by his student faceters. To provide the raw material for this work, he purchased the entire stock of dichroic-coated spheres (about 2,000 pieces) from Jewel Tunnel Imports of Baldwin Park, California.

## A PRELIMINARY REPORT FROM THE FIRST WORLD EMERALD CONGRESS

The first World Emerald Congress was held in Bogotá, Colombia, February 23–25, 1998, with about 750 participants. The Congress featured over 30 invited talks from industry figures worldwide, as well as panel discussions, exhibits, an emerald auction, and a field trip to the mines at Muzo and Cosquez. The presentations covered every aspect of the emerald sector, including the geology of mining areas in Africa, Brazil, and Colombia, the manufacture and identification of synthetic emeralds, and future challenges facing the emerald industry. However, one of the most important sessions (figure 15) concerned emerald treatments, especially clarity enhancements. The highlights of this session are given below.

Dr. Henry Hänni of the SSEF Swiss Gemmological Institute was the opening speaker. He described a 90% success rate—using a combination of Raman and FTIR spectroscopic techniques—in identifying the substances used to fill fractures in clarity-enhanced emeralds (see, e.g., H. A. Hänni et al., “A Raman Microscope in the Gemmological Laboratory: First Experiences of Application,” *Journal of Gemmology*, Vol. 25, No. 6, 1996, pp. 394–406). Dr. Mary Johnson of the GIA Gem

Trade Laboratory warned that there are at least 10,000 substances that could be used as emerald fillers, so discriminating among them is not a simple task. She also provided standard definitions for many of the terms used in describing filling materials; “resin,” for instance, can be used to describe material that is natural or synthetic, and solid or liquid. Dr. Johnson also discussed the current GIA emerald treatment project, in which hundreds of stones—representing all major localities—will be examined both before and after filling with a variety of substances, with the stones then subjected to various durability tests. (This study is scheduled to be completed and published within the next year.) Emerald dealer Ray Zajicek (Equatorial Imports, Dallas, Texas) offered an important viewpoint from the trade: the desire for a permanent—or at least stable—treatment, which is not itself colored, does not completely mask existing fissures, and can be easily removed. A panel discussion followed, in which Jaime Rotlewicz (Gemtec, Bogotá), Daniel Sauer (Amsterdam Sauer, Rio de Janeiro, Brazil), Ron Ringsrud (Constellation Colombian Emeralds, Bogotá), Kenneth Scarratt (director of the new AGTA laboratory

in New York City), Dr. Dietmar Schwarz and Robert E. Kane (Gübelin Gemmological Laboratory, Lucerne, Switzerland), and GIA GTL manager of identification Shane McClure also took questions from the audience.

The Congress participants appeared to agree on two major courses of action needed with regard to the clarity enhancement of emeralds: (1) gemological laboratories should provide information about the degree to which an emerald has been treated (e.g., slight, moderate, or major levels of clarity enhancement); and (2) treaters, dealers, and even the final consumer should be informed what the optimal filling material (or materials) would be. Until results are made available from the current GIA study on the durability of various emerald treatments, attending delegates from Colombian facilities professed their willingness to use only cedarwood oil in the clarity enhancement of emeralds, unless their customers request another treatment. However, Mr. Rotlewicz pointed out that cedarwood oil is not itself a perfect filling material; the viscosity of available Merck cedarwood oil changed about 10 years ago, which led treaters to experiment with “palma” (araldite resin) and other substances.



Figure 15. Among the speakers at the First World Emerald Conference were (left to right): Dr. Rodrigo Giraldo (moderator), Dr. Henry Hänni, Dr. Dietmar Schwarz, Ray Zajicek, and Jaime Rotlewicz. Dr. Mary Johnson is on the screen in the background. Photo by Charles Carmona.

## MORE FROM THE 26TH INTERNATIONAL GEMMOLOGICAL CONFERENCE

### COLORED STONES AND ORGANIC MATERIALS

**An unusual organic “gem”: Bezoar.** Jean-Paul Poirot from Paris, France, presented photos of an amazing collection of “bezoars”—concretions, usually spherical, that are found chiefly in the digestive tract of grazing animals. Bezoars are composed of a mixture of materials, both inorganic (e.g., whitlockite, a calcium-iron-magnesium phosphate) and organic (hair). In some cultures, they were once believed to have magical properties. For example, Renaissance Europeans believed that bezoars could prevent arsenic poisoning. Placed in a beverage such as wine, the bezoar supposedly would absorb any heavy metal—such as arsenic—that might be present. Bezoars were also used as amulets and set into objects of art, especially during the 17th century. Today bezoars are rarely, if ever, found in jewelry outside of museums.

### Gem-quality transparent feldspar from North America.

The well-known source for transparent and aventurescent labradorite in Plush, Oregon, is only one of a number of localities in North America for this gem material. Dr. Frederick H. Pough, a consulting mineralogist from Reno, Nevada, discussed several of these localities. A second occurrence in Oregon, near the town of Burns (the Ponderosa mine), is also producing quantities of transparent, gem-quality labradorite. Like the material from Plush, some of the rough gems contain small oriented

platelets of elemental copper that cause aventurescence when the stone is properly oriented during cutting. [Editor’s note: This material is commonly referred to as “sunstone” (see, e.g., C.L. Johnston et al., “Sunstone Labradorite from the Ponderosa Mine, Oregon,” *Gems & Gemology*, Winter 1991, pp. 220–233), although this term was originally reserved for aventurescent oligoclase feldspar with hematite—not copper—inclusions.]

Near-colorless plagioclase phenocrysts occur in scattered lava flows at Sunstone Hill, in Deseret, Utah. A similar feldspar-bearing lava flow has also been reported in Milford, Utah. Northern Mexico is home to a lava flow with even larger gem-quality feldspar crystals, some more than 2.5 cm long. Moonstone-like feldspar crystal clusters have also been found in a lava flow in this area of northern Mexico, as has dark brown, sometimes asteriated, spinel. Coincidentally, Gem News editor John Koivula recently identified (using Raman analysis) rounded blebs of black spinel as inclusions in some labradorite from Oregon that Dr. Pough provided.

Although most of the feldspar from these various localities is colorless to pale brownish yellow, some intensely colored gems are also recovered. The latter crystals are often color zoned, with an outer layer that is almost colorless and a red core. Between these two zones a narrow green rim is sometimes present (see, e.g., Summer 1997 Gem News, p. 145). Green is the rarest color of these feldspars, followed by red.



Figure 16. Maw-sit-sit is rock composed of several minerals, and is named for its locality of origin in northern Myanmar. The fashioned pieces range from 8.38 to 11.98 ct. Stones courtesy of Allen Jenny and Pala International; photo by Harold © Erica Van Pelt.

**Libyan Desert glass.** Dr. John Saul, an exploration geologist-gemologist from Paris, France, presented new information about “Libyan Desert glass.” This unusual, very-high-silica natural glass found at the Great Sand Sea in southwestern Egypt is sometimes faceted as a gem material. It is composed of 98%  $\text{SiO}_2$ , with minor amounts of iron, aluminum, and titanium oxides. Samples are transparent to translucent (milky); and near-colorless to very light yellow, green, or brown. The R.I. ranges from 1.464 to 1.545, and the S.G. is 2.120–2.215. Common internal characteristics are gas bubbles and distinctive dark streaks, as well as “pseudo-bedding” (layers that resemble bedding features). Among the mineral inclusions identified thus far are quartz, cristobalite, elbaite tourmaline, titanomagnetite, zircon, and baddeleyite.

It is generally accepted that Libyan Desert glass formed 28.5 million years ago during a meteorite (or comet) impact into a quartz-rich formation, probably

loose sand. However, there is no observable crater; moreover, unlike impact-derived glasses (tektites) from other known craters, the material never exhibits aerodynamic shapes. As a result, alternative hypotheses have been suggested, such as formation due to hydrothermal activity or ancient forest fires.

Although volatiles are nearly absent from Libyan Desert glass, tiny amounts of organic compounds in the form of fragile, crudely preserved sporomorphs or microfossils (less than 0.5 mm in size) have been tentatively identified. If these features are confirmed to be fossils, as Dr. Saul believes, any theory for the mode of formation of this material must accommodate both the high temperature needed to form the glass and the presence of fragile carbon-rich “microfossils.” Dr. Saul supports the hypothesis that a meteorite or comet impact heated the quartz-rich sand or sandstone parent rock, but he also suggests that this event occurred extremely rapidly and at a very high temperature—melting the silica and volatilizing other elements while driving away any gases present, particularly oxygen. In the absence of oxygen, some of the carbon-rich “microfossils” would not have ignited, but rather they could have been encapsulated by the molten silica.

**Maw-sit-sit from Myanmar.** Gem News contributing editor Dr. Henry Hänni, of the SSEF Swiss Gemmological Institute in Basel, presented the results of unpublished research on maw-sit-sit that he carried out with J. Meyer in 1984. With the recent reappearance of this unusual gem material, this information is still pertinent. Visual examinations of the maw-sit-sit currently being mined indicate little difference from that previously studied.

Because maw-sit-sit is a rock composed of several different minerals that can vary greatly in their relative amounts, it may show considerable variation in both visual appearance and specific gravity. The color of maw-sit-sit ranges from light green to black; it can be monochromatic, mottled, or spotted, with black or white spots or veinlets (see, e.g., figure 16).

Maw-sit-sit is named for its locality of origin in northern Myanmar, but it has also been referred to as jade-albite or chloromelanite. Jadeite and albite are two possible constituents of maw-sit-sit, but both are subordinate, so they should not be used to name the stone. Chloromelanite is an older varietal name for iron-rich jadeite (A. M. Clark, *Hey's Mineral Index*, 1993, London, Chapman & Hall, p. 132), which is not found in maw-sit-sit, so this too is a misnomer.

There are several main constituents of maw-sit-sit. *Chromite* occurs as small black grains with a metallic luster that are usually seen as cores in black kosmochlor aggregates. *Kosmochlor*, long recognized only from meteorites, occurs as fine felty masses, the characteristic black spots in some maw-sit-sit. Formerly known as ureyite, kosmochlor ( $\text{NaCrSi}_2\text{O}_6$ ) is the chromium analogue of jadeite ( $\text{NaAlSi}_2\text{O}_6$ ). Cr-colored green *jadeite* is present as



blocky mosaics of large single crystals. (Jadeite and kosmochlor form a solid-solution series through the substitution of chromium for aluminum.) The *eckermannite* and *arfvedsonite* species of amphibole form coarse crystals that are green or gray, depending on their Cr content. *Symplectite*, a very fine-grained mixture of minerals that cannot be resolved microscopically, may also be present. In maw-sit-sit, the symplectite is also green due to the Cr content of its components.

The matrix consists of chlorite, albite, serpentine, and zeolites, which also fill interstitial spaces between the minerals named above. Fine veinlets also consist primarily of these minerals.

The maw-sit-sit deposit is located near the classic jadeite location at Tawmaw. It formed along the rim of a large peridotite body that was altered and serpentinized. The deposit is apparently the result of a metasomatic reaction between albitite dikes and the adjacent serpentinite during high-pressure metamorphism.

(Dr. Hänni and Mr. Meyer wish to express their thanks to the late Günther Weinz of Kirschwiles, Germany, who supplied them with sample material in 1982.)

**An opal nomenclature.** Dr. Grahame Brown, of the Gemmological Association of Australia (GAA), presented a paper introducing a system for opal nomenclature that resulted from three years of discussion among representatives of GAA, the Australian Gem Industry Association, and the Lightning Ridge Miners Association. The information from these discussions was compiled by Anthony Smallwood, chairman of GAA's Opal Nomenclature subcommittee, and was ratified by these organizations and by the Australian Gemstone Industry Council and the Jewellers Association of Australia.

Under this system, natural opal is initially classified into one of three groups: precious opal (that which shows play-of-color), common opal, and potch. The latter two do not show play-of-color and are separated from one another based on their formation and structure. Precious opal is further divided into three types: Solid single pieces of opal with substantially homogeneous chemical composition are classified as Type 1; Type 2 is boulder opal, solid opal that is naturally attached or layered with the rock in which it was formed, and this rock is of a different chemical composition; and Type 3 is matrix opal, in which opal fills pores between grains in the host rock (e.g., opal-cemented sandstone).

In this nomenclature system, different varieties of precious opal are specified on the basis of their body tone (relative lightness or darkness of the stone) and transparency. These varieties are designated as black, dark, or light, with the lightest tone being white opal; any opal that is transparent to semi-transparent is called crystal opal.

Specific criteria for defining opal treatments, opal composites, synthetic opal, and imitation opals have also

been established, so that reproducible classification reports can be prepared for any opal, regardless of its country of origin. (For more information on this system, see A. Smallwood, "A New Era for Opal Nomenclature," *Australian Gemmologist*, Vol. 19, No. 12, 1997, pp. 486-496.)

**Identifying natural opal in the field.** The techniques of gem identification routinely used in well-equipped gemological laboratories are not always practical when buying gems in the field or at the mine. The distinction between natural opal and its synthetic and imitation counterparts under these conditions was the subject of a paper presented by Geoffrey Tombs of Beacon Hill, New South Wales, Australia. Mr. Tombs also prepared a useful chart for the field identification of natural opal and its imitations by means of basic gemological instruments and techniques. He emphasized the use of magnification and proper illumination to show differences in play-of-color patterns and internal structure. Fluorescence (and phosphorescence) to both long- and short-wave UV radiation were also discussed as means of identification. This information is particularly useful to gemologists and gem traders when advanced instrumentation, such as infrared spectrophotometry, is unavailable.

**Kashmir rubies.** The Kashmir region has been world famous for extraordinarily fine blue sapphires since they were first discovered there in 1881. Robert E. Kane, of the Gübelin Gemmological Laboratory in Lucerne, Switzerland, reported on the first ruby deposit found in this region, almost a century later (in 1979), about 350 km by air northwest of the historic blue sapphire deposits. The ruby deposit (figure 17) is located in extremely remote and rugged mountainous terrain on Nangimali Mountain, high in the Himalayas, in the Azad Kashmir region of Pakistan. The mine consists of two main workings (at 14,300 feet [4360 m] and 12,500 feet [3810 m]) that can only be mined from May to October because of the severe climate.

The ruby crystals are found in light bluish gray bands of pure calcite, which follow the bedding pattern of the marble (figure 18). The ruby-bearing bands vary in thickness from less than 1 cm to 30 cm, and the distance between the bands varies from a few centimeters to several meters. Closely spaced bands, with a thickness greater than 1 m, have been designated as ruby ore zones. At the Nangimali Top area, these zones range from 3 to 6 m thick. Schists of various types flank the ruby-bearing marbles; garnet-bearing schists predominate. Although calcite predominates in the ruby-bearing marbles, 16 additional minor minerals have been identified thus far.

Mining started in 1990 on a limited (pilot) scale. During the author's 1995 visit, mining was carried out by both open pit (at the upper workings) and underground (at the lower area) methods. As of 1995, about 250 kg of gem material had been produced from ore averaging 55



Figure 17. The lower of the two Kashmir ruby deposits has been developed by underground workings with conventional tunneling, using drilling and blasting. Photo by Robert E. Kane.

carats per cubic meter. The gems consisted of cabochon-to facet-grade ruby (some comparable in quality to stones from Mogok) and pink sapphire. The largest facet-grade stone recovered weighed 85 ct. With increasing depth of mining, the percentage of deep red gems increased, as did the transparency and size of the stones. Inclusions reported to date in the gem-quality material include pyrite, calcite, rutile, chromium-bearing mica, pyrrhotite, and hematite.

The total estimated “resources” (not to be confused with measured “reserves”) of ruby and pink sapphire are about 125 million carats. However, the remoteness and ruggedness of the location, as well as its short working

Figure 18. Well-formed ruby crystals are sometimes present in the mineralized calcite at Kashmir’s ruby deposits. When such spectacular ruby crystals are encountered, the miners preserve them as mineral specimens. This sample is approximately 10 cm across. Photo by Robert E. Kane.



season, present major challenges for the economic development of these deposits.

**Gemstones of Switzerland.** Although well-known for a variety of interesting “Alpine-type” minerals (such as fluorite, quartz, and epidote), Switzerland and the Swiss Alps are generally not known for their gem materials. It was therefore surprising when Dr. Edward J. Gübelin, of Lucerne, Switzerland, described a number of different gems that have been found in that country. Among the better-known gems described were aquamarine and green beryl, ruby and sapphire, moonstone, garnets (almandine, andradite, grossular, pyrope, and spessartine), amethyst, topaz, and tourmaline. The collectors’ gems he mentioned included anhydrite (figure 19), apatite, axinite, cordierite, diopside, dolomite, epidote, fluorite (figure 20), idocrase, kyanite, scapolite, and sphene.

Dr. Gübelin had examples of each of these Swiss gems available for examination. Many were quite large, with several exceeding 5 ct. Dr. Gübelin also provided a short introduction to the geology of the Swiss Alps, which he related to the various gem deposits.

## SYNTHETICS AND SIMULANTS

**First commercial synthetic ametrine from Russia.** Dr. Vladimir Balitsky, head of the Laboratory of Mineral Synthesis at the Institute of Experimental Mineralogy of the Russian Academy of Sciences at Chernogolovka (Moscow District), described the technology developed in Russia for growing single crystals of bicolored amethyst-citrine quartz, which resemble the natural gem “ametrine” found in Bolivia. This technology is based on the results of previous studies of the origin of amethyst and citrine coloration, as well as on discoveries concerning the effects of different physical-chemical and growth factors on the formation, stability, and character of color distribution in these crystals.

The first batch of crystals (on the order of 100 kg) was produced in 1994. As is the case with crystals of synthetic amethyst or citrine, ametrine is grown in autoclaves from strongly alkaline potassium carbonate solutions in the presence of ferric ions and an oxidizer, at temperatures of 350°–390°C and pressures up to 1.5 kbar. In one autoclave with a volume of 1,000 liters, 250–300 kg of ametrine crystals can be grown over a period of two to three months. [Editor’s note: According to Dr. Balitsky, the crystals are near-colorless and yellow as grown; with subsequent irradiation and heat treatment, the near-colorless portion turns purple and the yellow portion darkens. Both colors are due to iron.] Individual single crystals range from several grams (the most valuable faceting material) up to 1 kg.

As is the case for natural ametrine, the synthetic crystals are characterized by sector zoning, which results from a selective distribution of amethyst and citrine coloration in different growth zones (figure 21). Crystals





Figure 19. This faceted anhydrite is shown resting on a crystal of gem anhydrite from the Simplon Tunnel that is coated with ankerite. Swiss anhydrite is notable for its light purple color, as well as its size (crystals up to 7 cm long). Photo courtesy of Dr. Edward J. Gübelin.

grown on seeds parallel to the pinacoid {0001} are characterized by the simplest distribution of colors. The identification of gems cut from such crystals has previously been based on their characteristic internal structure and the distribution of color in growth sectors. However, in several recently produced crystals, these characteristics resemble natural ametrine more closely. Identification of synthetic ametrine requires evaluation of all distinguishing features of both synthetic amethyst and synthetic citrine, and it is not always easily accomplished. (For one method of distinguishing synthetic from natural amethyst and citrine, see T. H. Lind and K. Schmetzer, "Infrarot Spektroskopie geschliffener Edelstein, dargestellt am Beispiel von echten und synthetischen Amethysten," *Zeitschrift der Deutschen Gemmologischen Gesellschaft*, Vol. 31, No. 3, 1982, pp. 143–150.)

## INSTRUMENTATION

**Cathodoluminescence and photoexcitation applications in gemology.** Continuing his research on cathodoluminescence (CL), Dr. Johann Ponahlo of the Department of Mineralogy and Petrography at the Museum of Natural History in Vienna, Austria, described his latest observations. Dr. Ponahlo emphasized that cathodoluminescence is a nondestructive technique that can be useful in the separation of natural and synthetic gem materials.

Many CL instruments are designed to be mounted on a microscope stage. In addition to the visual images provided by this method, information on the luminescence of gemstones can be obtained by collecting CL spectra in the ultraviolet, visible, and near-infrared spectral ranges (figure 22) by means of computer-assisted CL spectrophotometers. Such instruments require only about 30 seconds to complete a spectral analysis in the visible plus near-infrared range; this time is reduced to just two thousandths of a second with newly developed diode array spectrometers. Rough or cut stones from 2 to ~40 mm can be accommodated in these instruments.

Another technique currently being explored by Dr.



Figure 20. Switzerland is also the source of attractive pink fluorite, as shown by these faceted stones (10–80 ct). Photo courtesy of Dr. Edward J. Gübelin.

Ponahlo is known as photoexcitation spectrometry (PECS). This method differs from CL analysis in that PECS does not use an electron beam to excite luminescence. Instead, the sample is excited by a beam of light

Figure 21. Synthetic ametrine grown in Russia is now commercially available. The smaller crystal measures 51 x 21 x 5 mm. Photo by Maha DeMaggio





(photons), and the energy emitted at each wavelength of excitation is measured as the wavelength of excitation is scanned. A photoexcitation spectrum is potentially more sensitive than CL for measuring the luminescence produced by a given activator ion. Preliminary results indicate that this photoexcitation method could be useful for detecting minor differences between natural gemstones and synthetics, as well as for determining locality of origin in some cases.

## ANNOUNCEMENTS

**New geologic maps of Sri Lanka.** The Geological Survey and Mines Bureau of Sri Lanka has published seven maps in a new series titled *Geological Maps of Sri Lanka 1:100,000*. These detailed maps (figure 23) provide coverage of the central and southern parts of the country, and include most of its known gem-producing areas. In addition to a full-color geologic map, each sheet contains a description of the regional geology of Sri Lanka, along with the geology and mineral deposits (where applicable) of the mapped area. The maps are a considerable resource for anyone wishing to undertake geologic studies or prospecting in this gem-rich country. They are available for a nominal charge from the Geological Survey and Mines Bureau, No. 4 Senanayake Building, Galle Road, Dehiwala, Sri Lanka; fax 94-1-735752.

**Nature of Diamonds exhibit extended.** The American Museum of Natural History is extending the Nature of Diamonds exhibition, from the original closing date of

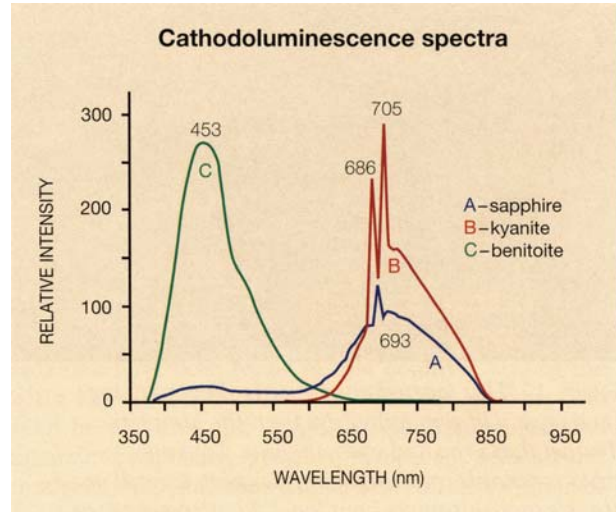

Figure 22. CL spectrophotometry is a fast, non-destructive technique, which was used here to separate beads of a similar saturated blue in a group of necklaces. The CL spectra showed that some of the necklaces contained only kyanite beads and some contained a mixture of kyanite and sapphire beads. The spectrum for benitoite is also shown for comparison as a gem material with a similar blue color.

April 26, to August 30, 1998. For more information on the exhibit, contact the Museum at Central Park West at 79th Street, New York, 10024-5192, phone 212-769-5099.



Figure 23. This geologic map, one of a series recently issued by the Geological Survey and Mines Bureau of Sri Lanka, covers an area of southern Sri Lanka where numerous gemstones are mined.

**International Mineralogical Association meeting.** The 17th General Meeting of the IMA will be held in Toronto, Canada, August 9–14, 1998. The meeting is being organized by the Mineralogical Association of Canada, the University of Toronto, and the Royal Ontario Museum. A symposium on “Gems and Diamonds” will be featured, in addition to the other scientific programs on mineralogy, petrology, geochemistry, and ore mineralogy. For more information, visit the web site at [http://opal.geology.utoronto.ca/IMA98/second\\_circular/Second\\_Circular.html](http://opal.geology.utoronto.ca/IMA98/second_circular/Second_Circular.html), or write IMA’98, Department of Geology, University of Toronto, Earth Sciences Center, 22 Russell Street, Toronto, Ontario, Canada, M5S 3B1.

#### IN MEMORIAM

**Charles E. Ashbaugh III, 1944–1997.** The editors were greatly saddened to learn that *Gems & Gemology* author Charles (“Chuck”) Ashbaugh passed away last July. A graduate of the University of California, Los Angeles, Chuck was hired by the GIA Gem Trade Laboratory in Santa Monica as an expert on radiation testing of gem materials. He set up the GTL radiation testing facility, which has been used to detect, characterize, and quantify induced radioactivity in several gem materials, most notably diamond and topaz. He eventually rose to the position of Manager of Radiation Testing at GTL, before moving on to become Manager of Health Physics at Isotope Products Laboratories in Burbank, California. Even after he left GIA, Chuck continued to offer advice on particularly challenging identification problems. He was a longtime member of the review board for *Gems & Gemology’s* Gemological Abstracts section and wrote three papers for *G&G*: “Gemstone Irradiation and

Radioactivity” (Winter 1988), which won the Most Valuable Article Award for that year; “Gamma-Ray Spectroscopy to Measure Radioactivity in Gemstones” (Summer 1992); and, with Dr. James E. Shigley, “Reactor-Irradiated Green Topaz” (Summer 1993).

Chuck is survived by his wife, Connie, and son, Charles E. Ashbaugh IV.

**Eugene Edward Foord, 1946–1998.** Eugene (“Gene”) Foord passed away on January 8, 1998, after a three-year battle with lymphoma. Gene was a longtime supporter of *Gems & Gemology*, co-authoring two articles (“Gem-Quality Red Beryl from the Wah Wah Mountains, Utah” in Winter 1984, and “Emeralds of the Panjshir Valley, Afghanistan” in Spring 1991) and reviewing many other papers.

Gene obtained degrees from Franklin and Marshall College (B.A. geology, 1968), Rensselaer Polytechnic Institute (M.S. geology/petrology, 1969), and Stanford University (Ph.D. mineralogy, 1976). Gene’s doctoral thesis was a detailed study of the gem-tourmaline-bearing Himalaya dike system in San Diego County, California. Through his studies of this and other pegmatites in Southern California and Colorado, Gene gained recognition as an expert on gem-bearing pegmatites. During his career as a geologist-mineralogist at the U.S. Geological Survey from 1976 until his death, Gene also made numerous other contributions, amounting to nearly 200 books, papers, abstracts, and maps. Gene’s collaborations with mineralogists from around the world took him to Russia, China, and Pakistan. His studies of gem materials included emerald, red beryl, topaz, tourmaline, and turquoise.

Gene is survived by his wife, Suzann, and their children, Laura and Robert.

## 1997 Manuscript Reviewers

*Gems & Gemology* requires that all articles go through the peer-review process, where the manuscript is reviewed by at least three experts in the field. This process is vital to the accuracy and readability of the manuscript, but it is also time-consuming for the reviewer. Because members of our Editorial Review Board cannot have expertise in every area, for some manuscripts we call on others in our community to share their intellect and expertise. In addition to the members of our Review Board, we extend a heartfelt thanks to the following individuals who provided us with their comments and reviews of manuscripts in 1997:

Dr. Peter Cooke  
 Dr. Eugene Foord  
 Dr. Jeff Harris  
 Mr. Hertz Hasenfeld  
 Dr. Don Hoover  
 Mr. Glen Lehrner

Mr. Nir Livnat  
 Mr. Shane McClure  
 Mr. Nicolai Medvedev  
 Mr. Dilip Mehta  
 Ms. Elise Misorowski  
 Mr. Russell Shor

Mr. Michael Steinmetz  
 Dr. Chris Welbourn  
 Mr. Richard Williams  
 Dr. William Wise  
 Mr. Lewis Wolfe

# Gems & Gemology

The information contained in the 1997 volume year of *Gems & Gemology* is as broad and diverse as the study of gems. Feature articles highlighted such topics as geophysics in gemstone exploration, modern diamond cutting and polishing, Sandawana emeralds, California benitoite,

# Challenge



synthetic moissanite, and blue fluorescence in diamond. Each article was packed with information that is as useful as it is interesting. To this end we invite you to test your understanding and knowledge of these important papers. This year marks the 12th annual *Gems & Gemology* Challenge, and we want you to be a part of it!

The following 25 questions are based on information from the four 1997 issues of *Gems & Gemology*. Refer to feature articles and "Notes and New Techniques" in these issues to find the single best answer for each question; then mark your choice on the response card provided in this issue (sorry, no photocopies or facsimiles will be accepted; contact the Subscriptions Department if you wish to purchase additional copies of the issue). Mail the card so that we receive it no later than Monday, August 17, 1998. Please include your name and address. All entries will be acknowledged with a letter and an answer key.

Score 75% or better, and you will receive a GIA Continuing Education Certificate. If you are a member of GIA Alumni and Associates you will earn 5 Carat Points toward GIA's new Alumni Circle of Achievement. (Be sure to include your GIA Alumni membership number on your answer card and submit your carat card for credit.) Earn a perfect score, and your name will also be featured in the Fall 1998 issue of *Gems & Gemology*. Good luck!

**Note:** Questions are taken from the four 1997 issues. Choose the single **best** answer for each question.

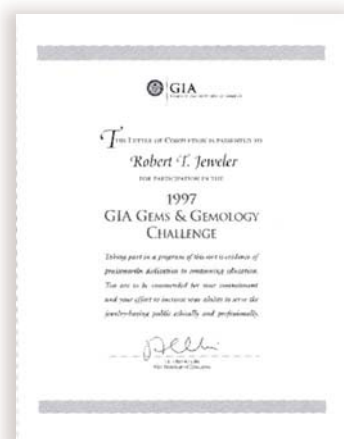



1. Common inclusions found in Bi-bearing tourmaline from Zambia are
  - A. growth tubes.
  - B. "breadcrumbs."
  - C. two-phase (liquid and gas).
  - D. "horsetails."
2. Ground-penetrating radar may be useful to locate gem-bearing pockets in pegmatites because it measures differences in a material's
  - A. magnetism.
  - B. refractive index.
  - C. electrical conductivity.
  - D. specific gravity.
3. Extraction of rhodochrosite specimens at the Sweet Home Mine has been improved by the use of a hydraulic chainsaw and
  - A. blasting.
  - B. dental picks.
  - C. diamond-impregnated drill bits.
  - D. hydraulic rock splitting.
4. Synthetic moissanite could be mistaken for diamond on the basis of
  - A. specific gravity.
  - B. refractive index.
  - C. dispersion.
  - D. thermal inertia.
5. The depth of the red color in ruby correlates to the concentration of
  - A. chromium.
  - B. chromium and iron.
  - C. iron.
  - D. iron and titanium.
6. Until recently, diamond simulants were readily distinguished from diamond on the basis of their
  - A. "Cape" lines.
  - B. absorption spectra.
  - C. UV luminescence.
  - D. thermal conductivity.
7. Besides ground-penetrating radar, the most promising geophysical method for gem exploration (due to its resolution) is
  - A. gravity surveying.
  - B. seismic-reflection profiling.
  - C. magnetism.
  - D. none of the above.
8. Sandawana emeralds are most similar in chemistry to emeralds from
  - A. Pakistan.
  - B. Colombia.
  - C. the Ural Mountains.
  - D. Madagascar.
9. One distinctive inclusion in Nepal rubies is
  - A. tremolite.
  - B. apatite
  - C. dolomite.
  - D. uvite tourmaline.
10. In diamond manufacturing, the decision whether or not to divide a diamond crystal is made by the
  - A. marker.
  - B. sorter.
  - C. bruter.
  - D. cutter.
11. When cleaning jewelry set with rhodochrosite, which of these cleaning methods may be used?
  - A. Ultrasonic
  - B. Steamer
  - C. Buffing wheel
  - D. Solvents
12. The formation of benitoite has been attributed to hydrothermal processes that caused the unusual combination of
  - A. barium and titanium.
  - B. silicon and titanium.
  - C. barium and silicon.
  - D. silicon and aluminum.
13. Which of the following is not characteristic of Chinese hydrothermal synthetic emeralds?
  - A. Nailhead spicules
  - B. Chrysoberyl inclusions
  - C. Platinum platelets
  - D. Beryl crystals
14. The main disadvantage of modern technological methods of diamond cutting is
  - A. the low yield.
  - B. the high cost of equipment.
  - C. the large number of operators required.
  - D. the length of time required to cut a diamond.
15. Besides the deposit in California, benitoite has been found in
  - A. Japan.
  - B. Korea.
  - C. Austria.
  - D. Mexico.
16. The presence of Ni in Tairus hydrothermal synthetic sapphires can be detected by the
  - A. characteristic color.
  - B. optical absorption spectrum.
  - C. distinctive crystalline inclusions.
  - D. red UV fluorescence
17. At the Sandawana mines, emeralds are recovered from
  - A. shear zones in sedimentary rocks.
  - B. hydrothermal veins near faults.
  - C. metamorphosed volcanic rock near pegmatites.
  - D. carbonate veins in black shale.
18. The presence of bismuth in Zambian tourmaline probably is responsible for which of the following?
  - A. Unusual color zoning
  - B. Luminescence to UV radiation
  - C. Presence of growth tubes
  - D. None of the above
19. During exposure to ultraviolet radiation, some diamonds emit visible light, which is termed
  - A. thermoluminescence.
  - B. fluorescence.
  - C. phosphorescence.
  - D. cathodoluminescence.
20. In standard laboratory color grading, a colorless to near-colorless diamond is viewed
  - A. table-up through the crown facets.
  - B. table-up through the pavilion facets.
  - C. table-down through the crown facets.
  - D. table-down through the pavilion facets.
21. The similarity of Tairus hydrothermal synthetic sapphires to natural sapphires can be attributed to their
  - A. chromophores.
  - B. crystal structure.
  - C. chemical composition.
  - D. hydrothermal growth.
22. Near-colorless synthetic diamonds may be differentiated from natural diamonds by their
  - A. inclusions, when present.
  - B. long-wave UV fluorescence.
  - C. pavilion flash colors.
  - D. thermal conductivity.
23. The most useful properties for separating synthetic moissanite from diamond are S.G. and
  - A. thermal inertia.
  - B. electrical conductivity.
  - C. double refraction.
  - D. pavilion flash.
24. Chinese hydrothermal synthetic emeralds can be distinguished from natural emeralds on the basis of their
  - A. lack of iron.
  - B. UV-visible absorption spectra.
  - C. infrared absorption spectra.
  - D. chromium content.
25. Blue fluorescence in diamonds
  - A. always reduces transparency.
  - B. is most noticeable in better-color stones.
  - C. is more common than yellow fluorescence.
  - D. is more common than lack of fluorescence.

# Book Reviews

SUSAN B. JOHNSON AND JANA E. MIYAHIRA, EDITORS

## CULTURED PEARLS: THE FIRST HUNDRED YEARS

By Andy Müller for Golay Buchel, 142 pp., illus., publ. by The Golay Buchel Group, Lausanne, Switzerland, 1997. US\$60.00\*

Mr. Müller states in the foreword that this book is targeted for a wide audience. His goal is to create a text that is readable and interesting to members of the gem trade, as well as to consumers who want to acquire general knowledge about cultured pearls.

The book is logically presented, with the first chapter dedicated to the history of the natural pearl before culturing began. Folklore and ancient beliefs about pearl formation are discussed, and a brief history of sources is also included.

Next, Mr. Müller describes the early efforts to create cultured pearls, beginning with the Akoya pearl in Japan. He then examines the effect of World War II on pearl production, focusing on how and why the cultured pearl eventually overtook the natural pearl in the jewelry industry. I found the history to be very interesting, especially the highs and lows of Japanese pearl culturing and the rise to prominence of other culturing locations such as Tahiti, Australia, the Philippines, and the Cook Islands.

The third chapter discusses the state of pearl culturing today, with sections on South Seas pearls, Akoya pearls, freshwater cultured pearls, mabé pearls, and keshi pearls. For each type, there is a brief discussion of culturing and value factors, as well as buying recommendations for the consumer.

The book concludes with the future potential of the cultured pearl industry, which is followed by a glossary of terms specifically for cultured pearls.

Individuals looking for very technical or scientific information on pearl culturing will be better served by other sources; in keeping with his goal of writing a text for the lay reader, Mr. Müller has kept technical information to a minimum. On the other hand, he has avoided the trap of "romancing the stone" too much. His book is not "flowery," but it does include enough legend and folklore to reflect his personal reverence for pearls. The book is lavishly illustrated throughout, with photographs showing each type of pearl discussed, sites where pearls are cultured, and some truly magnificent pearl jewelry. Mr. Müller has succeeded in his goal of creating a well-balanced and informative overview of the cultured pearl.

JANA MIYAHIRA

*Gemological Institute of America  
Carlsbad, California*

## DANA'S NEW MINERALOGY, 8th edition

Rewritten by Richard V. Gaines, H. Catherine Skinner, Eugene E. Foord, Brian Mason, and Abraham Rosenzweig, 1,874 pp., illus., publ. by John Wiley & Sons, New York, 1997. US\$250.00\*

Here at long last is an updated edition of *Dana's System of Mineralogy*. The seventh edition, published in two volumes in 1944 and 1951, covered all minerals known at the time, with the exception of the silicates.

This new edition covers all minerals known through 1995, approximately 3,550 species. To accomplish this in a single volume, the authors had to greatly slim down the descriptions, eliminate much of the crystal morphology, and list only a few references to original work, in a highly abbreviated form. Printed on a good-quality, thin, alkaline paper, the book's 1,800 pages occupy only 2 inches of shelf space.

Previous editions of *Dana's System of Mineralogy* classified minerals on the basis of chemical composition and crystallography. The major contribution of this volume is its expanded, modernized version of this classification system, especially for the silicates. Each mineral has a four-part classification number referring to class (composition group, such as oxides), type, and two numbers to indicate species. This hierarchical numbering system allows the insertion of new species into a list that emphasizes close chemical and structural affiliations. The type classification of the silicates is based largely on crystal structure, and many drawings are provided to illustrate different atomic arrangements.

Each mineral entry includes a classification number, chemical formula, name derivation, relationships with similar minerals, crystallography (that is, crystal system, crystal class, important crystal forms, space group symmetry, and twinning, if any), physical properties (color, habit, streak, luster, cleavage, fracture, hardness, and density), optical properties,

\*This book is available for purchase through the GIA Bookstore, 5345 Armada Drive, Carlsbad, CA 92008. Telephone: (800) 421-7250, ext. 4200; outside the U.S. (760) 603-4200. Fax: (760) 603-4266.

X-ray diffraction data, crystal structure, and occurrences. The properties and occurrences of common minerals, such as quartz and the feldspars, are discussed extensively. The rare minerals receive much less coverage, with only one or two occurrences mentioned.

Besides its expanded classification of known minerals, the book's strengths include its updated information on structure and X-ray diffraction data, and its list of important occurrences. There are also clear presentations of the interrelationships between the members of important groups, such as the 11 species of the tourmaline group.

Price will deter many from adding *Dana's New Mineralogy* to their libraries, even though the buyer is getting a classification and description of 3,550 minerals at only \$0.07 per mineral species. While the book is a must for mineralogists and mineral collectors, I suspect that many *Gems & Gemology* readers will find the coverage of gem minerals insufficient to warrant the cost.

WILLIAM S. WISE  
*University of California,  
Santa Barbara*

## MINERAL COLLECTOR'S HANDBOOK

By Barry Krause, 192 pp., illus., publ. by Sterling Publishing Company, New York, 1996. US\$24.95\*

The emphasis of a handbook for mineral collectors should be on the specific concerns of a mineral collector, rather than on geology and mineral identification; *Mineral Collector's Handbook* lacks this focus. These specific concerns are not actually addressed until the third chapter, after almost 60 pages. The chapters of particular interest to mineral collectors are Handling and Housing a Collection, Field Collecting of Rocks and Minerals, and Mineral Collecting

Specialties. Although of some importance to the collector, other chapters such as Origins of Rocks and Minerals, Rock Classification and Identification, Mineral Crystallography, Mineral Physical Properties and Tests, Mineral Optical Properties, and Mineral Classes deserve separate treatment, and there are several fine texts available. The book also overemphasizes gem minerals and jewelry at the expense of non-gem minerals, and non-mineral gems such as amber and ivory should not have been included at all.

Most of the information is basic but sound, with the exception of a few gemologically incorrect statements. For example, the author states that emeralds fade in sunlight over time (actually, emerald coloration is not affected by sunlight), and that diamond has the highest refractive index of any singly refractive mineral (actually, cuprite's is higher).

Perhaps the ideal handbook for a mineral collector could be assembled from segments of three books by Dr. John Sinkankas: *Mineralogy*, which not only contains detailed identification information but also provides advice on what species and localities are desirable to collect and what constitutes a fine specimen; *Field Collecting Gemstones and Minerals*, which tells how to find and properly collect gems and minerals without damaging them; and *Gemstone and Mineral Data Book*, which provides valuable information on cleaning and preserving specimens.

Although the focus of *Mineral Collector's Handbook* could be improved, the quality of the color photographs (courtesy of GIA and the Natural History Museum of Los Angeles County, among others), by such talents as Tino Hammid and Robert Weldon, gives the book an attractive look. I would recommend *Mineral Collector's Handbook* for beginners who are interested in start-

ing a collection of minerals and/or gems.

MICHAEL T. EVANS  
*Gemological Institute of America  
Carlsbad, California*

## OTHER BOOKS RECEIVED

**Gemme del Vicentino (Gems of Vicenza)**, by Matteo Boscardin and Ottaviano Violati Tescari, 114 pp., illus., publ. by Zannato Civic Museum, Montecchio Maggiore, 1996, US\$14.00 (in Italian, with English summary). Although small in size (roughly 80 km by 50 km), the Vicenza region of northeastern Italy is of great gemological interest. The area is a source of beryl, corundum, feldspar, garnets, silica materials (agate, amethyst, chalcedony, and rose quartz), and a wide variety of other gem materials. *Gems of Vicenza* is intended as a popular, well-illustrated text for those interested in exploring the gemological possibilities of this particular area.

The authors begin with a concise introduction to the history of gems in Vicenza, dating back to the mid-18th century. The bulk of the text is devoted to a profile of more than 30 locally found gems and their characteristics, most accompanied by color photographs of specimens from the Zannato Municipal Museum. The text is clear and well written, and the photos are of excellent quality; the delicate flesh-pink color of xonotlite, for example, is clearly visible. Then, after a brief chapter on gem cutting, the book concludes with several detailed tables of gem characteristics. *Gems of Vicenza* succeeds in spotlighting the gemological significance of this region.

R. A. HOWIE  
*Royal Holloway  
University of London,  
United Kingdom*



# Gemological



# ABSTRACTS

## EDITOR

A. A. Levinson  
University of Calgary  
Calgary, Alberta, Canada

## REVIEW BOARD

Anne M. Blumer  
Bloomington, Illinois

Peter R. Buerki  
GIA, Carlsbad

Jo Ellen Cole  
GIA, Carlsbad

Maha DeMaggio  
GIA Gem Trade Laboratory  
Carlsbad

Professor R. A. Howie  
Royal Holloway, University of London

Mary L. Johnson  
GIA Gem Trade Laboratory  
Carlsbad

Elise B. Misiorowski  
Los Angeles, California

Jana E. Miyahira  
GIA, Carlsbad

Himiko Naka  
GIA Gem Trade Laboratory  
Carlsbad

Carol M. Stockton  
Alexandria, Virginia

Rolf Tatje  
Duisburg University  
Duisburg, Germany

Sharon Wakefield  
Northwest Gem Lab  
Boise, Idaho

## COLORED STONES AND ORGANIC MATERIALS

**Annual pearl report.** *Europa Star International Jewellery*, No. 224–225, October–November 1997, pp. 42, 44, 46, 48, 50.

This article reports on pearl production worldwide, according to geographic origin and type:

- *French Polynesia*—The first half of 1997 saw a 5% increase in value—but a 13% decrease in volume (to 1.43 million grams)—of exports of unmounted Tahitian black pearls. The average price increased 20.8%, from \$20.1 per gram in the first half of 1996 to \$24.28 in the first half of 1997. Exports to the United States increased 73% in value, and to Hong Kong, 31.6%. The U.S. replaced Japan as the largest buyer in June 1997.

- *China*—Chinese total pearl exports (worked cultured, unworked cultured, and natural) decreased 86.1% in value to \$39.08 million, and decreased 42.1% in weight to 280.79 million grams in 1996, according to the Customs General Administration in Beijing. Worked cultured pearls constituted the largest segment (68%) by weight of the pearl exports, most of which went to Hong Kong (about 95%); Japan and Taiwan each took about 1.5%. By value, Hong Kong accounted for 89%, Japan 5%, and the U.S. 2% of the worked cultured pearls.

- *United States*—With demand and prices for abalone pearls rising in Asia, Europe, and the United States, the

---

*This section is designed to provide as complete a record as practical of the recent literature on gems and gemology. Articles are selected for abstracting solely at the discretion of the section editor and his reviewers, and space limitations may require that we include only those articles that we feel will be of greatest interest to our readership.*

*Requests for reprints of articles abstracted must be addressed to the author or publisher of the original material.*

*The reviewer of each article is identified by his or her initials at the end of each abstract. Guest reviewers are identified by their full names. Opinions expressed in an abstract belong to the abstractor and in no way reflect the position of Gems & Gemology or GIA.*

© 1998 Gemological Institute of America

California Fish and Game Commission is considering closing the state's heavily harvested fisheries so that the stock may recover. As a result, prices will probably climb even higher as abalone becomes harder to find.

- *Chinese Akoya*—Production of the larger (7–7.5 mm) Chinese Akoya pearls increased in 1997, totaling 5%–10% of current exports. Prices of high-quality Chinese Akoya pearls increased slightly in 1997. But with overall prices remaining stable, the market does not appear strong enough to warrant a price increase.

- *Japanese Akoya*—Japanese Akoya pearl exports declined in 1997, mainly because of competition from the Chinese Akoya and decreased demand in Asia. The poor state of the market is exacerbated by a high oyster mortality; it may take up to three years for production to recover.

- *Golden South Sea Pearls*—Low supplies and increased demand have caused prices of Indonesian golden pearls to increase by 300% in the last four years. According to one source, prices have increased to between \$400 to \$600 a gram for better-quality pearls. Production of yellow and golden pearls has recently decreased, because farmers have artificially bred oysters to get a higher production of better-selling white pearls. However, the growing market for South Sea pearls is prompting companies to invest in farms in Indonesia, the Philippines, Vietnam, Myanmar, and China. As a result, production is anticipated to increase by the year 2000.

MD

**Les gisements d'émeraude du Brésil: Genèse et typologie (The Brazilian emerald deposits: Formation and classification).** G. Giuliani, A. Cheilletz, J.-L. Zimmermann, A. Maria Ribeiro-Althoff, C. France-Lanord, G. Feraud, *Chronique de la Recherche Minière*, No. 526, 1997, pp. 17–61 [in French].

**Comment se forment les émeraudes: Caractériser la géologie des gisements pour mieux distinguer les vraies des fausses (How emeralds develop: Characterizing the geology of deposits in order to better distinguish natural from synthetic stones).** A. Cheilletz, G. Giuliani, *La Recherche*, No. 303, 1997, pp. 48–52 [in French].

Both of these articles cover the formation and geologic evolution of emerald deposits. The first article (with an extended abstract in English) reviews previously published studies and presents a detailed scientific description of the Brazilian emerald deposits, including their geologic history, the local tectonics, and the geochemical environment in which the deposits formed. A model is proposed that explains both the formation of emerald deposits and their rarity. Two general types of deposits are distinguished: Brazilian and Colombian. An extensive reference list is provided.

The second article summarizes the contents of the first publication with a less technical approach. It con-

cludes by stressing the need for more research on the chemistry of emeralds. A better understanding of the conditions required for emerald formation should help in determining their geologic and geographic origin, as well as in distinguishing between natural and synthetic stones. PRB

**The impact origin of Libyan Desert glass.** R. Rocchia, E. Robin, F. Fröhlich, J. Amossé, J.-A. Barrat, H. Méon, L. Froget, E. Diemer. In Vincenzo de Michele, Ed., *Proceedings of Silica '96—Meeting on Silica Glass and Related Desert Events, Sahara*, Special Issue, Vol. 10, 1997, pp. 143–149.

Using geochemical, isotopic, and infrared spectroscopic data, the authors provide evidence for the impact origin of natural high-silica Libyan Desert glass from the western part of the Great Sand Sea. This material is thought to have formed 25–30 million years ago by the impact of a meteorite into a silica-rich target that consisted of quartz mixed with small and variable amounts of clay. The glass fragments weigh between a few grams and several kilograms, cover an area (or "strewn field") of 130 x 50 km<sup>2</sup>, and comprise a total mass exceeding 10,000 tons. Local enrichment of elements such as those found in meteorites (i.e., Ni, Co, Fe, Cr, Ir, Ru, Rh, Pt, and Pd) is believed to originate from melted fragments of the bolide [an extraterrestrial object that explodes on hitting the atmosphere or earth] that were incorporated into the glass during the impact. The data do not provide much information about the composition of the target or the geographic location of the impact. [Editor's note: For more information on Libyan Desert glass, see Gem News in this issue, p. 58.] PRB

**It's got to be pearl-fect!** S. Jarrell, *Europa Star International Jewellery*, No. 224–225, October–November 1997, pp. 25–29.

The author visited Northern Australia's coast to witness the production of the South Sea pearls grown there, the world's largest. The oyster (*Pinctada maxima*) takes up to three years to produce one South Sea pearl. Wild *Pinctada maxima* are collected and placed in warm and uncontaminated waters, where they grow and develop prior to seeding. (The Australian government controls the number of pearl farms and the number of wild oysters that may be collected by divers. Hence, some farms now grow their own oysters for seeding.) Once seeded, the oysters are placed in panels that are hung under water. Every three to four weeks, seaweed and barnacles are scraped off the shells and the panels are washed. After three years, the pearls are removed. The oysters are checked to ensure that they are suitable for reseeded, and, if they are, the process immediately starts again.

The pearls are graded according to their shape, size, and color. Graders are dressed in white to ensure that the color grade of the pearl is not affected by any surrounding color. The colors vary from a grayish blue, to white, to

gold. The South Sea pearl can only be grown in an uncontaminated environment, and the companies using the area ensure that the water remains free from pollution.

MD

**Mysterious pearls.** J. Traub, *Smithsonian*, Vol. 28, No. 4, July 1997, pp. 70–76, 78–79, 130.

In 1993, a Swiss gem dealer presented a collection of 23 large, intensely colored orange “pearls” to jeweler and collector Ben Zucker, to solicit his help in determining their provenance. [Editor’s note: These are not nacreous pearls, but rather are more similar to “conch pearls.”] Zucker’s first avenue of inquiry was GIA Research, where he learned that these “pearls” are the product of the *Melo melo* gastropod, which lives in the waters off Southeast Asia. After much research and contemplation, Mr. Zucker concluded that they were collected during the 18th century Le Dynasty of Vietnam, and became part of the Vietnamese royal treasury. To validate this theory, he traveled to Vietnam and contacted archeologists, curators, fishermen, and scholars. Unfortunately, no one had ever seen or heard of this royal pearl collection. A spokeswoman for the last emperor of Vietnam, Bao Dai (now residing in Paris), stated, “The emperor has never heard of these pearls; thus, he says, they do not come from the royal family.” Undaunted, Zucker remains confident that his theory will ultimately be vindicated. SW

**A pavement of pearl.** L. Addadi and S. Weiner, *Nature*, Vol. 389, October 30, 1997, pp. 912–913, 915.

Mollusks build their shells out of calcium carbonate (aragonite and/or calcite) and an organic matrix. The best-studied shell architecture is that of nacre, the material that makes up pearls. The cross-sectional microstructure of nacre resembles a brick wall, with flat polygonal crystals of aragonite acting as bricks, mortared with organic material consisting of aligned protein fibers and polysaccharides (complex sugar molecules). Two fundamental questions are: (1) How does material flow from a mollusk’s layer of living cells (called the mantle) to the interior surface of the shell to form aragonite crystals, and (2) how do these crystals grow in almost perfect alignment?

T. Schaffer and colleagues have studied “flat pearls”—nacreous layers deposited by abalone on pieces of glass cover-slip—using an atomic force microscope to examine materials still in their living configurations. Their research suggests that the nacre layers grow between a series of closely spaced protein-sugar layers. This matrix contains pores that allow the aragonite crystals to grow from one layer to the next without the need for separate nucleation events. Each layer contains one pore per every 100 square microns, with diameters between 5 and 50 nanometers.

The biochemistry of the protein-sugar layers is also being investigated; a recent study found that one component is a protein similar to silk. Soluble glycoproteins

form another important component, and are thought to regulate the carbon ions required for aragonite formation; the amino acid complex of one such protein was sequenced last year. The study of mollusk nacre is at the forefront of research in biomineralization, which is the study of the creation of hard structures by organisms.

MLJ

**A pearl primer.** D. Federman, *Modern Jeweler*, Vol. 96, No. 10, October 1997, pp. 57–64.

This excellent primer sequentially highlights specific attributes of Akoya, Tahitian, South Sea, golden, freshwater, keshi, and mabé cultured pearls. The series of attractively illustrated, one-page introductory articles is intended to help jewelers educate their customers about the wide range of pearl products available today. Each profile provides information regarding unique characteristics, typical size range, color palette, and geographic origin of the various types of pearls, and offers suggestions for the budget-conscious. SW

## DIAMONDS

**Aber spends big.** *The Financial Post* (Canada), March 7–9, 1998, pp. 1–2.

Details have been released by Aber Resources Ltd. (40%) about the development of the Diavik mine with partner Rio Tinto PLC (60%) in the Northwest Territories. This will be Canada’s second diamond mine (after the Ekati mine), and it could start production as soon as late 2001. The mine will cost Can\$875 million and is expected to yield 8 million carats per year for 16–22 years. The diamonds are valued at an average of US\$56 per carat.

The mine presents complex engineering problems because it lies under a lake (Lac de Gras). It will require several kilometers of dikes to isolate the kimberlite pipes from the lake. An environmental assessment report and a feasibility study are expected to be completed this year, and construction is scheduled to begin in 1999 or 2000. The review process will benefit from the approval that BHP and Dia Met received for their nearby Ekati mine, which is scheduled to begin production by the end of 1998. AAL

**ADC releases new Pipe 441 results.** *Diamond International*, No. 49, September/October 1997, pp. 14, 16.

Archangel Diamond Corporation (ADC) has released preliminary results from its joint venture at the Verkhotina property, in the Arkhangelsk region of northwestern Russia. The magnetic anomaly associated with Pipe 441 at Verkhotina is at least 40 hectares (ha) in size, and 17 ha of diamondiferous kimberlite have been discovered in the northern part of this anomaly. Provisional data from 17 large-diameter drill holes (total weight of ore not provided) have shown an ore grade of 1.0–1.5 carats per ton,



with the largest diamond to date weighing 0.94 ct. The diamond crystals are mostly octahedra, and 60%–70% are gem quality. Two 150 ton bulk samples are still under evaluation. Two international firms (from South Africa and the U.K.) are providing on-site inspection, and they have verified that the diamonds came from Pipe 441 (that is, the ore was not “salted”). ADC has withdrawn from another joint venture in the Arkhangelsk region (at Windy Ridge) because of poor exploration results.

MLJ

**Anglo American's cutting edge.** *Mining Journal, London*, Vol. 329, No. 8437, July 11, 1997, pp. 30–31.

This article summarizes the annual report of Anglo American Corporation and describes the innovative research and development programs carried out in their various company laboratories. These laboratories include:

- the Central Technology Office in Johannesburg, which provides design and field services to Anglo American's mining ventures
- the Anglo American Research Laboratories, with a long-term (20 year) applied research focus and a staff of 220 distributed among four laboratories (chemistry, geology, metallurgy, and unspecified research)
- three De Beers research laboratories: the CSO Diamond Trading Division in Maidenhead, U.K., with a staff of 125 and a focus on gem grading, valuation, and diamond fingerprinting; the Industrial Diamond Division, with labs in Ascot, U.K. (63 employees; industrial applications) and Johannesburg (116 employees; diamond synthesis); and the Mineral Processing Division in Johannesburg, which works with manufacturing arm Debex Electronics to focus on diamond control systems and equipment (404 employees)

Among major recent advances in research are X-ray diamond sorting machines and products designed to increase the security of diamond mining (e.g., a fully automated and integrated diamond sort-house, and low-level-X-ray full-body scanners).

MLJ

**Argyle cranks up the production.** *Australia's Paydirt*, Vol. 1, No. 36, February 1998, p. 11.

Ashton Mining Ltd., which holds approximately 40% interest in the Argyle diamond mine, reported that total 1997 production at the mine was 40.2 Mct and that sales were US\$330.8 million; a record tonnage of ore was mined in the last quarter of the year. As the Argyle pit gets deeper, open-pit mining will not be feasible in a few years, so alternative mining methods are being considered.

Ashton continues to develop the Merlin diamond project in the Northern Territory, Australia, as well as alluvial concessions in Angola; active exploration projects are underway in Mauritania, Mali, Botswana, and Canada.

AAL

**Ashton sizes up K14 Alberta kimberlites.** *Northern Miner*, Vol. 83, No. 48, January 26–February 1, 1998, pp. 6, 11.

A potentially important new kimberlite field in north-central Alberta (about 500 miles [800 km] southwest of the Lac de Gras kimberlite field in the Northwest Territories) is the object of intensive exploration activity. One company alone, Ashton Mining Ltd. of Canada, found 15 kimberlites during 1997 in the Buffalo Hills area. One of the most promising is the large (about 400 m in diameter, or 15–18 ha) K14 pipe, which has a highly variable diamond content. From a 48.7 ton composite sample, 7.79 carats of diamonds were recovered, for an average grade of 0.174 ct/ton. The largest stone recovered weighed 1.31 ct, but was not gem quality. Evaluation of known kimberlites, and exploration for new ones, continues.

AAL

**Diamonds: the allure remains.** *Mining Journal, London*, Vol. 329, No. 8452, October 24, 1997, pp. 345–347.

The 1997 World Diamond Conference was held on October 7 and 8 in Perth, Australia. Much of the attention was focused on diamond exploration and mining in Australia, as well as on the worldwide diamond activities of Australian companies.

In 1996, diamonds worth Aus\$503 million were recovered from Australia (all from the Argyle mine), and \$58 million was spent on exploration (compared to an estimated \$63 million in 1997). Whereas the Argyle deposit is hosted by lamproite of Proterozoic age, the diamond-bearing kimberlite pipes in South Africa and Russia are younger (predominantly Devonian and Cretaceous), leading to speculation that Australia's share of these younger pipes may someday be found. At least 18 companies are currently involved in exploration. Also of interest is the older (Archean) Yilgarn craton, where kimberlites—but so far no diamonds—have been found.

Ashton is proceeding with development at Merlin, the project where the first pipe in the Northern Territory was discovered in 1993. A 710,000 ton/year processing plant will be fed by ore from nine kimberlites. The average mine grade is estimated at 0.42 ct/ton, and the average value at about US\$75 per carat. All the pipes are steep-sided cylinders, and at least three are zoned, with ore grades significantly higher toward the boundary of the pipe. Project commissioning could occur in late December 1998, with diamond sales anticipated shortly thereafter.

Australian companies are involved in numerous diamond exploration and mining projects around the world. For example, Moonstone Diamond Corp. and its South African partner Benguela Concessions are mining beneath the shallow waters off Namaqualand, South Africa. Trial mining stands at 3,500 ct/month, with production beginning this year at an anticipated 35,000–60,000 ct/year. BHP is involved in the Lac de Gras joint

venture with Dia Met, which is bringing Canada's first diamond mine into production. Expected mine life is about 25 years, with a total resource of 66 Mtons of ore at 1.09 ct/ton and an average value of US\$84 per carat. Quantum Resources is exploring an area in Liaoning Province, China, that contains the Fuxian kimberlite province. Additional exploration by Australian companies is proceeding in Africa, Indonesia, and Finland.

MLJ

**Genesis of presolar diamonds: Comparative high-resolution transmission electron microscopy study of meteoritic and terrestrial nano-diamonds.** T. L. Daulton, D. D. Eisenhour, T. J. Bernatowicz, R. S. Lewis, and P. R. Buseck, *Geochimica et Cosmochimica Acta*, Vol. 60, No. 23, 1996, pp. 4853–4872.

Extremely small (on the order of a billionth of a meter) "nano-diamonds" were discovered in a rare class of meteorites called carbonaceous chondrite about 10 years ago. They are believed to have formed before the solar system did, but the exact mechanism of their formation has not been resolved. Thus, high-resolution transmission electron microscopy images of nano-diamonds isolated from the Allende and Murchison carbonaceous meteorites were obtained. The microstructures of these presolar diamond crystallites were compared to those of nano-diamonds synthesized by two mechanisms—shock metamorphism and chemical vapor deposition—to determine the most likely mechanism of formation.

In the synthesized diamonds, microstructural features are described that appear unique to shock metamorphism and to nucleation from the chemical vapor phase; the latter features occur in the presolar diamonds. The predominant mechanism for presolar diamond formation is, therefore, a chemical vapor deposition process, suggesting a circumstellar origin. The (2H) hexagonal polytype of diamond (lonsdaleite) from the meteoric residues is also described. Its crystallization history, however, is not fully understood.

AAL

**Guyane: A prime target for exploration.** W. G. Prast, M. Forrest, M. Jones, S. Walker, and W. Dymott, *Advertising Supplement to Mining Journal, London*, Vol. 329, No. 8448, September 26, 1997, 20 pp.

Prospecting for diamonds in Guyane (also known as French Guiana) dates to the middle of the last century. The country is situated on the Guiana Shield, a Precambrian craton which corresponds in geology and age to the diamond-containing West Africa Shield. The two shields were joined at one time, before the opening of the Atlantic Ocean about 115 million years ago.

Prospecting for diamonds has been taking place for many years, but until the past decade, the only diamonds discovered came from recent alluvial deposits. Since then, microdiamonds (<0.5 mm) and some larger stones (to 2.7 mm) have been found in a 5-km-long belt of talc schist at Dachine. However, there were not enough large

stones (i.e., greater than 1.25 mm in length) for this deposit to be considered economic in 1996, although exploration is continuing. An inventory of mineral resources in Guyane, a long-term project undertaken by the Bureau de Recherches Géologiques et Minières in 1975 to seek new deposits and promote mining investment, is now complete.

MLJ

**I would like to point potential diamond hunters in the direction . . .** E. Szykowski, *International California Mining Journal*, Vol. 67, No. 4, December 1997, p. 3.

Several diamonds have come from Hayfork Creek and its tributaries in northern California. The author mentions "two stones over three ounces each" [!]. [Editor's note: The three largest authenticated diamonds found in California were 32.99, 17.83, and 14.33 ct (all industrial grade); see R.W. Kopf et al., "Recent Discoveries of Large Diamonds in Trinity County, California," *Gems & Gemology*, Fall 1990, pp. 212–219].

Almost all the gold in Hayfork Creek comes from two "old ocean bottom" conglomerates, which were uplifted several million years ago. One such unit is several kilometers long and lies on the north side of the east fork of Hayfork Creek, which was extensively dredged in the 1930s and 1940s. The other conglomerate body is within a triangle (about 4 km across) joining Carrier Gulch, Kingsbury Gulch, and Dobbins Gulch. These conglomerates are believed to be the source of both the gold and the diamonds in the Hayfork Creek gravels.

MLJ

**Mining finance.** *Mining Journal, London*, Vol. 329, No. 8453, October 31, 1997, p. 374.

DiamondWorks Ltd. recently sold (by closed tender in Antwerp) its first parcel of alluvial diamonds from the Luo mine in northeast Angola. The parcel weighed 10,375 carats and sold for US\$3.1 million; about one-third of the stones were larger than 1 ct, selling for an average of \$791 per carat. Between mid-July and mid-October 1997, about 18,000 carats have been produced at Luo. DiamondWorks plans to start production at another Angolan alluvial concession, Yetwene, in the summer of 1998.

MLJ

**A new tetragonal silicate mineral occurring as inclusions in lower-mantle diamonds.** J. Harris, M. T. Hutchison, M. Hursthouse, M. Light, and B. Harte, *Nature*, Vol. 387, May 29, 1997, pp. 486–488.

An "apple-green" mineral with a tetragonal crystal structure and chemical composition approximating that of almandine-pyropo garnet has been found as inclusions in eight diamonds from São Luiz, Brazil. From its structure and composition, it is known as TAPP (tetragonal almandine-pyropo phase). Crystals occur as distinct cubo-octahedra, sometimes flattened or elongated, ranging from

0.03 to 0.1 mm. In earlier publications, this phase has been mistakenly called garnet.

Although TAPP's stoichiometry, or relative proportion of atoms, is similar to that of garnet, the Mg/(Mg+Fe) ratio in TAPP is 0.93, higher than that of garnet found as inclusions in diamonds. Chromium is somewhat low (up to 2.8 wt.% Cr<sub>2</sub>O<sub>3</sub>), and calcium is very low. According to results of Mössbauer spectroscopy, more than half of the iron present is in the Fe<sup>3+</sup> oxidation state.

Oxide and silicate mineral inclusion assemblages in the diamonds suggest that they formed at depths below ~660 km (e.g., the upper to lower mantle transition). The authors offer several theories as to why TAPP has not been seen in experiments intended to reproduce the phase relations of aluminum-bearing compositions at lower mantle pressures and temperatures. MLJ

#### **Prospecting for diamonds in Wyoming and Colorado. W.**

D. Hausel, *International California Mining Journal*, Vol. 67, Part 1: No. 3, November 1997, pp. 55–56, 58. Part 2: No. 4, December 1997, pp. 17–20, 60–62.

In Part 1, the author describes diamond prospecting methods. Part 2 identifies areas in Wyoming and adjacent states where diamonds have been or may be found.

Economic diamond-bearing source rocks (kimberlite and lamproite) are confined to regions underlain by *cratons*, that is, very thick regions of ancient continental crust that stabilized over 1.5 billion years ago. Such a craton underlies Wyoming and adjacent portions of Colorado, Utah, and Montana.

Diamonds are associated with "indicator" minerals derived from kimberlite and lamproite (e.g., "G10" pyrope and "Group I" pyrope-almandine garnet) that contain specific chemical compositions; similar minerals ("G9" pyrope and "Group II" garnet) with slightly different compositions may indicate shallower depths where diamond formation should not occur. G10 and Group I garnets and certain other indicator minerals (e.g., chrome diopside, chromite, and picroilmenite) can be used to locate the diamond source rocks by analyzing stream sediments. However, under the conditions present in Wyoming, pyrope and diopside disaggregate within 3 miles (5 km) and 0.25 miles, respectively, of their sources. Diamond is the best indicator for diamond deposits because of its durability, but small specimens can float away from a heavy sand concentrate unless grease is employed as a collection material. Kimberlites can also be found by geophysical methods, or by looking for circular depressions (sometimes misidentified as impact craters). Much prospecting work in Wyoming has already been performed by the Wyoming State Geological Survey, and reports are available.

Diamonds and possibly diamondiferous primary rocks have been found in several places in Wyoming and adjacent states. The State Line district on the Colorado border is the most important at this time, with the Kelsey Lake diamond pipes having produced 120,000 stones

(total carat weight not given) so far; the largest one is 28.18 ct. About 40 pipes have been discovered in this region, but some have very low ore grades (e.g., 0.0061 ct/ton and 0.171 ct/ton at Sloan 1 and Sloan 2, respectively). However, not all known pipes have been tested, and some may yet prove economic. Also, many placers in the region have not yet been tested for alluvial diamonds.

Diamonds have been found in alluvium or ancient sediments at: the Gros Ventre Mountains, the Medicine Bow Mountains, and the Wind River Mountains (all in Wyoming); along the Missouri River in Montana; and reputedly on the western border of Idaho. Kimberlites, lamproites, or indicator minerals (but no confirmed diamonds) have been discovered at: Colorado's Green Mountain pipe, and in Wyoming at the Laramie Range, the Seminoe Mountains, the Leucite Hills, and the Bighorn and Green River Basins. Lamproite and related rocks have been found in northern Utah. MLJ

#### **Syngenetic inclusions in diamond from the Birim field (Ghana)—A deep peridotitic profile with a history of depletion and re-enrichment. T. Stachel and J. W.**

Harris, *Contributions to Mineralogy & Petrology*, Vol. 127, No. 4, 1997, pp. 336–352.

This paper is the first detailed report on diamonds from the West African craton and their mineral inclusions. It is based on the study of 308 inclusion-bearing diamonds from the placer deposits of the Akwatia mine, southern Ghana, on which numerous physical and chemical properties were determined (size, shape, color, deformation, inclusion assemblage, nitrogen content and aggregation state, and stable isotopes). Compared with 1,100 diamond inclusions in a worldwide database, the Akwatian inclusions have olivine with lower Mg/Fe ratios and extremely high Ni contents. Geothermometry shows that the Akwatian inclusions formed at a temperature of 140°–190°C hotter than the peridotitic average (1050°C), and garnet-orthopyroxene equilibria indicate a typical shield geotherm (40–42 mW/m<sup>2</sup>). These elevated temperatures imply an unusually deep origin for a peridotitic suite. The inclusions in these diamonds are believed to represent the most complete cross-section through peridotitic sub-continental upper mantle so far observed. Consequently, the inclusions imply that Akwatian diamonds formed at a greater depth (200–240 km) than most other diamonds [usually given as about 150 km]. RAH

#### **GEM LOCALITIES**

**Changes in the central Queensland gemfields. G. May and P. May, *Australian Gold Gem & Treasure*, Vol. 12, No. 12, December 1997–January 1998, pp. 23–25.**

An awareness of tourism's potential benefits has brought considerable changes to the central Queensland gemfields in the last decade. The effort is aimed at making the gemfields more accessible to fossickers [gem and mineral col-



lectors] by providing more modern amenities while maintaining the frontier flavor of the area. Roads have been paved, new hotels built, and water supplies improved.

In August, Gemfest 1998 will feature an exhibition of Australia's finest sapphires, as well as other Australian and overseas gemstones. Among the many attractions will be sapphire-"divining" demonstrations and displays of mining/fossicking equipment, as well as arts and crafts. MD

**Gem of a holiday.** I. Levingston, *Australian Gold Gem & Treasure*, Vol. 12, No. 9, September 1997, pp. 29-31.

The S 'n' S (Silk and Sapphires) mine at Rubyvale, 350 km west of Rockhampton in central Queensland, is reputedly the only sapphire mine in Australia operating primarily for the amateur and tourist. One can purchase and process a bucket of sapphire-bearing "wash" (unconsolidated material) for Aus\$5, or a "skip" load, which contains approximately six buckets of wash, for \$20. For real adventurers who want to collect their own samples underground, a half-day dig at a depth of 60 feet (18.3 m) costs \$60 per person; one couple recovered 340 carats of sapphire in two hours by this option. Stones can be fashioned by a local cutter. MD

**Gemmological features of rubies and sapphires from the Barrington volcano, Eastern Australia.** G. Webb, *Australian Gemmologist*, Vol. 19, No. 10, 1997, pp. 471-475.

Ruby is rare in Australia, but in the Barrington area of New South Wales, ruby and pink sapphire form up to 50% by weight of the gem corundum concentrate. These stones have Cr<sub>2</sub>O<sub>3</sub> contents of 0.60-1.42 wt.%, and FeO contents of 0.44-0.75 wt.%. They typically range from 2 to 6 mm, and contain inclusions of spinel and liquid-filled fractures. Polysynthetic twinning is common and is often associated with inclusions of boehmite needles.

On the basis of trace-element content, the Barrington corundum is divided into two distinct suites: One is related to ruby, while the other is typical of eastern Australian sapphires. The ruby-containing corundum suite originated in a metamorphic environment, whereas the non-ruby suite has a magmatic origin. Both suites were brought to the surface by basaltic volcanism. RAH

**Gemstones galore.** A. Taylor, *Australian Gold Gem & Treasure*, Vol. 12, No. 10, October 1997, pp. 28-31.

Rio de Janeiro is presented as the gemstone capital of the world, where stones can be bought everywhere (the airport, Copacabana Beach, the hotels, and even at the top of Sugar Loaf Mountain). Jewelry prices are related to location; in the beach area, for example, they are similar to those in Australia, with emerald-like green fluorite selling for Aus\$10 and pale emerald costing just a few dollars.

The world-famous, upscale jewelers Amsterdam Sauer and H. Stern have their headquarters, salesrooms, and gem museums in Ipanema, the suburb adjacent to Copacabana. At Stern's, visitors may take a self-guided tour that explains the entire jewelry-making process, from mining, gem cutting, gemstone identification, and valuation, to silversmithing and jewelry marketing. Workers behind glass partitions demonstrate the sawing of rough gem material, followed by preforming, and faceting.

The author also visited the state of Minas Gerais, one of the world's largest pegmatite provinces and a source of tourmaline, aquamarine, emerald and other beryls, quartz, and topaz. He makes observations on the relatively primitive nature of several mines in the area, as well as on the picturesque city of Ouro Preto, home of the famous School of Mines and mineralogical museum. MD

**Gemstones in the pegmatites of the eastern Pamirs.** A. M. Skrigitil, *World of Stones*, No. 11, 1996, pp. 16-19, 21-25.

A variety of gem materials are associated with pegmatites that are spatially and genetically related to the Alpine-age Shatput granites. The largest pegmatites occur in the Muzkol-Rangkul' anticlinorium in Precambrian rocks. Gem-bearing pegmatites are divided into two types: miarolitic and granitic. Three subtypes of miarolitic pegmatites are characterized by their contents of lepidolite, beryl, and topaz. The granitic pegmatites are also divided into three subtypes: (1) danburite-, multicolored tourmaline-, and smoky quartz-bearing; (2) scapolite-bearing; and (3) moonstone-bearing. Detailed descriptions are given of the tourmaline (with chemical analyses of five color zones from one multicolored crystal: black, dark brown, yellow, green, pink), topaz, scapolite (marialite), danburite, and aquamarine. Notes are also given on apatite, hambergite, and moonstone. RAH

**Namibia: Abundant exploration opportunities.** W. G. Prast, *Advertising Supplement to Mining Journal, London*, Vol. 329, No. 8450, October 10, 1997, pp. 1-16.

Namibia's recent economic policies encourage exploration and new mining initiatives. The country produced nearly 1.5 Mct of diamonds in 1996, as well as colored stones and ornamental materials. Diamonds provide about 60% of Namibia's exports and 15% of the country's gross domestic product (GDP). Although most mining ventures pay an average tax of 35% of revenues, diamond mining is taxed at a special rate of 55%, with an additional 10% royalty; however, new mining ventures are taxed at lower rates. The law has also been streamlined to prevent the retention of mining claims where work on that claim has been deemed insufficient.

In central, southern, and northeastern Namibia, mid-Cretaceous kimberlites have been emplaced into relatively young (about 2 billion years old) basement rocks;

so far, these have been found to be either barren or sub-economic. However, the basement north of the Damara origin may be old enough (over 2.5 billion years) to have productive kimberlites, and the Kalahari Craton may extend westward into northern Namibia. So far, all the Namibian diamonds that have been mined economically are derived from alluvial material eroded from kimberlites in the center of the continent. Since the diamonds have been transported over great distances, about 96% of them are of gem quality. The important diamond mining areas are six uplifted beaches and the offshore alluvial deposits between the Orange River and Lüderitz. About one-third of the current diamond production is mined from the offshore deposits, in water up to 200 m deep.

Colored-stone-bearing pegmatites occur mainly in the Karibib-Walvis Bay-Omaruru area. Among the gems recovered are: tourmaline, beryl (aquamarine, heliodor, andmorganite), "mandarine" (spessartine) garnet, topaz, rose quartz, and blue lace agate. Sodalite is recovered (as an ornamental stone) in the far north of the country at Swaartbooisdrif.

This extensive report also describes the history and current methods of mining diamonds in Namibia, and it contains a generalized geologic map of the country.

MLJ

**New emerald deposits from southern India.** J. Panjekar, K. T. Ramchandran, and K. Balu, *Australian Gem-mologist*, Vol. 19, No. 10, 1997, pp. 427–432.

In 1995, emeralds were discovered on the inner walls of a well in the village of Sankari Taluka, in Tamil Nadu. The properties and characteristic inclusions of these emeralds are similar to those from Madagascar, suggesting their common origin in the super-continent of Gondwana, prior to the rifting of India roughly 200 million years ago.

The Sankari emeralds occur in mica schist and show a pale green core surrounded by a darker green rim. The following properties were measured: refractive index  $n_o$ —1.582–1.585,  $n_e$ —1.588–1.591; birefringence—0.006; and specific gravity—2.70–2.73. The emeralds contain inclusions of mica, apatite, pyrite, quartz, feldspar, spinel, beryl, tourmaline, and amphibole, with abundant fluid inclusions and healed fractures.

RAH

**(Ruby-sapphire)-chromian mica-tourmaline rocks from Westland, New Zealand.** R. Grapes and K. Palmer, *Journal of Petrology*, Vol. 37, No. 2, 1996, pp. 293–315.

"Goodletite" is an ornamental material consisting predominantly of corundum (ruby-sapphire), chromian muscovite, margarite, and tourmaline. Boulders of this material are found in glacial moraine and riverbeds in north Westland, on the South Island of New Zealand. Although the boulders have not been seen *in situ*, their location, Cr-rich composition, and (rare) serpentinite rinds indicate

that they are derived from ultramafic rocks occurring within Alpine schists of the Southern Alps.

From a gemological point of view, it is the chemical zoning of the corundum that is most interesting. The  $\text{Cr}_2\text{O}_3$  contents range from 0.5% to an amazing 13%, the red color becoming more intense with increasing Cr. In addition to the dominant  $\text{Cr}^{3+} \rightleftharpoons \text{Al}^{3+}$  substitution, those of  $(\text{Fe}, \text{V})^{3+} \rightleftharpoons \text{Cr}^{3+}$  and  $(\text{Ti}^{4+} + \text{Fe}^{2+}) \rightleftharpoons 2 \text{Cr}^{3+}$  result in spectacular color zoning from colorless to deep ruby red-carmine to pale blue and dark blue-violet. The corundum grew by replacement of the micaceous matrix of chromian muscovite ( $\text{Cr}_2\text{O}_3$  0.10%–4.10%) and chromian margarite ( $\text{Cr}_2\text{O}_3$  0.46%–1.20%). Tourmaline (dravite with  $\text{Cr}_2\text{O}_3 \leq 3.6\%$ ) occurs as veins and larger poikilitic crystals that replace the microcrystalline matrix. The rocks formed due to metamorphism of enclaves of quartzofeldspathic schist in serpentinite under "garnet-zone" metamorphic conditions (5–6 kbar,  $450^\circ \pm 20^\circ\text{C}$ ).

RAH

**Smaragde aus dem Ural (Emeralds from the Ural Mountains).** E. Strack, *Der Elisabeth Strack Kurier*, Vol. 14, No. 83, 1997, pp. 1–5 [in German].

This article describes the locality and history of the emerald deposits northeast of Ekaterinburg, in the Ural Mountains. These deposits have been known since the 19th century; the output was commonly called "Tokowaja emerald" and later "Malyshevo emerald." Included are anecdotes about the discoverers of the deposits.

PRB

**Tokowaja-Malyshevo: Die Smaragdgruben des Urals (The Uralian emerald mines).** J. V. Burlakov, J. A. Polenov, V. J. Gernakov, and A. V. Samsonov, *Lapis*, Vol. 22, No. 7/8, 1997, pp. 44–55, 90 [in German].

Information about the location of the emerald deposits northeast of Ekaterinburg in the Ural Mountains of Russia is followed by a detailed historical outline, starting with the discovery of the emerald and alexandrite deposits in 1831. Production data and a short discussion of the scientific literature are also presented, along with an overview of the geologic setting and description of the deposits.

Much of the article is devoted to describing the important minerals: mainly emerald and other beryls, alexandrite, and chrysoberyl; but also topaz, euclase, and phenakite. The wealth of information is augmented by supplementary details, such as a list of the minerals identified so far (about 90 total), along with documentation of "giant emeralds," crystal drawings, and a facsimile of a report (dated 1842) on the original emerald discovery. The article is lavishly illustrated with color photographs of the emeralds and alexandrites, along with several mines and the surrounding landscape. As this entire November issue of *Lapis* is devoted to deposits in the Ural

Mountains, the reader will find additional information about the other gems (e.g., demantoid), gem deposits (e.g., Mursinka), geology, and history of this fascinating mountain range. RT

## INSTRUMENTS AND TECHNIQUES

**Fibre torches.** B. Neville, *Australian Gemmologist*, Vol. 19, No. 10, 1997, pp. 413–414.

In this article, the Gemmological Association of Australia Instrument Evaluation Committee evaluates portable illuminators produced by Linton Enterprises. The units are available in three sizes, and are used to backlight gemstones when sophisticated gemological testing equipment such as microscopes and other light sources is not available. Each illuminator consists of a fiber head, a focusable pocket flashlight, and a support base. A flexible plastic "fiber" (2–3 mm in diameter and 80 mm long) delivers a pinpoint source of light from the flashlight. A metal base supports the flashlight in an upright position, leaving the user's hands free to hold a loupe and manipulate the gemstone or tweezers. For optimum performance, the user is instructed to adjust the focus of the light beam to achieve maximum brightness.

The Committee found that, in conjunction with a 10 $\times$  lens, the Linton torches effectively illuminated internal features within test materials. The visibility of hard-to-see inclusions was enhanced by placing the end of the fiber against the stone. The fiber torch was also used effectively to backlight mounted gems for testing with a dichroscope and a handheld spectroscope. MD

## JEWELRY HISTORY

**Empires and emeralds.** F. Ward, *Lapidary Journal*, Vol. 51, No. 1, April 1997, pp. 34–38, 102–103.

This article, augmented by beautiful photographs of ancient to early 1900s jewelry, focuses on the geographic origin of emeralds in jewelry over the millennia. Cleopatra's Mines in Egypt were undoubtedly the dominant source of emeralds from Greco-Roman times (at least 330 BC) until the introduction of Colombian emeralds in the early 1500s. By today's standards, these Egyptian emeralds are of low quality: heavily included, almost never transparent, and of poor color. In fact, most should be classified as "green beryl." Although these mines operated for roughly 2,000 years, they never produced large quantities of gemstones. Egyptian emeralds and green beryls are found in pre-Colombian jewelry as far away as India. (See R. H. Jennings et al., "Emeralds and Green Beryls of Upper Egypt," *Gems & Gemology*, Summer 1993, pp. 100–115, for a modern description of the long-abandoned Cleopatra's Mines, and the gemological characteristics of these emeralds and green beryls.)

Following the Spanish conquests in the Americas, high-quality Colombian emeralds were so numerous that Spain exported them to other parts of Europe and to India. The fabulous emeralds referred to as "Old Mine" emer-

alds in post-Columbus jewelry of India, Persia, and Turkey are, in fact, Colombian emeralds, many of which Spain shipped directly across the Pacific, through its new colony in the Philippines. In addition to Colombia, today's major emerald-producing countries are Brazil, Zambia, Zimbabwe, Madagascar, Pakistan, Afghanistan, and Russia. MD

**Identifying period jewelry.** D. Pulese-Murphy, *JQ Magazine*, Vol. 71, June/July 1997, pp. 112–114, 116, 118, 120, 123.

Identifying and categorizing jewelry can be challenging. This article gives a basic overview of what must be understood and examined to accomplish such a task. The author describes stylistic elements, gemstones in vogue, and metals most commonly seen between 1837 and 1939, during the Victorian, Arts & Crafts, Art Nouveau, Edwardian, and Art Deco periods. The discussion is illustrated with photographs of characteristic pieces. Included are dates for each period and brief explanations about how the jewelry of each period originated and evolved. Although there is much more to learn, this article provides an interesting introduction to these unique styles and trends. JM

**Whalemen's work.** C. McCarthy, *Art & Antiques*, Vol. 20, No. 7, 1997, pp. 97–99.

This article offers a rare glimpse into the history and evolution of scrimshaw, plus insight into how the art form is evaluated. *Moby Dick*, published in 1851, helped bring the craft of scrimshaw to the fore. During the presidency of John F. Kennedy, demand for the art heightened when the president was photographed with his extensive personal collection. Due to the passage of the Marine Mammal Protection Act, which ended commercial whaling in the 1970s, scrimshaw is now produced using fossil ivory or imitation polymers. These materials create a dilemma for curators and dealers, who technically consider only hand-carved whale products as true scrimshaw.

Several artisans and collectors are profiled, and brief mention is made of basic testing for imitations, both natural (e.g., old teeth recently engraved using electric tools) and artificial (e.g., polymer copies cast from molds of the originals). JEC

## JEWELRY RETAILING

**Off the grid: Selling diamonds without papers.** K. Nestlebaum, *Rapaport Diamond Report*, Vol. 20, No. 25, July 4, 1997, pp. 15–16, 53.

Diamond grading reports define quality, and price lists set value. Or so goes the industry mantra linking commoditization of diamonds to shrinking profit margins. However, one option for jewelers feeling the price/quality squeeze is to sell stones that are "off the grid," that is, below a certain size and/or quality necessary to be sent to a grading laboratory for a certificate. These are the dia-



monds that comprise the price-point market where specific weight-for-price levels dominate and quality is secondary. While dealing in this market segment can offer some profit maneuvering room, it is not a panacea.

Consumers, in ever-increasing numbers, are becoming knowledgeable about diamond grades and are inquiring about specific quality factors. Therefore, whether or not they have laboratory reports, stones are represented in terms of their color and clarity. This trend leads to the conclusion articulated by one wholesaler that, "Once the grades are connected to the stone, the stone is connected to the price grid." This sentiment dilutes the effectiveness of selling stones "off the grid." In addition, consumers are becoming more quality-conscious and are more likely to demand a certificate as proof of a stone's value. SW

## PRECIOUS METALS

**Precious metals in May 1997.** *U.S. Geological Survey, Mineral Industry Surveys*, August 1997, 8 pp.

Although gold demand reached its highest recorded quarterly value in the first quarter of 1997, gold prices have been fairly low since then (e.g., below US\$320 per ounce in July 1997). At such prices, about 25% of the world's gold production is uneconomic to mine, and about half the world's gold deposits are uneconomical "if benefits derived from hedging were excluded." South Africa and Australia have the highest nationwide production costs, as their mines are among the oldest; newer mines generally have lower operating costs.

A new use has been found for silver: Automobile windshields coated with several layers of silver metal and oxides reflect 60% of the sun's energy, pass 70% of visible light, and also serve as AM/FM antennas. Additional information (e.g., import and export figures by country and an overview of world supplies) on gold, silver, platinum, and rhodium can be found on the U.S. Geological Survey's Web site at <http://minerals.er.usgs.gov/minerals>. MLJ

## TREATMENTS

**How to detect clarity enhancement in emeralds.** M. Johnson, S. McClure, J. Koivula, and T. Moses, *Modern Jeweler*, Vol. 97, No. 1, January 1998, pp. 58, 60, 61.

Although the filling of fractures that reach the surface of emeralds has been practiced in various forms for a very long time, recent interest has resulted from the development of new filling materials, improvements in filling technology, and high-profile advertising. Identifying specific fillers is time-consuming and difficult. Detecting the mere presence of a filler, however, is more important than knowing its actual composition. All emerald fillers have a refractive index very close to that of emerald, so fractures in treated stones become less visible as the air that

fills the breaks is displaced by the filling material. Because the filling procedures are never perfect, it is possible to detect them with a microscope.

First, the stone must be carefully examined for chips, fractures, and inclusions of any type that might cause problems during handling, and the surface of the stone must be cleaned with distilled water and/or isopropyl alcohol or acetone. [Editor's note: The stone should not be immersed in the latter fluids because they may dissolve the filling material.] Next, the following steps are recommended to detect evidence of filling: (1) use reflected light to find any fractures that reach the surface; (2) examine such areas in darkfield illumination to determine the visibility of the fractures below the surface (if a fracture seems to disappear below the surface, it is filled with something other than air); (3) look for the "flash effect"; and (4) in the fracture look for gas bubbles, voids, and evidence of deterioration (e.g., changes in color and transparency which occur over time with all the organic products used as emerald fillers). Notwithstanding the sequence briefly outlined above, there is no substitute for education and experience in knowing what to look for and how to interpret what is seen. MD

## MISCELLANEOUS

**Gemstones.** *U.S. Geological Survey, Mineral Industry Surveys, Annual Review 1996*, August 1997, 14 pp.

This annual survey is a treasure trove of statistical data on gemstone production worldwide, with a three-page text introduction. The U.S. produced about \$44 million worth of natural gem materials in 1996. (Unless otherwise specified, prices given are net wholesale in U.S. dollars.) This figure decreased by more than 10% from the previous year, mainly due to decreasing production of natural shell (used as nuclei for cultured pearl farming in Japan and elsewhere). Six states produced more than three-quarters of the natural gem materials: Tennessee (shell), Oregon, Kentucky (shell), Arkansas (shell), Arizona, and Alabama (shell). Diamond mining and exploration in the U.S. were noteworthy in 1996, with development continuing at the Kelsey Lake kimberlite in Colorado.

The U.S. market consumed \$4.3 billion in unset diamonds in 1996, and over \$370 million in unset colored stones (exclusive of pearls and coral). The most popular stones were diamonds (61%), emeralds (10%), sapphires (9%), and rubies (7%). The average price of rough diamonds sold worldwide was about \$70 per carat in 1996 (ranging from \$9 for Australian production to \$315 for Namibian stones), while cut but unset stones were valued on average at \$474 per carat (up from \$447 in 1995).

The U.S. imported gems from 106 countries and exported to 56. Rough diamond imports came from the U.K. (e.g., CSO sights), Belgium, Ghana, Zaire, and Australia (among others). Small cut diamonds were imported from India, Israel, and Belgium; and 0.5+ ct cut diamonds

came from Israel, Belgium, Switzerland, and India. The U.S. exported diamonds to Israel, Belgium, Hong Kong, Switzerland, and Japan. Diamond exports fell by weight but rose in value to \$2.23 billion (from \$2.04 billion in 1995).

Nearly 10 Mct (million carats) of fashioned emeralds were imported into the U.S. in 1996, worth \$203 million; by value, the most important sources for these cut gems were Colombia, India, Israel, Switzerland, and Hong Kong. Also imported were almost 6 Mct of fashioned rubies (from Thailand, Switzerland, Hong Kong, India, etc.), and 8.5 Mct of fashioned sapphire (from Thailand, Sri Lanka, Switzerland, Hong Kong, etc.). The average price per carat of imported emeralds was \$20.44 in 1996 (down from \$32.25 in 1995); rubies were valued at \$14.55 per carat (versus \$20.10 the preceding year) and sapphires at \$11.14 per carat (versus \$12.38 in 1995). The main source of "other" (i.e., not diamond, emerald, or corundum) gemstone rough was Brazil, while "other" cut stones came primarily from Thailand, Hong Kong, Japan, India, and Germany. Excluding pearl and coral, total colored stone imports for 1996 were valued at \$572 million. The U.S. exported \$29.1 million in colored stone rough, and about \$175 million in fashioned colored gemstones. The average value of imported colored stone rough exclusive of corundum and emeralds was about 12 cents per gram. The U.S. imported over \$34.6 million in natural, cultured, and imitation pearls and exported \$8.5 million in [unspecified] pearls. About \$38.6 million in shells and coral were exported and re-exported. Annual world production of cut natural gemstones exclusive of diamonds and pearls exceeded \$2 billion.

World diamond production in 1996 reached 117 Mct, with an estimated value of about \$7 billion. De Beers's CSO sold \$4.83 billion in rough diamonds, a new record, while retail diamond sales decreased slightly to \$52 billion, partly due to a weaker Japanese market. Argyle withdrew from the CSO in 1996. The first Canadian diamond mine is expected to go into production in late 1998.

Synthetic gem production from California, New York, Michigan, and Arizona totaled \$24 million. Production of gemstone simulants exceeded \$100 million. The U.S. imported \$109.2 million in synthetic and imitation stones (mainly from Austria and Germany), and exported \$29.5 million (including re-exports). The average synthetic import was valued at 23 cents per carat.

The article also includes tables of gemstone properties (with many of the same errors noted in earlier abstracts of this annual survey), synthetic gemstone production methods, and representative wholesale prices for diamonds and fashioned colored stones. Additional information (e.g., production, consumption, and value) on natural and synthetic gemstones can be found on the U.S. Geological Survey's Web site at <http://minerals.er.usgs.gov/minerals>. MLJ

**An image for all reasons.** D. Taranik, *Mining Magazine*, Vol. 177, No. 3, September 1997, pp. 158–160.

The costs of using remote sensing data for mineral explo-

ration, and the costs of analyzing such data, are rapidly decreasing. Remote-sensing techniques can now be applied on spatial scales, from field surveys with hand-held multi-band detectors to airborne and satellite-based systems. The newest satellite systems can achieve resolutions up to 1 m. These detectors analyze reflectance in narrow wavelength bands in the visible and infrared, and they have been calibrated to distinguish among common alteration minerals such as alunite, kaolinite, sericite, illite, and "free silica" (quartz or opal); these minerals are often useful for indicating the presence of associated ore deposits.

Another satellite remote-sensing technique, radar mapping, can be used to see topographic details in areas with dense forests or continuous cloud cover. Geographical Information System (GIS) technology can then be used to tie the various maps together. Quantitative evaluation techniques are now being applied to mining districts in order to produce maps of mineral potential.

Although these techniques are directed toward the search for metal deposits, geologists have also used many of them for years in gem exploration—particularly in the search for diamonds—without publicizing the fact.

MLJ

**Resources and reserves estimation.** G. Ferguson, *Mining Magazine*, Vol. 177, No. 3, September 1997, pp. 163–164, 167–168.

Although mining companies describe their holdings in terms of mineral resources [concentrations currently feasible to mine] and mineral reserves [identified resources that can be extracted profitably with existing technology], there is no universally accepted method of calculating either of these. This article is targeted to would-be investors in mining stocks, who should understand four factors before supporting a project: ownership and mining regulations, competence of the professionals, estimation of resources, and reserves engineering.

A successful mining venture has a clear legal title to the property in question, in accordance with local laws. The resources and reserves should have been defined by a competent geologist who has been involved in all stages of delineation of the ore body. With regard to resources estimation [determining how much ore is present and at what grade], the geologic model for describing the ore body should be accurate and plausible, reflecting known geologic conditions and employing appropriate statistical models to interpret ore grades based on available samples. In calculating the reserves, only proven and probable reserves should be considered (not "possible" or "inferred" reserves, which are less certain). Due to the need to excavate noneconomic material for access, both planned and unplanned "dilution" of ore grades should be taken into consideration. In the final analysis, the caliber of the professionals of the mining company can make all the difference in the decision to invest in mining stocks.

MLJ