

GEMS & GEMOLOGY

WINTER 2016
VOLUME LII

THE QUARTERLY JOURNAL OF THE GEMOLOGICAL INSTITUTE OF AMERICA



Jaipur's Gem and Jewelry Industry
The Earliest Gem-Quality Synthetic Emeralds
A New Source of Danburite from Vietnam
A Chart of Emerald Inclusions



pg. 351



pg. 371



pg. 394



pg. 409

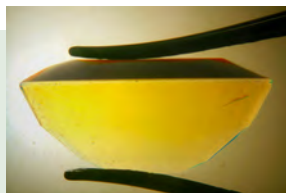

pg. 418

EDITORIAL

- 331 Emeralds and the Power of the Pink City**
Duncan Pay

FEATURE ARTICLES

- 332 Jaipur, India: The Global Gem and Jewelry Power of the Pink City**
Andrew Lucas, Nirupa Bhatt, Manoj Singhania, Kashish Sachdeva, Tao Hsu, and Pedro Padua

Examines Jaipur's role as a colored stone cutting and jewelry manufacturing center, with profiles of 17 companies and their factory, trading, and retail operations.

- 368 Synthetic Emeralds Grown by Richard Nacken in the Mid-1920s: Properties, Growth Technique, and Historical Account**
Karl Schmetzer, H. Albert Gilg, and Elisabeth Vaupel

Describes the chemical, morphological, and microscopic properties of the first gem-quality synthetic emeralds ever produced, offering a historical perspective on their development.

- 393 A New Find of Danburite in the Luc Yen Mining Area, Vietnam**
Le Thi-Thu Huong, Laura M. Otter, Tobias Häger, Tim Ullmann, Wolfgang Hofmeister, Ulrike Weis, and Klaus Peter Jochum

Reports on a recently discovered eluvial deposit of honey yellow danburite with excellent transparency.

CHARTS

- 402 Inclusions in Natural, Synthetic, and Treated Emerald**
Nathan D. Renfro, John I. Koivula, Jonathan Muiyal, Shane F. McClure, Kevin Schumacher, and James E. Shigley

Provides a visual guide to the internal features of natural, synthetic, and treated emeralds.

FIELD REPORTS

- 404 Update on Gemstone Mining in Northern Mozambique**
Wim Vertriest and Vincent Pardieu

Recounts an expedition to Mozambique's important deposits of ruby, spinel, and tourmaline, which have yet to be fully explored.

REGULAR FEATURES

- 410 Lab Notes**

Dyed green beryl • Coesite inclusions with filaments in diamond • Decay kinetics of boron-related peak in IR absorption of diamond • Spectroscopy of "gold sheen" sapphires • CVD synthetic diamond over 5 carats • Blue HPHT synthetic diamond over 10 carats • Mixing of natural diamonds in HPHT synthetic melee • HPHT-grown synthetic diamond with strain • Synthetic sapphire and synthetic spinel doublets • Laminated tortoiseshell scepter • Turquoise with simulated matrix

- 422 G&G Micro-World**

Quartz windows in chalcedony • Sphalerite inclusions in Namibian demantoid • Ferropericline inclusion in diamond • Apatite cluster in orthoclase feldspar • Curved tubes in blue sapphire • Designer inclusion in synthetic quartz • Quarterly crystal: Growth features on titanite

- 428 Gem News International**

Blue dravite-uvite tourmaline from Koksha Valley, Afghanistan • Sapphire rush near Ambatondrazaka, Madagascar • Trapiche-type sapphire from Tasmania • Two glass samples: Natural or man-made? • Imitation rubellite boulders • Color-change glass as a Zultanite imitation • "Decorated" jadeite jade in the Chinese market • Durability of a broken glass-filled ruby • Conference report • Errata

Editorial Staff

Editor-in-Chief

Duncan Pay
dpay@gia.edu

Managing Editor

Stuart D. Overlin
soverlin@gia.edu

Editor

Jennifer-Lynn Archuleta
jennifer.archuleta@gia.edu

Technical Editors

Tao Z. Hsu
tao.hsu@gia.edu
Jennifer Stone-Sundberg

Editors, Lab Notes

Thomas M. Moses
Shane F. McClure

Editors, Micro-World

Nathan Renfro
Elise A. Skalwold
John I. Koivula

Editors, Gem News

Emmanuel Fritsch
Gagan Choudhary
Christopher M. Breeding

Editorial Assistants

Brooke Goedert
Erin Hogarth

Contributing Editors

James E. Shigley
Andy Lucas
Donna Beaton

Editor-in-Chief Emeritus

Alice S. Keller

Customer Service

Martha Erickson
(760) 603-4502
gandg@gia.edu

Production Staff

Creative Director

Faizah Bhatti

Image Specialist

Eric Welch

Illustrator

Peter Johnston

Photographers

Robert Weldon
Kevin Schumacher

Video Production

Pedro Padua
Nancy Powers
Betsy Winans

Production Specialist

Juan Zanahuria

Multimedia Specialist

Lynn Nguyen

Editorial Review Board

Ahmadjan Abduriyim

Tokyo, Japan

Timothy Adams

San Diego, California

Edward W. Boehm

Chattanooga, Tennessee

James E. Butler

Washington, DC

Alan T. Collins

London, UK

John L. Emmett

Brush Prairie, Washington

Emmanuel Fritsch

Nantes, France

Eloïse Gaillou

Paris, France

Gaston Giuliani

Nancy, France

Jaroslav Hyršl

Prague, Czech Republic

A.J.A. (Bram) Janse

Perth, Australia

E. Alan Jobbins

Caterham, UK

Mary L. Johnson

San Diego, California

Anthony R. Kampf

Los Angeles, California

Robert E. Kane

Helena, Montana

Stefanos Karampelas

Basel, Switzerland

Lore Kiefert

Lucerne, Switzerland

Ren Lu

Wuhan, China

Thomas M. Moses

New York, New York

Aaron Palke

Brisbane, Australia

Nathan Renfro

Carlsbad, California

Benjamin Rondeau

Nantes, France

George R. Rossman

Pasadena, California

Andy Shen

Wuhan, China

Guanghai Shi

Beijing, China

James E. Shigley

Carlsbad, California

Elisabeth Strack

Hamburg, Germany

Fanus Viljoen

Johannesburg, South Africa

Wuyi Wang

New York, New York

Christopher M. Welbourn

Reading, UK

GEMS & GEMOLOGY®

gia.edu/gems-gemology

Subscriptions

Copies of the current issue may be purchased for \$29.95 plus shipping. Subscriptions are \$79.99 for one year (4 issues) in the U.S. and \$99.99 elsewhere. Canadian subscribers should add GST. Discounts are available for group subscriptions, GIA alumni, and current GIA students. To purchase print subscriptions, visit store.gia.edu or contact Customer Service. For institutional rates, contact Customer Service.

Database Coverage

G&G is abstracted in Thomson Reuters products (Current Contents: Physical, Chemical & Earth Sciences and Science Citation Index—Expanded, including the Web of Knowledge) and other databases. For a complete list of sources abstracting *G&G*, go to gia.edu/gems-gemology, and click on "Publication Information."

Manuscript Submissions

Gems & Gemology, a peer-reviewed journal, welcomes the submission of articles on all aspects of the field. Please see the Author Guidelines at gia.edu/gems-gemology or contact the Managing Editor. Letters on articles published in *G&G* are also welcome. Please note that Field Reports, Lab Notes, Gem News International, Micro-World, and Charts are not peer-reviewed sections but do undergo technical and editorial review.

Copyright and Reprint Permission

Abstracting is permitted with credit to the source. Libraries are permitted to photocopy beyond the limits of U.S. copyright law for private use of patrons. Instructors are permitted to reproduce isolated articles and photographs/images owned by *G&G* for noncommercial classroom use without fee. Use of photographs/images under copyright by external parties is prohibited without the express permission of the photographer or owner of the image, as listed in the credits. For other copying, reprint, or republication permission, please contact the Managing Editor.

Gems & Gemology is published quarterly by the Gemological Institute of America, a nonprofit educational organization for the gem and jewelry industry.

Postmaster: Return undeliverable copies of *Gems & Gemology* to GIA, The Robert Mouawad Campus, 5345 Armada Drive, Carlsbad, CA 92008.

Our Canadian goods and service registration number is 126142892RT.

Any opinions expressed in signed articles are understood to be opinions of the authors and not of the publisher.

About the Cover

In recent years, the Indian city of Jaipur has emerged as a cutting, manufacturing, and retail powerhouse. The lead article in this issue looks at the city's history and profiles some of its more prominent jewelers. The cover shows a bracelet created by Jaipur's Birdhichand Ghanshyamdas Jewellers. Inspired by the Amer Fort, a UNESCO World Heritage Site, the bracelet is comprised of canary diamonds, polki diamonds, and a stunning emerald at its center. Photo by Robert Weldon/GIA, courtesy of Birdhichand Ghanshyamdas Jewellers.

Printing is by L+L Printers, Carlsbad, CA.

GIA World Headquarters The Robert Mouawad Campus 5345 Armada Drive Carlsbad, CA 92008 USA

© 2016 Gemological Institute of America

All rights reserved.

ISSN 0016-626X



Emeralds and the Power of the Pink City



The theme of emerald unites three of our Winter issue's papers. First, lead authors Andrew Lucas and Nirupa Bhatt profile Jaipur's gem and jewelry industry. Renowned as a modern emerald cutting center, Jaipur has been a hub of jewelry craftsmanship since Jai Singh II founded the Rajasthani capital in 1727. Now the maharaja's city is a global powerhouse of jewelry design, manufacture, and retail, fusing traditional Indian design with a Western aesthetic to reach the market through innovative online retail and television shopping networks.

"A global powerhouse of jewelry design, manufacture, and retail..."

Our second paper, by Karl Schmetzer, H. Albert Gilg, and Elisabeth Vaupel, explores an early frontier of gem synthesis. The authors detail Prof. Richard Nacken's pioneering work and describe a previously unknown type of flux-grown synthetic emerald from the 1920s. Their paper is a valuable addition to the literature and a fascinating detective story, too.

Until recently, danburite was an underappreciated gem, but new sources are bringing this attractive yellow stone a larger audience. In our third paper, Le Thi-Thu Huong and her coauthors characterize a promising find of gem-quality danburite from Yen Bai Province, Vietnam.

Our fourth article returns to the emerald theme. We are proud to present a new wall chart illustrating some of the internal features of natural, treated, and synthetic emeralds. The chart, with contributions by inclusion specialists Nathan Renfro, John Koivula, Jonathan Muyal, and Shane McClure, provides a tantalizing look into the micro-world of emeralds.

Next, GIA field gemologists Wim Vertriest and Vincent Pardieu report on the latest developments in northern Mozambique, including the Montepuez ruby deposit and new discoveries of high-quality tourmaline and pink spinel.

I'd like to draw your attention to our three regular sections. Lab Notes includes entries on the largest near-colorless CVD-grown and HPHT-grown synthetic diamonds seen to date.

G&G Micro-World features a chalcedony containing more than a dozen clear hexagonal quartz windows, an iridescent ferropericlase inclusion in a diamond that might indicate a "superdeep" origin for its host, and a synthetic quartz crystal intentionally seeded with garnet inclusions.

Gem News International has something for everyone, including unusual tourmaline from Afghanistan, a new sapphire rush in Madagascar, and trapiche-type sapphire from Tasmania.

This issue also includes voting instructions for the Dr. Edward J. Gübelin Most Valuable Article Award. We had the best response ever to our 2015 reader ballot, so please do vote for your favorite 2016 articles. And don't forget to check out our additional online media content for the Jaipur article and this issue's Micro-World column.

Finally, we'd like to congratulate GIA post-doctoral research associate Evan Smith and his coauthors on their recent publication in *Science*—one of the world's top academic journals. Their paper on large type IIa diamonds suggests that these rare gems grew within liquid metal deep in the earth's mantle. It's a valuable contribution to understanding the origin of these big stones, which we hope to tell in a future issue.

Thank you for all your support through 2016. We look forward to the upcoming year in gemology!

Duncan Pay | Editor-in-Chief | dpay@gia.edu

JAIPUR, INDIA: THE GLOBAL GEM AND JEWELRY POWER OF THE PINK CITY

Andrew Lucas, Nirupa Bhatt, Manoj Singhania, Kashish Sachdeva, Tao Hsu, and Pedro Padua

In 2015, a field team from GIA visited the Indian city of Jaipur to capture the full scope of its gem and jewelry industry: colored stone cutting, wholesale trading, jewelry design, manufacturing, and retail. The authors documented the current state of the industry from a manufacturing as well as a business perspective. The results substantiated many of the team's prior assessments but also brought to light recent developments with far-reaching effects. The impact of vertical integration, consolidation, globalization, and jewelry television retail far exceeded expectations. Once known as a colored stone manufacturing center, Jaipur has rapidly climbed the value chain into jewelry manufacturing and retail by successfully incorporating experience and tradition with technology and innovation.

In the colored gemstone mine-to-market journey, there are major trading centers where rough is imported for cutting and then exported as finished stones. Each has its own attributes, niches, and challenges. Some of the hubs for colored stone manufacturing include China, Thailand, Sri Lanka, and Jaipur, India. The authors have visited all of these manufacturing and trading centers and studied them in detail. In late April and early May 2015, the authors visited Jaipur to examine its role as a colored stone cutting center and its more recent emergence as a modern jewelry manufacturing powerhouse (figure 1). This visit had the advantage of years of experience documenting such industries in the field, and a formula for gathering the information needed to understand the individual characteristics of that location as well as how it fits in the global picture.

The team spent 10 days in Jaipur touring 20 companies and documenting their factory, trading, and retail operations. Many of these were family businesses, and we were able to interview multiple generations in preparing case studies. The authors conducted numerous interviews with their ownership, management, and production crews and collected over 80 hours of video and more than 10,000 photos. Our approach to

understanding this dynamic colored stone center was to work with Indian trade organizations and industry leaders ahead of the trip to select as many companies as we could cover in the required time period and complete case studies on each one. The companies were chosen as representative of market sectors in the Jaipur industry, covering all the manufacturing and business aspects from traditional to modern. Like previous *G&G* reports on the gem and jewelry industries of China and Sri Lanka (Hsu et al., 2014; Lucas et al., 2014), the present article is largely based on these observations and interviews.

Members of the team who had visited Jaipur before came away with a different perspective of the industry there in some respects. Our impressions in Jaipur also completed a large part of the global colored stone picture. Gemfields' auctions from its Kagem mine have had a profound effect on the city's emerald industry. Indeed, we were surprised by the extent to which Zambia had overtaken Brazil as a supplier of emerald rough. Tanzania's restrictions on rough tanzanite exports were another influence, but smaller sizes were still very much available and had found a new customer in jewelry television networks. In fact, one of our biggest takeaways was how much television retail has affected Jaipur and the global industry.

The success of these shopping channels in the United States, the United Kingdom, Canada, Japan, and other countries has led to an enormous demand

See end of article for About the Authors and Acknowledgments.

GEMS & GEMOLOGY, Vol. 52, No. 4, pp. 332–367,

<http://dx.doi.org/10.5741/GEMS.52.4.332>

© 2016 Gemological Institute of America



Figure 1. Jaipur has a rich jewelry tradition. Today the city is a center for colored gemstone cutting as well as traditional, modern, and fusion jewelry manufacturing. Photo by Robert Weldon/GIA, courtesy of Motison Jewellers.

for all types of calibrated colored stones. This has greatly diversified Jaipur's colored stone cutting industry and expanded its scale of operations, with one factory cutting a million stones a month (N. Bardiya, pers. comm., 2015). As a result, some of these cutting companies have moved up the value chain into jewelry manufacturing. Many of these jewelry pieces are destined for television retailers and contain a variety of colored stones. In fact, one company was vertically integrated all the way to the end consumer, with its own television retail division reaching 100 million households, requiring approximately one million pieces of jewelry to be manufactured each month.

Another significant impression was Jaipur's blend of the modern and the traditional. State-of-the-art mass production is complemented by a cottage industry of individual artisans using centuries-old methods. Companies that once served the maharajas coexist with manufacturers for online retail and television shopping networks. From traditional *kundan meena* to fusion jewelry combining eras and styles, Jaipur has become a jewelry manufacturing center as well as a gemstone cutting center.

INDIA

In any major Indian city, one can feel the energy of an ambitious, rising economic power. At every socioeconomic level there is a distinct entrepreneurial drive and competitive spirit. With a population of ap-

proximately 1.3 billion, India is the world's largest democracy and the second most populous country, projected to overtake China in 2022 (Gladstone, 2015).

Although rich in history and tradition, India is a relatively new country. It gained independence from the United Kingdom in 1947 and became a republic in 1950. In the late 1980s, India began opening up to economic reform, trade, and foreign investment ("India country profile," 2015). The population is 72% Indo-Aryan and 25% Dravidian, with Mongoloid and others representing just 3% (The World Factbook, 2016). The most widely spoken language is Hindi, but there are 14 other official languages and more than 1,000 languages spoken in the country. While English is a subsidiary official language, it is the most important for international commerce. Hindus make up almost 80% of the population, with Muslims accounting for 14.2% and Christians, Sikhs, and other groups making up the rest (The World Factbook, 2016).

India's real GDP growth rate of 7.3% in 2015 placed it at 10th in the world. Forty-five percent of the country's GDP is in the services sector, followed by industry at 29.7% and agriculture at 17%. The country's estimated exports of US\$272.4 billion in 2015 ranked 20th in the world. India has an estimated labor force of 501.8 million, ranking second in the world in 2015 (The World Factbook, 2016).



Figure 2. Jaipur, capital of the northern Indian state of Rajasthan, is both a jewelry hub and a popular tourist destination. Amer Fort (inset) is a UNESCO World Heritage Site. Inset photo by Andrew Lucas.

Visiting India, one is taken aback by the architecture and the overload of vibrant colors. From palaces to saris to fruits and vegetables, India is a stimulation of the senses on a grand scale. This culture of color spreads to personal adornment and India's rich tradition of jewels and opulence, including colored gemstones and bold enamel colors. This is made abundantly clear in the French gem merchant Jean-Baptiste Tavernier's *Travels in India* (1676). Descriptions of the Great Moguls' seven thrones laden with diamonds, rubies, emeralds, and pearls offer a glimpse into the tradition of wealth and jewels in India.

JAIPUR

Jaipur is the capital of the state of Rajasthan in northwestern India (figure 2). Rajasthan has long been a strategic economic area because of its location on the trade route from China to Europe (Khullar, 1999). The city was founded in 1727 by Maharaja Sawai Jai Singh (known as Jai Singh II; see figure 3), the raja of Amer. Jaipur was India's first modern planned city, based on

traditional Hindu architecture. Access to water was a primary reason Jai Singh II moved his capital from Amer to this irrigated valley 11 km away (Khullar, 1999). The city was originally divided into nine blocks, two for state buildings and palaces and seven for the public. The old city's buildings were painted pink, the traditional color of hospitality, to welcome Queen Victoria and the Prince of Wales in 1876, and Jaipur is still known as the Pink City. It is a popular tourist destination, with such attractions as Amer or Amber Fort, which was designated a UNESCO World Heritage site in 2013 (again, see figure 2); Albert Hall; Hawa Mahal; Jal Mahal; City Palace; and Jantar Mantar. Some tourists come specifically to get married in local fashion, wearing traditional clothing and jewelry.

Figure 3. Maharaja Sawai Jai Singh (1688–1743) made Jaipur a thriving center for craftsmen, bringing in some of the region's finest jewelers during the early 1700s. Courtesy of Surana Jewellers.



THE GEM AND JEWELRY INDUSTRY IN JAIPUR

Almost at its conception, Jaipur became a city for skilled craftsmen who were drawn from around the region by Jai Singh II. These craftsmen included jewelers and stonecutters under the patronage of the maharajas. The jewelry they created embraced enameling and gemstones for magnificent colorful creations that were as carefully finished on the back as the front. The Johari Bazaar, one of the city's oldest markets (Conway, 2010), was commissioned by Jai Singh II and marked the start of the gem and jewelry industry in Jaipur. The bazaar is still home to many small workshops and emporiums. Jaipur has built upon this rich tradition, with today's entrepreneurs making the city a leading center for colored stone cutting and trading as well as modern jewelry manufacturing (figure 4).

The Gems and Jewellery Export and Promotions Council (GJEPC), formed in Jaipur by the Ministry of Commerce in 1966, works to promote the Indian

In Brief

- Similar to the diamond industry in Surat and Mumbai, Jaipur's colored gemstone cutting industry is moving up the value chain into producing finished jewelry.
- While Thailand and Sri Lanka are dominant players in the ruby and sapphire sector, Jaipur is a major global center for cutting and trading emerald, with the major source being Zambia.
- Jewelry manufacturing ranges from traditional handmade, one-of-a-kind kundan jewelry to large-scale mass production for television shopping channels.

gem and jewelry industry on behalf of some 6,000 exporters. During the organization's first year, Indian exports of gemstones and jewelry were US\$28 million. By 2014, that figure had risen to US\$35 billion (http://www.gjepc.org/about_us.php). Much of this growth could be attributed to polished diamond and diamond jewelry exports, which far exceeded those of colored stones and colored stone jewelry (R. Jain, pers. comm., 2015).

Determining the total number of people working in the Jaipur gem and jewelry trade is difficult. The sector includes the city's organized gemstone cutting and jewelry factories, as well as surrounding areas and a sizable cottage industry where families and households do contract manufacturing. The leaders we interviewed agreed that the figure is over 200,000, and some estimates put it closer to 300,000, with around 150,000 involved in the gemstone cutting sector.

In 2012, Gold Souk opened in Jaipur, with 95 showrooms and 150 offices featuring the city's leading jewelers ("Gold Souk opens in Jaipur," 2012). The souk caters to the flourishing tourism industry, offering a variety of jewelry styles to those visiting the city. The Jaipur Jewellery Show (JJS), held in December, attracts around 30,000 visitors annually to the Jaipur Exhibition and Convention Center (<http://10times.com/jjs>). The show, which started in 2003 with only 64 booths, features more than 700 vendors and includes finished jewelry and loose stones, and in 2015 it unveiled a new brand ambassador, Bollywood actress Amrita Rao ("Film actress Amrita Rao...," 2015).

Jaipur's gem and jewelry exports from April 2014 through March 2015 totaled more than US\$574 million. Within that total, the largest category was colored gemstones at more than US\$264 million. It is notable that finished gold jewelry was US\$112.5 million and non-gold jewelry US\$145 million (see table 1).

COLORED GEMSTONE INDUSTRY

In Jaipur there are at least 100 factories cutting colored gemstones. There is also a huge cottage industry of artisan cutters working on a contract basis (R. Jain, pers. comm., 2015). The industry is in many ways a complementary blend of traditional artisans in the cottage industry and large factories that employ thousands. Some of the large modern factories also contract their cutting work to the artisan cottage industry to expand their production capabilities when needed.

Figure 4. This modern jewelry factory creates traditional, contemporary, and fusion jewelry in a wide range of materials and price points. Photo by Andrew Lucas, courtesy of Amrapali.



TABLE 1. Jaipur gem and jewelry exports, 2010–2015 (in millions of U.S. dollars).

| | April 2010 to March 2011 | April 2011 to March 2012 | April 2012 to March 2013 | April 2013 to March 2014 | April 2014 to March 2015 |
|---------------------------|-----------------------------|-----------------------------|-----------------------------|-----------------------------|-----------------------------|
| Cut and polished diamonds | 23.0835 | 20.343 | 21.972 | 24.5715 | 18.606 |
| Gold jewelry | 74.529 | 79.932 | 88.359 | 118.221 | 112.506 |
| Colored gemstones | 186.6285 | 239.196t | 219.2505 | 276.111 | 264.834 |
| Pearls | 0.0135 | 0.012 | 0.072 | 0.735 | 0.0675 |
| Non-gold jewelry | 112.548 | 121.599 | 132.1185 | 146.244 | 145.158 |
| Costume fashion jewelry | 3.0855 | 6.7185 | 11.043 | 10.647 | 11.9205 |
| Raw synthetic | 0.0045 | 0.009 | 0.009 | 0.021 | 0.039 |
| Rough diamond | 0.051 | 0 | 0 | 0 | 0 |
| Rough colored gemstones | 3.045 | 11.6025 | 8.0775 | 12.015 | 20.037 |
| Synthetic stones | 0.3855 | 0.4335 | 0.918 | 1.4775 | 1.5405 |
| Total | 403.374 | 479.8455 | 481.899 | 590.043 | 574.7085 |

Source: GJEPC

Note: U.S. dollar amounts have been converted from Indian crore rupees (one crore equaling a quantity of 10 million) with November 2015 exchange rates.

While Thailand and Sri Lanka control the global corundum cutting industry, Jaipur excels in many different colored gemstones, particularly emerald. The impact of television retailers and their jewelry manufacturers has been significant, driving demand for a variety of colored gemstones, including large volumes of calibrated sizes. If the supply of one type of gem diminishes, others that are available can be cut and marketed through television. With this constant demand, Jaipur's rough buyers are purchasing a wide range of colored gemstones from sources all over the world.

Jaipur has been cutting Zambian and Brazilian emeralds for decades. Now much of the industry focus is on the Zambian supply, and the Gemfields auctions of that production have revolutionized the emerald cutting industry in Jaipur. The consistent supply of accurately graded parcels through regularly scheduled auctions has made it easier to plan for customer demand for finished stones. This benefit does come with the challenge of auction competitiveness and shrinking margins for the Jaipur cutters.

Since the 1980s Jaipur has been a major cutting center for tanzanite. Rough tanzanite export restrictions imposed by the Tanzanian government in December 2010 dramatically changed the face of tanzanite cutting in Jaipur. Some companies found it better to diversify into different colored gemstones, while others primarily focused on producing smaller calibrated tanzanites from the rough available to

them. These smaller calibrated goods have a ready market from manufacturers creating jewelry for television shopping.

The Emerald Trade. The authors visited three emerald cutting factories in Jaipur. Two were manufacturing partners of a U.S.-based wholesaler but cut goods for different market sectors: one higher-quality and one more commercial-quality. Both companies source emerald rough and cut stones from Zambia, Brazil, and Colombia. The rough is cut at their own manufacturing facilities and through partners in Jaipur. The wholesale firm they work with, Real Gems, Inc. of New York City, is a family business with over 40 years in the emerald industry. Real Gems sells a wide variety of sizes and qualities, from precision-calibrated 1 mm rounds to untreated stones over 50 carats (figure 5). With offices in New York, Hong Kong, Dubai, Bangkok, and Europe, they strive to fill any emerald order from customers within 48 hours (S. Shah, pers. comm., 2015). The third company we visited cuts and sells its goods to foreign buyers in Jaipur. All three have slightly different rough procurement models, buying strategies, and customer bases. Together they represent significant strategies of the Jaipur emerald industry as a whole.

Multigem Creations. Multigem Creations started over 25 years ago and developed a business similar to that of other companies in the Jaipur emerald trade.



Figure 5. From large, high-quality beads to cabochons and faceted stones, Real Gems sells a wide range of cutting styles. These examples were displayed at the Tucson gem shows. Photos by Tao Hsu, courtesy of Real Gems, Inc.

The company first started buying emeralds from Bahia, Brazil, especially the Socotó mines, when large amounts of rough were available. Much of it consisted of cabochon, tumbled, and lower-clarity facet qualities. By 1990 and 1991, Multigem was producing 20,000 carats of finished goods per month. As production from Bahia declined, the company shifted its focus to Zambian emerald. By 1998, it was purchasing Zambian rough almost exclusively. Multigem continued to specialize in more-included commercial qualities with the Zambian rough, while preparing to move up to middle-market and higher-quality material. Over the next decade, the company abandoned the lower-quality commercial market.

With the shift to higher-quality material, the production of finished goods dropped from 20,000 carats to about 5,000 carats per month by 2005. Today that figure is 1,500 to 2,000 carats per month, but in higher qualities. This is because higher-quality material takes more time to evaluate and cut. Top-quality material also requires larger capital, and availability is limited. But Multigem's total revenue has increased, and the price for better-quality Zambian rough and cut stones has doubled over the last six to seven years (N. Dugar, pers. comm., 2015). Still, the profit margins have been continuously squeezed as the cost of manufacturing and doing business has increased, even though far fewer employees are needed.

The company, which had a staff of 50 when it produced lower-quality material, has about a dozen employees today. The cutting staff consists of about seven master cutters, each with 20 to 48 years of experience. Company partner Naresh Dugar believes that becoming a skilled emerald cutter requires a minimum of 10 years' experience, especially to work with better-quality material. He says that a cutter needs to see a large amount of rough to make the right decisions on planning the cut, sawing, preforming, and faceting (figure 6). With emerald in particu-

lar, color zoning, inclusions, and fissures must be balanced with shape, weight retention, and how the stone will respond to clarity enhancement.

The manufacturing team pools together its knowledge to discuss the cutting of important pieces of

Figure 6. At Multigem, management takes an active role in sawing and preforming decisions. The less experienced cutters perform the faceting. Photo by Andrew Lucas, courtesy of Multigem Creations.



rough, so there can easily be at least 100 years of combined experience looking at a single stone. The company's years of cutting lower- to medium-quality emeralds prepared it to move up to fine-quality rough. While it is not always easy to move finished emeralds in today's market, Mr. Dugar noted that better-quality material is more appealing and marketable, almost always selling within a few months.

When Multigem started buying Zambian rough, the supply was consistent but the available lots had an undesirable mix of qualities and sizes. The quality within a rough lot might range in value from US\$1 to US\$1,000 per gram. This mixture made it difficult for manufacturers to focus on the quality needed for their business models.

Multigem no longer purchases rough primarily in the Zambian open market. About 60% of their rough comes from the Gemfields auction and 40% from local traders or Zambians who come to Jaipur to sell. The Gemfields auction system has made buying emerald rough much easier in the sense that the lots are very well organized by size and quality. Another important advantage is that the same quality grades are available from one auction to the next, allowing for better business planning. Thus, Multigem is able to provide consistent supply to customers over the years. At the same time, the auctions are very com-

petitive. Anyone buying emerald rough at these auctions must have considerable experience and market knowledge, especially for higher-quality lots.

Multigem Creations is one of the companies that partners with Real Gems, the New York-based global emerald wholesaler, which has a strong customer base in the United States. Multigem also sells to local buyers in Jaipur. The company produces large faceted free-size stones, as well as calibrated faceted stones, cabochons, and tumbled stones. It focuses on better qualities for all types of cut material.

The authors observed an example of a common business decision in Jaipur: whether to cut a 250 ct piece of rough into a faceted stone or matching tumbled stones (figure 7). The matching tumbled stones would easily total more than 50 carats; at 20,000 rupees per carat, they might sell for a total of one million rupees. A 20 ct faceted stone might also be produced, but much of the depth of color would be lost due to color zoning and the emerald's brightness would be hindered by inclusions. Faceted stones typically sell for more per carat, all things being equal. In this case, Mr. Dugar estimated that the faceted stone would also sell for 20,000 rupees per carat due to the loss of color and therefore bring only 400,000 rupees—600,000 rupees less than the matching tumbled stones. Understanding the nature of the crystal's color zoning, the effect of inclusions on brightness, and the potential to create very marketable matching tumbled pairs factored into the final decision. In the end, we saw the cutting of two matching tumbled pieces for earrings plus a matching tumbled stone for a pendant, creating a suite weighing 91.10 carats total (figure 8). Multigem was also able to retrieve a lower-quality 70 ct cabochon-grade stone from the same piece of rough, making the decision to go for tumbled stones a very successful one.

Mr. Dugar said that while buying individual stones is a gamble tempered with experience and skill, buying a lot is not as risky. Many of the stones will work out as expected—some better and some worse—but in the end it will balance out for a profit.

Samit Emeralds. This company specializes in commercial-quality faceted stones. During our visit, owner Samit Bordia explained why most emerald cutting factories in Jaipur do not use high-tech equipment and computerized cutting. With stones like citrine, blue topaz, and almandine garnet, factories do incorporate automated cutting. But emerald involves so many considerations throughout the cutting process that it is not economically advantageous to use tech-

Figure 7. The authors observed the entire decision-making and cutting process for matching tumbled stones. While there was an initial plan, it was often modified as the emeralds were preformed. Photo by Andrew Lucas, courtesy of Multigem Creations.





Figure 8. The business decision to create either lower-quality faceted stones or top-quality tumbled stones is based on the total value recovered from the rough as well as the available market for the different styles of material. Photo by Andrew Lucas, courtesy of Multigem Creations.



Figure 9. Samit Emeralds acquires large amounts of rough from Zambia, like the material in this photo, and to a lesser extent Brazil. Photo by Andrew Lucas, courtesy of Samit Emeralds.

nology. The key to emerald cutting, Bordia told us, is the experience and knowledge of the cutter. That is one of the main advantages of the Jaipur industry.

At Samit Emeralds, we saw commercial-quality Brazilian and particularly Zambian rough (figure 9). Mr. Bordia buys rough from Bahia in qualities usually ranging from US\$5 per kilogram to \$100 per gram. We also saw some lower-quality Bahia rough selling for US\$1,500 per kilo that would cut faceted stones selling to jewelry manufacturers for US\$3 to \$20 per carat. Mr. Bordia said that Jaipur's emerald cutting factories usually focus on certain market sectors for finished emeralds. He noted that the quality of material from Bahia has been low, even though the quantity has been sufficient, so Samit Emeralds has not been buying heavily from Brazil.

The company purchases Zambian emerald rough from the Gemfields auctions and from Zambian miners in the town of Kitwe. Mr. Bordia has observed that approximately 90% by weight of the Gemfields auction lots are cut in Jaipur, whether the buyer is local or from the U.S. or Hong Kong.

Most of the Zambian material Samit Emeralds buys is slightly more bluish than the Bahia material, but the colors range from bluish green to slightly yellowish green. Mr. Bordia finds that the more bluish Zambian stones tend to exhibit a stronger structure when cutting, adding that they have more luster and higher clarity.

Mr. Bordia finds the assortment and grading of lots from the Gemfields auctions superior to what is offered from Bahia or from other Zambian sources, even in lower commercial qualities. Colombian rough is

sometimes available in lower commercial qualities for Jaipur buyers, but comparably priced Zambian material has a better depth of color. In fact, Mr. Bordia estimates that Bahia and Zambia account for 90% of the rough cut in Jaipur, with material from Colombia, other Brazilian mining areas, Afghanistan, and Pakistan making up the rest.

The exact proportion of Brazilian and Zambian rough cut by Samit Emeralds depends on mine production. In 2012, when Bahia was enjoying a large production of good commercial-quality material, 75% of the company's rough inventory by weight came from there. In terms of value, the proportion was 30% Bahia and 70% Zambia. The quality of Bahia emerald has been declining, so now the Zambian supply represents 90% of the value, while the weight percentages have not changed as dramatically. Mr. Bordia pointed out that many of the commercial-quality emerald manufacturers in Jaipur face the same situation.

Samit Emeralds purchases rough and produces cut stones based on customer orders for specific sizes and qualities. Like Multigem Creations, the company works with Real Gems of New York. The U.S. is an important market for Samit, with manufacturers and jewelry television networks buying the full range of their commercial-quality material through Real Gems.

As a general rule, Samit Emeralds' planners saw or slice the stone if an inclusion occupies more than 20% of the crystal; if less, they grind the stone. Any remaining black schist is ground away after sawing. The goal is to combine maximum weight retention



Figure 10. By purchasing well-sorted rough at auction, Green International can produce consistently graded parcels of faceted emeralds. Photo by Andrew Lucas, courtesy of Green International.

with maximum inclusion removal during sawing or grinding. If the emeralds are sawn, there will be pieces ready for preform and pieces that will be sawn again before preforming to remove remaining black schist or included areas.

Luster and brilliance are evaluated to decide whether the stone will be faceted or fashioned into a cabochon or tumbled piece. The sorting of facet grade versus cabochon grade versus bead or tumbled grade varies by manufacturer. Samit Emeralds tends to facet a higher percentage of lower-quality material, while some manufacturers in Jaipur have a market for very clean, high-quality cabochons, tumbled stones, and beads.

After preforming, the stones are grouped by color and clarity grades into parcels of preformed stones varying in size and shape before moving to faceting and then the final polish. For calibrated goods the preform dimensions are usually at least 0.2 mm larger than those of the finished stone. If a 6×4 mm oval is

required, the preform size is 6.2×4.2 mm minimum. Mr. Bordia estimates a 30% weight loss from preform to faceted stone. Crown height and pavilion depth percentage tolerances are kept to ensure that the calibrated stones do not vary more in weight than customers will accept, while also maintaining standardized proportion appearance standards.

Over the years, Samit Emeralds has kept detailed records of all the rough lots it purchases, the preforms created, and the number of final cut stones. This has helped them estimate the weight of finished goods within a couple of percentage points for the rough lots they buy. If the weight estimation is off by more than 2%, they adjust their buying prices for the next similar lot on the market. When asked about the movement toward beneficiation and mining companies cutting their own rough to move up the value chain, Mr. Bordia felt that Jaipur's expertise in cutting emerald and its competitive labor costs would ensure a continuous flow of rough for decades to come.

Green International. Ramdas Maheshwari of Green International estimates that 99% of their emerald rough comes from the Gemfields auctions. This second-generation company has been in the emerald cutting business for more than 40 years. Mr. Maheshwari agrees that the Gemfields auctions have changed the whole dynamic of the Jaipur emerald industry (figure 10). Since they began buying regularly at auction and receiving well-sorted and graded lots, their ability to turn over their inventory has increased by five times. Green International does not base buying and manufacturing decisions on pre-orders from customers. Instead, they research the kinds of goods selling in the market, buy them for the best value at auction, and cut them for the best quality and weight to sell in the Jaipur market. Their selling prices start at US\$200 per carat for finished stones and can reach tens of thousands of dollars per carat. The sizes range from 2.5 mm rounds to large free-size stones.

Green's minimum parcel for calibrated stones is about 500 carats. The percentage of calibrated goods vs. larger free-size goods they manufacture depends on what is available at auction. When the company cut Brazilian material, 90% of the manufacturing was calibrated goods. Now that they deal almost exclusively with Zambian material, they cut a higher percentage of larger free-size material. Green International also sells to manufacturers in layouts and suites, but their main customer base consists of wholesale traders from around the world.



Figure 11. Tradition and skill outweigh technology at Green International, as these preformers prefer complete hand control over the emerald and the speed of the wheel for large free-size and calibrated stones. Photos by Andrew Lucas, courtesy of Green International.

Green International has 50 employees and does not outsource any of its cutting. Green's experienced cutters use traditional bow-powered laps for preforming, which gives them better control of the emerald rough (figure 11) and a higher weight yield. They also like being able to feel the emerald in their hand while controlling the speed of the preform with the bow in their other hand. Green International's cutters said they get about 2% more weight retention using the bow-powered cutting laps for preforming and hand-controlled jam pegs for faceting.

The Tanzanite Trade. When demand for emerald slowed in the latter half of the 1990s, the resilient Jaipur industry diversified into other colored stones such as tanzanite (Aboosally, 1997a). Nirmal Bardiya of RMC estimates that Jaipur cuts 90% of all tanzanites 1 gram and under (a figure confirmed by other sources), but the value percentage is smaller due to Tanzanian export restrictions that require facet-grade rough larger than 1 gram to stay in country for fashioning. When author AL visited Jaipur in 2007, a significant percentage of large, high-quality tanzanites were being cut there. At the time of our recent visit, there were more than 50 companies in Jaipur cutting tanzanite (A. Gokhroo, pers. comm., 2015). We mainly saw smaller calibrated stones, most under a carat.

The increase in gemstone sales to jewelry television networks has softened the impact of the rough restrictions, since the smaller calibrated sizes now being cut in Jaipur are a perfect match for the pieces being manufactured for television.

AG Gems. From the time it was established in 1991, AG Gems has purchased rough colored stones from East Africa. In the early 1990s, the company bought rough ruby and tanzanite in Nairobi. By the mid-1990s, AG Gems found that Arusha, Tanzania, was a better place to source tanzanite and began purchasing from dealers who bought the stones from Maasai tribesman.

Today AG Gems is one of the ten sightholders listed by TanzaniteOne, which operates in a manner similar to the De Beers supplier of choice system. For AG Gems, the fixed-price rough lots from TanzaniteOne are well graded, sorted, and organized, making it easy to calculate costs and profit margins. The company also buys an equivalent amount of rough on the open market from other miners and dealers in Tanzania. The rough supplied by Arusha's independent dealers has become very well graded, as opposed to the mixed lots and mine runs they supplied several years ago.

AG Gems has seen wide fluctuations in supply and prices. Today's prices are stabilized, as the miners and dealers control the material offered for sale to better meet the demand. Director Arun Gokhroo says the company's best period in the tanzanite business was around 2012 through 2013, when Chinese demand exploded but then cooled. Now their main market is once again the United States. AG Gems sells to wholesalers and jewelry manufacturers, but perhaps their most important customers today are television shopping networks and the manufacturers that make their jewelry.

Mr. Gokhroo feels that tanzanite is now a mainstream colored stone like the "Big Three," and al-

though supply has fluctuated it can still meet large-scale demand. Eighty percent of the company's business is now in tanzanite, with other Tanzanian stones like spinel, rhodolite, spessartine, and tsavorite making up the remaining 20%.

AG Gems, like RMC, has been affected by the size restrictions on rough exports from Tanzania, especially for smaller sizes, with Arusha as the cutting center for facet-grade rough over one gram. For larger rough, AG Gems and other Jaipur cutters can only obtain cabochon- or bead-quality material, which Tanzania does not subject to the same export restrictions as facet-quality material.

Mr. Gokhroo said his cutters and those of other companies in Jaipur have become expert at finding the transparent areas in these larger, lower-quality rough tanzanites and cutting faceted stones out of them (figure 12). AG Gems buys them on the open market in Arusha. These goods only yield between 2% and 5% weight retention for faceted stones, while in rough sizes under one gram they retain an average of 25% to 30% after faceting.

AG Gems primarily sells calibrated sizes, of which the most common are 4 × 6 mm to 6 × 8 mm. The smallest fancy shapes are 3 × 4 mm ovals and rounds down to 3 mm. Their customers typically allow a 0.2 mm size tolerance. Most are oval shapes, which have the best weight retention and highest demand. Most of the rough AG Gems now buys has already been cobbled in Tanzania. The rough stones are oriented for weight retention, but retaining color in small sizes is very challenging (A. Gokhroo, pers. comm., 2015).

AG Gems heat treats its rough in Jaipur. First the rough is preformed to remove potentially damaging inclusions, then heated, and then faceted and polished. Based on years of experience, the heaters can easily judge the color that will be produced. The stones are placed in a crucible inside an oven for 1.5 hours, until the oven reaches a temperature between 600° and 700°C. Then the stones are left at that temperature for half an hour, and the oven is cooled down for eight hours before removing the stones. No powders, chemicals, or fluxes are used.

From preform to calibration, the tanzanites generally lose 10% to 20% of their weight. After faceting they lose another 25% to 30%. After calibration they are usually 0.3 mm larger than the desired size, so they can lose a very slight amount of size (usually 0.2 mm) during faceting (figure 13). With the tight margins for tanzanite today, knowing how to evaluate the rough for weight retention and quality in the finished stones is critical for AG Gems.

M&M Gems. Although it specializes in cutting calibrated tanzanite and emerald, M&M Gems started cutting tanzanite in 2000. Approximately 80% of the finished stones are tanzanite and 20% emerald, but the value is a 50-50 split. At the time of our visit, the production was 150,000 stones and 25,000 carats of tanzanite a month. To give an idea of the production volume and speed, each preformer handles at least 400 stones a day (figure 14).

At the factory, we followed the entire process from rough grading and preforming to calibration and

Figure 12. With its expertise in evaluating tanzanite rough, AG Gems can buy larger cabochon-grade pieces and cut transparent areas for large faceted stones. Part of evaluating the rough is observing its pleochroism and finding the more valuable intense bluish and purple color directions. Photos by Andrew Lucas, courtesy of AG Gems.





Figure 13. From untreated rough in sizes under one gram (left) to preforms that have been heated (center) and precisely calibrated finished stones (right), AG Gems must accurately estimate the final appearance and weight at each stage. Photos by Andrew Lucas, courtesy of AG Gems.

faceting. Each stone could be completed in about two hours. The smallest size of rough M&M manufactures (approximately 0.1 gram) had about 6% weight retention, while the larger sizes (1 gram) retained about 25%. Most were cut as rounds and ovals, with other shapes cut to order. As with AG Gems, their calibration tolerance is 0.2 mm.

The company buys rough from dealers in Tanzania and in the domestic Jaipur market. The supply of tanzanite has fluctuated over the years, but the focus on smaller sizes in manufacturing is due to the Tanzanian restrictions (figure 15).

For most tanzanite rough, M&M follows a heat treatment process similar to that of AG Gems, heating the rough after preforming (though we did see some lighter-color rough being heated before preforming). No time is wasted preforming material that might not

have sufficient color quality for faceting, even though this leads to a higher percentage of stones that burst from preexisting fractures in the rough.

M&M classifies its tanzanite qualities according to standard terminology for the global trade. Colors are separated by tone and saturation into A, A+, AA, AA+, AAA, and the finest grade of AAA+. For stones with the same size, the spread in price from A to AAA+ can be as much as 300%. The grades are set according to M&M's master stones, which are chosen to match the grading of global customers. Many of these customers are wholesalers, manufacturers, and jewelry television networks.

Large Manufacturers and Bead Making. Even though emerald and tanzanite are two of the most important stones commercially, the Jaipur industry cuts a wide



Figure 14. M&M Gems has a traditional Jaipur factory where preformers prefer to work sitting on the floor. Each preformer averages 400 stones a day. Photo by Andrew Lucas, courtesy of M&M Gems.



Figure 15. While the facet-grade tanzanites available to MeM Gems are under one gram in size, the company still has an extensive rough sorting system for shape, color, and clarity that provides consistent quality ranges for cut stones. Photo by Andrew Lucas, courtesy of MeM Gems.

range of material. Many varieties, including nontraditional options such as yellow scapolite, are fashioned into assorted shapes and sizes. Some of these companies operate on a massive scale, cutting the full spectrum of gems, while others specialize in a few stones based on market demand.

RMC. Since its founding in 1991 in Bangkok, RMC has been involved in cutting and trading all types of colored stones. The company now cuts in China and in Jaipur, where the main production takes place. With sales offices in Bangkok, Hong Kong, and Japan, RMC refers to itself as a supermarket for all colored gemstone needs. The company manufactures and sells more than 100 varieties of colored stones in a wide range of shapes, sizes, and qualities. It specializes in colored gemstones outside the classic “Big Three.”

RMC purchases rough colored stones from sources around the world to cut and sell in major markets. It has not ventured into finished jewelry. The company employs more than 5,400 people directly and indirectly to accommodate the huge production requirements of one million stones per month. Ninety-seven percent of its business is in cutting natural and treated gemstones, with 3% consisting of synthetics and imitations (N. Bardiya, pers. comm., 2015).

RMC produces stones in calibrated sizes (figure 16), from 1 mm rounds to 12 × 15 mm fancy shapes. Rounds usually reach 10 mm in size, and fancy

shapes usually start at 3 × 4 mm. Their process involves handheld preforming and calibration machines that set the size and measurements. While RMC started out focusing on beads, today they produce mainly faceted stones.

RMC exhibits at major trade shows in China, Hong Kong, Bangkok, Japan, the United States, Switzerland, and Germany every year. Currently most of its business is in Asia. The company's primary customers include other wholesalers, jewelry manufacturers, jewelry television networks, retail chains, and Internet retailers. The customer base has changed dramatically in the last five years.

Before 2010, RMC sold to numerous smaller companies in US\$5,000 to US\$100,000 orders. The consolidation of the colored gemstone industry forced many smaller companies out of business. RMC now sells to fewer companies, but these clients place larger orders. RMC finds that the smaller manufacturers and wholesale customers cannot get enough regular orders to stay in business today.

In recent years RMC has seen changes in China, its largest market. At one time, China's appetite for colored stones caused rough prices for RMC to rise more than 300% over just a few years as demand outpaced supply from the mines. For RMC, the slowdown in the Chinese market has not caused a drop in colored gemstone prices but rather price stabilization, as demand has become more in line with supply, even though the rough supply is still very tight.

China demands bright and clean material from RMC in a variety of colored gemstones for its domestic market. RMC's quality requirements are narrower

Figure 16. RMC specializes in calibrated gemstones. Photo by Andrew Lucas, courtesy of RMC.





Figure 17. Numerous calibrated preforms are placed on a computerized faceting machine for final calibration, faceting, and polishing at RMC. Photos by Andrew Lucas, courtesy of RMC.

in China than in the U.S. market. The Chinese buyers have paid strong prices to RMC for the quality they require. Japan and Europe also have more stringent quality requirements than the U.S. However, Chinese jewelry manufacturers exporting to the U.S. buy a wide range of qualities. When the U.S. market is strong, as it was during our visit, it is a great advantage for RMC, which can move all quality ranges and price points there. Meanwhile, Italian manufacturing companies are again becoming important customers.

As with other companies in Jaipur, television shopping networks from the United States, Europe, and Japan have been major buyers of colored gemstones in a wide range of sizes and qualities. RMC is focusing on television retail, which has a very fast turnover and buys in large quantities. The company can sell full productions of all sizes and qualities to a variety of shopping channels catering to different market sectors. RMC also sees potential opportunities for television retail in China, where it can sell loose colored stones directly to the Chinese shopping channels, which provide them to their own jewelry manufacturers. RMC can also supply stones to China through jewelry manufacturers in Jaipur.

Nirmal Bardiya, one of the company founders, foresees a great future for Jaipur: "The children of the leaders of the colored gemstone industry are moving toward vertical integration and up the value chain into colored gemstone jewelry manufacturing." As Mr. Bardiya has seen the quality of cutting improve greatly over the last 10 years, opening up new markets, he has also observed dramatic improvement in

jewelry manufacturing. He is investing in automation and computer-controlled cutting (figure 17) to meet the anticipated growth in demand. At the same time, he expects continued demand for Jaipur's highly skilled but very affordable cutting labor (figure 18).

Mr. Bardiya does foresee some challenges ahead. To be more competitive with Thailand and Sri Lanka, Jaipur must improve its heat treatment technology and its skill in cutting and trading ruby and sapphire. He has also felt the effects of source-country legislation on exports of tanzanite and Ethiopian opal. While

Figure 18. Faceting colored gemstones by hand is still highly effective, even when a million stones per month are required. Photo by Andrew Lucas, courtesy of RMC.





Figure 19. At Sambhav Jewels, parcels of cobbled and heated blue apatite rough from Madagascar await faceting into calibrated cuts. Photo by Andrew Lucas, courtesy of Sambhav Jewels.

he expects such restrictions on rough exports to increase, he predicts strong growth potential throughout the Jaipur industry.

Sambhav Jewels. At the time of our visit, Sambhav Jewels was cutting apatite purchased from Madagascar (figure 19), fire opal from Mexico, morganite from Madagascar and Brazil, and chalcedony and quartz from Brazil and other sources. While the fire opal is mostly obtained in Mexico, morganite, apatite, and other gems are typically purchased from mine representatives in Bangkok.

During our visit, 80% of the production (figure 20) was for morganite and fire opal; apatite from Madagascar was also being cut, to a lesser extent. In addition,

Sambhav cuts synthetics and imitations to order. We saw fire opal separated into color grades from light orangy yellow through dark reddish orange. Demand for morganite has been exceedingly strong, especially from China, and Sambhav Jewels has focused on this gemstone for the last five years (R. Jain, pers. comm., 2015).

Sambhav prefers to handle morganite, which yields around 10% weight retention as opposed to only 3% to 5% for fire opal. Fire opal also has a high rejection rate from stones becoming opaque during cutting.

For Sambhav, the Hong Kong show is the main outlet for morganite to the Chinese market, while the Tucson shows are the path to the U.S. market. There has also been strong demand from television networks, primarily in the United States, and from designers for custom orders. The orders for these television networks come mainly from jewelry manufacturers. Sambhav is also cutting moldavite and synthetic alexandrite specifically for television. It supplies on an order basis, sourcing the rough and cutting any colored stone requested by the television network's vendors.

As with other Jaipur cutters dealing with various types of rough colored stones, Sambhav has found it difficult to source enough morganite to fill customer demand. Morganite rough has been especially difficult due to the strong Chinese demand. For instance, an order for cut stones might require 200 kg of rough, but only 100 to 150 kg of material can be sourced. Part of the difficulty in obtaining rough is that even though China is a main customer for Sambhav's cut morganite, the Chinese cutting factories are also Sambhav's main competitors for rough purchasing.

Figure 20. Sambhav's preformers and faceters are shown cutting morganite and fire opal. Photos by Andrew Lucas, courtesy of Sambhav Jewels.



This imbalance in morganite rough supply vs. demand over the last five years has increased the price for Sambhav five- to tenfold. This continual price increase makes it difficult to meet the demand and price expectations of clients or to provide a stable price for customers to plan their production costs on.

Sambhav preforms and facets the morganite rough, sends out the faceted stones for irradiation to a golden color, and then heats them to pink. The final product is predominantly calibrated goods. To obtain the proper calibration size in the final faceted stone, the preforms must be a half-millimeter to a millimeter larger than the final calibrated size. For larger sizes like 10 mm rounds, the preform will be 11 mm. For a 2 mm final cut stone, the preform will be 2.5 mm. The calibration tolerance varies, with some clients allowing a 0.2 mm tolerance and others only 0.1 mm. This requires a very careful transfer from the crown to pavilion on the dop. Sambhav sells calibrated stones down to 1 mm in size as well as large freeforms, based on the order.

National Facets. Since its start in the mid-1980s, this large family-owned business has specialized in manufacturing beads. Rajesh Dhamani has been the guiding force behind the company. In the local spirit of family businesses, he is now assisted by his son Yash Dhamani, part of the new generation of Jaipur entrepreneurs.

Another member of the family, Sankalp Dhamani, explained that starting out as a bead manufacturer requires a smaller initial investment than other types of colored gemstone manufacturing. It is far less expensive to produce top-quality beads than top-quality facet-grade material. Since finding success in this niche, National Facets has also expanded into finished bead jewelry.

The company, which began with three people working out of their homes, now has a staff of 500. The commercial grades are sent to the Jaipur cottage industry, while the better-quality material is cut at the factory. More than 50 families, almost an entire village outside the city, work full-time creating beads for National Facets. Most of these families have been working for the company for over 20 years.

All of the preforms are fabricated in a factory (figure 21). The preformed stones are either cut in the factory or sent to the cottage industry with specific requirements for bead manufacture. The company also saws in the factory, drills bead holes, and does stringing. National Facets now has two factories in Jaipur, one of them in a Special Economic Zone



Figure 21. National Facets uses the cottage industry for cutting but prefers to preform for beads and cabochons in its own factory, as this is a critical stage for weight. Photo by Andrew Lucas, courtesy of National Facets.

(SEZ; see box A) to take advantage of the tax breaks for exporting.

Customers include other bead wholesalers. Better-quality beads often go to designers, who want rare and exotic material, as well as retail chains and high-end branded retailers. Commercial-quality goods are increasingly sold to jewelry television networks. While National Facets' main customer base is in the United States, its beads are also selling in Germany and Japan. The company has also had some preliminary success entering the Chinese market, where customers will pay cash and give good prices. Hong Kong is one of its major outlets to markets all over the world.

More than 80% of the beads manufactured from transparent gemstones are faceted. Faceted beads are essential for television sales because their sparkle from the facets displays well on television and better captures the viewer's attention. At any given time, National Facets is manufacturing at least 50 gemstone varieties, including ruby, sapphire, emerald, tourmaline, beryl, topaz, quartz, moonstone, opal, cat's-eye chrysoberyl, alexandrite, tanzanite, tsavorite, and spessartine (figure 22). At the factory we saw large orders of chrysoprase and tanzanite beads totaling over 200,000 carats.

For ruby, sapphire, and emerald, National Facets looks primarily for good color and included but still transparent material, which keeps prices reasonable. For many other transparent gemstone varieties, good color and high clarity are vitally important. With



Figure 22. National Facets cuts a wide range of gemstone varieties for its bead inventory, including aquamarine, morganite, fire opal, lapis lazuli, and rose quartz. Photo by Andrew Lucas, courtesy of National Facets.

transparent material, bead sizes range from 2 to 20 mm, but maximum size depends on the variety. With amethyst and citrine, high-clarity material can yield 20 mm beads, but it is very difficult to produce good-clarity morganite and aquamarine above 10 mm at a reasonable price.

Exact standardization of size and quality for specific gemstone varieties is difficult to guarantee to customers based on the supply of rough. National Facets typically informs customers how long merchandise of a particular size and quality is expected to remain in stock—usually no more than six months.

Like other Jaipur companies, National Facets must work closely with Indian customs officials to assign the right value to rough imports. While rough usually enters the country through Mumbai, it is often valued by customs officials in Jaipur, who have considerable experience with colored stones. There are no duties for rough colored stones entering India. There are some trade agreements, as with Japan, regarding the value of raw materials imported into India and the value of the finished goods exported to Japan. If the price difference is too great, the Japanese government can challenge the Indian government. Similar agreements are in place with other countries.

The company's business strategy is to always have inventory. Even without specific orders, National Facets is constantly buying rough and cutting in order to have goods available to customers and to keep the cutters working. It tries to focus inventory

on gemstone types, sizes, and qualities that are consistently in demand, like citrine and amethyst, rather than overproduce trendier bead materials like fire opal and tanzanite, which would create more pressure to sell and discount. Customers are always looking for new stones, and National Facets cuts and markets new types of beads to meet the demand without oversupplying and dropping the price.

Every time the rough goes through the saw, 5% of its weight is lost. Preforming loses on average 40%, and from preform to cutting the final bead averages about 70% total weight loss. For good-clarity material, the weight retention from the original rough is about 25% to 28%, and for lower-quality material it is 10% or less. These percentages vary by variety. For instance, chrysoprase's weight retention is lower due to the impurities found in the rough. Good-quality quartz may go as high as 35%. Tumbled-looking material that requires only minor preforming and final polish following the preformed shape can achieve 40% to 50% weight retention, even for transparent material like aquamarine.

At full capacity, National Facets can cut up to one million carats per month, though this volume would be extremely rare due to labor costs, raw material costs, and inventory buildup. Production is gauged by market demand and availability of the right types of rough at the right price. This is a major issue for National Facets and all cutting companies in Jaipur.

In response to Tanzanian and Ethiopian regulations on rough exports, National Facets has set up cutting operations in those countries to fashion the material, with the final finishing done in Jaipur. This has created challenging situations with Indian customs officials, as there are duties on finished goods and the partially finished material must be prorated.

Gemstone Treatment. At the offices of Rhea Enterprises, Rajneesh Bhandari discussed the company's various treated, synthetic, and imitation products. The enhancement processes include heat treatment of corundum and other gems, coatings (especially thin films on drusy quartz), fracture filling (including lead-glass filling of ruby), and stabilization of turquoise. Rhea also creates what they market as synthetic fire opal, sold under the brand name Mexifire, and manufactures imitation alexandrite plus a variety of doublets and triplets. These products are sold directly and through partnerships with other companies.

Mr. Bhandari, who has been coating gemstones since 1999, showed us the wide variety of coated drusy quartz material that is one of Rhea's main product

BOX A: SPECIAL ECONOMIC ZONES (SEZs)

As the name suggests, Special Economic Zones are located within national boundaries and dedicated to increasing foreign investments by export only. India established its first such zone in 1965. The SEZ policy announced in April 2000 provides:

- Simplified procedures for development, operation, and maintenance of the SEZs and for setting up units and conducting business in them
- Single-window clearance, allowing exporters and importers to submit all relevant regulatory documents at a single location or to a single authority to expedite the clearance process
- Simplified compliance procedures and documentation requirements, with an emphasis on self-certification

Of the many SEZs providing services in various sectors, several are dedicated to the gem and jewelry industry. These are located in Jaipur, Mumbai, and Kolkata. The SEZ in Jaipur was developed by the Rajasthan State Industrial Development and Investment Corporation (RIICO) to generate more foreign investment. RIICO foresaw the gem and jewelry demand very early and established a dedicated zone for the industry. Later, RIICO announced the opening of two more zones in Jaipur.

More than 70 companies operate their export-only business in these three zones. They employ more than 7,500 workers, a number that fluctuates seasonally. Most of the companies provide pickup and drop-off facilities for their workers at certain transit stations.

The incentives and facilities offered to SEZ units include:

- Duty-free import/domestic procurement of goods for development, operation, and maintenance of SEZ units
- 100% tax exemption on export income for the first five years, 50% for the next five years, and 50% of the export profit for the following five years
- Loans up to US\$500 million in a year without any maturity restriction, through recognized banking channels
- Exemption from central sales tax and service tax ("Facilities and incentives," n.d.)

India's SEZs have increased the production volume of gems and jewelry in recent years. In 2005–2006, the SEZ exports from all sectors were only US\$5.08 billion; in 2013–2014 that total was US\$82.35 billion ("Export performances," n.d.).

TABLE A-1. Details of Jaipur's Special Economic Zones for gems and jewelry.

| DETAILS | Export Promotion Industrial Park (EPIP) | SEZ-1 | SEZ-2 |
|-------------------------|---|----------------------------|--|
| Total area | 212,030 sq. meters | 79,515 sq. meters | 361,748 sq. meters |
| Plots area | 116,500 sq. meters | 43,800 sq. meters | 199,267 sq. meters |
| No. of plots | 76 | 51 | 189 |
| Plot sizes (sq. meters) | 1,000, 1,500, 2,000, and 4,000 | 500, 700, 1,000, and 2,000 | 500, 700, 1,000, 1,500, 2,000, and 4,000 |
| Factories in production | 18 | 12 | 5 |
| Approx. employment | 7,500 collectively | | |

Source: <http://sitapurajewels.com/The-Association.html>

lines. We saw the process of cutting and shaping a natural chalcedony geode into the shapes that would be coated with materials to create the color. The final coated drusy only yields about 1% weight retention from the original geode. The gold coatings create an actual gold color, while other thin-film coatings like titanium oxide and silicon oxide cause light interference to create an assortment of colors.

Coating is done in a –7 atmosphere vacuum, by an electron beam or sputtering process. It often involves 24 to 36 multiple coatings with exact thickness, typically between 100 to 400 nm, and alternating higher and lower refractive index. A base layer is applied first and acts as an adhesive between the drusy quartz and the various color-causing elements. Slight heating is required for better adhesion. Electron beam coating



Figure 23. These triplets were assembled and preformed into rectangular shapes before being fashioned. Photos by Andrew Lucas, courtesy of Rhea Industries.

can cover larger surfaces faster and more economically, while sputtering is a more adhesive process. Some of the special effects that can be created from these coatings are bicolors, matte finishes, leopard-skin patterns, and logos and other designs.

For triplets, Rhea primarily uses natural colorless quartz with a variety of colored adhesives (figure 23). Colors reminiscent of Paraíba tourmaline have proven especially popular. The company has also had success creating bicolor triplets imitating ametrine and tourmaline. The thin-film process can even be used to create a schiller effect on top of the colored coating, giving the triplets a rainbow moonstone effect. A new product we saw was a mother-of-pearl base with coloring added by the epoxy layer. Gold wires were used in the epoxy layer to create a pattern. Another interesting product was a coated drusy quartz triplet with a colorless quartz protective top. Rhea's imitation alexandrite, a glass marketed under the trade name Alexite, features a purple to blue or an orange to green color change. In Turkey the material is sold as imitation Zultanite.

We observed the operations of Rhea's full range of furnaces for heating corundum. The treatment factory has 14 of them, including a Sri Lankan Lakmini gas furnace and various high-temperature electronic furnaces. Rhea often heat-treats rough corundum instead of preforms since it is not focused on cutting natural corundum and finds it easier to sell the rough to cutting factories. The first furnace we saw was a Nabertherm vertical tubular furnace from Germany, which can reach temperatures around 1,900°C. The gemstones are heated in the tubular portion, which can also be used to create a vacuum for precise control

of the atmosphere. Up to three gas lines can be controlled in this section. This exact control of the atmosphere is very useful in heating sapphire, where precise control over the reducing atmosphere is important.

Mr. Bhandari considers the muffle furnace more cost-effective for ruby, as the oxidizing atmosphere for heating ruby does not warrant the advanced tubular furnace. The atmosphere and environment control is highly stable even for several days of heating with the tubular electric furnace. For beryllium treatment of corundum, the advantage of the tubular furnace is its stability at high temperatures and the exact control of the oxidizing atmosphere. Mr. Bhandari notes that having exact control of the amount of oxygen allows better control over the appearance of the beryllium-diffused color, such as yellow, and the ability to make the color paler and more natural-looking.

We were told that the tubular furnace also gives precise control of the temperature, plus or minus 1°C over seven days. The atmosphere in the tube does not affect the heating elements as in a more open electric furnace like the muffle furnace. While the corundum is heated in a crucible and gases can be added to the electric muffle furnaces, the exact control of the environment is not as precise as with the tubular electric furnace. This reduces deterioration of the heating elements and makes the temperature limits higher and easier to maintain, according to Mr. Bhandari. The electric tubular furnace can also allow for more gradual cooling than Lakmini gas furnaces.

As Jaipur continues to take an even larger share of colored gemstone cutting and trading, treatment technology becomes critical. Being able to treat lower-cost goods with coatings and other processes

to make them more marketable will ensure that large amounts of this material flow into Jaipur. To successfully compete with Thailand and Sri Lanka in the ruby and sapphire cutting market, Jaipur must bring its heat treatment capability up to their level.

JEWELRY MANUFACTURING, RETAIL, AND EXPORT

Over the past two decades, Jaipur has built upon a rich tradition of jewelry manufacturing that dates back to the early 1700s, when the city was founded and the maharajas encouraged the migration of skilled craftsmen to the city. The traditional artisan cottage industry was overshadowed in the twentieth century by the colored stone cutting industry, for which the city is known internationally.

Today, traditional Jaipur jewelry arts and fusion jewelry combining modern and classic styles are gaining global recognition (figure 24). Jaipur has also become a modern jewelry manufacturing hub. In the late 1980s and early 1990s, there were only four modern jewelry factories. By 2015 there were more than 250 such facilities (R. Jain, pers. comm., 2015).

We saw traditional craftsmanship using techniques dating back centuries, as well as modern mass production. Cutting-edge designer jewelry for famous brands and tremendous amounts of colored stone jewelry for television were being created. Jewelry stores that once served the maharajahs, designer brands, retailers catering to the Bollywood crowd, and vertically integrated manufacturing/retailing companies all coexist and flourish in Jaipur.

Traditional Manufacturing, Retail, and Designer Jewelry. Traditional Rajasthani jewelry can be described as an explosion of opulence and color. An abundance of large flat-shaped rough or flat-cut *polki* diamonds and colorful enamel jewelry, completely finished on the front and back, lends a regal appearance. These pieces are truly fit for the maharajas and moguls of the past and are completely unlike Western jewelry. Much of the manufacturing involves techniques little changed for centuries. Some traditional items of Rajasthani jewelry include the *rakhdi* (head ornament), *tussi* (necklace), *baju bandh* (armlet), *ariya* (a special necklace worn by Rajputs), *gokhru* (bracelet), and *pajeb* (anklet). For a glossary of Indian jewelry terms, see box B.

So-called fusion jewelry combines the traditional materials and design elements of Rajasthani jewelry with those of various cultures and periods, including modern Western and Indian tribal jewelry. To investi-



Figure 24. Rubies in a modern invisible setting are combined with polki diamonds in this fusion-style ring from the *Adrishya* collection. Photo courtesy of *Birdhichand Ghanshyamdas Jewellers*.

gate this segment of the manufacturing and retail industry, we visited four companies in Jaipur. Three dated back to the 1700s, while the fourth has only recently entered the scene, particularly with Bollywood celebrities and the international market (Jakhar, 2012).

Surana Jewellers. This family-owned manufacturing and retail business began in 1735 as a jeweler to the maharajas. The Rajasthani royalty were the core clientele for many decades, as they were among the few who could afford this jewelry. By the 1900s, wealthy British and the growing Indian merchant class had become important customers. After India gained independence in 1947, the buying power of the Rajasthani maharajas was curtailed and Surana looked to expand, traveling to jewelry shows in Mumbai, New Delhi, and other cities where they have since opened stores. Eventually the company was able to place family members in different areas of the country to open more stores, and they continue to look at new areas as the family grows.

Prior to the 1950s, selling was very informal. Showrooms had low tables, and the customer and the jeweler would sit on pillows on the floor across from one another. Structured jewelry companies were not the norm in India, and on a daily basis there were far fewer customers.

Even after Surana established its first modern showroom in 1951, it was in a 150-year-old building in the old part of the city. Their 500-square-foot showroom received five wealthy customers a day, by

BOX B: GLOSSARY OF TRADITIONAL INDIAN JEWELRY TERMS

Chambala: Bud-shaped decorations based on the yellow flower of the champa tree, strung in a series on a long necklace.

Chandbala: A type of earring incorporating the shape of a half-moon.

Jadau: Jewelry in which gemstones are set with gold or silver foil beneath them to enhance their brilliance. It is the oldest form of Indian jewelry and is believed to have originated in the royal courts of Rajasthan and Gujarat.

Jhapta: A wedding ornament, usually crescent-shaped, that hangs on one side of the head and is fastened with a pin.

Jhumki: An earring style incorporating three-dimensional ornaments around the vertical axis.

Kada: A wide bangle bracelet, with or without a hinge.

Kundan: A traditional form of jewelry where very thin 24K gold foil, usually pounded into long strips, is burnished around gemstones to help set them. Kundan may be used interchangeably with *kundan meena*, as this style of jewelry often includes enamelwork.

Meenakari: A style of enameling, from *meena* (enamel) and *kari* (the art of fusing glass on precious metals).

Polki: Uncut diamonds, or diamonds fashioned to resemble uncut diamonds.

Rajasthani ariya/ariya: A choker necklace, usually gold, embellished with *polki* diamonds, colored stones, and pearls.

Rani Haar (also known as a Queen's necklace): A multi-strand neckpiece with a large pendant hanging in the front. There are usually an odd number of strands, which often contain gold beads.

appointment only. There were still only about 10 customers a day for many years after that, though these were serious customers who could spend significant money (P. Surana, pers. comm., 2015).

Now there are often 60 to 70 customers a day in the larger Jaipur showroom Surana moved to in 2000; most are still serious customers looking to buy. They are the modern-day moguls: wealthy Indians, corpo-

ration heads, European royalty, and celebrities. Showrooms have a minimalist feel, which lends itself to the traditional pieces on display. The stores are organized by jewelry product categories such as gold, diamond, colored stone, enamel, and Western styles.

Kundan jewelry (figure 25) is very popular with Indian consumers living domestically and abroad. Even younger upscale Indian consumers show a serious interest in kundan jewelry. Western customers often buy kundan pieces that are relatively slender and lightweight, with a simpler design. Interest in kundan jewelry is also growing among wealthy consumers in Pakistan, Sri Lanka, Bangladesh, and Nepal, whose king is already a customer. Surana's elaborate *objets d'art* in gold, polki diamonds, and enamel are found in auctions worldwide, and the collector base is growing (figure 26).

Surana also has a growing Internet sales business for its lower-priced items of US\$3,000 or less while selling more expensive pieces at traditional auctions. The company exports jewelry to the large Indian customer bases in the United States, Europe, and (through Hong Kong) many other global locations. Tourists visiting Jaipur have purchased kundan-style jewelry, creating more interest globally through the pieces they bring home.

To expand its market, Surana makes elaborate jewelry for traditional Indian weddings (figure 27) as well as lines with more modern influences. Their bangle bracelets show European design influences like oval

Figure 25. Kundan jewelry is still very popular with Surana's clients, with some shapes simplified for a more modern classic look while retaining the bold enamel colors and polki diamonds. Photo courtesy of Surana Jewellers.





Figure 26. Left: Besides its elaborate jewelry, Surana produces a limited number of decorative objects with enamel and polki diamonds. Right: Bold and colorful traditional kundan jewelry is popular with Indian consumers today and is reaching markets in other countries. Photos courtesy of Surana Jewellers.

cuffs, altered for the kundan style with uncut and rose-cut diamonds and a variety of colored stones and cultured pearls. Enameling is done on the front and back of the piece. These bracelets are designed for party and evening wear as opposed to traditional wedding jewelry. Some of these high-value fashion pieces have large uncut polki diamonds.

We saw a cultured pearl and diamond necklace, designed for evening wear, with a 10 ct polki diamond as the center stone. These kundan-style pieces contain 22K, 23K, or 24K gold, which works well for the enamel used to add bright color. Polki diamonds or flat-cut diamonds are often set in the kundan style

in 22K to 24K gold frames. Inside the setting, a silver foil is placed underneath the diamond to give it an appearance of depth. The diamond is then sealed in place with thin 24K gold all around it. Creating the illusion of larger, brighter polki diamonds is essential to the art of kundan jewelry.

Surana prefers 23K gold for the frames and 24K gold foil to secure the uncut diamonds in the setting. A wax-like substance holds the silver foil under the diamond, and the 24K gold foil secures the diamond. Cultured pearls and colored gemstone beads are popular components of kundan-style jewelry and are used to create a sense of movement. South Sea cul-

Figure 27. This traditional wedding jewelry is covered in large polki diamonds and finished in the back with enamel. For wealthy Indian families, no wedding is complete without such elaborate bridal jewelry. Photos by Andrew Lucas, courtesy of Surana Jewellers.



tured pearls are often chosen for high-end kundan jewelry. The main stages are the creation of the gold frame, the enameling process, and the setting of the polki diamonds.

After the gold frame is made and the piece is enameled, the wax-like substance is applied to secure the uncut flat diamonds and the silver foil. After the wax-like substance becomes soft at about 60°C, they make an indentation in it, often with a rounded piece of hot charcoal, and place the silver foil and then the polki diamond. This creates the look of one piece and gives the appearance of depth to the flat diamonds that are flush with the soft wax-like material. The silver foil is shaped to act as the diamond's pavilion. Its highly reflective nature gives the appearance of depth to the flat diamond while adding brilliance. The depth of the silver foil is determined by the stone size and the thickness of the gold frame. Surana uses a silver alloy that is approximately 8% gold so that the silver does not tarnish over time. Once the wax-like "lacquer" hardens, it puts the diamond and silver foil setting in place.

Any excess wax-like material that is pushed above the setting is removed with a graver-type tool. Then the wax-like material is reheated to 50°C, and the 24K gold foil is placed inside it and around the diamond, securing it in place. A finishing tool is used on the 24K gold, giving it a polished look. Some of Surana's more intricate pieces can take two to four months to complete, depending on how many bench jewelers can work on different components at the same time.

Colored stones are set the same way using silver foil. Sometimes the foil is even painted to enhance the color of the stone. In less expensive kundan pieces, Surana uses 18K gold, colorless sapphires, or

rock crystal quartz fashioned to resemble flat uncut diamonds (often set with silver foil behind them to increase brilliance) and no enamel. Color may be added by the use of emeralds and other colored stones.

Surana sources uncut diamonds from sightholders and specifically looks for flat rough. In one of its jewelry lines, 18K gold is used with more contemporary designs and modern-cut diamonds as well as fusion styles (figure 28). In 2013, Surana's production of the line with modern-cut diamonds and the kundan line with uncut diamonds was divided 50-50. By 2015, the kundan-style jewelry was between 60% and 70%. This increase reflects the rising price of diamonds and the fact that foil-backed uncut diamonds offer the look of a much larger diamond for less money, which has stimulated interest in this style of jewelry. The continued rise of the wealthy class in India and the amount of money they can spend on weddings also plays a significant part. They prefer jewelry that is expensive and provides an even larger and more regal look.

Surana uses the cottage industry of artisan jewelers. Handling such expensive materials requires complete trust in the skill and integrity of these artisans, and some have been making jewelry for Surana for five generations.

Surana uses approximately 100 kilograms of gold in manufacturing each year. An elaborate bridal suite of kundan jewelry could have a total weight of half a kilogram or more, with 75% of that weight in gold. Surana Jewellers gives the material for the suite to a single artisan, who often works at home with other family members and possibly apprentices. These traditional skills and kundan-style designs are passed down from generation to generation.



Figure 28. Surana creates jewelry with modern-cut and fancy-color diamonds while retaining an Indian flair. Both the ring (left) and the bracelet (right) feature modern-cut diamonds and gold filigree but do not incorporate the enamel that is traditionally seen in Indian jewelry. Photos courtesy of Surana Jewellers.



Figure 29. This maharaja headdress with polki diamonds and emeralds was created by Gem Palace more than 200 years ago. Photo by Andrew Lucas, courtesy of Gem Palace.

Gem Palace. In the early 1700s, the ancestors of Gem Palace owner Sanjay Kasliwal were invited by Jai Singh II to Jaipur to become official royal jewelers. The family made kundan-style jewelry for the maharajas using uncut Golconda diamonds (figure 29). The opulent lifestyle of the maharajas provided a constant demand for elaborate jewelry and *objets d'art*, even for infants and horses. Today objects such as a 250-year-old 24K gold and enameled chess set are found throughout the Gem Palace showroom of treasures. Mr. Kasliwal showed us an infant's solid gold plate and spoon that were enameled and set with diamonds. Some of Gem Palace's pieces, like a 250-year-old drinking flask, have been purchased back from the descendants of the maharajas and resold to today's ultra-wealthy.

During the British colonial period, Gem Palace served many of the viceroys in India. This eventually led to clientele like President John F. Kennedy and First Lady Jacqueline Kennedy, Queen Elizabeth II, and the royal families of the Netherlands, Sweden, and Spain. Gem Palace pieces have also been worn by celebrities past and present such as Errol Flynn, Richard Gere, Gwyneth Paltrow, and Oprah Winfrey. Some of the world's wealthiest people, including the emir of Qatar, are clients.

Fifty percent of Gem Palace's customers are Indian, and wedding jewelry is very important to the core business. Foreign clients from Europe, the U.S., the Middle East, and a growing market from Central and South America also play an important role.

The building that houses the showroom and workshops was completed in 1842 and still contains

the room where the maharajas were received. Most of the rooms are workshops now, and Gem Palace creates its jewelry on site. The lapidary staff uses modern faceting machines as well as traditional handheld bow-powered preforming machines to cut a wide range of colored gemstones. Besides cutting for its own jewelry, Gem Palace also exports colored gemstones to other jewelers worldwide. Its jewelry manufacturing incorporates traditional hand fabrication methods and tools and even some blowtorch soldering techniques (figure 30).

Mr. Kasliwal takes pride in the fact that Gem Palace's jewelry is finished with equally high quality on the front and back, as it was for the maharajas. This is normally done with enamel on the back. The philosophy is that the wearer sees the back of a piece as they put it on and take it off, so they should see the same quality of finish that the rest of the world sees. Mr. Kasliwal also blends styles, as in his Indo-Russian line, where the back of the piece is finished with a Russian style of filigree and diamond settings (figure 31). These new styles may incorporate flat polki diamonds, rose-cut diamonds, and modern full-cut diamonds.

Gem Palace creates jewelry for a variety of price points, ranging from US\$500 to US\$10 million. The company sells both antique and newly made jewelry in traditional kundan style with polki diamonds as well as variations that blend in modern influences. It also produces opulent jewelry with modern-cut diamonds and colored stones with contemporary set-

Figure 30. Even today, many of Gem Palace's master goldsmiths prefer soldering with a blowpipe, which they feel controls the flame and heat more precisely than a modern torch. Photo by Andrew Lucas, courtesy of Gem Palace.





Figure 31. With polki diamonds and an Indian design on the front (left) as well as a completely finished back with filigree and diamond settings in a Russian style (right), this reversible piece offers the choice of two distinct styles. Photos by Andrew Lucas, courtesy of Gem Palace.

tings, similar to what might be seen in the high-end jewelry houses of Europe. Mr. Kasliwal has also catered to a substantial increase in demand for colored stone jewelry featuring gems such as tourmaline, tanzanite, aquamarine, and quartz (Persad, 2014).

The company is vertically integrated in the sense that Mr. Kasliwal travels to Africa and South America to buy rough stones directly from the mines and the dealers. His workshop cuts the stones, designs the jewelry, and manufactures the pieces to be sold in the Gem Palace showroom.

Amrapali Jewels. Unlike other Jaipur companies that date back to the 1700s, Amrapali Jewels was started in 1978 by two entrepreneurial history students, Rajiv Arora and Rajesh Ajmera. Both men wanted to start a business that incorporated Indian culture and history, which they found could be expressed through jewelry. They started the business with no long-term business model, just a few hundred rupees in their pockets and a passion.

The two traveled to remote villages in Rajasthan, Gujarat, and Orissa and sought out one-of-a-kind tribal jewelry to recreate in their vision. These pieces could be purchased in secondhand stores and pawnshops for very little money, often just 10% over the metal value. Much of the jewelry they created contained components of the original piece. After purchasing a necklace with 24 drop pendants, they would turn the piece into 12 earring pairs and sell to 12 customers rather than one. By following this strategy they were able to get more customers and higher profit margins. (Indeed, one of the history student founders was also a business school graduate.) Their original store in Jaipur, a 150-square-foot shop at the end of a quiet street, was the

least expensive place they could find. At first the two partners made everything by hand. In 1981 they hired a craftsman, and that was the start of growing the business.

Amrapali brought the tribal motif into the realm of high-end fashionable jewelry, attracting Bollywood celebrities and other sophisticated customers. The first Mumbai store, opened at the end of the 1980s, was in an upscale shopping area that catered to a trendsetting clientele. The brand name Amrapali became synonymous with this tribal designer look. The jewelry styles remained closely related to those of each individual tribe's unique design elements but also reflected Amrapali's own influences. One example, the Panna collection, features carved emeralds in floral designs (figure 32).

Along with the flagship store on Mirza Ismail Road, which is considered the Fifth Avenue of Jaipur, stores were also opened in Delhi and Bangalore, and franchises were formed. Amrapali's growing e-commerce business is designed to reach the consumer globally and directly. The export business also began growing due to strong international interest in the tribal-inspired designs. By 2002 these collections were available in Selfridges, an upscale department store in London (Kaushik, 2014). Amrapali is now sold in Harrods of London and in retail stores other than the brand's own. There are 36 global retail outlets, 28 of them in India and eight outside the country, with an office in New York City. In addition to its own products, the company manufactures jewelry for other brands.

Most of Amrapali's jewelry manufacturing was outsourced to artisans in the local cottage industry to meet growing demand until the company opened its



Figure 32. Amrapali's Panna collection features Zambian emeralds sourced from Gemfields and carved in traditional floral designs. This peacock brooch is made of silver and gold with diamonds. Photo courtesy of Amrapali.

first factory in Jaipur. This factory is designated as an Export Oriented Unit (EOU) within a Special Eco-

nomic Zone, an area for free trade and export. The facility's success in producing jewelry for export led to the opening of two other factories, also in Jaipur, to handle domestic demand with the same efficiency. Amrapali now relies on its own factories that, depending on the season, employ 1,600 to 2,300 craftsmen manufacturing plated base metal fashion jewelry as well as silver and gold jewelry.

Amrapali's modern jewelry manufacturing facilities are equipped with everything needed for mass production of a variety of traditional and fusion jewelry. Manufacturing includes hand fabrication and stone setting as well as massive amounts of wax carving, casting, and plating.

While documenting Amrapali's manufacturing processes, we saw how the company handles its jewelry lines. Traditional kundan jewelry was manufactured in a separate area of the factory that produces fusion and more modern styles. Amrapali uses traditional steps, including design sketching, hand fabricating the 22K to 24K gold frames, placing the wax-like substance in the frame, placing the polki diamonds and setting them with the 24K gold foil, and applying the enamel (figure 33).

Fifteen years ago, 60% to 70% of Amrapali's business was in exports, but today that number represents the company's domestic sales. The growing discretionary income and purchasing power of the Indian consumer as well as the number of points of sale throughout India have led to this change. With the challenging global economic conditions over the last several years, the international sales volume has actually increased through lower-priced pieces, including base metal fashion jewelry and silver jewelry, which is less expensive and easier to sell and often has a higher profit margin. Amrapali's silver jewelry

Figure 33. The authors observed the steps of making traditional kundan jewelry: building the gold frame, applying the wax-like substance into the gold frame, positioning the polki diamonds, and setting the diamonds with the 24K gold foil. Photos by Andrew Lucas, courtesy of Amrapali.

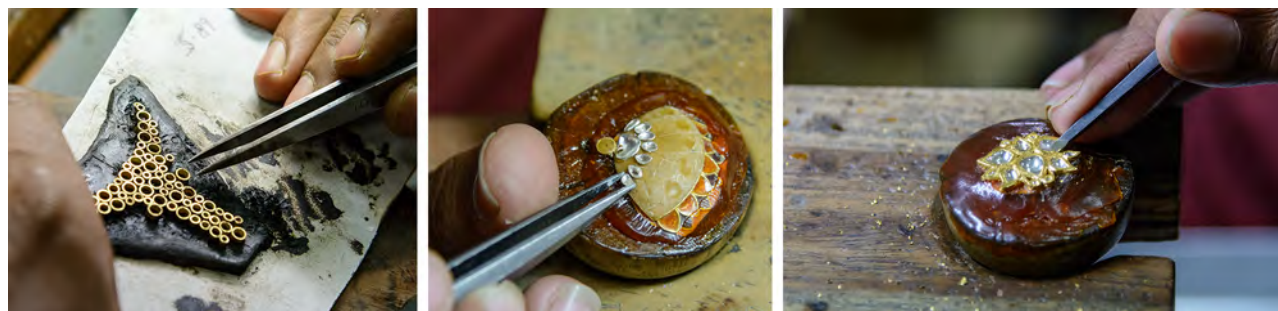

often contains lower-priced colored gemstones, and the base metal jewelry incorporates crystal and other imitations. The e-commerce site mainly sells silver jewelry domestically and fashion jewelry globally, although the company recently launched a base metal fashion jewelry line for Indian consumers. Online sales represent 35% of Amrapali's international sales by value. There are fewer e-commerce purchases internationally than domestically, but often the overall purchase price is higher. This is partly because shipping costs make smaller purchases less cost-effective. But the domestic e-commerce customer is a very loyal repeat customer.

During festival seasons in India, Amrapali's sales can increase dramatically. The company finds that Indian consumers are becoming more fashion conscious. They want to change their jewelry more often and wear new jewelry for special occasions. The price point of the less expensive but well-made and trendy jewelry makes it attractive to consumers with this new mindset.

Amrapali also offers high-end traditional jewelry for discriminating tourists and locals. Indian wedding jewelry is a major source of revenue. While the tourist market is important, the domestic consumer represents about 85% of Amrapali's store sales in India. Customers of all ages come to the stores, but the e-commerce domestic market is younger—from late teens through the 30s—and most sales are from smartphones. Over 90% of the sales are women's jewelry (figure 34).

Amrapali's prices range from about US\$7 to whatever the customer is willing to spend. The average

price for gold jewelry purchased as gifts for special occasions is around US\$500 to US\$5,000. Gold wedding jewelry can easily sell for five to six times that amount. The average price for e-commerce sales varies depending on the season and any festivals taking place but generally ranges from US\$120 to US\$400. Amrapali's gold jewelry ranges from 18K to 24K (predominantly 18K). The kundan-style 22K to 24K gold jewelry is almost always finished with enamel on the back, while the 18K gold jewelry is often finished with filigree on the back.

Amrapali believes that the market for kundan and tribal-inspired jewelry will continue to grow. The company sees the tradition of wearing kundan jewelry at weddings continuing with each generation. Astrological jewelry created in the Navratna style, with nine stones related to the planets with ruby representing the sun in the center, is still popular and remains important to Amrapali. Navratna is considered sacred in many parts of Asia and has a deep meaning that goes beyond fashion. These traditional jewelry-buying needs are combined with the growing demand for fashion-based jewelry among India's younger adults, as well as modern-cut diamond and colored stone jewelry with high-end stones.

Birdhichand Ghanshyamdas Jewellers. This family business began as a goldsmith shop during the 1700s, when select clientele included the maharajas. The company has been prominent in manufacturing traditional kundan meena jewelry with polki diamonds, a style that has been popular in Rajasthan for centuries. In the 1970s, Birdhichand introduced kundan



Figure 34. Left: These upscale bangle bracelets made with silver, gold, and polki diamonds are offered on Amrapali's website. Right: Amrapali is known for its modern high-end diamond and colored stone jewelry lines such as the Masterpieces collection, which includes these sapphire and emerald rings. Photos courtesy of Amrapali.



Figure 35. Birdhichand Ghanshyamdas's Hunar collection brought kundan meena jewelry with polki diamonds to consumers throughout India. Photo courtesy of Birdhichand Ghanshyamdas Jewellers.

meena to the mainstream Indian consumer with the Hunar collection (figure 35).

Birdhichand has blended a variety of modern and traditional designs, materials, and manufacturing techniques to create its fusion jewelry. The company still uses traditional cleaving methods as well as blade and laser sawing to create the flat polki diamonds for traditional kundan meena. The brand has also become known for fusion jewelry, combining styles and materials of kundan meena with more modern elements such as full-cut brilliant diamonds.

The fusion style is popular in India for wedding jewelry and fashionable fine jewelry. The target demographic is Indian women in their 20s through early 30s. Birdhichand finds this generation more interested in fusion jewelry because of the variety of materials and design elements, and the fact that it is different from the traditional kundan meena. Since 2010 the company has featured its fusion jewelry at major international shows such as JCK Las Vegas, the Hong Kong Jewellery & Gem Fair, and Baselworld. The reception over the past few years has been encouraging. The strongest market outside of India is the Middle East, especially Dubai, but there has been growing interest in Hong Kong, the U.S., and Europe. Still, the domestic Indian market accounts for approximately 80% of Birdhichand's business. The company hopes to make exports 50% of its total business.

In 2011 Birdhichand introduced the Adrishya collection, which incorporates invisible settings for full modern brilliant-cut diamonds, rubies, and sapphires. Some of the motifs used for the fusion collections include Mogul architecture, native flora and fauna, and different eras and cultures (Y. Agrawal, pers. comm., 2015).

The Adrishya collection incorporates invisible setting techniques used in Thailand, and Birdhichand

even brought in Thai experts to set the stones and teach the techniques. Fusion jewelry can combine polki, rose-cut, and modern brilliant-cut diamonds in the same piece, and some even combine modern-cut fancy-color diamonds. More colored stones are being used in the fusion designs, particularly emerald and tanzanite.

In 2012 came the Aranya collection, inspired by wildlife. The designs feature carvings of native birds and other animals along with Indian fauna motifs, conveying a sense of closeness to nature. A percentage of the profits from this collection went to conservation and animal protection efforts.

The Amér line, introduced in 2013, was inspired by the Indo-Saracenic architecture of Amer Fort at Jaipur as well as other Indian palaces and citadels. Through these designs, the collection strives to blend Indian culture into the designs. Amér incorporates fancy-color yellow and pink diamonds using full brilliant cuts, rose cuts, and uncut diamonds. Ruby, emerald, and other colored stones as well as basara (or Basra) pearls are also used. In 2014 the Aks collection was launched, designed to reflect Indian cultures and eras.

The Adaa line of fusion jewelry, launched in 2015, is inspired by six eminent royal fashion icons: Maharani Gayatri Devi, Sita Devi (Kapurthala), Umrao Jaan, Razia Sultana, Jodha Bai, and Princess Niloufer. Adaa's theme is feminine power, featuring the motifs and styles of famous women from India's history.

Both kundan meena and fusion jewelry are manufactured in Birdhichand's own factory, with help from the cottage industry of artisans. The company has found that some of the artisans who are expert in these styles work far better in their own homes than in a factory.

18K gold is used to produce Birdhichand's fusion jewelry for the domestic and international markets. One of the key elements in the fusion jewelry is the incorporation of polki diamonds into the design, giving it the big, bold look that is important to the brand.

Birdhichand has also found that the modern Indian woman buys 18K gold jewelry that is smaller and more Western but still suited to Indian attire and design sense. This type of jewelry is as popular for professional working women in India as it is for their counterparts in the West. Because the Indian sense of fashion, especially contemporary fashion, stems from Mumbai and Bollywood cinema, Birdhichand has found contemporary jewelry tastes to be very similar between Mumbai, Delhi, and even Jaipur.

Large-Scale Mass Production. In sharp contrast to traditional and even fusion jewelry manufacturing facilities are the large-scale factories with modern equipment turning out huge quantities of jewelry in more contemporary, Western-influenced styles. These companies can create jewelry in a variety of metals, including gold-plated base metal, silver, and various karatages of gold. The jewelry may be metal-only or set with colored gemstones. Production can reach over a million pieces per month (P. Agarwal, pers. comm., 2015).

One of India's leading mass producers, Derewala Jewellery Industries, was started by Pramod Agarwal in 1986 with a focus on manufacturing silver jewelry. The company had one artisan and just one customer, who became Mr. Agarwal's wife. By 2015 it had a staff of 1,800 manufacturing jewelry in three factories and through Jaipur's cottage industry of artisans.

Derewala mostly produces metal-only jewelry, ranging from gold-plated base metal to silver and various gold alloys. The plated base metal jewelry is for export only. Jewelry with colored gemstones as well as cubic zirconia and synthetics is produced primarily for export. When colored stones are incorporated, Derewala uses a wide variety of them, but only a small percentage of ruby, sapphire, and emerald. Total production is between 1 and 1.5 million pieces each month.

Large retail chains and television are the main customers in the U.S. Derewala also sells to other jewelry wholesalers, smaller retail stores, catalogue retailers, and Internet companies, and it manufactures for other brands. Some 90% of the gold jewelry the company produces is sold in the domestic market. Designs for domestic jewelry are slightly modified with Indian motifs. Derewala sells 18K and 22K gold jewelry for the Indian domestic market, exporting 14K and 18K to the U.S. and 22K to Dubai.

The jewelry's wholesale price ranges from less than US\$1 to US\$6,000 a piece. Mr. Agarwal noted the challenge of designing and producing for such a wide price range. Derewala uses its own designs and accepts design specifications from customers. The minimum order is US\$10,000.

In 2008 Derewala purchased four factories' worth of Italian equipment, including chain-making machines (figure 36), stamping equipment, casting, CAD/CAM, and 3-D modeling. The company also purchased training and consulting support as well as Italian designs for mass production. The factory we visited manufactures gold and silver jewelry and uses 100 kg of gold and 600 kg of silver *each day*.



Figure 36. An assortment of chain-making machines in Derewala's factory are capable of creating numerous styles in silver and various gold karat alloys. Photo by Andrew Lucas, courtesy of Derewala.

Derewala sources nearly all of its colored gemstones but maintains a small cutting facility for repairs or alterations. Colored stones are sourced from large cutting factories in both Jaipur and China. The company is looking for opportunities to open jewelry factories in countries where the market is promising but import duties and tariffs are high. It would make economic sense to manufacture for that country's domestic market, and China is one of Derewala's first choices for such a venture or joint venture.

Television Retail and Modern Jewelry Manufacturing. In Jaipur we were particularly struck by the significance of the jewelry television industry and the integration between local manufacturing and television retail sales. The influence of television shopping extended beyond Jaipur's manufacturing sector, reaching all areas of the colored gemstone supply chain from the mine to the consumer. Just watching jewelry television broadcasts on any given day, it becomes apparent that these shows are appealing to a mass audience with a huge variety of gemstones.

We visited three companies involved with jewelry television. With Vaibhav Global Ltd., we were introduced to the high-volume manufacturing and consumer reach of a vertically integrated company broadcasting its own television programs. The partnership between Pink City Jewel House and Gemporia offered a different perspective, that of a local Jaipur company manufacturing for a foreign company that sells jewelry through television networks in the U.S. and the UK. This close relationship be-

tween manufacturer and customer led to a joint venture to sell jewelry through television to domestic consumers in India.

Vaibhav Global Ltd. This company is an excellent example of consolidation of the value chain in the colored stone industry. Sunil Agrawal started Vaibhav in the early 1980s, buying and selling rough stones out of a garage. Vaibhav was incorporated in 1989 and went public on the Indian stock exchange in 1996 to raise the capital to meet growing wholesale orders from brick-and-mortar and television retailers in the U.S.

In 1996 the company won the GJEPC award for colored stone exports, totaling US\$6.61 million for the year ending March 31, 1996 (Aboosally, 1997b). This was the fifth time the company had won the award. The business quickly moved to manufacturing and supplying finished jewelry to Macy's and other large retail chains in the U.S., as well as television retailers such as QVC.

The company found that the margins for manufacturing colored gemstone jewelry and supplying retailers in large quantities were shrinking substantially. The competition was intense, and it was not a business where a company could provide a unique product or service. Retailers seemed to be in a strong position to squeeze the margins from manufacturers. By this time Mr. Agrawal had been observing the business models of large U.S. and UK jewelry retailers, and he decided to start selling directly to the consumer.

Between 2004 and 2005, Vaibhav opened 18 tourist-oriented jewelry stores in the Caribbean. At the same time it opened a jewelry television station in the UK. By 2006 Vaibhav was expanding into jewelry television in the U.S. and Germany. The company realized that it would take around three to four years to build a retail clientele and become profitable at that level. Then the worldwide recession of 2009 made the company rethink its retail model. During the recession, Vaibhav sold off its Caribbean retail stores and closed its German television ventures. The company also decided which direction to take with its retail business after seeing U.S. television sales for inexpensive jewelry triple (figure 37).

In many of Vaibhav's Caribbean stores and a significant part of its television sales, the average selling price for a piece of jewelry was US\$150. The less expensive jewelry was recession proof. While customers would think twice about a purchase of hundreds of dollars, they would not hesitate to make a \$20 purchase. At this price, it was an easy impulse

purchase. The new company business model was to bring \$20 gemstone jewelry to the U.S. and UK consumer through television (H. Sultania, pers. comm., 2015).

The retail television business has expanded over the last three to four years, allowing the company to repay expansion loans and become profitable. Between television and the Internet, the company sells 30,000 pieces of jewelry each day. Manufacturing is done at their factory in Jaipur, which has more than 2,000 employees, and outsourced to manufacturers in China, Bangkok, and Bali. Vaibhav only manufactures for its television retail divisions and not for any other company.

The jewelry is shipped to the company's retail subsidiaries in the U.S. and the UK, where it is stored in warehouses while awaiting sale on television or the Internet. Vaibhav now has shopping channels in the U.S. and Canada (Liquidation Channel) and in the UK and Ireland (The Jewellery Channel). It also has two e-commerce websites, www.liquidationchannel.com in the U.S. and www.tjc.co.uk in the UK. Besides retail, the umbrella VGL Group also includes wholesale business-to-business sales through STS Jewels. Still, business-to-consumer sales are 87% of the company's revenue.

About 75% of the retail sales come from television and 25% from the web. The television shows are all live, broadcasting 24/7 and covering around 100 million households in the U.S. and the UK. This gives the company 1.5 million registered customers, including half a million regular buyers. To reach this audience, Vaibhav broadcasts over national carriers such as Dish TV, DirecTV, Comcast, Time Warner, AT&T, and Sky, as well as numerous local carriers.

Figure 37. For Vaibhav, the combination of television retail and inexpensive colored gemstone jewelry proved to be a recession-proof and expandable business model. Photo by Andrew Lucas, courtesy of Vaibhav Global Ltd.



The company grew at a rate of 30% a year from 2011 through 2013 and expects double-digit growth in the coming years after substantial upgrades in manufacturing capability and customer reach in 2014. Besides the more than 2,000 employees in Jaipur, the company has buyers in China, Bangkok, and Bali, as well as U.S. and UK retail teams, for a total staff of about 3,000.

Vaibhav's television and Internet outlets complement each other. Because airtime is a costly medium, inventory that is left over from television sales is put on the website, often using a "rising auction" feature. These auctions, which start at US\$1 and sell to the highest bidders, eliminate the problem of old or left-over inventory.

Vaibhav also does reverse merchandising. Since the average selling price will be around US\$20 per jewelry piece, their manufacturing costs need to be around US\$8 per order to reach the desired profit margin. To incorporate gemstones in this price model, Vaibhav buys large parcels of various gemstones at auctions, liquidations, and closeouts around the world and directly from mines.

The upcoming fashion season's colors play a large role in deciding which gemstones to buy. The jewelry is manufactured in base metal for gold plating or in sterling silver, sometimes with gold accents or at the high end of the jewelry gold alloy. Vaibhav's gross profit margin for 2014–2015 was 61%.

Figure 38. Jaipur's vast pool of skilled jewelry makers is crucial to Vaibhav's manufacturing capability. Photo by Andrew Lucas, courtesy of Vaibhav Global Ltd.



In Jaipur the company has around 200 employees devoted to merchandising and design. It also has associates in the U.S. and the UK who study fashion trends and forecasts and send in design requests to designers and merchandisers in Jaipur as well as buyers in China, Bangkok, and Bali. The design teams work both ways to develop concepts. The U.S. and UK teams send design ideas to Jaipur based on their market predictions, and the Jaipur designers send their own concepts to the U.S. and UK teams for feedback.

The company offers 500 different jewelry products each day, and approximately 100 of these are new products. By manufacturing most of the jewelry for its own television channels and websites, Vaibhav is able to meet massive inventory requirements while creating a constant stream of new designs.

The company is investing in technology (larger vacuum casters, more 3-D model making and rapid prototype machines, electropolishing units, and ion plating systems) to increase production but still finds Jaipur an advantageous location for its abundance of skilled manufacturing labor (figure 38). Vaibhav has built two additional factories in Jaipur and a new 80,000-square-foot facility.

Vaibhav is also investing in ways to reach the customer. The passive nature of watching television seems conducive to selling jewelry, and online streaming applies that same model. Vaibhav is also investing in apps for smartphones to bring their shows to mobile users. Whether the medium is television or the Internet, Vaibhav uses the "pull" of the show and the host's storytelling ability to bring in the customer. The storytelling includes the filming of mining areas to show how difficult it is to obtain gemstones, and shots of manufacturing to illustrate the skill involved in creating the jewelry piece. Telling the story creates a sense of value and desire for the piece. Vaibhav uses close communication between merchandisers and show hosts prior to the show to provide the information used in the storytelling. The merchandiser knows the technical information about the product, and the host is expert at telling the story.

Vaibhav has found that this combination works well, since the buyers and merchandisers are attracted to gemstones and jewelry in the same ways consumers are. Because of this, they can communicate the details to the host in a way that will captivate the consumer. For Vaibhav, the other most important factor in jewelry retail is making correct gemstone buying decisions from the start. Buying what the customer wants, and buying it at the right price, is half the challenge.



Figure 39. By investing in sophisticated vacuum casting equipment and incorporating strict casting procedures, Pink City can produce high-quality castings, a crucial first step in quality control. Photo by Andrew Lucas, courtesy of Pink City Jewel House.

Vaibhav is also venturing into other products. Most of its customers are Caucasian women between 35 and 65 years old. The company studied the buying habits of this group and found a natural pairing between their jewelry and their clothing, accessories, household items, and beauty products. Vaibhav does not manufacture any of these products but buys them from third parties. Its goal is to be the digital Wal-Mart of jewelry, fashionable products, accessories, decorative household objects, and beauty products for this demographic. As an example of its merchandising scale, Vaibhav sold out of ring cases that held 100 rings. To accommodate the new categories, the Liquidation Channel has added around 45,000 square feet of warehouse space at its facility in Austin, Texas.

Their average customer buys around 27 pieces of jewelry a year. A new customer will watch the show about five times before deciding to buy. Vaibhav retains around 48% of its customers from year to year. To gain and maintain this loyalty, the company encourages customer feedback, provides a personal shopper program, and sends free gifts to customers twice a year. In 2015 Vaibhav started offering 30-day unconditional returns to its U.S. customers, attracting a new group of customers who would avoid buying unless they had the freedom to return the item if they were not completely satisfied.

The Liquidation Channel has also added a “budget pay” option, where customers can make three

equal payments over three months, allowing for more flexibility. Updates to the website and the e-commerce platform have added features like “guest checkout,” where unregistered guests can make purchases without registering. “Fast buy” provides one-click checkout for registered customers. The Jewellery Channel has also upgraded its analytics. Vaibhav is making technical upgrades for smart televisions and connected devices in order to reach customers through all relevant platforms.

Pink City Jewel House. Jaipur’s Pink City Jewel House started out in the 1990s processing rough colored gemstones exclusively for Swarovski. After 12 years of creating high-quality mass-produced gemstone cuts, the company moved into manufacturing jewelry that met the same quality standards. As the Jaipur colored stone industry saw the Surat diamond cutting industry move from selling polished diamonds into selling diamond jewelry, some members followed suit and moved into colored stone jewelry manufacturing.

Managing director Manuj Goyal realized that overseas jewelry manufacturers could not compete with Jaipur’s own labor costs for manufacturing colored stone jewelry. The key was to invest in the same equipment for vacuum casting (figure 39), 3-D model making, CAD/CAM design, plating, and finishing that was being used to manufacture high-quality jewelry worldwide, while implementing the strictest quality control standards. In 2008 he made the move to finished jewelry.

Rather than selling to wholesalers, Pink City Jewel House manufactures for designers and large retailers, both brick-and-mortar and television. Some of the designers they supply are sold in Saks Fifth Avenue and Neiman Marcus. Manufacturing for television shopping networks began in 2009 and is now the major part of the business. Much of this jewelry is for Gemporia Ltd., which owns Gems TV in the UK and Gemporia TV in the U.S.

In terms of value, Pink City’s business is 70% television sales and 30% designer brands and brick-and-mortar retailers. The brick-and-mortar retailers have a higher percentage of total sales by volume, as a substantial amount is produced with silver or with gold-plated base metal but still contains natural gemstones. Pink City also produces jewelry in gold alloys and platinum, with the emphasis on incorporating an assortment of colored gemstones.

Television customers need a constant variety of different gemstones—literally hundreds of varieties—while the designer brands focus more on a spe-

cific style or a unique cut. Other cutting houses supply most of the stones Pink City sells to their TV customers. Pink City creates unique cuts for branded designers selling in high-end retailers.

The branded designers prefer to have their unique cuts and jewelry done in the same factory, as they find the integration yields a higher-quality finished product, as well as a smoother and more secure operation. Pink City does not cut and sell gemstones for any third parties, only for its own jewelry orders. For television jewelry they buy stones cut to within 0.2 mm tolerance, but for the unique cutting styles done in-house for designers they cut within 0.1 mm tolerance. About 95% of the gemstones they use come from outside vendors, with 5% cut in-house for their designer brand customers.

Jewelry pieces for television often contain a variety of 10 to 15 small stones. Pink City focuses on a lower volume and higher price point, manufacturing fewer pieces than Vaibhav Gems. They average 40,000 pieces each month, though large orders from retailers can add another 100,000 pieces a month. Almost all of the jewelry is manufactured in-house to assure strict quality control and manufacturing time. Once cast, a jewelry piece is completely finished within three days and ships within seven days.

Pink City Jewel House believes that the best-quality workmanship comes from having jewelers on salary as opposed to paying for piecework, and it pays incentives based on both quality and production. The company recently built a third factory in Jaipur, increasing its staff to a total of 1,000.

The brands send very specific requirements as to design, weight, measurements, types of material, and cost. A television retailer usually has less exact requirements but sends design concepts based on themes, something like a storyboard, that Pink City will turn into a collection. Pink City's design team turns these design specifications into CAD/CAM designs and 3-D models that are usually cast but sometimes hand-formed. Their 3-D printers can turn out multiple resins of the same design that can be cast in investment or used as a master model from which molds are created. Finishing is a six-step process of sprue grinding, media polishing, wet media grinding, magnetic polishing, electronic polishing, and then manual polishing by bench jewelers to ensure the highest global standards.

The 30 employees in the design department come up with about 30 new designs a day. They are responsible for creating product lines of nine different brands for television customers alone. More than

25,000 master models have been created to date. The wax and casting department handles around 1,500 wax injections and castings per day. Pink City Jewel House prides itself on the sophistication and quality of its castings, which require minimal finishing. Pink City does much of its manufacturing by setting gemstones in wax and casting them in place. These include diamond, sapphire, topaz, garnets, and some citrines. Still, many of the stones they use require hand setting, which limits production rates. The company's sophisticated quality control includes surface roughness testing machines for castings, and vibration testing machines to ensure the security of set stones in finished pieces.

The company has also begun working with a world-renowned gem artist to bring what was once a designer cut produced by one craftsman, one at a time, to a mass audience. Glenn Lehrer's patented Torus cut gemstones are now being cut at Pink City Jewel House. The cutters are trained by Mr. Lehrer himself under rigorous quality control (G. Lehrer, pers. comm., 2015). The jewelry featuring these cuts is also manufactured by Pink City and sold on Gems TV in the UK, with Mr. Lehrer often appearing on the show with the hosts. Consumers of this jewelry have become avid collectors, buying an average of eight pieces. With the manufacturing capability of Pink City and the consumer reach of Gems TV, a designer like Glenn Lehrer can transition from an artist to a brand.

Designers and brands needing to create high-end, unique pieces with large gemstones ranging from 15 to 20 ct also call upon Pink City. On the day we visited, they had designed and were manufacturing 150 such pieces. All of these were being created simultaneously by a 3-D modeling system.

Pink City's relationship with the Genuine Gemstone Company (now Gemporia) became even more integrated in September 2015, when they formed a jewelry shopping channel through a joint venture. Gemporia India was the first 24/7 jewelry network broadcasting live in India. The channel has many product lines centered on genuine gemstones and diamonds. Gemporia India already reaches more than 30 million homes, with plans to go to 60 million in 2017.

With their knowledge about gemstones, they see an advantage over many traditional retailers in India by using similar methods as Gems TV in the UK and Gemporia TV in the United States. These include storytelling—which encompasses sources, lore, manufacturing, gemstone characteristics, formation, and qualities—as well as disclosure of enhancements and



Figure 40. When Steve Bennett returned to Gems TV in 2010, he decided to sell only natural and treated natural gemstone jewelry, like these tanzanite and diamond rings (left). With two television shopping networks supplying jewelry under the Gemporia brand (right), a large manufacturing capability is required to supply the shows. Photo courtesy of Gemporia Ltd.

care instructions. Their salespeople and show hosts have completed gemological training, and they have a total staff of about 150 employees.

Along with highly informed gemstone storytelling, the show hosts educate viewers on the many styles of traditional Indian jewelry featured on the show. Here the storytelling focuses on the history, the art forms, and the skill in designing and manufacturing these pieces.

Gemporia India also accommodates India's wide variety of ethnic backgrounds and regional jewelry tastes. It broadcasts simultaneously through television, the Internet, and mobile devices. The Internet and mobile versions also feature traditional catalog options.

For Pink City Jewel House, Gemporia India offers an opportunity to manufacture its own jewelry lines for Indian consumers. Given the expanding jewelry tastes among younger consumers in India, Gemporia is poised to sell more colored gemstone jewelry, similar to what the Gemporia's channels in the U.S. and UK are doing.

Gemporia (formerly the Genuine Gemstone Company). Gemporia is considered one of the largest buyers of gemstones and jewelry in Jaipur. One of their main suppliers is Pink City Jewel House, but they have another 40 local suppliers as well as their own cutting facility in Jaipur. Including these suppliers, the number of craftsmen manufacturing for them is around 6,000, and these companies outsource to approximately 4,000 additional artisans (M. Goyal, pers. comm., 2015). The company's sourcing staff in Jaipur totals 130. To supply their customers' appetite,

70,000 to 100,000 pieces of jewelry are manufactured in Jaipur every month for Gemporia.

Company owner Steve Bennett made a fortune in the computer industry before entering the jewelry television business in 2004. In 2006, he and his partners merged Gems TV with the 3,000-employee factory making their jewelry in Thailand. Mr. Bennett then sold his interest in the business to his partners. Gems TV expanded from the UK into other countries and moved into selling jewelry with synthetics and imitations. After the company went through some problems, Mr. Bennett bought back the original Gems TV company in 2010.

Mr. Bennett restored the original philosophy of only selling natural and treated natural gemstones (figure 40) and reduced operations to just the UK before returning to the U.S. market in 2012 with Rocks TV. The company's approach is to start with the gemstones and build the jewelry lines around them. They often buy directly from the mines and have the stones cut in Jaipur. They also buy cut stones from Jaipur and other cutting centers like China and Thailand, but approximately 80% of their cutting and stone purchases are in Jaipur. Diamonds are often bought from sightholders in Mumbai and Gujarat. Between its operations in Jaipur, China, Bangkok, the UK, and the U.S., Gemporia employs more than 1,000 people (S. Bennett, pers. comm., 2015).

Mr. Bennett did a great deal of research before selecting Jaipur as his main base of manufacturing. Besides its competitive labor costs, he feels that the quality he receives in Jaipur rivals that of any manufacturing center. He added that when people talk of superior quality coming out of China or Thailand,

they are comparing an older Jaipur industry and not the new factories and the younger generation of industry leaders who have invested in state-of-the-art equipment and training.

Because it only uses natural gemstones and sells its jewelry in the U.S. and UK 24/7, a wide variety of gemstones are needed to keep the customer base coming back. Gemporia and other jewelry television companies have done a great deal to raise awareness of lesser-known gems like sphene. Their customers tend to be collectors. They might collect jewelry with specific gemstones, or gemstones with a particular source or color, or they might collect jewelry lines from certain designers such as Glenn Lehrer.

Gemporia has changed the way Jaipur cutting companies look at gemstones, with a much greater emphasis on rare and new gemstones to feed the customer's need for constant variety. Besides the variety of gems that is required, Gemporia needs a variety of sources for all gem material. A gem like amethyst is purchased from common sources like Brazil but also from new and lesser-known deposits like Morocco to entice collectors to buy examples from many sources. They have found the mine-to-market story and the source story to be their most effective selling tools. As Mr. Bennett says, "The more you tell, the more you sell."

The variety of stones and sources give the show hosts many different stories they can use to make sales. Their customers, who watch an average of 11 hours a week, are highly knowledgeable and expect the same from the hosts. The on-air staff are required to complete gemological training, and their knowledge is an essential reason why a third-party survey of 200,000 customers showed 98% approval.

SUMMARY

In the colored gemstone industry, the divisions between sources, manufacturers, traders, retailers, and consumers are increasingly diminishing and becoming less geographically distinct. Much like the diamond industry, there is a movement toward consolidation and vertical integration as margins for manufacturers from rough to cut continue to shrink. In Jaipur and every other major cutting center, there is an incentive to move into jewelry manufacturing and even further up the value chain to retail in some cases.

Like China and Thailand, Jaipur has undergone consolidation of the value chain and vertical integration into jewelry manufacturing for colored stones. Each center has its own attributes, but all three share similar strategies and challenges. All of them see a



Figure 41. Jaipur capitalizes on its rich history of craftsmanship with perhaps the best blend of tradition and innovation in the colored gemstone industry. Photo courtesy of Birdhichand Ghanshyamdas Jewellers.

movement toward larger companies that are better funded to buy rough globally, and toward finished colored stone jewelry to increase profit margins. Also, all three have improved the quality and precision of cutting and invested in technology. Thailand and China do not have the same inexpensive labor advantage they once enjoyed, and even though the labor costs for cutting in Jaipur remain highly competitive, the industry there is moving in the same direction as Thailand and China.

Jaipur has perhaps the largest cottage industry of artisan cutters and jewelry makers. This complements the larger factories that cut colored gemstones and manufacture jewelry. Indeed, some large and sophisticated factories also use the cottage industry for part of their manufacturing. Jaipur is one of the most successful blends of traditional and modern gem and jewelry manufacturing and trading.

These advances are being driven by forward-thinking entrepreneurs building modern factories and looking to turn the colored stone cutting center

of Jaipur into an equally strong jewelry manufacturing center. With challenges from the supply side such as limited supply, rising rough prices, and legislation limiting the availability of rough tanzanite and Ethiopian opal, Jaipur has proved very adept at ad-

justing to change, such as the huge demand from jewelry television companies. With its blend of tradition, innovation, and adaptability (figure 41), Jaipur is assuming an even more important position in the global gem and jewelry industry.

ABOUT THE AUTHORS

Mr. Lucas is manager of field gemology for education, Dr. Hsu is technical editor of *Gems & Gemology*, and Mr. Padua is video producer, at GIA in Carlsbad, California. Mrs. Bhatt is managing director for GIA India and Middle East. Mr. Singhania is director of education, and Mr. Sachdeva is a gemology instructor, at GIA India.

ACKNOWLEDGMENTS

The authors would like to thank all the companies and individuals mentioned in this article as well as the GJEPC.

REFERENCES

- Aboosally S. (1997a) Award-winner expanding. *Jewellery News Asia*, No. 152, pp. 56, 58.
- Aboosally S. (1997b) Emerald centre diversifies into other gemstones. *Jewellery News Asia*, No. 151, pp. 84, 88, 90.
- Conway R. (2010) The jewels of Jaipur. *The National*, Jan. 27, <http://www.thenational.ae/lifestyle/fashion/the-jewels-of-jaipur>
- Export performances (n.d.) Indian Ministry of Commerce & Industry, <http://www.sezindia.nic.in/about-ep.asp>
- Facilities and incentives (n.d.) Indian Ministry of Commerce & Industry, <http://www.sezindia.nic.in/about-fi.asp>
- Film actress Amrita Rao—the new brand ambassador of JJS (2015) Oct. 7, <http://www.jaipurjewelleryshow.org/news.aspx>
- Gladstone R. (2015) India will be most populous country sooner than thought, U.N. says. *New York Times*, July 29, <http://www.nytimes.com/2015/07/30/world/asia/india-will-be-most-populous-country-sooner-than-thought-un-says.html>
- Gold souk opens in Jaipur (2012) *Diamond World*, Oct. 27, <http://www.diamondworld.net/contentview.aspx?item=7367>
- Hsu T., Lucas A., Qiu Z. (2014) Exploring the Chinese gem and jewelry industry. *G&G*, Vol. 50, No. 1, pp. 2–29, <http://dx.doi.org/10.5741/GEMS.50.1.2>
- India country profile (2015) BBC News, Oct. 28, <http://www.bbc.com/news/world-south-asia-12557384>
- Jakhar D. (2012) Jewels of Jaipur: Amrapali adds an Italian jewel to its sparkling crown. *Daily Mail India*, May 13, <http://www.dailymail.co.uk/indiahome/indianews/article-2143976/Jewels-Jaipur-Amrapali-adds-Italian-jewel-sparkling-crown.html>
- Kaushik M. (2014) Where old meets new. *Business Today*, Sept. 28, <http://www.businesstoday.in/magazine/cover-story/jaipur-jewellers-ethnic-jewellery-amrapali-jewels/story/2110072.html>
- Khullar R. (1999) *Jaipur and Best of Rajasthan*. Bookwise India Pvt. Ltd., New Delhi, p. 11.
- Lucas A., Sammoon A., Jayarajah A.P., Hsu T., Padua P. (2014) Sri Lanka: Expedition to the island of jewels. *G&G*, Vol. 50, No. 3, pp. 174–201, <http://dx.doi.org/10.5741/GEMS.50.3.174>
- Persad M. (2014) What it takes to be one of the most successful jewelers in the world. *Huffington Post*, May 29, http://www.huffingtonpost.com/2014/05/29/successful-jewelers-sanjay-kasliwal_n_5405069.html
- Tavernier J.-B. (1676) *Travels in India, Vol. 1*, translated by V. Ball, 1977, Munshiram Manoharlal Publishers Pvt. Ltd., p. 303.
- The World Factbook (2016) India. Central Intelligence Agency, <https://www.cia.gov/library/publications/the-world-factbook/geos/in.html>

For More on Jaipur

Watch video interviews to learn more about the Pink City's role in the gem and jewelry industry. Visit www.gia.edu/gems-gemology/winter-2016-jaipur-india, or scan the QR code on the right.



SYNTHETIC EMERALDS GROWN BY RICHARD NACKEN IN THE MID-1920s: PROPERTIES, GROWTH TECHNIQUE, AND HISTORICAL ACCOUNT

Karl Schmetzer, H. Albert Gilg, and Elisabeth Vaupel

Chemical and microscopic examination of the first gem-quality synthetic emeralds of facetable size proves that Prof. Richard Nacken grew two main types of emerald by flux methods in the mid-1920s. One of these two types, grown with colorless beryl seeds in molybdenum-bearing and vanadium-free fluxes, has not previously been mentioned in the literature and would appear to be unknown to gemologists. The other main type, which has already been described in gemological publications, was grown from molybdenum- and vanadium-bearing fluxes. In drawing these conclusions, rough and faceted synthetic emeralds produced by Nacken were available for study from two principal sources: the Deutsches Museum in Munich, to which Nacken had donated samples in 1961, and family members who had inherited such crystals. Chemical, morphological, and microscopic properties are given, and circumstances concerning the developmental history of the Nacken production, including the possibility of collaboration with IG Farben (a subject of past speculation), are discussed as well. The latter has recently been elucidated by the discovery of original documents from the IG Farben gemstone plant, preserved in the Archives of the German Federal State of Saxony-Anhalt.

The early technology for producing gem-quality synthetic emerald has long been a matter of speculation. In particular, the initial methods used for crystal growth by Interessen-Gemeinschaft Farbenindustrie Aktiengesellschaft, known as IG Farben, in Germany from 1935 to 1942 ("Synthetic beryl," 1935; "Synthetischer Smaragd," 1935), which yielded the so-called Igemerald, and by Carroll Chatham in the United States from 1941 onward have generated decades of discussion. Although detailed descriptions of both of these types of synthetic emeralds followed shortly after their introduction (for Igemerald see Eppler, 1935, 1936; Jaeger and Espig, 1935; Espig, 1935; Schiebold, 1935; Anderson, 1935; for Chatham synthetic emerald see Gübelin and Shipley, 1941; Anderson, 1941; Rogers and Sperisen, 1942; Switzer, 1946), the actual growth techniques

remained unknown through the 1950s and were merely assumed to involve the hydrothermal method (Webster, 1952, 1955, 1958). Then, in the early 1960s, Hermann Espig, one of the inventors of the growth process used at IG Farben's plant in Bitterfeld, near Leipzig, disclosed the technique as a flux-growth method using lithium-molybdate as the main flux component (Espig, 1960, 1961, 1962). Conversely, the precise composition of the flux used by Chatham has been a "closely guarded secret" (see Chatham, 1998). Nonetheless, the presence of traces of molybdenum in Chatham synthetic emeralds has established the use of a molybdenum-bearing flux for these stones as well (Nassau, 1976 a,b).

In gemological textbooks and overview articles summarizing the synthesis of gem-quality emerald (Cannawurf, 1964; Nassau, 1976 a,b; Schmetzer, 2002), the samples grown by Prof. Richard Nacken in Frankfurt, Germany, in the 1920s are frequently mentioned as early precursors of modern synthetic emeralds. Because Nacken did not publish any papers about the technique he used, and because only lim-

See end of article for About the Authors and Acknowledgments.

GEMS & GEMOLOGY, Vol. 52, No. 4, pp. 368–392,

<http://dx.doi.org/10.5741/GEMS.52.4.368>

© 2016 Gemological Institute of America

ited quantities of the resulting crystals went to museums or to teaching and research collections, many years passed before the growth method was proven through direct examination of samples. Rather, a hydrothermal technique was widely assumed, based on publications by Gordon Van Praagh (1946, 1947 a,b), whose work was also reviewed briefly in *Gems & Gemology* (Switzer, 1948) and therefore available to the gemological community. Van Praagh's comments were derived from interviews with Nacken in 1945, covering primarily his research on hydrothermal synthesis of quartz (Nacken, 1950, 1953). The first detailed gemological study of Nacken synthetic emeralds, likely performed on samples loaned from the collection of Eduard Gübelin of Lucerne, Switzerland¹, followed this assumption (Eppler, 1958 a,b). Only in the 1970s did examination by Kurt Nassau (1976 a,b, 1978) of Nacken synthetic emeralds, preserved in the collections of Frederick H. Pough of Reno, Nevada, and the Natural History Museum in London, identify residues of a molybdenum- and vanadium-based flux by scanning electron microscopy in combination with EDXRF analysis. This result was confirmed in Schmetzer et al. (1999), using samples from the collections of Pough and Gübelin¹.

In seeking to place Nacken's work in the historical context of emerald synthesis, Nassau (1976 a,b, 1978) mentioned some similarities with the crystal growth techniques used by Espig at IG Farben, and he speculated about a possible collaboration between the two scientists. Nassau also suggested that the secret coloring ingredient in Igmeralds alluded to by Espig (1960) might have been vanadium, but this uncertainty has since been resolved by identification of a nickel-bearing compound used in addition to chromium to achieve the desired color (Schmetzer and Kiefert, 1998). In contrast, the question about collaboration between Nacken and the IG Farben researchers at Bitterfeld has remained open. Moreover, it should be realized that the few known gemological and analytical examinations were based on samples obtained from a limited number of reliable private or public collections. Material sourced directly from Nacken has not been examined to date, simply because his synthetic emeralds have never been available commercially and only a few samples were donated to colleagues. Consequently, the possibility persists that other types of synthetic emeralds, grown by a variant of the flux method or by another technique, might have been produced. The present paper endeavors to incorporate new details into the decades-old discussion on the history of synthetic emerald.

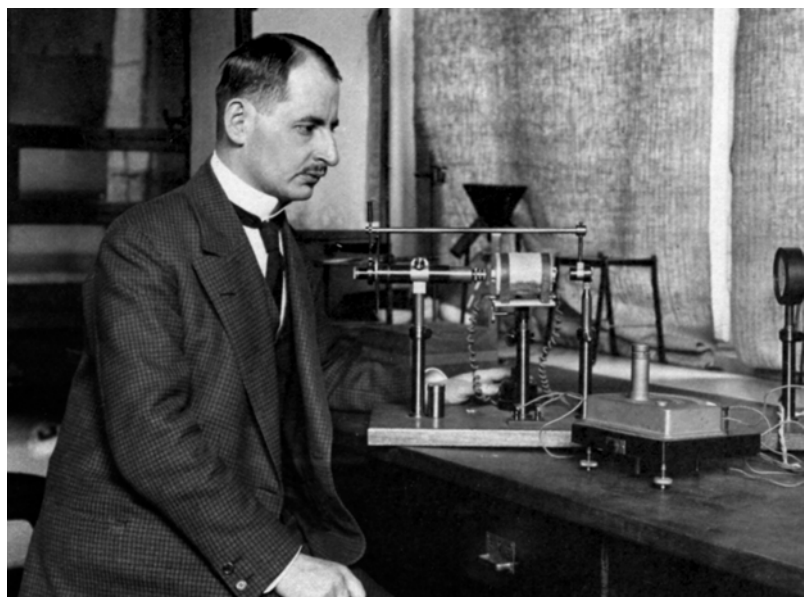

Figure 1. Richard Nacken as a young assistant in the laboratory at the University of Göttingen, 1907. Photo courtesy of E. Schlatter.

PROF. RICHARD NACKEN (1884–1971)

Richard Nacken² was born May 4, 1884, in Rheydt, near Mönchengladbach, Germany, and died April 8, 1971, in Oberstdorf. From 1903 he studied mathematics and natural sciences at the Universities of Tübingen and Göttingen (figure 1), graduating from the latter in 1907. He worked as an assistant at the University of Göttingen until 1908 and at the University of Berlin from 1908 to 1911. In 1911, at the age of 26, he was appointed associate professor for mineralogy and petrology at the University of Leipzig, making him the youngest mineralogy professor in Germany at that time. In Leipzig he also met his wife Berta (née Dreibrodt), and the couple married in August 1912. Nacken's academic career continued with positions at the Universities of Tübingen as associate professor (1914–1918), Greifswald as full professor (1918–1921), and Frankfurt as director of the mineralogical institute. From 1936 he also served as director of the Institute for Gemstone Research at Idar-Oberstein³. After the mineralogical institute at the University of Frankfurt was completely destroyed in the spring of 1944 by Allied bombing (and his home was likewise heavily damaged), Nacken moved to the countryside near Schramberg in the Black Forest, where he was able to set up a small laboratory at the Junghans Watch Company⁴. In 1946 he returned to the University of Tübingen as professor, a position from which he retired in 1952.

Nacken's primary academic interest was in crystal growth and mineral synthesis techniques. Particularly notable among his work were two discoveries. One was the invention of a method for crystal growth in which a seed was attached to a cooled copper rod and inserted into a melt, thereby instigating growth on the cooled seed (Nacken, 1915, 1916). This method is still known as the Nacken-Kyropoulos technique (based upon a variant developed by Spyro Kyropoulos in the mid-1920s; see Feigelson, 2014). A second significant contribution was Nacken's advancement of the technology for growing quartz hydrothermally in autoclaves, based mainly on his research from the late 1930s until 1945 but published in the 1950s (Nacken, 1950, 1953). His hydrothermal work was of interest to foreign governments in the years following World War II and was covered in five documents prepared under the auspices of American and British government entities. These included the U.S. Army's Field Information Agency, Technical (FIAT) and the British Intelligence Objectives Subcommittee (BIOS); relevant documents are archived as PB 6498 (Guellich et al., 1945), PB 14620 (Sawyer, 1945), PB 18784 (Swinnerton, 1945), PB 28897 (Swinnerton, 1946), and BIOS Final Report No. 552 (Coates, undated). These documents were frequently cited in publications addressing subsequent developments in hydrothermal quartz synthesis for crystal oscillators between 1945 and 1960. Some of these documents also contain limited information about emerald synthesis⁵, but Nacken never described his method in a scientific paper. Circumstances that

might have motivated Nacken's efforts in growing emeralds will be discussed below.

In addition to the achievements above, Nacken authored numerous papers in the 1930s dealing with phase diagrams and formation of cement minerals, research that had begun as early as 1919. Other work in the gemological field included contributions to the Verneuil technique for growing rubies and sapphires (German and British patent documents, published 1925 and 1926) and a method for distinguishing between natural and cultured pearls (German, British, French, Swiss, and Austrian patents, published in 1927 and 1928).

MATERIALS AND METHODS

In October 1961, Nacken donated a glass vial to the Deutsches Museum (German Museum) in Munich, Germany's largest museum for science and technology. The closed ampoule, inventory number 75218 (figure 2), was described at the time as containing synthetic emeralds grown from 1923 to 1925. This information about the growth period is, to the knowledge of the present authors, the only firsthand information available directly from Nacken. The glass ampoule remained closed until being opened for the first time for this study. Inside were 360 faceted synthetic emeralds and 10 crystals or crystal fragments. The total weight of the samples was 11.15 carats.

Figure 2. This glass vial containing 360 faceted and 10 rough synthetic emeralds was donated by Nacken in 1961 to Munich's Deutsches Museum. The diameter of the vial is approximately 10 mm. Photo courtesy of Deutsches Museum.



In Brief

- In the mid-1920s, Prof. Richard Nacken of Frankfurt grew the first gem-quality synthetic emeralds of facetable size.
- Historical documents establish that he achieved these developments independently, without collaboration with IG Farben. However, a possible cooperation was discussed in the mid-1930s but not pursued.
- The Nacken synthetic emeralds were flux-grown crystals of two principal types, both with natural colorless beryl seeds, but differing in the fluxes used (molybdenum-bearing or molybdenum- and vanadium-bearing compounds).
- These two principal types can be distinguished by growth features, color zoning, inclusions, and chemical properties.

nerton, 1946), and BIOS Final Report No. 552 (Coates, undated). These documents were frequently cited in publications addressing subsequent developments in hydrothermal quartz synthesis for crystal oscillators between 1945 and 1960. Some of these documents also contain limited information about emerald synthesis⁵, but Nacken never described his method in a scientific paper. Circumstances that



Figure 3. Synthetic emeralds produced by Nacken in the mid-1920s. Nacken left these and other samples to his family, and they are now in the possession of his grandsons. The label measures 45 × 23 mm. Photo courtesy of E. Schlatter.

During the course of our investigation, we also learned that a small mineral collection left by Nacken at his death has remained within the family and is in the possession of his grandsons. Contained in a wooden box, this collection similarly comprised various glass ampoules with synthetic gem materials, primarily ruby, sapphire, and spinel boules grown by the Verneuil method. Two such glass containers held synthetic emeralds, but the labels (figure 3) indicated no further details. From these two containers, 77 faceted synthetic emeralds and rough crystals, weighing a total of 9.73 carats, were kindly loaned by E. Schlatter, Nacken's grandson, for this research project. These samples (figure 4) covered all different color varieties and sizes within the two lots. This material had never been examined by mineralogical or gemological methods and had only been inspected visually by family members. No written documentation pertaining to these synthetic emeralds or any other technical information regarding Nacken's work was available from the family.

For comparison, we also examined seven rough samples from the collection of one of the authors (KS). These were initially loaned by Drs. Gübelin and Pough to the author for study and donated after the related paper (Schmetzer et al., 1999) was published. Another synthetic emerald crystal was obtained for

comparison from the reference collection of the German Gemmological Association in Idar-Oberstein.

All 77 samples submitted by the Nacken family (rough and faceted) and approximately 150 faceted synthetic emeralds as well as the 10 rough samples from the vial donated to the Deutsches Museum were examined microscopically in immersion. Visually, it soon became apparent that two primary groups seemed to exist. From these two groups, a total of 75 rough and faceted synthetic emeralds, again covering all sizes and color varieties from the Deutsches Museum and Nacken family samples, were selected for X-ray fluorescence spectroscopy (EDXRF) using a Bruker Tracer III-SD mobile unit. These samples were also examined at higher magnification (up to 1000×) with a Leica DM LM polarizing microscope employing a transmitted light source. For documentation, we used an Olympus DP25 digital camera with Olympus Stream Motion 1.6.1 software.

The previously mentioned eight samples available for comparison from various collections, which were more indirectly linked to Nacken, were similarly examined by the EDXRF and optical methods described in the preceding paragraph.

RESULTS

Chemical, mineralogical, and gemological properties of the Nacken synthetic emeralds studied are summarized in table 1 and described more fully below.

Figure 4. Rough and faceted synthetic emeralds grown by Nacken in the mid-1920s from molybdenum-bearing fluxes (type 1, left) and from molybdenum- and vanadium-bearing fluxes (type 2, right). Colorless seeds are observed with the unaided eye in many of the samples. The largest crystal, in the center left, weighs 0.51 ct and measures 5.5 × 3.5 mm. Photo by K. Schmetzer.

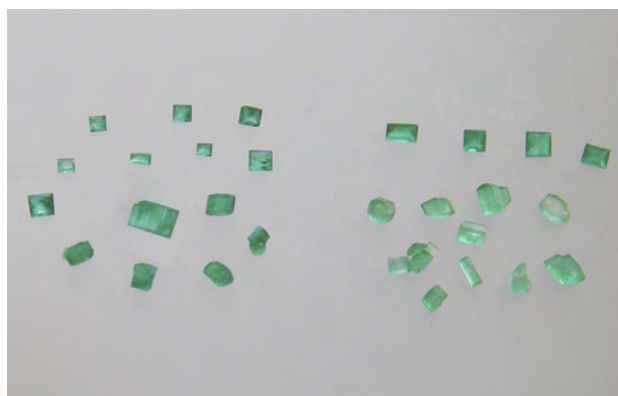

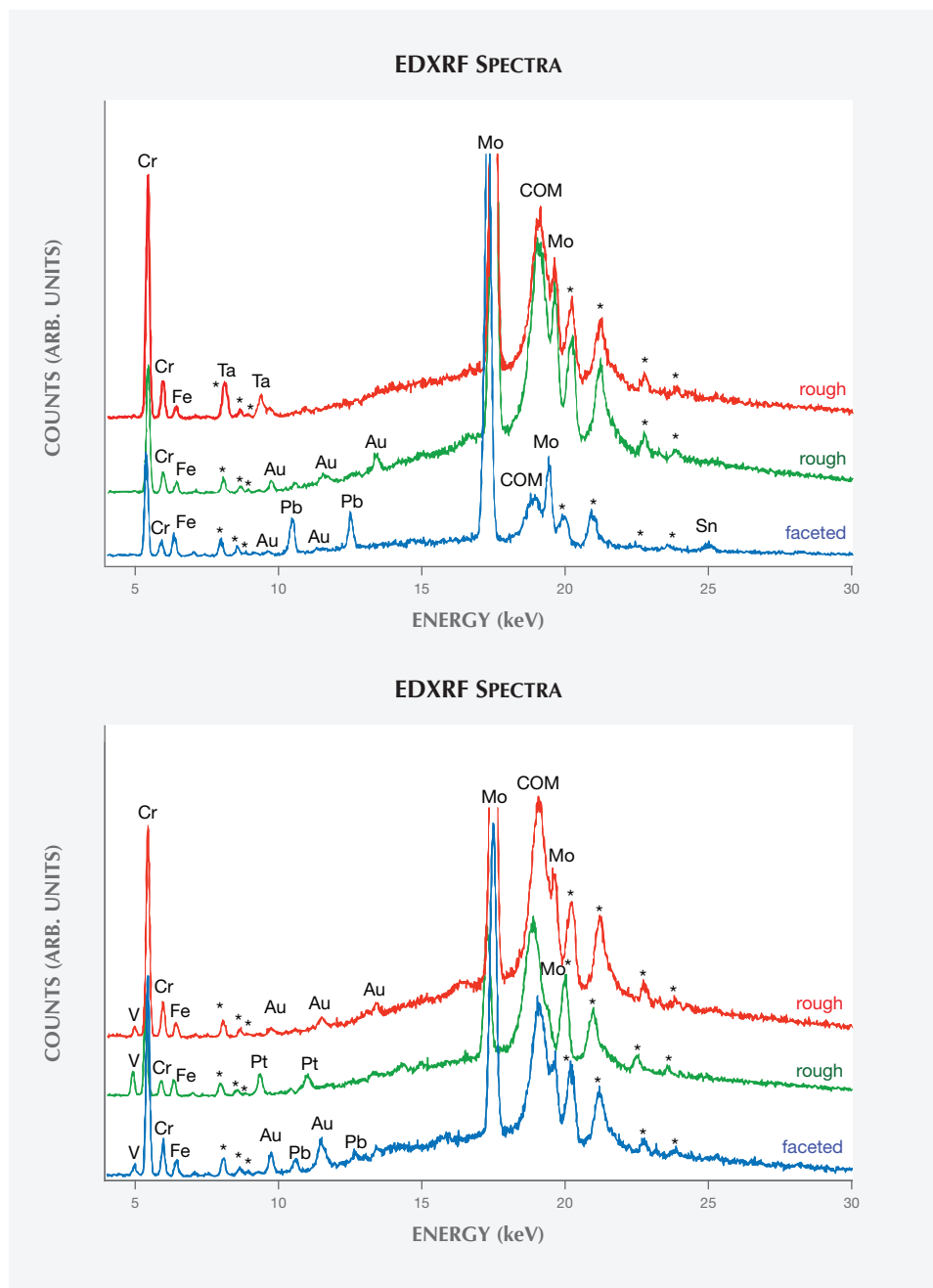

Figure 5. Energy-dispersive X-ray fluorescence (EDXRF) spectra of Nacken type 1 (top) and type 2 (bottom) synthetic emeralds. The rough samples show peaks of color-causing trace elements (Cr and Fe), peaks related to the flux (Mo and V), and peaks related to different crucible materials (mostly Au, rarely Ta or Pt). The faceted samples show additional peaks of trace elements related to the polishing disk (Pb and Sn). The peaks labeled with an asterisk are related to the X-ray tube (Rh) or to interactions with the instrument (Pd, Cu, and Zn); COM refers to Compton scattering (inelastic scattering of the incident radiation).

Chemical Properties. The trace elements revealed by EDXRF clearly distinguished two principal groups of synthetic emeralds (figures 4 and 5), referred to as type 1 and type 2 in the present study. Type 2 comprised samples grown from a molybdenum- and vanadium-bearing flux, and stones of this type have previously been documented and described (Nassau, 1976 a,b, 1978; Schmetzer et al., 1999). Conversely, the type 1 samples were grown from a molybdenum-bearing flux without vanadium, as the latter element was ab-

sent from their X-ray spectra. This type of Nacken synthetic emerald has, to the best of our knowledge, never been mentioned in the literature. Chromium was the main color-causing trace element in both types, with small traces of iron also present.

A third small group, consisting of two samples from the Pough collection, was also grown from molybdenum- and vanadium-bearing fluxes. However, because these two samples differed from the main type 2 group in a key microscopic feature—the

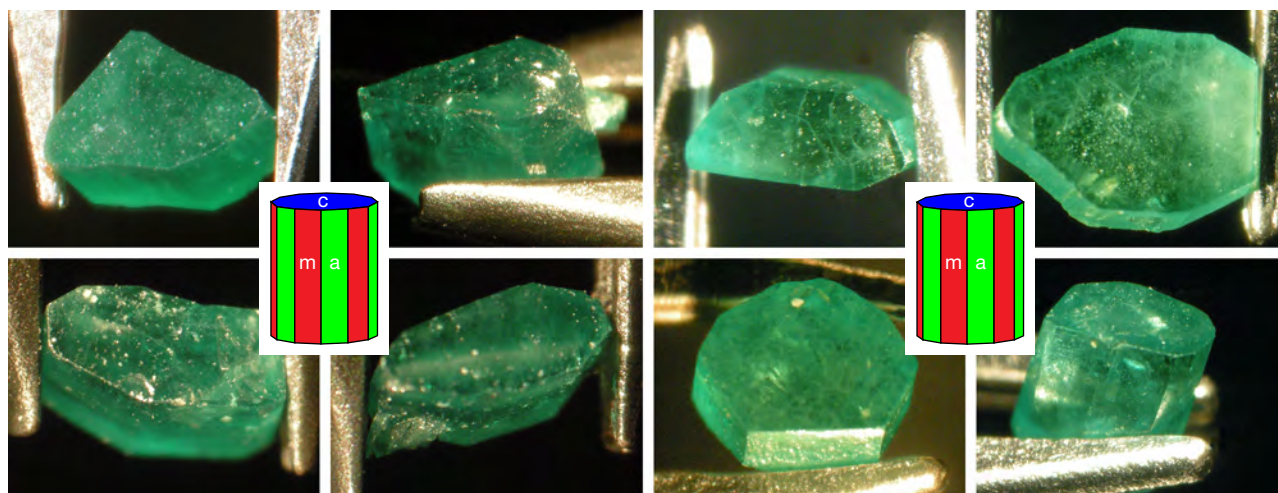

Figure 6. Synthetic emerald crystals grown by Nacken from molybdenum-bearing fluxes (left, type 1, 0.09–0.51 ct) and from molybdenum- and vanadium-bearing fluxes (right, type 2, 0.10–0.21 ct). The inset in the center of each figure shows a clinographic projection of an idealized (undistorted) crystal; the habit of both types consists of first- and second-order hexagonal prism faces m and a , as well as the basal pinacoid c . Photos and drawing by K. Schmetzer.

absence of a colorless seed—they were separated and designated type 3. No type 3 stones were discovered within the samples from the Deutsches Museum or the Nacken family.

The variable intensities of the chromium, vanadium, and molybdenum peaks in the EDXRF patterns indicated that Nacken experimented with various mixtures of fluxes and color-causing trace elements in an effort to obtain the ideal conditions for crystal growth and color. In a few samples, in which large portions of the natural colorless seed (see below) were exposed to the surface, signals assigned to traces of gallium were also observed.

Characteristic X-ray lines for gold or tantalum (in type 1 samples) or for gold or platinum (in type 2 samples) were frequently seen. These emission lines could not be explained by residual flux and were therefore assigned to particles from the crucibles or other containers used for emerald synthesis. In both types, traces of gold were observed most often. Only a smaller fraction of type 1 samples showed tantalum lines, while a similarly small fraction of type 2 samples showed platinum lines. In faceted samples of both types—but not in rough crystals—the characteristic X-ray emission lines for lead or for lead and tin were occasionally present. These trace elements were artifacts of the polishing process, which was performed at that time on wheels composed of lead or a lead-tin alloy.

Crystal Morphology. The rough samples of all three types were prismatic crystals with a habit formed by

first- and second-order hexagonal prism faces m $\{10\bar{1}0\}$ and a $\{11\bar{2}0\}$, in combination with the basal pinacoid c $\{0001\}$ (figure 6). Due to the external form of the natural seed used for growth, the majority of the synthetic emerald crystals were moderately distorted, and in most cases only a subset of the faces of the twelve-sided prism could be observed, normally between eight and ten. An idealized (undistorted) crystal with all twelve prism faces is shown in figure 6 (left and right insets). Some of the crystals, especially from type 1, exhibited somewhat rough and uneven faces and rounded edges, possibly indicating minor dissolution of the completed crystals at the end of the growth period. The largest rough crystal measured approximately $8 \times 6 \times 5$ mm, with a colorless seed of about $6 \times 4 \times 3$ mm, and weighed 1.32 ct. The largest faceted synthetic emeralds approached 4.5 mm in one dimension for rectangular stones (e.g., 4.5×3.0 mm, 4.2×2.3 mm, or 4.0×2.5 mm) and weighed up to 0.15 ct, but most were between 0.05 and 0.10 ct.

Microscopic Features. Colorless seeds, mostly in the 1–2 mm range and rarely as large as 5 mm, were found in all samples obtained from the Deutsches Museum and the Nacken family, as well as in most of the samples available from other collections for comparison (figures 7 and 8). Certain of these seeds, sometimes not larger than 0.5 mm, were not easily recognizable, especially in larger and heavily included stones. Nonetheless, careful examination with the immersion microscope revealed the pres-

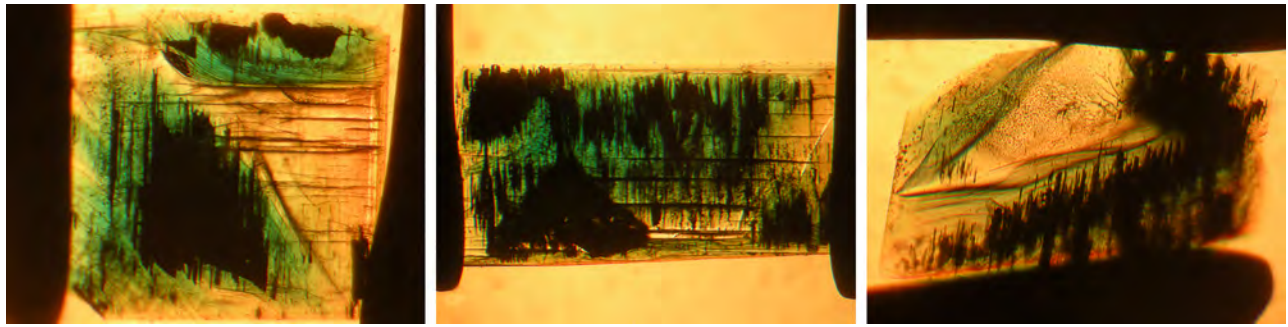

Figure 7. Most type 1 synthetic emeralds grown from molybdenum-bearing fluxes are heavily included. They also show colorless seeds with fluid inclusions (flat cavities) oriented parallel to the basal face. Immersion, field of view 3.2 × 2.4 mm (left), 4.2 × 3.2 mm (center), and 2.5 × 1.9 mm (right). Photomicrographs by K. Schmetzer.

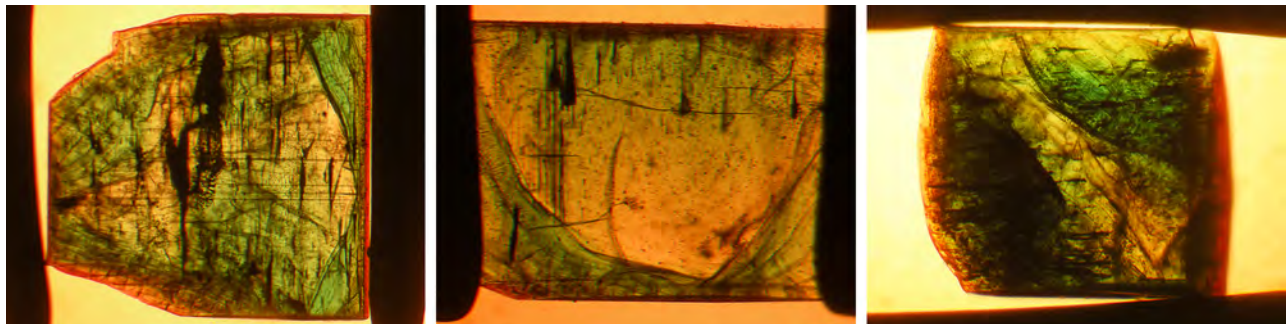

Figure 8. The type 2 synthetic emeralds grown from molybdenum- and vanadium-bearing fluxes are less heavily included. They also show colorless seeds with fluid inclusions (flat cavities) oriented parallel to the basal face. Immersion, field of view 4.6 × 3.4 mm (left), 3.5 × 2.6 mm (center), and 3.8 × 2.8 mm (right). Photomicrographs by K. Schmetzer.

ence of such irregularly shaped colorless seeds in all the synthetic emeralds with the exception of two heavily included samples obtained by one of the authors (KS) in the late 1990s from the Pough collection. As mentioned above, these samples were separated from the two main groups of synthetic emeralds and designated as type 3 (see table 1).

The colorless seeds frequently showed fluid inclusions on planes parallel to the basal pinacoid of the seed crystals (figures 7 and 8). Natural emeralds with

such an inclusion scene are typical for some locations, as observed in samples from the famous Russian deposits in the Ural Mountains (Schmetzer et al., 1991).

The colorless beryl seeds showed no attachment or suspension points. The absence of such features indicated that the seeds floated freely within the molybdate or molybdate-vanadate melt. Even clusters of synthetic emeralds, consisting of three or four intergrown prismatic crystals, contained small seeds in each of the tiny crystals (figure 9). This could be

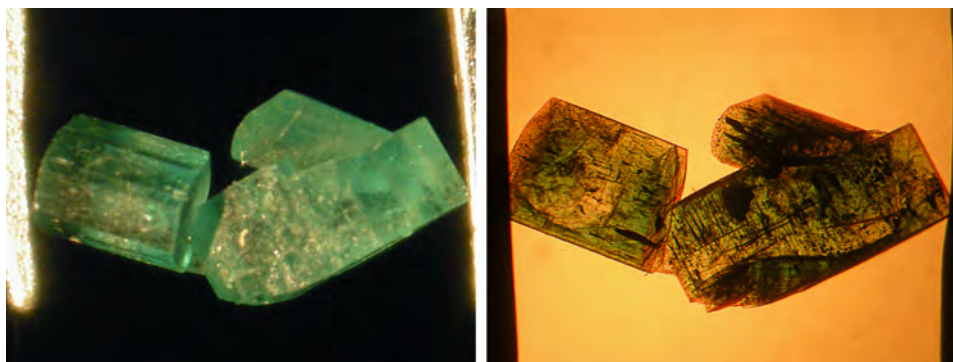

Figure 9. Cluster of type 2 synthetic emeralds grown from molybdenum- and vanadium-bearing fluxes. Each crystal within the cluster likewise reveals an irregularly shaped colorless seed. The sample is shown in daylight (left) and immersion (right); the crystal group is about 7.5 × 4.5 mm. Photos by K. Schmetzer.

TABLE 1. Properties of Nacken flux-grown synthetic emeralds.

| | | Type 1 | | Type 2 | | Type 3 |
|----------------|---|---|-------------------|---|-------------------|--|
| Samples | | Crystals or crystal fragments | Faceted gemstones | Crystals or crystal fragments | Faceted gemstones | Crystals |
| Source | Deutsches Museum, Munich | 3 samples | 359 samples | 7 samples | 1 sample | |
| | Nacken family ^a | 7 samples | 24 samples | 43 samples | 3 samples | |
| | E. Gübelin collection ^b | | | 2 samples | | |
| | F.H. Pough collection ^b | | | 3 samples | | 2 samples |
| | German Gemmological Association, Idar-Oberstein | 1 sample | | | | |
| Morphology | | First- and second-order hexagonal prism plus basal faces | | First- and second-order hexagonal prism plus basal faces | | First- and second-order hexagonal prism plus basal faces |
| Seed | | Colorless seed always present | | Colorless seed always present | | Green seed (?) |
| Growth zoning | | Layers parallel to the surface of the seed, dominant growth planes parallel to s ($11\bar{2}2$), occasionally growth planes parallel to the basal and prism faces | | Layers parallel to the surface of the seed, dominant growth planes parallel to s ($11\bar{2}2$), occasionally growth planes parallel to the basal and prism faces | | Curved boundary between center (seed?) and rim |
| Color zoning | | Intense green layers fading in a direction from the center to the rim or alternating layers of intense green and lighter green or almost colorless zones | | Weak zoning occasionally observed | | Weak zoning between center and rim |
| Inclusions | Growth tubes with nail heads | Occasionally observed | | Frequently observed in all samples | | Frequently observed in both samples |
| | Isolated beryl crystals | Rare | | Common | | Common |
| | Growth tubes without nail heads | Dominant in all samples | | Occasionally observed | | Not observed |
| | Residual flux in various forms | Common | | Common | | Common |
| | Opaque platelets | Occasionally observed | | Occasionally observed | | Observed in one sample |
| Trace elements | Related to flux components | Mo | | Mo, V | | Mo, V |
| | Related to the crucible | Au or Ta | | Au or Pt | | Au |
| | Related to the polishing wheel | Pb or Pb and Sn | | Pb or Pb and Sn | | |
| | Color cause | Cr, minor Fe | | Cr, minor Fe | | Cr, minor Fe |

^a Obtained in 2015 from E. Schlatter, R. Nacken's grandson

^b Obtained by one of the authors (KS) in the late 1990s

established by careful inspection of type 1 and type 2 clusters, guided by the trace-element pattern generated through EDXRF.

In the two type 3 samples from Pough examined for comparison, no colorless seeds could be detected. Both crystals were grown in a molybdenum- and

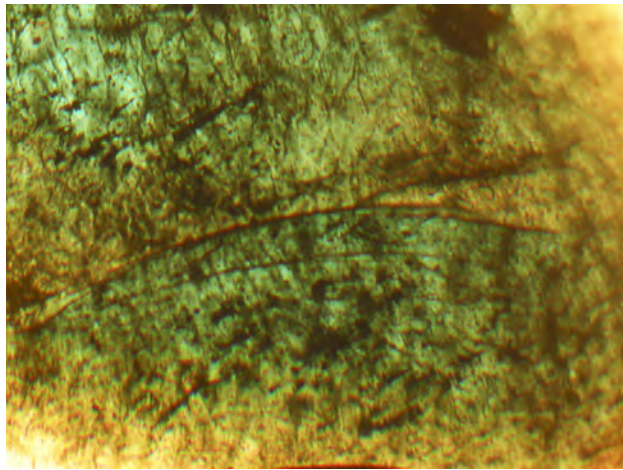

Figure 10. In a few Nacken synthetic emeralds (type 3) submitted by F.H. Pough in the late 1990s to one of the authors (KS), no colorless seeds could be observed. These heavily included samples contained dark green cores, which might indicate the use of natural or synthetic green beryl seeds. Immersion, field of view 2.3×1.7 mm. Photomicrograph by K. Schmetzer.

vanadium-bearing flux and were heavily included. They also showed the typical morphology of Nacken synthetic emeralds. Although not as clearly outlined as the colorless seeds in the other samples, both stones displayed a somewhat deeper green core (figure 10), which could suggest the presence of a natural or synthetic emerald seed.

In type 1 and type 2 synthetic emeralds, growth layers in the first stages of crystal growth followed the external shape of the seed (figures 11 and 12). Subsequent growth proceeded through a period dominated by the hexagonal dipyrmaid $s\{11\bar{2}2\}$, inclined

45° to the c-axis of the emerald crystals (figure 12). This face initially developed more rapidly than the prism faces m and a and the basal pinacoid c . In still later stages, the s face therefore became obscured and was no longer apparent on the surface of the final rough crystals with prismatic habit (figure 13).

It is known that synthetic emerald starts to dissolve in a molybdate melt if the supersaturation of the various components is not sufficient, especially at the end of a growth cycle (Espig, 1960, 1961, 1962). Some irregular growth features in the form of irregular zigzag patterns were observed in several of the crystals (figure 14). These oscillating growth structures were possibly caused by unstable growth conditions, which could include such dissolution processes.

Color zoning in type 1 samples was generally strong, and the following variations could be distinguished:

1. Very intense green growth layers fading gradually from the center outwards, becoming lighter green or almost colorless in the outer regions. In some samples, this pattern with gradually decreasing color intensity repeated several times, indicating multiple growth cycles for the synthetic emerald crystals (figure 15).
2. Alternating intense green and lighter green to almost colorless growth layers, but with sharp boundaries between the intensely colored and lighter areas (figures 11, right, and 12, left and center).
3. Intense green growth (incorporating a small colorless seed) with a light green or almost colorless overgrowth, seen in only a few samples (figure 16).

Figure 11. Growth and color zoning in type 1 synthetic emeralds grown from molybdenum-bearing fluxes. In the center of the crystals, the layers of emerald growth closely follow the outline of the irregularly shaped colorless seed. In later stages, the growth zoning and color zoning are parallel to the prismatic and basal faces of the synthetic emerald crystals. Immersion, field of view 3.5×2.6 mm (left), 3.5×2.6 mm (center), and 2.9×2.1 mm (right). Photomicrographs by K. Schmetzer.

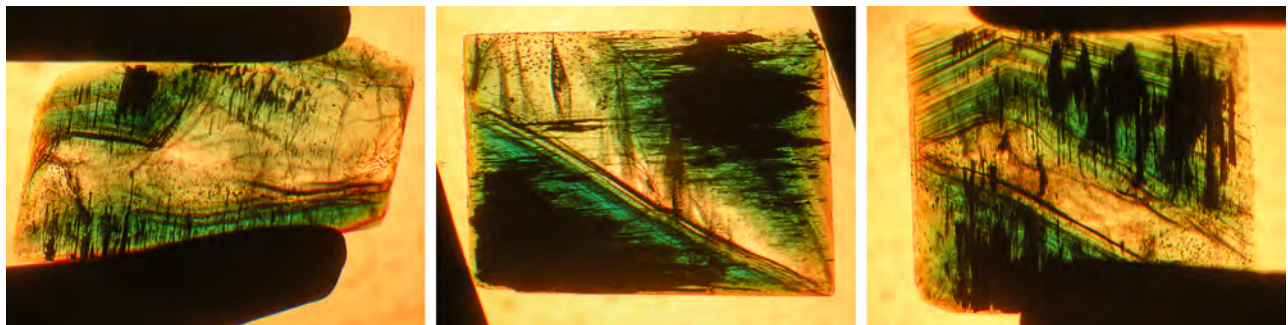

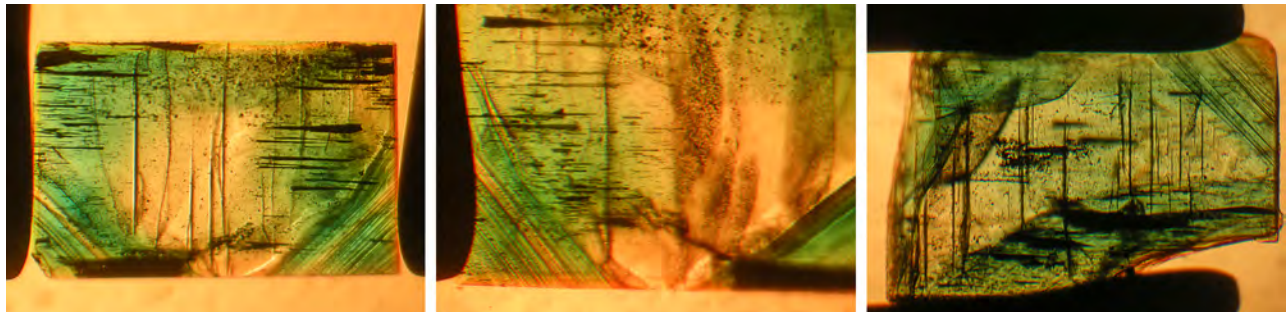

Figure 12. In both types of Nacken flux-grown synthetic emeralds, the fastest-growing crystal face is the second-order hexagonal dipyrmaid *s*, which is inclined at about 45° to the *c*-axis. This face is the dominant internal growth structure observed microscopically, but it is not seen at the end of crystal growth as an external crystal face. The samples shown in the left and center images are type 1, and the sample shown in the photo on the right is type 2. Immersion, field of view 3.2 × 2.4 mm (left), 2.3 × 1.7 mm (center), and 3.7 × 2.7 mm (right). Photomicrographs by K. Schmetzer.

In type 2 samples, only weak color zoning with alternating lighter and darker green zones was observed (figures 8 and 12, right).

Type 1 samples in general were heavily included (figures 7 and 15). The most characteristic features were growth tubes filled with residual transparent or non-transparent flux (figure 17, A–D). These tubes ran parallel to the *c*-axis and were often conical in

shape. When the residual flux was transparent, a contraction bubble was typically visible. Occasionally, a small birefringent crystal was attached to the wider end of the growth tubes (figure 17E). Such crystals were most often found close to the boundary between the natural colorless beryl seed and the green emerald overgrowth. The tiny crystals were birefringent but had a refractive index similar to that of the host. Consequently, they were clearly visible only under crossed polarizers. Wispy veils of residual flux were also common in type 1 synthetics (figure 17F).

In general, type 2 samples were less heavily included (figure 8). Conical growth tubes analogous to those seen in type 1 samples were present, but the

Figure 13. Development of habit in Nacken flux-grown synthetic emeralds. The hexagonal dipyrmaid *s* is the fastest-growing crystal face; therefore, this face is frequently seen as an internal growth feature, but the external morphology generally consists only of the two hexagonal prism faces *m* and *a* and the basal pinacoid *c*. Left: The progressive development viewed in type 1 and type 2 samples can be demonstrated by a clinographic view of three crystals, with the synthetic emerald at the left representing the first stage of crystal growth and the synthetic emerald at the right representing the final state. Right: A cross-sectional view also shows the morphological development in progressive stages of crystal growth. Drawings by K. Schmetzer.

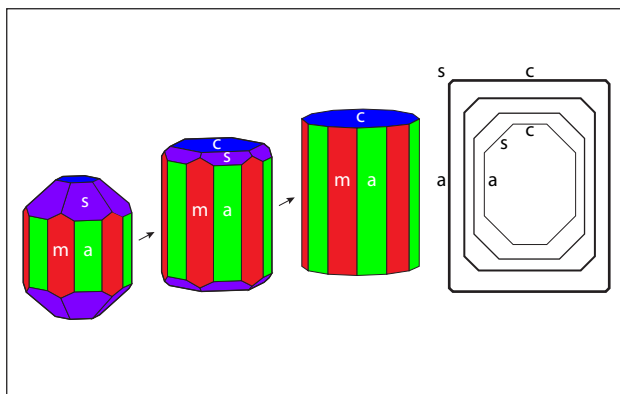
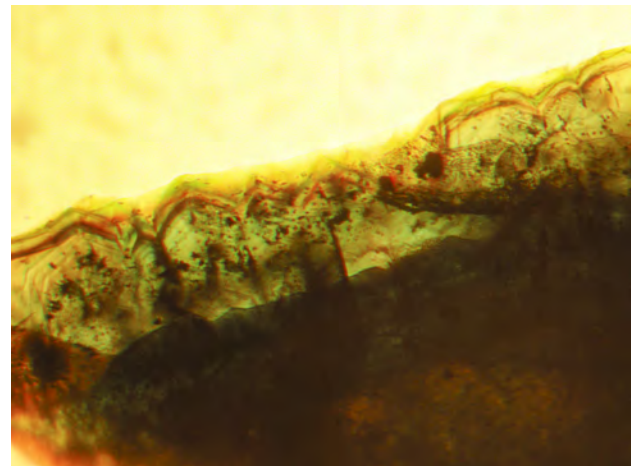

Figure 14. Irregular growth and color zoning in a type 1 Nacken synthetic emerald. In a view parallel to the *c*-axis, the zigzag pattern consisting of growth layers parallel to different prism faces is clearly visible. Immersion, field of view 2.1 × 1.6 mm. Photomicrograph by K. Schmetzer.



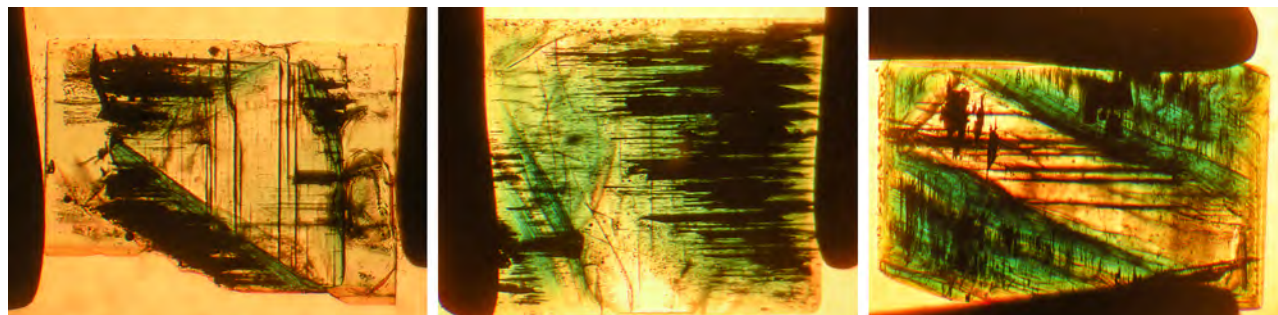
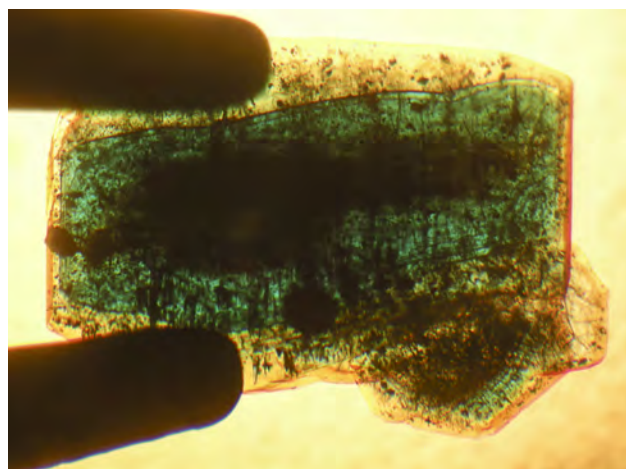

Figure 15. In type 1 samples, grown from molybdenum-bearing fluxes, growth layers often appear intensely green toward the seed, then fade toward the rim. One (left), two (center), or even three (right) such growth cycles may be observed. Immersion, field of view 2.5×1.9 mm (left), 3.8×2.8 mm (center), and 3.0×2.2 mm (right). Photomicrographs by K. Schmetzer.

tiny birefringent crystals attached to the wider ends of the growth tubes were more common. Again, the similarity in refractive index with the host meant that these crystals were best revealed under crossed polarizers, as were other tiny inclusions of the same type not attached to growth tubes (figure 18). The birefringent crystals at the ends of the tubes also frequently contained small inclusions (figure 19, A–E). The residual flux within the growth tubes ranged from transparent with a contraction bubble to inhomogeneous, non-transparent, and even birefringent (figure 19, A–E). Isolated tubes without birefringent crystals at the wider ends were rare in type 2 stones (figure 19F). Somewhat irregularly shaped inclusions

Figure 16. In a few type 1 samples, an intense green core (incorporating a small colorless seed) is overgrown by a very light green, almost colorless layer. Immersion, field of view 3.8×2.8 mm. Photomicrograph by K. Schmetzer.



with various forms of residual flux—transparent or non-transparent, birefringent or non-birefringent—were also seen occasionally (figure 20). Additionally, small particles of residual flux trapped in veil-like feathers were found, often with contraction bubbles visible at higher magnification (figure 21).

The inclusion pattern consisting of conically shaped growth tubes capped by birefringent crystals, forming what gemologists refer to as nail-head spicules, has been the subject of several prior works on Nacken synthetic emeralds. An early description was provided by Wilhelm F. Eppler (1958 a,b). The birefringent crystals were later examined in detail by Raman micro-spectroscopy and identified as tiny emerald crystals with an orientation different from that of the host (Schmetzer et al., 1999). The substances found in the growth tubes were likewise further characterized using micro-chemical and micro-spectroscopic techniques such as electron microscopy, electron microprobe analysis, and Raman micro-spectroscopy (Nassau, 1976 a,b, 1978; Schmetzer et al., 1999). They consisted of mixtures of the flux components (vanadium and molybdenum) and the synthetic emerald ingredients (aluminum, silicon, and chromium). These fillings were either transparent, representing a glassy state, or translucent to opaque, and sometimes even partially birefringent, representing multiple states of phase separation (e.g., formation of a bubble in the melt), as well as incomplete and complex devitrification processes including recrystallization of the flux after cooling. Interestingly, various forms of trapped flux in different states were found close together in the same host crystal.

Type 1 and type 2 synthetics also occasionally showed included emerald crystals not attached to

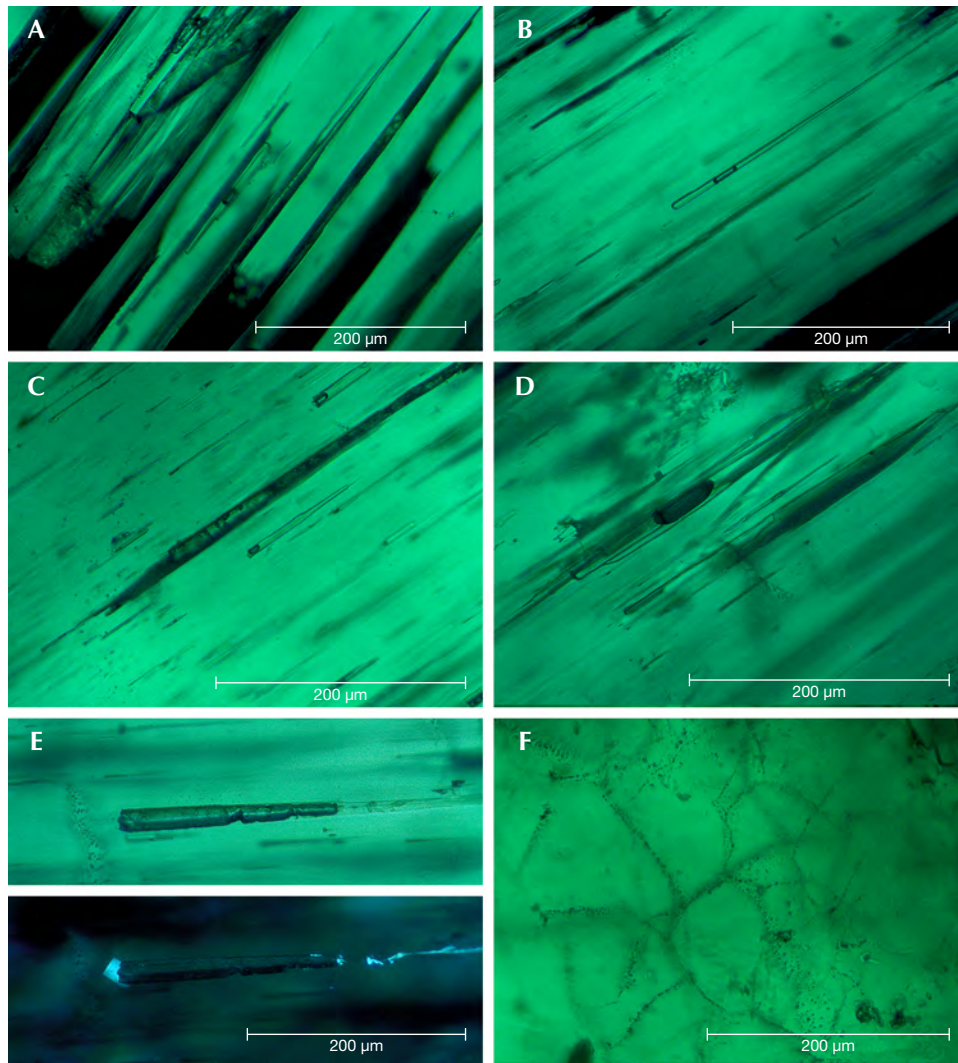

Figure 17. At higher magnification, type 1 synthetic emeralds frequently show growth tubes with contraction bubbles and otherwise transparent or only translucent, partly devitrified fillings (A–D, in transmitted light). Attached to the wider end of these conical growth tubes, a birefringent beryl crystal is occasionally seen, shown here in transmitted light (E, top) and crossed polarizers (E, bottom). Veil-like feathers consisting of small residual flux particles are also observed (F, in transmitted light). Photomicrographs by H.A. Gilg.

growth tubes. Such inclusions had been formed by spontaneous nucleation. Larger inclusions of this nature contained various forms of residual flux (figure 22), comparable to the inclusions seen in the synthetic emerald host.

Tiny opaque platelets with a hexagonal or trigonal shape were another notable inclusion feature (figure 23). Analogous platelets have been recognized in flux-grown gem materials (e.g., emeralds, rubies, or sapphires) and identified as platinum platelets originating from the platinum crucibles used for crystal growth. In the present study, trace-element analyses most often indicated a gold component corresponding to growth in gold containers. Because hexagonally or trigonally shaped gold platelets are known to be formed under various synthetic growth conditions (Morriss et al., 1968; Smart et al., 1972; Engelbrecht and Snyman, 1983; Lofton and Sigmund,

2005; Liu et al., 2006), characterizing the platelets evident in many Nacken emeralds as gold seems reasonable. Similar gold platelets with hexagonal and trigonal outlines were described in Biron synthetic emeralds grown in Perth, Australia (Kane and Liddicoat, 1985).

Type 3 Nacken synthetic emeralds exhibited a similar inclusion pattern of nail-head spicules, tiny isolated beryl crystals, and various forms of flux.

TECHNOLOGY OF CRYSTAL GROWTH

A general overview tracking the primary information published to date about the crystal growth technology applied by Nacken in the 1920s (Van Praagh, 1946, 1947 a,b; Osborne, 1947; Fischer, 1955) and the sources for the research samples underlying the major extant gemological descriptions of these synthetic emeralds (Eppler, 1958 a,b; Nassau, 1976 a,b,

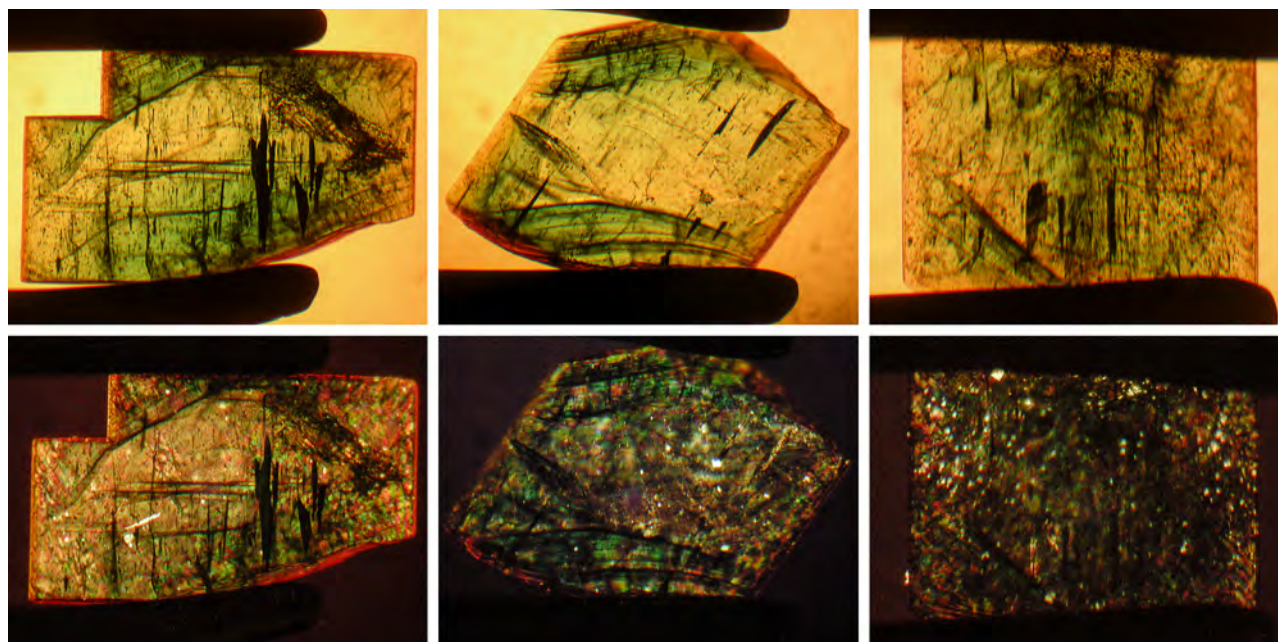

Figure 18. In type 2 samples, numerous nail-head spicules are observed, each consisting of a flux-filled conical tube with a tiny birefringent beryl crystal at the wider end of the tube. These beryl crystals, as well as other beryl inclusions that are not attached to a growth tube, have a refractive index close to that of the host and therefore are often seen only under crossed polarizers. The samples are shown in immersion, in the same orientation in transmitted light (top) and under crossed polarizers (bottom); field of view 4.9×3.7 mm (left), 4.3×3.2 mm (center), and 3.2×2.4 mm (right). Photomicrographs by K. Schmetzer.

1978; Schmetzer et al., 1999) is given in figure 24. All samples previously examined were grown in molybdenum- and vanadium-bearing fluxes. In contrast, the samples submitted by Nacken to the Deutsches Museum consisted mainly of faceted stones grown without vanadium as a component of the flux. Another sample grown in a vanadium-free flux was found in the reference collection of the German Gemmological Association during the course of this study. The samples loaned to the authors by the Nacken family comprised both principal types.

Primary Sources. As previously noted, various Allied government documents were generated after World War II from investigations into German scientific activities. In several of these, dealing mainly with growth of quartz and other piezoelectric crystals, isolated statements by Nacken about synthetic emeralds can be found⁵, but only PB 85147 contains significant information. Written by R.M. Osborne (1947) and based on an interview of Nacken by Leon Merker⁶, this report notes:

A stoichiometric mixture of alumina and beryllia is prepared as a paste and dried. This is gradually fed into a molten mixture of potassium carbonate and vanadium pentoxide at $900\text{--}950^\circ\text{C}$ in a gold crucible. Quartz is simultaneously fed into the melt in the form of small quartz pieces. The crystallization process is seeded with small emeralds and beryls. The crystallization is slow and only small emeralds are said to be produced. It was stated that the emeralds could be increased in size by removing them from the melt in which they were grown and placing them in a fresh melt of the same composition.

In contrast to this clear description of a flux-growth process, Van Praagh⁷ (1946, 1947 a,b) described Nacken's synthesis of both emeralds and quartz as hydrothermal. He stated that Nacken synthesized different minerals "by crystallizing them from water or dilute aqueous solution in the neighborhood of the critical temperature of water. By 1928 he had succeeded in synthesizing a number of minerals including feldspars, mica and beryl." Van Praagh further mentioned growth on a seed crystal in an autoclave:

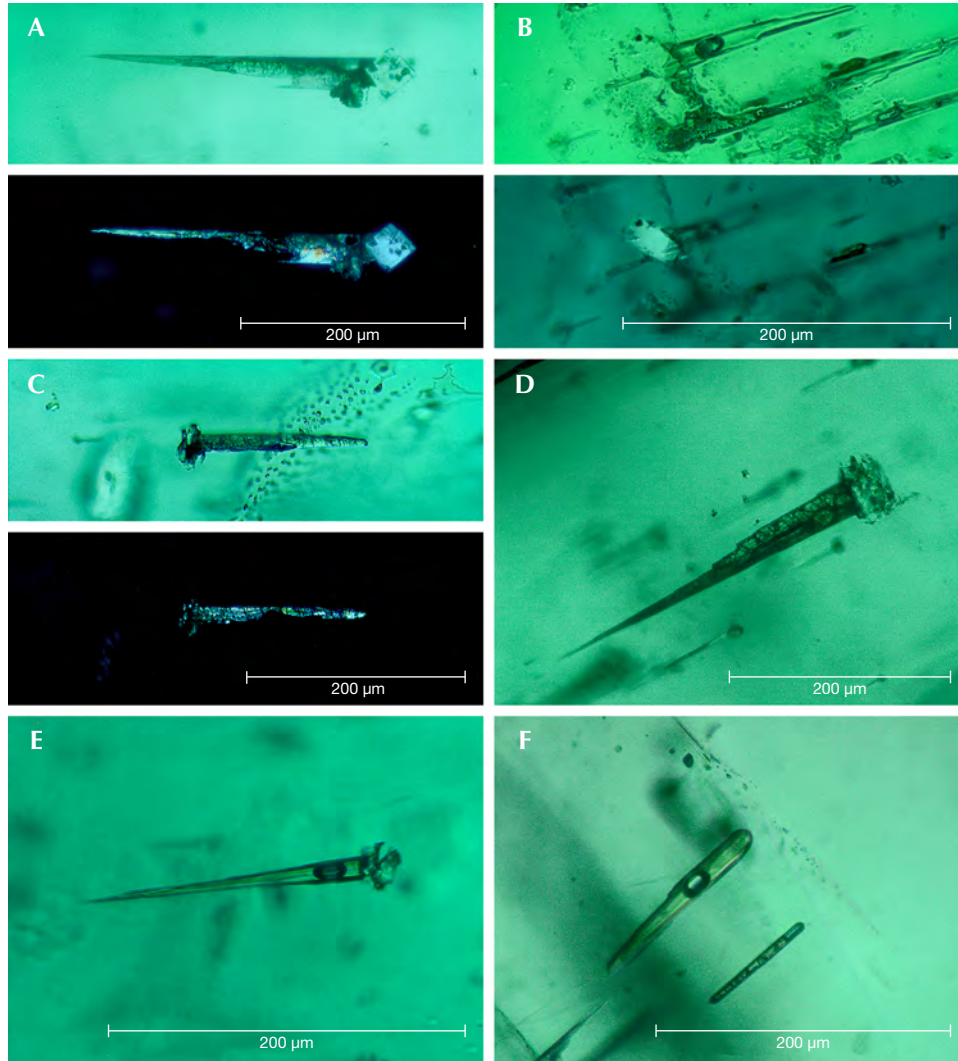

Figure 19. At higher magnification, type 2 synthetic emeralds frequently show growth tubes with contraction bubbles and otherwise transparent or translucent, partly devitrified fillings. A birefringent beryl crystal is typically attached to the wider end of these growth tubes (A–E). Examples A–C are shown in transmitted light (top) and crossed polarizers (bottom), D–F in transmitted light. Photomicrographs by H.A. Gilg.

The vessel of the autoclave was lined with silver and the seed crystal was suspended from a silver wire. The rough material consisting of a mixture of beryllium

oxide, alumina and silica in the correct proportions was placed in the autoclave, which was then closed and the temperature raised to about 370–400°C. It was main-

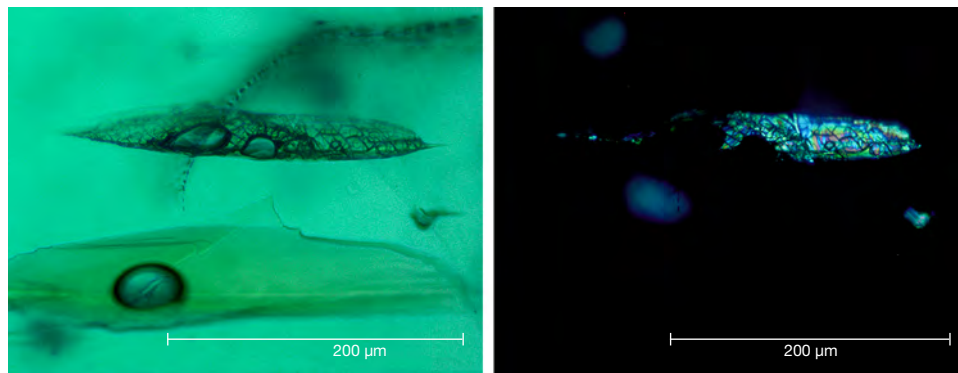

Figure 20. In type 2 samples, residual flux is trapped in various forms, either transparent (glassy) or at least partly translucent and devitrified (left). Under crossed polarizers, portions of the residual flux are shown to be birefringent (right). Contraction bubbles are common. Photomicrographs by H.A. Gilg.

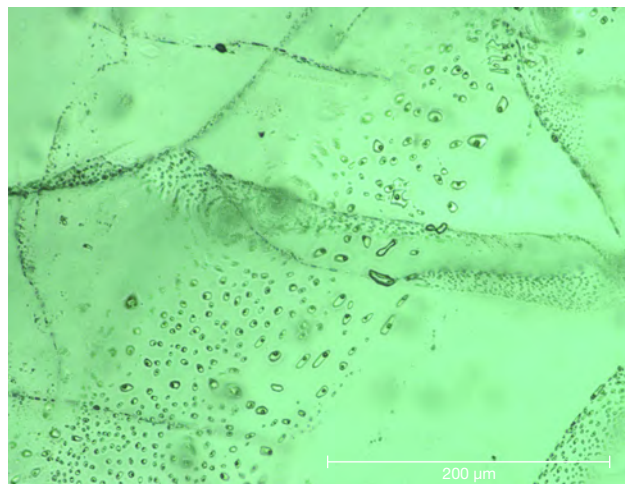

Figure 21. Veil-like feathers consisting of small residual flux particles are also observed in type 2 samples, often with tiny contraction bubbles in the trapped flux. Photomicrograph by H.A. Gilg.

tained at this value for a few days.... Finally Nacken was able to make crystals of beryl (colored green with a trace of chromium to turn them into emeralds) that were up to 1 cm in length and 2 to 3 mm in width.

In 1955, Walther Fischer⁸ wrote a paragraph about Nacken's synthetic emeralds in an encyclopedia review article about synthetic gemstones [translated from German]:

In 1925 R. Nacken succeeded in growing emerald crystals of remarkable size. He suspended a beryl seed crystal within a melt consisting of acid lithium molybdate to which he added a mixture of Al_2O_3 , SiO_2 , and BeO . In addition to the presence of small amounts of water, an excess of SiO_2 is important, which has to be calculated according to the other components. To achieve the desired coloration, traces of Cr_2O_3 and Fe_2O_3 are added. The application of pressure is unnecessary. Great difficulties came from problems with the appropriate selection of the right materials. Nacken worked with gold and silver containers.

Correlation of Primary Sources with Experimental Results.

The results of the present study are consistent with previous research (Nassau 1976 a,b, 1978; Schmetzer et al., 1999), insofar as they confirm flux growth of Nacken synthetic emeralds. The experimental results also augment the existing literature through identification of a new type of Nacken synthetic emerald. In addition to those stones known to have been grown from molybdate-vanadate fluxes (designated as types 2 and 3 herein), a variation grown from molybdenum-bearing fluxes without a vanadium component has now been identified. Conversely, we discovered no Nacken samples lacking entirely in flux residues (as proven by a combination of EDXRF and microscopy), which would have suggested hydrothermal growth. This conspicuous absence raises questions about the origin of the

Figure 22. Larger inclusions of beryl crystals formed by spontaneous nucleation are occasionally found, as in this type 2 example. The included beryl crystal exhibits a core with a high concentration of trapped flux particles and a clear rim. The boundary between the almost clear rim and the host is best seen under crossed polarizers. Transmitted light (left), with crossed polarizers (right). Photomicrographs by H.A. Gilg.

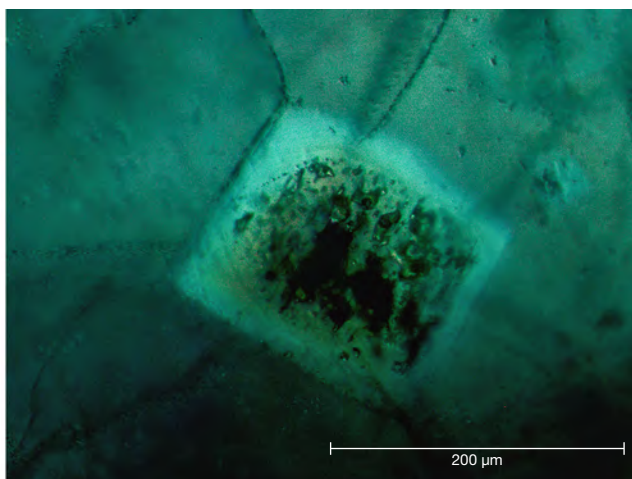
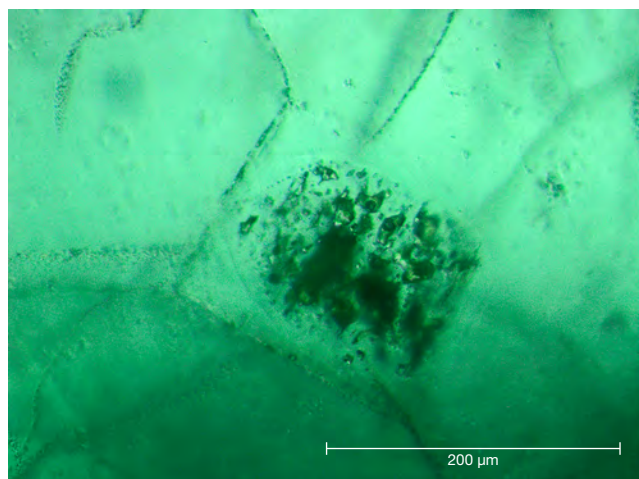

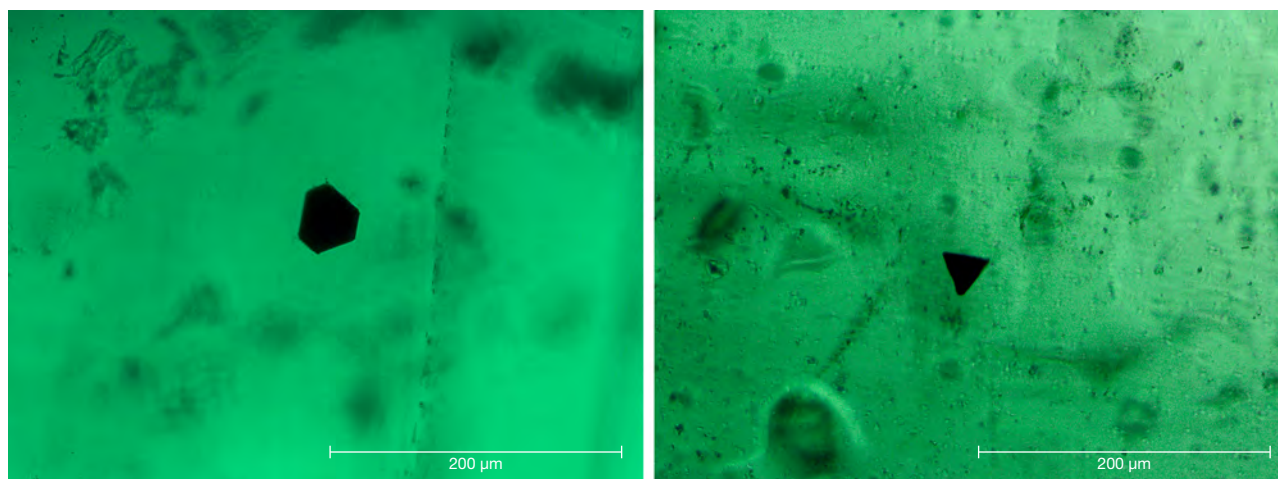

Figure 23. In type 1 (left) and type 2 (right) synthetic emeralds, in which the presence of gold is proven by EDXRF analyses, hexagonally or trigonally shaped opaque particles are found, most likely originating from gold crucibles or containers used for crystal growth. Transmitted light, photomicrographs by H.A. Gilg.

information detailed in Van Praagh's publications (1946, 1947 a,b).

As noted above, Van Praagh and other American and British government personnel interviewed Nacken several times in 1945 to acquire scientific

and technical information about the German program for substituting hydrothermally grown crystals for natural quartz in electronic devices⁹, as summarized by Swinnerton (1946) in document PB 28897. None of the government documents generated from

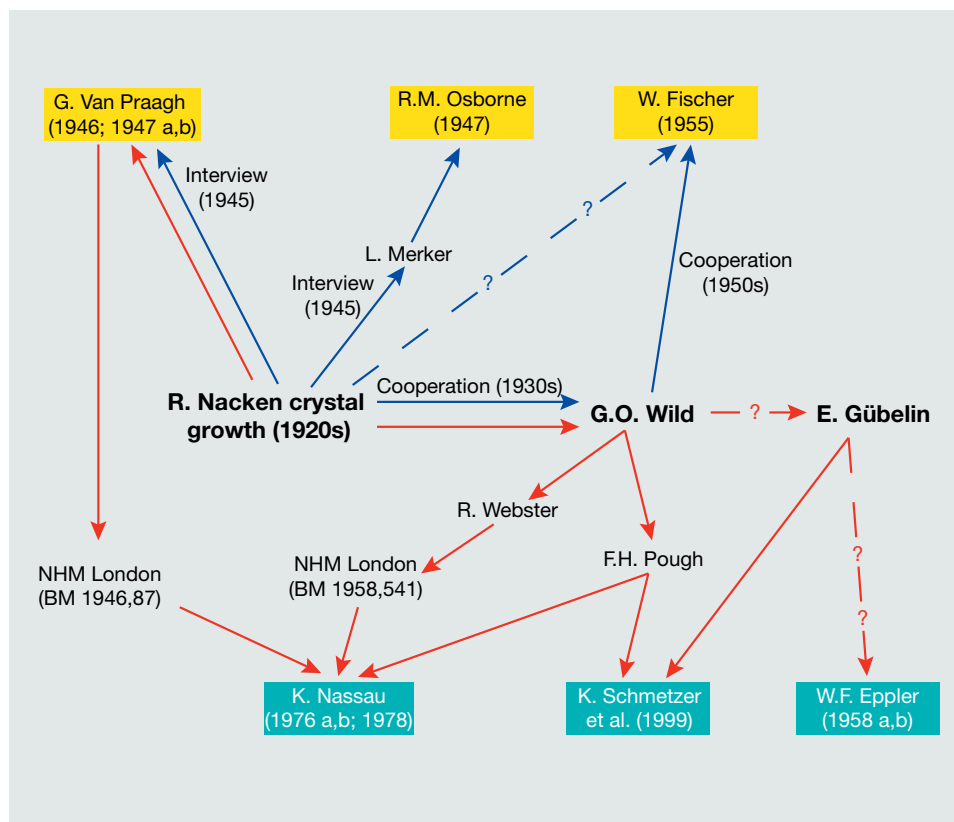

Figure 24. Schematic overview of the information obtained in the 1940s and 1950s, leading to publications by Van Praagh, Osborne, and Fischer (represented by yellow boxes) on the growth technology applied by Nacken. The diagram also incorporates the major papers describing properties of Nacken synthetic emeralds, published by Eppler, Nassau, and Schmetzer et al. (represented by light blue boxes), and shows the source(s) of the information (blue arrows) and samples (red arrows) used for these studies; BM represents inventory numbers of the Natural History Museum. Question marks indicate possible sources suggested by the known circumstances but not proven by original documents.

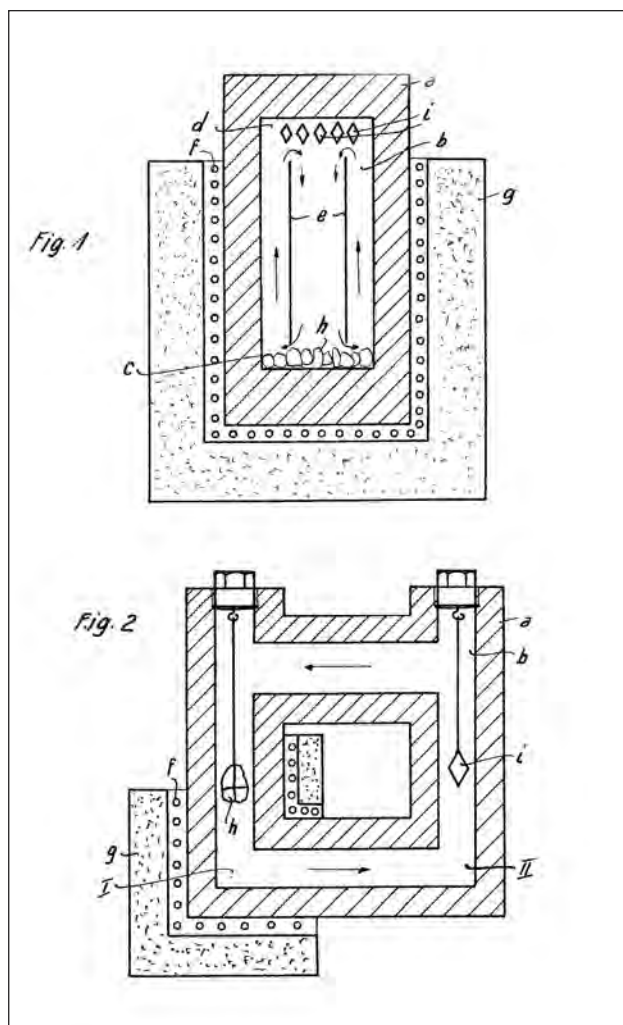

Figure 25. A patent application by R. Nacken and I. Franke, filed June 25, 1943, and published due to circumstances of World War II as German patent 913 649 in 1954, shows the use of autoclaves for hydrothermal synthesis of quartz and other minerals with the application of a vertical (top) or horizontal (bottom) temperature gradient. From German patent 913 649, a—autoclave, b—internal chamber of the autoclave, c—lower part with nutrient, d—upper part, e—tube of silver, f—heater, g—insulation, h—nutrient, and i—seed. I indicates the column in which the nutrient is placed, and II indicates the column in which the seed is placed. Through the application of a vertical or horizontal temperature gradient, the nutrient region is kept at a higher temperature and, as material is dissolved in the solution, it is transported to the growing crystal at the seed, which is kept at a lower temperature. The circulation of the solution is indicated by arrows.

these various interviews with Nacken mentioned any of his unpublished patent applications in this

field. One such application¹⁰, originally filed June 25, 1943, by Nacken and Immanuel Franke, became German patent 913 649, published June 18, 1954.

The 1954 patent document described the use of autoclaves with vertical or horizontal temperature gradients for the growth of single crystals (figure 25). This technique became the basis for the development of a nascent industry, in the United States and elsewhere between 1945 and 1960, focused on growing quartz for technical applications such as crystal oscillators. That work, in turn, led to the modern-day mass production of synthetic quartz. Single-crystal quartz was highlighted as the most important material to be grown in the Nacken and Franke patent, but the patent also mentioned possible use of the method for synthesizing other minerals such as beryl, tourmaline, mica, fluorite, corundum, and as-

Figure 26. Richard Nacken in 1954, at the age of 70. Photo courtesy of E. Schlatter.



bestos. Whether those minerals had already been synthesized successfully was not indicated. Continued work by Nacken (figure 26) in the field of autoclaves and hydrothermal mineral synthesis is further evidenced by a patent document dated from the late 1950s (Nacken and Kinna, 1959).

According to the existing literature, hydrothermal synthesis of emerald began with Johann Lechleitner in Austria in the late 1950s or early 1960s (Holmes and Crowningshield, 1960; Schloßmacher, 1960; Gübelin, 1961; Schmetzer, 1991), and the method was only disclosed a decade later in several US patents assigned to the Linde Division of Union Carbide Corporation and in related scientific papers (Flanigen et al., 1967; Flanigen and Mumbach, 1971; Flanigen, 1971). Another development of the 1960s was the flux growth of synthetic emerald by spontaneous nucleation or by seeded growth with natural beryl or emerald used as nutrient (not starting from the separate chemical components of beryl). Successful results were achieved with a flux of lead vanadate (Linares et al., 1962; Lefever et al., 1962; Linares, 1967; Flanigen and Taylor, 1967; Koivula and Keller, 1985; Bukin, 1993). Commercial growth of gem-quality synthetic emerald using natural beryl as nutrient has been documented for flux material produced by Gilson near Calais, France (Diehl, 1977), and for the Biron hydrothermal synthetic emerald produced in Perth, Australia (Brown, 1997).

Given the foregoing circumstances, the logical conclusion is that misunderstandings between Nacken and Van Praagh during the 1945 interview led the interviewer to assume that the synthetic emeralds grown in the 1920s had been created hydrothermally. Yet nothing suggests that the technology for hydrothermal growth of emerald was available in the 1920s. Furthermore, Nacken's application of such a technique cannot be proven by any known samples and would seem particularly unlikely since his primary work in developing the hydrothermal method for quartz growth occurred two decades later, between 1939 and 1945. Buttressing this conclusion, Van Praagh later donated samples he had obtained from Nacken to the Natural History Museum in London (Van Praagh, 1946, 1947a), and these were proven by Nassau (1976 a,b, 1978) to be flux-grown synthetic emeralds.

In contrast, the properties found in the present study of the flux-grown synthetic emeralds correlate with the data recorded by Osborne (1947, documenting Merker's 1945 interview with Nacken) and Fischer (1955, using information given by Nacken or,

more likely, his colleagues in Idar-Oberstein). Nonetheless, we must remember that the historical information is somewhat generalized in nature, given that it was obtained at least two decades after Nacken had stopped his practical work growing synthetic emerald and in a context where there would have been little incentive for him to disclose any more than basic background.

That said, the consistencies are notable. Both the crucibles and the fluxes indicated by the present study find corroboration in the Osborne and Fischer writings and in the practices of the time. EDXRF analysis proved that Nacken used gold containers for most of his synthesis experiments, and Osborne and Fischer likewise mentioned his use of gold crucibles. Platinum, found in a few samples as a trace element, was and is a common crucible material applied in various chemical technologies, while tantalum is a cheaper alternative to platinum and also offers high corrosion resistance (Kieffer and Braun, 1963). It is a matter of speculation whether Nacken seriously investigated the use of growth facilities larger or more complex than simple gold or platinum containers or crucibles, but it seems he at least tried to use cheaper materials such as tantalum. The two main components of the fluxes seen in this study, molybdenum and vanadium (in the form of a molybdenum-bearing compound for type 1 emeralds and a molybdenum-compound together with a vanadium-bearing compound for type 2), were similarly mentioned in the literature (lithium molybdate by Fischer, vanadium oxide by Osborne). Moreover, French scientists had long used both molybdenum and vanadium in fluxes to grow synthetic emerald, although not in combination, but the resulting crystals only reached about 1 mm in size (Hautefeuille and Perrey, 1888, 1890).

Another historical parallel is found in Osborne's allusion to multiple growth cycles. From the present study, it can be concluded on the basis of color zoning that at least two, and occasionally three, growth cycles were performed for most of the samples, with a higher percentage of chromium incorporated into the beryl structure at the beginning of each growth cycle. A similar observation was made recently for flux-grown synthetic alexandrite (Schmetzer et al., 2012).

A final point of historical relevance derives from the prime technical challenge of the day. In the first half of the 20th century, emerald synthesis was plagued by the formation—through spontaneous nucleation—of clusters of tiny crystals. To avoid this scenario, IG Farben in Bitterfeld used platinum cru-

cibles in which part of the nutrients (beryllium oxide and aluminum oxide) were separated from the remaining emerald component (SiO_2 in the form of vitreous silica). As described by Espig (1960, 1961, 1962), this separation was accomplished by placing the BeO and Al_2O_3 nutrients at the bottom of the crucible, suspending beryl seed crystals below a platinum net or baffle in the upper part of the platinum container, and floating silica plates on top of the lithium molybdate melt (Schmetzer and Kiefert, 1998). Nacken, too, must have successfully applied the same principle of separating the nutrient into two parts (feeding a beryllia and alumina paste into the flux melt and separately adding quartz pieces), while also using beryl seeds (see Osborne, 1947).

POSSIBLE COOPERATION WITH IG FARBEN

In papers on the history of synthetic emerald (Nassau, 1976 a,b), and particularly in a detailed report on those grown by Nacken (Nassau, 1978), the possibility of cooperation between Nacken and Igmerald producer IG Farben was discussed. Despite differences identified in the fluxes they used, Nassau argued that Nacken's lack of inclination to publish details about his emerald synthesis or to attempt commercialization might suggest a secret collaboration with the mineralogists at IG Farben in Bitterfeld, particularly Espig.

However, in his descriptions of the growth process applied at Bitterfeld for emerald synthesis (1960, 1961, 1962), Espig still followed the assumption prevalent in the 1950s literature and referred to Nacken's work as hydrothermal. To have stated so in his 1962 publication indicates that Espig had no direct information about Nacken's technology and, accordingly, that the two did not cooperate in developing crystal growth methods.

Nonetheless, historical sources establish communications dealing with such a possible collaboration in the mid-1930s. Specifically, a file containing correspondence between IG Farben and Nacken, along with related internal reports and comments by IG Farben staff members, was discovered by one of the authors during recent research into the industrial history of Verneuil synthesis at the Bitterfeld plant¹¹ (Vaupel, 2015).

In 1933, Nacken contacted IG Farben and asked if there had been any progress in the emerald synthesis project. Later, in January 1936, Nacken consulted one of the company's directors and offered to cooperate, mentioning that he had already grown synthetic emerald successfully. At that time, Nacken

was likely aware of IG Farben's breakthrough in emerald synthesis, announced in several mid-1935 articles, and he would also have been informed that the company did not intend to pursue commercial production (Jaeger and Espig, 1935). Nacken and IG Farben exchanged samples at the end of January 1936. Nacken remarked in an accompanying letter that while he had obtained growth of 2 mm per month, the optimal growth rate to produce clearer samples would be somewhat slower.

The three samples submitted by Nacken to IG Farben were inspected by Espig at the company and by E. Schiebold at the University of Leipzig. Schiebold (1935) had previously examined IG Farben samples and written about the properties of Igmeralds. Both prepared reports of their inspections. Schiebold specified that the samples were of synthetic origin, but neither report described whether the synthetic emeralds contained any natural or synthetic seeds. Each report also mentioned the presence of nail-head spicules. In contrast to his later publications from the 1960s (presumably influenced by Van Praagh's writings), Espig concluded that the growth method might have been similar to that used by IG Farben. He added that, given the unfavorable bluish green color and high content of impurities, the quality of Nacken's samples was no better, and possibly even worse, than that of the samples produced at Bitterfeld. Since the Igmeralds could be grown at rates between 1.2 and 3 mm per month, purchasing Nacken's technical know-how offered no apparent opportunity for improving the quality or growth technology of the IG Farben production.

During a final consultation with Nacken and his lawyer in March 1936, IG Farben representatives stated that the question of whether the company would pursue commercial production of synthetic emeralds could not be answered affirmatively at that time. A decision to move forward would require an ability to produce larger samples of better quality. Therefore, they declined to pursue Nacken's technology.

The facts described above, all based on recently discovered letters and internal IG Farben communications and reports¹¹, prove that development of emerald synthesis by Nacken at the University of Frankfurt and by Espig at the IG Farben plant in Bitterfeld occurred independently. There was, however, another personal connection between Nacken and IG Farben that in all likelihood did play a role in the history of emerald synthesis.

In 1913 a young mineralogist named Otto Dreibrodt¹² was hired by Elektrochemische Werke

Bitterfeld (which became part of IG Farben in 1925). Prior to this employment, Dreibrodt had already invented an apparatus for crystal growth in solutions or melts, and in his new position he was tasked with developing novel techniques for crystal growth and applying known methods to new materials, including synthetic emeralds. Elektrochemische Werke Bitterfeld also applied for German and international patents covering the apparatus previously invented by Dreibrodt, after rights to the device had been transferred to the company by contract. A German patent 273 929 was granted in 1914, and the corresponding US patent was published in 1920¹³.

To work with a melt and not only with hydrous solutions, the complex apparatus was constructed of platinum and used, at least temporarily, in Bitterfeld for emerald synthesis experiments¹⁴. However, problems with oversaturation of the melt and spontaneous nucleation of tiny emerald crystals or aggregates could not be solved, and no emeralds of facetable size were obtained from the experiments. Dreibrodt left the company at the end of 1926, three years before Espig's major breakthrough in emerald growth at IG Farben (in the fall of 1929).

Nacken was one of Dreibrodt's academic instructors at the University of Leipzig, and both scientists were focused on crystal growth and mineral synthesis. Moreover, after Nacken married Dreibrodt's sister Berta in 1912, the two families were always in close contact (E. Schlatter, pers. comm., 2015). Nacken (1952) described and depicted Dreibrodt's apparatus in a treatise on methods for crystal growth, and he presumably had become aware of the patent soon after its publication in 1914. In light of these many connections, it can be assumed that the two scientists discussed academic problems of mineral synthesis and that Nacken would have heard about IG Farben's difficulties in developing a useful method for synthesis of larger, facetable emerald crystals. It is possible that such conversations prompted Nacken to contemplate alternative solutions, which, in turn, might have led to the development of his successful method for emerald synthesis.

It could be that Nacken contacted IG Farben in 1936 and offered his technique after noticing from the company's announcements that commercial application of the Igemerald technology was not intended, despite almost two decades of research¹⁵. Nonetheless, it remains unclear why Nacken neither published his results nor tried to commercialize his technique in the mid-1920s. From a brief comment

in a 1951 publication by Fritz Klein¹⁶, it appears that faceted synthetic emeralds produced by Nacken were shown to Klein for evaluation in the 1930s. In all likelihood, however, the reception given to Nacken's synthetics by Klein or any other trade members queried would have paralleled the reaction of emerald dealers to the introduction of synthetic emeralds to the market by IG Farben. Stated succinctly, none of the German companies dealing in faceted natural emeralds were interested in supplementing their established product range of natural stones with synthetics. What is known is that Nacken never ceased to be interested in further developments in the field of emerald synthesis. Indicative of such ongoing curiosity, his grandsons found among his papers a newspaper clipping from 1965 that described the recent success in synthetic emerald growth achieved by Walter Zerfass of Idar-Oberstein.

CONCLUSIONS

During the mid-1920s, Richard Nacken was able to grow the first synthetic emeralds of facetable size and quality. New details about his work have emerged, augmenting previous studies that were based on a limited number of samples and interviews from the 1940s.

We have shown that Nacken produced synthetic emeralds of two principal types: (1) crystals grown in molybdenum-bearing fluxes, and (2) crystals grown in molybdenum- and vanadium-bearing fluxes. Both were created primarily in gold containers using a process that added various ingredients such as BeO and Al₂O₃ separately from the third major beryl component, SiO₂. Nacken typically employed small, colorless, irregularly shaped beryl seed crystals of 0.5 to 5 mm and attained faceted synthetic emeralds reaching up to 4.5 mm and 0.15 ct. Characteristic internal features include colorless cores, color zoning, and oriented inclusions such as nail-head spicules, all of which reflect the experimental conditions of crystal growth. The two principal types of synthetic emeralds are distinguishable by differences in growth and color zoning and inclusion features, in combination with chemical properties.

From a historical perspective, it has also become clear that Nacken developed his synthesis method independently, apart from any association with IG Farben's Igemerald growth technique. Contemporaneous files establish that although Nacken discussed possible collaboration with scientists at IG Farben in the mid-1930s, no joint efforts were undertaken.

NOTES

1. Wilhelm F. Eppler (1958 a,b) described three types of synthetic emeralds: samples grown by Nacken, Igemeralds produced by IG Farben in Bitterfeld, and Chatham synthetic emeralds. In giving credit for loan of samples, he acknowledged Eduard Gübelin, Hermann Espig, and Basil W. Anderson.

Eppler had been associated with Nacken in 1937, publishing papers through the Institute for Gemstone Research while Nacken was formally the organization's director (Eppler, 1937 a,b; see note 3 and accompanying text). In a later publication, Eppler (1964) still assumed that Nacken synthetic emeralds were grown hydrothermally. It would thus seem that Eppler never received any direct information from Nacken about his growth technique.

The three lots examined by Kurt Nassau were loaned by Frederick H. Pough and by the Natural History Museum in London. According to the records of the Natural History Museum (M. Rumsey, pers. comm., 2015), the museum received two groups of synthetic emeralds, one donated by Gordon Van Praagh in 1946 (see note 7) and another donated by Robert Webster in 1958 (identifying Georg Otto Wild as the previous owner; see note 3). A letter from Webster to Wild, dated April 1948, acknowledged the gift of a Nacken synthetic emerald (D. Jerusalem, pers. comm., 2015).

The samples from the Pough collection loaned to one of the authors (KS) in the late 1990s had also been obtained from Wild (see note 3), but no further details were given. Pough spent two years (1931–1932) in Heidelberg, Germany, at the research institute of Victor Goldschmidt studying mineralogy and crystallography and thus would have had connections with German colleagues in the 1930s. In particular, there is evidence of a visit by Pough to Idar-Oberstein in mid-1937 that included a meeting with Wild (D. Jerusalem, pers. comm., 2015).

As for the samples traced to the Gübelin collection, a relevant detail is that Gübelin and Wild had known each other since 1937 (Gübelin, 1969).

In summary, all Nacken samples examined in the major papers written to date were sourced through three individuals—Van Praagh, Wild, or Gübelin—and samples in Gübelin's collection may also have in turn come from Wild (see figure 24).

2. This paragraph is based on the most detailed published biographical data, as found in Kleber (1954) and Schloemer (1973); a draft of a personal autobiography by Nacken (circa 1959 or 1960); and on details provided by E. Schlatter, Nacken's grandson, in 2015.

3. From 1925 to 1936, the director of the Institute for Gemstone Research in Idar-Oberstein was Georg Otto Wild, who also founded the German Gemmological Association and became its first president in December 1933/January 1934. In the 1930s, Nacken was a board mem-

ber of the association. When the German government decided to affiliate the Institute for Gemstone Research more closely with a university, Nacken (then with the University of Frankfurt) was named its director in November 1936, with Wild remaining the local leader for research activities and working in close collaboration with Nacken. Wild traveled to Frankfurt on a weekly basis during 1936 and 1937 and had an office in the university's mineralogical institute ("Angliederung des Edelsteinforschungsinstituts Idar-Oberstein an die Universität Frankfurt a.M.," 1936; Nacken, 1937; Chudoba, 1969; D. Jerusalem, pers. comm., 2015).

4. Several interviews with Nacken were conducted by Allied investigators in 1945, when he was still living at Schramberg in the Black Forest (see note 5). Regarding the 1940s quartz synthesis program, the information about his work that he revealed to the interviewers would have been recent, insofar as he had pursued this topic at his small research laboratory in Schramberg following the destruction of the mineralogical institute at the University of Frankfurt. In contrast, the information given about his 1920s emerald synthesis would have been based solely on memory of a research project from two decades prior.

5. In total, American and British teams conducted at least five interviews with Nacken in 1945 and possibly early 1946. The interviews were conducted by C.B. Sawyer (Guellich et al., 1945, archived as PB 6498; Sawyer, 1945, archived as PB 14620), A.C. Swinnerton (Swinnerton, 1945, archived as PB 18784; Swinnerton, 1946, archived as PB 28897), Gordon Van Praagh (mentioned in Swinnerton, 1946), F.H. Coates (Coates, undated, archived as BIOS Final Report No. 552), and Leon Merker (Osborne, 1947, archived as PB 85147). The various PB documents are preserved at the U.S. Library of Congress, Division of Science, Technology & Business, Washington, DC. In the interview by Sawyer it was only noted that Nacken displayed some synthetic emeralds from his own production. In Swinnerton's interview, emerald was not mentioned. Coates observed that Nacken "appears to be more concerned with the production of synthetic emeralds...than pursuing the matter of synthesis of quartz."

6. Leon Merker (1917–2007), who studied chemistry at the University of Vienna and later in the United States at the University of Michigan, was one of the pioneers in applying the Verneuil flame-fusion method for growth of materials other than corundum and spinel, such as rutile, strontium titanate, calcium titanate, and aluminum titanate (all described in U.S. patents from the 1950s). Merker spent about one year at the U.S. Army's Field Industrial Agency, Technical (FIAT), joining in 1945. During that period, he authored a report about the German synthetic stone industry (Merker, 1947). He mentioned that in 1945 he could not visit IG Farben's Bitterfeld production

plant, which was located in the Soviet-controlled zone of Germany. This fact supports a conclusion that the information about synthetic emerald given in document PB 85147 (Osborne, 1947) “by an old German scientist from memory” was based on a 1945 interview with Nacken. Subsequently, Nassau (1976 a,b, 1978) was able to communicate with Merker and to confirm that Nacken was the interviewee. Likewise, in a brief paper describing his own work on crystal growth technologies, Merker (2004) noted that he had the chance to interview Richard Nacken and Spyro Kyropoulos and that, back in the United States, he too had “toyed” with synthetic emeralds for a short time. Given his Austrian background, Merker would have experienced no language barrier in his communications with Nacken in 1945.

7. Gordon Van Praagh (1909–2003) taught chemistry at Christ’s Hospital, in Horsham, Sussex, UK, and published several basic textbooks on chemistry and physical chemistry. He began working for the British Admiralty in 1943 during World War II, and his duties immediately after the war involved Allied combined intelligence operations, tracking down German scientific developments and expertise (Berry, 2003). In his articles about emerald and quartz synthesis, Van Praagh (1946, 1947 a,b) did not identify any sources for the information given; however, his interview with Nacken is mentioned in the American PB 28897 report (Swinnerton, 1946). Furthermore, in a later paper on quartz synthesis (1949), he referenced “Nacken (private communications, 1945)”.

8. Walther Fischer (1897–1979) studied chemistry, mineralogy, and geology in Dresden, Germany, graduating in 1925. He left Dresden in 1948 and moved to Idar-Oberstein, where he worked until 1959 as a teacher and later served as the director of the local college for gemstone cutting and processing. His list of scientific publications (Metz, 1972) contains 380 titles, including many book reviews and historical articles. In his 1955 review article on synthetic gemstones, Fischer offered numerous references for most of the information given. In contrast, only the section about Nacken is without citations. This suggests either that the author had direct contact with Nacken, or more likely, that he received his information from colleagues in Idar-Oberstein. Fischer had good connections with Georg Otto Wild—see the acknowledgements in Fischer’s 1954 book *Praktische Edelsteinkunde* (*Practical Gemmology*)—who in turn worked closely with Nacken in the 1930s (see note 3). Hence, the information presented in the 1955 article could have come through Wild.

9. Until the end of World War II, the United States used exclusively natural quartz, primarily from Brazilian sources, for mass production of oscillator plates. Therefore, no American program for hydrothermal growth of single-crystal quartz existed from 1940 to 1945 (Thompson, 2007). Nacken’s research programs for growing synthetic

quartz for oscillator plates, with financial support by the German government, are documented for 1939 and 1941 (Bundesarchiv Koblenz [Federal Archives], file nos. 13331 and 13332).

10. The history of German patent 913 649 by Richard Nacken and Immanuel Franke reflects political circumstances between 1940 and 1950. Four patent applications related to hydrothermal growth of crystals were filed between July 1942 and August 1943 by Nacken and Franke, both of Frankfurt. After the arrival of American troops in Berlin in mid-1945, unpublished patent applications were documented on microfilms retained by the Allies, but by then the German patent office had ceased operation. Copies of these microfilms were submitted to the patent office after it reopened in Munich in October 1949, though only titles and short abstracts were published in Germany in the early 1950s. The full documents were released as part of a special project of the German Patent and Trade Mark Office beginning in 2014, and the four Nacken and Franke patent applications are now available under document numbers DE N 45 891 AZ, DE N 46 429 AZ, DE N 46 863 AZ, and DE N 46 979 AZ. Three of these applications dealt with methods for hydrothermal crystal growth, and the last of the series described an autoclave seal. After 1949 Nacken and Franke requested further examination of the most recent of the three applications concerning hydrothermal growth methods. This application, filed June 25, 1943, in turn covered most of the material set forth in the two earlier submissions filed in 1942 and 1943. The application was granted in 1954 and became German patent 913 649.

11. Verneuil synthesis of ruby and sapphire commenced at Elektrochemische Werke Bitterfeld in 1910. In 1925, this company, including the plant for producing synthetic gem materials, was incorporated into the IG Farben group. Later, under Communist rule, the state-owned entity VEB Elektrochemisches Kombinat Bitterfeld took control of synthetic ruby, sapphire, and spinel production at the factory. Documents from all three periods are preserved in the Landesarchiv Sachsen-Anhalt, Merseburg (Archives of the German Federal State of Saxony-Anhalt, Department Merseburg) and at Kreismuseum Bitterfeld. The correspondence with Nacken and the IG Farben internal reports and notes related to Nacken synthetic emeralds are preserved at Merseburg, file number LASA, MER, I 506, No. 769.

12. Otto Dreibrodt (1887–1941) studied mathematics and mineralogy at the Universities of Halle and Leipzig, graduating from the latter in 1912. One of his academic instructors at the University of Leipzig was Richard Nacken. Dreibrodt joined Elektrochemische Werke Bitterfeld in August 1913. Numerous German and international patents by Dreibrodt and assigned to Elektrochemische Werke Bitterfeld dealt with improvements to the Verneuil technique (e.g., for producing sapphires and spinels of various colors)

and with chemical technology not related to the synthesis of gem materials. He left the company at the end of 1926. His personnel file still exists in the Landesarchiv Sachsen-Anhalt (see note 11), file numbers LASA, MER, I 506, No. 1068 and I 506, No. 1069, but the reason for his departure is unknown. Several Verneuil boules from his work remained with his daughter L. Dreibrodt, but no synthetic emerald samples are included (E. Schlatter, pers. comm., 2015).

13. The U.S. patent for Otto Dreibrodt's apparatus for crystal growth was apparently considered worthy of attention; it was reviewed briefly in *The American Mineralogist* ("An apparatus for growing large crystals," 1921), not a common practice at that time.

14. Landesarchiv Sachsen-Anhalt (see note 11), file number LASA, MER, I 506, No. 475.

15. According to the records of the German Patent and Trade Mark Office (Patentrolle), Munich and Berlin, German patent 273 929 expired in February 1924 due to non-payment of annual fees, thereby ending any protection

under the patent laws and any restriction on commercial use by others. Obviously, the company had lost interest in this technology.

16. In a 1951 book chronicling his adventures in South America and especially with Colombian emeralds in the first decades of 20th century, Klein mentioned an episode in which 35 carats of faceted synthetic emeralds were submitted to him at a bank in Frankfurt for evaluation. In his book, Klein did not directly identify Nacken as the producer, but he described the samples as having been manufactured by means of an invention made parallel to that of the "great concern." During that era, only two producers had grown synthetic emeralds of facetable quality and size in Germany, so the samples evaluated were either Nacken's synthetics or Igemeralds made by IG Farben. Because Igemeralds were released to the public in 1935, the "great concern" was likely a reference to IG Farben, thus implying that Nacken emeralds were the subject of Klein's investigations. Based on these circumstances, this episode would be dated to the 1930s, presumably the second half of the decade.

ABOUT THE AUTHORS

Dr. Schmetzer is an independent researcher living in Petershausen, near Munich, Germany. Prof. Gilg is professor at the chair of engineering geology at the Technical University of Munich. Prof. Vaupel is a staff member at the Research Institute of the Deutsches Museum in Munich.

ACKNOWLEDGMENTS

The authors are grateful to Prof. E. Schlatter of Nottuln and his brothers, Richard Nacken's grandsons, for kindly loaning samples

for this study and for providing the information known to the family about Prof. Nacken's work. A synthetic emerald crystal from the reference collection of the German Gemmological Association was submitted by Dr. U. Henn of Idar-Oberstein, Germany. Various types of government documents archived at the U.S. Library of Congress, in Washington, DC, were accessed by A.R. Blake. M. Rumsey of London and D. Jerusalem of Idar-Oberstein provided useful information about samples and history.

REFERENCES

- Anderson B.W. (1935) Igemerald – the German synthetic emerald. *The Gemmologist*, Vol. 4, No. 46, pp. 295–300.
- (1941) More news of synthetic emerald. *The Gemmologist*, Vol. 11, No. 122, pp. 9–11.
- Angliederung des Edelsteinforschungsinstituts Idar-Oberstein an die Universität Frankfurt a.M. (1936) *Deutsche Goldschmiede-Zeitung*, Vol. 39, No. 49, p. 507.
- An apparatus for growing large crystals (1921) *The American Mineralogist*, Vol. 6, No. 5, p. 90.
- Berry M. (2003) Gordon Van Praagh. *The Guardian*, Oct. 24, <http://www.theguardian.com/science/2003/oct/24/obituaries.highereducation>
- Brown G. (1997) The Biron synthetic emerald: An update. *The South African Gemmologist*, Vol. 11, No. 2, pp. 53–73.
- Bukin G.V. (1993) Growth of crystals of beryllium oxides and silicates using fluxes. *Growth of Crystals*, Vol. 19, pp. 95–110.
- Cannawurf C. (1964) Die Frühgeschichte der Smaragd-synthese. *Zeitschrift der Deutschen Gesellschaft für Edelsteinkunde*, No. 46, pp. 7–11.
- Chatham T.H. (1998) Created gemstones, past, present and future. *Canadian Gemmologist*, Vol. 19, No. 1, pp. 8–12.
- Chudoba K.F. (1969) Georg O. Wild zum 75. Geburtstag. In *Georg O. Wild zum 22. Januar 1969*. Deutsche Gemmologische Gesellschaft, Idar-Oberstein, Sonderheft 3, pp. 21–26.
- Coates F.H. (undated) Report on the investigation on the production of synthetic crystals in Germany and Copenhagen. BIOS Final Report No. 552. British Intelligence Objectives Sub-Committee, London, 13 pp.
- Diehl R. (1977) Neues zum Thema "Synthetischer Smaragd": Besuch bei Pierre Gilson. *Zeitschrift der Deutschen Gemmologischen Gesellschaft*, Vol. 26, No. 2, pp. 61–75.
- (Dreibrodt O.) Elektrochemische Werke (1914) Verfahren und Apparat zur Züchtung großer Kristalle durch Kristallisation in Bewegung aus Lösungen und Schmelzflüssen. DE 273 929, issued May 12.
- Dreibrodt O. (1920) Method and apparatus for forming large crystals. US 1,353,571, issued September 21.

- Engelbrecht J.A.A., Snyman H.C. (1983) Electron transparent gold platelets. *Gold Bulletin*, Vol. 16, No. 3, pp. 66–69.
- Eppler W.F. (1935) Der synthetische Smaragd. *Deutsche Goldschmiede-Zeitung*, Vol. 38, No. 15, pp. 144–146.
- (1936) Neue Untersuchungen an synthetischen Smaragden. *Deutsche Goldschmiede-Zeitung*, Vol. 39, No. 21, pp. 215–217.
- (1937a) Mitteilungen der Deutschen Goldschmiede-Zeitung aus dem Institut für Edelsteinforschung Idar-Oberstein. *Deutsche Goldschmiede-Zeitung*, Vol. 40, No. 27, pp. 257–259.
- (1937b) Mitteilungen der Deutschen Goldschmiede-Zeitung aus dem Institut für Edelsteinforschung Idar-Oberstein. *Deutsche Goldschmiede-Zeitung*, Vol. 40, No. 33, pp. 308–309.
- (1958a) Synthetischer Smaragd. *Deutsche Goldschmiede-Zeitung*, Vol. 56, No. 4, pp. 193–197; No. 5, pp. 249–251; No. 6, pp. 327–329; No. 7, pp. 381–385.
- (1958b) Synthetic emerald. *Journal of Gemmology*, Vol. 6, No. 8, pp. 360–369.
- (1964) Ein neuer synthetischer Smaragd. *Deutsche Goldschmiede-Zeitung*, Vol. 62, No. 3, pp. 183–184.
- Espig H. (1935) Der synthetische Smaragd. *Zeitschrift für Kristallographie*, Vol. 92, pp. 387–391.
- (1960) Die Synthese des Smaragds. *Chemische Technik*, Vol. 12, No. 6, pp. 327–331.
- (1961) Die Synthese des Smaragds. *Deutsche Goldschmiede-Zeitung*, Vol. 59, No. 10, pp. 660–663.
- (1962) Die Synthese des Smaragds und einiger anderer Minerale. *Berichte der Geologischen Gesellschaft der DDR*, Vol. 7, pp. 464–475.
- Feigelson R.S. (2014) Crystal growth through the ages: a historical perspective. In T. Nishinaga, Ed., *Handbook of Crystal Growth. Fundamentals: Thermodynamics and Kinetics*. Volume 1, Part A, 2nd ed., Elsevier, Amsterdam, pp. 1–83.
- Fischer W. (1954) *Praktische Edelsteinkunde*. Verlag Gustav Feller-Nottuln, Kettwig/Ruhr, pp. III–V.
- (1955) Smaragd-Synthese. In W. Foerst, Ed., *Ullmanns Enzyklopädie der Technischen Chemie*, 3. Auflage, 6. Band, Urban & Schwarzenberg, Munich – Berlin, pp. 246–248.
- Flanigen E. M. (1971) Hydrothermal process for growing crystals having the structure of beryl in an alkaline medium. US 3,567,642, issued March 2.
- Flanigen E.M., Mumbach N.R. (1971) Hydrothermal process for growing crystals having the structure of beryl in an acid halide medium. US 3, 567, 643, issued March 2.
- Flanigen E.M., Taylor A.M. (1967) Flux-melt method for growing single crystals having the structure of beryl. US 3,341,302, issued September 12.
- Flanigen E.M., Breck D.W., Mumbach N.R., Taylor A.M. (1967) Characteristics of synthetic emeralds. *American Mineralogist*, Vol. 52, No. 5–6, pp. 744–772.
- Gübelin E. (1961) Hydrothermal rubies and emerald-coated beryl. *Journal of Gemmology*, Vol. 8, No. 2, pp. 49–63.
- (1969) Untitled. 75th birthday greeting for G.O. Wild. In *Georg O. Wild zum 22. Januar 1969*. Deutsche Gemmologische Gesellschaft, Idar-Oberstein, Sonderheft 3, p. 12.
- Gübelin E., Shipley R.M. Jr. (1941) The synthetic emerald. *G&G*, Vol. 3, No. 10, pp. 146–150.
- Guellich G.E., White J., Sawyer C.B. (1945) Report on questioning of Prof. Pohl, Prof. Nacken, Prof. Spangenberg, Prof. Joos, Prof. Gunther, Dr. Chytrek, et al. (Artificial quartz crystals). PB 6498, 8 pp.; preserved at the U.S. Library of Congress, Division of Science, Technology & Business, Washington, DC.
- Hautefeuille P., Perrey A. (1888) Sur la reproduction de la phénacite et de l'émeraude. *Comptes Rendus Hebdomadaires des Séances de l'Académie des Sciences*, Vol. 106, pp. 1800–1803.
- (1890) Sur les combinaisons silicatées de la glucine. *Annales de Chimie et de Physique*, 6. Série, Vol. 20, pp. 447–480.
- Holmes R.J., Crowningshield G.R. (1960) A new emerald substitute. *G&G*, Vol. 10, No. 1, pp. 11–22.
- Jaeger M., Espig H. (1935) Der synthetische Smaragd. *Deutsche Goldschmiede-Zeitung*, Vol. 38, No. 35, pp. 347–349.
- Kane R.E., Liddicoat R.T. Jr. (1985) The Biron hydrothermal synthetic emerald. *G&G*, Vol. 21, No. 3, pp. 156–170, <http://dx.doi.org/10.5741/GEMS.21.3.156>
- Kieffer R., Braun H. (1963) Vanadin, Niob, Tantal. *Die Metallurgie der reinen Metalle und ihrer Legierungen*. Springer Verlag, Berlin/Göttingen/Heidelberg, 327 pp.
- Kleber W. (1954) Richard Nacken zur Vollendung seines 70. Lebensjahres. *Geologie*, Vol. 3, pp. 442–444.
- Klein F. (1951) *Smaragde unter dem Urwald*. 2nd ed., published by the author, Idar-Oberstein, Germany, pp. 284–285.
- Koivula J.I., Keller P.C. (1985) Russian flux-grown synthetic emeralds. *G&G*, Vol. 21, No. 2, pp. 79–85, <http://dx.doi.org/10.5741/GEMS.21.2.79>
- Lefever R.A., Chase A.B., Sobon L.E. (1962) Synthetic emerald. *American Mineralogist*, Vol. 47, No. 11–12, pp. 1450–1453.
- Linares R.C. (1967) Growth of beryl from molten salt solutions. *American Mineralogist*, Vol. 52, No. 7–8, pp. 1554–1559.
- Linares R.C., Ballman A.A., Van Uitert L.G. (1962) Growth of beryl single crystals for microwave applications. *Journal of Applied Physics*, Vol. 33, No. 11, pp. 3209–3210, <http://dx.doi.org/10.1063/1.1931138>
- Liu X., Wu N., Wunsch B.H., Barsotti R.J. Jr., Stellacci F. (2006) Shape-controlled growth of micrometer-sized gold crystals by a slow reduction method. *Small*, Vol. 2, No. 8–9, pp. 1046–1050, <http://dx.doi.org/10.1002/smll.200600219>
- Lofton C., Sigmund W. (2005) Mechanisms controlling crystal habits of gold and silver colloids. *Advanced Functional Materials*, Vol. 15, No. 7, pp. 1197–1208, <http://dx.doi.org/10.1002/adfm.200400091>
- Merker L. (1947) The synthetic stone industry of Germany. FIAT Final Report No. 1001, PB 77671, 27 pp.; preserved at the U.S. Library of Congress, Division of Science, Technology & Business, Washington, DC.
- (2004) Remembrances of flame fusion. In R.S. Feigelson, Ed., *50 Years Progress in Crystal Growth: A Reprint Collection*. Amsterdam, Elsevier, pp. 23–27.
- Metz R. (1972) Walther Fischer zum 75. Geburtstag. Der Aufschluß, Vol. 23, pp. 209–222.
- Morriss R.H., Bottoms W.R., Peacock R.G. (1968) Growth and defect structure of lamellar gold microcrystals. *Journal of Applied Physics*, Vol. 19, No. 7, pp. 3016–3021, <http://dx.doi.org/10.1063/1.1656724>
- Nacken R. (1915) Über das Wachsen von Kristallpolyedern in ihrem Schmelzfluss. *Neues Jahrbuch für Mineralogie, Geologie und Paläontologie*, Vol. 1915, II. Band, pp. 133–164.
- (1916) Kristallzüchtapparate. *Zeitschrift für Instrumentenkunde*, Vol. 36, pp. 12–20.
- (1937) Mitteilungen der Deutschen Goldschmiede-Zeitung aus dem Institut für Edelsteinforschung Idar-Oberstein. *Deutsche Goldschmiede-Zeitung*, Vol. 40, No. 21, pp. 203–207.
- (1950) Die hydrothermale Mineralsynthese als Grundlage zur Züchtung von Quarzkristallen. *Chemiker-Zeitung*, Vol. 74, No. 50, pp. 745–749.
- (1952) Über Kristallzüchtung. *Naturwissenschaftliche Monatsschrift*, Vol. 60, No. 2, pp. 33–40.
- (1953) Die wirtschaftliche Bedeutung der hydrothermalen Forschung. *Technische Mitteilungen*, Vol. 46, No. 4, pp. 87–94.
- Nacken R., Franke I., DE N 45 891 AZ (Ausgelegte Patentanmeldung, filed July 30 1942) Verfahren zur Herstellung kristalliner Produkte. 5 pp. (published online by German Patent and Trade Mark Office 2015)
- Nacken R., Franke I., DE N 46 429 AZ (Ausgelegte Patentanmeldung, filed February 9 1943) Verfahren zur Züchtung einheitlicher Kristallaggregate bzw. von Einkristallen. 2 pp. (published online by German Patent and Trade Mark Office 2015)

- Nacken R., Franke I., DE N 46 863 AZ (Ausgelegte Patentanmeldung, filed June 25 1943) Verfahren zur Erzeugung von Kristallen bzw. kristalliner Produkte, insbesondere aus schwer und sehr schwer löslichen Stoffen. 8 pp. (published online by German Patent and Trade Mark Office 2015)
- Nacken R., Franke I., DE N 46 979 AZ (Ausgelegte Patentanmeldung, filed August 4 1943) Verschluss für Hochdruckbehälter. 6 pp. (published online by German Patent and Trade Mark Office 2015)
- Nacken R., Franke I. (1954) Verfahren und Vorrichtung zur Erzeugung von Einkristallen bzw. Kristallaggregaten, insbesondere aus schwer und sehr schwer löslichen Stoffen. DE 913 649, issued June 18.
- Nacken R., Kinna W. (1959) Beheizbarer Druckautoklav. DE 1 054 424, issued October 15.
- Nassau K. (1976a) Synthetic emerald: The confusing history and the current technologies. *Journal of Crystal Growth*, Vol. 35, pp. 211–222, [http://dx.doi.org/10.1016/0022-0248\(76\)90172-X](http://dx.doi.org/10.1016/0022-0248(76)90172-X)
- (1976b) Synthetic emerald: The confusing history and the current technologies. *Lapidary Journal*, Vol. 30, No. 1, pp. 196–202 (part I); No. 2, pp. 468–492 (part II).
- (1978) Did Professor Nacken ever grow hydrothermal emerald? *Journal of Gemmology*, Vol. 16, No. 1, pp. 36–49.
- Osborne R.M. (1947) Synthetic Emerald. FIAT Technical Bulletin T-49, PB 85147, 1 p.; preserved at the U.S. Library of Congress, Division of Science, Technology & Business, Washington, DC.
- Rogers A.F., Sperisen F.J. (1942) American synthetic emerald. *American Mineralogist*, Vol. 27, No. 11, pp. 762–768.
- Sawyer C.B. (1945) Notes on interviews with German scientists on synthetic crystals in August and September, 1945. PB 14620, 15 pp.; preserved at the U.S. Library of Congress, Division of Science, Technology & Business, Washington, DC.
- Schiebold E. (1935) Vergleichende Untersuchungen an natürlichen und synthetischen Smaragdkristallen. *Zeitschrift für Kristallographie*, Vol. 92, pp. 435–473.
- Schloemer H.J. (1973) Richard Nacken†. *Fortschritte der Mineralogie*, Vol. 50, pp. 34–36.
- Schloßmacher K. (1960) Beryll mit Auflage von synthetischem Smaragd. *Zeitschrift der Deutschen Gesellschaft für Edelsteinkunde*, No. 33, pp. 5–7.
- Schmetzer K. (1991) Lechleitner synthetic emeralds, rubies and sapphires. *Australian Gemmologist*, Vol. 17, No. 12, pp. 516–523.
- (2002) More than 100 years of emerald synthesis. In *Emeralds of the World*. ExtraLapis English No. 2, pp. 84–92.
- Schmetzer K., Kiefert L. (1998) The colour of Igemerald: I.G. Farbenindustrie flux-grown synthetic emerald. *Journal of Gemmology*, Vol. 26, No. 3, pp. 145–155.
- Schmetzer K., Bernhardt H.-J., Biehler R. (1991) Emeralds from the Ural Mountains, USSR. *G&G*, Vol. 27, No. 2, pp. 86–99, <http://dx.doi.org/10.5741/GEMS.27.2.86>
- Schmetzer K., Kiefert L., Bernhardt H.-J. (1999) Multicomponent inclusions in Nacken synthetic emeralds. *Journal of Gemmology*, Vol. 26, No. 8, pp. 487–500.
- Schmetzer K., Bernhardt H.-J., Hainschwang T. (2012) Flux-grown synthetic alexandrites from Creative Crystals Inc. *Journal of Gemmology*, Vol. 33, No. 1–4, pp. 49–81.
- Smart D.C., Bosswell F.W., Corbett J.M. (1972) Lattice spacings of very thin gold platelets. *Journal of Applied Physics*, Vol. 43, No. 11, pp. 4461–4465, <http://dx.doi.org/10.1063/1.1660943>
- Swinerton A.C. (1945) Report on the interrogation of German scientists regarding quartz crystals and other piezoelectric materials. FIAT Final Report No. 641, PB 18784, 21 pp.; preserved at the U.S. Library of Congress, Division of Science, Technology & Business, Washington, DC.
- (1946) Report of investigations in European theater with special references to the German Ersatz quartz program and wartime crystal industry, and the quartz developments and piezoelectric materials investigations in the United Kingdom. PB 28897, 40 pp.; preserved at the U.S. Library of Congress, Division of Science, Technology & Business, Washington, DC.
- Switzer G. (1946) Improvements in quality in synthetic emerald. *G&G*, Vol. 5, No. 5, pp. 305–307.
- (1948) Method for producing synthetic emerald. *G&G*, Vol. 6, No. 1, p. 25.
- Synthetic beryl (1935) With notes by Prof. Dr. Karl Schlossmacher, B.W. Anderson and Georg O. Wild. *G&G*, Vol. 1, No. 10, pp. 281–286.
- Synthetischer Smaragd (1935) *Deutsche Goldschmiede-Zeitung*, Vol. 38, No. 6, pp. 3–4.
- Thompson R.J. Jr. (2007) *Crystal Clear: The Struggle for Reliable Communications Technology in World War II*. Hoboken, New Jersey, John Wiley & Sons, 230 pp.
- Van Praagh G. (1946) Synthetic emeralds. *Chemical Products and the Chemical News*, Vol. 9, pp. 10–11.
- (1947a) Synthetic emeralds. *Science News*, Vol. 3, pp. 22–24.
- (1947b) Synthetic quartz crystals. *Geological Magazine*, Vol. 84, No. 2, pp. 98–100, <http://dx.doi.org/10.1017/S0016756800082340>
- (1949) The hydrothermal crystallization of vitreosil at constant temperature. *Discussions of the Faraday Society*, Vol. 5, pp. 338–341, <http://dx.doi.org/10.1039/df9490500338>
- Vaupel E. (2015) Edelsteine aus der Fabrik. *Technikgeschichte*, Vol. 82, No. 4, pp. 273–302, <http://dx.doi.org/10.5771/0040-117X-2015-4-273>
- Webster R. (1952) The secrets of synthetic emerald. *The Gemmologist*, Vol. 21, No. 252, pp. 117–121.
- (1955) The emerald. *Journal of Gemmology*, Vol. 5, No. 4, pp. 185–221.
- (1958) Synthesis of emerald. *The Gemmologist*, Vol. 27, No. 328, pp. 203–206.

For online access to all issues of GEMS & GEMOLOGY from 1934 to the present, visit:

gia.edu/gems-gemology



A NEW FIND OF DANBURITE IN THE LUC YEN MINING AREA, VIETNAM

Le Thi-Thu Huong, Laura M. Otter, Tobias Häger, Tim Ullmann, Wolfgang Hofmeister, Ulrike Weis, and Klaus Peter Jochum

In the summer of 2015, gem-quality danburite was found in an eluvial deposit of ruby, sapphire, spinel, and tourmaline at the foot of the marble mountains of An Phu in the Luc Yen area of Vietnam's Yen Bai Province. This danburite is notable for its honey yellow color and excellent transparency. For the present study, rough and cut samples were investigated by standard gemological methods, photoluminescence, spectroscopic analysis (Raman, FTIR, and UV-Vis-NIR), electron microprobe, and femtosecond LA-ICP-MS chemical analysis. Microscopic observations revealed fingerprints and two-phase inclusions (gas/liquid). Additionally, growth zoning was visible with different blue intensities under a long-wave UV lamp. The samples were characterized by high concentration of lanthanides (totaling about 1116 ppm on average) together with the presence of other elements such as Al, Sr, Y, Hf, Pb, and Th, while the concentrations of transition metals were below detection limits. All Raman, UV-Vis-NIR, and photoluminescence results revealed the bands related to rare earth elements. FTIR spectroscopy showed the presence of hydroxyl in the danburite structure.

Danburite, with an ideal formula of $\text{CaB}_2\text{Si}_2\text{O}_8$, crystallizes in the orthorhombic system. It has a structure composed of a framework of corner-sharing Si_2O_7 linked with B_2O_7 groups by eight-coordinated Ca atoms. First discovered in Danbury, Connecticut (United States), gem-quality danburite has also been found in Japan, Madagascar, Mexico, Myanmar, Russia, Sri Lanka, Switzerland, and Tanzania (Hurwit, 1986; Chadwick and Laurs, 2008; Hintze, 2010). Danburite is an exceptionally rare gemstone, however.

In the summer of 2015, during a geological and mineralogical investigation of a metamorphosed carbonate formation in the Luc Yen district of Yen Bai Province, northern Vietnam, the authors found gem-quality danburite crystals. At the beginning of the investigation, several crystals with sizes up to 2.5 cm (figure 1, left) were found in mining dumps from Bai Cat, an active placer deposit of ruby, sapphire, spinel, and tourmaline located in the An Phu commune. Our team pursued this finding and found many small (1–2 cm) danburite crystals of similar

color and transparency along the streams within 2 km of the Bai Cat deposit. One of the rough crystals (figure 1, sample C) was cut into a clean 4.6 ct gem with no eye-visible flaws (figure 1, right). The present article provides a detailed characterization of the newly found danburite from Luc Yen.

GEOLOGIC BACKGROUND

The geology of the Luc Yen mining area has been described by Garnier et al. (2005), Long et al. (2013), and Chauviré et al. (2015). It is dominated by metamorphic rocks, mainly granulitic gneisses, mica schist, and marble, which are sometimes intruded by granitic and pegmatitic dikes (Garnier et al., 2005). Danburite crystals have been found associated with ruby, sapphire, spinel, and tourmaline in the Bai Cat placer deposit, which is surrounded by a series of marble mountain chains. One mountain about 5 km away, An Phu, contains a ruby mine (May Thuong) on one side and a spinel mine (Cong Troi) on the opposite side. While all of Luc Yen's primary formations of ruby, sapphire, and spinel were favored by metamorphic conditions, its tourmaline originated from pegmatite bodies. The nearest sources of tourmaline are pegmatites in the Minh Tien commune bordering An Phu. The geologic environment of Luc Yen was very suitable for the formation of danburite, which

See end of article for About the Authors and Acknowledgments.

GEMS & GEMOLOGY, Vol. 52, No. 4, pp. 393–401,

<http://dx.doi.org/10.5741/GEMS.52.4.393>

© 2016 Gemological Institute of America

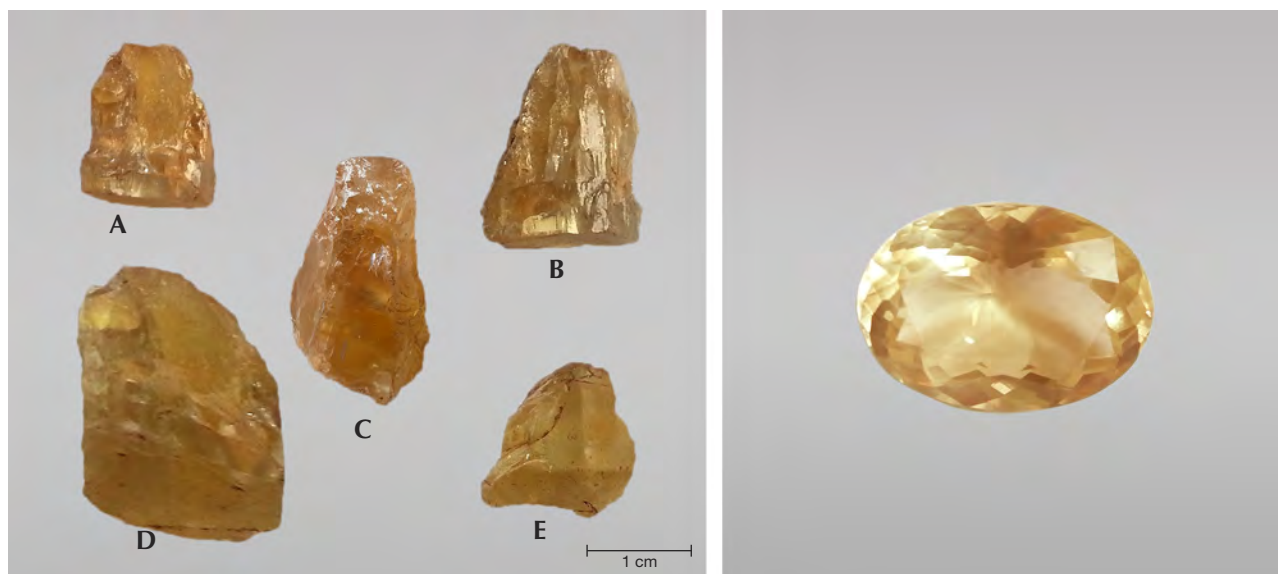

Figure 1. Five rough danburite crystals, in sizes up to 2.5 cm, were found at the Bai Cat deposit in Luc Yen, Vietnam. Crystal C, weighing 26.3 ct in rough form, was cut into the 4.6 ct faceted oval on the right. Photos by Le Thi-Thu Huong.

could be related to some pegmatite veins (figure 2). A similar geologic condition has previously been reported for danburite from the Anjanaboina pegmatite deposit in Madagascar (Wilson, 1989; 2007; Dirlam et al., 2002; De Vito et al., 2006). The pegmatites from both areas are often hosted by marble and locally contain coarse-grained green K-feldspar, tourmaline, and smoky quartz.

Although the overall production of danburite from Luc Yen has not been evaluated, the output from the Bai Cat deposit appears to be lower than that of ruby, sapphire, spinel, and tourmaline. Danburite remains fairly unknown to most local miners, who mistake it for quartz pebbles.

MATERIALS AND METHODS

For this study, we selected five danburite crystals ranging from 1 to 2.5 cm in length from the Bai Cat placer deposit in the Luc Yen mining area. The samples weighed 12.8 ct (A), 22.5 ct (B), 26.3 ct (C), and 49.6 ct (D), and 15.3 ct (E).

The 26.3 ct sample was cut into a 4.6 ct faceted oval, while the others were polished into parallel-window plates, oriented parallel to the c-axis for gemological analysis and Raman and photoluminescence measurements. Gemological characteristics were examined using a dichroscope, a refractometer, a hydrostatic balance, a 6 W long-wave/short-wave UV lamp (365 and 254 nm, respectively), and an immersion microscope with Zeiss optics. Raman spectroscopy was

carried out on a Horiba Jobin Yvon LabRam HR 800 spectrometer equipped with an Olympus BX41 optical microscope and a Si-based charge-coupled device (CCD) detector. Raman spectra were collected in two ranges, from 100 to 1200 cm^{-1} and 3300 to 3800 cm^{-1} , for all samples. The instrument used a frequency-doubled Nd-YAG laser (532 nm) and a grating with 1800 grooves/mm and a slit width of 100 μm . These parameters, and the optical path length of the spectrometer, yielded a resolution of 0.8 cm^{-1} . The spectral acquisition time was set at 240 seconds with two

In Brief

- Vietnamese danburite possesses honey yellow color and excellent transparency. It can be differentiated from yellow danburite from other localities by its fluorescence characteristics.
- Internal features include fingerprints, two-phase inclusions, and growth zoning.
- The concentration of total lanthanides is relatively high, with light rare earth elements exceeding heavy rare earth elements by a 250- to 300-fold enrichment.

cycles for all measurements, and sample orientation was carefully controlled. Photoluminescence (PL) spectra were recorded at room temperature on a Horiba Jobin Yvon NanoLog spectrophotometer equipped with a 450 W xenon discharge lamp as an

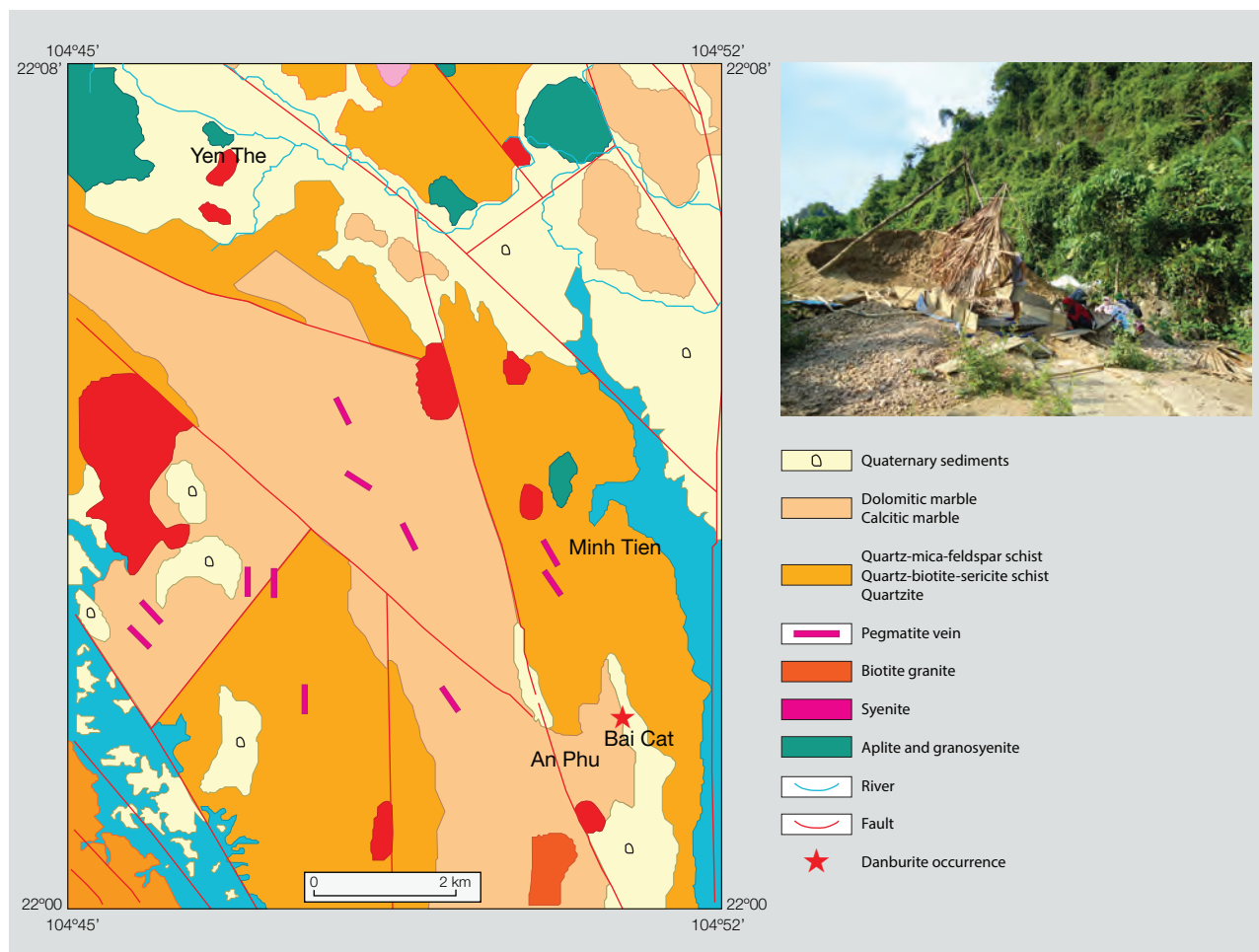

Figure 2. A portion of the Luc Yen geological map showing the location of the Bai Cat deposit, which has been worked for ruby, sapphire, spinel, and tourmaline. The deposit is the first site in Luc Yen where danburite crystals have been found. Map and photo by Le Thi-Thu Huong.

excitation source (240 nm). The recorded range was from 300 to 1000 nm, and spectral resolution was approximately 1 nm. Other spectroscopic techniques (FTIR and UV-Vis) and chemical analyses required further preparation, and the two smallest plates were chosen for these methods. The two larger plates were saved for future research. About 3 mg of material was removed from each of the two plates from inclusion-free regions and ground for FTIR measurements, while the remaining materials were further polished for UV-Vis-NIR and chemical analyses. FTIR spectra of powdered danburite were recorded in the 400–4000 cm^{-1} range with 64 scans and 4 cm^{-1} resolution using a Thermo Scientific Nicolet 6700 FTIR spectrometer equipped with an optimized beam condenser. UV-Vis-NIR absorption spectra were recorded in the 200–1600 nm range with 20 scans and a total measurement time of 4 seconds using a Zeiss Axio

Imager A2m microscope (0.1 mm beam spot), which was connected with two J&M spectrometers. The first diode array spectrometer (TIDAS S-CCD) works in the 200–980 nm range with a spectral resolution of 0.75 nm and the second one (TIDAS S900 with an InGaAs detector) in the 900–1600 nm range with a resolution of 2.8 nm.

Chemical data were obtained by electron microprobe analysis at the University of Mainz, Germany, and by femtosecond laser ablation–inductively coupled plasma–mass spectrometry (fs-LA-ICP-MS) at the Max Planck Institute for Chemistry in Mainz. Microprobe analyses were performed with a JEOL JXA 8200 instrument equipped with wavelength-dispersive spectrometers, using a 20 kV accelerating voltage and a 20 nA filament current. The spot size of 5 μm and measurement time of three minutes per spot analysis resulted in a peak counting time of 20–

TABLE 1. Chemical composition of danburite from Luc Yen, Vietnam.

| Oxides and elements | Sample 1 (from crystal A) | | Sample 2 (from crystal E) | |
|---|---------------------------|-------|---------------------------|------|
| | Average | SD | Average | SD |
| SiO ₂ (wt.%) | 46.6 | 0.1 | 47.3 | 0.2 |
| CaO (wt.%) | 22.7 | 0.1 | 22.7 | 0.1 |
| B ₂ O ₃ (wt.%) | 31.4 | 0.5 | 31.5 | 0.6 |
| Total | 100.7 | | 101.5 | |
| Minor and trace elements (ppm, as µg/g) | | | | |
| Li* | <1 | | <1 | |
| Be | 90 | 6 | 66 | 1 |
| B | 95800 | 5300 | 97700 | 1700 |
| Na | 40 | 10 | 41 | 3 |
| Mg* | <4 | | <4 | |
| Al | 260 | 30 | 270 | 20 |
| Si | 224000 | 19000 | 225900 | 5400 |
| K | 54 | 6 | 18 | 6 |
| Ca | 162180 | 0 | 162180 | 0 |
| Sc | 0.5 | 0.1 | 0.64 | 0.06 |
| Ti* | <1 | | <1 | |
| V | 0.78 | 0.07 | 0.8 | 0.1 |
| Cr* | <5 | | <5 | |
| Mn | 20 | 1 | 19 | 1 |
| Fe* | <20 | | <20 | |
| Ni | 2 | 1 | 0.4 | 0.3 |
| Cu | 10 | 1 | 2 | 1 |
| Zn | 36 | 18 | <20 | |
| Ga | 0.31 | 0.07 | 0.25 | 0.05 |
| As | 1.7 | 0.6 | 0.6 | 0.2 |
| Se* | <5 | | <5 | |
| Rb | 0.2 | 0.1 | <0.2 | |
| Sr | 68 | 6 | 64 | 4 |
| Y | 13 | 2 | 10 | 2 |
| Nb* | <0.02 | | <0.02 | |
| Ag* | <0.5 | | <0.5 | |
| Cd* | <1 | | <1 | |
| Sn | 0.8 | 0.2 | <0.5 | |
| Sb* | <0.5 | | <0.5 | |
| Cs* | <0.1 | | <0.1 | |
| Ba | 0.2 | 0.1 | <0.1 | |
| La | 540 | 90 | 270 | 10 |
| Ce | 720 | 90 | 410 | 30 |
| Pr | 58 | 8 | 29 | 2 |
| Nd | 120 | 10 | 65 | 3 |
| Sm | 8.4 | 0.7 | 4.7 | 0.2 |
| Eu | 0.4 | 0.1 | 0.28 | 0.02 |
| Gd | 3.7 | 0.6 | 2.0 | 0.1 |
| Tb | 0.24 | 0.04 | 0.15 | 0.02 |
| Dy | 0.9 | 0.2 | 0.6 | 0.2 |
| Ho | 0.17 | 0.02 | 0.13 | 0.01 |
| Er | 0.6 | 0.1 | 0.4 | 0.1 |
| Tm | 0.10 | 0.01 | 0.08 | 0.02 |
| Yb | 0.9 | 0.1 | 0.8 | 0.2 |
| Lu | 0.18 | 0.01 | 0.14 | 0.04 |
| Ta* | <0.01 | | <0.01 | |
| W* | <0.01 | | <0.01 | |
| Pt* | <0.05 | | <0.05 | |
| Au* | <0.02 | | <0.02 | |
| Tl* | <0.04 | | <0.04 | |
| Pb | 15 | 3 | 11 | 1 |
| Bi* | <0.01 | | <0.01 | |
| Th | 0.16 | 0.04 | 0.09 | 0.02 |
| U | <0.01 | | <0.01 | |

30 seconds per element. Calcium and silicon were analyzed by microprobe, with wollastonite used as the standard. LA-ICP-MS data for all elements except Ca and Si were obtained using an NWR Femto femtosecond laser operating at a wavelength of 200 nm in combination with a ThermoFisher Element2 single-collector sector-field ICP mass spectrometer. Before analyses, a pre-ablation (80 µm/s scan speed, 65 µm spot size, and 50 Hz pulse repetition rate at 100% energy output) was performed to reduce any eventual superficial polish residues. The samples were then ablated using line scans of 300 µm length at a scan speed of 5 µm/s and a spot size of 55 µm, achieving an energy density of 0.13 J/cm² at the sample surface using a pulse repetition rate of 50 Hz. The mass spectrometer was operated using low mass resolution (R=300). Laser ablation was performed in a He atmosphere that was mixed with Ar before entering the plasma area. The applied laser device produces pulses at 150 fs, enabling an almost matrix-independent calibration (Jochum et al., 2014). Important operating parameters for the mass spectrometer are: rf generator power = 1150 W, sample gas (Ar) flow rate = 0.7 L/min, carrier gas (He) = 0.7 L/min, measurement time = 60 s). The glass reference material NIST SRM 610 was used as a calibration material in the evaluation process, where ⁴³Ca was the internal standard. Data reduction and the elimination of obvious outliers were performed following a programmed routine in Microsoft Excel described in Jochum et al. (2007).

RESULTS AND DISCUSSION

Visual Appearance and Gemological Properties. The crystals showed orthorhombic pyramidal faces, some of them broken or rounded, and possessed a nearly identical honey yellow color with slightly different shades. They were transparent with some contaminated cracks. Some samples exhibited color zoning; pleochroism was not observed in any of them. The faceted sample was fairly clean, with no eye-visible inclusions. The refractive indices were $n_{\alpha} = 1.630-1.632$, $n_{\beta} = 1.633-1.635$, and $n_{\gamma} = 1.636-1.637$, with a birefringence of 0.006–0.008. SG values varied between 2.98 and 3.01. All of the samples were inert to short-wave UV radiation and fluoresced strong blue

*Concentrations below detection limits.

SD = standard deviation. Ca and Si were analyzed by electron microprobe analysis (five spots per sample) and trace element data by fs-LA-ICP-MS (nine lines per sample). B₂O₃ wt. % is calculated from LA-ICP-MS data.

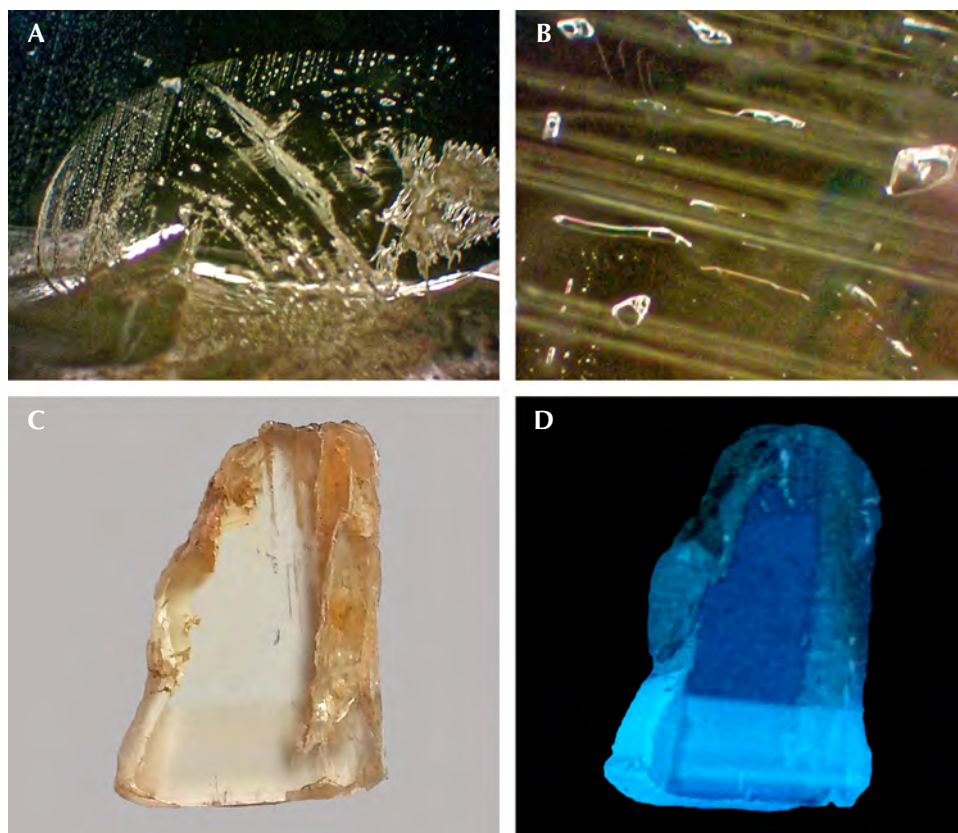

Figure 3. Internal features of Vietnamese danburite include fingerprints (A, field of view 1.5 mm) and two-phase inclusions (B, field of view 1.5 mm) as well as growth zones (C) that fluoresce with different blue intensities under long-wave UV (D). Darkfield illumination; photomicrographs by Le Thi-Thu Huong.

to long-wave UV. Those with a more intense honey yellow color fluoresced more intense blue under long-wave UV. The Vietnamese danburites can be differentiated from those originating from Tanzania (Chadwick and Laurs, 2008), Madagascar (GIA Gems database), and Myanmar (Kiefert, 2007) since the samples from these origins are either inert to both short- and long-wave UV (Tanzania and Madagascar) or fluoresce blue to both (Myanmar).

Microscopic observation revealed no mineral inclusions in our Vietnamese danburite samples. Fingerprints were observed in two of them (figure 3A). More often seen were two-phase (gas/liquid) inclusions (figure 3B). Another feature was growth zoning (figure 3C), which was also observed under a long-wave UV lamp as zones exhibiting different blue intensities. The darker zone showed more intense blue luminescence (figure 3D). By correlating these visual observations with the chemical data, we found that the darker sample had a higher total rare earth element (REE) concentration than the lighter one. We therefore assume that the blue luminescence was caused by some REE.

Chemical Composition. The chemical composition of the two analyzed samples is shown in table 1. Ac-

cording to our data, the Luc Yen danburites are characterized by a relatively high concentration of lanthanide elements.

The total lanthanide content for samples 1 and 2 was 782 and 1451 ppm, respectively, whereby the concentrations of light rare earth elements (LREE: La, Ce, Pr, Nd, Sm, and Eu) totaled 777 and 1444, exceeding heavy rare earth elements (HREE: Gd, Tb, Dy, Ho, Er, Er, Tm, Yb, and Lu) by a 250- to 300-fold enrichment. Other notable elements were Al, Sr, Y, Hf, and Pb (concentrations shown in table 1). We identified a very low concentration (0.09–0.16 ppm) of the radioactive element Th. Generally, our danburite samples had extremely low concentrations of transition metals (e.g., Sc, V, Ni, Cu, and Zn). Some other elements were even below detection limits (labeled with an asterisk in table 1). Individual exceptions were Be and Mn, with average concentrations of about 78 ppm and 19 ppm, respectively. The detection limits were calculated using three standard deviations of the gas blank measurements and the element sensitivity of the reference material NIST SRM 610 (Jochum et al., 2005).

Raman Spectroscopy. Raman spectra of the Luc Yen danburite were collected in the 100–1200 cm^{-1} range

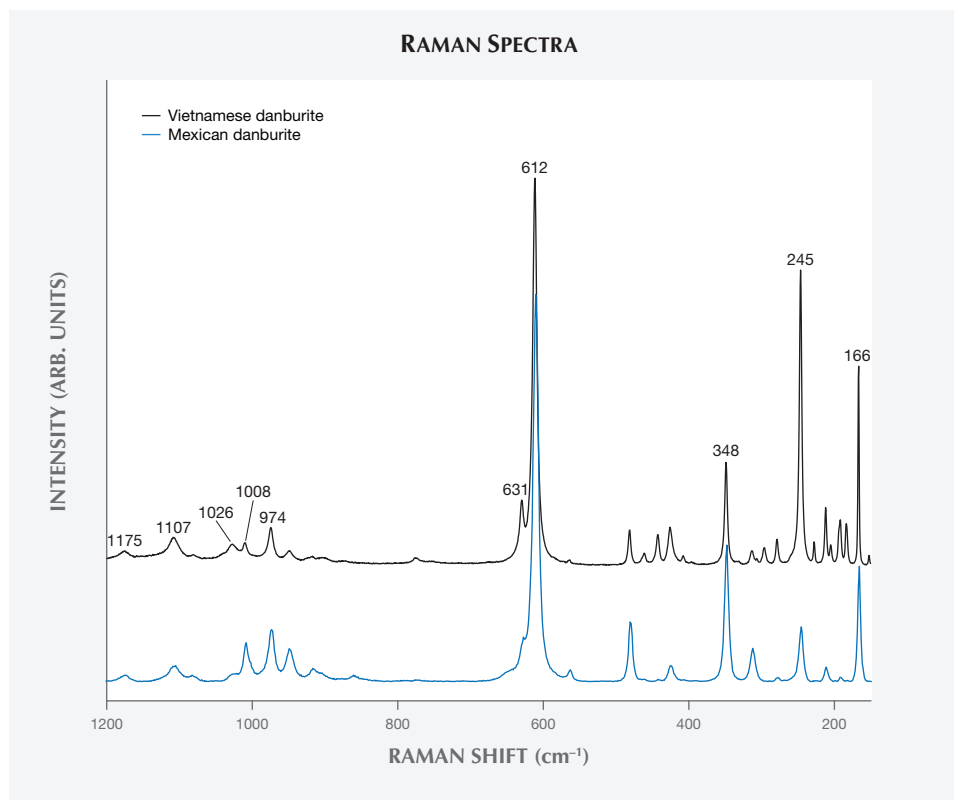

Figure 4. The Raman spectrum of a Vietnamese danburite (black trace) is compared with that of a colorless Mexican danburite (blue trace). Both spectra were recorded with the electric vector perpendicular to the *c*-axis showing the most intense band at 612 cm⁻¹.

and showed the highest-intensity band at 612 cm⁻¹. According to Best et al. (1994), this band and its shoulder at 631 cm⁻¹ are generated by B-O-Si bending vibration, while the bands at 1026, 1008, and 974 cm⁻¹ are caused by Si-O-B stretching. The two bands of highest frequency, at 1175 and 1107 cm⁻¹, originate from Si-O-Si stretching vibration. The bands in the 500–400 cm⁻¹ region are due to Si-O-Si bending vibration, while those in lower frequencies (including the 348, 245, and 166 cm⁻¹ bands) correspond to Ca translation and torsional modes of the borosilicate framework. Compared with the Raman spectrum of a colorless Mexican danburite in the RRUFF database (see figure 4), Vietnamese danburite shows additional bands between 245 and 166 cm⁻¹. According to one of our comparative studies of danburite composition from various deposits (Huong et al., 2016), the colorless Mexican danburites are fairly free of REE, with total contents of approximately 1.1 ppm. We therefore assume that the bands between 245 and 166 cm⁻¹ are due to Ca translation and torsional modes of the borosilicate framework, which might be caused by the substitution of REEs in the Ca position.

Photoluminescence Spectroscopy. Figure 5 shows room-temperature PL spectra of different color zones within a Vietnamese danburite sample under 254

nm excitation. Both zones (lighter and darker) show intense emission bands at 338 and 354 nm and a less intense broad band at 463 nm. However, PL intensity at the 463 nm emission band is higher and clearer in the darker zone than in the lighter zone.

Figure 5. Photoluminescence spectra of Vietnamese danburite in the lighter zone (blue trace) and the darker zone (black trace) show three bands at 338, 354, and 463 nm.

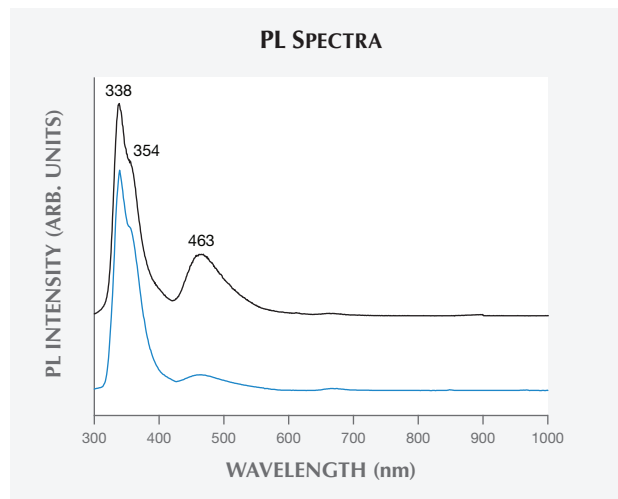

As for the UV emission bands (338 and 354 nm), the PL spectra resemble the typical emission spectra arising from radiative relaxations of Ce^{3+} ions from 5d to 4f levels (Tang et al., 2005). Thus, we assume that the PL emission in the UV region in this case also comes from the electron transitions of Ce^{3+} ions. As for the 463 nm emission band, we propose that it results from the presence of REE ions. Note that the 463 nm peak is stronger for the darker (more REE-rich) zones.

FTIR Spectroscopy. Figure 6 shows the IR spectrum of a representative Luc Yen danburite. Some of the main features include the internal modes in the 400–1200 cm^{-1} range and other modes in the range of water/hydroxyl vibrations from 3000 to 3800 cm^{-1} . In the latter range, we observed one broad band with a maximum centered at 3270 cm^{-1} and a weak band at 3560 cm^{-1} . According to Beran (1987), OH^{-} species can occupy the O^{2-} positions in danburite's structure, and charge is balanced by the substitution of Al^{3+} for Si^{4+} . The broad band seen in the IR spectra of Luc Yen danburite could indicate that OH^{-} substitutes for O^{2-} in different sites rather than just a single oxygen site.

In the 400–1200 cm^{-1} range, sharp bands are located at 445, 493, 536, 630, 671, 712, 890, 983, and 1061 cm^{-1} . These bands have never been assigned to the danburite structure. But for sorosilicates (with isolated Si_2O_7 in the structure), bands above 600 cm^{-1} have generally been assigned to stretching motions of Si_2O_7 (Kieffer, 1980; Hofmeister et al., 1987). These bands were also assigned to Si_2O_7 vibrations for lawsonite, $CaAl_2Si_2O_7(OH)_2 \cdot H_2O$, an isostructural mineral with danburite (Le Cléac'h and Gillet, 1990). Other bands in the 400–600 cm^{-1} range, when compared with Raman spectra, can be attributed to torsional modes of the borosilicate framework and/or Ca translation. Two absorption bands at 1415 and 1610 cm^{-1} are due to CO_2 and possibly skin fat.

UV-Vis-NIR Spectroscopy. A UV-Vis-NIR spectrum of Luc Yen danburite is shown in figure 7. Absorption increases gradually from the green portion of the spectrum (approximately 500 nm) to the higher-energy end (approximately 200 nm). On the absorption continuum base in the UV region, we observed three dominant peaks at approximately 315, 275, and 229 nm and a shoulder at 219 nm. This observation is dif-

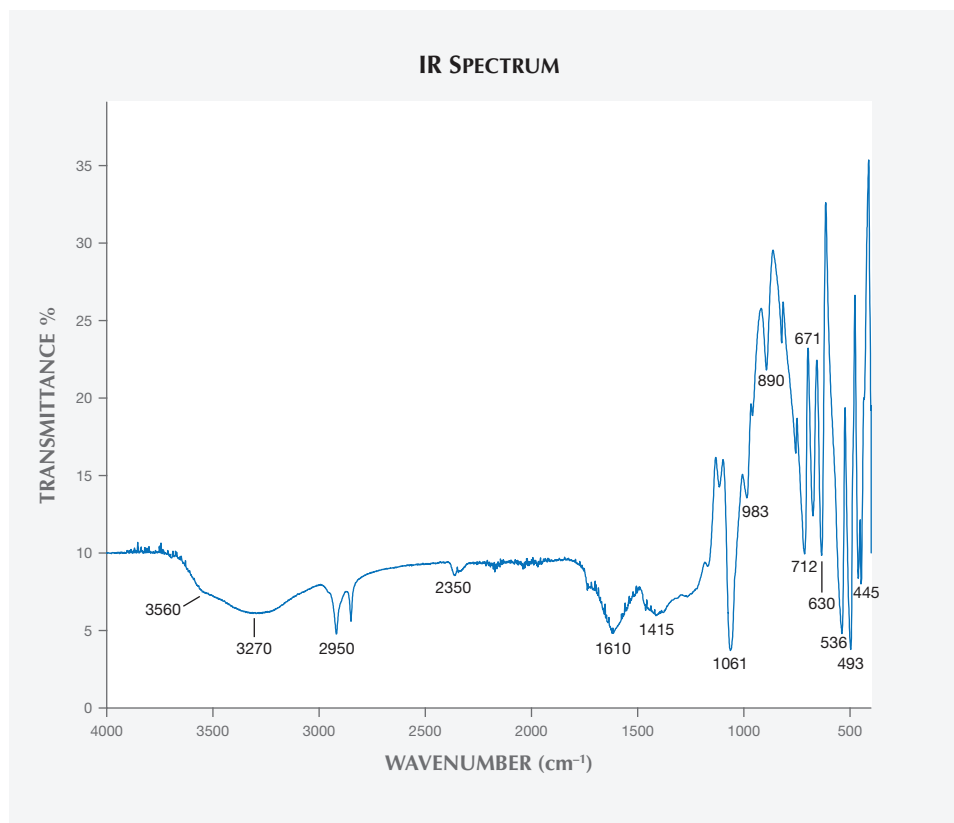

Figure 6. The infrared spectrum of powdered danburite from Luc Yen shows a broad band centered at 3270 cm^{-1} and a weak band at 3560 cm^{-1} , both of which are related to stretching vibrations of the OH^{-} group.

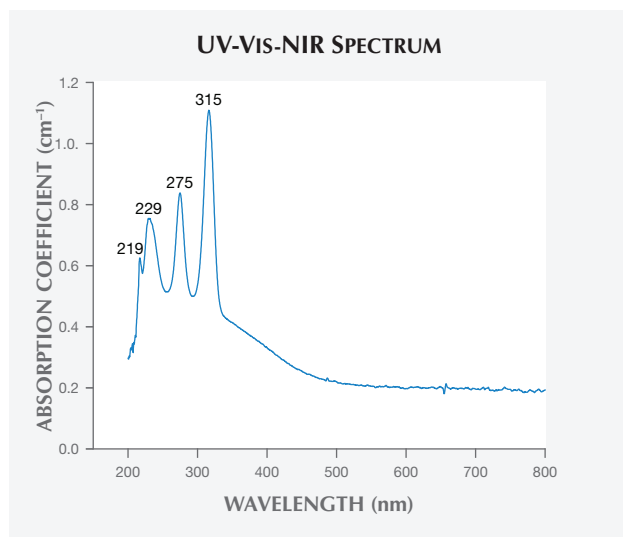

Figure 7. This UV-Vis-NIR absorption spectrum was obtained from a Luc Yen danburite plate.

ferent from the reports of Hurwit (1986) and Chadwick and Laurs (2008) for yellow danburite from other sources, which showed a minor peak at 585 nm attributed to REEs. However, the Luc Yen danburite's sharp and intense absorption peaks in the UV region are typical for electronic transitions in the core of REE ions, especially Ce^{3+} and Ce^{4+} (Ebendorff-Heidepriem and Ehrt, 2000; Nicolini et al., 2015). This is validated by the abundance of REEs in the sample (again, see table 1). It is easy to recognize that the Sri Lankan danburites reported by Hurwit (1986) and the Tanzanian samples examined by Chadwick and Laurs (2008) were a different shade of yellow. This is due to their absorption peak at 585 nm, which is not observed in Vietnamese danburite. As for the REE ions in large band-gap materials such as danburites, sharp and intense absorption spectra are often reported due to the energy transitions in the intra-4f

electron shell of the trivalent REE dopants. The crystal field effect is caused by interactions between the 4f electrons and the electrons of the host materials, partially or completely lifting the degeneracies of the quantum levels. Thus, different symmetric groups of REE ions in the host materials yield different optical properties. In many cases, however, the fine structure and the relative intensities of the optical transitions in the absorption can be used to probe the local environment of the REE ions, and luminescence spectra are more favorable for higher sensitivity. Relevant transitions for determining the group symmetry are very weak, with absorption cross-sections of about 10^{-21} to 10^{-22} cm^{-1} . Finally, the absorption continuum base in the UV region may be due to the absorption band of the host materials.

CONCLUSIONS

Placer deposits at Luc Yen in northern Vietnam host gem-quality danburite that possesses a honey yellow color. The samples are characterized by a high concentration of lanthanide elements (La to Lu) with combined concentrations ranging from 782 to 1451 ppm; concentrations of light rare earth elements exceed heavy rare earth elements by a 250- to 300-fold enrichment. Internal characteristics include fingerprints, two-phase inclusions, and growth zoning. Vietnamese danburites are also inert to short-wave and luminesce blue in long-wave UV. The blue radiation is related to REE impurities. Bands related to REEs are observed in Raman, photoluminescence, and UV-Vis-NIR spectra. Despite being an anhydrous mineral, danburite contains traces of hydroxyl that entered the structure by the substitution reaction $\text{OH}^- + \text{Al}^{3+} = \text{O}^{2-} + \text{Si}^{4+}$. The formation environment of Vietnamese danburite remains an ongoing research project.

ABOUT THE AUTHORS

Dr. Huong (leth@vnu.edu.vn) is lecturer in mineralogy and gemology at the Faculty of Geology, Hanoi University of Science. Ms. Otter is a scientist working at the Department of Climate Geochemistry at the Max Planck Institute for Chemistry in Mainz, Germany. Dr. Häger is senior scientist at the Centre for Gemstone Research at Johannes Gutenberg University in Mainz; lecturer in the Gemstone and Jewellery Design Department at the University for Applied Sciences in Idar-Oberstein, Germany; and managing director of the Centre for Gemstone Research in Idar-Oberstein. Mr. Ullmann is a master's student at Johannes Gutenberg University. Dr. Hofmeister is professor and vice president for research at

Johannes Gutenberg University and head of the Centre for Gemstone Research in Idar-Oberstein. Dr. Jochum is group leader, and Ms. Weis is a technician, at the Department of Climate Geochemistry, Max Planck Institute for Chemistry.

ACKNOWLEDGMENTS

Danburite samples were found in a field trip supported under a NAFOSTED Project grant (1055.99-2013.13). Dr. Ngo Ngoc Ha, Dr. Nguyen Duc Dzung, and Dr. Nguyen D.T. Kien from Hanoi University of Science and Technology are gratefully acknowledged for useful discussions. The authors appreciate the many valuable comments of the peer reviewers of this manuscript.

REFERENCES

- Beran A. (1987) OH groups in nominally anhydrous framework: Structures: An infrared spectroscopic investigation of danburite and labradorite. *Physics and Chemistry of Minerals*, Vol. 14, No. 5, pp. 441–445, <http://dx.doi.org/10.1007/BF00628821>
- Best S.P., Clark R.J.H., Hayard C.L., Withnall R. (1994) Polarized single-crystal Raman spectroscopy of danburite $\text{CaB}_2\text{Si}_2\text{O}_8$. *Journal of Raman Spectroscopy*. Vol. 25, No. 7-8, pp. 557–563, <http://dx.doi.org/10.1002/jrs.1250250717>
- Chadwick K.M., Laurs B.M. (2008) Gem News International: Yellow danburite from Tanzania. *G&G*, Vol. 44, No. 2, pp. 169–171.
- Chauviré B., Rondeau B., Fritsch E., Ressigeac P., Devidal J.-L. (2015) Blue spinel from the Luc Yen District of Vietnam. *G&G*, Vol. 51, No. 1, pp. 2–17, <http://dx.doi.org/10.5741/GEMS.51.1.2>
- De Vito C., Pezzotta F., Ferrini V., Aurisicchio C. (2006) Nb-Ti-Ta oxides in the gem-mineralized and “hybrid” Anjanabonoina granitic pegmatite, central Madagascar: A record of magmatic and postmagmatic events. *Canadian Mineralogist*, Vol. 44, No. 1, pp. 87–103, <http://dx.doi.org/10.2113/gscanmin.44.1.87>
- Dirlam D.M., Laurs B.M., Pezzotta F., Simmons W.B. (2002) Liddicoatite tourmaline from Anjanabonoina, Madagascar. *G&G*, Vol. 38, No. 1, pp. 28–52, <http://dx.doi.org/10.5741/GEMS.38.1.28>
- Ebendorff-Heidepriem H., Ehrh D. (2000) Formation and UV absorption of cerium, europium and terbium ions in different valencies in glasses. *Optical Materials*, Vol. 15, No. 1, pp. 7–25, [http://dx.doi.org/10.1016/S0925-3467\(00\)00018-5](http://dx.doi.org/10.1016/S0925-3467(00)00018-5)
- Garnier V., Ohnenstetter D., Giuliani G., Maluski H., Deloule E., Phan Trong T., Pham Van L., Hoang Quang V. (2005) Age and significance of ruby-bearing marble from Red River Shear Zone, northern Vietnam. *Canadian Mineralogist*, Vol. 43, No. 4, pp. 1315–1329, <http://dx.doi.org/10.2113/gscanmin.43.4.1315>
- Hintze J. (2010) Die gelben Danburite von Morogoro in Tansania. *Lapis*, Vol. 35, No. 3, pp. 25–31.
- Hofmeister A.M., Hoering T.C., Virgo D. (1987) Vibrational spectroscopy of beryllium aluminosilicate: Heat capacity calculations from band assignments. *Physics and Chemistry of Minerals*, Vol. 14, No. 3, pp. 205–224, <http://dx.doi.org/10.1007/BF00307985>
- Huong L.T.T., Otter L.M., Macholdt D.S., Foerster M.W., Stoll B., Weis U., Jochum K.P. (2016) Discrimination of danburite from different deposits by chemical components: a femtosecond LA-ICP-MS study. *International Geological Congress*, August 27–September 4, 2016, Cape Town, South Africa.
- Hurwit K.N. (1986) Gem Trade Lab Notes: Golden yellow danburite from Sri Lanka. *G&G*, Vol. 22, No. 1, p. 47.
- Jochum K.P., Nohl U., Herwig K., Lammel E., Stoll B., Hofmann A.W. (2005) GeoReM: A new geochemical database for reference materials and isotopic standards. *Geostandards and Geoanalytical Research*, Vol. 29, No. 3, pp. 333–338, <http://dx.doi.org/10.1111/j.1751-908X.2005.tb00904.x>
- Jochum K.P., Stoll B., Herwig K., Willbold M. (2007) Validation of LA-ICP-MS trace element analysis of geological glasses using a new solid-state 193 nm Nd:YAG laser and matrix-matched calibration. *Journal of Analytical Atomic Spectrometry*, Vol. 22, No. 2, pp. 112–121, <http://dx.doi.org/10.1039/B609547J>
- Jochum K.P., Stoll B., Weis U., Jacob D.E., Mertz-Kraus R., Andreae M.O. (2014) Non-matrix-matched calibration for the multi-element analysis of geological and environmental samples using 200 nm femtosecond LA-ICP-MS: A comparison with nanosecond lasers. *Geostandards and Geoanalytical Research*, Vol. 38, No. 3, pp. 265–292, <http://dx.doi.org/10.1111/j.1751-908X.2014.12028.x>
- Kiefert L. (2007) Gem News International: Unusual danburite pair. *G&G*, Vol. 43, No. 2, pp. 167–168.
- Kieffer S.W. (1980) Thermodynamics and lattice vibrations of minerals: 4. Application to chain and sheet silicates and orthoclase. *Review of Geophysics and Space Physics*, Vol. 18, No. 4, pp. 862–886, <http://dx.doi.org/10.1029/RG018i004p00862>
- Le Cléac’h A., Gillet P. (1990) IR and Raman spectroscopic study of natural lawsonite. *European Journal of Mineralogy*, Vol. 2, No. 1, pp. 43–53.
- Long P.V., Pardieu V., Giuliani G. (2013) Update on gemstone mining in Luc Yen, Vietnam. *G&G*, Vol. 49, No. 4, pp. 233–245, <http://dx.doi.org/10.5741/GEMS.49.4.233>
- Nicolini V., Gambuzzi E., Malavasi G., Menabue L., Menziani M.C., Lusvardi G., Pedone A., Benedetti F., Luches P., D’Addato S., Valeri S. (2015) Evidence of catalase mimetic activity in $\text{Ce}^{3+}/\text{Ce}^{4+}$ doped bioactive glasses. *The Journal of Physical Chemistry*, Vol. 119, No. 10, pp. 4009–4019, <http://dx.doi.org/10.1021/jp511737b>
- Tang C., Bando Y., Golberg D., Ma R. (2005) Cerium phosphate nanotubes: Synthesis, valence state, and optical properties. *Angewandte Chemie International Edition*, Vol. 44, No. 4, pp. 576–579, <http://dx.doi.org/10.1002/anie.200461171>
- Wilson W.E. (1989) The Anjanabonoina pegmatite, Madagascar. *Mineralogical Record*, Vol. 20, No. 3, pp. 191–200.
- Wilson W.E. (2007) Tourmaline from the Minh Tien pegmatite: Luc Yen mining district, Yenbai Province, Vietnam. *Mineralogical Record*, Vol. 38, No. 6, pp. 453–457.

INCLUSIONS IN NATURAL, SYNTHETIC, AND TREATED EMERALD

Nathan D. Renfro, John I. Koivula, Jonathan Moyal, Shane F. McClure, Kevin Schumacher, and James E. Shigley



Figure 1. This emerald contains a brown crystal of the rare mineral parisite. There is also an oil-filled cavity showing a blue and orange flash effect, along with two large trapped gas bubbles. This inclusion suite verifies the natural origin of this emerald; it also confirms that the stone, which shows signs of clarity enhancement, is from Colombia. Photomicrograph by John I. Koivula; field of view 3 mm.

This short introduction accompanies a chart illustrating some of the characteristic inclusions and other internal features seen in emerald (figure 1). Over the past 50 years, the observation of inclusions in colored gemstones, particularly emerald, has become an essential foundation for identification, quality analysis, and origin determination. This chart

contains a selection of photomicrographs of natural, synthetic, and treated emeralds. It is by no means comprehensive; photomicrographs of features not seen here can be found in many gemological textbooks. The images show the visual appearance of numerous features a gemologist might observe when viewing emeralds with a microscope.

With improvements in the design and construction of binocular microscopes in the 1800s, researchers increasingly used this instrument to study the natural world. In the 1940s, the occurrence of inclusions in emerald and other gemstones, and their importance for identification, was the focus of sev-

See end of article for About the Authors.
 GEMS & GEMOLOGY, Vol. 52, No. 4, pp. 402–403,
<http://dx.doi.org/10.5741/GEMS.52.4.402>
 © 2016 Gemological Institute of America

eral published articles by Swiss gemologist Eduard Gübelin. The immense value of inclusion studies in gemology is captured by the three-volume *Photo-atlas of Inclusions in Gemstones* by Eduard Gübelin and John Koivula.

Studying emerald inclusions provides insight into their geological formation. Beryllium is a rare element in the upper continental crust, and emeralds form in those unusual environments where Be is brought together with Cr (and sometimes V; see Groat et al., 2008). Important emerald sources include Brazil, Colombia, Madagascar, Russia, Zambia, and Zimbabwe. The principal types of emerald occurrences are sedimentary black shales affected by tectonic faulting and other structures, the contact zones of granitic pegmatites emplaced within silica-poor mafic or ultramafic igneous rocks, and certain metamorphic schists. In each of these environments, the minerals present in the host rocks, and in the rocks that formed at the same time as the emeralds,

may be preserved as inclusions. Multiphase fluid inclusions are also typical in emeralds from many sources (Saeseaw et al., 2014). In contrast, synthetic and treated emeralds often display inclusions that are visual evidence of their artificial growth or treatment process. The primary treatment for emeralds is clarity enhancement, in which a material with refractive index similar to beryl's, such as oil or resin, is introduced into surface-reaching cracks in order to reduce their visibility. Evidence of this treatment often consists of flattened gas bubbles and a flash effect seen when examining the material in a microscope. Similarly, inclusions such as phenakite crystals and roiled growth zoning can offer insight into flux and hydrothermal synthetic emerald genesis.

We hope you enjoy this look into the micro-world of emeralds. For more on emerald inclusions, please see our Suggested Reading list (<http://www.gia.edu/gems-gemology/winter-2016-suggested-reading-inclusions-emerald>).

ABOUT THE AUTHORS

Mr. Renfro is analytical manager of the gem identification department and microscopist of the inclusion research department, and John Koivula is analytical microscopist, at GIA in Carlsbad, California. Mr. Moyal is a staff gemologist, Mr. McClure is global

director of colored stone services, Mr. Schumacher is a digital resources specialist at the Richard T. Liddicoat Library and Information Center, and Dr. Shigley is distinguished research fellow at GIA in Carlsbad.

REFERENCES

Groat L.A., Giuliani G., Marshall D.D., Turner D. (2008) Emerald deposits and occurrences: A review. *Ore Geology Reviews*, Vol. 34, No. 1–2, pp. 87–112, <http://dx.doi.org/10.1016/j.oregeorev.2007.09.003>

Saeseaw S., Pardieu V., Sangsawong S. (2014) Three-phase inclusions in emerald and their impact on origin determination. *G&G*, Vol. 50, No. 2, pp. 114–132, <http://dx.doi.org/10.5741/GEMS.50.2.114>

Additional Reading

To access a list of references pertaining to inclusions in natural, synthetic, and treated emerald, please visit www.gia.edu/gems-gemology/winter-2016-suggested-reading-inclusions-emerald, or scan the QR code to the right.

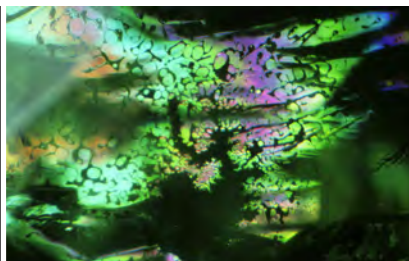

UPDATE ON GEMSTONE MINING IN NORTHERN MOZAMBIQUE

Wim Vertriest and Vincent Pardieu

Northern Mozambique (figure 1) has gained attention for its rubies since a major discovery near Montepuez in 2009 (see McClure and Koivula, 2009; Pardieu and Lomthong, 2009; Pardieu and Chauvire, 2012; Pardieu et al., 2009, 2013; Hsu et al., 2014). Until the arrival of Gemfields in 2012, nearly all the production from this deposit came from unlicensed miners, known as *garimpeiros*. Between 2012 and 2016, Gemfields became a force in the ruby trade, supplying the market through regular auctions in Singapore and Jaipur. In 2016, two new players acquired ruby mining licenses around Montepuez: Mustang Resources and Metals of Africa. During a summer 2016 GIA field expedition, we visited these new sites. We also spent time at the Gemfields operation, in order to follow the development of what is already the world's largest ruby mine. We also visited an interesting new pink spinel and tourmaline deposit near Ocua.

RUBY MINING AROUND MONTEPUEZ

MRM. In 2011 Gemfields and its local partner, Mwiriti Lda., created Montepuez Ruby Mining (MRM) and started a large-scale mining operation near Montepuez the following year. Over the past four years, MRM has established a solid foundation and secured their operations, and now they are preparing for a significant expansion. Within their initial 360-square-kilometer concession, there are already four main ruby deposits: Mugloto, Ntorro, Maninge Nice, and Glass. MRM recently acquired additional exploration licenses for areas surrounding their first licenses and now has exploration rights over a huge expanse of about 1,000 square kilometers.

The secondary deposit at Mugloto (figure 2) is currently MRM's main source of high-quality rubies.

Many of Gemfields' highest-priced gems are from this pit, including the Rhino and Dragon Eye rubies. Mining started in this pit in 2013. It consists of a gravel bed with a thickness of 20–120 cm, located at depths between 4 and 7 meters. Rubies are found in the slightly undulating gravels and are usually concentrated in zones with higher clay content. Rubies from this deposit are typically well rounded and medium to dark red, usually with some orangy tones and weak to medium fluorescence (figure 3). This site has not been worked extensively by unlicensed miners, but we were able to see some artisanal shafts. At the time of our visit, the main Mugloto mine (pit 3) measured an astonishing 350 by 1,000 meters, and MRM is actively expanding this pit. The total area that contains the ruby-bearing gravels is estimated to be over 5 km long. Some parts of the Mugloto mining area have already been restored and converted into plantations.

The mixed deposit at Maninge Nice is dominated by primary ruby mineralization in the amphibole-rich host rock. These primary rubies are flat, angular, light-colored, and strongly fluorescent. Overlying the primary rock is a gravel bed that is also very rich in rubies. These secondary rubies are similar to the ones

Figure 1. Map of northern Mozambique showing the locations of the main gem mining operations.

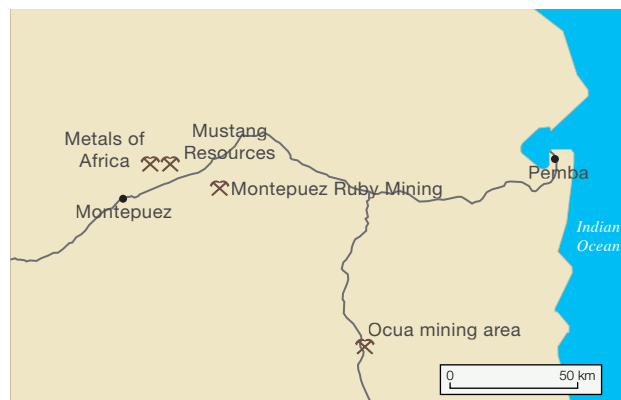

See end of article for About the Authors and Acknowledgments.

GEMS & GEMOLOGY, Vol. 52, No. 4, pp. 404–409,

<http://dx.doi.org/10.5741/GEMS.52.4.404>

© 2016 Gemological Institute of America



Figure 2. The ruby-bearing gravel bed in Mugloto. The wooden structure is the entrance to a tunnel abandoned by unlicensed miners. This section is about four meters high. Photo by Wim Vertriest/GIA.

in the host rock. This deposit produces large volumes of medium- to lower-quality commercial material, which reacts well to treatments such as flux healing.

Figure 3. These rubies from the Mugloto pit represent MRM's main production at the moment. The stones are typically well rounded and medium to dark red, often with some orangy tone and a weak to medium fluorescence. Photo by Vincent Pardieu/GIA.



Although MRM has extensively mined this pit, there was no activity during our visit.

The secondary deposit known as Glass (figure 4) was being prepared for production during our visit. This source is located downstream from Maninge Nice. It consists of a gravel bed with a thickness similar to that found at Mugloto, though the depth is more variable and can change sharply over a distance of a few meters. Some parts of the Glass area have been thoroughly worked by unlicensed miners, while others are untouched. Most of the production we saw at the sorting house was similar to rubies from Maninge Nice, although they had a rounded shape. Nevertheless, we also saw some material that resembled the Mugloto stones.

MRM stockpiles ore gravels from the different pits close to their washing plant (figure 5). Their current stock contains more than 800,000 tonnes of ore. This allows them to continue ruby production even when the mining of fresh gravels is halted. At the time of our visit, the facility could process 18,000 tonnes per week in ideal conditions. Their washing plant uses a series of screens to remove material measuring less



Figure 4. A view of MRM's new secondary deposit known as the Glass pit. Photo by Wim Vertriest/GIA.

than 3 mm and more than 25 mm before the gravels are concentrated in jigs. The concentrates are brought to the sorting house, where they are washed and handpicked. The selection is then sorted by quality and size before it is sealed for transport.

MRM is investing heavily in their washing and sorting installations. A new washing plant capable of processing twice as much ore has been operational since December 2016. This plant concentrates the gravels using dense media separation rather than jigs. At the end of 2017, a new sorting house is scheduled for the site. The sorting process will be more automated, allowing MRM to produce higher volumes of ruby.

Figure 5. Jigs at the MRM washing plant. The washing capacity of this installation is reportedly 130 tons per hour. Photo by Vincent Pardieu/GIA.



New Players in Montepuez. An interesting development in 2016 was the arrival of two new mining companies that acquired mining licenses around Napula, north of the road linking Pemba and Montepuez. During exploration, both companies found attractive facet-grade ruby material. This was a surprise to author VP, who visited areas north of the road, near Namahaca, in 2009 and observed that the production from these pits was not very promising. Soon these pits were abandoned, and the author received no confirmation about the recovery of attractive rubies in areas north of the road. The new production near Napula suggests that the Montepuez ruby-producing area is larger than expected.

Mustang Resources. This Australian company acquired interests in three mining licenses northwest of the MRM license in 2015. Mustang's operation started in 2016; during our visit Mustang was focusing on infrastructure and exploration of potential secondary ruby mineralization. They base their efforts on the earlier mining activity by garimpeiros. Mustang is working with a contractor specializing in geophysical exploration to map the subsurface and detect the gravel layers based on their reaction to electromagnetic signals. Most of the gravels are deeper than nine meters, making them more challenging to extract than the shallower areas around Montepuez. The advantage, however, is that they are mostly untouched by illegal miners.

During the exploration phase, Mustang excavates 1–2 ton samples of the gravels and washes them to determine the potential ruby grade. Mustang is washing the test samples with a small jig while



Figure 6. Facet-grade pink rubies discovered in the Mustang concession near Napula at the beginning of their exploration program. The largest stone weighs about 1 ct. Photo by Vincent Pardieu/GIA.

building a larger processing plant. They plan to use rotary pans to concentrate the gravels once they start mining. The company has extensive experience with this technique, which is mainly used in diamond recovery. We examined some of the earliest production (figure 6) and found that the rubies were facet-grade material. The operation appears to have expanded after the authors' visit. By mid-November, Mustang reportedly collected 810.46 carats of small rubies.

Metals of Africa. Metals of Africa is a significant player in graphite mining in northern Mozambique. The company recently recognized the opportunities in the Montepuez ruby area and acquired a mining license near the village of Napula. Metals of Africa entered into a joint venture with Mozambican Ruby Lda. to exploit this area, which borders Mustang's license in the northwestern part of Montepuez. Metals of Africa is taking a novel approach to the operation: While tolerating garimpeiros within the concession, the company tries to reduce their numbers by providing alternative income through clearing roads and building infrastructure. Nevertheless, we witnessed around 300 garimpeiros still working within the concession, both on primary and secondary deposits (figure 7).

One valley showed good ruby potential. The upstream part had been extensively worked by garimpeiros, but they were not allowed to mine the downstream area, which belongs to a farmer. This downstream area was untouched and likely rich in ruby. In the dry streambed we were able to find some ruby that had been discarded by garimpeiros. These



Figure 7. An artisanal mining pit in the Metals of Africa concession, where primary ruby is exploited by garimpeiros. Photo by Vincent Pardieu/GIA.

small pieces looked very similar to ruby from Maninge Nice in the MRM concession. In other areas, garimpeiros were producing rubies from altered amphibole-rich rocks in artisanal pits more than 18 meters deep (figure 8). The rocks in these pits

Figure 8. A garimpeiro shows some low-quality rubies in their matrix associated with amphibole, mica, and feldspar from a mining pit inside the Metals of Africa concession. Photo by Vincent Pardieu/GIA.





Figure 9. The Ocuá tourmaline mining area was being worked by garimpeiros. Photo by Vincent Pardieu/GIA.

were also very similar to those seen in the Maninge Nice pit in the MRM concession. Metals of Africa has sampled these places of interest and discovered some high-quality ruby.

Recent Garimpeiro Activity. On July 25 and 27, we could see hundreds of garimpeiros moving to the south of the Ntorro area inside MRM's concession, where a rush was taking place. We also received reports that many garimpeiros were still active near Nacaca (to the southeast of MRM's concession).

Since our last visit in 2015, Mozambique has enacted laws that distinguish illegal mining as a crime punishable by law. Therefore, unlicensed mining is

now considered a serious criminal offense, whereas before it was only an infraction. This means that garimpeiros risk serious jail time if caught.

SPINEL AND TOURMALINE MINING

At the end of 2015, pink spinel was discovered in northern Mozambique (Boehm, 2016). The deposit is located a few kilometers east of Ocuá (figure 9), a village near the southern border of the Cabo Delgado province on the road linking Pemba and Nampula. All the mining was done by artisanal miners. The stones were typically small, with an attractive light pink color (figure 10). Most of the material was facet grade, though it tended to be slightly milky. The land they were mining was being exploited for timber by a Chinese company that quickly acquired a gem-mining license for the area. During our visit, the company was bringing in mining machinery. The garimpeiros had been asked to leave, and most went to work on the other side of the road, where tourmaline was recently discovered. In this new area, we could see around 200 miners digging for gemstones. They were collecting gem-rich gravels in pits up to three meters deep. These gravels contained a variety of minerals, but the most attractive were yellow to green tourmaline crystals (figure 11).

Figure 10. Pink spinel from Ocuá, presumably mined in the area claimed by a Chinese timber company. Photo by Vincent Pardieu/GIA.



CONCLUSIONS

Northern Mozambique has more ruby mining activity than ever, with several new players showing interest. We saw that the Montepuez ruby deposit may be larger than expected, with mining activity extend-



Figure 11. A parcel of mainly green and yellow tourmaline from Ocua. Photo by Vincent Pardieu/GIA.

ing outside MRM's concession. This is an indication that this deposit's potential has yet to be fully explored. The discovery of other types of high-quality material, such as pink spinel and tourmaline, also

underscores the gem wealth of this region. As field gemologists, we are confident that further discoveries and developments in northern Mozambique will continue in the future.

ABOUT THE AUTHORS

Mr. Verriest is a trainee in the field gemology department, and Mr. Pardieu is a senior manager in the field gemology department, at GIA in Bangkok.

ACKNOWLEDGMENTS

We would like to thank the people we met in Mozambique and particularly the people from Gemfields, Mustang Resources, and

Metals of Africa for their hospitality and support during our field expedition.

Disclaimer: GIA staff often visit mines, manufacturers, retailers, and others in the gem and jewelry industry for research purposes and to gain insight into the marketplace. GIA appreciates the access and information provided during these visits. These visits and any resulting articles or publications should not be taken or used as an endorsement.

REFERENCES

- Boehm E. (2016) Gem Notes: Pink spinel from Mozambique. *Journal of Gemmology*, Vol. 35, No. 2, pp. 109–111.
- Hsu T., Lucas A., Pardieu V. (2014) Mozambique: A ruby discovery for the 21st century. *GIA Research & News*, Dec. 3, <http://www.gia.edu/gia-news-research-mozambique-expedition-ruby-discovery-new-millennium>
- McClure S.F., Koivula J.I. (2009) Gem News International: Preliminary observations on rubies from Mozambique. *G&G*, Vol. 45, No. 3, pp. 224–226.
- Pardieu V., Lomthong P. (2009) Gem News International: Update on new rubies from Mozambique. *G&G*, Vol. 45, No. 4, pp. 302–303.
- Pardieu V., Chauvire B. (2012) Gem News International: Update on ruby mining in northern Mozambique. *G&G*, Vol. 48, No. 4, pp. 309–311.
- Pardieu V., Jacquat S., Senoble J.B., Bryl L.P., Hughes R.W., Smith M. (2009) Expedition report to ruby mining sites in Northern Mozambique. http://www.giathai.net/wp-content/uploads/2015/02/Fieldtrip_to_Mozambique_December_16_20091.pdf
- Pardieu V., Sangsawong S., Muyal J., Chauviré B., Massi L., Sturman N. (2013) Rubies from the Montepuez area (Mozambique). http://www.giathai.net/wp-content/uploads/2015/02/GIA_Ruby_Montepuez_Mozambique.pdf



G&G

Lab Notes

Editors

Thomas M. Moses | Shane F. McClure

Dyed Green BERYL

Emerald simulants and synthetic emeralds have often been submitted for testing to GIA (e.g., Spring 2001 Lab Notes, pp. 57–59). Recently, the New York laboratory examined a dyed green beryl that was intended to imitate natural emerald. The green octagonal step-cut stone, set in a yellow metal ring with near-colorless stones, initially appeared to be emerald.

The stone had a refractive index of 1.588–1.595 and fluoresced a very weak chalky yellow under long-wave UV radiation and a weak chalky yellow under short-wave UV. Microscopic examination revealed the obvious presence of a green dye concentration in numerous fractures (figure 1) and other natural beryl inclusions such as short needles, particles, and jagged fingerprint patterns. This dyed green material also enhanced the clarity of the stone.

In addition, dyed bands (~610 and 660 nm) were revealed in the visible spectrum by utilizing a high-resolution visible spectrometer (figure 2). The green color in this sample was caused by an organic dye rather than chromium or vanadium elements that give rise to a green color in natural emeralds. When the color was observed under a diffused light source, it became apparent that a near-colorless

natural beryl was the starting material. This example shows the importance of spectroscopic testing to confirm the cause of an emerald's color.

Hyejin Jang-Green

DIAMONDS

Coesite Inclusions with Filaments in Diamond

GIA's New York lab recently encountered an HPHT-treated Fancy Vivid yellow diamond with unique inclusions. The diamond was determined to be HPHT-treated due to the presence of a strong solitary peak at 1344



Figure 1. A green dye concentration in beryl was observed along fractures and confirmed by spectroscopic testing.

cm⁻¹ in the infrared absorption spectrum, indicating isolated nitrogen C-

Figure 2. In the beryl's Vis-NIR absorption spectrum, dye bands were observed at ~610 and 660 nm, while sharp Cr-related features were absent.

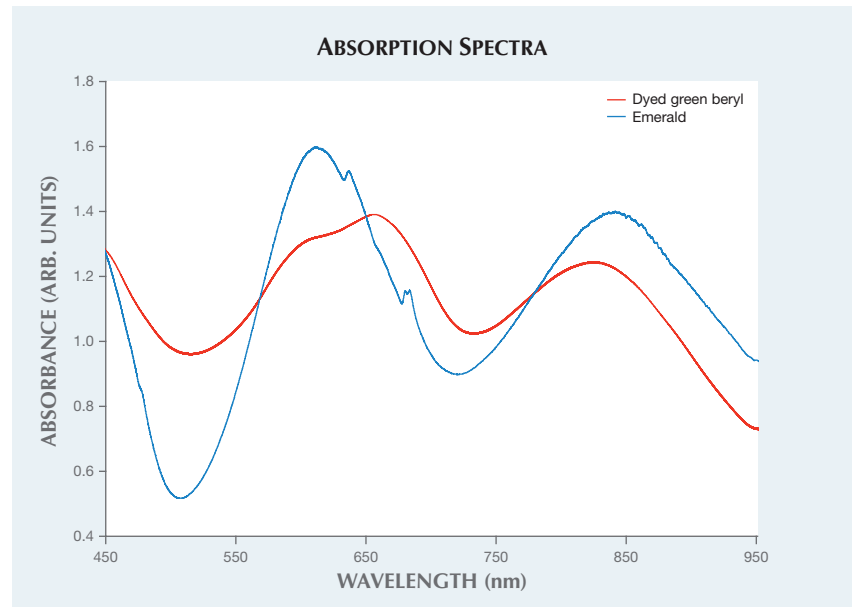

Editors' note: All items were written by staff members of GIA laboratories.

GEMS & GEMOLOGY, Vol. 52, No. 4, pp. 410–421.

© 2016 Gemological Institute of America

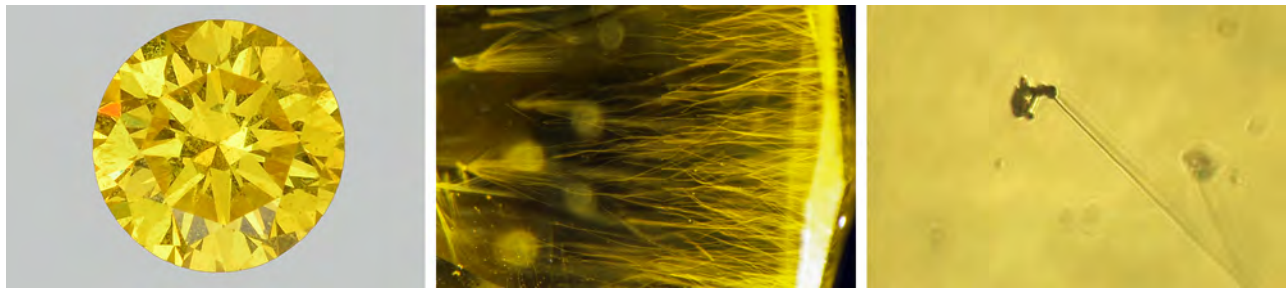

Figure 3. Left: A Vivid yellow 0.164 ct diamond containing coesite inclusions. The diamond is 3.52 mm in diameter. Center: Photomicrograph of a dense region of coesite inclusions with filaments; field of view 1.26 mm. Right: A photomicrograph of a single coesite inclusion, with filament gradually going out of focus to the right; field of view 100 μm .

centers, a relatively even distribution of color, and the absence of certain peaks in the diamond's Raman spectrum. However, the color treatment of this diamond was not its most interesting aspect. The diamond was unique for possessing many small inclusions with fine, tail-like filaments (figure 3). Visually, the filaments within this 0.164 ct round brilliant-cut diamond resembled horsetail inclusions in demantoid garnet. Raman spectroscopy of four separate inclusions gave peaks for coesite, a high-pressure SiO_2 polymorph (figure 4).

The measured peaks of coesite are shifted with respect to reference spectra due to high confining pressures within each inclusion. The shift of the main peak from its unconstrained position at 521 cm^{-1} to the measured peak in the inclusions, at $533 \pm 1\text{ cm}^{-1}$, can be used to calculate the internal pressure, which is an incredible $4.3 \pm 0.4\text{ GPa}$ (R.J. Hemley, "Pressure dependence of Raman spectra of SiO_2 polymorphs: α -quartz, coesite, and stishovite," in M.H. Manghnani and Y. Syono, Eds., *High-Pressure Research in Mineral Physics*, AGU, Washington, D.C., pp. 347–359). When a diamond is carried to the surface, the diamond and its inclusions do not decompress coherently, so it is fairly common for inclusions to have some amount of "locked-in" remnant pressure. HPHT treatment is unlikely to have modified this remnant pressure, although the possibility cannot be entirely ruled out without more detailed study. These particular coesite inclusions preserve an especially high pres-

sure because the inclusions are small. Larger inclusions are more likely to crack or deform the surrounding diamond and relieve some of the built-up pressure.

Coesite inclusions are not uncommon in diamond, and they are interpreted to indicate an eclogitic mantle host rock paragenesis. The curvilinear filaments extending from the inclusions are, however, both uncommon and unusual. They have a preferred orientation, extending to the right in figure 3 (center). This direction corre-

sponds with the interpreted direction of growth, outward from the center of the diamond. Most filaments are singular, measuring 20–200 μm long, but a few branch into a fan-like spray of sub-parallel filaments. The thickness of each filament is less than 1 μm , making it difficult to observe or characterize them in more detail. Interestingly, the inclusions occur within discrete regions in the diamond, which correspond to cuboid {100} growth sectors when examined in the DiamondView (short-wave UV fluo-

Figure 4. Raman spectra of four inclusions corresponding to coesite with high remnant pressure inside each inclusion. Spectra have been vertically offset for clarity.

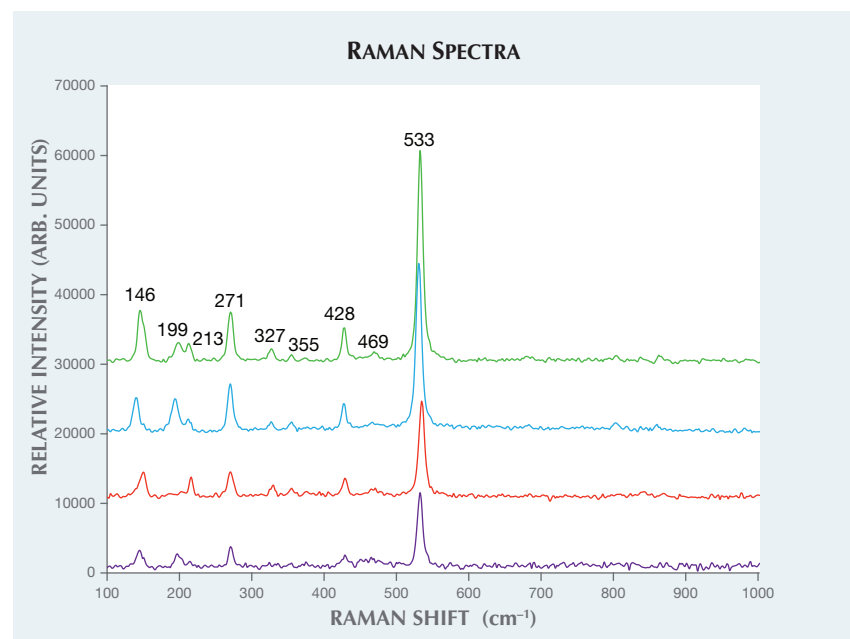

rescence imaging). A possible explanation for the filaments is that they are grown-in dislocations, originating from the point where the diamond just finished enveloping each inclusion. The filaments resemble the dislocations seen in X-ray topography of natural diamonds (e.g., B. Rondeau et al., "On the growth of natural octahedral diamond upon a fibrous core," *Journal of Crystal Growth*, Vol. 304, 2007, pp. 287–293). A dislocation alone, however, would not be optically visible. Small amounts of solid or fluid material trapped with the dislocation might be responsible for its visibility.

*Evan M. Smith, Christopher Vendrell,
and Paul Johnson*

Decay Kinetics of Boron-Related Peak in IR Absorption of Natural Diamond

Recently, gemologists at the National Gold & Diamond Testing Center in China found that the uncompensated boron peak at 2800 cm⁻¹ in FTIR absorption could be induced by UV excitation and then subsequent decay, similar to the phosphorescence response often seen in type IIb diamonds (J. Li et al., "A diamond with a transient 2804 cm⁻¹ absorption peak," *Journal of Gemmology*, Vol. 35, 2016, pp. 248–252).

The Carlsbad laboratory recently received a nominally type IIa, 1.01 ct diamond with Fancy gray color. It was identified as natural and, uncharacteristically, showed a 500 nm band phosphorescence, which is typical for type IIb diamonds (S. Eaton-Magaña and R. Lu, "Phosphorescence of type IIb diamonds," *Diamond and Related Materials*, Vol. 20, 2011, pp. 983–989). With UV excitation we recorded the transient 2800 cm⁻¹ absorption (associated with uncompensated boron) observed in type IIb diamonds, and we monitored the peak's decay (figure 5).

From the calculated area of the 2800 cm⁻¹ absorption peak, we can determine the uncompensated boron (Bo) concentration (D. Fisher et al., "Brown colour in natural diamond

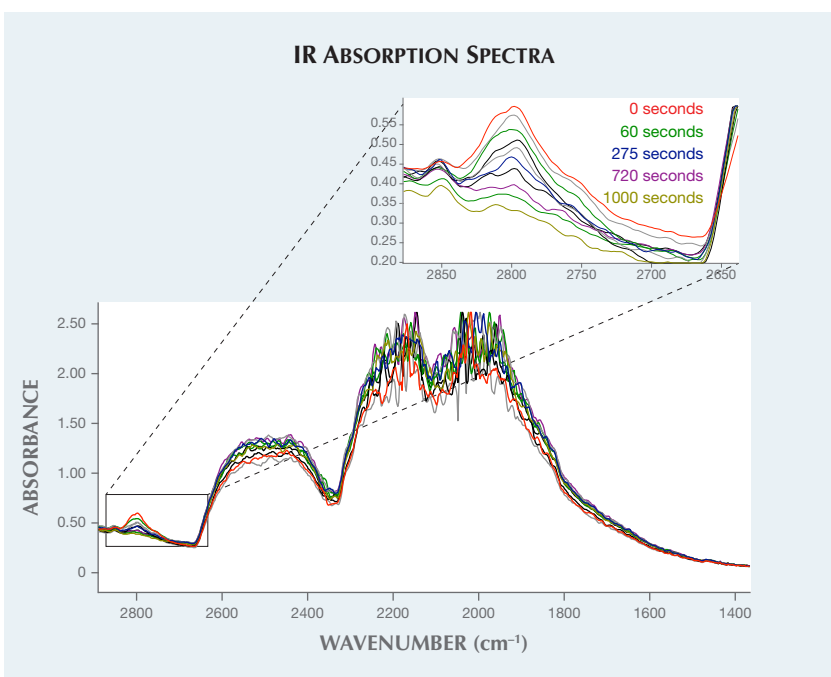

Figure 5. In response to UV excitation, the IR absorption spectra for a 1.01 ct Fancy gray, nominally type IIa diamond shows a pronounced peak at 2800 cm⁻¹, associated with type IIb diamond and boron impurities. The intensity of the 2800 cm⁻¹ peak decays over several minutes. For the sake of clarity, not all collected IR absorption spectra are shown here; the peak at 2850 cm⁻¹ is unrelated to boron and is caused by hydrocarbon contamination on the diamond surface.

and interaction between the brown related and other colour-inducing defects," *Journal of Physics: Condensed Matter*, Vol. 21, 2009, 364213). Immediately after UV excitation, the diamond showed blue phosphorescence and the FTIR spectrum changed from a nominally type IIa diamond to a type IIb, with an uncompensated boron concentration of ~70 ppb (figure 6, left). An increase in the 2800 cm⁻¹ peak upon UV excitation was previously recorded in some other type IIb diamonds as well and in a few other nominally type IIa diamonds examined by GIA, but those showed much lower values than this sample with UV excitation, with an initial increase in Bo of ~5 ppb or less. The decay of the 2800 cm⁻¹ absorption band in the diamond studied here was well described by the non-exponential decay model $1/(1+kt)$, where t is the decay time and k is a constant. This equation fit the absorption decay data better than an exponential decay

model or the hyperbolic decay model that describes type IIb diamond phosphorescence, $1/(1+kt)^2$ (K. Watanabe et al., "Phosphorescence in high-pressure synthetic diamond," *Diamond and Related Materials*, Vol. 6, 1997, pp. 99–106).

Photoluminescence spectra were collected both with and without UV exposure using 488, 514, and 830 nm excitation. The only distinction observed between the two sets of spectra was the addition of a 3H peak (503.5 nm) when the diamond was exposed to UV radiation. The 3H peak is ascribed as an intrinsic defect containing interstitials and is often observed in PL spectra of type IIb diamonds.

Phosphorescence spectra were also recorded (figure 6, right). As expected based on prior research of diamond phosphorescence, the data did correspond well with the hyperbolic model. When boron impurities are present but are electrically compensated by other defects such as nitro-

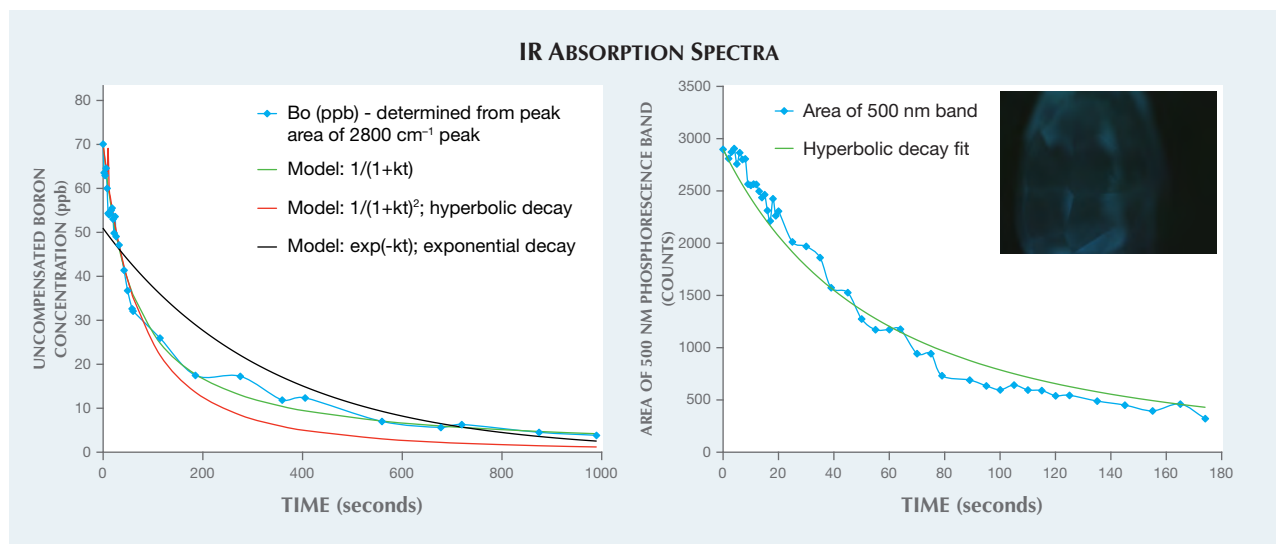

Figure 6. Left: The uncompensated boron concentration for the IR absorption spectra in figure 5 were calculated and compared against several phosphorescence decay models. Right: The decay of the phosphorescence peak at 500 nm, also induced by UV excitation, was calculated and compared against the accepted model for phosphorescence. The DiamondView image shows the diamond's blue phosphorescence.

gen, the 2800 cm^{-1} peak would not be detected and a nominally type IIa diamond would be recorded by IR absorption. However, UV excitation creates a charge transfer effect, temporarily uncompensating some of the boron so that the Bo concentration temporarily increases. This absorption decay of the 2800 cm^{-1} peak is most dramatic in nominally type IIa diamonds such as this sample, but has also been observed to a lesser extent in type IIb diamonds. There are several unanswered questions regarding the phosphorescence mechanism and decay kinetics in type IIb diamonds, and further study of this absorption decay will help address these issues.

Sally Eaton-Magaña

Update on Spectroscopy of "Gold Sheen" SAPPHIRES

Sapphires displaying a golden sheen, known in the trade as "gold sheen" or "Zawadi" sapphires, entered the gem market in late 2009. These sapphires are mined in eastern Kenya (T.N. Bui et al., "From exsolution to 'gold sheen': A new variety of corundum," *Journal of Gemmology*, Vol. 34, No. 8, 2015, pp. 678–691). They contain

dense needles and platelets of hematite/ilmenite inclusions, which are responsible for producing a golden shimmer on the surface.

Recently, GIA's laboratory in Bangkok received 14 gold sheen sap-

phires of various shapes and cuts. The samples had yellow and green to blue bodycolor, were transparent to translucent, and weighed 1.06 to 97.69 ct (figure 7). Their physical properties and inclusions were similar to those of gold

Figure 7. These 14 sapphires, weighing up to 97.69 ct each, displayed a golden sheen effect and in some cases six-rayed asterism. They possessed sufficiently large inclusion-free areas to enable good-quality spectra.

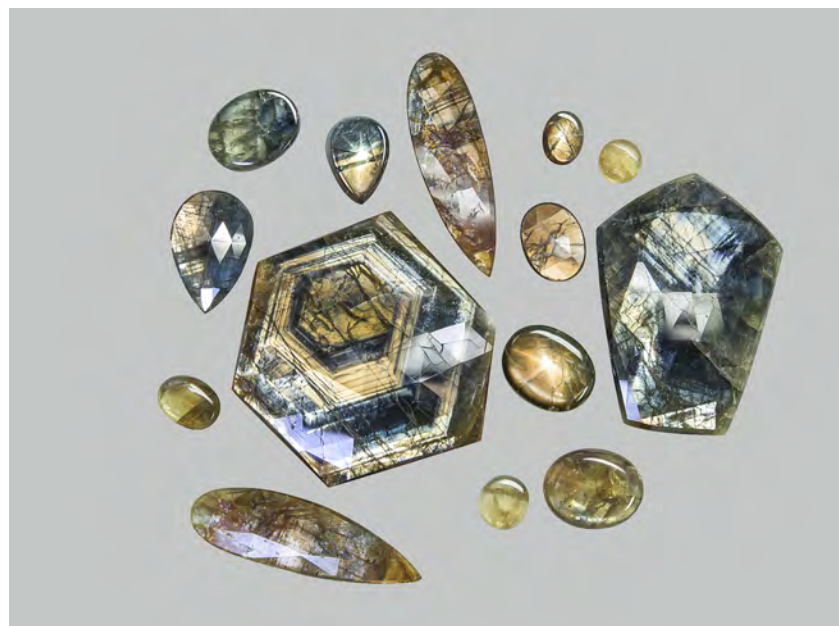

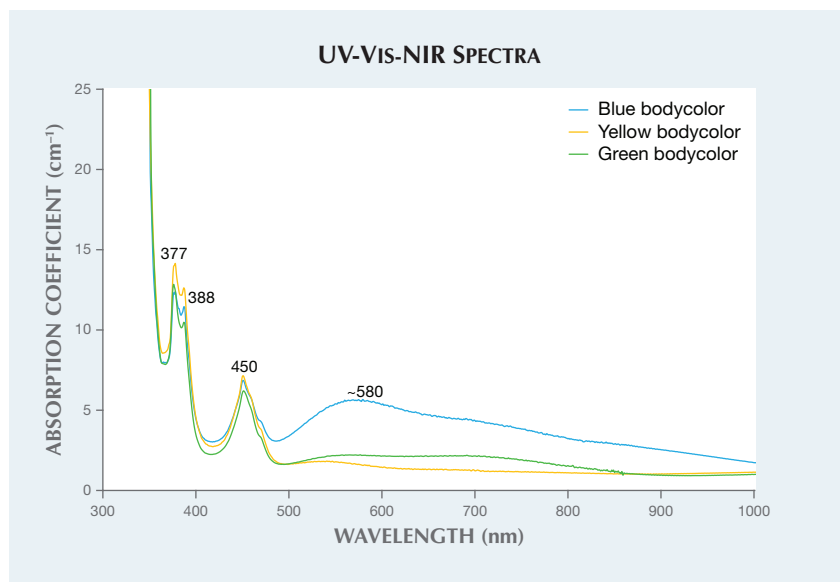

Figure 8. The UV-Vis-NIR spectrum of a gold sheen sapphire with yellow bodycolor revealed strong Fe-related absorption features at 377, 388, and 450 nm. The spectra of green to blue samples revealed an additional Fe^{2+} - Ti^{4+} intervalence charge-transfer band centered at around 580 nm. These samples were not specifically aligned to the c-axis.

sheen sapphires described in Bui et al. (2015): an RI of 1.762–1.772, a birefringence of 0.008–0.009, a hydrostatic SG of 3.98–4.01, an inert reaction to long- and short-wave UV radiation, and an abundance of hematite/ilmenite platelets. Since the samples had some transparent windows, UV-Vis-NIR spectra were analyzed.

The UV-Vis-NIR spectra all displayed strong Fe-related absorption features at 377, 388, and 450 nm. Samples with a yellow bodycolor showed mainly the three Fe features, whereas the green to blue sapphires revealed a band centered at around 580 nm that is related to Fe^{2+} - Ti^{4+} intervalence charge transfer, in addition to the three strong Fe features (figure 8). LA-ICP-MS analysis on inclusion-free areas showed high Fe ranging from 2550 to 3260 ppma, 2 to 8 ppma Mg, 4 to 11 ppma Ti, 30 to 45 ppma Ga, and 0.2 to 0.7 ppma V. For the green to blue samples, Ga/Mg overlapped, varying from 5 to 30. Samples with a yellow bodycolor varied from 4 to 11. Other trace elements including Zr, Nb, Ta, W, Th, and U were also detected but in insignificant quantities. It is notable that Mg and

Ti concentrations were comparable in the yellow samples (all Ti^{4+} charges compensate Mg^{2+} , leaving no Ti^{4+} to interact with Fe^{2+}), whereas Ti concentrations were significantly higher than Mg concentrations in the green to blue sapphires resulting in some Ti^{4+} forming Fe^{2+} - Ti^{4+} pairs (J.L. Emmett et al., “Beryllium diffusion of ruby and sapphire,” *Summer 2003 G&G*, pp. 84–135). The chemical and UV-Vis-NIR spectroscopic features corresponded with the bodycolors of these sapphires. In addition, FTIR spectra of the gold sheen sapphires generally showed diagnostic features of $\text{AlO}(\text{OH})$, consistent with either boehmite or diaspore; kaolinite; and gibbsite.

Wasura Soonthorntantikul,
Ungkhana Atikarnsakul, and
Vararut Weeramonkhonlert

SYNTHETIC DIAMONDS

CVD Synthetic Diamond Over 5 Carats Identified

Chemical vapor deposition (CVD) technology has accelerated over the last several years, and the rapidly improving techniques have produced

large, high-quality near-colorless and colorless synthetic diamonds. Two samples over 3 carats were reported in early 2016 as the largest CVD synthetics (Winter 2015 Lab Notes, pp. 437–439). GIA recently tested a CVD-grown synthetic diamond that weighed over 5 carats, marking a significant milestone.

The 5.19 ct cushion modified brilliant measuring $10.04 \times 9.44 \times 6.18$ mm (figure 9) was submitted to GIA’s Hong Kong laboratory for grading service. The stone was not disclosed as a synthetic diamond. Using the lab’s standard screening and testing processes, it was identified as CVD synthetic. Following examination, a GIA Identification Report was issued and the stone was inscribed on the girdle with the report number and the words “Laboratory Grown,” following GIA’s protocols for undisclosed synthetics.

This is the largest CVD synthetic diamond GIA has examined to date, and the largest reported in the jewelry industry. It had J-equivalent color

Figure 9. This 5.19 ct CVD-grown diamond ($10.04 \times 9.44 \times 6.18$ mm, with J-equivalent color and VS_2 -equivalent clarity) is the largest CVD synthetic GIA has identified to date.



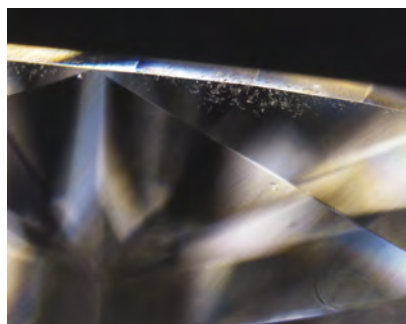

Figure 10. Needles and pinpoints were the major internal features. Black inclusions, a common feature of CVD synthetic diamond, were not observed.



Figure 11. Microscopic examination between crossed polarizers revealed high-order interference colors, attributed to strong lattice dislocation.

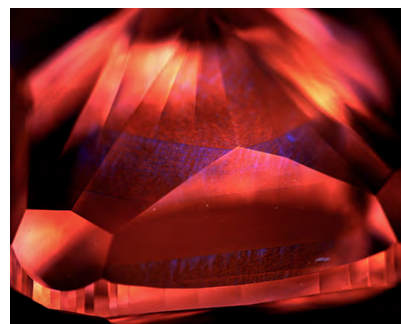

Figure 12. Fluorescence imaging from the DiamondView showed strong red fluorescence with bundles of violet-blue. Up to six growth layers basically parallel to the table were revealed.

grade and VS₂-equivalent clarity, comparable to a high-quality natural counterpart. Natural-looking internal inclusions such as needles and clouds were the major features (figure 10). Strong graining and a fracture in the table were also clearly observed under the microscope. It is worth noting that black inclusions, often contained in synthetic diamond, were not found in this CVD specimen, which could have been mistakenly identified as natural based on microscopic examination alone. This case therefore highlights the importance of using advanced spectroscopic instruments as well as conventional gemological techniques to ensure an accurate identification.

Viewing the sample under a binocular microscope with cross-polarized light revealed irregular birefringence patterns with high-order interference colors, a common feature of CVD synthetic diamond (figure 11). Fluorescence images under the short-wave UV radiation of the DiamondView showed strong red fluorescence with irregularly distributed areas of violet-blue (figure 12). The images also revealed a layered growth structure, indicating a start-stop cycling growth process typical of CVD synthesis. Up to six growth layers basically parallel to the table were identified from the fluorescence features. These multiple growth segments make it possible to grow such a thick sample.

Infrared absorption spectroscopy identified the sample as type IIa. Except for a very weak absorption at 1332 cm⁻¹, no other absorption features (such as hydrogen-related defects) were detected. Photoluminescence (PL) spectra were collected at liquid nitrogen temperature with various excitation wavelengths. The SiV⁻ doublet at 736.6 and 736.9 nm, a common feature of both CVD and HPHT synthet-

ics and only rarely seen in natural diamond, was observed using 457, 514, and 633 nm laser excitation, suggesting the sample's synthetic origin. Spectra acquired with 514 nm laser excitation also showed emissions from NV centers at 575.0 nm (NV⁰) and 637.0 nm (NV⁻), with the NV⁰ center dominating in intensity (figure 13). The occurrence of a weak emission pair at 596.5 and 597.2 nm, in

Figure 13. The photoluminescence spectrum acquired with 514 nm laser excitation revealed strong emissions from NV centers in addition to emissions from SiV⁻. Emissions at 596/597 nm indicated that this synthetic diamond was not annealed after growth.

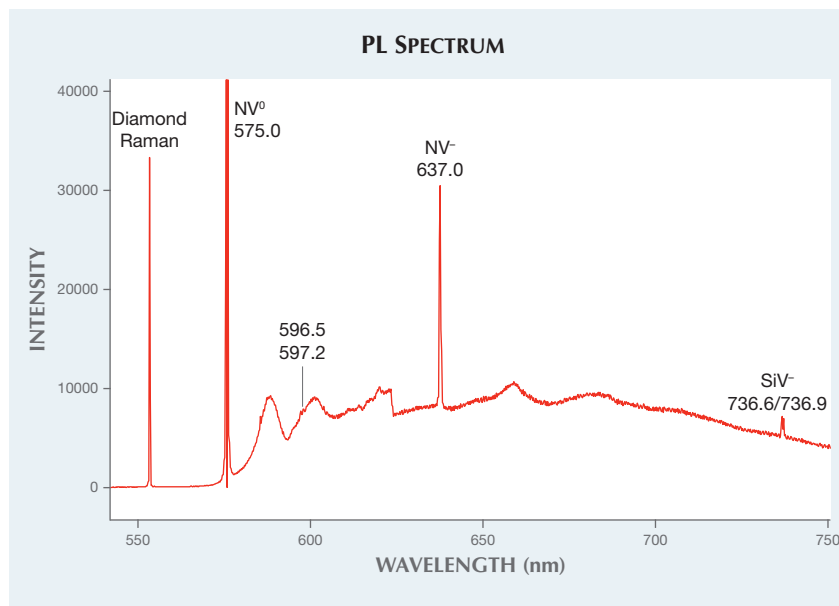

combination with the absence of H3 emission, unequivocally identified this as an as-grown CVD synthetic diamond. No post-growth annealing had been applied to improve its color appearance.

CVD synthetics are available from several sources. The gemological and spectroscopic features of this 5.19 ct sample are very similar to those GIA has examined from Washington Diamonds (now known as WD Lab Grown Diamonds). As diamond growth techniques continue to advance, we expect to see more high-quality samples, both in size and clarity.

*Billie “Pui Lai” Law and
Wuyi Wang*

Blue HPHT Synthetic Diamond Over 10 Carats

In September 2016, GIA’s Hong Kong laboratory tested a 10.08 ct blue synthetic diamond grown by the high-pressure, high-temperature (HPHT) method. This was the largest HPHT synthetic diamond recorded to date. It was also the largest HPHT blue synthetic diamond GIA has examined, surpassing two samples examined by the Hong Kong lab in May 2016 (Summer 2016 Lab Notes, pp. 195–196). The manufacturer of all three stones is New Diamond Technology (NDT) in St. Petersburg, Russia.

The 10.08 ct emerald cut measured $13.54 \times 11.39 \times 7.36$ mm and had a color grade equivalent to Fancy Deep blue (figure 14). The client submitted the stone for scientific examination and disclosed that it was a synthetic diamond. Magnification revealed very weak color zoning with a banded structure. A few very small metallic inclusions and fractures were observed, resulting in a clarity grade equivalent to SI₁. Microscopic examination with crossed polarizers showed no detectable strain, indicating a very low density of dislocations. Fluorescence images collected using the DiamondView revealed the distinctive “hourglass” growth pattern, which is significant in revealing

HPHT growth. Strong blue phosphorescence, another indicator, was also detected. These images were dominated by the {111} growth sector, which had much stronger blue fluorescence. The {100} growth sector with very weak fluorescence was much smaller, indicating this synthetic diamond was produced with octahedral growth. It also exhibited a strong red-orange fluorescence to long-wave UV radiation and a yellow fluorescence to short-wave UV (figure 15), both of which are uncommon.

Infrared absorption spectroscopy confirmed this was a type IIb diamond, with a strong absorption band at ~ 2800 cm⁻¹ in its infrared absorption spectrum attributed to boron impurity. PL analysis conducted at liquid nitrogen temperature with varying laser excitations showed it was surprisingly pure, with no detectable impurity-related emissions.

Based on these gemological and spectroscopic features, we concluded that this sample was an HPHT synthetic diamond. This offered another indication of the rapid progress in HPHT synthetic technology, which offers an option for the diamond jewelry industry as well as many promising industrial and research applications. NDT also plans to offer large colorless and blue HPHT-grown diamonds made from unique donor carbon “DNA,” such as car leather and wood trim that have been turned



Figure 14. This 10.08 ct ($13.54 \times 11.39 \times 7.36$ mm) HPHT-grown diamond, with color equivalent to Fancy Deep blue, is the largest HPHT synthetic to date.

into ultra-clean graphite. With standard protocols in place at GIA laboratories, every type of synthetic diamond on the market can be confidently identified.

*Terry “Ping Yu” Poon and
Wuyi Wang*

Mixing of Natural Diamonds with HPHT Synthetic Melee

In recent years, significant amounts of colorless to near-colorless HPHT-grown synthetic diamond melee have been produced for the jewelry indus-

Figure 15. The blue synthetic diamond showed strong red-orange fluorescence to long-wave UV radiation (left) and yellow fluorescence to short-wave UV.





Figure 16. These 23 HPHT-grown synthetic diamond melee, ranging from 0.002 to 0.012 ct, were identified recently at GIA's Hong Kong lab.

try. As a result, the separation of natural from synthetic melee diamonds has become increasingly critical. GIA offers melee diamond screening services using conventional gemological techniques and analytical methods such as photoluminescence and infrared absorption spectroscopy. In September 2016, GIA's Hong Kong laboratory received 135 melee diamonds for identification service (see figure 16). Of these, 131 were confirmed to be HPHT synthetics and four were natural diamonds. It is interesting to find natural diamonds mixed in HPHT-dominated groups as "contamination."

The tested melee were colorless to near-colorless round brilliants, ranging from 0.002 to 0.012 ct. Infrared absorption spectroscopy performed on the 131 HPHT synthetics showed they were generally type IIb with a very weak absorption band at $\sim 2800\text{ cm}^{-1}$ from trace boron in the diamond lattice. Blue phosphorescence with varying intensity was observed under short-wave UV radiation ($<225\text{ nm}$) and could be easily detected in the DiamondView (figure 17). In photoluminescence spectroscopy collected at liquid nitrogen temperature, clear emissions from SiV^- at $736.6/736.9\text{ nm}$ were recorded using 633 nm laser ex-

citation, and extremely strong Ni-related emissions at $882/884\text{ nm}$ occurred in all 131 synthetic melee. These features are similar to those observed from known HPHT synthetic diamonds from a few sources in China.

The four natural diamonds showed no phosphorescence under short-wave UV radiation. When examined in the DiamondView, they displayed blue fluorescence and very weak phosphorescence. Infrared absorption spectroscopy indicated these stones were type IIa, and no trace boron absorption was recorded. In photoluminescence analysis, no SiV^- emission was detected. Surprisingly, all four diamonds showed weak Ni-re-

Figure 17. Phosphorescence in an HPHT-grown synthetic diamond melee.



Figure 18. This DiamondView image of the 1.60 ct HPHT synthetic shows the diagnostic square pattern seen in the crown facets.

lated emissions at $882/884\text{ nm}$. Their most notable photoluminescence feature was an extremely broad band centered at $\sim 700\text{ nm}$, which is usually observed in natural diamonds.

We would expect to find a small percentage of HPHT synthetics mixed in with natural diamond melee, but on a few occasions we have seen the opposite. As GIA launches the melee sorting service, we anticipate that more melee goods will be submitted for natural vs. synthetic diamond testing.

Terry Poon, Carmen Lo, and
Billie Law

HPHT-Grown Synthetic with Strain

An undisclosed HPHT-grown synthetic diamond was submitted to the GIA laboratory in Ramat Gan, Israel, for a diamond grading report. It weighed 1.60 ct and was in the near-colorless range. Initial screening showed the diamond was type IIa (without detectable nitrogen or boron in the infrared spectrum), which prompted further testing. Examination with the DiamondView fluorescent imaging system revealed the growth patterns betraying the synthetic origin (figure 18). Photoluminescence detected a further lack of impurities: no nickel-related peaks, a very common defect in HPHT synthetics, and only small amounts of nitrogen-vacancy centers.

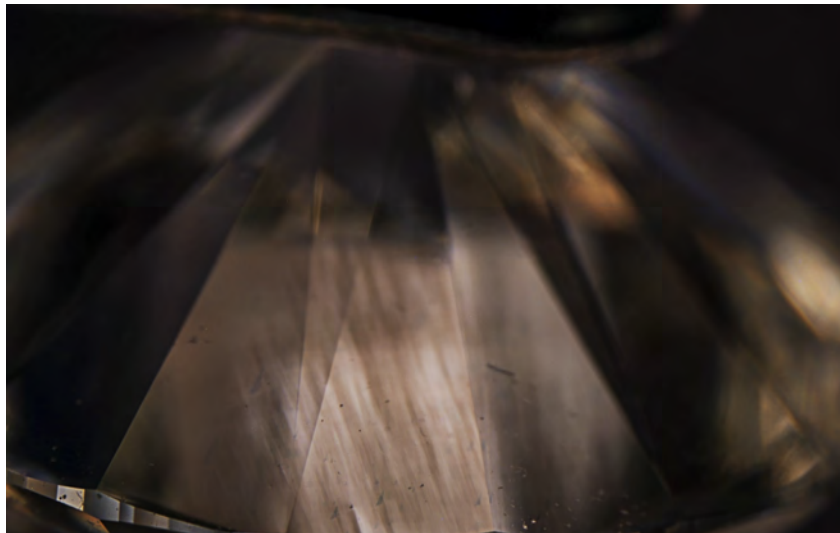

Figure 19. An image taken with polarized light showing the linear birefringence colors, indicating the presence of linear strain in the diamond lattice. Field of view 6 mm.

When viewed under polarized light, the diamond showed very little strain throughout most of the body, but one side on the pavilion displayed noticeable birefringent colors caused by internal strain (figure 19). HPHT-grown synthetic diamonds are known for being mostly free of strain, which generally occurs only around inclusions. They are grown in a metal catalyst, and metal particles can become trapped in them. These trapped particles place stress on the host diamond, which causes strain. But that is a localized strain seen around an inclusion, which was not the case in this synthetic diamond. Except for a small fracture on the pavilion, there were no internal inclusions that could have created strain. Furthermore, the strain

patterns were linear rather than radial, as is the case with inclusion-related strain.

Fortunately, this strain is still distinguishable from the type of strain in natural diamonds, which have a cross-hatched pattern known as “tatami” strain. The cause of the strain in this synthetic diamond is unknown, but if it is related to a new growth process we would expect to see more strained HPHT-grown diamonds in the future. As innovations in the synthetic diamond industry continue to introduce a wider variety of products, more and more properties of natural and synthetic diamonds will start to overlap, necessitating caution when separating stones.

Troy Ardon and Ronny Batin

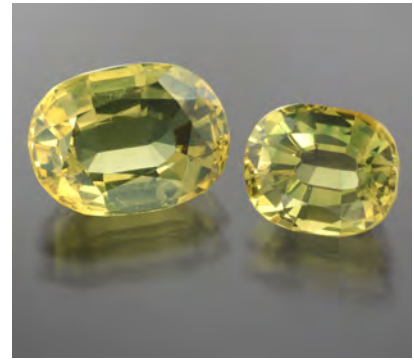

Figure 20. These two doublets, a 6.45 ct greenish yellow oval mixed cut and a 4.17 ct greenish yellow cushion mixed cut, contained a synthetic spinel crown and a synthetic sapphire pavilion.

SYNTHETIC SAPPHIRE and SYNTHETIC SPINEL Doublets

Assemblages have been used to imitate various gemstones for many years. Some of the most common are garnet and glass doublets, sapphire and synthetic corundum doublets, synthetic spinel triplets, and beryl triplets.

The Carlsbad laboratory recently examined two uncommon doublets: a 6.45 ct greenish yellow oval mixed cut and a 4.17 ct greenish yellow cushion mixed cut (figure 20). Initial microscopic observation revealed a separation plane near both girdles with flattened, trapped gas bubbles in colorless cement (figure 21, center). The green crowns were joined to the yellow pavilions with this colorless

Figure 21. Left: The green crown and yellow pavilions of the 6.45 ct oval mixed cut are easily observed in immersion. Center: A separation plane near the girdle with a flattened, trapped gas bubble; field of view 1.76 mm. Right: Parallel twinning planes in the pavilion; field of view 2.90 mm.

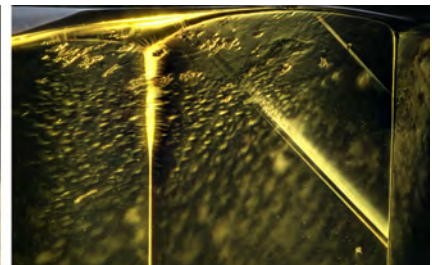
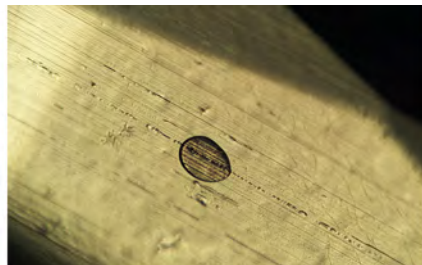
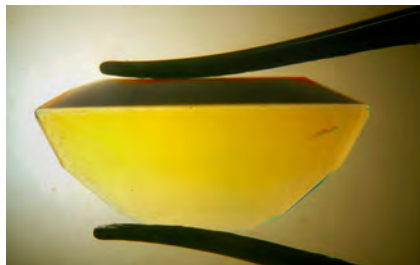



Figure 22. This tortoiseshell scepter is from the Palais Royal collection.

cement (figure 21, left). An RI of 1.728 and whitish chalky fluorescence under short-wave UV on both crowns were suggestive of synthetic spinel. One of the doublets showed thick green curved color banding. Photoluminescence (PL) emission spectra identified the crowns as synthetic spinel.

In both doublets, the pavilion had a refractive index of 1.760 to 1.768 and was inert to UV radiation. The two assemblages were clean and showed only twining planes (figure 21, right). Faint yellow curved color banding was visible when they were immersed in methylene iodide and observed with a blue color filter. EDXRF analysis showed a chemical composition consistent with synthetic corundum. They contained Ni as a trace element and no Fe, Ga, or Ti.

Microscopic observation and advanced gemological testing confirmed that these were doublets consisting of a synthetic spinel crown and a synthetic sapphire pavilion, joined together with a colorless cement. These are the first assemblages of synthetic spinel and synthetic sapphire observed by GIA.

Najmeh Anjomani

Laminated TORTOISESHELL Scepter

“Tortoiseshell” generally refers to a material produced from the shell of the hawksbill sea turtle (T. Hain-schwang and L. Leggio, “The characterization of tortoise shell and its imitations,” Spring 2006 *G&G*, pp. 36–52). Because of its attractive appearance, durability, and thermoplasticity, it had been widely used for jewelry, personal items, and ornamental objects since ancient times, until the international trade of new tortoiseshell was banned in the 1970s under the Convention on International Trade in Endangered Species (www.cites.org). Today, this material is seldom submitted to gemological laboratories.

Recently, a mottled brownish orange scepter measuring 203.00 × 41.45 × 42.52 mm was submitted to GIA’s Hong Kong laboratory (figure 22). The object was adorned with white metal and numerous stones of various shapes and colors.

Standard gemological testing revealed an RI of 1.56. In addition to the orange bodycolor with distinctive brown patches and resinous luster, the strong odor of burned protein given in hot point testing ruled out most inor-

ganic and organic materials except the keratinous materials tortoiseshell and horn. Under magnification, the piece showed a layered structure and mottled color patches made up of numerous brownish dots of pigment (figure 23), both typical of tortoiseshell. The only remaining question was the thickness of the piece, which at 42.52 mm far exceeded tortoiseshell’s maximum thickness of 9–12 mm (Hain-schwang and Leggio, 2006). The orange part of the scepter exhibited a strong blue reaction to long-wave UV radiation, with a wavy layered struc-

Figure 23. The brown patches in the tortoiseshell scepter were made up of numerous brownish spots. Field of view 1.88 mm.



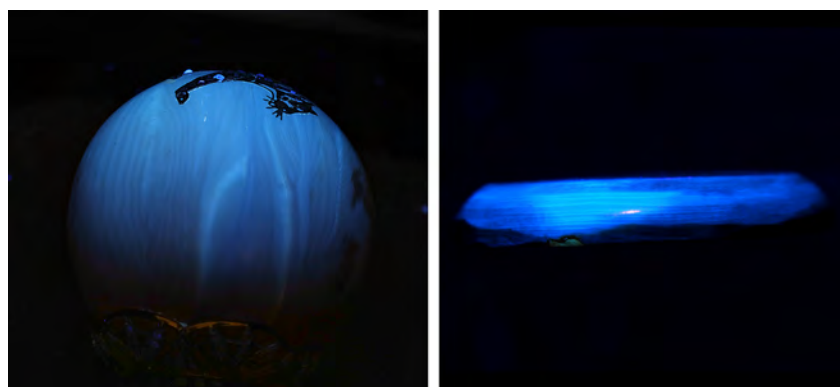

Figure 24. Left: Under long-wave UV, the scepter showed disordered wavy layers of various thickness and boundary layers marked by structural discontinuities. Right: A natural tortoiseshell tablet displays a parallel layered structure in side view. Field of view 19.27 mm.

ture and distinct boundaries (figure 24, left), and a weaker reaction to short-wave UV. The brown patches were inert to both long-wave and short-wave UV. Taking into account the piece's exceptional thickness and the unusual structural discontinuities observed under UV source, we concluded this material was laminated tortoiseshell.

Further analysis by FTIR on powdered samples collected at different layers showed a keratin spectrum with predominant amide peaks at 1637, 1516, and 1236 cm^{-1} (figure 25), which confirmed the material was

tortoiseshell (Hainschwang and Leggio, 2006). High levels of S and Cl detected by EDXRF were also consistent with known tortoiseshell samples.

Xiaodan Jia and Mei Mei Sit

TURQUOISE with Simulated Matrix

The Carlsbad laboratory recently examined a 78.60 ct greenish blue oval bead with patches that contained fragments of a metallic material in dark matrix (figure 26). Standard gemological testing of the greenish

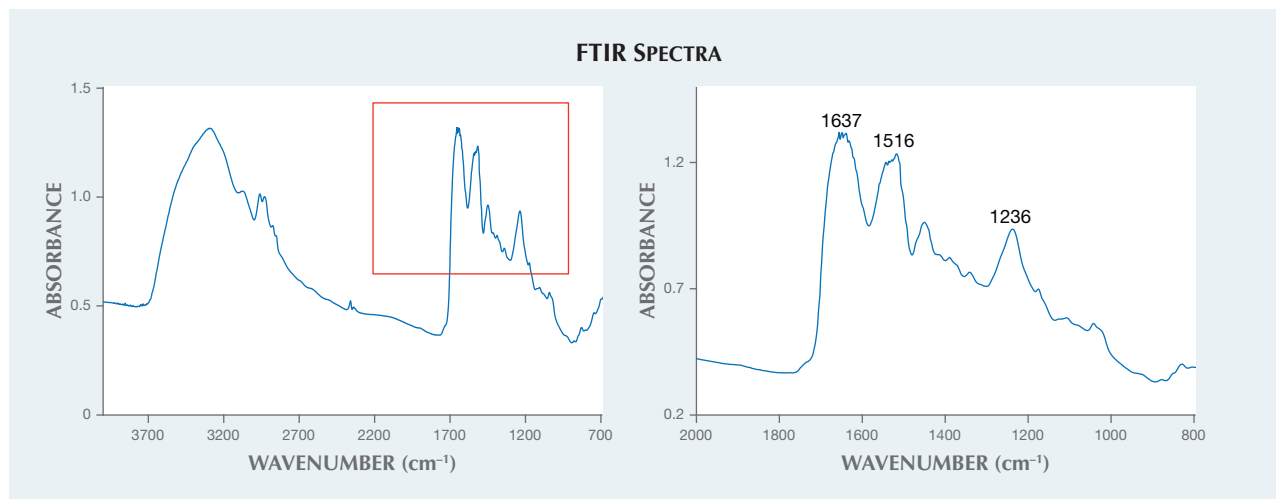

Figure 26. A 78.60 ct greenish blue turquoise oval bead with artificial metallic pyrite. The turquoise was filled with a mixture of crushed pyrite and polymer.

blue areas showed properties consistent with turquoise, including a refractive index of 1.60. Microscopic observations revealed the typical visual characteristics of turquoise: blue and white mottling, a granular texture, and a waxy luster with no evidence of dye. Raman analysis confirmed the metallic material was pyrite, and infrared spectroscopy indicated the greenish blue material was turquoise.

Upon closer investigation using a standard gemological microscope, it

Figure 25. FTIR spectra of the tortoiseshell displayed amide peaks at 1637, 1516, and 1236 cm^{-1} . The spectrum on the right is a closer view of the region in the red box on the left.



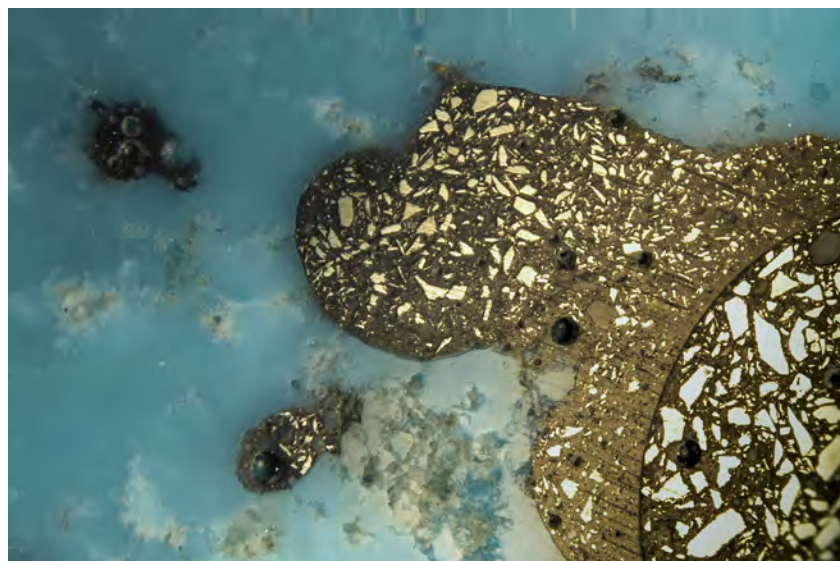

Figure 27. Closer magnification revealed crushed pyrite crystals, voids left behind from gas bubbles, and a discontinuity between two episodes of filling. Field of view 4.02 mm.

became clear that the pyrite was composed of irregular and angular broken fragments suspended in a fine-grained black matrix. In addition, each dark patch displayed well-defined boundaries with hemispherical voids, presumably gas bubbles that had been

cut through during polishing. Interestingly, one patch showed a discontinuity between two different shades of color and textures of the pyrite in black matrix (figure 27). Based on our observations, we believe these patches were formed by filling the

cavities of the turquoise with a mixture of crushed pyrite crystals and a type of polymer resin. The treatment might have involved one or more filling episodes, which could explain the discontinuity seen in one of the patches. The filled turquoise was later polished into the finished product we observed.

In the past, we have seen a variety of treatments for turquoise, but this was the first example of an artificial pyrite-containing matrix examined at the Carlsbad laboratory.

Rebecca Tsang

PHOTO CREDITS:

HyeJin Jang-Green—1; Jian Xin (Jae) Liao—3 (left); Evan M. Smith—3 (center and right); Lhapsin Nillapat—7; Johnny Leung and Tony Leung—9, 16; Billie "Pui Lai" Law—10, 11, 12; Johnny Leung—14, 15, 24 (left); Troy Ardon—18, 19; Robison McMurry—20; Nathan Renfro—21; Tony Leung—22; Xiaodan Jia—23; Jonathan Muiyal—24 (right); C.D. Mengason—26; Rebecca Tsang and Nathan Renfro—27.

THANK YOU, REVIEWERS

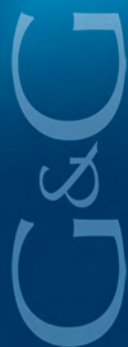

GEMS & GEMOLOGY requires each manuscript submitted for publication to undergo a rigorous peer review process, in which each paper is evaluated by at least three experts in the field prior to acceptance. This is essential to the accuracy, integrity, and readability of *G&G* content. In addition to our dedicated Editorial Review Board, we extend many thanks to the following individuals who devoted their valuable time to reviewing manuscripts in 2016.

Vittorio Bellani • Troy Blodgett • Robert Boyd • Warren Boyd • Gagan Choudhary • Manoj Dhandia • Barbara Dutrow • Richard Hughes • Estelle Levin • Yan Liu • Jana Miyahira-Smith • Kyaw Soe Moe • Mikhail Ostrooumov • Karl Schmetzer • Monica Solorzano-Kraemer • Steven B. Shirey • K. Srinivasan • Lawrence Stoller • Ziyin Sun • Rose Tozer • Geza von Habsburg • Barbara Wheat • Alexander Zaitsev

G&G

Micro-World

Editor

Nathan Renfro

Contributing Editors

Elise A. Skalwold and John I. Koivula

Quartz Windows in Chalcedony

We recently examined a 55.08 ct polished half-moon-shaped plate of white and brownish yellow chalcedony from Madagascar that was fashioned by Falk Burger (Hard Works, Tucson, Arizona). As can be seen in figure 1, more than a dozen hexagonal windows of transparent colorless quartz accentuated by thin frames of brownish yellow chalcedony are randomly scattered throughout the host. In this specimen the quartz crystals would be considered protogenetic inclusions since the chalcedony formed around the preexisting crystals. The quartz crystals are all twinned on the Brazil law, and the c-axes of the quartz windows are all aligned in parallel fashion. As a result, when the chalcedony plate is examined between crossed polarizing filters, the transparent windows all display their twinning through the presence of colorful stellate patterns (figure 2) that vary in appearance as the plate is rotated or moved about in the polarized light field (see video at <http://www.gia.edu/gems-gemology/quartz-window-chalcedony>).

John I. Koivula

Sphalerite Inclusions in Namibian Demantoid

The inclusion scene of skarn-related demantoid garnets from Namibia and Madagascar is dramatically different from that of serpentinite-hosted demantoid found in the classic locality of the Russian Urals. Reported inclusions

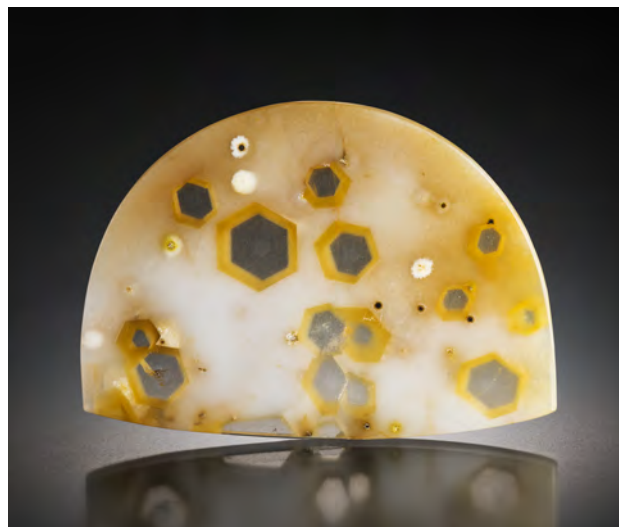

Figure 1. Measuring $52.56 \times 36.71 \times 2.88$ mm, this half-moon-shaped chalcedony plate contains more than a dozen hexagonal quartz windows. Photo by Kevin Schumacher.

in Namibian demantoid include diopside, wollastonite, quartz, calcite, fluid inclusions, and sphalerite (F. Koller et al., "The demantoid garnets of the Green Dragon mine (Tubussi, Erongo Region, Namibia)," Joint 5th Mineral Sciences in the Carpathians Conference and 3rd Central-European Mineralogical Conference, April 19–21, Miskolc, Hungary, 2012). Demantoid from Madagascar is reported to contain inclusions of diopside, wollastonite, fluid inclusions, and growth tubes (F. Pezzotta et al., "Demantoid and topazolite from Antetetzambato, northern Madagascar: Review and new data," Spring 2011 *G&G*, pp. 2–14). There has been little photomicrographic documentation of these inclusion suites, however.

About the banner: The banner image shows irregular, iridescent exsolution rutile, known as "silk," in a Sri Lankan purple sapphire. Photomicrograph by Nathan Renfro; field of view 1.29 mm.

Editors' note: Interested contributors should contact Nathan Renfro at nrenfro@gia.edu and Jennifer-Lynn Archuleta at jennifer.archuleta@gia.edu for submission information.

GEMS & GEMOLOGY, VOL. 52, NO. 4, PP. 422–427.

© 2016 Gemological Institute of America

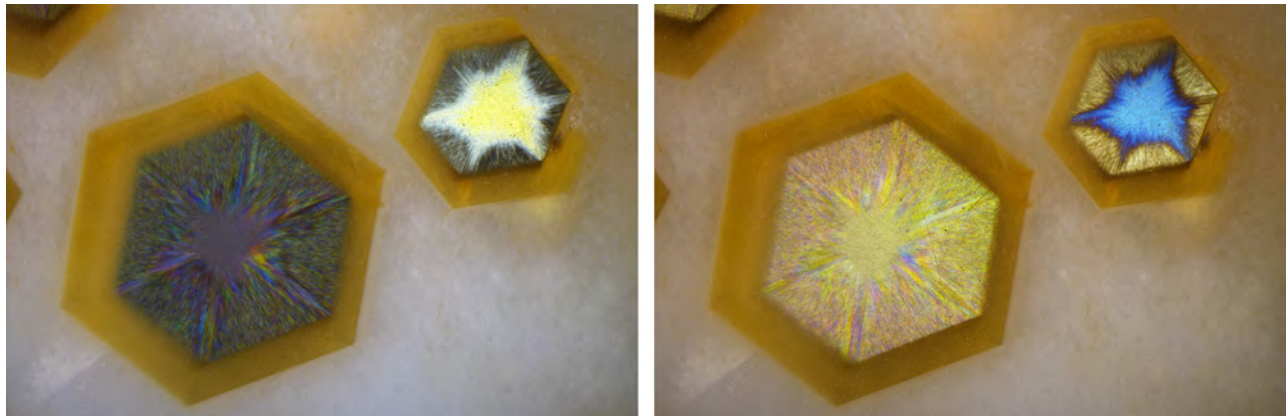
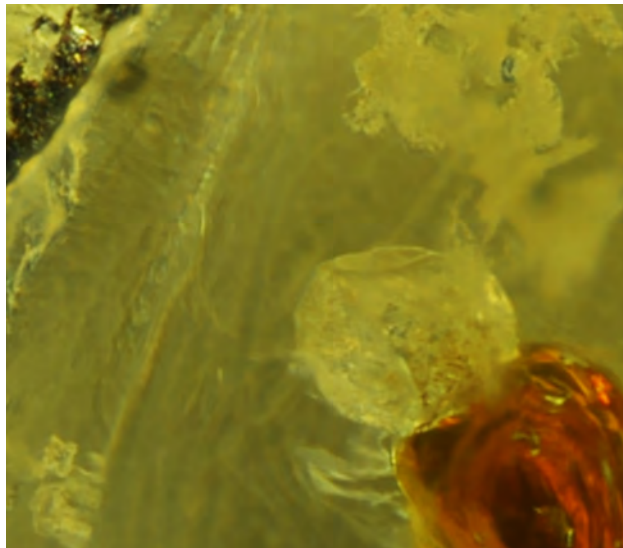

Figure 2. When viewed between crossed polars, Brazil-law twinning in the quartz windows is revealed as stellate patterns (left). As the analyzer is rotated, different colors are revealed along the twinning (right). Photomicrographs by Nathan Renfro; field of view 19.01 mm.

In this contribution we document relatively rare sphalerite inclusions in a Namibian demantoid crystal. Figure 3 shows a translucent brownish orange sphalerite inclusion with a spheroidal diopside aggregate adhering to it (both identified by Raman spectroscopy). While a clear Raman signal could not be obtained on a nearby crystal, its rhombohedral morphology leads the author to speculate that it is a calcite inclusion. The two sphalerite inclusions seen in figure 4 are larger, so their color is a much darker orangy brown. The oblique fiber-optic illumination used in this photo highlights the highly lustrous surface of these spha-

Figure 3. A brownish orange sphalerite inclusion in Namibian demantoid with a spheroidal diopside aggregate along its upper left side. Based on its morphology, the rhombohedral crystal on the upper right could be a calcite inclusion. Photomicrograph by Aaron Palke; field of view 0.72 mm.



lerite inclusions. Further photomicrographic documentation of the inclusion suites in demantoid from Namibia and Madagascar may help to identify inclusion scenes unique to these skarn deposits.

Aaron Palke
Queensland Museum and University of Queensland
Brisbane, Australia

Ferropericase Inclusion in Diamond

Most diamonds originate from the cratonic lithosphere, the basal portion of the thickest, oldest parts of continents.

Figure 4. Oblique fiber-optic light illuminates the surface luster of these sphalerite crystals within a Namibian demantoid. Photomicrograph by Aaron Palke; field of view 0.84 mm.

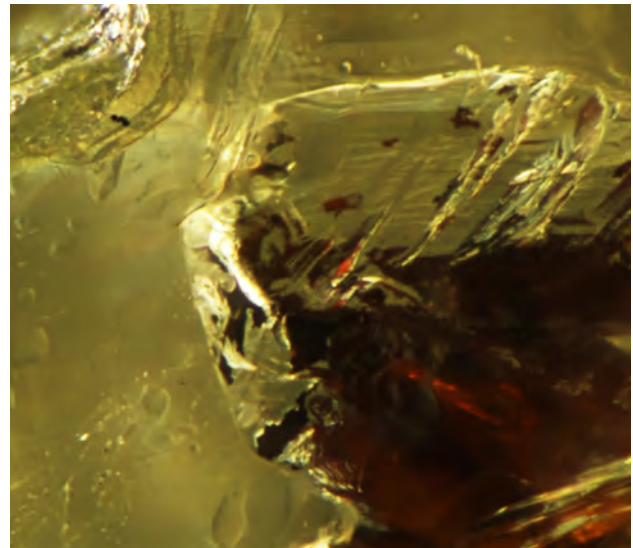



Figure 5. The changing iridescent colors of a ferropericlase inclusion are revealed through different facets of the host diamond. Photomicrographs by Evan M. Smith; field of view 1.99 mm.

Rarely, diamonds are found with mineral inclusions that indicate a deeper origin, below the lithosphere, within the convecting mantle. Ferropericlase, $(\text{Mg,Fe})\text{O}$, is one of the most common of such “superdeep” inclusion phases (T. Stachel et al., “Inclusions in sublithospheric diamonds: Glimpses of deep Earth,” *Elements*, Vol. 1, 2005, pp. 73–78). It often exhibits a vivid iridescence that serves as a helpful identifier. A 1.54 ct Fancy Light pink type IIa diamond with a spectacular ferropericlase inclusion was recently examined in GIA’s New York lab (figure 5). The exact cause of this iridescence is unknown, but it may arise at the inclusion-diamond interface due to thin-film interference from trapped fluid or structural coloration from ultra-fine exsolution of magnesioferrite. The iridescent colors of these ferropericlase inclusions change with viewing and lighting angles. The iridescence is not always uniform and can sometimes be absent, in which case the inclusion appears a transparent deep brown color.

Strictly speaking, ferropericlase inclusions alone do not necessarily indicate a sublithospheric origin (T. Stachel et al., 2005). This is the case for the present diamond, so the assignment of sublithospheric origin is only tentative. It may be possible to create ferropericlase at shallower depths, in the lithosphere, if special conditions occur that lower the availability of silica.

*Evan M. Smith and Kyaw Soe Moe
GIA, New York*

Apatite Cluster in Orthoclase Feldspar

A yellow orthoclase feldspar (figure 6) recently examined by these authors was of particular interest, not only for its size and clarity but also for the unusual cut. The 7.20 ct oval had a wide table facet that dramatically framed a large eye-visible crystal cluster just below its surface. The potassium-rich orthoclase host was identified using traditional gemological testing and confirmed by Raman microspectrometry, which also identified the inclusion as apatite (figure 7).

This relatively large apatite cluster was composed of hexagonal elongated prismatic crystals, a morphology typ-

ical of the mineral. They also proved to be opaque and exhibited evidence of a certain degree of softness by their slightly corroded crystal faces (again, see figure 7). Several small tension stress cracks were observed surrounding the inclusion. The altered appearance suggests that these apatite crystals are protogenetic inclusions that were present in the growth environment before the orthoclase began to form.

Apatite, a common phosphate mineral, has been described in the literature as a crystal inclusion in various

Figure 6. Located just left of center, a large apatite crystal cluster is visible directly below the table facet of this 7.20 ct orthoclase feldspar (the inclusion is also reflected numerous times by the pavilion facets). Photo by Kevin Schumacher.





Figure 7. A tiny crystal next to this large cluster of prismatic hexagonal apatite crystals resembles a space shuttle approaching a space station. The image was taken using darkfield illumination. Photomicrograph by Jonathan Muyal; field of view 4.79 mm.

gem materials and as randomly scattered “jackstraw” needles in yellow orthoclase from Madagascar (E.J. Gübelin and J.I. Koivula, *Photoatlas of Inclusions in Gemstones, Volume 2*, Opinio Verlag, Basel, Switzerland, 2005). This specimen’s morphology and size make it an aesthetically pleasing example of apatite as a crystal inclusion in orthoclase, and therefore an interesting collector’s gemstone.

Jonathan Muyal and John I. Koivula

Curved Tubes in Blue Sapphire

During a GIA field expedition to Vietnam in May 2016, a 0.45 ct faceted blue sapphire containing numerous hair-like curved tubes (figure 8) was discovered at the gem mar-

Figure 8. Curved linear features with healed fissures. The image was taken using a combination of dark-field and fiber-optic illumination. Photomicrograph by Victoria Raynaud/GIA; field of view 3.50 mm.



ket in Yen The. While the seller said the stone was mined in the Luc Yen area, this could not be confirmed. Unlike rubies and spinels, blue sapphires are not common in northern Vietnam. Analysis at GIA’s laboratory in Bangkok revealed that the stone had a metamorphic origin and had been heat treated. The tubes contained highly reflective glassy masses.

Curved linear inclusions are well known in different types of gemstones. The most famous are probably the horsetails in demantoid garnet. Inclusions with a similar appearance have been observed in emeralds from Sandawana (Zimbabwe), quartz, and rhodonite (E.J. Gübelin and J.I. Koivula, *Photoatlas of Inclusions in Gemstones*, Vols. 1 and 2, Opinio Verlag, Basel, Switzerland, 1986 and 2005; V. Pardieu, “Winza ruby? No sorry, my name is rhodonite!” <http://www.giathai.net/rhodonite>).

In the corundum family, the only documented variety containing curved linear features are rubies from Winza, Tanzania (D. Schwarz et al., “Rubies and sapphires from Winza, central Tanzania,” Winter 2008 *G&G*, pp. 322–347). To our knowledge, these features have never been documented in blue sapphires.

Victoria Raynaud, Wim Vertriest, and Vincent Pardieu
GIA Bangkok

Synthetic Quartz: A Designer Inclusion Specimen

As interest in gem and mineral inclusions grows, the value of inclusion specimens has increased as well. This has led to the relatively recent trend of simulated inclusion specimens being offered in the marketplace (see E.A. Skalwold, “Evolution of the inclusion illusion,” *InColor*, Summer 2016, pp. 22–23). To the best of this author’s knowledge, the synthesis of a quartz host with inclusions—or for that matter, any type of synthetic crystal—for the express purpose of creating a collectable inclusion specimen has not yet been reported and therefore presents a very interesting project to pursue.

Natural quartz plays host to a wide variety of inclusions, including several types of colorful garnets that often lend an aesthetic contrast to this already fascinating mineral. The author retained the services of a synthetic quartz manufacturer who refined and implemented her plan for growing four small specimens: one with pyrope garnets, one with almandine garnets, one with both types, and one without added garnets as control. The chosen garnets are brightly colored despite their tiny size and so fit with the desire to keep the finished quartz crystals small, given the long and expensive growth period required for the hydrothermal process.

Using a five-meter-tall industrial high-pressure autoclave, several runs were completed over a four-month period. Prior to the second run, the garnets were introduced into holes bored into the quartz. A few of the garnets were thus successfully captured and incorporated within the host as the second run continued. The nutrient solution for the



Figure 9. A 50 × 27 × 13 mm synthetic quartz crystal in which almandine and pyrope garnets introduced during the growth process created a suite of inclusions in the lower right of the specimen within the same plane as an elongated liquid and gas two-phase inclusion. The six vertical prism faces and angled rhombohedral faces help orient the crystal and mirror those of natural quartz, but their unnatural surface features immediately give away the synthetic origin. In the foreground are approximately 2.5 mm water-worn pyrope crystals (left) and 1.5–2.0 mm dodecahedral almandine crystals (right) similar to those used as inclusions; the almandines were extracted from the schist matrix specimen shown in the background. Photo by Elise A. Skalwold.

quartz growth consisted of approximately 10 wt.% of Na_2CO_3 in pure water, with many trace elements originating from the milky vein Arkansas quartz used as the silica source. To produce the desired crystal morphology, a seed with “c-a” cut was used to initiate growth vertically along the c-axis and elongation along the a-axis. Rather than being hung by wires in the autoclave, the growing crystals sit on a shelf, and hence there is no wire in the finished specimen. The growth temperature was approximately 350°C in a pressurized environment of 700-plus bars.

When the autoclave was opened at the end of four months, four crystals of approximately the same size emerged intact, one of which is described here as representative of the entire set (figure 9). Along with “breadcrumb” inclusions familiar to gemologists, the suite of captured garnets was surrounded by unidentified white masses and radiating cracks. Quartz’s structure can be thought of as an open yet distorted framework of silicon and oxygen atoms. Because these bonds have angles that change rapidly with temperature, the *volume* of quartz changes rapidly with change in temperature—much more rapidly than the rather closely packed atoms in garnet. So it is not surprising that as the specimens cooled, the quartz shrank faster



Figure 10. Amid a storm of breadcrumb inclusions, two orangy red almandines and two larger red pyropes caused tension cracks to form in the quartz upon cooling. Portions of a two-phase liquid and gas inclusion running nearly the length of the crystal are indicated by the large bubbles seen at the left and right edges of the image. The guest quartz crystal (part of a multi-phase inclusion at right), along with the white masses accompanying the garnets, are remnants from the nutrient environment in which the quartz crystal grew. Transmitted and oblique fiber-optic light. Photo by Elise A. Skalwold; field of view 13 mm.

than the garnets, causing the quartz to fracture (figure 10). Having formed previous to the growth of the quartz that later captured them, these garnets would be considered “protogenetic” inclusions. Some liquid and gas originating from the autoclave’s environment was also captured as a two-phase inclusion running perpendicular to the c-axis of the quartz. The glassy prism faces of the crystals display characteristic diagonal striations, unlike the prism faces of natural quartz, which have horizontal striations (i.e., perpendicular to the c-axis). Originally, one of the four crystals was intended to be cut into a cabochon to illustrate a classic “rough and cut” suite, but it would have been a shame to sacrifice even one of these pristine and arguably unique synthetic quartz inclusion specimen simulants. Therefore, they will remain as they are in the author’s collection—as her own “designer inclusion specimens.”

Elise A. Skalwold

Quarterly Crystal: Growth Features on Titanite

The micro-world of gems and minerals involves not only solid and fluid inclusions, but also significant surface features. If a gem crystal is fashioned into a gemstone by a lapidary artist, most of the surface features of any significance are removed during the process. So when we encounter a



Figure 11. This beautifully formed 17.04 mm titanite crystal from Russia owes its green color to the presence of vanadium. Photo by Kevin Schumacher.

beautiful gem crystal, we always take the opportunity to examine the natural surfaces for any interesting evidence of growth or dissolution.

In that regard, we recently studied a beautifully formed titanite crystal (figure 11) from the Ural Mountains in

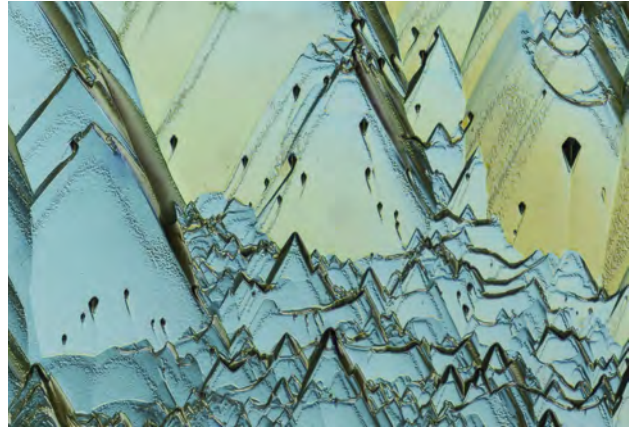

Figure 12. Some of the growth features observed on the surface of the titanite crystal were reminiscent of jagged mountain peaks. Photomicrograph by Nathan Renfro; field of view 0.72 mm.

Russia that measured $17.04 \times 15.27 \times 0.94$ mm and weighed 2.35 ct. EDXRF analysis confirmed that its bright green color resulted from the presence of vanadium. As shown in figure 12, examination of the surface using Nomarski differential interference contrast microscopy revealed an abundance of growth features, some with rather dramatic architecture. These were the features targeted for photomicrography.

John I. Koivula

For More on Micro-World

To see video of the twinning of quartz windows in a chalcedony plate, as featured in this section, please visit www.gia.edu/gems-gemology/quartz-window-chalcedony, or scan the QR code on the right.

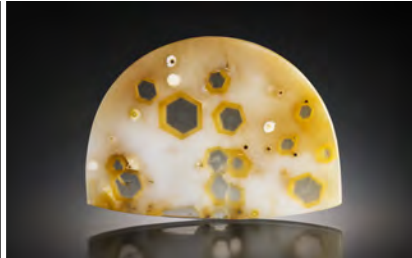

Contributing Editors

Emmanuel Fritsch, *University of Nantes, CNRS, Team 6502, Institut des Matériaux Jean Rouxel (IMN), Nantes, France* (emmanuel.fritsch@cnrs-imn.fr)

Gagan Choudhary, *Gem Testing Laboratory, Jaipur, India* (gagan@gjepcindia.com)

Christopher M. Breeding, *GIA, Carlsbad* (christopher.breeding@gia.edu)

COLORED STONES AND ORGANIC MATERIALS

Blue dravite-uvite tourmaline from Koksha Valley, Afghanistan. Tourmaline is popular among gem and mineral enthusiasts for its extensive variety of colors. Blue, one of the most sought-after hues, is usually encountered as elbaite, a sodium- and lithium-containing species with the chemical formula $\text{Na}(\text{Li}_{1.5}\text{Al}_{1.5})\text{Al}_6(\text{Si}_6\text{O}_{18})[\text{BO}_3]_3(\text{OH})_3(\text{OH})$. While it has been reported that very limited quantities of dark blue tourmaline crystals are being mined in Afghanistan's Koksha Valley, we have found that this material appears to be a hybrid species of dravite-uvite tourmaline (figure 1).

Around a dozen blue crystals in pale green and brown micaceous matrix first surfaced in the gem markets of Peshawar, Pakistan, in late 2009, as confirmed by two sources (S. Khan and P. Slootweg, pers. comms., 2016). These crystals, reportedly from Badakhshan Province's Koksha Valley, were subsequently assumed to be a member of the tourmaline group based on their ditrigonal pyramidal habit. Since that time, only very small batches of these crystals have turned up; interestingly, a few of these specimens have been associated with sapphire in the same matrix (P. Slootweg, pers. comm., 2016). In 2010, while examining sapphire rough believed to be from a deposit near the Koksha Valley, GIA's Bangkok laboratory identified bluish green crystals present in some matrix specimens of sapphire as dravite tourmaline (Spring 2011 Lab Notes, pp. 53–54). While the Koksha Valley is most famous for extensive deposits of high-quality lapis lazuli near Sar-e-Sang, sapphire mining takes place near the vil-



Figure 1. This specimen of dark blue tourmaline on micaceous matrix, from the Koksha Valley of Badakhshan Province in Afghanistan, measures 28 × 25 × 17 mm. Photo by Kevin Schumacher.

Editors' note: Interested contributors should send information and illustrations to Stuart Overlin at soverlin@gia.edu or GIA, The Robert Mouawad Campus, 5345 Armada Drive, Carlsbad, CA 92008.

GEMS & GEMOLOGY, VOL. 52, NO. 4, pp. 428–440.

© 2016 Gemological Institute of America

lage of Hazrat Saeed, 25 km north of Sar-e-Sang along the Koksha River (T.P. Moore and R.W.M. Woodside, "The Sar-e-Sang lapis mine," *Mineralogical Record*, Vol. 45, No. 3, 2014, pp. 280–336). The sapphire at Hazrat Saeed is recovered from mica-rich gneiss, and it appears that these green and blue tourmalines were uncovered as a by-product of sapphire mining operations.

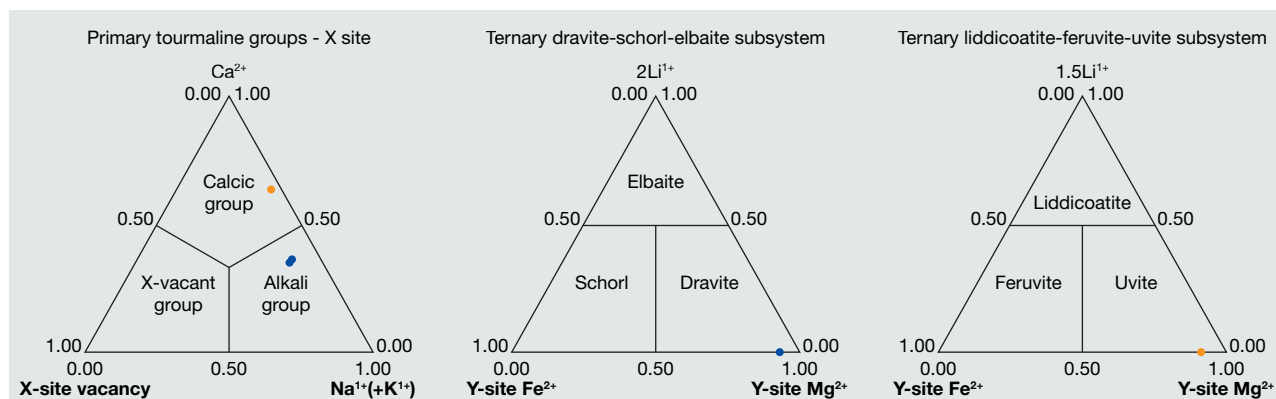

Figure 2. Left: Three laser spots were plotted in the ternary system for the primary tourmaline groups based on the dominant occupancy of the X site. Center: Two blue laser spots that belong to the alkali primary tourmaline group were further plotted in the ternary dravite-schorl-elbaite subsystem. Right: One orange laser spot that belongs to the calcic primary tourmaline group was further plotted in the ternary liddicoatite-feruvite-uvite subsystem. These findings show a range of composition consistent with the dravite-uvite series.

Laser ablation-inductively coupled plasma-mass spectrometry (LA-ICP-MS) was used to analyze the chemical composition of the dark blue tourmaline seen in figure 1. Three spots were measured and plotted (figure 2). Two of the spots showed that the tourmaline contained dravite; the third revealed the presence of uvite (D.J. Henry et al., "Nomenclature of the tourmaline-super group minerals," *American Mineralogist*, Vol. 96, No. 5-6, 2011, pp. 895-913). Dravite, $\text{NaMg}_3\text{Al}_6(\text{Si}_6\text{O}_{18})(\text{BO}_3)_3(\text{OH})_3\text{OH}$, is a sodium- and magnesium-rich tourmaline typically encountered in brown, yellow, black, and rarely as intense green. Uvite, $\text{Ca}(\text{Mg}_3)\text{MgAl}_5(\text{Si}_6\text{O}_{18})(\text{BO}_3)_3(\text{OH})_3(\text{F}/\text{OH})$, is a calcium- and magnesium-rich tourmaline that is often brown, green, or deep red. Our analysis suggests that this blue tourmaline specimen is composed of a mixture of dravite and uvite. While fibrous blue dravite has been reported in the Czech Republic (M. Novak, "Blue dravite as an indicator of fluid composition during subsolidus replacement processes in Lipoor granitic pegmatites in the Moldanubicum, Czech Republic," *Journal of the Czech Geological Society*, Vol. 43, No. 1-2, 1998, pp. 24-30), this is the first large single-crystal blue dravite-uvite tourmaline the authors have encountered.

Ian Nicastro
San Diego, California
Ziyin Sun
GIA, Carlsbad

Sapphire rush near Ambatondrazaka, Madagascar. In October 2016, a sapphire rush of an estimated 45,000 miners occurred at Bemainty, about 35 km east of Ambatondrazaka, Madagascar. Author VP was informed of the rush by Marc Noverraz, a Swiss gem merchant based in Ilakaka, Madagascar. According to Mr. Noverraz, some large, highly saturated blue sapphires were found at the rainforest site in late September. This attracted people from all over the island, as well as traders (mainly from Sri Lanka) who settled in Ambatondrazaka to buy gems.

Author RP gained access to the site from October 23 to 26. When she arrived, miners were working along either side of a river. The mining area was slightly more than 2.5 km long. The miners were digging for gem-rich gravels near the river or in the forest while washing took place in the nearby stream. The sapphires produced were mainly blue, varying from light to deep blue (figure 3). Many of the blue specimens were very slightly green; most were milky and would benefit from heat treatment. Particolored stones with pink/blue/colorless color zoning and pinkish orange sapphires (like those discovered at Mandraka near Toamasina in 2011) were also found.

This new rush area (figure 4) was clearly a secondary deposit. Miners had dug pits up to two meters deep in order to collect potentially gem-rich gravels for washing in the

Figure 3. A rough blue sapphire at the rush site at Bemainty, near Ambatondrazaka, Madagascar. Photo by Rosey Perkins.





Figure 4. Thousands of independent Malagasy miners work the sapphire deposit in the rainforest east of Ambatondrazaka in October 2016. Photo by Rosey Perkins.

stream using hand sieves. Life at the mining site was very basic, with some people living in huts but most in makeshift tents under a plastic roof. There was no sanitation, and clean water was not available. While some police were present to keep the peace, it is now believed they took greater control of the area, and the number of active miners seems to have decreased.

Author RP accessed the site from Ansevabe, a one-hour journey from Ambatondrazaka by motorbike, though many people were reaching the area by tractor, bicycle, or on foot (an 11-hour walk from Ansevabe). On her return to Ansevabe, RP estimated a thousand people traveling toward the mine. In Ambatondrazaka, she saw blue stones from the rush weighing up to 75 ct. Fine, clean blue stones over 100 ct and some attractive pinkish orange stones over 50 ct were also reported.

As rubies and sapphires have been discovered fairly regularly in this region since 2000, a new sapphire find was not a huge surprise. The region is part of the Ankeniheny-Zahamena-Mandadia Biodiversity Conservation Corridor and Restoration Project, which consists of Ankeniheny, Zahamena, and Mantadia National Parks. The rush site is therefore a protected area. Several sources in Madagascar have reported that by early November the authorities had started to control the foreign buyers, though stones continue to emerge from the mine.

Rosey Perkins
London
Vincent Pardieu
GIA, Bangkok

Trapiche-type sapphire from Tasmania. Trapiche and trapiche-type minerals are treasured for their beauty and unique patterns. The six-rayed spoke patterns occur in different minerals but are best known in emeralds. During a

GIA field expedition to the Australian island of Tasmania, author VP was able to mine several sapphires (figure 5), including a black star, some small blue samples, and a 2.73 ct blue sapphire that showed a fixed six-ray pattern. Trapiche-type stones are found in almost all basalt-related sapphire fields, but they are considered exceptionally rare in Tasmania (B. Sweeney, "Interesting gems from north-east Tasmania," *Australian Gemmologist*, Vol. 19, No. 6, 1996, pp. 264–267).

The trapiche-patterned stone had a dark blue bodycolor and was translucent to opaque. Many inclusions were visible, as were iron-stained fractures and clouds of particles. Hexagonal growth and color zones could also be seen. The core of the sample appeared colorless. The trapiche pattern was expressed as a hexagonal core with six radiating arms

Figure 5. Production from one day of mining in Tasmania. The trapiche-type sapphire in the center weighs 2.73 ct. Photo by Vincent Pardieu/GIA.





Figure 6. The polished section of the trapiche-type sample, as seen with fiber-optic illumination. The central white core and the six whitish particle-rich arms separated by blue areas are clearly visible. Photo by Victoria Raynaud.

(figure 6). These white reflective features stood out against the blue bodycolor. The stone weighed 2.54 ct after we opened a polished window, and it measured approximately $6.93 \times 8.20 \times 3.00$ mm after fabrication.

The relationship of the trapiche arms to the color zoning is important for correctly identifying a sample as “trapiche” or “trapiche-type.” In this case, it was obvious that the rays were perpendicular to the hexagonal color and growth zoning, and that the intersections were not located at the corners of the hexagonal pattern.

According to the recent literature, this pattern would not qualify as true trapiche, as seen in Muzo emeralds or some Mong Hsu rubies (G. Giuliani and I. Pignatelli, “Trapiche’ vs ‘Trapiche-like’ textures in minerals,” *InColor*, Vol. 31, 2016, pp. 45–46). True trapiche minerals have equivalent, crystallographic sectors divided by heavily included zones, a pattern expressed as arms intersecting the growth patterns at the junctions (figure 7, left). In the Tasmanian sapphire, the included zones were perpendicular to the growth zones and did not divide the gem into crystallographic sectors (see figure 7, right). Thus, it was a “trapiche-like” mineral.

The sample’s chemical composition was analyzed with laser ablation–inductively coupled plasma–mass spectrometry (LA-ICP-MS) on five different areas. The trace-element composition was analyzed in the white core, two arms at mid-length, one arm close to the core, and a blue area between the arms (again, see figure 6).

For most elements (Mg, V, Fe, Zr, Nb, and Ta), an increase in concentration is observed from the less included blue areas to the most included area, which was the core. Ti showed a different pattern, with higher concentrations

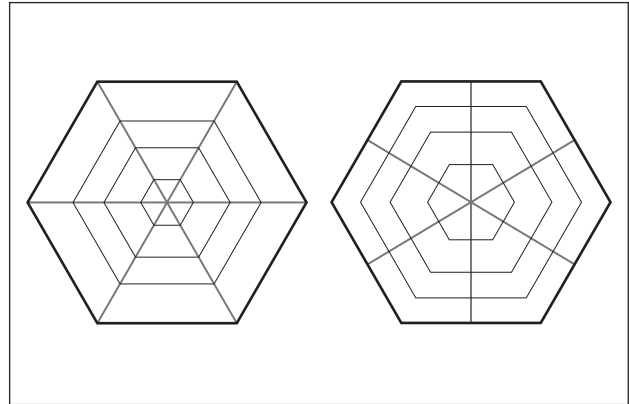

Figure 7. Trapiche (left) vs. trapiche-type (right) patterns in corundum.

in the arms and lower concentrations in the blue areas; concentrations were even lower in the core. Ga remained constant throughout the stone but was slightly elevated in the core. Be showed a similar pattern but was more variable outside the core.

The higher concentration of certain elements (V, Zr, Nb, and Ta) was most likely due to the presence of micro-inclusions. Ti was extremely low in the core, where there was no blue color; higher Ti concentrations in the other areas explained the blue color. The variation within the arms and the blue area may be explained by growth + color zoning, although the influence of Ti-rich particles should not be excluded. The Fe concentrations were probably caused by a combination of increased particle density and internal growth variations. It is notable, but not unexpected, that this natural trapiche-type sapphire contained some Be, albeit in very low quantities (V. Pardieu, “Blue sapphires and beryllium: An unfinished world quest,” *InColor*, Vol. 23, 2013, pp. 36–43). The Be concentration was highest in the core, where the particle density was highest and the blue color was absent.

While trapiche-type sapphires are not particularly rare, it is unusual to find them in Tasmania. This sample has additional scientific value because it was mined by a field gemologist during a field expedition, giving it an extremely reliable origin.

Wim Verriest, Supharart Sangsawong,
and Vincent Pardieu
GIA, Bangkok

SYNTHETICS AND IMITATIONS

Two glass samples: Natural or man-made? During a March 2014 visit to Chanthaburi, Thailand, author VP was shown two faceted green samples (figure 8) that were reportedly moldavite, a natural glass formed from meteorite impact.



Figure 8. Face-up (top) and face-down (bottom) views of the imitation moldavite examined in this study. The sample on the left weighs 3.80 ct (9.48 × 9.30 × 6.93 mm); the specimen on the right is 3.76 ct (10.76 × 8.11 × 6.02 mm). Testing identified them as “soda-lime” glass. Photos by Nuttapol Kitdee.

He had serious doubts about their natural origin, based on the material’s coloration and inclusions when viewed

through a loupe, but purchased them for further study.

Standard gemological properties included a single RI reading of 1.520 and an SG value of 2.51 for both samples (moldavite has an SG of 2.32–2.38). Under the polariscope, the material exhibited an isotropic reaction with anomalous double refraction (ADR). The samples were inert under long-wave UV radiation but displayed a weak chalky yellowish green reaction under short-wave UV. Examination with a gemological microscope revealed numerous individual and clustered rounded gas bubbles of various sizes, mostly smaller, and flow structures (figure 9). FTIR spectra showed absorption peaks at approximately 2850 and 3520 cm^{-1} , features commonly found in man-made glass, whereas moldavite usually exhibits broad bands at approximately 3609 cm^{-1} (T.T. Sun et al., “Moldavite: Natural or imitation?” *The Australian Gemologist*, Vol. 23, No. 2, 2007, pp. 76–78).

We used laser ablation–inductively coupled plasma–mass spectrometry (LA-ICP-MS) for comparison with known samples, including “soda-lime” man-made glass, natural volcanic glass from Japan, and Vietnamese tektites. This analysis revealed that the two faceted samples shared very similar chemical compositions with the Na_2O - and CaO-rich man-made references examined, while the natural glass from Japan and tektite from Vietnam were noticeably richer in Al_2O_3 and possessed a much lower Na_2O and CaO content (figure 10).

Standard and advanced testing techniques showed that the material from Chanthaburi closely matched common “soda-lime” man-made glass. The higher SG corresponded to man-made glass. FTIR spectroscopy and chemical com-

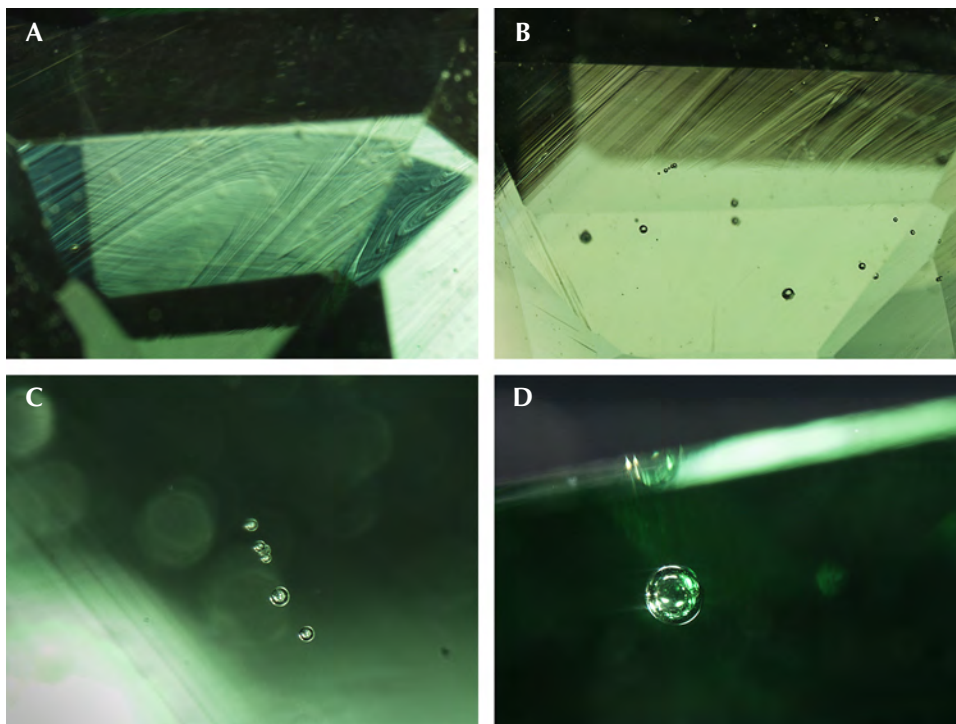

Figure 9. Magnification revealed flow marks (swirls) and rounded gas bubbles of various sizes. A: The characteristic flow structure usually observed in glass in brightfield illumination; field of view 5.20 mm. B: Flow marks and individual round gas bubbles in brightfield illumination with diffused lighting; field of view 6.30 mm. C: Round clustered gas bubbles in brightfield illumination; field of view 1.10 mm. D: A larger individual gas bubble in brightfield illumination; field of view 5.20 mm. Photomicrographs by Supharart Sangsawong.

LA-ICP-MS ANALYSIS

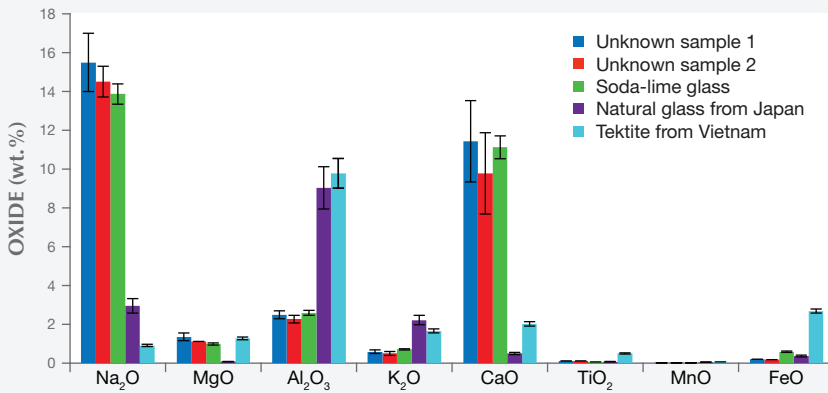

Figure 10. LA-ICP-MS results of the two glass samples are compared against those of known soda-lime glass, natural glass from Japan, and tektite from Vietnam. The black bars at the top of each column correspond to standard deviation (SD) obtained from three analyses.

position indicated that the samples were not moldavite. The study also demonstrates how these analytical techniques can be applied in separating glasses from different origins. High Na₂O and CaO content may be a useful aid for identifying “soda-lime” man-made glass in the future.

*Supharat Sangsawong and Vincent Pardieu
GIA, Bangkok*

Imitation rubellite boulders. Recently, RAG Gemological Laboratory in Turin received two “boulders,” weighing approximately 2.0 and 0.7 kg, reported to be rubellite tourmaline rough from Madagascar. The larger one was cut into two parts and found to be a resin imitation made heavier using a metal bar insert (figure 11). The smaller one was half of a boulder, again containing a metal insert. The resin matrix was colored bright cherry red and clearly noticeable in direct sunlight or using a small handheld light. The ex-

ternal appearance of both specimens was that of alluvial boulders that had floated and eroded over a period of time in riverbeds. The surface of each was rough with pits and fissures, and the voids were filled with material with an ochre appearance, very similar to clay and soils (figure 12). Due to the specimens’ mass, the authors could not use an immersion balance, so an approximate density was determined by weighing the two parts of the larger boulder and weighing the corresponding amount of water displaced by immersion. The density was about 2.9, close to the specific gravity of natural rubellites (3.0–3.2).

During an examination of a thick slab (about 1 cm) taken from the larger boulder using a circular saw with a diamond blade, different phases of preparation of the boulder imitation were observed. These stages were suggested by the presence of differently colored resin blobs around the metal bar, enveloped by the outermost portion of plastic material with

Figure 11. Left: The two sections of the larger “boulder” were glued together to show the original size and form of the 2 kg imitation tourmaline rough. The length of the boulder was approximately 16 cm. Right: The boulder was cut, revealing the metal bar insert. Photos by Emanuele Costa.

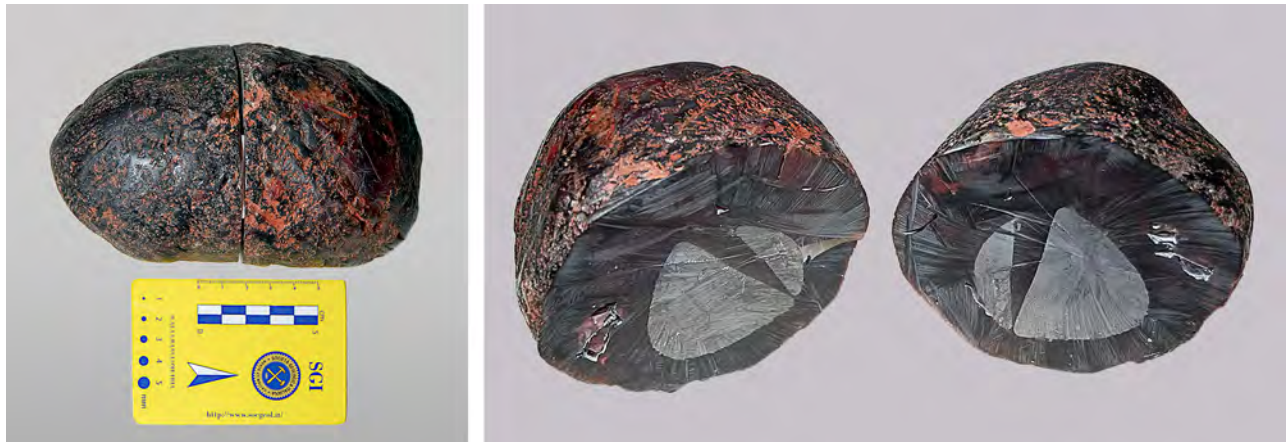

a more intense cherry red color (figure 13). The resulting product was probably scarred on the surface, tumbled, and finally immersed in a mix of mud and clay. Infrared (IR) spectroscopy investigation indicated the material was styrene-based resin, with a phthalate compound added for hardening. The resin was very similar to that used for fiberglass preparation, and it is easily found on the market. The metal insert, analyzed with EDS, was ordinary lead.

Many features easily distinguished these imitations from natural rubellites. The surface hardness was very low, and the resin used for the imitation partially melted at a relatively low temperature; therefore, a hot needle was enough to confirm the organic character of the mass. Acrid and pungent smoke was released when the hot needle made contact with the red-hot metal. Moreover, the plastic mass contained air bubbles (figure 14) that were easily seen from a smooth portion of the surface when using a loupe with intense illumination.

These tests are not easily managed in the field, however. The provenance of these boulders was most likely Madagas-

Figure 12. Details of the imitation boulder's surface, with pits, cavities, and fissures filled with a clay-like material. Photo by Emanuele Costa.



Figure 13. A transparency scan of an imitation boulder section; the black region is the metal insert. Color changes in different areas of the boulder suggest a multiple-step preparation involving various resin batches. The resins may have been worked in a semi-fluid or solid but malleable form, because some lack of adhesion—and the creation of voids—is noticeable. Photo by Emanuele Costa.

car, but no other reliable information was provided. Such boulders are rumored to have been mixed in with batches of natural rubellite boulders from alluvial deposits. Such imitations, especially if wet and muddy, could go unnoticed and increase the total weight of a rough stone batch.

*Emanuele Costa
Department of Earth Science, University of Turin, Italy*

*Raffaella Navone
RAG Gemological Laboratory, Turin, Italy*

Color-change glass as a Zultanite imitation. Diaspore, a relatively common mineral with the chemical formula $AlO(OH)$, is found in metamorphic bauxite deposits (A.A. Calagari and A. Abedini, "Geochemical investigations on Permo-Triassic bauxite horizon at Kanisheeteh, east of



Figure 14. Air bubbles are randomly scattered in various portions of the resin matrix. Photo by Emanuele Costa.

Bukan, West-Azarbaidjan, Iran," *Journal of Geochemical Exploration*, Vol. 94, No. 1, 2007, pp. 1–18), and usually appears as a mineral inclusion in sapphire, ruby, and spinel (V. Pardieu, "Hunting for 'Jedi' spinel," Spring 2014 *G&G*,

pp. 46–57; Spring 2016 GNI, pp. 98–100; Summer 2016 GNI, pp. 209–211). However, gem-quality transparent diasporite is rare and appears to be unique to the Ilbir Mountains area in southwest Turkey (M. Hatipoglu et al., "Gem-quality transparent diasporite (zultanite) in bauxite deposits of the Ilbir Mountains, Menderes Massif, SW Turkey," *Mineralium Deposita*, Vol. 45, No. 2, 2010, pp. 201–205). Zultanite is the trade name of diasporite that exhibits a color-change effect; the material appears yellow, pink, or green in different light sources. Zultanite has only been found in the Anatolian Mountains of Turkey (M. Hatipoglu and M. Akgun, "Zultanite, or colour-change diasporite from the Milas (Mugla) region, Turkey," *Australian Gemmologist*, Vol. 23, 2009, pp. 558–562).

The Geological Institute of China University of Geosciences in Beijing recently received two samples, an unmounted 8.44 ct 10×12 mm faceted pear-shaped specimen and a ring with an 8×10 mm faceted oval, that displayed a color-change effect. The material was reportedly purchased from Turkey as Zultanite, a designation the client wished to confirm. Both samples were yellowish green in fluorescent light with a color temperature of 5500 K (figure 15, left) and brownish yellow in incandescent light (figure 15, right). The specimens were fairly clean, with no obvious inclusions and no obvious scratches on the surface. Facet junctions were generally smooth, with small chips. A series of absorption lines related to rare earth elements (REE) were observed by a handheld prism spectroscope. These properties, along with electron microprobe analysis, indicated that the two samples were not diasporite or any other natural material, but rather man-made glass. The infrared spectrum of the unmounted specimen, with peaks at 1037 , 462 , 443 , and 430 cm^{-1} , confirmed the material was glass.

LA-ICP-MS data of three points on the loose sample are reported in table 1. The main trace elements were Nd (102,792 average ppmw) and Pr (68,500 average ppmw), both rare earth elements. Other REE included Gd (1473 average ppmw) and Ce (135 average ppmw). Nd and Pr are the

Figure 15. These glass imitations of Zultanite are shown in fluorescent (left) and incandescent light (right). The color-change effect is apparent when switching between the two illumination types. Photos by Xiaoyan Yu.



TABLE 1. LA-ICP-MS data of glass sample (ppmw).

| Element | TG1-01 | TG1-02 | TG1-03 |
|-----------|-------------------|-------------------|-------------------|
| Ti | 65.55 | 64.02 | 64.13 |
| V | 0.618 | 0.614 | 0.621 |
| Cr | 0.740 | 0.832 | 0.818 |
| Mn | 0.882 | 0.861 | 0.756 |
| Fe | 50.68 | 49.78 | 51.31 |
| Co | 0.0462 | 0.0444 | 0.0444 |
| Ni | 0.2291 | 0.2124 | 0.2062 |
| Cu | 13.14 | 12.80 | 13.02 |
| Se | <0.75 | <0.75 | <0.71 |
| Rb | 3.63 | 3.51 | 3.50 |
| Sr | 68.23 | 66.01 | 66.26 |
| Y | 2.381 | 2.29 | 2.319 |
| Cs | 0.028 | 0.0273 | 0.028 |
| La | 4.78 | 4.55 | 4.56 |
| Ce | 139.42 | 133.47 | 134.65 |
| Pr | 69,791.21 | 67,327.64 | 68,381.69 |
| Nd | 104,391.56 | 100,985.23 | 103,001.10 |
| Sm | 0.307 | 0.311 | 0.301 |
| Eu | 0.372 | 0.356 | 0.353 |
| Gd | 1482.77 | 1452.45 | 1480.22 |
| Tb | 24.41 | 23.51 | 23.85 |
| Dy | 8.42 | 7.98 | 7.92 |
| Ho | 0.658 | 0.617 | 0.611 |
| Er | 31.30 | 30.25 | 31.00 |
| Tm | bdl | bdl | bdl |
| Yb | 0.2224 | 0.1979 | 0.2197 |
| Lu | bdl | bdl | bdl |

Rare earth elements are displayed in bold text. bdl = below detection limit.

chromophores that cause color change in material such as synthetic cubic zirconia (Fall 2015 GNI, pp. 340–341).

The visible-range absorption spectrum of the loose material (figure 16) showed a typical spectrum of glass with rare earth elements. This spectrum showed bands at 443, 479, 529, and 587 nm. The bands at 443, 479, and 529 nm indicate the presence of Pr³⁺, which caused the green or yellowish green color. The brownish yellow color is related to the 587 nm absorption peak, which is induced by Nd³⁺.

Xiaoyan Yu (yuxy@cugb.edu.cn), Bijun Guo, Xue Jiang, and Weirui Kang
China University of Geosciences, Beijing

TREATMENTS

“Decorated” jadeite jade in the Chinese market. Jadeite jade has long been popular in China, where it has profound

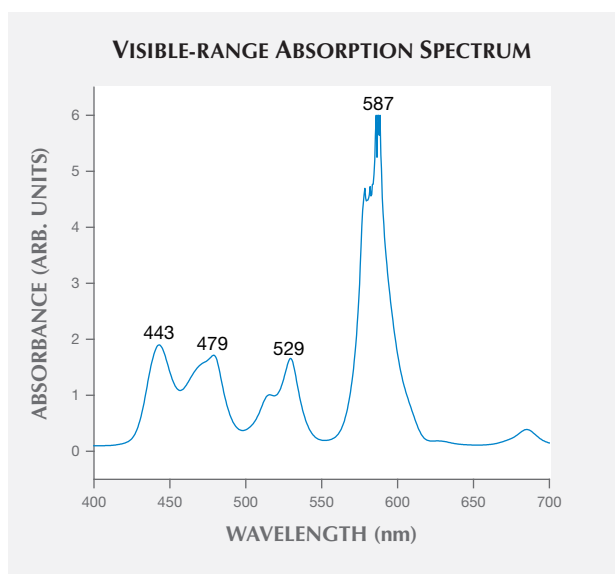

Figure 16. The visible absorption spectrum of the unmounted pear-shaped sample shows four absorption bands at 443, 479, 529, and 587 nm. The peak at 587 nm is associated with Nd³⁺, while the bands at 443, 479, and 529 nm are attributed to Pr³⁺.

cultural connotations. Fine-quality jadeite has the highest market value, especially the colorful and near-transparent pieces. Bright color zoning on a piece of jadeite will enhance its value; therefore, color-enhanced jadeite is available in the market. Filling and dyeing have been used for decades to modify jadeite’s color, but these methods can damage the texture of jadeite and reduce its value. A new method, cementing small colored jadeite attachments on the surface of jadeite ornaments, recently appeared in the Chinese jade market. Because the method does little or no damage to the main jadeite’s texture, we consider this an assembled stone.

Figure 17 shows three jadeite pendants decorated with small green and brown jadeite plates. These pendants were submitted to the Gem Testing Center of China University of Geosciences (Wuhan) for identification of species and treatment. They were tested by observation under microscope and ultraviolet lamp, infrared (IR) spectroscopy, and ultraviolet/visible (UV-Vis) absorption spectroscopy.

The background color and texture quality of the small plate attachments was similar to those of the main jadeite body, creating a harmonious overall appearance (again, see figure 17). The green color appeared to be floating on the surface and seemed to be detached from the base (figure 18, left), whereas the natural color zone of jadeite always changes gradually. Resin with accompanying bubbles was found in the space between the green attachments and the jadeite body (figure 18, right). Under the long-wave UV lamp, the resin in the contact region emitted strong blue-white fluorescence while the body did not fluoresce (figure 19).



Figure 17. A light-colored off-white jadeite pendant decorated with small green and brown jadeite attachments. Photo by Fen Liu.

The IR reflection spectra of the green attachments showed typical jadeite features (figure 20, left). However, the IR transmission spectrum of the contact zone revealed peaks at 3058 and 3037 cm^{-1} , indicating the stretching vibration of the benzene ring in resin (figure 20, right), which was used to attach the decoration. The blue trace in figure 20 is typical for jadeite without any treatment.

Figure 18. Left: The green color on this jadeite appears to float on the surface and has a clear boundary. Field of view 5.50 mm. Right: Resin with bubbles fills the space in the contact area. Field of view 16.8 mm. Photomicrographs by Shufang Nie.

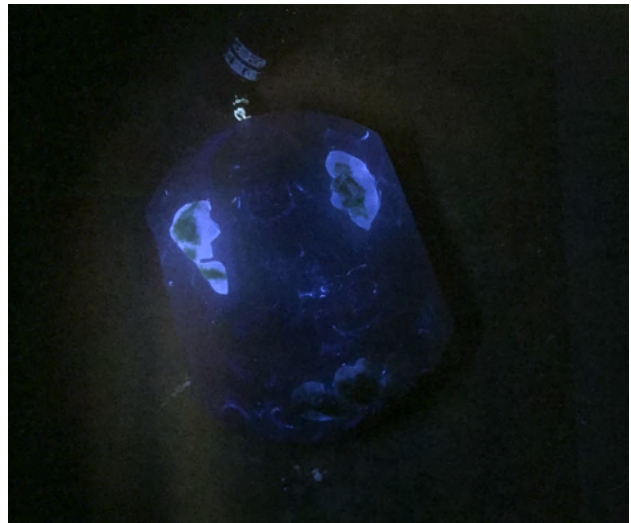
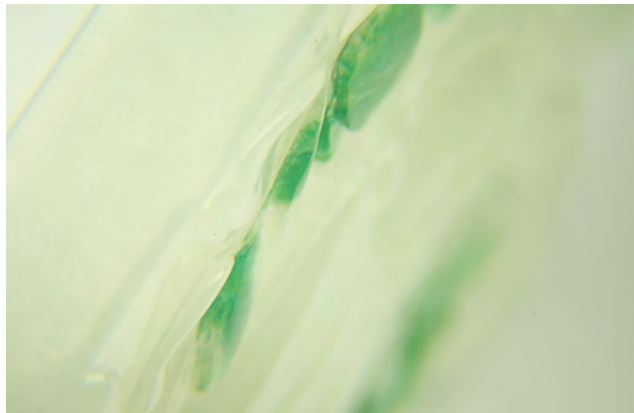

Figure 19. The resin in the contact region emits strong blue-white fluorescence under a long-wave ultraviolet lamp. Photo by Fen Liu.

The attachments all had a typical fibrous-granulous crystalloblastic texture without loosening or slagging. This implied they were natural jadeite that had not been subjected to acid washing or filling. The green color of the attachments was also natural, as shown by the UV-Vis absorption spectrum, which showed the 690 and 660 nm peaks induced by Cr^{3+} .

Yamei Wang, Shufang Nie, Fen Liu, and Andy Shen
Gem Testing Center, China University of Geosciences,
Wuhan

Durability of a broken glass-filled ruby. It is no secret that corundum is subjected to heating and fracture-filling treatments to alter its color and improve its clarity in order to increase the market value. Heat treatment in particular has

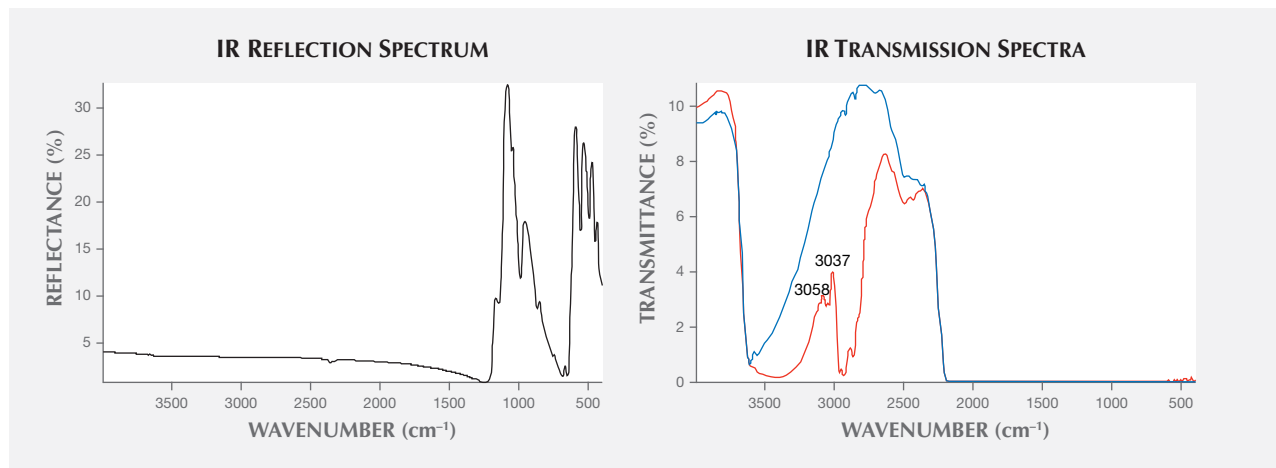

Figure 20. Left: The IR reflection spectrum of the jadeite decorations matches the typical spectrum for jadeite. Right: IR transmission spectra of the jadeite body (blue trace) and the green attachment zone (red trace). The blue trace is typical for natural jadeite without filling, while the 3058 and 3037 cm^{-1} peaks on the red trace are characteristic for resin, which was used to attach the colored jadeite plates.

become common practice and is generally accepted in the market, provided it is fully disclosed. The trade and end consumer are more concerned about the term “residue,” what it means, and how it affects the stone. Many heat-treated stones are easy to detect with magnification, and a recent case submitted to the Lai Tai-An Gem Laboratory involving a broken ruby revealed how heat treatment applied to rubies can influence durability.

The client claimed that the ruby in question (figure 21) was broken into two pieces by a goldsmith who only applied standard pressure on the claws when setting the stone in a piece of jewelry. The ease with which the stone broke under these normal conditions caused the jeweler to submit the piece for examination.

The original ruby measured $8.2 \times 5.7 \times 4.1$ mm and weighed 2.08 ct, while the two pieces weighed 1.10 ct and 0.98 ct after the damage. Identical RI readings of 1.762–1.770

were obtained and an SG of 4.00 was determined on each piece. Further observation under long-wave UV light revealed a weak red reaction, and FTIR and Raman spectra were indicative of ruby. The stone’s natural origin was proved when extensive twinning, white acicular inclusions, and parting planes were observed through a gemological microscope. Some white flaky glass residues (figure 22) were also seen on broken surfaces, and numerous tiny gas bubbles were observed within some fractures. Flattened filler was also visible within the partially healed fractures (figure 23). When analyzed with a Micro-XRF M4 Tornado Bruker spectrometer, the filling material showed significant silica content.

DiamondView observations revealed that the residue within some fractures was more opaque (figure 24), confirming the existence of glass filler. While the application of heat treatment together with glass filler usually improves a ruby’s clarity, some fractures may not heal completely.

Figure 21. Left: The two pieces of a glass-filled ruby were combined to demonstrate its appearance before breaking. Center and right: The two pieces that broke during the setting process. Photos by Lai Tai-An Gem Lab.

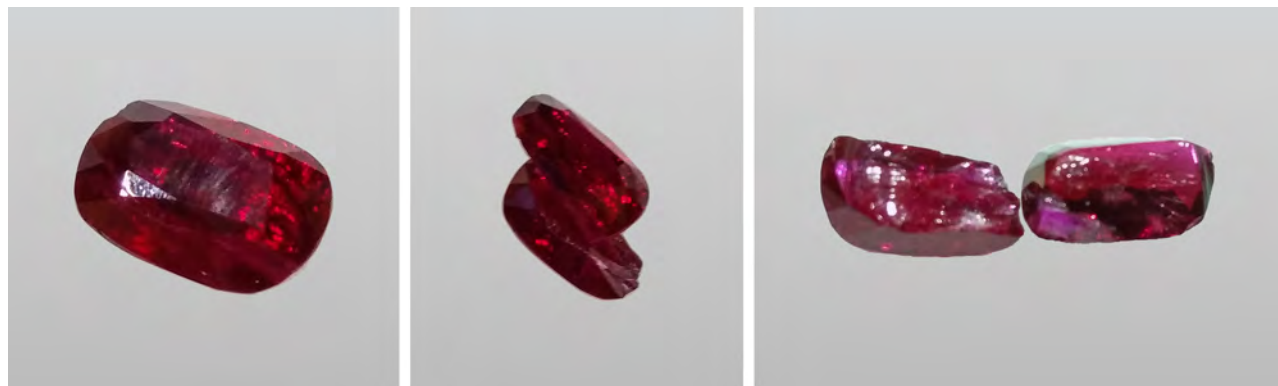

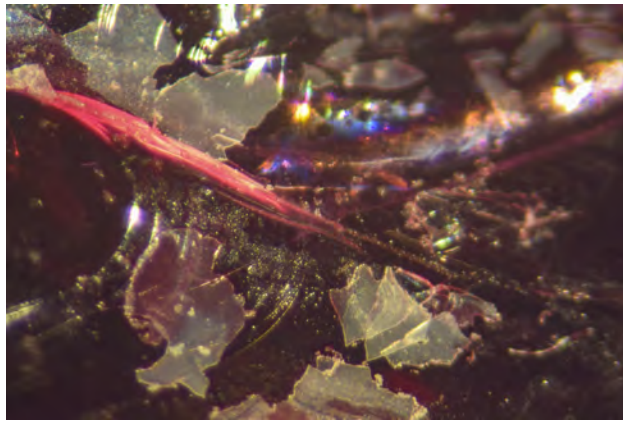

Figure 22. Visible white flaky “residue” seen on broken surfaces of the ruby. Photo by Lai Tai-An Gem Lab; field of view 4.25 mm.

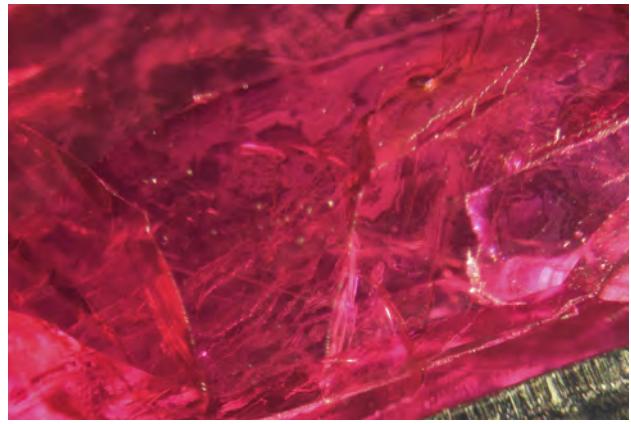

Figure 23. Areas of whitish filler were noted within some surface-reaching fractures. Photo by Lai Tai-An Gem Lab; field of view 4.8 mm.

Since the starting material is often of low quality, the industry and consumers should be alert to the potential risk of damaging stones during the mounting process. Careful inspection of any stone prior to setting is recommended.

Larry Tai-An Lai (service@laitaian.com.tw)
Lai Tai-An Gem Laboratory, Taipei

CONFERENCE REPORT

Fabergé Symposium. “The Wonder of Fabergé: A Study of The McFerrin Collection” was the title of the Fabergé Symposium held at the Houston Museum of Natural Sciences (HMNS) November 3–4. Comprised of over 600 objects (figure 25), the collection of Artie and Dorothy McFerrin is the largest privately owned assortment of Fabergé objects and Russian decorative art in the United

States. (Worldwide, only the Fabergé Museum in St. Petersburg and Queen Elizabeth II have larger collections.) It has now been the focus of two Fabergé symposiums, the first in 2013. Photos from the McFerrin Collection were incorporated into all of the talks.

Researcher **Dr. Ulla Tillander-Godenhielm** (Helsinki) presented “Fabergé in the Light of 20th Century European Jewelry,” which covered the years 1881–1915. In 1881, Carl Fabergé took over the family business from his father Gustav and, along with his younger brother Agathon, began building their brand. The Fabergé brothers opened shops in other cities and became court jewelers to Russia’s imperial family, but 1915 marked the end of the successful enterprise. The outbreak of World War I in 1914 increased the cost of materials and sent many goldsmiths off to the front lines. In 1917, along with the end of the 300-year reign of

Figure 24. These images show the appearance of the white silica glass filler residue on some fracture surfaces under normal lighting conditions (visible light, left) and as opaque dark areas against the bright red ruby reaction in the DiamondView (right). Photos by Lai Tai-An Gem Lab.

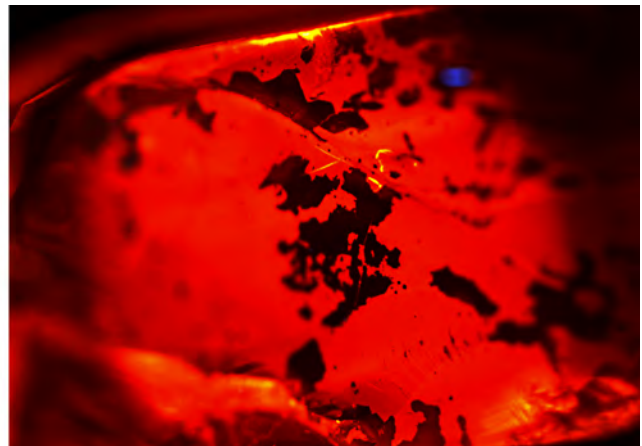
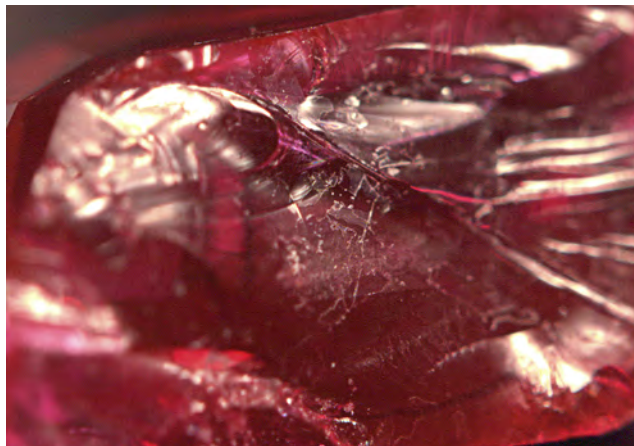



Figure 25. Fabergé's Kelch Rocaille Egg (1902), featuring green translucent enamel, diamonds, and yellow gold rocaille ornament, is part of the McFerrin Foundation Collection. Photo by Hank Gillette/CC BY-SA 4.0.

the Romanovs, the House of Fabergé was closed. Many of Fabergé's workmen and their families emigrated to Finland to work for the A. Tillander firm in Helsinki. The speaker came to know these individuals as a young girl.

Dr. Galina Korneva (Russia) spoke on "Imperial Gifts Created by Fabergé for the Coronation of Nicholas II: New Archival Research." Dr. Korneva and her sister Tatiana Cheboksarova have discovered and reviewed thousands of handwritten archival documents. The coronation of Nicholas II was celebrated May 6–26, 1896. Fabergé gifts from Nicholas II included a yellow and white diamond brooch in the shape of a rose given to his wife, Empress Alexandra Feodorovna; a brooch and the Lilies of the Valley basket for his mother, Dowager Empress Maria Feodorovna; 18 brooches in the shape of crowns for the Grand Duchesses; pectoral crosses for the clergy; plate and salt cellars; and bracelets, brooches, pins, snuffboxes, and cigarette cases for members of the imperial court and other dignitaries. Fabergé marked the occasion a year later with the Imperial Coronation Egg, which now resides in the Fabergé Museum.

Art historians **Timothy Adams** (San Diego, California) and **Christel Ludewig McCannless** (*Fabergé Research Newsletter*, Huntsville, Alabama) discussed "Fabergé Smoking Accessories: Materials and Techniques of a New Art Form." With the popularity of smoking in the first half of the 19th century and the demand for smoking accessories, the Fabergé firm had a production line for these items. In one studio, ten men made nothing but cigarette cases. These items were large, with a tinder cord and a vesta compartment that held matches, which were very expensive. The cigarette case became more streamlined with the invention of the cigarette lighter in the late 1800s, making the bulky tinder cord and vesta compartment unnecessary.

Researcher **Mark Moehrke** (New York City) lectured on "Fabergé Silver-Mounted Art Glass." These objects are both functional and decorative. Neo-classical in style, most of them are colorless cut glass, but they were also made from hardstones, metals, and ceramics with applied silver bases, handles, and stoppers. Included in the discussion were three objects from the McFerrin Collection: a Louis Comfort Tiffany favrile glass vase with Fabergé silver base, made by workmaster Victor Aarne; a Louis Comfort Tiffany favrile glass scent bottle with silver stopper, handles set with natural pearls, and a silver base; and a rectangular Löt glass lamp with silver mounts, including a base of stylized dolphins and scrolls to imitate ocean waves, also by Victor Aarne.

In "Collector Tales," **Artie and Dorothy McFerrin** (Houston) described how they started accumulating Russian decorative arts. Their first purchase turned out to be an imposter egg, or "Fauxbergé," which is on display in the museum. They also discussed their favorite pieces and took questions from the attendees.

Dr. Wilfried Zeisler (Hillwood Estate, Museum & Gardens, Washington, D.C.) presented "From Canvas to Silver: Enameled and Repoussé 'Paintings' in Russian Jewelry at the Turn of the 20th Century." Dr. Zeisler used examples from both the Marjorie Merriweather Post and McFerrin collections to illustrate how paintings were reinterpreted as art objects. The subject of a painting would find its way onto small boxes, caskets, and cigarette cases by way of engraving, enameling, or lithograph. Feodor Rückert, an enamel master from Moscow, supplied such items to Fabergé from 1886 to 1917.

Mikhail Ovchinnikov (Fabergé Museum, St. Petersburg) discussed "Fabergé's Renaissance Style Objects in the Context of 19th Century European Revival Jewelry." Fabergé was inspired by the pieces exhibited at the museums he visited on his grand tour of Europe. Objects made using the *pietra dura* method influenced his hardstone figures. Fabergé also worked in the Hermitage examining and repairing ancient jewelry, which would influence his later designs.

Rose Tozer
GIA, Carlsbad

ERRATA

- In the Fall 2016 Magaña and Shigley article on CVD-grown synthetic diamonds, the caption for figure 5 (p. 227) described the 5.19 ct brilliant examined in September 2016 as a round brilliant. The correct shape is cushion modified brilliant.
- In the Fall 2016 Lab Notes entry on the treated pink type IIa diamond colored by red luminescence (pp. 299–301), the figure 5 caption misidentified the red and blue traces in the UV-Vis-NIR absorption spectra. The red trace actually represents the 4.29 ct natural diamond; the blue trace represents the 0.48 ct treated CVD synthetic used for comparison.