

RESOURCES

JEFF DAVIS COUNTY LIBRARY
T 86921

GEMSTONES AND THE ENVIRONMENT

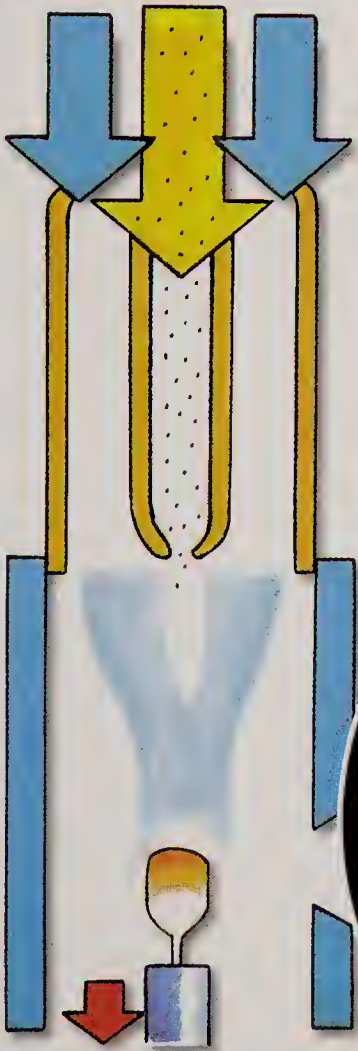

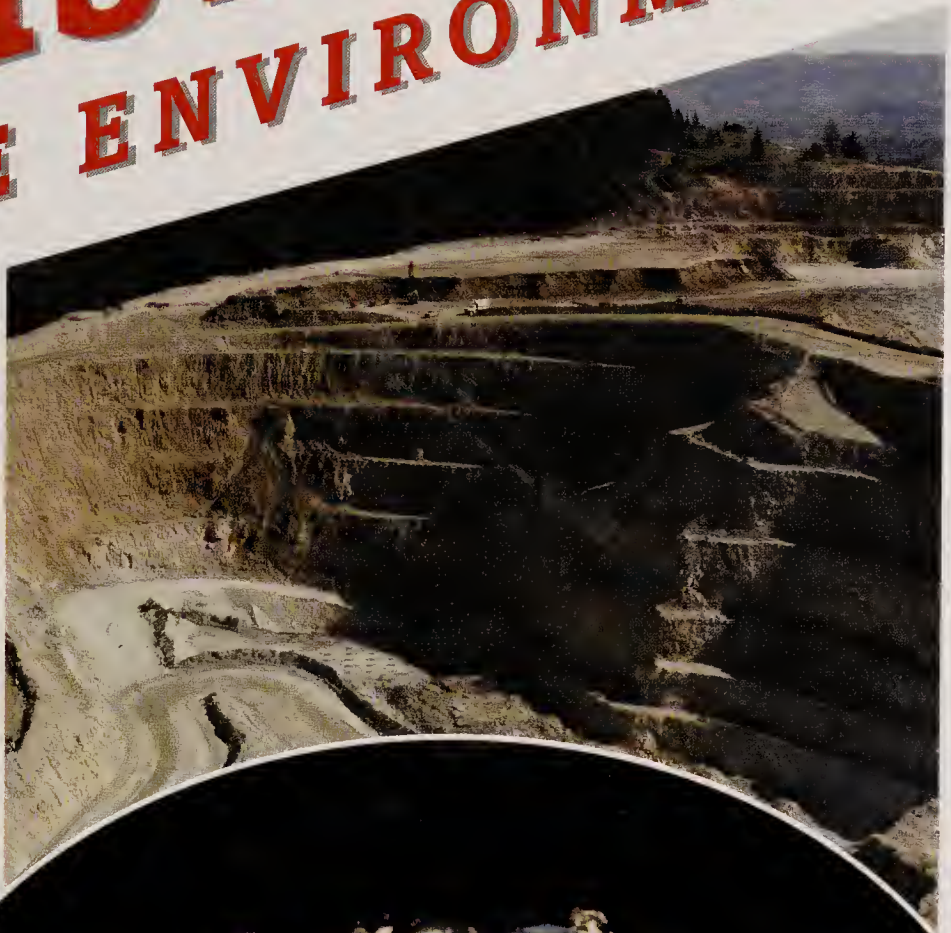
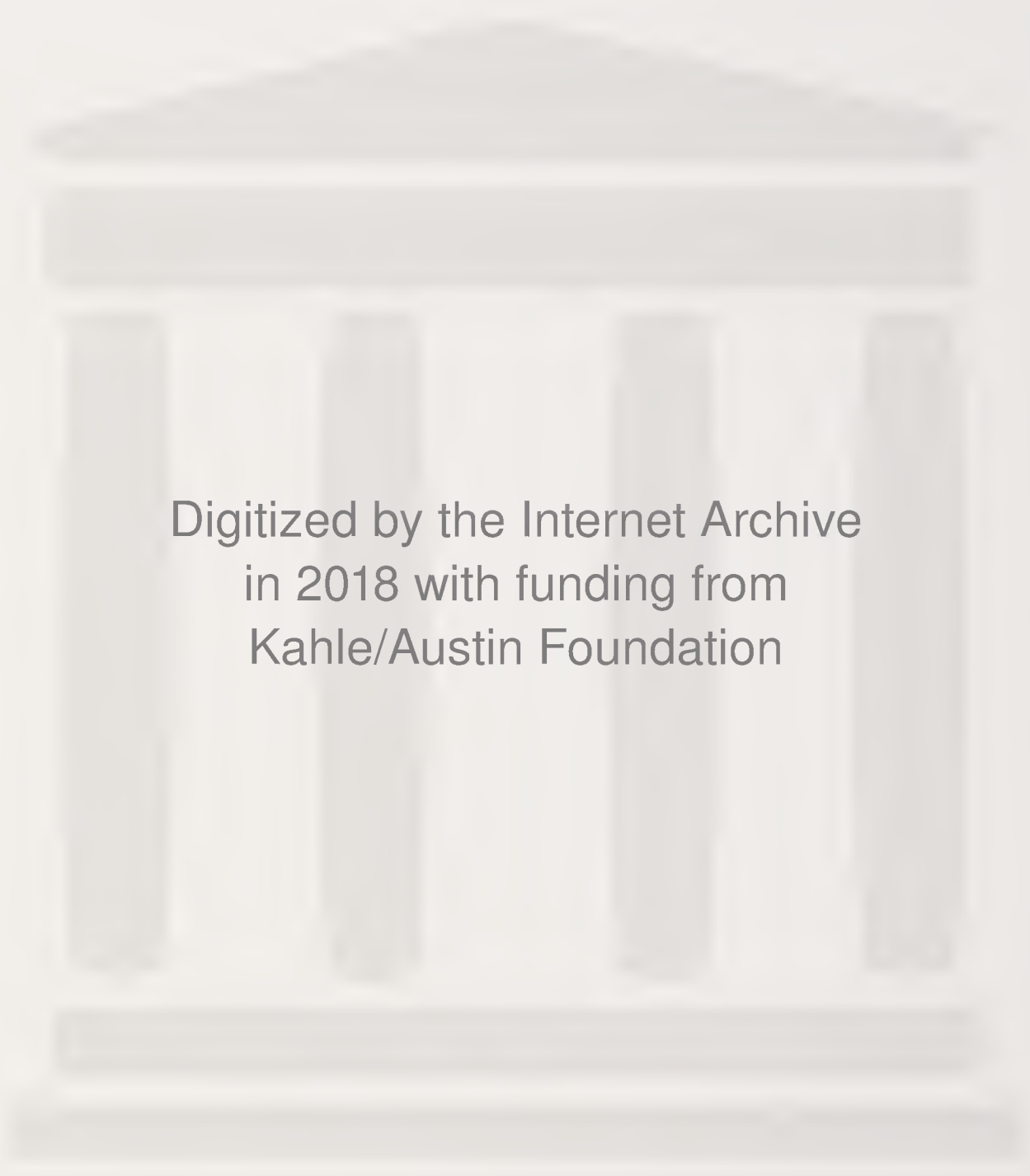

Digitized by the Internet Archive
in 2018 with funding from
Kahle/Austin Foundation

<https://archive.org/details/gemstonesenviron0000merc>

Jeff Davis County Library

GEMSTONES AND THE ENVIRONMENT



IAN MERCER

Stargazer Books

1-5-10ep

© Aladdin Books Ltd 2005

Printed in UAE

Library of Congress Cataloging-in-Publication Data

New edition published in the
United States in 2005 by:
Stargazer Books
c/o The Creative Company
123 South Broad Street
P.O. Box 227
Mankato, Minnesota 56002

All rights reserved

Editor: Harriet Brown

Designer: Simon Morse

Illustrator: Louise Nevett

Picture Researcher:
Brian Hunter Smart

Mercer, Ian, 1944-
Gemstones and the environment /
by Ian Mercer ; [illustrator, Louise Nevett].—New ed.
p. cm.— (Resources)
Includes index.
ISBN 1-932799-38-9 (alk. paper)
1. Precious stones—Juvenile literature.
2. Precious stones, Artificial—Juvenile literature.
[1. Precious stones.] I. Nevett, Louise, ill. II Title.
III. Resources (North Mankato, Minn.)

QE392.2.M48 2004
553.8—dc22

2003070753

Photocredits Abbreviations: l-left, r-right, b-bottom, t-top, c-center, m-middle.

Cover main, cover mb, 2-3, 4tl, 4tr, 4b, 5t, 6tl, 8tl, 11tl, 11tr, 12tl, 12tr, 14tl, 14tr, 16tl, 18tl, 18tr, 20tl, 22tl, 22tr, 24tl, 26tl, 26br, 27bl, 28t, 28tr, 29t, 30t, 31t, 32t — Corel. cover mt, 8tr, 26-27, 26tr, 26ml, 27tl — Photodisc. 1, 7t, 15b — Geological Museum. 6tr, 27mr — Digital Stock. 9t, 11b, 13t, 14b — De Beers. 9b, 17 — Alan Jobbins. 16tr — Brian Hunter Smart. 19, 23 both, 25 — Science Photo Library. 20b — Select Pictures. 20tr — Ingram Publishing. 21 both — Shell. 24tr — Stockbyte.



CONTENTS

What are gemstones?	4
Gems from the earth	6
Mining for gems	8
Sorting diamonds	11
Shaping diamonds	12
Shaping gems	14
Artificial gems	16
Is it real?	18
Diamonds in industry	20
Precision instruments	22
Gems in space and medicine	24
The environment	26
Weight and hardness	28
Gem deposits	30
Glossary	31
Index	32

WHAT ARE GEMSTONES?

Gemstones are made from rare crystals that have been cut up and polished. They are usually hard and clear, or colorful. Gemstones are extremely valuable because of their beauty and rarity. When we think of gemstones we usually imagine a jewelry store window, or a beautiful ring or necklace.

Hard or clear crystals are not only used to make jewelry, they are also used in factories, spacecraft, and lasers.





Natural gemstones are found in the earth.

Crystals in the earth's rocks are called minerals. Gems made from these minerals are called natural gemstones. Artificial gemstones are made from glass and from crystals made in laboratories and factories. Gems of all kinds are often made to imitate more valuable gemstones.

In this book you will discover how hard crystals are formed, processed, and used in industry and in jewelry.

GEMS FROM THE EARTH

The earth's rocks are moving, squashing, and often melting together. It is in this turmoil that gems are formed. The rocks are a mixture of minerals that are themselves made up of chemical elements. Atoms of chemical elements, such as carbon, oxygen, and silicon, combine to make tiny building blocks. These fit together in neat regular patterns to form "crystals."

The type and size of that crystal depends on the chemical elements present, their temperature, and the pressure exerted on them. Natural gems are found as clear or colored crystals embedded in rock. They are also found as big crystals lining cracks or cavities in the earth's surface layer, or "crust." Some gems are washed along by rivers and may then be picked out.

How gems are formed

Some gem crystals, like garnet, grow in solid rock as it squashes beneath moving mountains (1). Others, such as tourmaline, are formed in veins beneath the earth's surface (2).

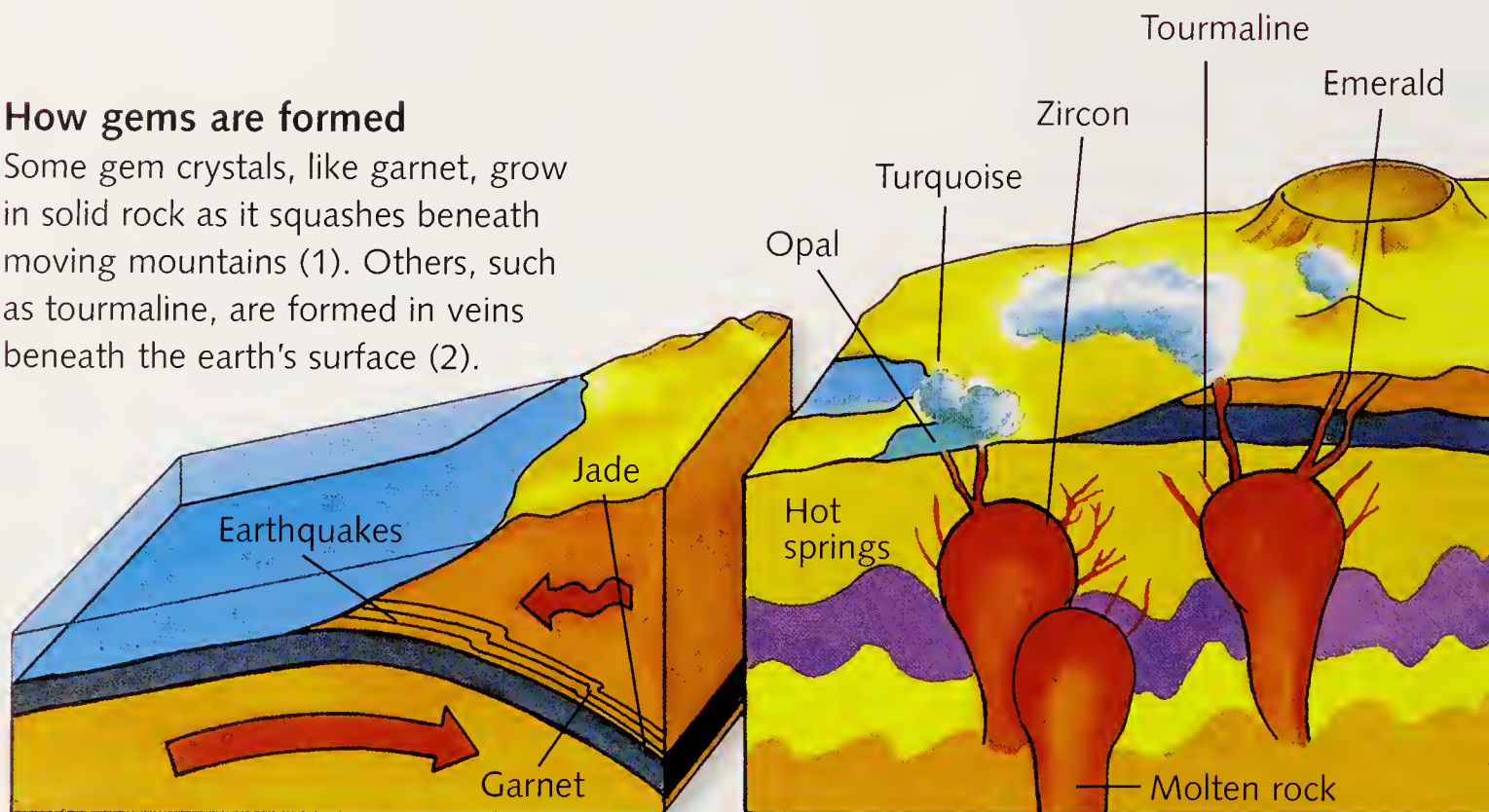



An emerald crystal as it appears in rock

Stones such as agate grow in volcanic rocks at the surface (3). Gems like ruby grow deep down where molten rock "cooks" the earth's crust. Diamond crystals grow way down, about 100 miles beneath the surface (4).

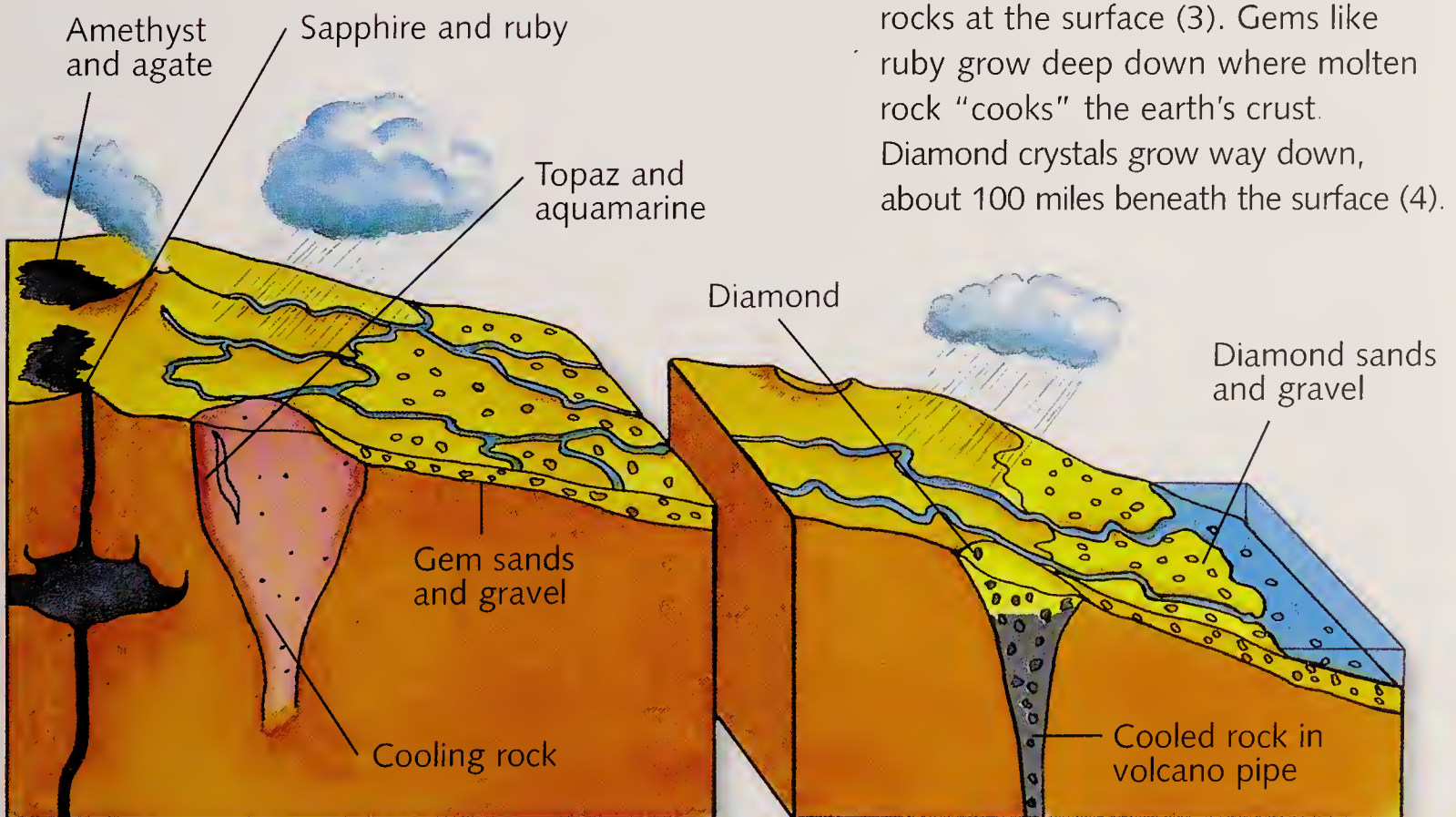

MINING FOR GEMS

Most diamonds are found in huge, deep mines. The mines are often in the underground “pipes” of extinct volcanoes. First, the top rocks are removed to make a pit. Next, huge shafts are drilled beneath the pit to reach the diamonds. On the southwest coast of Africa, another type of diamond mining takes place. Here, diamonds lie buried in an ancient pebble beach now covered by huge sand dunes. Over 70 million tons of sand and pebbles have to be removed to extract half a ton of diamonds.



Gems like opal, topaz, and emerald usually come from very small tunnels or gravel pits close to the earth’s surface. The earth is scooped out of the pit, washed, and sieved, and any gems are hand-picked from the sieve.

Some mines are extremely deep. You can see one of the mining levels in this big diamond mine (1). Huge pits are cut out of the solid rock so that shattered rock falls through onto railroad cars running through a tunnel.

Australian opal miners actually live inside mines (2). It takes a lot of work to free the gems from very hard rock. People also search the rock waste dumps hoping to find opals the miners may have overlooked!

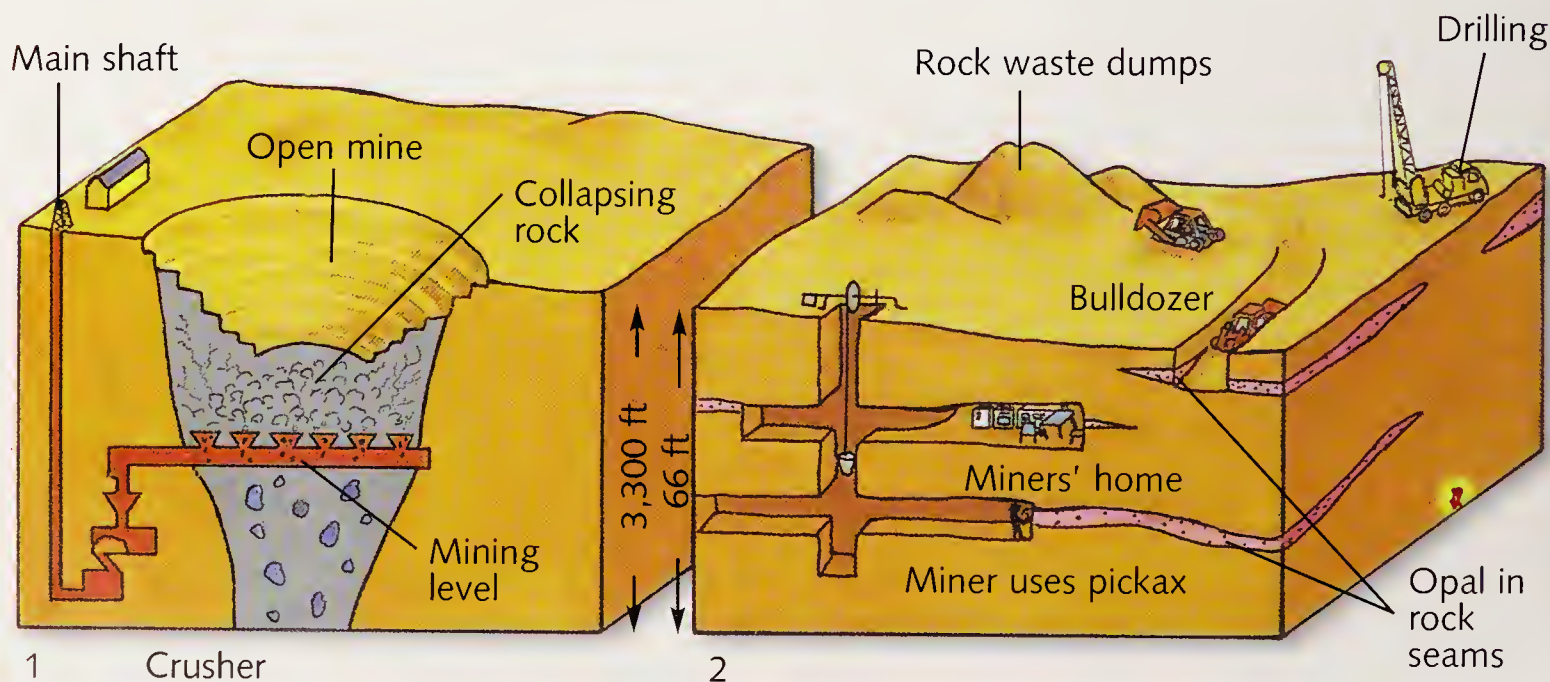

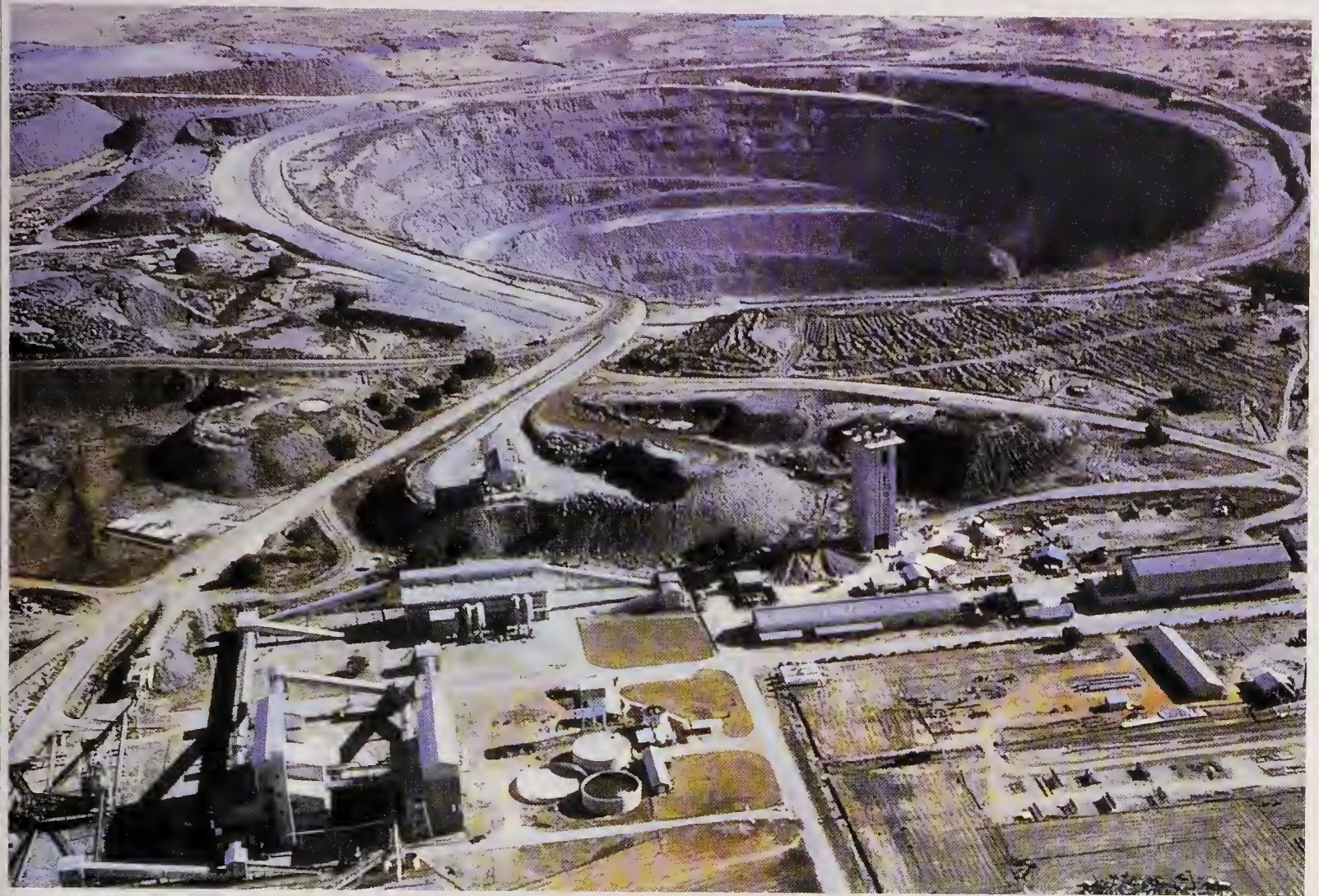

Mining for gems in a huge diamond mine, South Africa

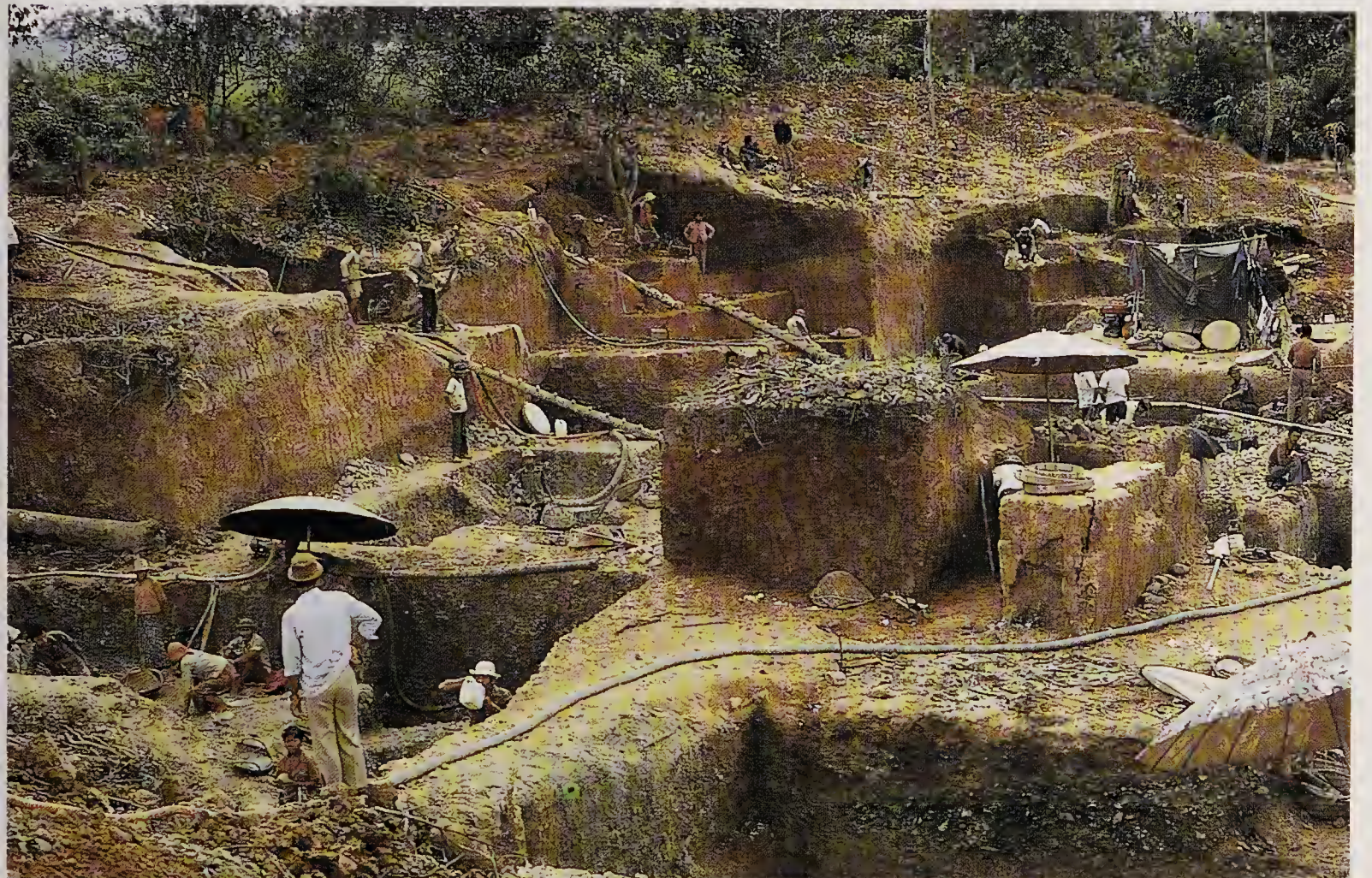

Working in an open gem mine in Kampuchea, Cambodia

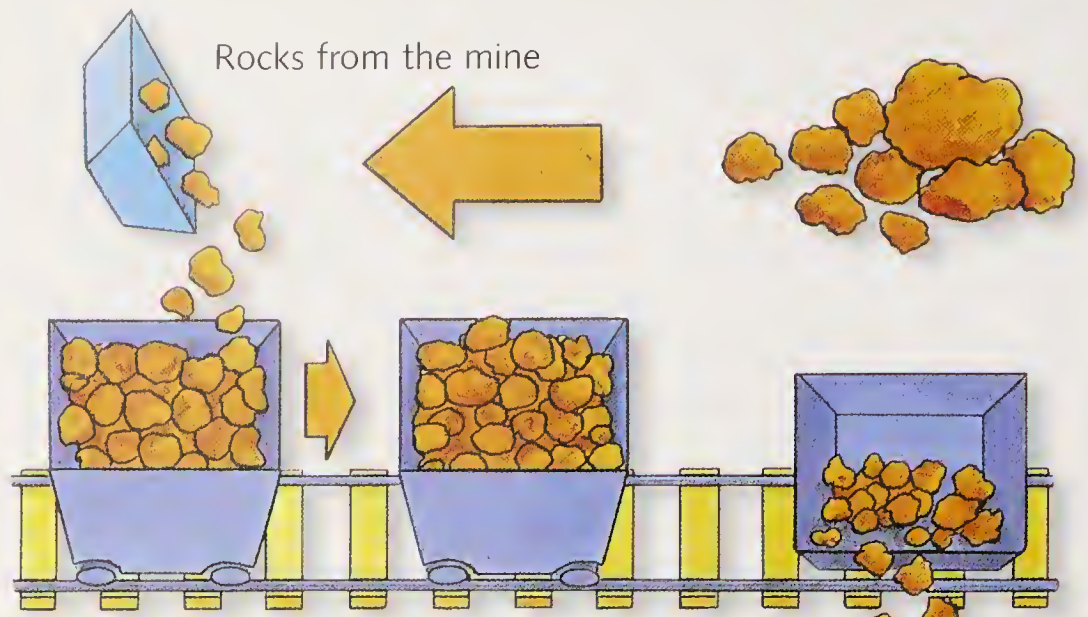

Trucks carry the rocks.

Rocks are crushed into smaller pieces.

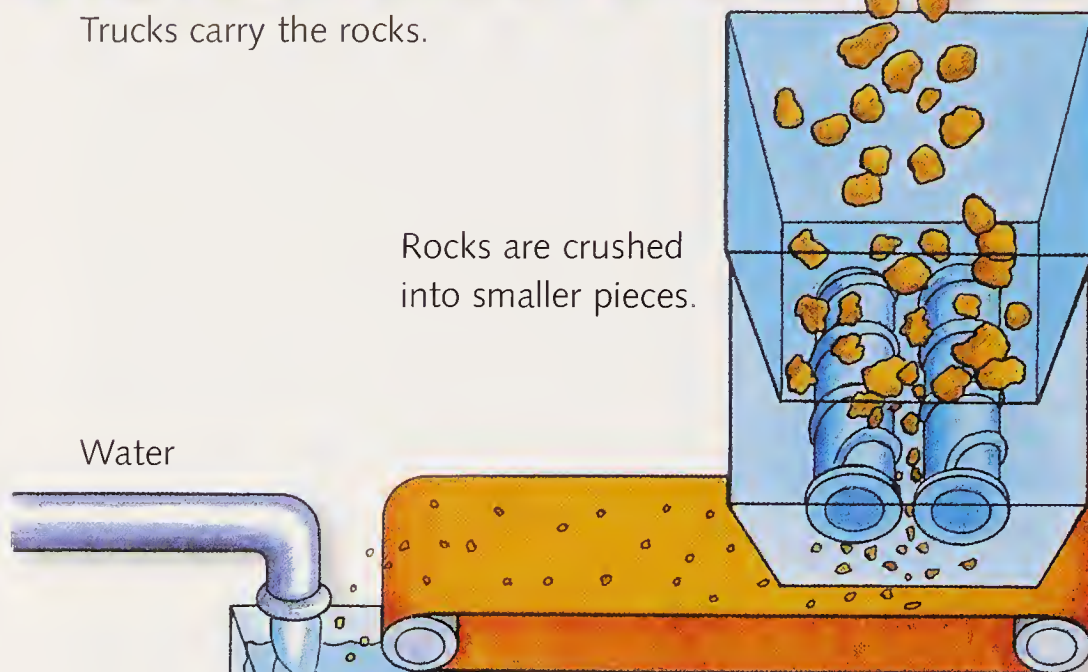

Conveyor belt

Small rocks are crushed.

Rotary worker to separate light and heavy minerals

Heavy minerals

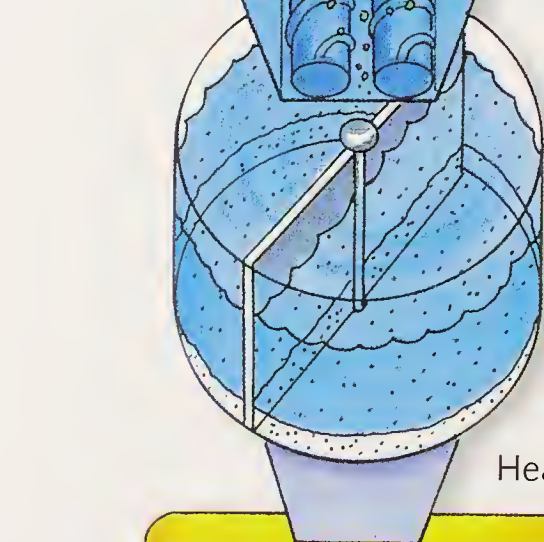

Water washes away all the minerals except diamonds.

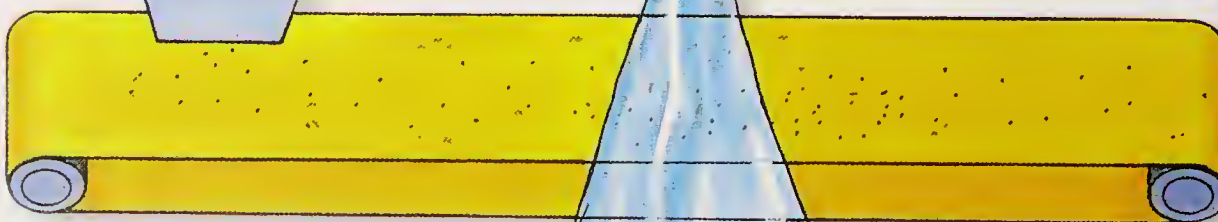

Greased belt

Diamonds stick to belt.

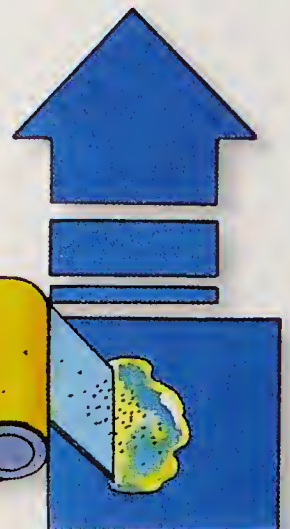

The grease is melted.

Separating diamonds

This diagram shows how diamonds are separated from the earth's rocks.

About one gram of diamond crystals is taken from an average of about 22 tons of rock—the same weight as five adult elephants. It is only because diamond has special properties that such a tiny amount can even be detected and removed.

Nearly all the diamonds that are recovered are less than 1 in across but even 0.2 in crystals are "caught" by the grease on the conveyor belt. Diamonds can also be spotted because they glow in X-rays.

Diamonds are cleaned and sent to the sorting room, then weighed and locked up.

SORTING DIAMONDS

Diamonds from the mine are sorted into two groups, industrial and gem quality. Many of the stones are full of bits of mineral, reducing their value and making them unsuitable for jewelry. Gem quality diamonds are sorted according to their weight, color, clarity, and shape. Every year over 20 tons of diamonds are mined, but only a small amount is of gem quality. The rest are industrial diamonds, and the demand for them is high.

Diamonds are probably one of the most abundant gems on Earth but they are hard to reach. The world's supply and prices of diamonds are very carefully controlled. This has resulted in a huge inflation in the price of diamonds.

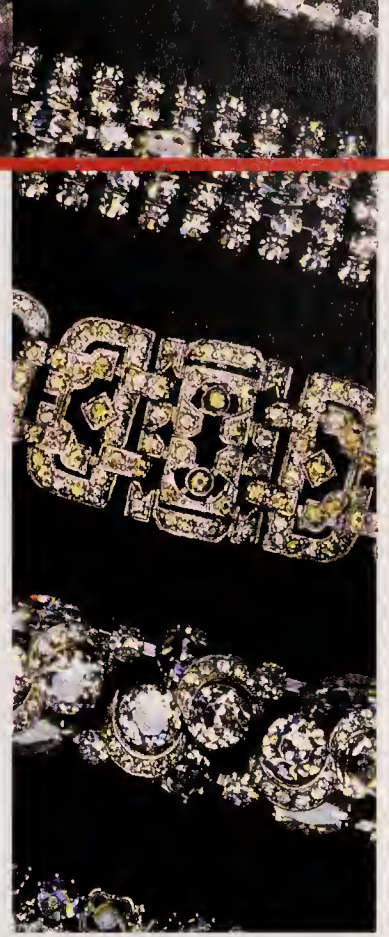

One week's production of diamonds from a large mine

SHAPING DIAMONDS

A diamond can be cut and shaped only by another diamond. This is because diamond is the hardest substance known to man. Each diamond crystal can only be cut in certain directions, along which it is a little less hard. Even so, it takes hours to cut through a diamond. Diamonds can also be split, or “cleaved,” along four different directions through the crystal.

Nearly all diamonds are “brilliant cut.” This means that the facets—faces of gems—are cut at just the correct angles to make the most of a diamond’s sparkle. Each facet acts like a polished mirror inside the gem—it reflects the light and splits it into the colors of the rainbow.

There are several different stages involved in shaping a diamond crystal into a cut gem. Firstly, the crystals are sent to special factories and sawed with thin bronze disks coated in diamond dust and olive oil (1). The designer decides where each crystal should be sawed.

Each diamond is then “bruted,” or shaped (2). The bruter shapes the gem by holding another diamond against it while it is spun around at great speed. After grinding and smoothing the top facet, or “table,” the cutter carefully decides where to grind the first of the 16 main facets.

When the main facets are polished to the right size (3), the “brillianteer” grinds the other 40 small facets. Over half of the original crystal has now been cut or ground away!

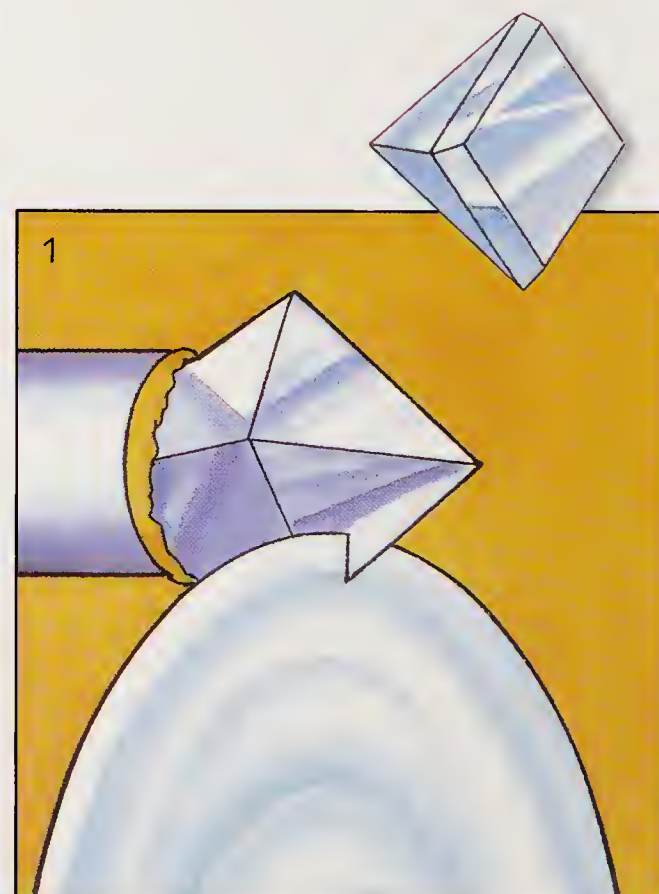

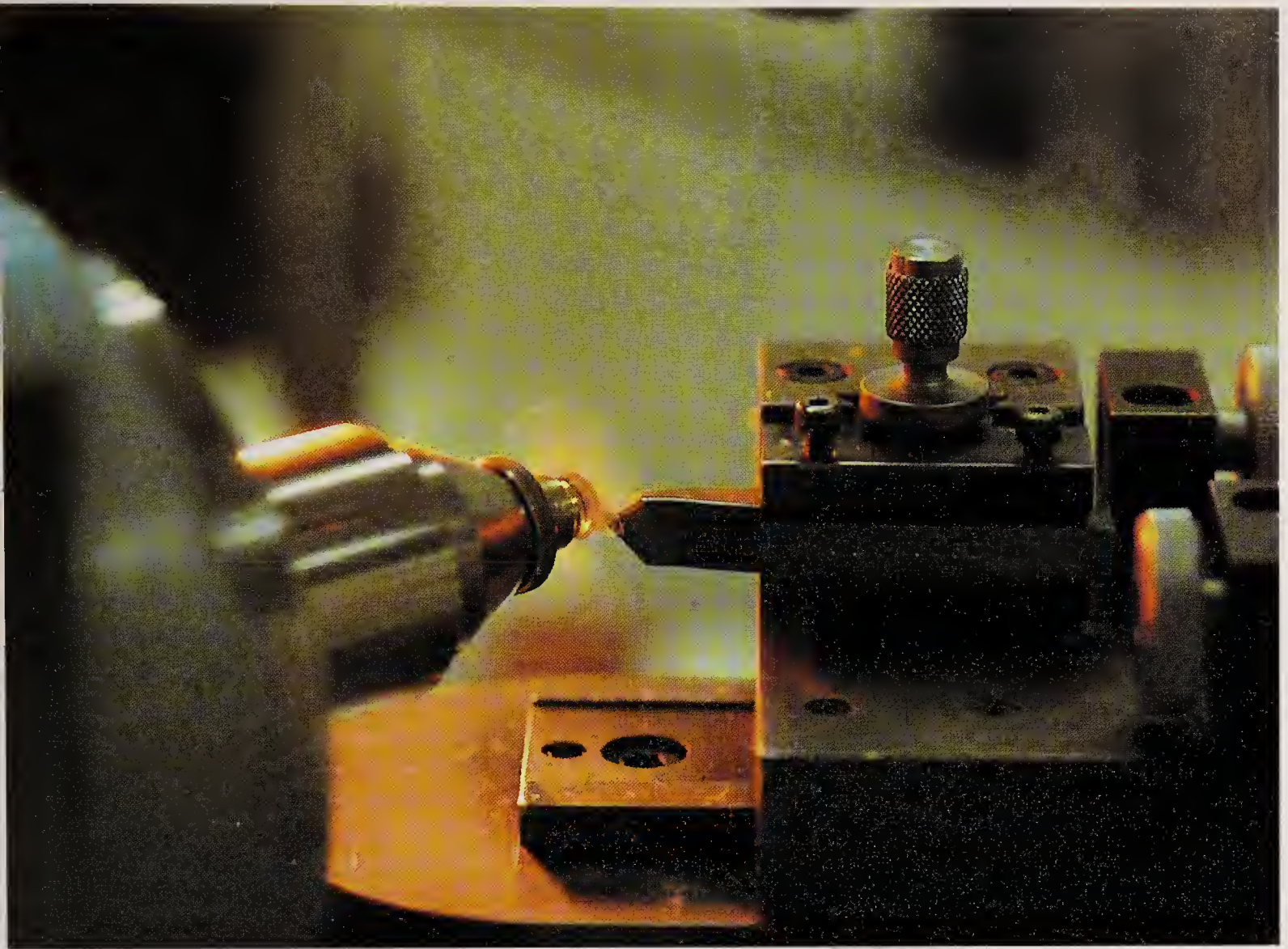

Bruting a diamond with another diamond

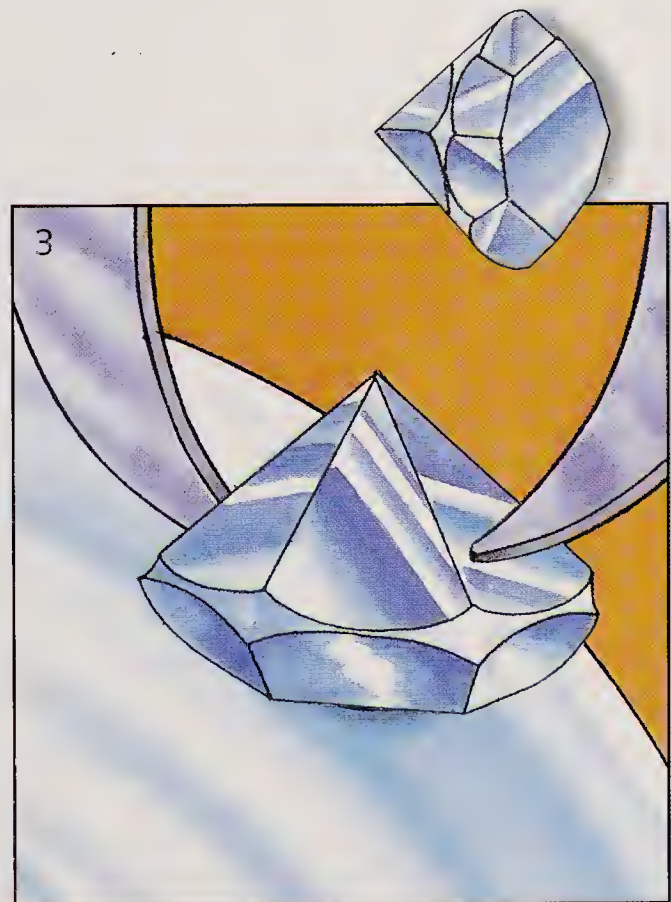
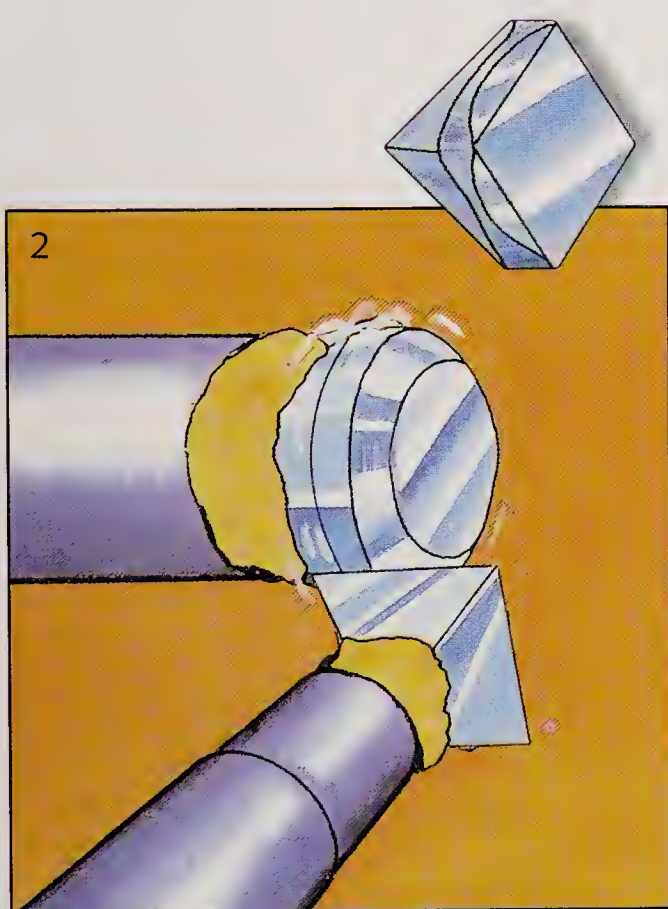

SHAPING GEMS

There are many ways of shaping, or “cutting,” a gemstone. A person who cuts gems is called a “lapidary.” The gems are cut to display their color, fire, sheen, or other beautiful optical effect. Gems are sliced with diamond saws and ground into flat facets or curved surfaces. They are then polished with diamond or ruby powder.

Many clear gems are cut with flat, mirrorlike facets. Their angles are carefully set to allow for the way that the light “bends” as it enters and leaves the gem. Each kind of gem has its own special set of facet angles: brilliant cut ruby has different angles from topaz, for example. A faceted gem will only twinkle or show its color well if it has been cut with correct facet angles.

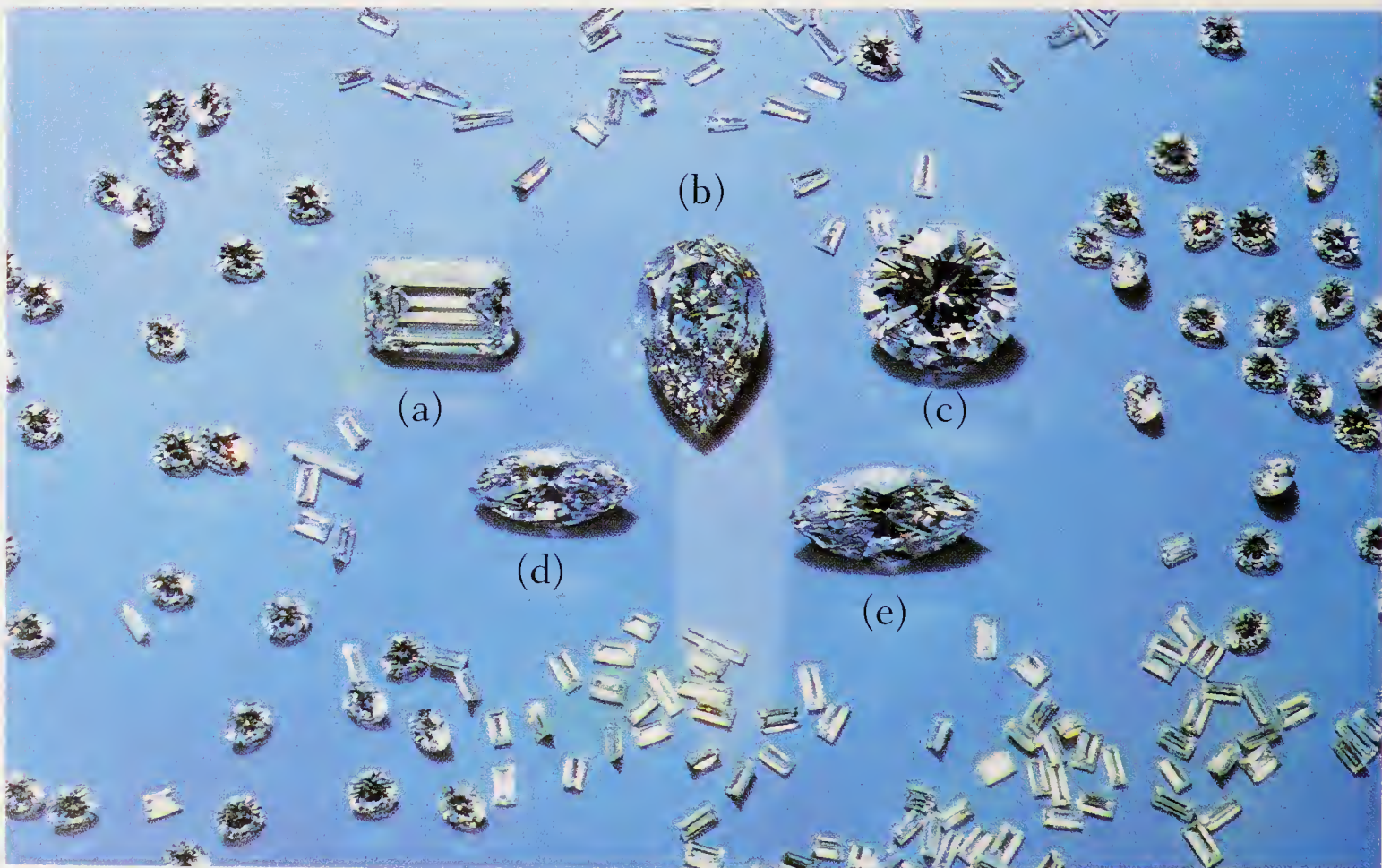

“Cabochons” are gems that have been cut in the shape of a dome. This type of cut shows off bright colors in opaque gems—gems that do not let light through. Cabochons are also made to reveal beautiful tricks of light, such as “stars” in certain rubies and sapphires, the sheen in moonstones, colors in opals, and the bright line that can be seen inside the rare, honey-colored “cat’s-eye” gems.

The “emerald cut” is oblong with the corners cut off. Long facets reflect lots of light back from deeply colored, transparent gems. Some gems are carved so that little scenes, symbols, or figure-heads stand out. These are called “cameos.”

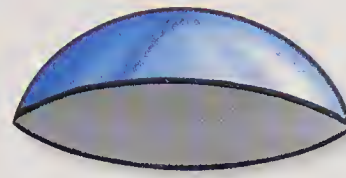

Simple cabochon

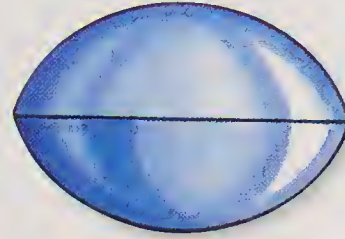

Double cabochon

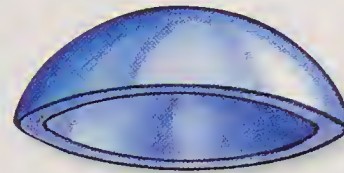

Hollow cabochon



Opals are often cut into cabochons to show off their colors.

ARTIFICIAL GEMS

We have seen how crystals are made up of atoms fitted together in regular patterns. These patterns can be made to change—with dramatic results! Black graphite is made of carbon atoms; diamond is also made from carbon atoms, but arranged in a different pattern. By applying huge amounts of pressure, the carbon atoms in black graphite can be squeezed together to make a more compact diamond pattern. This process is only used to make industrial quality diamonds. It's too expensive to make a diamond large enough to be set in a ring.

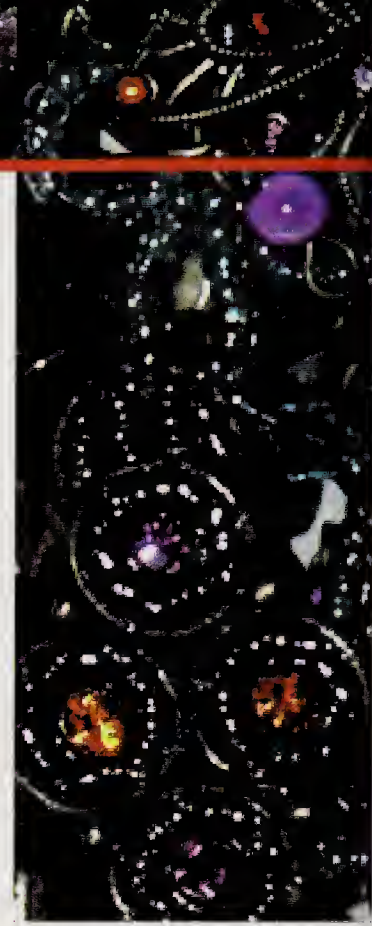

A hard, sparkling, artificial substance called cubic zirconia (CZ) is made into gems that look just like diamond. CZ gems are much cheaper than diamonds.

Ruby and sapphire furnace

Artificial crystals are made in furnaces like the one in the diagram. Rows of these furnaces make clear, sausage-shaped crystal rods of ruby or sapphire. These are cut in great numbers to make very inexpensive gems. Other kinds of furnaces are used to make perfect crystals that are used in lasers. CZ crystals are made in special furnaces at temperatures of more than 4,500°F.

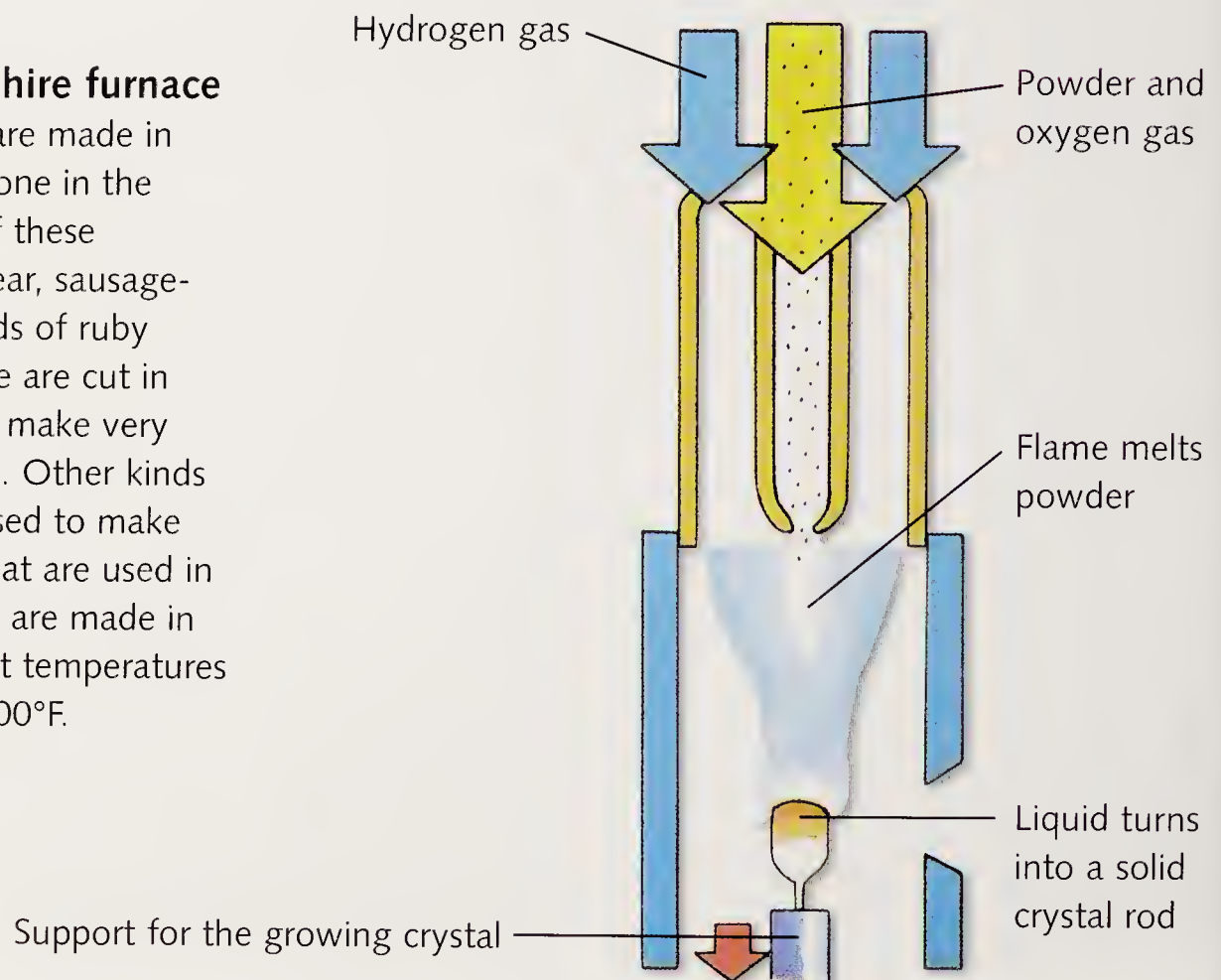



A selection of artificial gems—showing the crystal rod shapes from which they were cut.

IS IT REAL?

Some kinds of gems are made as imitations of more valuable gemstones. Natural gems that look similar but are cheaper are often used. For example, citrine looks like the more costly topaz. Sometimes, artificial gems are used.

“Gemologists” test gems and crystals to find out exactly what they are made of. They have to look closely inside the gem through a lens or a microscope. They also test the quality of light coming out of a gem and can tell whether the sapphire (right) is artificial or natural.

Gemstones can be sandwiched together with other substances to create “gems” that can be sold for more than they’re really worth. This method is also used to create cheaper jewelry. The diagram below shows ways in which this can be done.

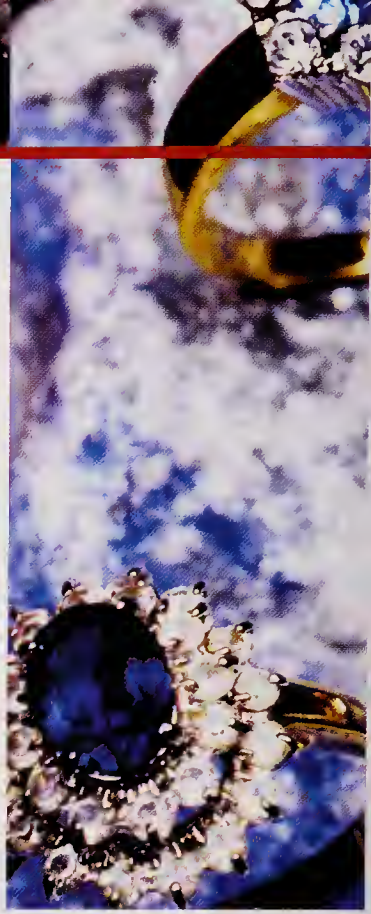

Five gemstone “tricks” to watch out for

(a) Doublet

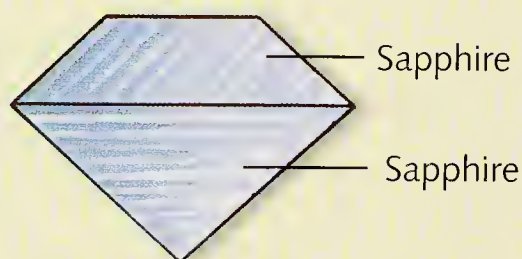

(b) Garnet-topped doublet

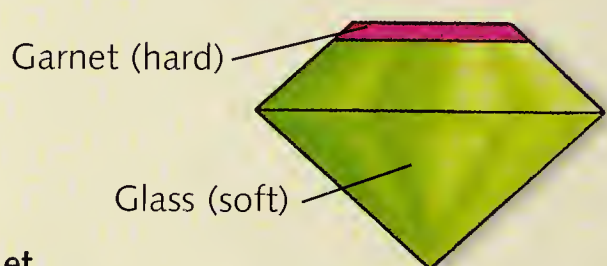

(c) Triplet

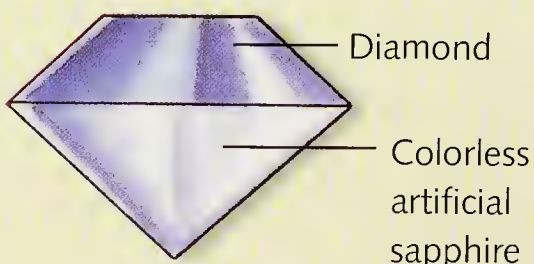
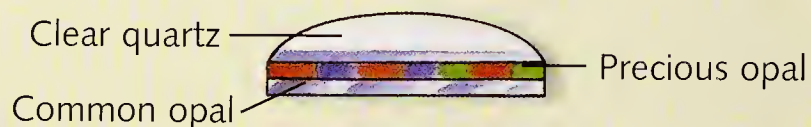

(d) Half-and-half doublet

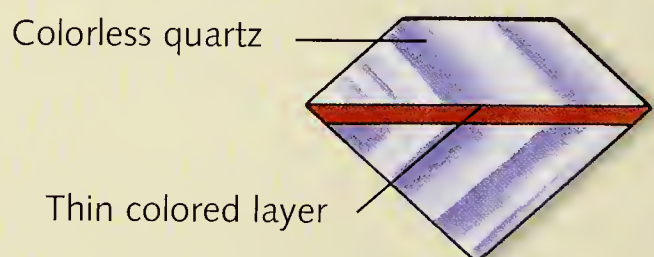

(e) Sandwich doublet



Light shining through the facets of a natural sapphire—magnified 50 times.

DIAMONDS IN INDUSTRY

Diamond is harder than any other substance. It can cut through anything and as a result, it has many uses in industry. Diamond powder is used for polishing lenses and gems, and for sawing tiny silicon wafers to make computer chips. Diamond is used in drills to make holes in stone and concrete. Whole “stones” are used for engraving glass, as teeth in large saws for slicing stone, and as drills powerful enough to cut holes in road surfaces. They are also set into the drills of oil and gas wells for exploring under the seabed.

In the future, diamonds may be used to make very small and powerful computers, radiation detectors, unwettable and unscratchable surfaces, and as light emitters in electronic displays.

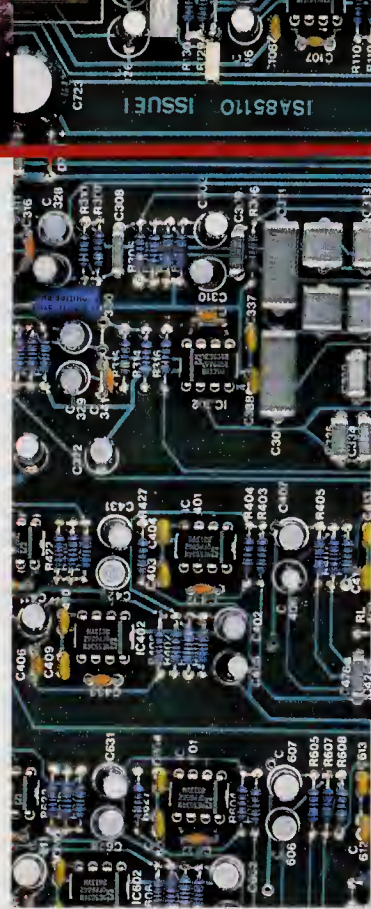

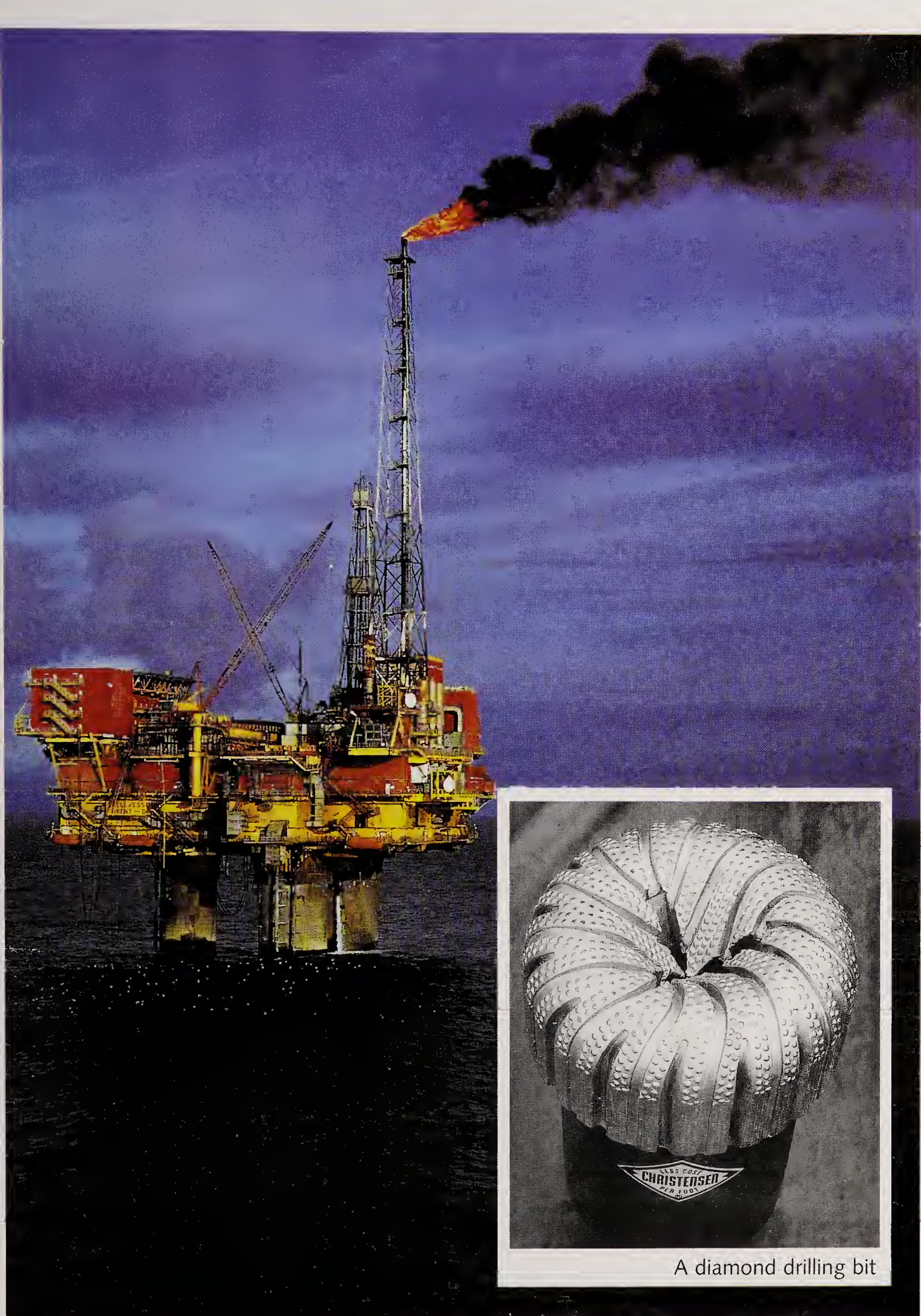

A diamond drilling bit

Oil rigs use diamond bits to drill beneath the seabed.

PRECISION INSTRUMENTS

Quartz is often used in precision instruments. Scientists discovered that when quartz crystals are placed in an electric field, they will vibrate. The precise way in which the quartz is cut affects the speed at which it vibrates. This exact vibration is used as the beat to keep time in a “quartz” clock or watch. Tiny “jewel” bearings, often rubies, are fitted inside clockwork watches. They are used because their surfaces are not worn away by the workings of the watch.



High-quality natural diamonds are used to make fine scalpel blades for surgeons to use in delicate eye operations. The precision-made stylus in a vinyl record player pick-up is also a diamond and therefore lasts for a long time. Heat flows through diamond very easily, so tiny diamond pieces are used in television transmitters to keep electronic devices cool.

A quartz watch

In a quartz watch, a battery produces electric pulses. These electric pulses “wobble” the quartz. As long as the battery continues to do this, the quartz will “wobble” at an exact rate to create a steady pulse. This helps to keep the watch showing the correct time.

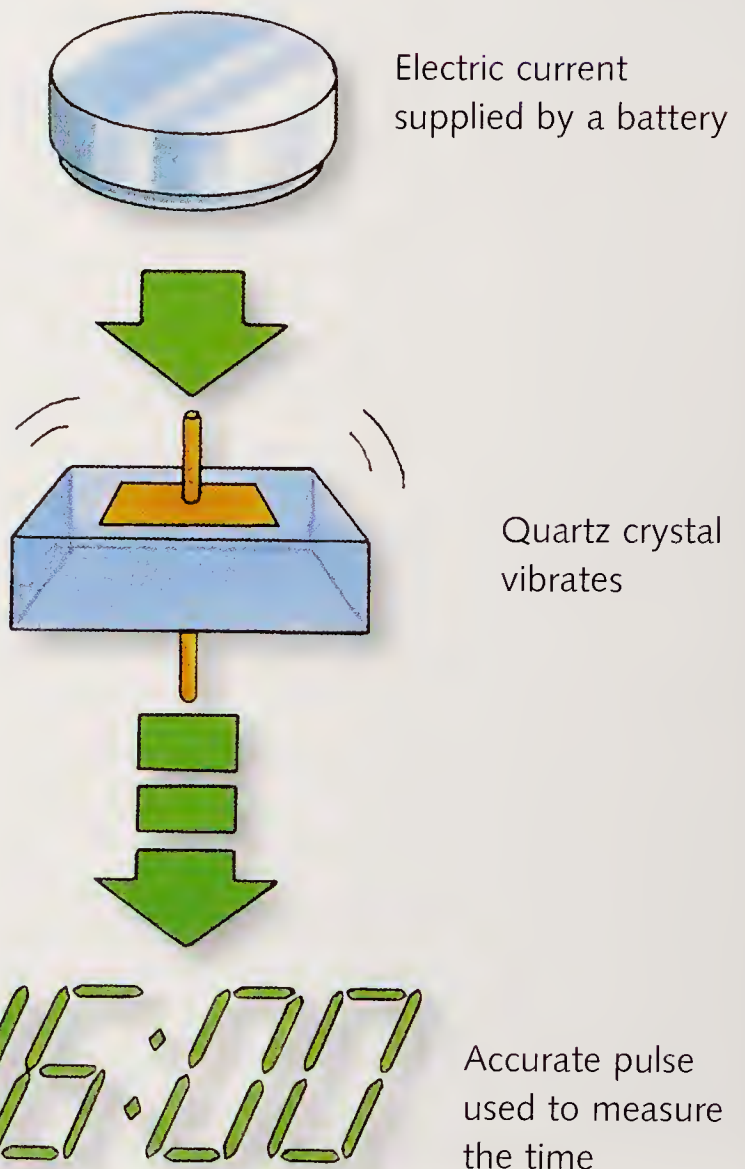

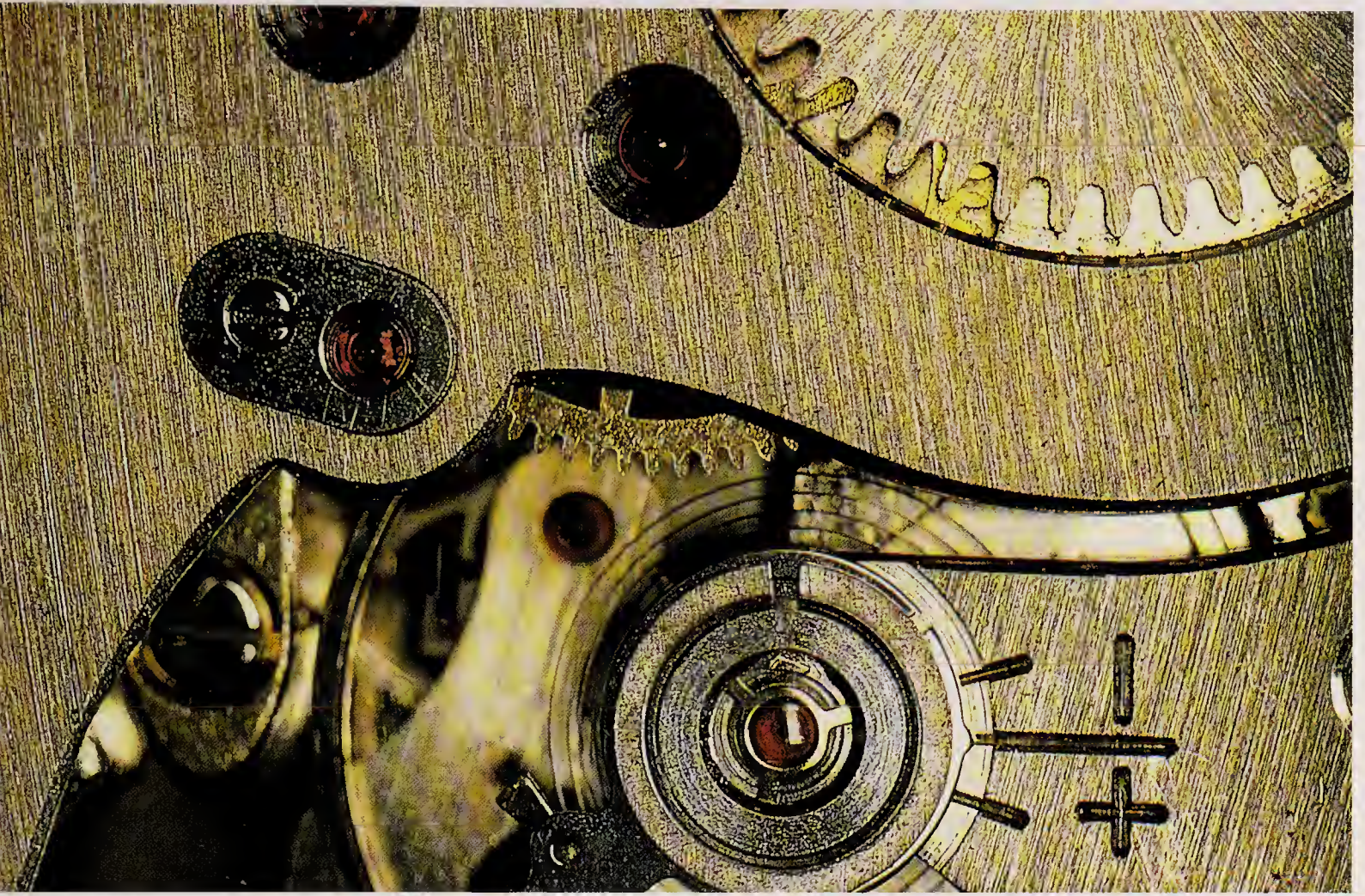

The workings of a 17-jewel clock

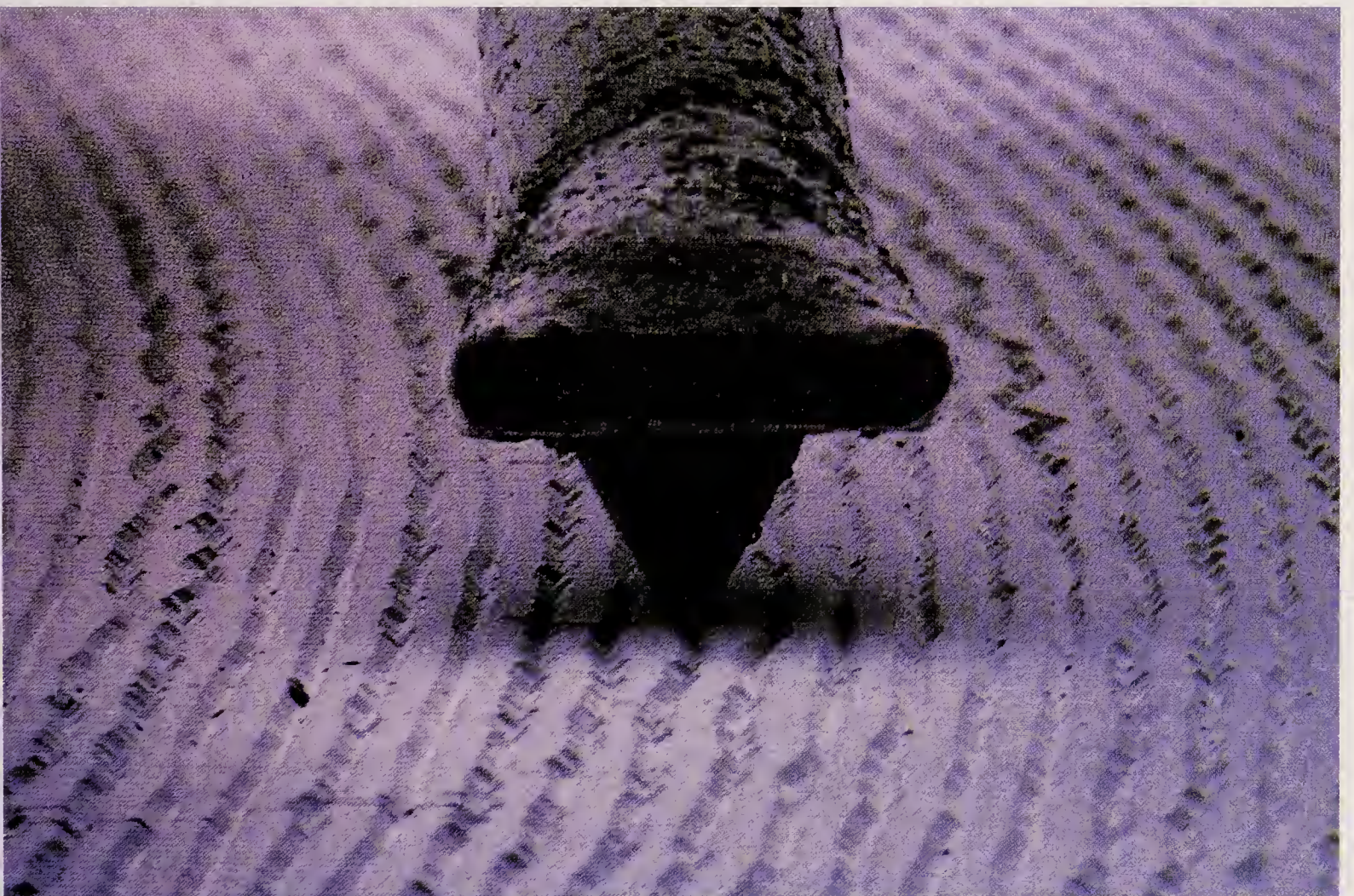

An electron microscope photograph of a diamond stylus in a vinyl record groove

GEMS IN SPACE AND MEDICINE

Gems have played an important part in medicine since around the 1960s. Rubies are used to produce a laser beam in certain types of lasers. Ruby lasers are used in the removal of skin blemishes, such as tattoos. However, there can be side effects to this treatment, such as scarring and a removal of natural skin color in the area.

Diamonds have many special properties. Hard diamond chips are used on dental drills to allow them to cut easily through teeth. Many kinds of radiation can travel easily through diamond and it can withstand huge pressures. This makes it suitable for use in space, and in weather and spy satellites. Perfect diamonds are used on space probes, as shown below, as they are unlikely to be damaged by the deadly gases found on some planets, such as Venus.

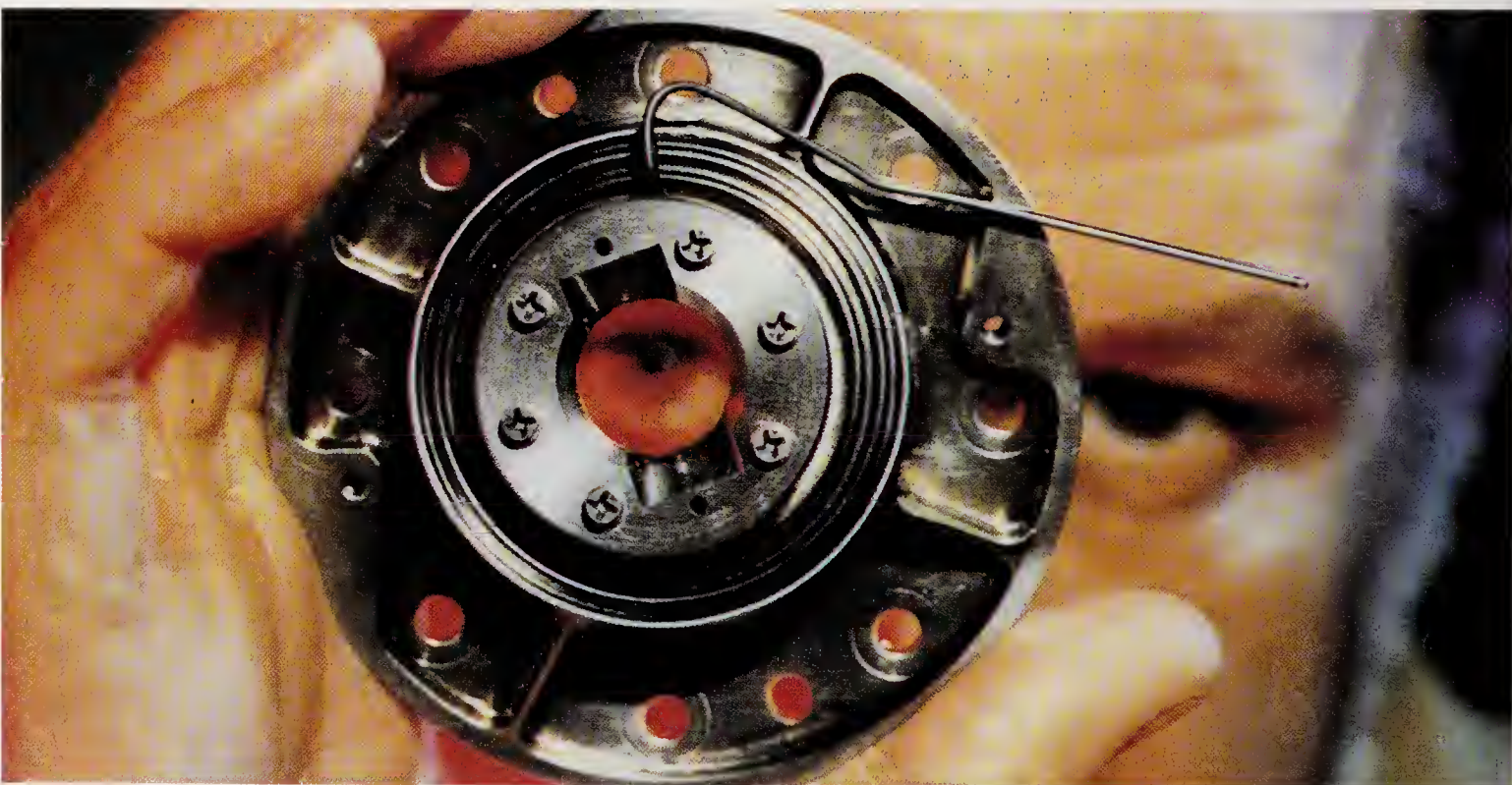



An electron microscope photograph of the diamond chips on a dental drill

THE ENVIRONMENT

Gemstones play an important part in our lives. We use gems in medicine, space travel, weather forecasting, engineering, and in industry. Without them we would not be able to drill into the earth's crust to extract oil, which has numerous uses in today's world. However, the extraction of gemstones can cause a number of environmental problems.



▼ Wildlife

During the mining process, large areas of vegetation are cleared to allow for the exploration of the area, the actual mining, and the processing of the gemstones retrieved from the mine. As a result, the animals and plants in the area are wiped out.

▲ Pollution

The heavy digging and lifting machines used in the mining industry pump out carbon monoxide, hydrogen, and oxides of nitrogen and sulfur. These can be harmful to humans and wildlife. The carbon monoxide is converted into carbon dioxide in the atmosphere. This contributes to the greenhouse effect—global warming—that could devastate our planet if it is not controlled.





◀ Waste

A lump of rock bigger than a house must usually be crushed and sorted to find one small gem. This waste must be disposed of safely so that it does not cause further damage to wildlife. The crushing of waste rock also produces a lot of dust that can hang in the air, making breathing uncomfortable. Water drainage from mining processes carries acidic waste products into rivers, causing harm to the local ecosystem.

▼ Rarity

Many gems are rare. Even gems that are thought of as common, such as amethyst, are rare compared to most rocks in the earth's crust. To conserve these rare stones, scientists have found ways of creating artificial gemstones, mainly for use in industry.



▲ The future

To protect the environment from damage caused by gemstone mining, it must be managed properly. This means that governments and mining companies must stick to rules that encourage waste to be disposed of safely. They must also limit destruction of ecologically important areas, such as habitats that contain endangered species of plant or animal life.



WEIGHT AND HARDNESS

Weighing gemstones

Diamonds and other gemstones are weighed in a special unit. This is called a "carat." There are five carats (cts) in one gram. Therefore, 1 kg is 5,000 cts. Tiny diamonds have their own measure. They are weighed in "points." One carat is 100 points, so a quarter-carat gem (0.25 ct) is a "twenty-five pointer." Gold is also measured in carats but these are not based on weight. They are amounts of gold in metal, and 24 carats is equivalent to 100 percent pure gold. The diagram compares the sizes of diamonds.

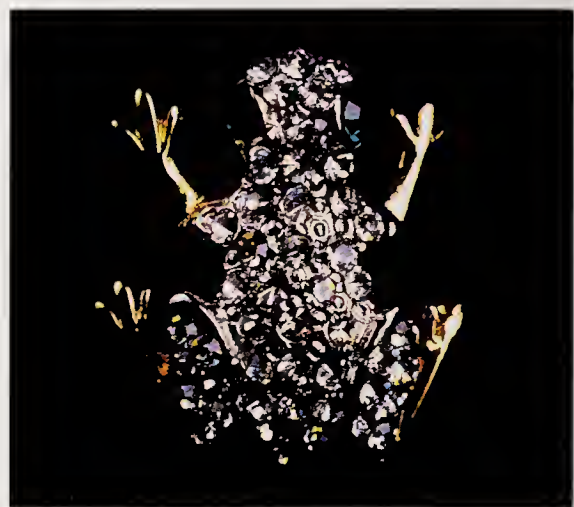

Lots of smaller diamonds are used to make a bigger jewel.

Comparing the size in diamonds using their carat values (actual size)

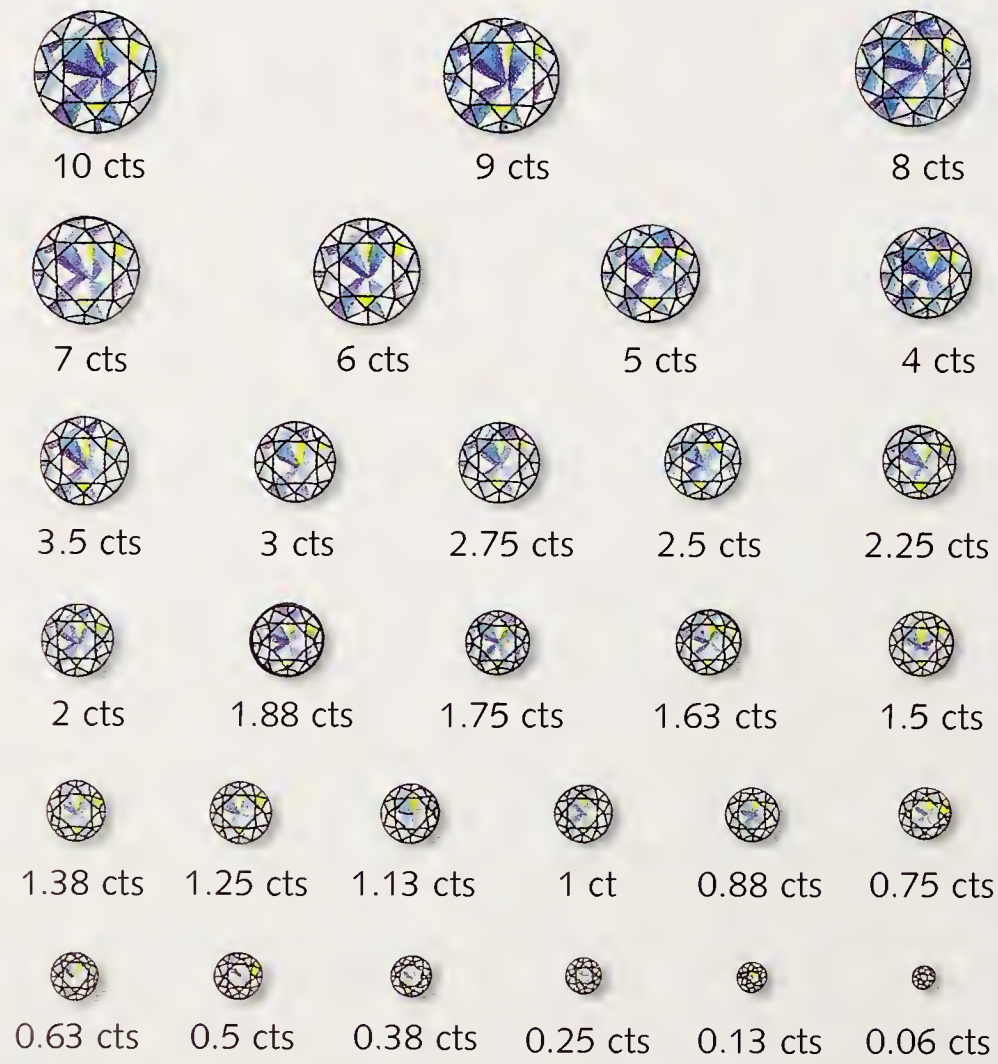

A selection of gems



Diamond



Ruby

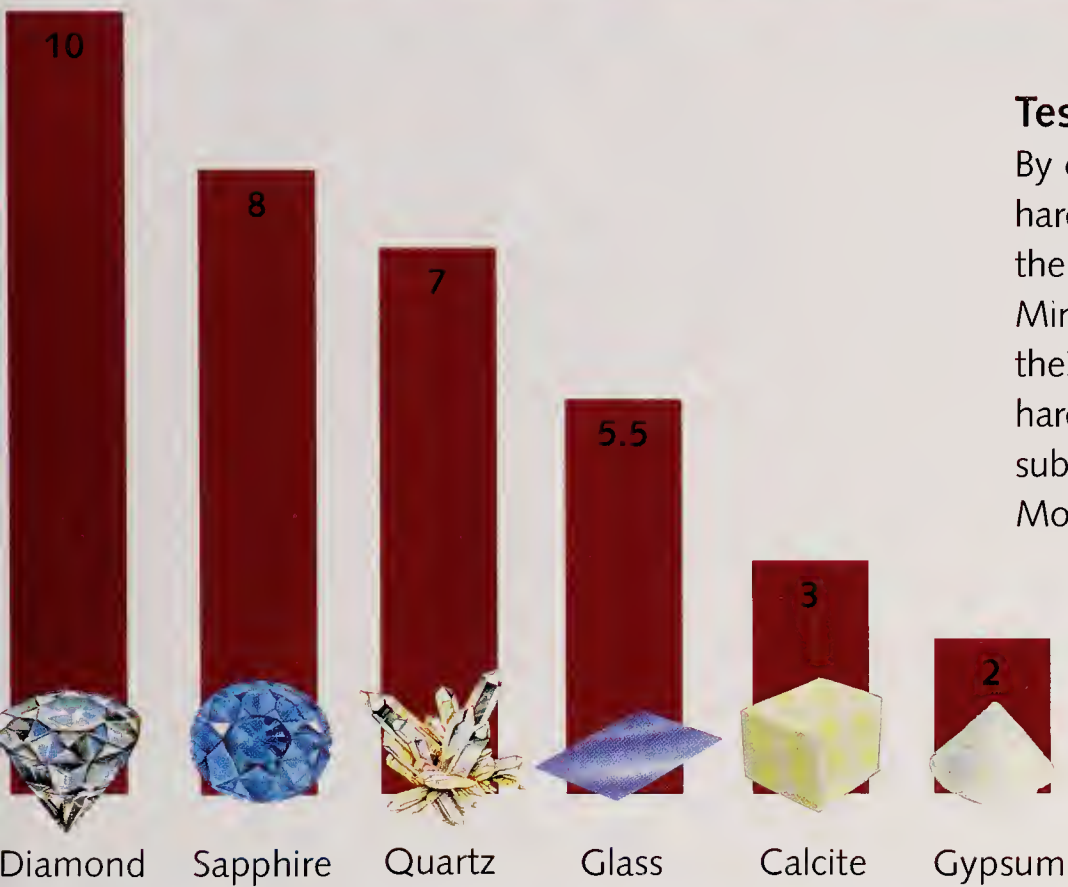

Testing for hardness

By comparing other stones with the hardness of a diamond, a test called the "hardness test" was developed. Minerals can be tested by measuring their hardness. In the diagram, the hardness value of several different substances is given. This is called the Mohs scale and measures hardness from one, representing talc, to ten—diamond—with the highest hardness value. Calcite is a colorless mineral found in limestone; gypsum is a white mineral and is used for making plaster.



GEM DEPOSITS

Diamond mines produce both gem-quality and industrial diamonds. Although most of the diamonds sold are industrial diamonds, the value of the gem diamond trade is much greater. Africa is the richest continent for diamond mining, accounting for around 49 percent of world production. Artificial diamonds are made for use in industry. Most artificial diamonds are made in the United States.

A total of only 314 tons of diamond has ever been mined in the whole history of diamond mining. The world's total of all gems—industrial, natural, and synthetic—is around 57 tons per year.



Star of Africa
530.20 carats



Green Dresden
41 carats

"Eugenie"
blue
diamond
30.82
carats

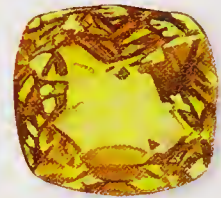

Tiffany yellow
diamond
128 carats

Blue Hope
diamond
44.5 carats



Black
Amsterdam
diamond
33 carats



Smithsonian pink diamond
2.9 carats

The world's famous diamonds

The Star of Africa is the world's largest cut diamond. It was cut from the biggest diamond ever found and is included in the British Crown Jewels. The Smithsonian pink diamond, although small, is extremely valuable because of its unusual color.

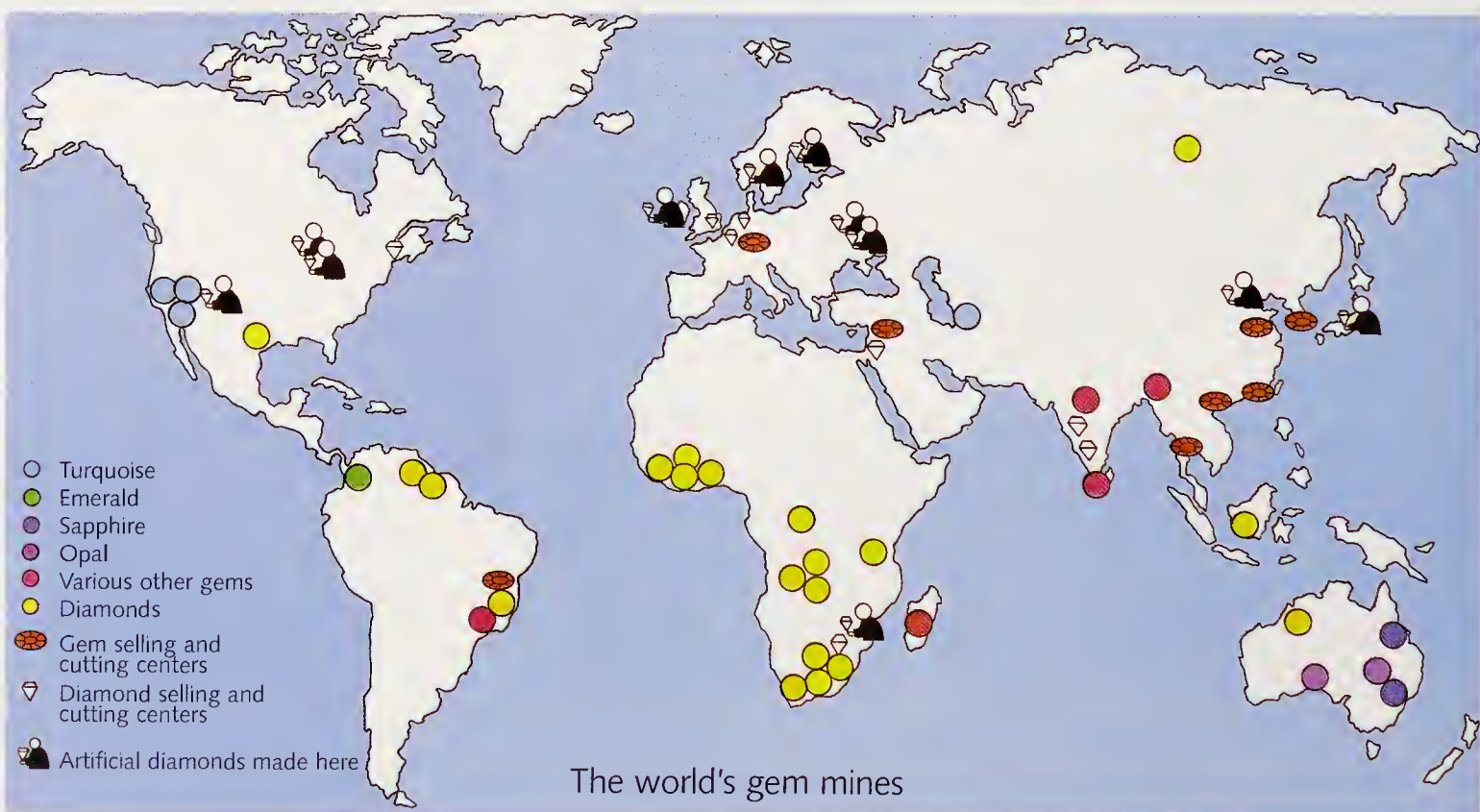



GLOSSARY

Artificial

Manmade, not natural. Some substances, like diamond, ruby, or quartz, can be made artificially although they are also found naturally. When this sort of substance is artificial we call it synthetic.

Atom

A tiny particle. It is the smallest part of a chemical element that can exist and still have all the characteristics of that element.

Brillianteer

A brillianteer grinds small facets onto a gem. Once this is done correctly, the gem will glitter and sparkle.

Bruting

A method of shaping a gem. It involves holding a diamond, spinning at a high speed, against the gem in order to shape it.

Cabochons

Gems that have been cut into the shape of a dome.

Cameos

Gems that have been carved so that a scene, symbol, or figurehead stands out.

Carat

Gems are weighed in carats (cts). There are 5 cts in one gram. Gold is also measured in carats but these are based on the amount of gold in a metal—24-carat gold is 100 percent gold.

Cat's-eye gems

Cabochon cut gems that show a line of light, or a crisscross of lines, when a beam of light shines onto them. The lines move when the gem is tilted.

Crystal

A substance made with a neat, orderly pattern of atoms. This inner neatness sometimes causes crystals to have "faces" on the outside surface.

CZ

Cubic zirconia. A hard form of zirconium oxide crystal used as a diamond imitation. This is an artificial gem.

Doublet

Two substances, sandwiched together. For example, a diamond stuck to a piece of glass to make it look like one large diamond.

Facet

One of the flat, polished surfaces cut on a gemstone or occurring naturally on a crystal.

Fire

The colorful twinkling of a gem. The more a gem reflects light inside, from facet to facet, and the more it splits that light into a rainbow of colors, the more fire it displays.

Gemologist

A person who studies gems. Gemologists carry out tests to tell if a gemstone is natural or artificial.

Lapidary

A person whose job it is to cut gems.

Mineral

A chemical substance that is found in the earth's crust. Minerals are the basic natural substances that make up rocks.

Mohs scale

A measure of hardness that runs from one to ten. Diamond is ten, the hardest substance known.

Transparent

A substance that you can see through. Clear glass is transparent.

INDEX

- A**
agate 7
amethyst 7, 29, 31
aquamarine 7, 29, 30
artificial gems 5, 16, 17,
18, 24, 27, 28, 30, 31
atoms 16, 31
- B**
brillianteer 12, 31
bruting 12, 13, 31
- C**
cabochons 15, 31
calcite 29
cameos 15, 31
carats 28-29, 30, 31
carbon 16
cat's-eye gem 15, 31
citrine 18
computers 20
crystals 4, 5, 6, 7, 10, 12,
16, 17, 18, 22, 24, 31
cubic zirconia (CZ) 16, 31
cutting 12, 14, 20, 30
- D**
diamond 7, 8, 9, 10, 11,
12-13, 16, 18, 22, 26-27,
28, 29, 30, 31
uses of 4, 20-21, 22, 23,
24, 25
doublet 18, 31
drilling 20, 21, 25
- E**
Earth's crust 6, 7, 26, 27, 31
earthquakes 6
element 6, 31
emerald 6, 7, 8, 28, 29, 30
environment 26-27
environmental management
27
- F**
facet 12, 14, 31
fire 14, 31
- G**
garnet 6, 18
gemologist 18, 31
graphite 16
greenhouse effect 26
gypsum 29
- H**
hardness 29
- I**
industrial gems 16, 20, 27,
30
- J**
jade 6, 29, 30
jewelry 4, 5, 18
- L**
lapidary 14, 31
lasers 4, 24
- M**
medicine 24, 26
minerals 5, 6, 10, 26, 29, 31
mining 8-11, 26, 28-29
minor gems 6, 7, 15, 18, 28,
30, 31
Mohs scale 29, 31
moonstone 15
- O**
opal 6, 8, 15, 18, 28, 29, 30
- P**
pollution 26, 27
- Q**
quartz 18, 22, 29, 31
- R**
ruby 7, 14, 15, 16, 22, 24, 30,
31
- S**
sapphire 7, 15, 16, 18, 19,
28, 29, 30, 31
shaping 12, 13, 14, 15, 26,
27, 28
sorting 11
space 4, 24, 26
- T**
talc 29
topaz 7, 8, 14, 18, 29, 31
tourmaline 6, 31
turquoise 6, 28, 29, 30, 31
- V**
value, gemstone 4, 16, 18,
28, 30
volcano 7, 8
- W**
waste 27
weight 28
wildlife 26, 27
- Z**
zircon 6

RESOURCES

GEMSTONES AND THE ENVIRONMENT

GEMSTONES are made from rare crystals that are mined throughout the world for their beauty and their value. Some gemstones also have special properties that make them ideal for use in manufacturing and industry.

This book looks at natural and artificial gemstones—where they come from; how they are processed; how they are used in industry, space, medicine, and jewelry; and the impact that mining gemstones has on the environment.

Titles in the series:

Oils (1-932799-31-1) • Metals (1-932799-33-8) • Gemstones (1-932799-38-9)
Wood (1-932799-34-6) • Plastics (1-932799-32-X) • Glass (1-932799-37-0)
Rocks & Minerals (1-932799-36-2) • Textiles (1-932799-35-4)

A Stargazer Books Library Edition



W1-ATG-222