





IV 1026



# Fahys Permanent Filled Case.

Fahys Permanent Gold Filled Cases are the most thoroughly and carefully made cases to be found on the market.

In beauty of Pattern,  
In tastefulness of Engraving,  
In handsomeness of finish,  
They are unsurpassed.

JOSEPH FAHYS & CO.



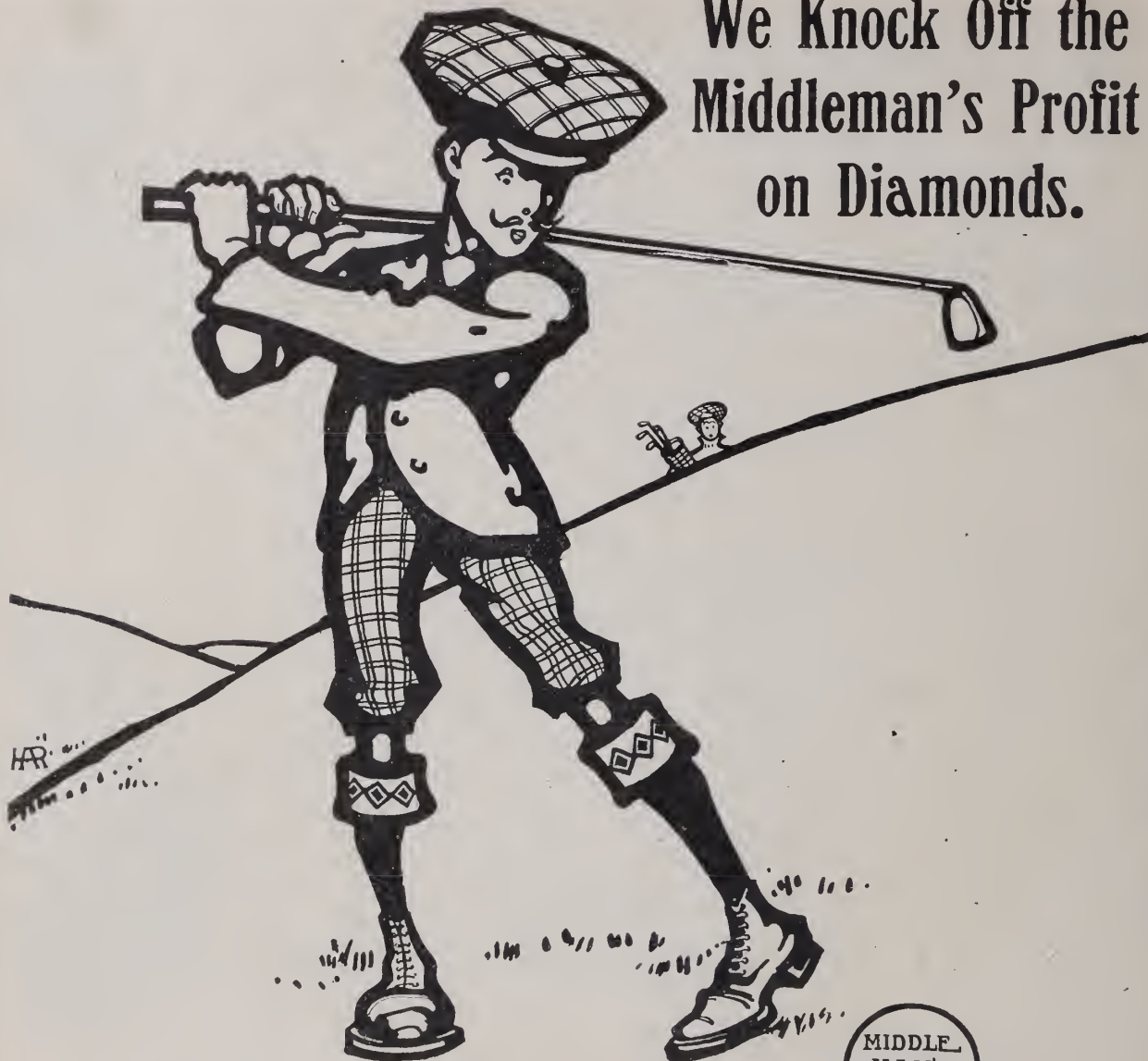

We Knock Off the  
Middleman's Profit  
on Diamonds.

Fact I.—We cut our own diamonds in our own factory.

Fact II.—We employ no salesmen.

Fact III.—We sell direct to the retail dealer.

Either, then, we make a 3-fold profit or we sell for lower prices. An easy way to prove whether the former or latter is true, is to send to us for a selection package and compare our prices with others' the next time you want any diamonds.

Buy direct from the cutter and you'll never fozzle on a sale.



**J. R. WOOD & SONS,**

DIAMOND CUTTERS,

No. 2 Maiden Lane,

New York.



They will come to you for their wedding ring.  
Sell them the best wedding ring in the market.  
A ring you can unconditionally guarantee to be  
exactly what it is represented to be.  
A ring of our manufacture. With all its excel-  
lence it costs no more than inferior ones.

**J. R. WOOD & SONS,**

RING MAKERS,

2 Maiden Lane,

New York.

# We Have Doubled our Line for the Fall Trade

in Vest Chains, Guard Chains, Fobs, Locketts, Grand Paris, etc., coupled with a large number of new ideas which we will not dwell upon at this time. When you see our line you will wonder at our new creations, and it will bother you to know how we can give you so much for the money.

Don't mention it to anyone.

## Design, Workmanship, Quality and Durability

are the four factors  
which have made the

# BIGNEY CHAINS

the most popular in the market to-day. They are handled and worn by more people than any other make.

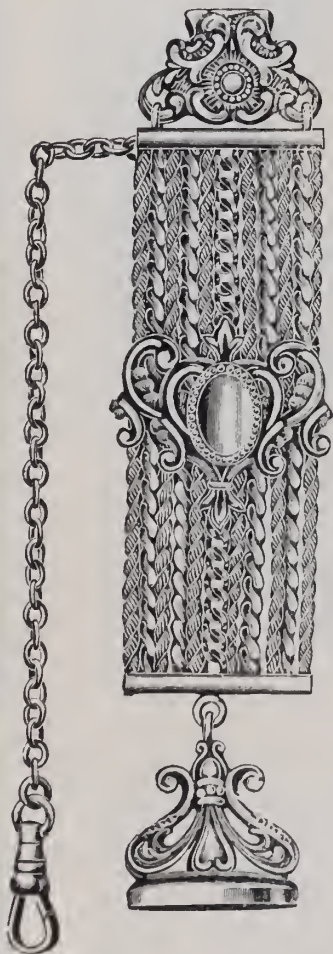

## S. O. Bigney & Co.

NEW YORK OFFICE,  
3 MAIDEN LANE.

FACTORY, Attleboro, Mass.

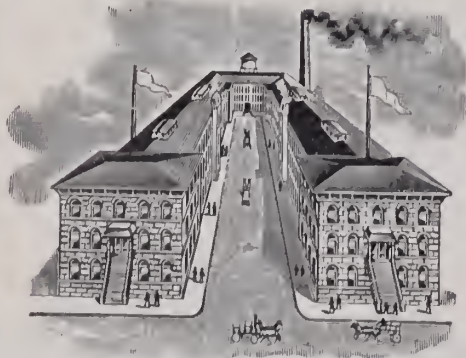





No. 301.



No. 302



No. 305.



No. 303.



No. 300.



No. 3.



No. 18.



No. 11.



No. 14.



No. 13.



No. 317.



No. 306.



No. 196.

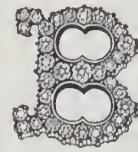

No. 307.

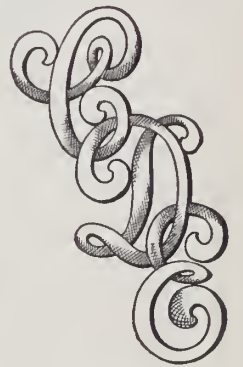

No. 318.



No. 209.



No. 322.



No. 208.



No. 316.



No. 321.



No. 320.

# Wendell & Company

MAKE

## GOLD MONOGRAM CHARMS, FOBS, SLIDES, BROOCHES AND RINGS

SILVER MONOGRAMS for BROOCHES, BELT ORNAMENTS and CLASPS; also for LEATHER BAGS, PORTFOLIOS, MUSIC ROLLS AND ALL KINDS OF EBONY, IVORY AND TORTOISE SHELL GOODS.

ALL ORDERS PROMPTLY EXECUTED.

103 and 105 WILLIAM STREET }  
NEW YORK

2 FACTORIES: {

57 WASHINGTON STREET }  
CHICAGO

---

---

# Can You Answer This One ?

---

Why is the WADSWORTH (25 year) PILOT the best “quarter-of-a-century” Watch Case on the market ?

THE REASON IS  
that, built on honor and  
sold on merit, the

## PILOT

represents a maximum of  
beauty, wear and value.

There's always a reason. There's no element of chance—no lottery—when you buy a WADSWORTH. The reason is in the goods.

---

### *The* Wadsworth Watch Case Co.

CHICAGO                      SAN FRANCISCO                      NEW YORK  
Columbus Building              717 Market St.                      49 Maiden Lane  
FACTORY, DAYTON, KY.

---

---



The above illustration shows our new 12 Size

## PILOT

25 year Screw Bezel and Back. The thinnest and most compact gentleman's watch case ever made to fit American Movements.

Ask your Jobber for them.

---

### *The* Wadsworth Watch Case Co.

CHICAGO  
Columbus Building

SAN FRANCISCO  
717 Market St.

NEW YORK  
49 Maiden Lane

FACTORY, DAYTON, KY.

---

# CUT GLASS

## AND STERLING SILVER

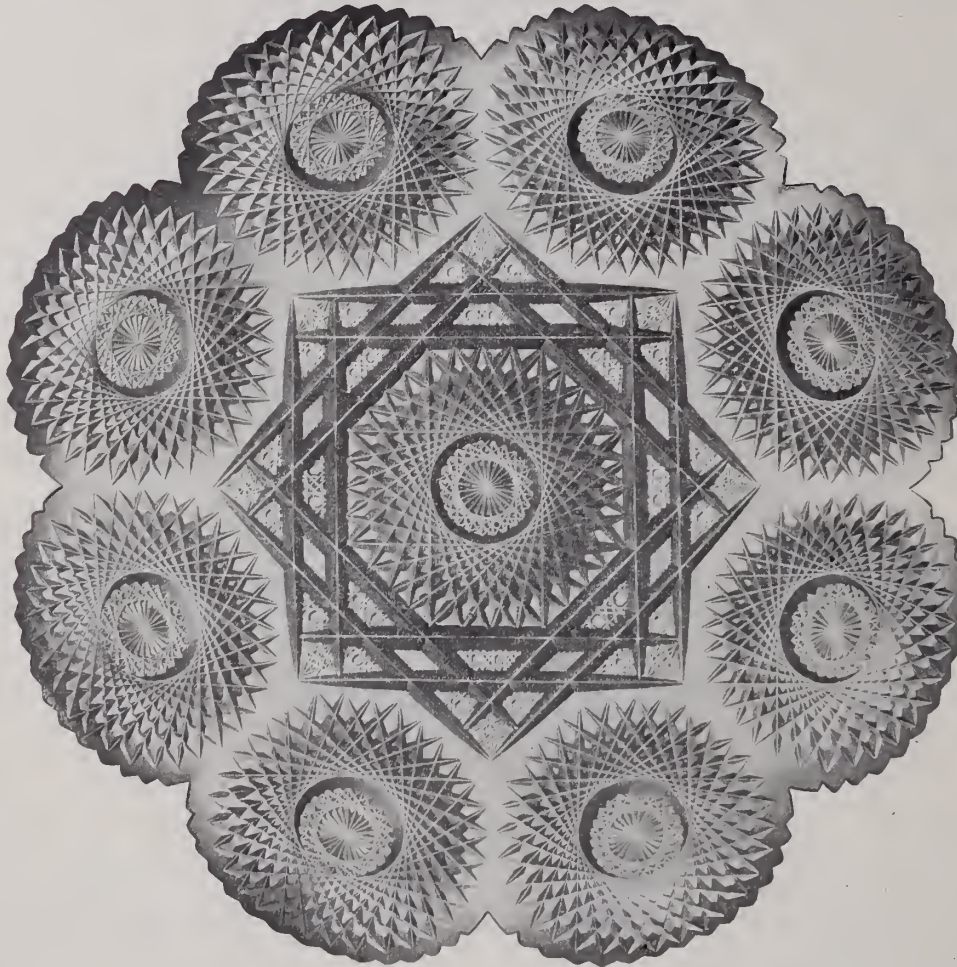

WE do not claim that our **American Rich Cut Glass** is the handsomest.

That's for the dealer to determine. What we **do** claim is that it's the best that we can produce with skill and honest workmanship.

With our cut glass, as with our **Plated Ware** and **Sterling Silver**, we have a reputation to live up to.

Make your headquarters with us when in New York.

### INTERNATIONAL SILVER CO.,

#### FACTORIES:

THE MERIDEN CUT GLASS CO.  
THE BARBOUR SILVER CO.  
THE HOLMES & EDWARDS SILVER CO.  
MERIDEN BRITANNIA CO.  
1847 ROGERS BROS.

ROGERS & BROTHIER.  
ROGERS, SMITH & CO.  
WILCOX SILVER PLATE CO.  
THE DERBY SILVER CO.

THE MERIDEN SILVER PLATE CO.  
THE WM. ROGERS MFG. CO.  
THE ROGERS & HAMILTON CO.  
SIMPSON, HALL, MILLER & CO.  
THE WATROUS MFG. CO.

WAREROOMS, - -

9-11-13-15 MAIDEN LANE, NEW YORK.



**A**MONG the various historical styles of decoration suitable for silverware, none has attained a more lasting popularity than that associated with the name of Louis XIV of France, le Grand Monarque. ¶ It is for this reason that the Whiting Company have decided to introduce a novel and original treatment of this favorite form of French Renaissance applied to a very complete line of Hollow Ware, characteristic examples of which will be here shown from time to time.



**WHITING MFG. CO., SILVERSMITHS**

Broadway and 19th Street, New York.

**Profit and Prestige**  
**is a combination**  
to gain and maintain.

Every  
**Retail Jeweler**  
can earn it by selling

**Dueber-Hampden Watches**

The Best American Watch.  
Sold on its reputation and merit.

**The W. J. JOHNSTON COMPANY,**

Wholesale Agents of the Leading American Watch Companies,

**Fifth Avenue and Market Street, Pittsburgh, Pa.**

## The Greatest Recommendation

ever given to

# Illinois Watches and Hamilton Watches

was, by their greatest rival in the Watch Business, in these few words, **“They have robbed us of our Railroad Watch Business.”**

The conclusion is clear, but the statement is ambiguous.

**The Railroad Watches most in demand are the Watches that are the best for the purpose, and it is an indisputable fact that the**

**Most Reliable Railroad Watches in the World  
are the Illinois and Hamilton Watches.**

**The W. J. JOHNSTON COMPANY,**

Wholesale Agents of the Leading American Watch Companies,

**Fifth Avenue and Market Street, Pittsburgh, Pa.**

# Stern Bros. & Co.

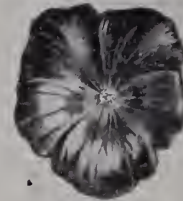

## THE CHARM OF BEAUTY

Nothing more charming in design and perfect in workmanship than our jewelry. Our assortment of bead necklaces, bracelets and brooches, embraces the widest scope of selection, as well as the newest ideas. HIGH-CLASS JEWELRY AT POPULAR PRICES.

**STERN BROS. & CO., 33-43 Gold Street, New York**

SALESROOM AND OFFICES  
Diamond Department  
68 Nassau Street, New York

DIAMOND CUTTING WORKS  
142 West 14th Street, New York

BRANCH OFFICES  
103 State Street, Chicago  
29 Ely Place, London  
12 Tulp Straat, Amsterdam





GREAT MANY of the leading jewelers of America are pushing the sale of *ILLINOIS WATCHES* because of their superior quality.

If you are not entirely satisfied with the line of watches you have been selling, we would be glad to have you try a few of our manufacture.

We are sure you will find them satisfactory in every way and of greater value than comparative grades of other makes.

If your jobber does not carry them, write us for price list and discounts.

**Illinois Watch Company**  
SPRINGFIELD.

Retail selling prices of  
Railroad grades established  
and maintained.

# DAVID KAISER & Co.

MANUFACTURERS OF

## Diamond Mountings

12-14-16 JOHN STREET,

NEW YORK

---

## Notice of Removal

IN consequence of much needed room for our factory, we have removed our offices to rooms 121 and 122 on the 12th floor of our building. Our former office on the 11th floor has been added to the factory, giving us 1,800 square feet for manufacturing purposes, covering the entire 11th floor, and allowing us greatly increased facilities. This will enable us to maintain our reputation for promptness in filling orders, which has always been our chief aim.

Our designer, Mr. John P. Schmidt, sailed for Europe, on the steamer "Kaiser Wilhelm der Grosse," on April 17th, to visit the leading jewelry centers of Europe for the latest novelties in fine Diamond Work, and on his return early in June, we will be prepared to show some of the newest and most artistic effects in all kinds of Diamond Mountings, for the Fall trade.

# DAVID KAISER & Co.

MANUFACTURERS OF

## Diamond Mountings

12-14-16 JOHN STREET,

NEW YORK

*"We never follow the Fashion, the Fashions Follow Us."*

MAURICE L. POWERS.



JOSH W. MAYER.

## TIARAS.

**T**HIS ornament has been the most neglected of any in the past few years. There is a growing demand for this head-dress, and having had many calls of late, it has encouraged us to show an extravagant line of this queenly ornament. It will be the reigning fad for the coming season, and we are now prepared to say that we will show a varied line of these at our coming exhibition to be held in our offices between August 13th and 18th, inclusive.

Many reasons have combined to bring about the pre-eminence of Powers & Mayer products. Many years of aggressive and intelligent effort have been given and they have been years of splendid accomplishment, both in securing earliest representations of foreign styles and developing the best that is in America. Year after year we have introduced to the Jewelers of this country, the new models, also informing them of public demands and giving them the aid of the advice and experience of our experts. This not only gives to us their first and best efforts, but to our stock a breath of originality that does not exist elsewhere.

## POWERS and MAYER,

Makers of Diamond Mounted Jewels THAT SELL,

258-260 Fifth Avenue,

NEW YORK.

We are always pleased to ship goods on memorandum when satisfactory references are given.

## The Sternau Tea Kettle Set

No. 646/420 consists of Tea Kettle and stand, fitted with Ventilated Asbestos Lamp, Sugar Bowl, Cream Pitcher, Wind-Shield, Tea Pot and Oblong Tray. Size, 14 x 22 inches.

Made in Copper, Brass, Nickel or Silver Plate.



Capacity of Kettle, 2½ pints; capacity of Pot, 1 pint; extreme height of Kettle and Stand, 12 inches. Our trademark carries with it a guarantee of satisfactory service and perfection in every detail.

*Write us for illustrations of our complete lines.*

New York Showrooms:  
Park Place, cor. Broadway,  
Opposite Post Office.

**S. STERNAU & CO.**

Makers of Coffee Machines, Chafing Dishes and  
Their Accessories, Smoking Sets, Trays, etc.

Office and Factory:  
195 Plymouth Street,  
Brooklyn, N. Y.

# BRACELETS

**F**ASHION decrees that every woman must wear at least one bracelet—some style of a band bracelet is the proper thing. In no other line can you find a better variety of snappy, artistic up-to-the-minute designs than ours.

Ask your jobber for the **W & D Latest.**  
IT IS A SELLER.

**WHITING & DAVIS,** Plainville, Mass.  
NEW YORK OFFICE, 7 MAIDEN LANE.

# BATES & BACON,

ATTLEBORO, MASS.

Makers of

HIGH GRADE CHAINS.

The BEST SAFETY FOB is one of our specialties; Gent's Vests, Dickens, Lorgnettes, Secret Locket Chains, Locketts, Chate-laines, and the unexcelled

## "Bates" Bracelet

"KANT-KUM-OFF"

We make these Bracelets in

### Seven Sizes.

Just on the market—A New Flat Seamless Wire Bracelet, made with the "WINNA" Joint and Catch. Patented.

Ask your jobbers for **OUR GOODS.**

New York Office, 9 Maiden Lane.  
Chicago Office, 103 State Street.

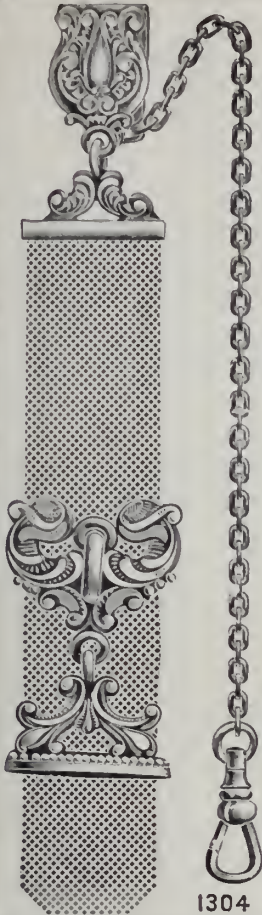

# ONWARD.

We want you to watch our line and note its progress. It has always been our aim to produce goods which have real merit, goods which in point of style, design, weight and workmanship, cannot be surpassed. We shall continue this policy. We are enlarging our plant and adding innumerable new articles to our line. See to it that you leave a space in your stock for our goods and profit will surely be yours. We will make more definite announcements later on. In the meantime do not let our line go by without a look, or send to us for further particulars.

†B  
TRADE-MARK

†B  
TRADE-MARK

**R. Blackinton & Co.,**  
Manufacturing Jewelers and Silversmiths,  
No. 3 Maiden Lane, New York.

Factory, North Attleboro, Mass.

JOHN R. MORSS.

Western Representative, F. D. NEWBURGER.

GOLD  
RINGS

BROOCHES AND MOUNTINGS

Also GOLD FILLED RINGS, including the popular THREE CROWN

Ostby & Barton Company respectfully announce to the jobbing trade that their fall line comprising many new and original designs is now ready.

OSTBY & BARTON COMPANY

New York, 13 Maiden Lane  
Chicago, 103 State Street

PROVIDENCE, R. I.

The "Bryant" Rings.

WE have made the **Bryant Rings** for 50 years, and know how to make first class goods. The stone setting—which every retailer knows is a very important part of the work—we give special attention to. The **Bryant Rings** will help your reputation as a first class Jeweler.



TRADE-MARK.

M. B. BRYANT & Co., No. 7 MAIDEN LANE,  
NEW YORK.

The Bowden Rings

ARE COMPLETE IN VARIETY, CORRECT IN  
QUALITY AND PERFECT IN FINISH. WE  
MAKE EVERY VARIETY OF FINGER RINGS.

J. B. BOWDEN & CO.,

1 Maiden Lane.

NEW YORK.

# HENRY FREUND & BRO. SELLERS OF SELLERS



**W**E have kept all the little Brownies busy and some big ones too, and now we are pretty comfortably installed on the twelfth floor of the "Cockcroft Building," Corner Nassau and John Streets. We never were in such shape to hustle out your orders. Send them in and watch the result, or come up to the office and let us show you.

## HENRY FREUND & BRO.,

Cockcroft Building, 71 Nassau St., cor. John St., NEW YORK.

Elk and F. O. Eagle Goods  
a Specialty.

"Sellers of Sellers."

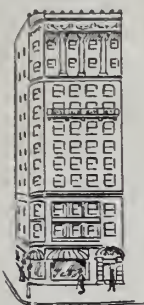

Our New Line for  
the Coming Season  
is NOW READY.

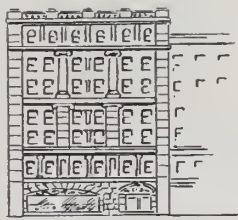

REMOVED FROM  
23 MAIDEN LANE



# 2 Moves May 1, 1906.

NEW YORK OFFICE  
520 FIFTH AVE. COR 32<sup>ND</sup> ST  
IN THE "NEW WHOLESALE DISTRICT"

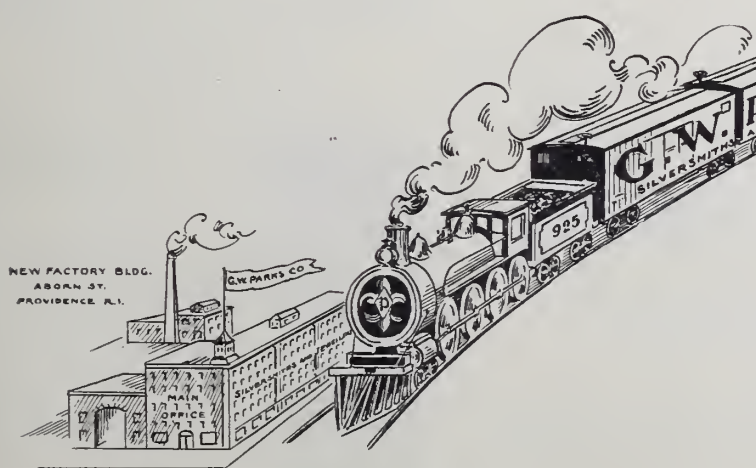

NEW FACTORY BLDG.  
400<sup>TH</sup> ST.  
PROVIDENCE R. I.

This illustration shows our double move.  
MAIN OFFICE AND WORKS FROM NEWARK, N. J.,  
TO PROVIDENCE, R. I.

NEW YORK OFFICE FROM MAIDEN LANE,  
To "The New Uptown Wholesale District"

## G. W. PARKS CO.

Makers of Sterling Silver Wares.  
PROVIDENCE, R. I.

### Expert Workmanship in Lorgnettes.



EXPERIENTIA  
DOCET

THE MECHANICAL features are no less important in a Lorgnette than its artistic points. It must be practical as well as ornamental. Durand Lorgnettes are superior mechanically and artistically, embodying expert workmanship.

PRICES: \$12.00 to \$800.00.



EXPERIENTIA  
DOCET

Durand & Company,

49-51 Franklin Street,  
Newark, N. J.



### SOLID GOLD CHAINS

The selling price of our goods is based on the cost of honest materials, plus the cost of the very best workmanship it is possible to procure. The usual large selling cost is absolutely eliminated—we have no salesmen. You get the benefit of this system of honesty in manufacture and economy in selling, when you buy our

### SOLID GOLD CHAINS



TRADE MARK

For 56 years, exacting Jewelers have found our chains ready sellers, very profitable to handle and most durable in service. Our prices are very low. We will be pleased to send you a selection package.

1850 1906

### ALOIS KOHN & CO.

Makers of  
SOLID GOLD CHAINS  
of every kind.

16-18 Maiden Lane  
New York



### A COMPLETE LINE

of some of our handy pins. Made in all colors, sizes and finishes.

A. J. HEDGES & CO.,

Makers of Exclusive Designs in 14K. Jewelry,  
14 JOHN STREET, NEW YORK

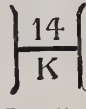

TRADE-MARK



TRADE 14 MARK

### OSMUN-PARKER MFG. CO.

MAKERS OF

Fine Pearl and Diamond Goods

338 Mulberry Street, NEWARK, N. J.

ESTABLISHED 1871.

Factory and Office: Newark, N. J.

INCORPORATED 1900.

### CARRINGTON & CO.,

Patent Pocket Match Box

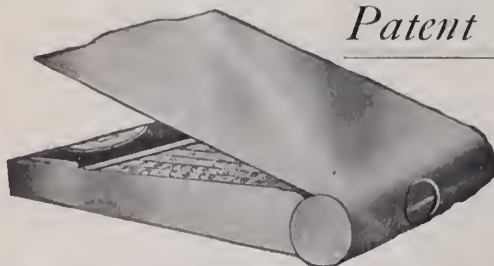

14K. ONLY IN STOCK.

Book Safety Matches with  
Steel Cigar Cutter.  
(Patented.)

Sales Agent:

7 Maiden Lane,  
NEW YORK.



### M. SCHIFF

Established 1876

82-84 Nassau St., N. Y.

Phone 801 John.

Manufacturer of fine  
Diamond Mountings, Locketts  
and Buttons. Patentee of

### THE NEW IMPROVED Ear Screw

The only one on the market  
of its kind, absolutely secure.  
Special attention paid to all  
order work.



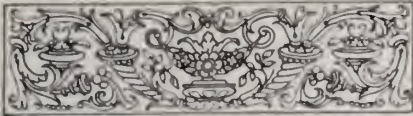

## Colonial Engraved Effects.

**P**ARTICULAR CARE has always been taken by this house to secure the highest excellence in the decorative effects employed. This policy is manifest in the results attained.

You will be interested in our attractive showings in Colonial Engraved Effects. They possess elements of "character" which distinguish and recommend them to refined taste.

Applied to a variety of lines, including

- COMBS,
- BARRETTES,
- HAT PINS,
- BRACELETS,
- SCARF PINS.

## Day, Clark & Company

14 KARAT  
ONLY

25

Maiden Lane  
New York



## WHITESIDE & BLANK

### JUNE BRIDEGROOMS

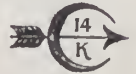

Are selecting gifts for  
BEST MAN AND USHERS.

A Suggestion:

SCARF PINS—Rich Scroll Designs.  
Pearl Mounted.  
Soft Rose Finish.

CUFF BUTTONS—Heavy Link or Post.  
New Pierced Style.  
Strong Etched Effects.

SEAL FOBS—Ribbon Mounted.  
All Finishes.  
Gold or Stone Base.

The fancy of engraving these tokens makes the new lapped top button and the gold base seal fob peculiarly appropriate as gifts from the groom.

NEWARK, N. J.,  
Lafayette and Liberty Streets.

NEW YORK,  
14 and 16 John Street.

ESTABLISHED 1841.

## Carter, Howe & Co.

TRADE  MARK

MANUFACTURERS OF

## Gold Jewelry,

9, 11, 13 MAIDEN LANE, - NEW YORK.

FACTORY, NEWARK, N. J.

A. CARTER.

G. R. HOWE.

W. T. CARTER.

W. T. GOUGH.

## SCARF PINS

TRADE  MARK

Established in New York 1837.

## Geo. O. Street & Sons.

24 JOHN ST., NEW YORK.  
103 STATE ST., CHICAGO.



Quality and  
Finish Consistent  
With Twenty  
Years' Experience

❦

Original and  
Exclusive  
Designs

**MOORE & SON,**  
NEWARK, N. J.

ESTABLISHED 1886. INCORPORATED 1903.





Adjustable  
Solid Gold

## Glove Garters

in Gold, Silver and Plated.  
**THAT NEW THING.**  
**OUR**  
Showings of Gold, Gold Filled  
and Silver Jewelry for Spring  
are complete in

Brooches	Crosses
Links	Rosaries
Scarf Pins	Fobs
Bracelets	Combs
Hat Pins	Waist Sets
Buckles	Collar Supporters
Dog Collars	La Vallieres
	etc.

**Chas. L. Trout & Co.**  
15 Maiden Lane, New York.

# ALLSOPP & ALLSOPP'S

HIGH CLASS  
**BRACELETS**  
MOUNTED IN COMBINATIONS OF

Dia. and Pearl  
Dia. " Sapphire  
Dia. " Emer'lds  
Dia. " Baroques



Amethysts  
Topazes  
Peridots  
Aquamarines  
Etc.

18-20 COLUMBIA ST. ◁ & ▷ TRADE-MARK. NEWARK, N. J.

"THE BRACELET HOUSE."  
**KENT & WOODLAND,**  
BRACELETS FOR EVERY WOMAN AND MISS.

16 John Street, New York.

San Francisco Office,  
Care JULIUS A. YOUNG.

"Nethersole Bangles,"  
Plain and with Stones.

"Pinhole" Secret Snap,  
with and without pre-  
cious and semi-precious  
stones.



**To Jobbers Only—**

When you think of Toilet Goods,  
please remember us. Our goods  
are high grade and can be retailed  
at popular prices.

*Special Terms on Early Business*  
**Art Stamping & Mfg. Co.**  
411 Commerce Street, PHILADELPHIA, PA.

**ROBERT DULK,**  
DESIGNER,  
Etching in Gold and Silver,  
Telephone, 3960 Chelsea.  
No. 70 5th Avenue, NEW YORK

# MONOGRAMS.

In Gold, Silver and Plate.

A complete line of Two and Three-Letter Monograms always in stock.

SPECIAL DESIGNS TO ORDER.

Elegant  
Silk Ribbon  
and  
Leather Strap  
FOBS.

Always  
Acceptable as  
Gifts.

A Beautiful Solid  
14-K. Gold  
Monogram Fob  
with Ribbon and  
Swivel, complete,  
any three  
letters desired,  
for

**\$10.00**

Send for new  
Illustrated Catalogue,

showing the largest  
selection of stock  
Fob Monograms,  
from 50c. in Gold Plate  
upward.

Create a demand for  
these Fobs by display-  
ing a few samples in  
your window.



1260.

### WIDE STRAP FOB.

English Pig Skin, Tan or  
Black, Take your choice.  
Monograms to order, two  
or more letters, same  
price.

Gold Plated...each \$4.50  
Gold Filled...each 7.50  
14-karat Gold, each 15.00

These prices are list  
and subject to discounts  
as shown in our new  
illustrated catalogue.

**OUR  
SPECIALTY:**

MONOGRAMS  
AND INITIALS FOR  
POCKET BOOKS,  
BAGS, ETC.

Send for Fob and Monogram Catalogue  
or other information to

**Thomas J. Dunn & Co.,**  
101 and 103 Chambers St.,  
Dept. J. NEW YORK CITY.

# Look for the Stamp

on back of



The Standard American Collar Button.

# Krementz Collar Buttons and Studs

## The Government Stamp

on every bar of gold issued by the U. S. Assay Office  
giving its Quality, Weight and Value, is known and  
accepted all over the world as absolutely correct.

## The Kremmentz Stamp

is universally recognized by dealers and wearers with  
the same confidence.



# KREMENTZ & CO.,

49 Chestnut Street,

Dept. A.

NEWARK, N. J.

Send for booklet "The Story of a Collar Button"—Free

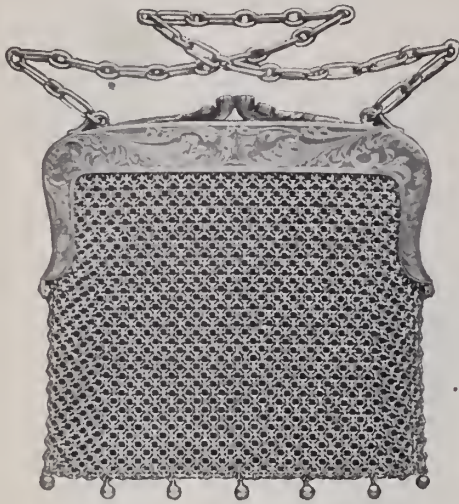

# S. Cottle Co.

are showing an entirely new and exclusive line of Gold and Silver BAGS and PURSES, also many lines of BRACELETS—all of superior workmanship and design.

31 East 17th Street,  
New York.



Three-Quarter Size

## New Pierced Nethersole Bangles

14 karat, Size 7 1/2 inches. Suitable for wearing over the new long gloves

### COOPER & FORMAN

Office and Factory, 3 Maiden Lane, N. Y.

Makers of Diamond Jewelry

Festoon Necklaces  
Locketts  
Cuff Buttons

Brooch Pins  
Scarf Pins  
Bracelets

## Bridesmaids' and Ushers' Pins

We would suggest something with color. Brooches, Scarf Pins and Handy Pins with Amethysts, Topazes, Garnets, Peridots, Aquamarines, Jades and Baroque Pearls. We have a large variety of patterns at moderate prices.

REGARDING OUR FOBS WE HAVE NOTHING TO SAY—  
THEY SPEAK FOR THEMSELVES.

## SNOW & WESTCOTT,

Makers of Good Jewelry for Over Seventy Years,

21 MAIDEN LANE, NEW YORK.

Everything New Under the Sun

IN MODERN JEWELRY  
OF EVERY DESCRIPTION

## Signet Rings

(OUR OWN MAKE)

A SPECIALTY.

We Solicit Memorandum Orders.

*L. Witsenhausen*

47-49 Maiden Lane,  
New York.

Manufacturers of MODERN JEWELRY

Chicago, 405 Masonic Temple.  
(L. KATLINSKY.)

ADOLPH LUTHY.

PERCY W. HINE.

## LUTHY & HINE,

13 EAST 30TH STREET, - NEW YORK.

MANUFACTURERS OF

### Artistic Gold and Platinum Mounted Diamond Jewelry.

Odd and Exclusive Patterns in NECKLACES, BROOCHES, BRACELETS, RINGS, RIBBON COLLARETTES, Etc.

MOUNTED WITH AQUAMARINES, PERIDOTS, AMETHYSTS AND OTHER PRECIOUS STONES.

(DIAMOND MOUNTED COMBS A SPECIALTY.)

## DESIGNS For Silverware, Novelties and Jewelry . . . FINE ETCHING

Even if you have your own designer, don't you think it a good policy to use an "outside" idea once in a while? Try one of ours.

CHARLES M. PRIOR (PHONE 1224 HARLEM) 1683 Madison Ave., New York

## GARREAU & GRISER

68 & 70 Nassau St., New York.

LAPIDARIES. PRECIOUS STONES.  
EMS in Unique Cuttings.



The Rosary  
in Fine Jewels

Fine Rosaries in pure and imitation stone. Mounted in solid gold and rolled gold-plate

ALL COLORS.

Our special illustrated catalogue will give interesting advice regarding prices and discounts.



MADE BY

**The W. J. Feeley Co.**  
Providence, Rhode Island,  
Ecclesiastical Art Metal Workers.

**THE WASHBURN SECURITY MAGIC NUT**  
Automatic Holder for ear studs, scarf pins, etc.  
for all sizes of scarf-pin wire. Guaranteed.



**EAR WIRES**  
for unpierced ears.



**SAFETY CATCH**  
For brooches, etc.  
Can be applied to any work where pin tongues are used.



Open. Closed. Open. Closed.  
Descriptive Circular on Application.  
Pearl drilling and Adjusting a specialty.  
Special Order Work and Repairing.  
C. IRVING WASHBURN, 12-16 John St., N. Y.

**THE CROHN PATENT SAFETY GUARD.**



For Scarf Pins. The most adjustable one invented. Price, \$1.50 per doz. For sale by all wholesale jewelers and material houses. Sample by mail, 25c; in 10k. gold, \$1.00; 14k., \$1.25. M. CROHN, Maker and Inventor, 43 and 50 Maiden Lane, N. Y.

Studs and Lace practical and only \$1.50 per doz. For sale by all wholesale jewelers and material houses. Sample by mail, 25c; in 10k. gold, \$1.00; 14k., \$1.25. M. CROHN, Maker and Inventor, 43 and 50 Maiden Lane, N. Y.

THE...  
**SOLID GOLD PEARLETTE BARRETTE**  
THE LATEST IN HAIR ORNAMENTS



Set in fine artificial pearls, indestructible, and cannot be detected from the real pearls.

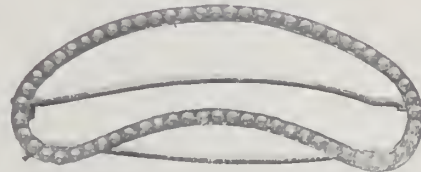

All of our designs are original and exclusive and are possessed of utility and rich possibilities of artistic treatment.

**SCHULTZ, LEISS & CO.**

OFFICES  
14 John St., New York 103 State St., Chicago  
FACTORY  
Cor. McWhorter and Oliver Sts., Newark, N. J.



**NEW SPRING PATTERNS.**



In our comb showings for Spring every detail is significant of superior workmanship, while our patterns are of the exclusive and original type.  
Every comb is artistically developed and possesses qualities for the most exquisite adornment.  
This cut represents a comb 4 1/2 inches in width.

Write for prices.  
**SCOFIELD & De WYNGAERT,**  
50 Walnut Street, NEWARK, N. J.  
New York Office, - 9-11 Maiden Lane.  
C. C. PICKFORD.



No. 1638.—Sterling hand-pierced bag, all soldered ring mesh, and workmanship unexcelled. Size 5 3/4 in. by 4 in.

**Sterling Hand Bag**  
No. 1638.  
Hand Made.



Our Bags and Chains are handled by the most exacting Jewelers. A sample order will show you the reason. Our prices are "right."

**SPECIALTIES:**  
Plain, Engraved, Etched and Hand-Made throughout Sterling Silver Hand Bags.  
(Telephone, 1038 J. Newark.)

# THE NEW MOUNTING.

A SETTING FOR EVERYTHING.

Earscrews,  
Earrings,  
Studs,  
Scarf Pins,  
and Rings  
of every description.



Made in  
Platinum,  
18K.,  
14K.,  
all sizes.

NOW READY TO RECEIVE YOUR ORDERS.

## JULIUS WODISKA,

MANUFACTURER OF A GENERAL  
LINE OF DIAMOND MOUNTINGS,

40 JOHN STREET,

NEW YORK.

## DEPASSE MANUFACTURING COMPANY.

This corporation has been organized under the laws of the State of New York and has taken over all the business, accounts and assets of the partnership heretofore carrying on business under that name, and also all property and assets of the Eugene S. Toner Company. The new company will continue the manufacture of Deposit Work in Silver and Gold upon China, Glass and other substances and will hereafter sell its product in its own name. All indebtedness of the partnership trading under the name Depasse Manufacturing Company and of said Eugene S. Toner Company has been assumed by the new corporation and will be paid when due.

## ELLIS & CO.,

10 Holborn Viaduct, - - - London  
Hall Street, - - - - - Birmingham

ENGLAND



Plated Goods on Copper with  
Sterling Silver Mounts, Rolled  
Plated Goods, Trays, Waiters, etc.

# Koshland & Italic Co.

702 Chestnut Street,

PHILADELPHIA, PA.

## FAHYS FILLED CASES.

We handle exclusively

Fahys Permanent

Guaranteed Permanently.

Fahys Montauk

Guaranteed 20 years.

Brooklyn Bristol

Guaranteed 25 Years.

Brooklyn Windsor

Guaranteed 20 years.

SEND FOR SELECTION PACKAGE.

## CROUCH & FITZGERALD



**Jewelry  
Trunks  
and Cases**

177 Broadway,  
Bet. Cortlandt  
and Dey Sts.

688 Broadway,  
723 6th Ave.,

New York.

Match Boxes  
 Pen Knives  
 Cigar Cutters  
 Brooches  
 Scarf Pins  
 Fobs

**ROBT. LEVY**

*Manufacturing Jeweler*

will utilize this space from  
 now on for advertising  
 his line of

**10K. Jewelry that is 10K.**

**ROBT. LEVY**

*Manufacturing Jeweler*

Green and Columbia Streets  
 NEWARK, N. J.

---

All Goods  
 Mounted or  
 Unmounted

---



---

Write for  
 Selection  
 Package

---

Bracelets  
 Locketts  
 Buttons  
 Bead Necks  
 Heart Charms  
 Tie Clasps



Timer is 1/8 Larger than cut

# THE OLD RELIABLE Centennial

## SPLIT SECOND TIMER

*"None better made"*

Now is the time to order TIMERS for the Spring and Summer trade—suitable for racing purposes or for mechanical uses.

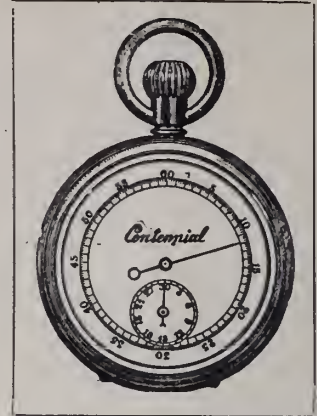

Timer is 1/8 larger than cut

# CROSS & BEGUELIN, Manufacturers, New York.

## The Comb House

We manufacture a complete line of

### FINE MOUNTED COMBS

in 14 K., 10 K., Sterling Gilt and Gold Filled.

Also all kinds of PLAIN, REAL and IMITATION TORTOISE SHELL COMBS.

### Wagner Manufacturing Co.

41 Union Square,

New York. Factory, Lorimer St. and Throop Ave., B'klyn, N. Y.

Repair Work a Specialty.



## Ross, Saltman & Anderson

MANUFACTURERS OF

### Rings and Diamond Mountings

89 FULTON STREET,  
NEW YORK



699



204

Jewelers will find it desirable and profitable to keep in touch with our new and artistic monthly productions. They represent that originality and perfection upon which we propose to establish a substantial reputation.

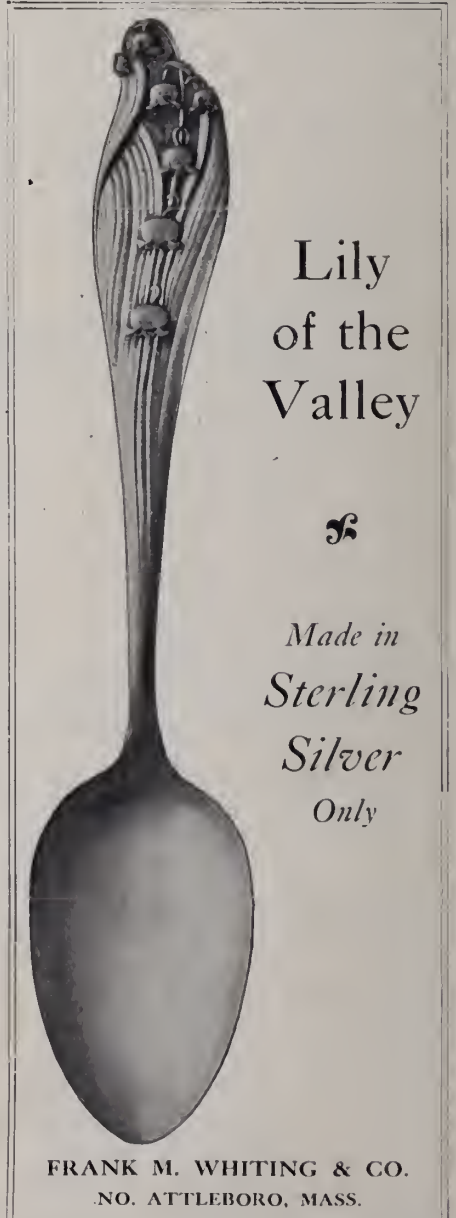

## Lily of the Valley



Made in Sterling Silver Only

FRANK M. WHITING & CO.  
NO. ATTLEBORO, MASS.

## HERMAN KOHLBUSCH, Sr.,

ESTABLISHED 1859.

Manufacturer of Fine Balances and Weights for every purpose where accuracy is required.

Office and Salesroom, 194 BROADWAY, NEW YORK.

Send for Price List.

Tel. 370 Cortlandt.





HIGH CLASS FANCY  
**Link Bracelets**

MOUNTED WITH AND WITH-  
OUT FANCY STONES.

The  
Product of  
Many Years  
of Con-  
scientious  
Manufacture.

We are  
the  
largest  
exclusive  
makers  
of 10  
Karat  
jewelry.

Ask  
your  
Jobber  
for the  
P. & B.  
Co.  
lines of  
Fobs,  
Locketts,  
Tie Clasps,  
Brooches,  
Scarf Pins,  
Hat Pins,  
Baby Pins,  
Bead  
Necks,  
Cuff  
Buttons,  
Crosses,  
Bracelets  
and  
Waist Sets.

Design  
Illustrated

No. 7957

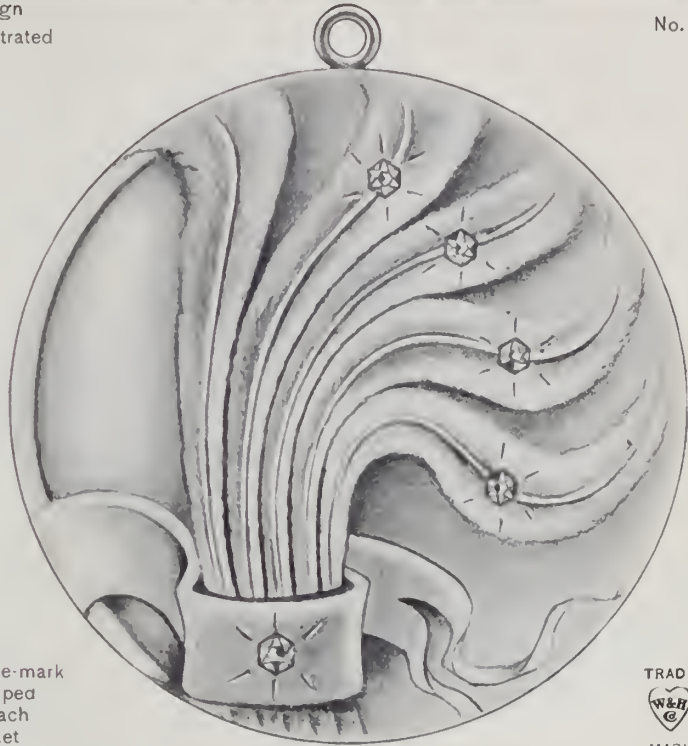

Trade-mark  
stamped  
in each  
Locket



Our **LOCKET** creations continue to be the standard for workmanship and design. Originality and quality have combined to render the excellence of W. & H. Locketts unsurpassed.

3 Maiden Lane **Wightman & Hough Co.** Providence, R. I.  
New York



**COMBS**

OUR new line shows many designs, highly artistic and attractive, that will prove rapid sellers.

The highest class of workmanship is characteristic of all our lines.

- |            |                  |
|------------|------------------|
| Combs      | Baby Pins        |
| Brooches   | Crosses          |
| Scarf Pins | Waist Sets       |
| Bracelets  | Hat Pins.        |
| Barrettes  | Collarettes      |
| Buttons    | Silver Novelties |



MARK  
**ALWAYS  
ON  
THE  
GO**

LOOK FOR THE TRADE-MARK

**MILLER, FULLER & WHITING, MANUFACTURING JEWELERS**  
N. Y. Office, 9-11 Maiden Lane NORTH ATTLEBORO, MASS.

**Potter & Buffinton Co.,**

Providence, R. I.

New York Office,  
65 Nassau St.

San Francisco Office,  
206 Kearny St.

**Roger Williams Silver Co.,**

PROVIDENCE, R. I., AND NEW YORK, 860 BROADWAY.

**Sterling Only.**

RICH DESIGNS :: :: :: Photos on Application.

# The Kenilworth Bracelet.

(Patented Jan. 2, 1906, No. 808,805.)  
No. 4086.

All of the foremost jobbing houses now carry a full line in stock, and you will miss an opportunity if you fail to see them. Ask your jobber to show you the full line.



A success beyond our expectations. Its simplicity of operation in putting on or taking off, "having no catch or snap," commends it to the discriminating buyer, and has made it the most popular bracelet on the market. Made in plain, beautifully chased and stone set, plain polished, English and Roman finishes, and in gold-filled and sterling silver.

Manufactured by  
**Doran,  
Bagnall  
& Co.,**

North Attleboro,  
Mass.

194 BROADWAY,  
NEW YORK.

67 WABASH AVE.  
CHICAGO.

126 KEARNY ST.,  
SAN FRANCISCO.

EVERYTHING IN LOCKETS AND CHAINS.

THE BASSETT JEWELRY CO.,

PROVIDENCE, R. I.

## Original Reliable Distinctive Emblems Receive Sales



Will pour into your office if you carry our goods.

Our salesmen will be out soon with some *new creations* for the *Fall trade*.

Be sure and have a look.

### IRONS & RUSSELL

Makers of Distinctive Emblems

NEW YORK OFFICE  
11 MAIDEN LANE

MAIN OFFICE AND FACTORY  
95 CHESTNUT ST., PROVIDENCE, R. I.

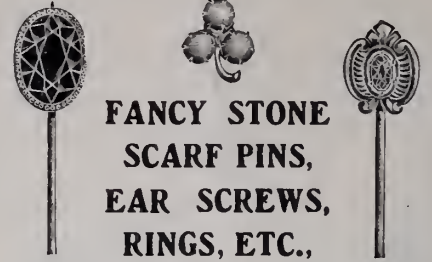

**FANCY STONE  
SCARF PINS,  
EAR SCREWS,  
RINGS, ETC.,**

*That Defy Competition.*

Correct in Price, Quality and Style.

*Request your jobber to show you the designs in these goods as shown in the new manufactures of*

**The American Ring Co.,**  
94 Point Street, Providence, R. I.



**Ladies' Fancy Stone Rings  
and Stone Scarf Pins  
in 10K. that defy  
competition.**

Our reputation for making the finest and most complete line of 10-K. gold band rings is still maintained—ask your jobber.

THE  
**EDWIN LOWE & CO., Inc.**

F. W. BODWELL, V.-Pres. and Gen. Mgr.,  
116 Chestnut St., PROVIDENCE, R. I.

New York Representative, E. T. Wilson, 180 B'way.  
Western Representative, S. H. Brower.

## ORKIN BROS.

373 WASHINGTON ST.,

Jewelers' Bldg., BOSTON, MASS.

Manufacturers of diamond mountings, and repairers to the trade. Importers of precious, semi-precious and imitation stones.

*A Full Line Always in Stock at  
Lowest Prices.*

We aim to be the foremost jobbing house of Boston.

Send us your repairs, or write us for information.

## RINGS

**WM. LOEB & CO.**

101 Sabin St.,

**Providence, R. I.**

New York Office, 37 Malden Lane.

**W**ait  
**A**nd See  
**I**  
**T**  
**E**  
**T**  
**H**  
**R**  
**E**  
**S**  
**H**  
**E**  
**R**  
**'**  
**S**  
**G**  
**O**  
**O**  
**D**  
**S**  
**S**  
**E**  
**L**  
**L**

**Waite-Thresher  
Company**

61 PECK ST., PROVIDENCE, R. I.

7 Maiden Lane,  
NEW YORK.

1203 Heyworth Bldg.  
CHICAGO, ILL.

1876 **Hutchison & Huestis** 1906

**RING MAKERS**

**JADE**  
is in  
vogue.

See our  
**JADE**  
**RINGS**

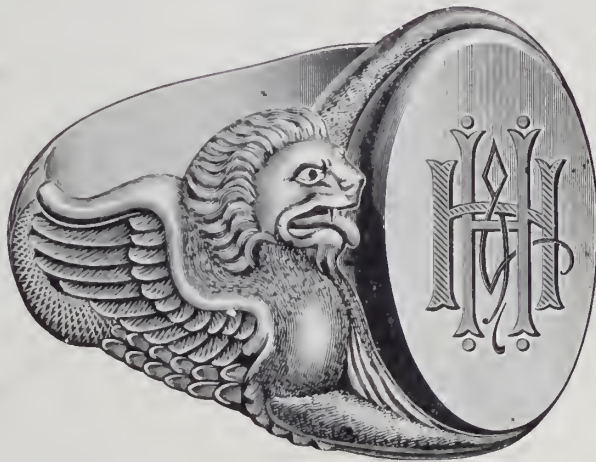

Jobbing  
Trade  
Only.

**FACTORY: PROVIDENCE, R. I.**

**CHICAGO:**

Columbus Building,

**HARRY H. MILLER.**

**NEW YORK:**

**3 MAIDEN LANE.**

# RINGS

We are not the largest producers of Rings  
in our country. We, however, make  
and sell an endless variety of

*Ladies', Misses' and  
Children's Rings*

*AT MODERATE PRICES*

"Orders Prove Our Goods Sell"

**E. L. SPENCER COMPANY,**

*Makers of Gold Jewelry for the Jobbing Trade*

95 Chestnut St., - PROVIDENCE, R. I.

New York Office, - 9-11-13 Maiden Lane.

(SAMPLES ONLY)

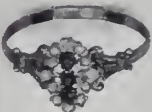



# The "ARMLLET"



F. & B.  
"ARMLLET"  
Secret Joint  
Pat. ~~1911~~  
Size 2 3/8 In.

- |           |                           |                                      |
|-----------|---------------------------|--------------------------------------|
| 474       | 476                       | 477                                  |
| 474 POL.  | 476 Rose Gold Half Chased | 477 Rose Gold, Half Chased, 5 Stones |
| 475 ROM.  | 507 O. E. " "             | 522 O. E. " " 5 "                    |
| 506 O. E. | 530 Rose Gold Full " "    | 546 Rose Gold " " 6 Brillants        |
|           | 538 O. E. " "             |                                      |

Color of stones as ordered, Amethyst, Ruby, Sapphire, Olivene, Topaz, Aquamarine, Almondine, Turquoise and Rose Stones.  
Bracelets made with secret joint and push catch. High-grade Seamless Gold-filled Stock. Each bracelet in fine leatherette covered box.



**BRACELET 473 ROSE.**  
COLOR OF STONES AS ORDERED.

Amethyst, Ruby, Sapphire, Olivene, Topaz, Aquamarine and Turquoise.  
Two of the above Bracelets snapped together, makes a nice dog collar 14 in. long.



Locket  
2825  
Rose



Pin  
3632  
Rose and Green  
Brillants



Pin  
3647 Pearls  
3648 Brillants  
3649 Turquoise



Pin  
3629  
Baroque Pearls  
and Brillants



Locket  
2826  
Rose



Hair Barrette  
3660 Pearls  
3659 Brills.



Cuff Pin  
3624  
Roman



Cuff Pin  
3622  
Roman



Hair Barrette  
3652 Pearls  
3651 Brills.



Hat Pin  
710  
Rose and Green  
Polish Signet

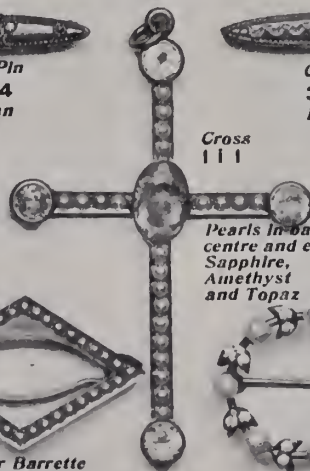

Cross  
111  
Pearls in bars,  
centre and ends.  
Sapphire,  
Amethyst  
and Topaz



Hat Pin  
705  
Rose  
Polish Signet



Links  
751 Rose

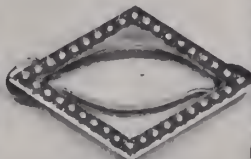

Hair Barrette  
3658 Pearls  
3657 Brillants



Pin  
3603 Baroque Pearls  
and Brillants

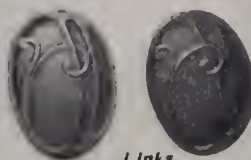

Links  
753 Green  
757 Rose

These are only a few examples of our new goods; see our complete lines.

## Theodore W. Foster & Bro. Co.

MANUFACTURING JEWELERS AND SILVERSMITHS,  
100 Richmond Street, Providence, R. I.

Established 1873.

### See our Lines of Goods for Articles suitable for gifts.

A full line of PHOTO. FRAMES in both Sterling Silver and 14 K. Gold Filled. CROSSES, PENDANTS, NECK CHAINS, LORNETTE CHAINS, LOCKETS, CHARMS, VEST, DICKENS and FOB CHAINS, BRACELETS, PINS, BROOCHES, EARRINGS, LINK BUTTONS, SCARF PINS, HAT PINS, BARRETTE PINS, WAIST SETS, HAIR CHAIN MOUNTINGS, DOG COLLARS and BELT BUCKLES, RIBBON BOOK-MARKS and a large variety of useful

### Sterling Silver Novelties.

MANICURE and TOILET SETS and pieces, also DESK SETS, SEWING SETS, TRAVELING SETS, SHAVING SETS, SMOKING SETS, FLASKS and other goods suitable for gentlemen's use.

Do not fail to order a few of our new bracelets,

"The Armllet"

## Favor Trade School

### Attleboro Jewelry Manufacturers Discuss Suggestion of Industrial Commission That State Found School for Jewelry Working.

ATTLEBORO, Mass., May 2.—The idea of a jewelry trade school for Attleboro has been enthusiastically welcomed by the manufacturers. This proposition is an outgrowth of the suggestion made last year by Gov. William L. Douglas, of Massachusetts, that the State assist each city and large town to open, in addition to its regular public schools, a training school where boys and girls may learn the industry prevailing in the community. Gov. Douglas's idea was to throw open to the young people the industries at their very doors, by giving to the boys and girls the theoretical instruction and practical drill needed to become skilled workers. The governor deplored the effect, while confessing the necessity, of specializing the work in the factories of every industry, holding that before the young worker adopts a specialty he should first learn the industry as a whole, so that later in his specialized work he may show greater intelligence, and so he may be better fit for promotion as occasion arises.

The report of the commission appointed by him to devise a practical system for the whole State found manufacturers and employers all dissatisfied with the boys and girls who come to them from the public schools and eager for young workers with more "industrial intelligence."

THE CIRCULAR-WEEKLY correspondent has interviewed all the leading manufacturers in Attleboro on the subject of the commission's report. He finds every one sympathetic toward the idea of a jewelry trade school in Attleboro. Only one manufacturer took the ground that in his particular line of business he could get along with unskilled help in large numbers. He thought his goods were of so cheap a grade that graduates of a technical school would be no help to him, for the greater part of the work. Even he, however, favored the trade school idea as a whole, and like the rest, thought manufacturers and workers would be benefited, the character of the work would be improved, and no one would suffer in any degree from the change.

At the office of C. H. Eden & Co. the correspondent found Charles H. Eden enthusiastic. "It would be a fine idea," he declared. "I don't see how it could do anything but good." When asked if he was dissatisfied with the help that comes from the public schools, Mr. Eden preferred to let his foreman answer for him. The foreman maintained that he got better work from the boys and girls who left school at the lowest legal age than from those who went through the high school.

This was exactly in line with the finding made by the Governor's Commission, who reported that the business men one and all complained the young workers who received the almost wholly literary education of a public school lacked the intelligence to see beyond the task set before them, back to its origin and ahead toward the finished product, and were therefore unable to harmonize their work to the system, and that the schools had failed to de-

velop, as shop work would have done, that conscience which recognizes the obligation to do as good work as possible for "the house."

At this point Orlando W. Hawkins, of O. W. Hawkins & Co., dropped in on business. Learning the topic under discussion, he exclaimed: "That trade-school idea is O. K." Then he dissented from the views of Mr. Eden's foreman on the subject of the boy and girl with the high-school education. "I would rather have a high-school boy, or one with any good education, every time. The better education, the quicker I want them."

"Have you in your factory now any high school or college boys?" was asked.

"No," he answered. "I can't get any. They want more money than they're worth to start. They aren't willing to begin at the bottom. They want to start right in where their fathers left off."

Louis J. Lamb, of C. H. Allen & Co., while unwilling to discuss the matter in detail until he knew the whole plan, expressed himself vigorously in favor of the general idea. Mr. Lamb, Mr. Eden, and several others interviewed referred to the fine industrial schools of Germany as a good pattern.

William A. Cook, of Fontneau & Cook, said: "Trade schools are a help in any kind of business."

Manager Thompson, at the factory of the Chas. M. Robbins Co., said: "What we need is intelligent help, and it's hard to get them. A trade school would be very beneficial." He held that under present conditions the graduates of the public schools with liberal education make desirable recruits for the office, clerical and selling departments of the jewelry business. He also thought that in many routine departments of factory work there would always be a demand for unskilled help.

James E. Blake, of the James E. Blake Co., silverware makers, declared that trade schools are highly desirable. His words are of special interest because of the fact that when the commission was making its inquiries it found the silversmiths in the whole State were among the most eager for the schools. They claim one and all that there is need of a new generation of workers, trained both in taste and execution, and that the grade of work needs to be elevated.

Mr. Blake pointed out that the graduates of the public schools to-day, so far as the jewelry and silver industries are concerned, are holding subordinate positions, while the boys who have practically learned the trade in the shops are to-day the owners, managers and aggressive leaders. Mr. Blake also paid a high tribute to the work accomplished by the "School of Jewelry Designing" maintained by the Young Men's Christian Association.

Edward A. Sweeney, of the W. H. Wilmarth Co., said that in his particular line the trade school would be of little help, but for the jewelry industry as a whole he heartily favored it. He said that he wanted in his shop boys from 14 to 16, ambitious to learn the practical operations of a factory, rather than public school graduates. His remarks are significant. The commission found the employers all over the State unanimous in the idea that the time when

boys and girls ought to be laying the foundation of their business training is the precious period between 14 and 16.

J. Lyman Sweet, of the R. F. Simmons Co., said that if the jewelry trade school could have the right man at the head it would be a big help to the business. He referred to the improvement in the jewelry work of this district brought about by the graduates trained in the Rhode Island School of Design. He thought if the school could follow such practical lines as that it would be all right. Mr. Sweet said he preferred to hire in workers who had received at least a high-school education. His view on this subject would naturally differ from that of some other employers, because of the high grade of work his factory produces.

Clelland J. McCatchey, of the Horton, Angell Co., was confident it would be a good thing to have the young workers know something of the practical operations before entering the factory.

Charles H. Tappan, of the D. F. Briggs Co., declared emphatically: "It seems to me it would be a fine idea." He joined with the others interviewed in saying that for his own shop he preferred to hire boys who had not received a high-school or college fitting.

Edgar A. Remington, of Carter, Ovarnstrom & Remington, said: "A trade school would be a grand, good thing." He also said that his firm preferred to have its young workers have a high-school education if possible.

Superintendent Amos Blackinton, at the Bates & Bacon factory, would not commit himself on the trade school proposition until he knew the way it was to be run. Like the others, however, he said that high-school and college education on the literary lines they are run to-day were no help to the ambitious jeweler. He said a boy with natural ability would do better to start with practical experience in a factory.

Hon. Sidney O. Bigney, of S. O. Bigney & Co., said: "On the whole it would be a good thing." He wanted to know, however, if the product of the pupils would go into the market in competition with the manufacturers before expressing himself finally. This point is not covered in the bill now pending in the legislature to establish the schools. The State, however, is committed to a certain policy. Massachusetts is already running large industrial schools to teach the textile business in all its forms. The product of the pupils is not allowed to compete with that of the manufacturers whose taxes help support the institution. Mr. Bigney said that there were no positions in his factory for which a young man needed more than a high-school education, as the public schools are maintained to-day.

THE CIRCULAR-WEEKLY's correspondent visited the State's trade school at Fall River to see something of the practical work of such an institution. There are in the schools scores of young men and boys of just the right age to learn rapidly, and no one seeing them could ever forget the keen, earnest, interested, ambitious look on every face. Boys who would have found the literary studies of the high-school utterly dull and an endless bore work like Trojans to master the intricacies of dyeing,

# ACTIVITY

## The Keynote of Our Progress

A series of pictures showing  
various forms of active life.



### JUST OVER

By constant training and endeavor, the pole vaulter—inch by inch—increases the height of his jump. By constantly adding new ideas and patterns to our various lines of rings, we want to merit an increase in our business.

If you will let our salesmen show you our stock of rings—for man, woman and child—you will find many new and attractive patterns in the line. This means we would like more business. May we do it with you?

4  
over  
40  
years  
Ring Makers

Larter & Sons  
21-23  
Maiden Lane  
New York



weaving, designing and the selections of materials for textile goods. In this trade school the young men from the mills can attend out of working hours to fit themselves for promotion, as well as the boys just starting life.

The correspondent also talked with Judge Warren A. Reed, one of the Governor's Commission. "The whole educational system of Massachusetts must be revamped. It is out of date," he asserted. Judge Reed then launched into enthusiastic praise of the work achieved by the Wilmerding and other trade schools of California, where boys enter at 12 and graduate at 16 to 18 with the basis of a technical training that makes them welcome in any trade; not skilled enough to be master workmen, but far better than the raw apprentice; while at the same time they have received all the best features of a high-school literary education.

In the past few years the Attleboro superintendents of schools have repeatedly tried, with some minor success, to introduce courses which would help prepare boys and girls for good places in the jewelry business. The town is in just the right frame of mind to welcome the proposed jewelry trade school.

### A Unique and Magnificent Diamond Collar.

IRRESPECTIVE of its intrinsic value, which is considerable, a diamond collar made recently in Philadelphia, is generally regarded in the trade of that city as a notable piece of jewelry work. It has been fashioned in a most skillful manner for a prominent society woman and the uniqueness of its design, as well as the perfection of its construction, has attracted general attention. The design was suggested to the Philadelphia jewelers by a diamond collar which was presented to the bride of the Crown Prince of Germany at the time of their nuptials, about a year ago.

The scheme is especially well carried out so as to make it a lacework design, light in weight, but strong and durable. The cobwebby effect is offset and adroitly shown by contrast with a ribbonlike piece in front.

Exactly 1,600 diamonds are set in the collar, which is entirely handmade of platinum and iridium and without any gold fortification whatever. On this account alone the piece would be exceptional.

So far as the makers, Coombes & Van Roden, are informed, there has been no such piece ever before made in this country. So delicately have the jewelers fashioned the collar that, although hard as steel, it is remarkably light. It is the originality of design and the extreme refinement of construction which has made the collar one of the most admired pieces worn in Philadelphia.

The eclipse in front supports and holds a forget-me-not design. Especial attention has been paid to the designing of the clasp, so that pressure on the cross top of the bow knot releases the snap and permits the collar to disconnect at the bottom as well.

On the whole, it is admitted by those in the trade here who have examined the piece that it is an improvement on the design which was suggested by the magnificent diamond collar made a wedding gift to the Crown Princess of Germany.

## Silversmiths' Stock Increased.

### Gorham Mfg. Co. Votes in Favor of the New Plan for the Operation of the Several Allied Concerns.

Reference was made in last week's issue to a special meeting of the stockholders called by the Gorham Mfg. Co., to be held at the office of the company May 1, the purpose being explained in the call as follows:

"To make such changes in the charter and by-laws, or either of the Silversmiths' Co., a New York corporation, as they may see fit, including any increase in the authorized capital stock thereof; to cause the capital stock of the said Silversmiths' Co., including its increase or any part thereof, to be issued, sold, exchanged or otherwise disposed of, for a value not less than par.

"Also to sell, exchange or otherwise dispose of all or any part of the capital stock and assets, or either, of any corporation or corporations owned or controlled by the Gorham Mfg. Co. at a price not less than the cost thereof to date of sale, upon such terms and conditions as they may see fit.

"To do all things necessary or proper to effect the foregoing purposes."

The meeting was held in accordance with the call, and a resolution providing for an increase in capital stock of the Silversmiths' Co. was adopted by the following vote: Ayes, 32,265; nays, 3,251; not voting, 271.

President Edward Holbrook gave the following statement to THE CIRCULAR—WEEKLY:

"The Silversmiths' Co., a corporation organized under the laws of the State of New York, is now wholly owned by the Gorham Mfg. Co. and conducts a manufacturing business in New York City.

"It is proposed to enlarge the capital stock of this company, issuing at the present time \$7,000,000, of which \$1,750,000 will be offered for subscription at par to the present stockholders of the Gorham Mfg. Co., preferred and common. The proceeds of the sale of this stock will provide a sufficient cash capital to enable the Silversmiths' Co. to purchase the stocks of the Whiting Mfg. Co. and the stocks of the William B. Durgin Co., now held by the Gorham Mfg. Co.

"The remainder of the said issue will be offered in exchange for the common stock of the Gorham Mfg. Co., the holders of such common stock having the option of making the exchange. It is expected that a large number of them will avail themselves of the opportunity to exchange their stock under this option.

"The financial feature is, however, only a part of the plan which is further intended to offer a better method for the operation of the various companies by forming a separate organization for supervising the various plants and the commercial departments of the allied companies.

"This plan leaves the organization of the Gorham Mfg. Co. free to devote all of its energies to the business of that company, providing, however, for a central control that will be exercised over the entire business.

"It is believed that such authority will be effective in preserving harmonious work-

ing relations, securing to each company, so far as possible, all the advantages in management that may be possessed by any one of the companies.

"This plan was submitted to the stockholders for their consideration, that they might take such action as to them seemed desirable, and inasmuch as they voted to adopt the necessary resolutions and to make this plan effective, every stockholder has the right to exercise or not the privilege and subscribe to the shares of the Silversmiths' Co. stock that are to be sold for cash, which they are entitled to as stockholders of the Gorham Mfg. Co.

"The holders of the common stock of the Gorham Mfg. Co. have the further option of making an exchange and should they decide not to make exchange of their Gorham Mfg. Co. common stock for the Silversmiths' Co. stock on the terms of the exchange, their interest will remain in the Gorham Mfg. Co. exactly as before."

### Jewelry, Clocks, Watches, Silverware and Kindred Lines Exported from New York.

WASHINGTON, D. C., May 2.—The following were the exports of jewelry, silverware and optical goods, clocks, watches and kindred lines from the Port of New York, for the week just ended:

- Algoa Bay: 72 packages clocks, \$1,353.
- Amapala: 3 packages plated ware, \$275; 4 packages cutlery, \$103.
- Antwerp: 1 package optical goods, \$260.
- Auckland: 6 packages cutlery, \$158; 3 packages plated ware, \$249; 60 packages clocks, \$979.
- Bombay: 15 packages clocks, \$320; 6 packages plated ware, \$679; 22 packages clocks, \$197.
- Bremen: 2 packages plated ware, \$200.
- Calcutta: 36 packages clocks, \$1,668; 26 packages plated ware, \$3,020; 2 packages jewelry, \$1,818.
- Colon: 5 packages watches, \$107.
- Durban: 1 package watches, \$500.
- Glasgow: 18 packages clocks, \$157.
- Guayaquil: 6 packages watchmaking machinery, \$1,105.
- Hamburg: 1 package watches, \$1,408; 4 packages optical goods, \$110.
- Havana: 7 packages plated ware, \$683; 3 packages thermometers, \$272; 4 packages jewelry, \$211; 5 packages cutlery, \$310.
- Havre: 9 packages jewelry, \$440; 2,406 pieces nickel, \$43,500.
- Liverpool: 1 package plated ware, \$208; 71 packages clocks, \$763; 6 packages stereoscopes, \$175; 3 packages stereoscopes, \$375; 1 package jewelry, \$1,000; 6 packages cutlery, \$351.
- London: 93 packages clocks, \$2,034; 1 package optical goods, \$250; 2 packages plated ware, \$135; 1 package clocks, \$130; 4 packages scopes and views, \$906; 22 packages optical goods, \$3,522; 6 packages clocks, \$450; 21 packages cutlery, \$336.
- Lishon: 43 packages clocks, \$471.
- Matanzas: 12 packages clocks, \$110.
- Melbourne: 29 packages clocks, \$478; 14 packages plated ware, \$2,155.
- Naples: 1 package jewelry, \$500.
- Para: 45 packages clocks, \$682; 10 packages cutlery, \$648; 2 packages jewelry, \$216.
- Panama: 3 packages plated ware, \$111; 1 package thermometers, \$350; 7 packages clocks, \$139; 3 packages watches, \$200.
- Progresso: 9 packages clocks, \$140.
- Rio de Janeiro: 7 packages cutlery, \$357; 2 packages plated ware, \$433; 1 package jewelry, \$719.
- Savanilla: 1 package cutlery, \$152; 3 packages stereoscopes, \$141.
- Shanghai: 141 packages clocks, \$2,946.
- Singapore: 9 packages plated ware, \$976.
- Southampton: 1 package jewelers' findings, \$132; 1 package watches, \$420; 1 package cutlery, \$550.
- St. John: 3 packages watches, \$299; 43 packages clocks, \$490.
- Sydney: 23 packages clocks, \$450; 14 packages plated ware, \$3,202; 4 packages cutlery, \$181.
- Vera Cruz: 8 packages plated ware, \$487; 1 package silverware, \$275; 3 packages cutlery, \$113; 27 packages clocks, \$546.
- Wellington: 17 packages clocks, \$158.

### General Appraisers Render Decision as to Duty on Steel Watch Chains.

In a decision announced last week by the Board of United States General Appraisers, New York, a ruling was made in relation to the duty on watch chains made of steel. The case came in the form of a protest by A. Strauss & Co. against the assessment of duty by the Collector at New York. The Board divided the articles into two classes and sustained the protest in part. Under the decision, when the chains are of the usual lengths and fashioned for utility, they are dutiable as manufactures of metal. On the other hand, chains that are shorter than the usual length and suitable for any other use than the amusement of children are held to be dutiable as toys.

The opinion, written by General Appraiser Fischer, says:

The merchandise consists of steel watch chains, upon which duty was assessed at the rate of 45 per cent. ad valorem under the provisions of Par. 193 of the Tariff Act of 1897. A large number of claims appear in the protests, but the only one pressed is that the goods are dutiable properly at 35 per cent. under Par. 418 of said act as toys.

At the several hearings on these protests, much testimony and some representative samples of the goods were admitted. The testimony offered to show that the chains are commercially recognized as toys was contradicted by a member of a domestic firm dealing in domestic goods of this character, as well as by a catalogue which showed that the chains are used by adults, as watch chains ordinarily are, in the carrying of cheap watches, and it falls short of substantiating the claim of the importers.

From an examination of the samples we find that items 4355 on protests 167809, 175486 and 176038 are chains provided with a bar and snap, but much shorter than the usual chain, so flimsy in character that the sample broke under a moderate pull, and obviously unfit for use except as playthings; that items 4836, protest 167809, and 5143, protests 171091 and 175486, are vest chains of the usual size, with a bar, snap and charm, and, though of cheap construction, are undoubted articles of utility and not mere playthings; that item 1, protest 170176, is a fully finished fob chain, to which the same observations apply, and that item 19, protests 178932-3, is a gilded chain exactly like that which was held in Abstract 7866 (T. D. 26682) to be dutiable as manufactures of metal.

In accordance with these findings, we sustain the claim under Par. 418 in protests 167809, 175486 and 176038, as to item 4355, and we modify the decisions of the Collector to that extent. The remaining items represent chains that are articles of utility and not toys, and as to them and to all other items not herein specifically allowed, the protests are overruled and the decisions of the Collector thereon affirmed.

There is judicial authority for this ruling in the case of *Veil v. United States* (128 Fed. Rep., 471; T. D. 25007), wherein watch guards made of leather mounted with cheap iron bits, spring loops and stirrups in imitation of harness, bridle and saddlery materials, were held to be dutiable as manufactures of leather. Those articles and the goods now before us are of the same character, use and general make-up.

F. S. Taylor & Co., Leavenworth, Wash., have sold out to J. W. Elliot & Co.

The Geo. W. Meyer Jewelry Co., Chattanooga, Tenn., has been appointed official timekeeper of the Nashville, Chattanooga & St. Louis Railroad. The concern has been timekeeper for all the other railroads entering Chattanooga for some time past.

A warrant was issued recently for the arrest of William Oldknow, of Atlanta, Ga., by A. L. Delkin, a former jeweler of that place, who accused Oldknow of assault and battery. Delkin and Oldknow became involved in a row which resulted in a free-handed fight. Both participants were badly bruised.

# HAYDEN W. WHEELER & Co.



## MOUNTED DIAMONDS

**O**UR stock of Mounted Diamonds contains the Latest and Newest Designs. Made from best Selected Material. Finest Hand Made Mountings. Quality, Style and Lowest Price consistent with this standard.

AMSTERDAM  
2 TULP STRAAT

BROOCHES, RINGS, SCARF PINS, BRACELETS, ETC.



LONDON  
50 HOLBORN VIADUCT

2 MAIDEN LANE, NEW YORK

TELEPHONE  
7365 CORTLANDT

ORDER

# DIAMONDS

ON MEMORANDUM FROM

## ALFRED H. SMITH & CO.

170 BROADWAY, NEW YORK.  
Corner Maiden Lane.

London,  
6 Holborn Viaduct.

Chicago,  
103 State Street.

## Oppenheimer Bros. & Veith.

Cutters of Diamonds,

65 NASSAU ST. (PRESCOTT BUILDING), NEW YORK.

AMSTERDAM,  
2 Tulp Straat

LONDON,  
40 Holborn Viaduct.

CUTTING WORKS,  
Cor. Union & Nevins Sts., Brooklyn

## HENRY E. OPPENHEIMER & CO.,

51 Holborn Viaduct, London.  
50 Rue de Chateaudun, Paris.  
7 Place Loos, Antwerp.

Tel. 621 Cortlandt

3 MAIDEN LANE, NEW YORK.

DIAMONDS, PEARLS AND PRECIOUS STONES.

MEMORANDUM ORDERS SOLICITED.



**Death of Albert Wiggers.**

The New York jewelry trade lost one of its oldest jewelry box and case makers last week, when Albert Wiggers, for many years head of the old firm of Wiggers & Froelick, passed away at the Flower Hospital, Manhattan, after an operation. Mr. Wiggers, though ill for some time past, was not considered seriously sick until his trouble took an acute turn while he was on a trip to Barbadoes, last February. He grew worse and three weeks ago took to his bed and specialists were consulted. On the advice of the doctors an operation was performed at the Flower Hospital, but his heart being weak, Mr. Wiggers was unable to withstand



THE LATE ALBERT WIGGERS.

the effects and passed away Monday, April 30.

Mr. Wiggers was a native of North Germany, and was 69 years old April 15 last. He came to this country when 14 years old and first learned the piano trade and later entered the jewelry case manufacturing business, starting in 1863 as a partner of a Mr. Hess, at 60 Nassau St., at which location the business has remained continuously to the present time. After being associated with Mr. Hess for two years he bought out the latter's interest, continuing alone until in 1869 he formed a partnership with Mr. Froelick, who had been his friend from boyhood, and the two remained together in business until 1895, at which time Mr. Froelick retired. The deceased and his son, Albert Wiggers, Jr., then continued under the old partnership name and two years ago the business was incorporated, although retaining the old firm style, Albert Wiggers, Jr., becoming president and treasurer; the deceased, vice-president, and John Gamundt, the secretary of the concern.

For the past 37 years Mr. Wiggers had been a resident of West Hoboken, N. J., and had been prominently identified with the work of building up that town. Not only was he among its most public spirited citizens, but he also took an active part in politics, and held many offices, among others those of Town Councilman, Police Commissioner and Mayor. He was one of the organizers of a "committee of 100" for the improvement of West Hoboken, and to his

energy and ability was due much that this committee accomplished. Outside the jewelry trade he was connected indirectly with other industries; he was a director and organizer of the Highland Trust Co., a stockholder of the Maiden Lane Safe Deposit Co. and of the Astoria Realty Co., and a charter member of the New York Turnverein. In the jewelry trade, although actively connected with none of the associations, he was well known as one of its pioneer case makers, and it was in his firm that many of the present manufacturers of jewelry cases and boxes served their apprenticeship.

Mr. Wiggers was married Nov. 10, 1866, to Eleanor Merle, and she survives him, as well as one son, Albert Wiggers, Jr., three daughters, Mrs. W. Reid, Mrs. Charles Cellard and Mrs. Charles W. Edwards, and three grandchildren. The funeral services, which took place at his residence, 192 Palisade Ave., West Hoboken, were largely attended. The remains were interred temporarily at Fair View Cemetery.

**Death of David B. Lincoln.**

AURORA, Ill., May 2.—The funeral of David B. Lincoln, for many years superintendent of the Aurora Silver Plate Co., was held Monday in the First Presbyterian Church, the services being in charge of Post No. 20, G. A. R., of which the deceased was a past commander. Mr. Lincoln died at his home, 114 N. View St., early Saturday morning, of heart failure. He had been ill since last November.

The deceased was born in Taunton, Mass., Jan. 26, 1844, and spent his boyhood at the farm of his father. At the breaking out of the Civil War he enlisted in the 33d Massachusetts Volunteer Regiment, serving until the close of the hostilities. He then entered the silver plate business in his native town and continued in that line until his death. At one time he was foreman of a Taunton concern, and after four years there went to New York, starting in business for himself in that city, where he remained a number of years. In 1886 he came to Aurora and accepted the superintendency of the Aurora Silver Plate Co., a position which he held continuously until last Fall.

Mr. Lincoln was a prominent citizen of Aurora, was widely known and respected, and his death is mourned by a large circle of friends and acquaintances. He was especially prominent in G. A. R. circles and in a number of fraternities and societies. Among other positions he held were those of past chancellor of Charlemagne Lodge No. 245, Knights of Pythias, and lieutenant-colonel of the fifth regiment of the same lodge. He is survived by a widow and three children—a son, Percy G. Lincoln, and two daughters, Mrs. A. H. McLaughlin and Mrs. M. D. Jones.

**Statistics of the Silver and Brass Industries of Connecticut.**

An output of millions of dollars worth of goods each year is shown by a report given to the public by the Connecticut State Bureau of Labor Statistics, William H. Scoville, commissioner. Two of the sections of the report treat of the silver and plated ware industry and brass industry. The re-

port explains that none of its figures are as large as might be, because of the failure of a few concerns to send their data. These interesting statistics appear:

	Brass goods.	Silver goods.
Establishments .....	94	32
Average persons employed .....	27,329	5,394
Average days in operation .....	297.9	295.3
Average annual earnings per employe.....	\$515.64	\$533.37
Amount paid in wages..	14,171,411	2,815,805
Gross value of product..	63,395,973	10,151,750

**General Appraisers Render New Decisions as to Real and Imitation Pearls.**

In a decision by T. S. Sharretts the Board of United States General Appraisers sustained last week a protest filed by J. M. Colton, of New York, regarding the customs classification of a valuable string of pearls assessed by Collector Stranahan as "jewelry" at the rate of 60 per cent. ad valorem.

The Board classified the imports as pearls in their natural condition, dutiable at 10 per cent. General Appraiser Sharretts in his opinion said:

"The merchandise under protest consists of a string of pearls graduated and matched as to size, shape and luster, but without metal attachments. These pearls were assembled with reference to color, size and quality and the assortment and selection are similar to the collection found in the articles of jewelry known as necklaces or strung pearls, and return was made at 60 per cent. under Par. 434, Act of 1897.

"The pearls in dispute were exhibited to the Board at the hearing in the case at Philadelphia, based upon which we find they were temporarily strung on cotton cords for preservation only, and not strung as jewelry. See G. A. 5892 (T. D. 25996).

"Reference is made by the appraiser to *Tiffany v. United States* (103 Fed. Rep., 609), but that decision was reversed in principle by the Circuit Court of Appeals, Second Circuit (112 Fed. Rep., 672), which reversed the Circuit Court for the Southern District of New York (105 Fed. Rep., 766). The goods now before us fall directly within the ruling of the Circuit Court of Appeals, Second Circuit, in the case of *Neresheimer v. United States* (T. D. 25676), based upon which decision and the others cited we sustain the claim in the protest that said goods are dutiable either directly or by similitude at 10 per cent. ad valorem under Par. 436 of the Tariff Act of 1897, the Collector's decision being reversed."

In another decision by Mr. Sharretts the Board sustained in part a protest filed by Benedict & Warner, New York, regarding the rate of duty applicable to imitation pearls. The decision follows: "We find the merchandise to be imitation pearls assessed with duty at 45 per cent. ad valorem under Par. 112, and claimed to be dutiable at 20 per cent. ad valorem under Par. 435 of the present Tariff Act. On the authority of G. A. 6088 (T. D. 26554) we sustain the protest so far as it relates to said merchandise which is marked (B. W.) on the invoice for identification, to which extent the Collector's decision is reversed."

Narval Babb, Stratford, Ont., is about to move his stock into larger and newly furnished quarters.



**AMETHYST**

In Siberian, Brazilian and D'Auvergne qualities, in all shapes and sizes. Golden and Madeira topaz. Half, round and bouton pearls. Reconstructed rubies, opals, garnets, and doublets in the fancy colors and fancy shapes—uniform grades, especially selected for the American Market.

*L. Heller & Son*

Importers of Precious and Imitation Stones.

New York, 51 Maiden Lane  
Paris, 5 Cite Trevisé

Providence, 212 Union Street  
Idar, 14 Hauptstrasse

TELEPHONE 219 JOHN.

GEORGE H. HODENPYL.

WALTER N. WALKER.

**DIAMONDS**

AND

DIAMOND JEWELRY

**HODENPYL & WALKER**

Unique  
and  
Staple Patterns

**170 Broadway, New York**  
Corner of Maiden Lane  
**TELEPHONE, 1898 CORTLAND**

Repairing and Recutting  
Diamonds  
a Specialty

<p>OUR <b>40th</b> YEAR</p> <p>IN BUSINESS</p> <p>1866-1906</p>	<p><b>DIAMONDS</b> LOOSE AND MOUNTED</p>	<p><b>CASES and MOVEMENTS</b> ALL MAKES AND GRADES</p>	<p><b>JEWELRY</b> GOLD AND PLATED</p>
<p>ORDERS SOLICITED FROM RESPONSIBLE JEWELERS.      GOODS SENT ON SELECTION.</p> <p>All our goods are either direct importations, our own manufacture or bought for cash, enabling us to offer special inducements in prices and terms.</p>			
		<p>EST. 1866.</p> <p><i>Lissauer &amp; Company</i></p> <p>Importers.</p> <p>2 TULPSTRAAT, AMSTERDAM.</p>	<p>12 MAIDEN LANE, (ONE FLIGHT UP)</p> <p>P. O. Box, 1625, <b>NEW YORK.</b></p>

**JOBGING STONES**      IMITATION and GENUINE

ORDERS OF ALL SIZES SOLICITED.

**MARTIN LOW & TAUSSIG,**

51 Maiden Lane, New York.      139 Mathewson St., Providence, R. I.  
Telephone, 2817-John.      Telephone, 3037-Union.

**MEYEROWITZ BROS.,**

IMPORTERS OF **DIAMONDS,**      37-39 MAIDEN LANE,  
NEW YORK CITY

A Complete Line of Precious, Semi-Precious and Imitation Stones. Mail orders promptly attended to.

## Rhode Island's Great Industry.

### Interesting Census Report on the Jewelry and Silver Trade of Providence.

WASHINGTON, D. C., May 4. The jewelry trade is fourth of the large industries of Rhode Island and the capital has been increased from \$8,787,502 to \$11,199,233 in 1905, while the number of establishments have been reduced from 210 to 197 in the same period of time. The average number of wage-earners has been reduced from 7,102 to 6,175, while their wages have been increased from \$3,145,557 to \$3,365,274; the cost of materials used has increased from \$6,176,854 to \$6,657,584, and the value of the output from \$13,229,313 to \$14,431,756. In addition to this there are also in the State 10 establishments for the refining of gold and silver.

In 1900 there were in the State four silversmithing establishments and eight silverware plants; this number has been reduced to 10; the capital stock, however, has been increased from \$5,199,284 to \$8,582,489; the number of employes has been increased from 1,815, earning \$1,099,612, to 1,919, earning \$1,439,688; the value of the output has been increased from \$4,249,190 to \$5,323,261.

In value of products for the manufacture of jewelry Rhode Island led all other States and territories in the United States in 1905. Gold and silver, reducing and refining, not from the ore, and silversmithing and silverware are two important industries that are closely allied to the manufacture of jewelry.

As compared with the totals for the State, the three industries, jewelry, gold and silver reducing and refining, and silversmithing and silverware combined, gave employment to 8,471 persons in 1905, or 8.7 per cent. of the total number of wage-earners in the State; their wages amounted to \$4,859,771 or 11.3 per cent. of the total wages paid, and the output at \$24,015,718 was 11.9 per cent. of the State's total.

Of the jewelry firms 76, or 38.6 per cent. are under individual ownership, with capital amounting to \$1,725,244; 1,526 wage-earners are paid \$696,269, the cost of materials used, \$1,207,103, 18.1 per cent. of the total, and the output, \$2,759,694, or 19.1 per cent.

Sixty-nine firms control capital amounting to \$2,979,601, employ 2,163 persons, who earn \$1,161,490, and have an output amounting to \$4,268,163, or 29.6 per cent.

Fifty-two incorporated companies are 26.4 per cent. of the total establishments, they have invested \$6,494,388, or 58 per cent.; give employment to 2,786 persons, or 43 per cent. of the total number, to whom is paid \$1,507,515, or 44.8 per cent.; the cost of materials is \$3,641,108, or 54.7 per cent., and the value of the products, \$7,403,899, or 51.3 per cent.

Of the silversmithing and silverware establishments four are firms and six are incorporated companies; for the former the invested capital is placed at \$72,678, and for the latter \$8,509,811, or 99.2 per cent. of the total; the number of employes are 68 and 1,851 respectively, and the wages \$1,409,04 and \$30,644; the cost of the material used by the four firms is \$48,428, or

two per cent., and for the corporations \$2,371,933. The value of the products turned out by the four firms is \$120,381, or 2.3 per cent., and for the companies \$5,202,883.

Of the jewelry firms, 16 have an output valued at less than \$5,000, their total output being \$618,930; 18 have outputs between \$5,000 and \$20,000, the aggregate being \$516,172; 86 are between \$20,000 and \$100,000, total, \$3,846,761, and 17 between \$100,000 and \$1,000,000, of which one firm is capitalized at an excess of a million, the total output being \$10,919,890.

Of the silversmithing and silverware establishments, five have outputs ranging between \$20,000 and \$100,000, the total being \$171,877, with a like number between \$100,000 and \$1,000,000, with one of the five having an output of more than \$1,000,000, the total being \$5,118,387.

Taking the specified industries of the State we find nine electroplating establishments with a capital amounting to \$21,888, under the control of 10 persons, having on the payrolls five salaried employes who receive \$3,930, and in addition 18 employes who receive \$20,943; of that number 10 are men who receive \$18,847; four women receive \$1,377, and four children under 16 years of age, \$719; the miscellaneous expense is \$1,235, and the cost of materials \$16,692, with an annual output of \$67,480.

Twenty-four establishments are engaged in the manufacture of enameling and the manufacture of enameled goods, with a total capital of \$192,635, under the management of 17 persons, having on their payrolls 18 salaried employes who receive \$16,008; and in addition 385 wage-earners who receive \$157,581; of that number 234 are men who receive \$115,260; 132 women receive \$38,479, and 19 children, \$3,842. The miscellaneous expense is \$45,437, cost of materials used, \$62,495, and the total output, \$338,392.

The 10 gold and silver reduction and refining plants have a total capital of \$598,739, of which \$36,820 is in lands, \$37,560 in buildings, \$48,097 in machinery and tools, and the balance in cash and sundries. The total number of firm members is 16, and in addition to this there are on the pay rolls 27 salaried employes who receive \$29,288, and 77 wage-earners who receive \$54,809. Of that number all are men. The total amount expended under the heading of miscellaneous is \$66,941, and the cost of materials used to \$3,987,262, and the total output is reported at \$4,260,698.

Of the total \$11,199,233 invested in the 197 jewelry establishments, \$98,600 is in land, \$327,925 in buildings, \$1,988,254 in machinery and tools, and the balance, \$8,785,054 in cash and sundries. Two hundred and thirty-three persons are interested in the management of these firms, and on the pay-rolls are carried 799 salaried employes who receive \$918,569 annually; in addition to these employment is furnished to 6,475 persons at a total wage of \$3,365,274; of that number and amount 4,140 are men to whom is paid \$2,616,580; 2,251 women receive \$732,891, and 84 children receive \$15,803. The item of miscellaneous expense amounts to \$1,142,636, and of that amount \$166,145 is for rent of works, \$16,392 for taxes, \$872,920 for rent of works, interest, etc., and the remainder, \$87,179

for contract work. The total cost of materials used is \$6,657,584, and of that amount \$78,422 is for fuel and rent of power and heat. The total value of the output is \$11,431,756.

Turning our attention to the 10 silversmithing and silverplating establishments, with their total capital of \$8,582,489, we find that \$182,519 is invested in land, \$1,549,222 represents the value of the buildings, \$1,292,004 is in machinery and tools, and the balance in cash and sundries. Interested in the management of these establishments are nine persons, and on the payrolls are 139 salaried employes who receive \$171,368; in addition to this employment is furnished to 1,919 employes, who receive \$1,139,688, and of that number 1,707 are men and receive \$1,357,357; 196 women are paid \$79,844, and 16 children, \$2,487. The total miscellaneous expense is placed at \$379,822, of which \$8,634 is for rent of works, \$11,967 for taxes, \$358,781 for rent of offices, interest, etc., and \$440 for contract work; the total cost of materials used is \$2,423,361, of which \$34,907 is for rent of fuel, etc. The total value of the output is \$5,323,261.

In addition to the industries named there are also in the State one clock factory, one for manufacturing cutlery, one for the manufacture of jewelry cases, two lapidary works, two for optical goods, one for gold pens, one for plated ware.

Pawtucket has four of the jewelry establishments, Providence contains eight of the electroplating works, all of the establishments for enameling, all of the gold and silver refining and reduction works, 193 of the jewelry establishments, and all the silversmithing and silverplating works, the establishments for the manufacturing of jewelry cases, and two lapidary works, also the gold pen, and the plating establishment.

### Proceedings Against McKay Co. Washington, D. C., Settled and Receiver Discharged.

WASHINGTON, D. C., May 3.—In the case of Louis Costaggini against John F. McKay and the McKay Co., jewelers, the Equity Court has dissolved the temporary injunction issued April 20, and has discharged and vacated the rule to show cause. This action was taken by the court upon the representations of counsel for the parties involved that the question at issue should be disposed of out of court, so as to save the business of the McKay Co. from destruction. It seems that a friendly adjustment has been perfected among the parties to the suit, and this being the case the court has ordered James S. Easby-Smith, the receiver appointed by the court, to return to the defendants all the books, papers and assets which were taken into his possession as receiver.

The McKay Co. has given a deed of trust chattel to William M. Offley and Robert P. Shealey to secure Meyer B. Newman in the sum of \$950. The chattels are located in the McKay jewelry store at 1115 F St., N. W.

The Watson Drug Co. has succeeded to the business of Leon V. Officer, Atoka, Ind. Ter.

# Chester Billings & Son

1840

Successors to  
Kandel, Barmore & Billings

1906

Importers of Diamonds  
Other Precious Stones, and  
Pearls, Diamond Jewelry

1840, Kandel & Barmore; 1866, Kandel, Barmore & Co.; 1880, Kandel, Barmore & Billings; 1897, Chester Billings & Son

New York, 58 Nassau Street, 29 Maiden Lane  
London: 22 Holborn Viaduct, E. C. Paris: 53 Rue de Chateaudun  
Amsterdam: 2 Tulp Straat

## SAM'L BUCKLEY & CO.

English Fancy Goods.



Carry in New York a full line of

### ENGLISH PLATED WAITERS.

118-122 Holborn, E. C.,  
London, England.

100 William St., New York.

## WONDERS NEVER CEASE

The New Cooper Diamond  
Has 100 Per Cent.

More Brilliancy Than Any Other Diamond.

Call and be convinced. Estimates furnished for recutting under our patents. Any infringement will be prosecuted.

### COOPER DIAMOND CO.,

Cutting and Polishing Industry  
of America.

47-49 MAIDEN LANE, NEW YORK.

### REMOVAL NOTICE!

## THE LYONS GEM CO.,

Have Removed to

35 Maiden Lane, New York.

A FULL AND COMPLETE LINE OF PRECIOUS,  
SEMI-PRECIOUS AND IMITATION  
STONES ALWAYS IN STOCK.

Our Specialty is Scientific Rubies.

Local and out of town jobs promptly attended to at reasonable prices. Send us your mountings to be set with matched stones. A trial order will convince you that our prices are right, and our goods select.

### ALLOW ME TO CALL ON YOU IN THIS WAY.

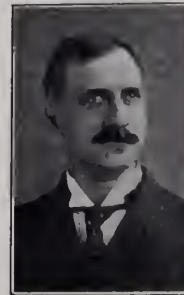

CASSIUS W. SEYMOUR,  
37-39 Maiden Lane, N.Y.

Jewelers' Stationer  
and Printer.  
Jewelers' Cards,  
Tissue Paper,  
Tags,  
Blank Books, etc.  
ROLL AND FLAT PAPERS.

Estimates cheerfully given. Mail orders promptly attended to. Let us quote you our prices on manifold books and sealing wax.

**STUDY** THE ORIGINAL SCHOOL. Instruction by mail adapted to everyone. Recognized by courts and educators. Experienced and competent instructors. Tuition spare time only. Three courses—Preparatory, Business, College. Prepares for practice. Will better your condition and prospects in business. Students and graduates everywhere. Full particulars and special offer FREE.

**LAW**

**AT**

**HOME**

THE SPRAGUE  
CORRESPONDENCE  
SCHOOL OF LAW,  
733 MAJESTIC BLDG.  
DETROIT, MICH.



TRADE-MARK.

## AZTEC TURQUOISES

Mines: MINERAL PARK, ARIZONA.



TRADE-MARK.

Of true CERULEAN BLUE, the rarest and most fashionable shade. Turquoises bearing Company's trade-mark are GUARANTEED. A new Turquoise will be given without question to replace any that discolors. The leading Jewelers of the World sell AZTEC TURQUOISES.

## THE AZTEC TURQUOISE COMPANY,

12-16 JOHN STREET, NEW YORK.

THE BOSTON DIAMOND HOUSE

## JOHN B. HUMPHREY CO.

387 Washington St., Boston, Mass.

We are receiving Monthly Shipments of Diamonds from our Brazilian Mines, which are on exhibition at our Boston Office.

Cutters of  
DIAMONDS

Cutters of  
DIAMONDS

**San Francisco Jewelers Resuming Business.**

**Temporary Quarters Opened at Oakland and in the Stricken City—Details as to Present Conditions Told in Interviews and Letters.**

SAN FRANCISCO, Cal., May 2.—The jewelry business in Oakland and this city is rapidly getting into definite shape, and a number of the more prominent firms have already resumed to a greater or less extent. Several of the leading retailers are arranging to open temporary stores in the new retail district of San Francisco, which extends along Fillmore St. and Van Ness Ave. The uncertainty as to just what part of the reconstructed city will be the best retail locality has so far prevented any permanent arrangements by the retailers. The wholesalers have, generally speaking, arranged for suitable warerooms and offices in Oakland, and will continue to conduct their business from that city until suitable quar-

ters in good shape, will be reconstructed at once.

Manager Melrose, of the W. K. Vanderslice Co., states that no definite arrangements for a location have yet been made, although the company will most certainly re-enter the retail trade at an early date.

The various Chinese jewelers, formerly located along Kearny and adjacent streets, have been busy this week securing permits and searching in the ruins of their stores for any property which may have survived.

Hammersmith & Field, formerly in business on Kearny St., are still conducting business at their temporary office in Oakland and have not yet decided on a location for their new store in San Francisco.



HOW THE SHREVE BUILDING NOW LOOKS, WITH ITS WALLS AND FLOORS STILL IN GOOD STATE OF PRESERVATION.

ters can be secured in San Francisco. A number of the stores are counting on remaining in Oakland for from four to 12 months.

A. I. Hall & Son, who have temporary offices at 113 Broadway, Oakland, and at 2443 Vallejo St., this city, started one man on the road, last week, with a full line of samples. Some stock has already been received, and more is on the road. L. A. Smith, representing the same house, will cover some of the principal points in his territory, and other travelers will be put out within the next 30 days, who will book orders from the catalogue for delivery from the factory, though it is hoped that delivery can be made from stock very soon.

Shreve & Co. opened a temporary office and salesroom at 2429 Jackson St., here, May 1, and are already doing business in a small way. The new Shreve building, at the corner of Grant Ave. and Post St., the framework, walls and floors of which are

In addition to the firms which secured temporary offices last week the following have now arranged for temporary offices: California Jewelry Co., corner of 14th St. and Broadway, Oakland; W. K. Vanderslice Co., 1551 Devisadero St., San Francisco; Phelps & Adams, 1103½ Broadway, Oakland; the Bohm-Bristol Co., 2506 Fruitvale Ave., Fruitvale; Gorham Mfg. Co., 1103½ Broadway, Oakland; Baldwin Jewelry Co., 1521 Sutter St., San Francisco; Radke & Co., 1198 McAllister St., San Francisco; Diamond Parlor Jewelry Co., 1461 Steiner St., San Francisco.

The military authorities here report that the safe of a jeweler named Less, formerly in business on Kearny St., has been broken and that the military under Col. Maus had rescued the contents from the looters. Thieves have been busy in the former retail jewelry district ever since the ruins cooled, and a number have been caught red-handed. The authorities have not decided to drive

off all relic seekers and sightseers from this section.

2778 PINE ST.,

SAN FRANCISCO, Cal., May 2, 1906.

Editor THE JEWELERS' CIRCULAR—WEEKLY:

During and after the days following the fire, it was given out by local papers that all letters would be forwarded without stamps, owing to lack of same here. Many letters in answer to inquiries from New York and eastern jewelry firms were, therefore, forwarded without stamps and, after being retained by the postal authorities here, were returned to writers after five or seven days. This will explain to a great many houses the seeming neglect on the part of their San Francisco houses to answer letters promptly.

Our entire business center and, without exception, the whole jewelry district, both wholesale and retail, is completely destroyed by fire. Many were fortunate enough to rescue all or part of their stock. The feeling is that for the balance of the year there will be no business. But we are optimistic in being sure that 1907 will bring a very great boom in our line and that the setback will be for a short time only.

Excuse writing, as typewriter and all other tools were destroyed in the great fire. Kindly publish all or any part of this and oblige many old subscribers, and especially

Yours sincerely,

MAX ABRAHAMS.

Formerly 126 Kearny St.

J. C. Blythe, the San Francisco representative of Joseph Fahys & Co., arrived in New York in the early part of last week and remained two or three days, during which time he gave to the members of the company a vivid account of the calamity. On the morning of the earthquake he hurried to the office at 126 Kearny St. When the fire threatened the building he decided to remove the books and insurance policies. Because of the disturbed condition of the city, the disposition of the stock of gold and filled cases, valued at \$20,000, presented to him a difficult problem for solution. He realized that if he attempted to carry the cases away, with what assistance he could get, there was danger of the stock being separated from him. It then seemed possible that lawless elements might take advantage of the circumstances to rob. Citizens were already being impressed for work in fighting the flames. He concluded to leave the cases in the safes.

The insurance policies he kept in his pockets and the books he placed in his house. Later the soldiers blew up his home, so that the books were destroyed.

He spent two days and two nights sleeping out, not trying to get to Oakland at first, because he knew if he went there he could not get back. Having ascertained that the building in which the office was located had been destroyed by the fire and that nothing could be done for the present in reaching the safes, he came on to New York, so as to notify the company of all that had happened. When he left San Francisco the military had not yet permitted any examination of the ruins of the Kearney St. buildings. After such an examination is permitted it may take some time to dig out the safes. To what extent, if any, the

**W<sup>M</sup> S. HEDGES & CO.,**

IMPORTERS AND CUTTERS OF

**DIAMONDS.**

Precious Stones and Pearls.

**170 Broadway, Corner Maiden Lane, New York.**

27 Holborn Viaduct, London.

**REMOVAL NOTICE.****SAUNDERS, MEURER & CO.,**

Importers of Diamonds, Pearls and Precious Stones,

HAVE REMOVED TO

**65 NASSAU STREET, PRESCOTT BLDG., NEW YORK.**

New Telephone No. 1613 Cortlandt.

**Chas. L. Power & Co.,** Cutters and Importers,**DIAMONDS**

AND OTHER PRECIOUS STONES,

**170 Broadway, corner Maiden Lane, NEW YORK.**

27 Holborn Viaduct, London.

**GOODFRIEND BROS.,**

IMPORTERS AND CUTTERS OF PRECIOUS AND IMITATION STONES.

Pearls

Rubies

Sapphires

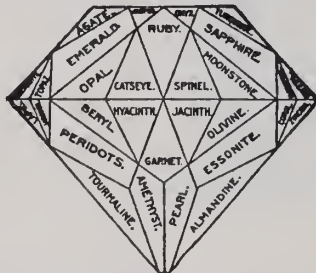

Tourmalines

Gem Corals

Opals

Emeralds

COPYRIGHT, 1895, BY GOODFRIEND BROS.,

256 Westminister St., Providence, R. I.  
10 Rue Cadet, Paris.Tel. No.  
662 Cortl't.**9-11-13 Maiden Lane, New York.****CORAL****BORRELLI & VITELLI,**  
CORAL MANUFACTURING COMPANY,All kinds of Coral—DROPS, BUTTONS, LENTILLES.  
CORAL NECKLACES, Graduated and Uniform.**PINK AND WHITE CORAL A SPECIALTY.**GOLD MEDAL, ST. LOUIS, 1904.  
GRAND PRIX, LIEGE, 1905.

3 Via Amedeo, Torre del Greco, Italy. 32 Rue d'Hauteville, Paris, France.

**401 Broadway, New York.**

Telephone, 5412 Franklin.

**CORAL****CORAL****Mr. Retailer:**

The Jobbers  
are taxing  
us to our  
utmost capacity  
with orders  
for the best  
line of  
Gold Watch  
Cases we ever  
created.

You will be  
pleased with  
their selections,  
we assure you.

**"WATCH OUT"****SOLIDARITY**  
**Watch Case Co.**

Established 1885.

**3 Maiden Lane, New York.**

GENERAL SELLING AGENTS

JOHN W. SHERWOOD  
FRANK E. HARMER

stock has been injured nobody is prepared to say until the doors of the safes are opened. Some people believe that the watch cases will be practically protected from the heat. Mr. Blythe started back for San Francisco about the middle of the week to resume charge of the business.

Ira Goddard, secretary of the Jewelers' Safety Fund, New York, said yesterday that not a single claim against the company has as yet been filed as a result of the disaster. It happened that comparatively few salesmen were in San Francisco at the time of the earthquake. A little earlier in the season there were many more there, and later there would have been a larger number. The losses of stock in the offices of resident agents is not covered by the company's policies, which are designed to protect stock while in transit. If a salesman, having a policy, lost his stock by fire in his hotel the policy would, of course, cover such a loss, but as far as has been reported those whose samples were burned in this manner were not insured in the union.

In relation to the probable damage to jewelry stock in fires, Mr. Goddard said that he recalled an instance, several years ago, when a stock of diamonds, valued at \$10,000, had passed through an intense fire in an express car. The diamonds were in a safe. The only damage to the stones was that they had temporarily lost their brilliancy. This necessitated repolishing, with a slight loss in weight as a consequence. The Safety Fund, which had insured the diamonds, was called upon to pay only a few hundred dollars, the cost of labor in polishing and the value of the slight losses in weight. The lightest kind of heat, Mr. Goddard said, would be fatal to pearls. As to jewelry, it might be melted in safes. The metal would then be of value, but the loss would be considerable because of the value of the workmanship.

The Solidarity Watch Case Co., New York, subscribed \$100 for the sufferers through Burr W. Freer, at San Francisco. The employees of the company in New York and Brooklyn sent a generous contribution through their local organization.

W. A. Salmon, who travels with the extensive lines of clocks of Harris & Harrington, 12 Barclay St., and goods of the Riviere Brass & Bronze Works, of 330 Seventh Ave., New York, had a close escape in San Francisco, where he had only just located for a business visit at the Palace Hotel. Mr. Salmon lost his entire lines of samples, and saved only the clothing he had the opportunity to take hurriedly with him. He begs to say to his friends in the trade that in two weeks he will be on the road again, with full lines of samples and photographs.

The A. Wittnauer Co., 9 Maiden Lane, received word last Friday from F. H. Wilkinson, who was traveling for the house and was in San Francisco at the time of the earthquake, that the stock was safe. Mr. Wilkinson was stopping at the Palace Hotel at the time, and at once removed the stock to a safe deposit vault.

The subscriptions to the Jewelers' Board of Trade fund for the relief of the San Francisco victims, heretofore acknowledged, amount to \$32,209. To this was added, May 3, \$460.53, making a total of \$32,669.53. The

additional subscriptions were as follows:

Kastenhuber & Lehrfeld	\$100.00
Powers & Mayer	100.00
Hartwig, Emma B.	50.53
Stern, L. & Co.	50.00
Redlieb, Alex.	50.00
Barrows, Ira	50.00
Safford, D. L.	25.00
Lapham, Edwin B.	25.00
Lauterbach, Aaron	10.00

Emma B. Hartwig gave the receipts of her restaurant at 83 John St., Thursday, May 3, amounting to \$59.53.

Several representatives of Shreve & Co., San Francisco, have been in New York in the last week and their many friends have extended to them earnest congratulations on their personal safety. They have passed most of their time in the Maiden Lane district and members of the trade who have met the western men have been much interested in getting information as to conditions in the stricken city.

George Lewis, the secretary of the company, kindly gave to a reporter of THE CIRCULAR-WEEKLY some information as to the happenings on the day of the earthquake. He was lying at the Pacific Union Hotel and, getting out safely, was the first man to reach the store in the new building recently erected for the firm. By 8 o'clock he had about 100 men of the force in the building. Orders were given that nobody should be allowed to enter except those connected with the business and the employees, and none who entered were allowed to go out until all left, when the fire was approaching.

Mr. Lewis made up his mind in the morning that the city would be destroyed, and, accordingly, all the men at hand were put at work storing jewelry and silverware in the vaults. They had from eight in the morning until midnight to do this, and at the latter hour the flames were so close that all were obliged to leave. By that time all the stock except the bric-à-brac, cut glass and china was in the vaults. Mr. Lewis and Bruce Bonney, the vice-president, remained in the neighborhood and saw the fire reach the building and destroy the interior. The building is of skyscraper proportions, the company occupying the basement, first floor, messanine and the second floor, while the offices above were rented.

Mr. Lewis said it was apparent that nothing inside the building, exposed to the flames, could survive. He remained in the city for more than a week. After the fire had swept his building and the ruins had cooled a little, he made his way inside. Everything of glass, he said, was melted and looked like ice. Cut glass and china, bric-à-brac lay in unrecognizable masses. Chandeliers were strung like icicles. Nothing of wood remained. The vaults were cool 10 hours after the fire. They were not opened, however, up to the time Mr. Lewis left San Francisco, as the firm desired to take no chances. In a number of cases, when the vaults had been opened, flames had broken out afresh and the military authorities were therefore slow in giving permission to open vaults.

Mr. Lewis said that he is as confident as he can be of anything without actually seeing it, that the merchandise in the vaults is safe. There are two of these vaults, one in the basement and one on the ground

floor. They are each 12 feet long, six feet wide and eight feet high, built of brick and steel by the De Bault Safe Co., and were pronounced on their completion to be as perfect protection as could be obtained.

The company had the assistance of soldiers, Mr. Lewis said, who protected the building's contents from the start, so that there has been no danger of any looting. Reports of people breaking into the store and stealing were therefore baseless.

The company's factory was also destroyed by the fire, the machinery being a total loss.

Mr. Lewis was not prepared to say what was the total loss on the factory or on the fittings and merchandise known to have been destroyed in the store. Whatever the loss is, he said, it is fully covered by insurance, so that the company is amply protected. The company leased, soon after the fire, new quarters at Jackson and Filmore Sts. Here it has a large building that had been used for a residence. This will be stocked at once and the business will be conducted here until the interior of the burned building has been refitted. It is likely that for a time both buildings will be used. The company has also opened an office at Post St. and Grant Ave.

While he remained in the city Mr. Lewis said that he had to take his chances with everybody else in getting food, rich and poor alike being glad to go in the bread line. After all arrangements had been made for resuming business, Mr. Lewis had no difficulty in getting a train east, and he arrived in New York last week. It is his intention to sail in a few days for Europe.

Godfrey Eacret, the company's buyer, who returned last week from Europe, met Mr. Lewis in this city. H. Houston, who is with the company, came on from San Francisco, and will remain in New York for a short time.

J. C. Aikin, of Aikin, Lambert & Co., returned to New York last week and received the congratulations of many friends on the fact that, although he was in San Francisco at the time of the earthquake, he was not harmed. Mr. Aikin occupied room 13 in the Palace Hotel.

To a CIRCULAR-WEEKLY reporter he said that he was awakened by falling plaster, and when the bed and furniture were thrown to one side of the room he realized that there was an earthquake. Going into the courtyard of the hotel, he found the guests seeking places of safety. The plate glass windows had been broken to pieces and the glass was scattered on the floors. He warned several ladies of the danger, as they were walking toward the glass in their bare feet. As he had no baggage except a light steamer trunk, he found a man who was willing to carry it over to the St. Francis Hotel.

Mr. Aikin spent all of Wednesday, the day of the earthquake, watching the fire. He noticed that before the fire reached the business district that Shreve & Co.'s store was apparently not damaged. Mr. Aikin said that people generally were not greatly alarmed. There was plenty of time to get away from the fire.

He remained out Wednesday night watch-

ADDISON W. WOODHULL, President.  
FRANK K. HUFF, Vice-President.

GILBERT T. WOODHULL, Treasurer.  
WILLIAM J. McQUILLIN, Secretary.

# MOUNT & WOODHULL,

IMPORTERS OF

**DIAMONDS,  
OTHER PRECIOUS STONES  
PEARLS, ETC.**

MAKERS OF

**FINE  
DIAMOND  
JEWELRY.**

26 Maiden Lane,  
(Southwest Corner Nassau Street)

**NEW YORK.**

**PARIS ADDRESS:  
5 SQUARE DE L'OPERA.**

**BAGG, PERINE & CO.,**  
RARE SPECIMENS OF  
DIAMONDS AND OTHER  
PRECIOUS STONES,  
21 & 23 MAIDEN LANE, NEW YORK.  
Tel. No. 6226 Cortlandt.

**EMERALDS,  
DIAMONDS  
AND  
PEARLS.**

**RUBIES AND  
SAPPHIRES.**

**CABLE ADDRESS:  
MILBAGG.**

## Pearl Necklaces and Collarettes.

**Mounted  
Diamond  
Jewelry**

of every  
description.

*Leading Jeweler*

*Emil W. Knopf*

*John W. Raefer*

*Frank L. Wood*

182 & 184 BROADWAY  
NEW YORK

Large  
assortment  
of all kinds of  
very fine, fancy  
and rare gems,  
including Pearls,  
Diamonds, Rubies,  
Emeralds and Sapphires.

**Particularly Fancy  
Colored and Fancy  
Shaped Diamonds.**

ing its progress, and Thursday morning he made his way to the home of a relative, C. S. Aikin, who lives about three miles out, opposite the Presidio. One side of the house had fallen, but the family were making themselves as comfortable as possible, and Mr. Aikin was glad to accept their hospitality until Saturday, when he took the first coast train that left for Los Angeles. He planned that it would be more comfortable to take a train from Los Angeles east than to get a through train in the crowds leaving San Francisco, and this plan enabled him to visit an aunt at Los Angeles. The train was delayed, however at San José, where he spent Sunday, and did not reach Los Angeles until Monday.

ATTLEBORO, Mass., May 5.—Communications continue to come to the Attleboro manufacturing jewelers, adding details to the loss sustained by the industry through the San Francisco earthquake. The W. H. Saart Co., which for many days heard nothing from its representative in that locality, has a letter saying the office was burned, but the greater part of the samples and other things of value were in a large safe, and escaped with little or no damage. Oscar S. Levy has notified J. M. Fisher & Co. that his line of samples appears to be lost, the office having been burned out. He adds that his own home was badly shaken up, but he and his family suffered no injury.

Numerous Attleboro jewelers are in receipt of copies of the letter sent east by Kahn Bros. notifying the trade that the customers in Oakland are as solvent as ever, that there is no occasion for any lapse in confidence toward them, and that all the losses in that community fall on real estate owners, not on merchants. The letter proclaims the fact that the firm is not acting selfishly in the matter, but sends the letter in the interests of the whole place.

The manufacturing jewelers in Attleboro continue to add their donations to the relief fund. They have been liberal givers to the Attleboro town fund, which last week reached the neighborhood of \$5,000, and they have given through the jewelers' fund raised in Providence. Among donations not acknowledged in the two previous issues are: Employes of the D. F. Briggs Co., \$43.80; Sykes & Strandberg and employes, \$38.50; P. J. Cummings & Co., \$40; Frontneau & Cook Co., \$18.

Reed & Barton, Taunton, have a vivid letter from their San Francisco representative, E. H. Adams. He was thrown out of bed by the principal shock, and as he struck the floor the wall of the dwelling fell off into the street. He threw on some clothing, and then, hearing of the quick spread of the flames, proceeded as fast as possible on foot a distance of five miles to the company's office on Kearny St. He saved from the place the most valuable of the contents, being particularly fortunate in getting out a group of samples that would have required much time to replace. He had no sooner found a safe place for them than the advancing flames drove him still further back, a second moving being necessary. Until he takes inventory of the saved goods the amount of loss will not be known. All his personal property was burned, leaving himself and wife practically penniless.



**Imports of Watches, Clocks, Jewelry and Gems into Canada.**

TORONTO, Can., May 5.—The monthly report of the Department of Trade and commerce of Canada gives the value of imports for home consumption for the month of January in the jewelry and kindred trades as follows:

	Month of January,		Seven months ended	
	1905.	1906.	1905.	1906.
Jan. 31.				
<b>Clocks:</b>				
Great Britain .....	\$282	\$766	\$7,383	\$7,213
United States .....	11,255	15,663	112,621	157,012
Germany .....	2,013	2,147	25,601	23,090
Other countries .....	195	457	9,902	12,232
<b>Totals .....</b>	<b>\$13,745</b>	<b>\$19,333</b>	<b>\$185,507</b>	<b>\$199,577</b>
<b>Watches:</b>				
Great Britain .....	\$1,262	\$1,517	\$15,338	\$19,051
United States .....	36,578	43,677	404,913	413,096
Switzerland .....	9,908	11,307	122,813	101,002
Other countries .....	6,737	1,316	21,682	36,273
<b>Totals .....</b>	<b>\$54,485</b>	<b>\$57,817</b>	<b>\$564,746</b>	<b>\$569,422</b>
<b>Jewelry:</b>				
Great Britain .....	\$6,806	\$6,003	\$50,057	\$42,924
United States .....	18,208	38,046	407,739	394,121
Germany .....	6,151	4,909	37,513	36,403
Other countries .....	3,214	2,030	21,475	18,568
<b>Totals .....</b>	<b>\$64,739</b>	<b>\$50,988</b>	<b>\$516,784</b>	<b>\$492,016</b>
<b>Gold and silver and manufactures of:</b>				
Great Britain .....	\$7,075	\$8,096	\$70,398	\$93,182
United States .....	11,251	11,983	200,865	188,833
Other countries .....	3,715	2,480	38,651	36,104
<b>Totals .....</b>	<b>\$22,041</b>	<b>\$22,559</b>	<b>\$309,914</b>	<b>\$318,119</b>
<b>Precious stones of all kinds and imitations of (durable):</b>				
Great Britain .....	\$20	\$1	\$6,480	\$5,949
United States .....	4,130	1,465	10,124	12,638
Other countries .....	2,834	330	12,971	16,111
<b>Totals .....</b>	<b>\$6,984</b>	<b>\$1,796</b>	<b>\$29,575</b>	<b>\$34,698</b>
<b>Precious stones of all kinds and imitations of (free):</b>				
Great Britain .....	\$10,259	\$7,814	\$136,379	\$214,061
United States .....	34,972	12,639	73,259	57,091
Holland .....	68,121	43,758	132,473	200,426
Other countries .....	32,914	80,945	428,948	234,215
<b>Totals .....</b>	<b>\$146,266</b>	<b>\$145,156</b>	<b>\$771,059</b>	<b>\$705,793</b>

**Date of Meeting to Form National Association of Retail Jewelers Changed to Aug. 3 and 4 at Rochester, N. Y.**

DETROIT, Mich., May 2.—The meeting which the American Retail Jewelers' Association had called to take place at Rochester, N. Y., for the formation of a representative national association of retail jewelers by delegates from the various State organizations of the country has been changed as to date. As it was intended that the meeting should take place in conjunction with the annual meeting of the American Association of Opticians, and as that meeting has been changed from Aug. 10 and 11 to Aug. 3 and 4, the time of the jewelers' convention has been changed to the latter dates.

It is expected that this meeting will be attended by delegates from not only all the organizations at present affiliated with the American Retail Jewelers' Association, but also the other retail jewelers' associations now in existence and the new ones which, it is expected, will be formed in various sections of the country between this date and August. Every effort will be made to have the national organization then formed thoroughly representative of the jewelry trade throughout the entire country and a large attendance is expected.

Particulars as to the meeting and election of delegates may be had from the secretary of the American Retail Jewelers' Association, Edward R. Roehm, of this city.

**Death of William Oscar Cornell.**

PROVIDENCE, R. I., May 2.—William Oscar Cornell, head of the refining concerns of Cornell & Andrews, this city; Cornell & Andrews Co., Meriden, Conn., and Cornell-Andrews Smelting Co., Attleboro, died yesterday morning at his residence in Whalen Ave., at the age of 70 years.

The deceased, who had been long and favorably known in the jewelry trade, was born Feb. 8, 1836, and originally went into the grocery business. He started in the refining business about 1890, with Frederick W. Andrews, who had long experience in this line, and the latter's son, Frank H. Andrews, was ultimately admitted. R. J. Rice became a partner in the Cornell & Andrews Co., and has charge of the branch in Meriden, Conn. The Cornell-Andrews Smelting Co., at Attleboro, was incorporated under the laws of Rhode Island, some time ago, with a capital stock of \$25,000, and was controlled by the deceased and his partner. The plant in this city was at 25 Mathewson St.

Mr. Cornell was also the president of the Providence Dyeing, Bleaching & Calendering Co., and was secretary of the American Seamless Wire Co. He was a trustee of Tufts College and a member of the Society for the Prevention of Cruelty to Animals and was also prominent in the work of the First Universalist Church. He is survived by a widow.

**Death of Kuno F. Keller.**

APPLETON, Wis., May 2.—Kuno F. Keller, a pioneer jeweler of Appleton, and one of the best-known men of the trade in this section, passed away at his home, 37 Sherman Pl., early last evening. Mr. Keller's death, which was sudden, was due to heart failure, and came as a shock to all his friends and family. He left his store feeling slightly unwell, and after returning to his home felt worse and lay down on a couch. A short time afterward Mrs. Keller called to him, and, receiving no reply, went to the couch and found him lying lifeless. The physicians who were summoned said that he had died before their arrival.

Kuno Ferdinand Keller was born in Pfulendorf, Baden, Germany, Nov. 20, 1837, and started in the jewelry trade in his native city. After receiving his education he was apprenticed to a watchmaker, and remained in that line until he came to this country in 1860. He first located in New York, where he practiced his trade and in which city he married Miss Theresia Mattes. He moved to Appleton in 1873 and purchased the jewelry store that had been conducted by Bernard Warkatler, next to the First National Bank, and this business he continued, moving to several locations, until he was finally settled in his present location, 814 College Ave. In 1891 he took into partnership his elder son, Gustav Keller, and later admitted three other sons. For a while he had a branch in Milwaukee, but this was closed a few years ago. The deceased was the fourth oldest jeweler in this State; he was a man of untiring energy and industry, and was highly thought of in the business community here.

The funeral services will be held Friday morning from St. Joseph's Church, under the auspices of the St. Joseph Society and Branch No. 6 of the Catholic Knights of Wisconsin, of which the deceased had long been prominent.

**Death of Frank Harmon.**

The many friends of Frank W. Harmon will learn with sincere regret of his death, which occurred at his home, 415 Central St., Springfield, Mass., last Monday. Mr. Harmon's death was not unexpected, as he had been confined to his house since Christmas with Bright's disease.

For 20 years Mr. Harmon has represented M. B. Bryant & Co., New York, in the east and parts of New York and Pennsylvania. The members of the company speak of him as a man of absolute fidelity to every trust and say that they feel his death as a great loss, in a business way, while their sense of bereavement is second only to that of his widow and daughter, who survive.

**Death of M. Lippert.**

CHICAGO, May 5.—M. Lippert, doing a jobbing jewelry business as M. Lippert & Co., in the Columbus Memorial building, was buried here last Tuesday at Waldheim Cemetery. Mr. Lippert died in Sioux City, Ia., while stopping at the house of B. Reingold, a retail jeweler of that town.

Deceased was well known in the local trade, having been in the jewelry business here about 18 years.

H. H. Humber, Leduc, Alberta, Can., moved recently to Red Deer, same province.

**EICHBERG & CO.,**  
IMPORTERS AND CUTTERS OF  
**DIAMONDS,**  
 65 NASSAU STREET, (Prescott Building.) NEW YORK.

**STERN BROS. & CO.,**  
IMPORTERS AND CUTTERS OF  
**DIAMONDS,**  
 CUTTING WORKS:  
 138-142 West 14th St., N. Y. **68 Nassau St.,**  
 CHICAGO, LONDON, **NEW YORK.**  
 103 State Street. 29 Ely Place.

**T**HE continued scarcity of fine Pearls is the conspicuous feature of the day in European markets. It not only takes days of hunting, but oftentimes weeks, before one can find what he actually needs. American buyers are therefore quite ready to appreciate the value of the co operation of a "GEMFINDER" always on the spot. A word in advance of your coming to Europe and an idea of your wants would insure the possibility of securing the desired goods and save time.

**FREDERICK A. JEANNE,**  
 "Gemfinder,"  
 5, Square de l'Opéra, PARIS, FRANCE.  
 London: Chancery Lane Safe Deposits. New York: Maiden Lane Safe Deposit Co.

**A. ROSEMAN, 9-11-13 Maiden Lane, New York**  
IMPORTER OF  
**DIAMONDS**  
 Maker of Diamond Jewelry

*Established 1872*  
**HEADQUARTERS FOR**  
  
**AMERICAN WATCHES**  
TRADE-MARK.

IMPORTERS **DIAMONDS** CUTTERS  
**Jacob Strauss & Sons**  
 14 MAIDEN LANE NEW YORK

**LEO GOLDSMITH, IMPORTER OF DIAMONDS**  
TELEPHONE: 4115 CORTLAND  
 and Precious Stones. Headquarters for Reconstructed Rubies and Sapphires. All sizes and forms.  
 9-13 MAIDEN LANE, NEW YORK.

**Has One of Our  
 8 Salesmen  
 Called On  
 You?**

They are showing the most attractive lines of American Watches, Diamonds and Jewelry that are being shown this season.

"We cover the country."

From our  
 New York Office:  
 H. OLLENDORFF  
 M. OLLENDORFF  
 H. GOLDSTEIN

From our  
 Pittsburg Office:  
 W. S. BICKART  
 J. S. BICKART  
 W. E. PARISH  
 S. A. REUTER

Special Southern Representative:  
 O. J. SOMERS

Should your wants necessitate an immediate delivery before our representative's arrival, either our New York or Pittsburg office will give your order by mail PROMPT and CAREFUL attention.

**I. Ollendorff Co.**  
JOBBER IN  
 Watches, Diamonds and Jewelry  
**PITTSBURG, PA.:**  
 Cor. Liberty Ave. & 6th St.  
**NEW YORK:**  
 54 Maiden Lane  
 ESTABLISHED 1868.

**THE MUELLER LAPIDARY CO.,**  
 248 Halsey Street, Newark, N. J.  
**CUTTERS**  
of  
 Precious and Semi-Precious Stones.

**Jewelers Having Tortoise  
 Shell Goods**

that have become dull or broken, can have them repaired, repolished and made as bright as new, at a small expense, by sending them to the manufacturer,  
**POTTER SHELL WORKS, Providence, R. I.**

### Receiver Appointed for I. G. Dillon & Son Co., Wheeling, W. Va.— Creditors Meet at New York.

The appointment last week of a receiver for the I. G. Dillon & Son Co., the prominent retail jewelry house of Wheeling, W. Va., surprised creditors, who, at the request of the president of the company, met in the rooms of the Jewelers Board of Trade, New York, on the same day that the application for a receiver was made at Wheeling. The company carried a stock roughly valued at \$150,000. The liabilities are said by Mr. Dillon to be about \$130,000, and he says that the assets are worth far more than that amount.

The creditors, after discussion of the situation, appointed a committee to investigate conditions and to take what action is necessary. Oliver G. Fessenden, of Hayden W. Wheeler & Co., is chairman of the committee.

No representative of the company was present at the meeting, and the creditors did not learn until later of the legal proceedings at Wheeling. Secretary D. L. Safford, of the Jewelers Board of Trade, as a member of the investigating committee, went to Wheeling on Friday to make inquiries.

WHEELING, W. Va., May 2.—I. G. Dillon, the president of the I. G. Dillon & Son Co., yesterday filed an application in the Circuit Court asking for the appointment of a receiver to take charge of the business and settle the present obligations.

In the bill asking for the appointment of the receiver, Mr. Dillon says that the obligations of the firm are about \$130,000, but that the assets will far exceed that sum. The company has an authorized capital of \$100,000, and it is said that under the proper management of the court all claims can be met in full and a balance will be left.

The cause assigned for this application was that too much credit had been extended by the firm to its customers and that it was in need of ready money. Some of the creditors are said to be clamoring for their money and in order to protect the business the court was asked to place the business in charge of some competent person.

Of the indebtedness of the firm about \$70,000 is due to foreign firms or corporations, while the balance, amounting to about \$61,000, is due to local creditors, most of it being due to banks. In regard to the sums due banks, the bill states that all the notes are amply secured and that there will be no loss to any one.

I. G. Dillon, the president, owns 996 of the 1,000 shares of stock.

Judge Harvey on the day of the application appointed W. S. Hicks receiver. He was away from the city, and on his return refused to act. The court then appointed as joint receivers, J. A. Mills, formerly cashier of a local bank, and Frank C. Cox, an attorney. They gave bonds in \$100,000, and took possession. An inventory of the assets is now being made.

The local creditors of the firm are as follows: Bank of the Ohio Valley, \$27,337; Dollar Savings & Trust Co., \$3,500; City Bank of Wheeling, \$7,800; People's Bank, \$4,300; Wetzel County Bank, \$3,100; First

National Bank of Mingo, \$1,500; First National Bank of Woodsfield, \$500; National Bank of West Virginia, \$1,500; National Exchange Bank, \$2,500; Friend Cox, \$1,000; W. A. Ward, \$7,848; German Savings Bank, \$700.

### Foreman of Tiffany & Co., New York, Arrested on Charge of Padding Firm's Pay Rolls.

John B. Brosseau, for many years foreman of Tiffany & Co.'s workshop, Fifth Ave. and 37th St., New York, was arrested last Wednesday on the charge of larceny, committed by padding the pay rolls. Subsequently he confessed. According to the statements that have been made, about \$5,000 was stolen each of the last two years. How much farther back the thefts have extended will not be known until an examination of his accounts is complete.

Brosseau, who is 59 years old, had been with the company 35 years, working his way up during that time to a position of peculiar responsibility. His examination was postponed in the Tombs Police Court until to-day.

Since the arrest the police have not hesitated to express their suspicion that he stole the three pear-shaped diamonds valued at \$35,000, which mysteriously disappeared from the workshop about a year ago. It is now revealed that the police at the time of the robbery had a suspicion of Brosseau, but the members of the company were so firm in their confidence of his honesty that no espionage was placed on him, and his name was held from publicity.

Brosseau denies that he took the pear-shaped diamonds, or that he stole in any other way except by padding the pay rolls. His counsel, A. B. Cunningham, last week, was quoted in the daily papers as saying that in case Brosseau was allowed to make restitution and go free, he would expose other leakages in the jewelry establishment. The members of the company say that such a proposition will not be entertained, and that there have been no robberies except those that have been published.

The method by which Brosseau robbed the company was simple and was possible only because entire confidence was placed in him. He sent his requisitions to the cashier for the money with which to pay the money to the men. The amounts in his payroll were larger than what the men actually received. His books have not been examined for a number of years, and there was no comparison during this time of the amount turned over to him for salaries and wages and what he actually paid.

For some time the officers of the company have been aware that they have been losing money, and detectives were employed to trace leakages. After some investigation the circumstances pointed to Brosseau, but even then the officers of the company were loath to think that their trusted employe was dishonest.

The complaint in the case accuses the prisoner of the specific theft of \$50 in raising the pay account of Jacques Brizel, a repairer. The police say that he in the same manner increased the pay of 60 or 70 other employes, and that his revenue from this source was from \$60 to \$75 a week, and sometimes more.

When the case against Brosseau seemed

complete the facts were made known to Ralph M. Hyde, the superintendent, and Col. H. H. Treadwell, a director. This was a couple of weeks before the arrest. Brosseau said that he was willing to turn over his equity in his home at 413 Lenox Ave. in order to make restitution. Charles T. Cook, the president of the company, who had been ill, learned about this time of what had happened, and he directed that the law should have its course.

In his confession Brosseau says that he did not gamble and had no vices, but spent his money on his family. Persons who are somewhat familiar with his circumstances say that he lived far beyond his income, his salary being \$3,500 a year. It is also said that sickness and other troubles in his family caused unusual expenses in recent years. His son, Gerald, had a position as salesman for Tiffany & Co., beginning about two years ago, and resigned a month ago.

### Death of the Rev. Henry Dutcher.

PET JERVIS, N. Y., May 2.—The Rev. Henry Dutcher, who died at his home in Warwick, N. Y., Saturday last at the advanced age of 85 years, was at one time well known in the jewelry trade, having been in business in this city.

The deceased, who is the father of Dwight Dutcher, of Warwick, was born Feb. 21, 1821, at Coventry, N. Y., and being a member of a large family received but little education. However, with the grit and energy for which he was later noted, he studied himself, and finally took up theology, and was admitted to Elders' Orders in the Methodist Episcopal Church. While never in charge of a church he preached in many pulpits and at the same time he worked at a trade, first a cabinet-maker and later in the jewelry line. He was in the jewelry trade in this city for some time, and 12 years ago moved with his family to Warwick, in which town the business is still continued by his son.

The funeral was held at Warwick yesterday afternoon.

### Death of A. P. Boynton.

CHICAGO, May 2.—The death of A. P. Boynton, a well-known jeweler of this city, was a great shock to his many friends throughout the jewelry trade. The deceased, who was 82 years old, had been in the business for over half a century; in fact, since Chicago was a small and unimportant town. He made a specialty of old clocks, but of recent years did not attempt to develop his business to any extent.

Mr. Boynton's brother, J. E. Boynton, of St. Louis, came to this city to look after the remains.

Extensive improvements have been completed in the store of William Keck, Ashland, O.

Burglars who entered the postoffice at Kingman, Ind., early Tuesday morning of last week, blew open the safe and escaped with a large amount of jewelry and watches which were carried by the postmaster, C. F. Smith. The amount of the loss is placed at approximately \$700. The building, a one-story structure of brick, was badly damaged by the explosion. No trace of the thieves has yet been found.

## WELL CUT STONES

GREATLY ENHANCE THE VALUE OF

## FINE JEWELRY

ALL SIZES AND SHAPES OF

## PERIDOTS

CUT TO ORDER FROM CLEAN ROUGH

At Reasonable Prices.

### AMERICAN GEM & PEARL CO.

14-16 Church Street  
NEW YORK

LONDON, 16 Holborn Viaduct  
PARIS, 39 Rue de Chateaudun

From MINES to MARKET

## AMERICAN PEARLS

From Ten to Ten Thousand Dollars Each.

MAURICE BROWER, 16 John St., New York.

### SOHN and HYMAN

IMPORTERS OF PRECIOUS AND IMITATION STONES

Crystals Engraved and Painted from Photo. Crests and Coats of Arms Engraved. Stone Seal Engravers and Incrusters. Lapidary Work a Specialty.

JOBGING STONES A SPECIALTY

47 and 49 Maiden Lane, NEW YORK

## MONTANA SAPPHIRES

IN FANCY COLORS

PERHAPS no finer or larger assortment of these Stones has ever before been shown. We are prepared to furnish you with a selection at once, and solicit your order on memorandum.

UNIQUE STONES ARE OUR SPECIALTY.

Send for our new booklet containing a list of over 100 precious stones, their distinguishing features and colors, also articles on "THE INFLUENCE OF GEMS ON CERTAIN DAYS" and "THE SIGNIFICANCE OF GEMS," a handy book of reference that will assist you in selling.

The PASSMORE GEM CO., 373 WASHINGTON ST., BOSTON, MASS.

### Trans-Atlantic Voyagers.

TO EUROPE.

H. W. Allen and wife, Chicago, will sail next Monday.

R. A. Breidenbach, New York, sailed last Saturday on the *Patricia*.

Charles N. Hancher, Wheeling W. Va., will sail to-day on the *Baltic*.

B. Didisheim, of Hipp. Didisheim & Bro., New York, sailed recently on *La Savoie*.

George Lewis, secretary of Shreve & Co., San Francisco, Cal., will sail in a few days.

M. A. de Vries, with Eduard van Dam, New York, sailed last week, on the *Finland*. Frederick Goldsmith, of Ingomar Goldsmith & Co., sailed on the same boat.

Loring Andrews, of the Loring Andrews Co., Cincinnati, O., will sail to-morrow on the *Amerika*.

Julius Mamluck, of Julius Mamluck & Co., New York, sailed, recently, on the *Kaiser Wilhelm II*.

Henry Bodenheimer, of Bodenheimer & Jaskow, New York, sailed, last week on the *Grosser Kurfurst*.

William Ali, Beckingham, manager of the silverware department of Pitkin & Brooks, Chicago, and his bride, sailed, last Wednesday on the *Teutonic*.

Goodman King, of the Mermod, Jaccard & King Jewelry Co., St. Louis, Mo., sailed yesterday on the *Kronprinz Wilhelm*. L. Laubheim, of Laubheim Bros., New York, and Mrs. Laubheim sailed on the same boat.

FROM EUROPE.

M. Moussaieff and S. Kutner, both of Paris, France, arrived last week.

Godfrey Eacret, with Shreve & Co., San Francisco, Cal., returned last week.

Maurice L. Powers, of Powers & Mayer, New York, returned last-week on the *Carmania*.

J. W. Mayer, of Powers & Mayer, New York, returned last week on the *Kronprinz Wilhelm*.

R. Harris, of R. Harris & Co., Washington, D. C., and family is returning on the *Zeeland*, due in New York next Wednesday.

Eduard van Dam, New York, returned Sunday on the *Amerika*. On the same boat was L. Friedlander, of R. L. & M. Friedlander, New York.

Jacob Bloom, Kansas City, Mo., offers his creditors 35 cents on the dollar. Mr. Bloom was first located in Denver, Colo., where he conducted business under the name of E. Bloom. He resumed control in 1894 and did a prosperous business. He discontinued business early in 1905 and traveled for several months, after which he re-engaged in business in this city in November, 1905.

The factory of Miller, Fuller & Whiting, Broad St., North Attleboro, Mass., was broken into either Saturday or Sunday evening, and jewelry valued at \$300 taken. An entrance was gained through a skylight window, which was reached by outside stairs. Once inside the shop the burglars hastened to the packing room, where they stripped the pattern boards and helped themselves to finished brooches and pins. Several thousand dollars worth of unfinished stock was within reach of the burglars, but was apparently untouched.

## Connecticut.

The Wm. L. Gilbert Clock Co., Winsted, contributed \$350 to the relief fund for the San Francisco sufferers.

Albert G. Lewis, with Manning, Bowman & Co., Meriden, and Miss Daisy L. Morgan, will shortly be united in marriage.

Augustus R. Marshall, for many years a well-known watchmaker in Stratford, died May 1, at his home at that place, aged 76 years.

Wm. Kenneth Sessions, son of Wm. C. Sessions, returned, last week, from a trip to Florida, where he went for the benefit of his health.

The wife of N. Burton Rogers celebrated her birthday anniversary, last week, by a reception. The hostess was the recipient of many beautiful gifts.

Mrs. Elmira B. Lewis, widow of the late Benjamin Lewis, an inventor of a calendar clock, was found dead in bed at her home on Maple St., Bristol, Friday morning.

Chas. Goff, a former employe of the Wilcox Silver Plate Co., Meriden, died suddenly, May 3, in New Britain. The deceased was a member of the O. U. A. M.

Samuel Stohr, designer at factory "E," International Silver Co., Meriden, is arranging to make a trip to Europe this Summer. His itinerary will embrace visits to the principal art centers abroad.

Edward M. Phelps was arrested, May 4, in Hartford, on a charge of forgery. Among those upon whom he is alleged to have passed worthless checks is Daniel H. Blinn, 50 Asylum St. The amount of the check given to the jeweler was only \$7.

Henry Haaf, master mechanic with the Seth Thomas Clock Co., Thomaston, collided with a wagon while on the way from Bristol to the concern's offices, in his automobile one day last week, and completely demolished the vehicle. The auto was unharmed.

Notices have been posted in the various departments of the Seth Thomas Clock Co.'s factory, notifying the employes that until further notice the plant will be run only half a day on Saturdays, thus making 55 hours constitute a week's work.

Landers, Frary & Clark, New Britain, are planning to hold a big opening of their new foundry building in Elm St., which is nearing completion. It is one of the largest foundry plants in the State. The employes of the concern will give an entertainment and dance.

President Chas. F. Smith, of Landers, Frary & Clark, New Britain, arrived home, Sunday evening, of last week, after a European trip. Mr. Smith was accompanied by his wife and the latter's sister. The party was met by the Mayor of New Britain in New York and accompanied home by him.

A member of the firm of G. W. Fairchild & Sons, Bridgeport, while hastening for a train recently, dropped a valuable pearl and diamond necklace from his pocket. The necklace was found shortly afterwards by Richard F. Phelan, who returned it to the owners. The finder was liberally rewarded.

The body of Allen S. Butler, a fireman in the employ of the Bradley & Hubbard Mfg. Co.'s factory, Meriden, was found

Friday morning in the ruins of the factory, recently destroyed by fire. The deceased had been engaged in fighting the flames when he met his death. A widow and several children survive him.

Employes of factory "E," International Silver Co., Meriden, have been notified that the Summer shut-down for repairs and inventory, instead of taking place this year on July 4, will be during the Centennial and the week following. The factory will be closed June 9, and will open again June 25. It will be closed July 1 only for the holiday.

Gen. George H. Ford, New Haven, was a delegate to the National Congress, Sons of the American Revolution, just held in Boston, from David Humphrey's Branch of the Connecticut Society, Sons of the American Revolution, of New Haven. He made an address, May 3, to the latter organization in New Haven concerning the convention.

A fire which broke out May 3 in the stock room of the big Bradley & Hubbard Mfg. Co.'s plant, Meriden, threatened the entire factory at one time, but the firemen finally got it under control. There is an immense amount of damage done by smoke and water to the chandelier department. The fire was first discovered breaking through the windows of the stock room, which is on the top floor of the chandelier factory, and in a few minutes the whole top seemed to be ablaze. Two alarms called all the department apparatus and several streams were soon playing on the building. Capt. Donovan, of Hose No. 2, was overcome by the smoke and rescued with difficulty. All the fixtures and stock of chandeliers and lighting appliances were stored on the top floor. This floor and its contents were entirely destroyed. The lacquer department directly underneath was also ruined, mostly by smoke and water. The chandelier manufacturing department, which occupied the next two floors, was washed out, with considerable loss. The loss is fully covered by insurance.

## North Attleboro.

Artner Chace, Wednesday, left on a western trip for F. S. Gilbert.

James P. Black returned Saturday from a trip through New England.

Roswell Blackinton, Friday, returned from a trip to North Carolina, which he took for the benefit of his health.

James M. Clark 2d, has been granted a patent on a bracelet hinge. He has assigned it to the Daggett & Clap Co., of Attleboro.

The factories of F. L. Shepardson & Co., Casper, Mandalian Co., J. J. Sommer & Co. and the W. G. Clark Co. were closed last week pending repairs to engine and building.

That the San Francisco trade is not entirely gone for this Spring was shown last week when the W. & S. Blackinton & Co. received an order from a San Francisco house.

Ross Whitmarsh left last week to assume charge of the New York office of the George L. Paine Co., pending the recovery of George Angell, who was injured several weeks ago in an elevator accident in a Brooklyn department store.

The Bugbee & Niles Co. last week filed

its annual financial statement as follows: Machinery, \$12,857; cash and debts receivable, \$54,775; manufactures and merchandise, \$16,927; capital stock, \$50,000; profit and loss, \$34,559. The officers of the corporation are: Daniel Chisholm, president; Charles Rhodes, vice-president, and Alpin Chisholm, treasurer.

John P. Stanley, whom the older members of the trade will remember as the New York representative of the Stephen Richards Co., has written a letter to Samuel E. Fisher from Oakland, stating that although he escaped from the earthquake without injuries, that he lost all his possessions. His principal loss is a collection of curios and pictures, which, it is said, was the finest in that part of California.

## Buffalo, N. Y.

C. F. Chouffet, 379 Main St., for several years a resident of Bidwell Parkway, has moved to 527 Auburn Ave.

Present & Co.'s store, 444 Main St., is being thoroughly remodeled and overhauled. The salesroom is being extended in the rear some 40 or 50 feet.

Philip Fischer, bankrupt jeweler, formerly at 548 Main St., has been employed as head salesman in the jewelry department of the Wm. Hengerer Co.'s store.

E. V. Syrcer, optician in the Best & Co. jewelry store, 11 E. Genesee St., was last week elected secretary of the Bible Class of '06 of the Lafayette Presbyterian Church.

All of the stock of the Freeman Jewelry Co. not sold at auction in the Niagara Falls branch store, was, last week, brought to the Buffalo store, 84 Seneca St., which is this week being enlarged and overhauled. The improvements will be extensive.

A. E. Sipe, in the Mooney building, Saturday night caused the arrest of Fred Storms, aged 16, by Detectives Holmes and Flynn, on a charge of petit larceny. The young man, who had been in the employ of Mr. Sipe, is accused of collecting \$10 and failing to turn it into the office.

The Niagara Ring Mfg. Co., Eagle and Washington Sts., is much pleased with the success of its innovation in furnishing an automobile in which to show customers and visitors the sights of Buffalo. The concern has noticed a substantial increase in patrons as well as calls from friends.

M. L. Levine, 163 Genesee St., has received a letter from his brother, Harry Levine, who states that the house in which he was living in San Francisco at the time of the earthquake, collapsed, and that he escaped in his night clothes, and is now living in Oakland. All his property was destroyed.

In a few weeks the town clock system of Buffalo will be materially changed. T. & E. Dickinson & Co. will remove their old stand clock from its tower in lower Main St. and erect it on a handsome post in front of their new place, 472-74 Main St. Charles F. Damm is negotiating for the placing of a chronometer at the edge of the sidewalk in front of his Main St. establishment. The chronometer will show its face beneath a heavy plate glass.

Jacob M. Kolb, Elizabeth, Ill., has been succeeded by Ira E. Shaw.

WATCHESDIAMONDS**AT WHOLESALE ONLY**

**W** E DO NOT *RETAIL*, which means that we protect the *Retail Trade* by *Positively Refusing* to sell any goods other than at *Wholesale*. Any *Jobber* who *Retails* becomes a competitor of the *Retailer*.

*Are you buying your Watches, Diamonds, Jewelry, Cut Glass and Silverware from a competitor of yourself? We are not your competitor and we solicit your trade.*

**D. C. PERCIVAL & CO., Inc.,**  
373 WASHINGTON ST., BOSTON, MASS.

IMPORTERS OF DIAMONDS.

Manufacturers and Jobbers only of Watches, Jewelry, Silverware,  
Cut Glass and a complete material department.

JEWELRYCUT GLASSSILVERWARE**THE DEMAND FOR PEARLS IS ENORMOUS****FASHION DICTATES PEARLS**

Our stock is the largest and most complete in America of the finest Fish-Skin Pearls. Prices range from

**30c. to \$25.00 per String**

Selection packages sent on request.

**CHOPARD FRÈRES**

MAKERS OF ART JEWELRY NOVELTIES.

49 Maiden Lane

NEW YORK

FACTORY: 35 Rue Des Trois Bornes,  
PARIS, FRANCE.

## Philadelphia.

P. P. Swan has left the Philadelphia College of Horology to accept a position in Atlanta, Ga.

Fred Goldman held the formal opening of his new retail store at 1125 Columbia Ave. last week.

Abe Sickles, of M. Sickles & Sons, is expected back from a trip to Europe in about six weeks.

William Todd, watchmaker, resigned last week his position with George Child, 9th and Chestnut Sts.

William P. Kammerer, with J. Warner Hutchins, has completely recovered from a week's attack of the gripe.

Alterations and extensions were completed last week to the polishing and shipping department of M. Sickles & Sons.

F. B. Wallen, 105 Broadway, Camden, N. J., made a trip to Bridgeton last week to attend the birthday festivities of his mother at the old homestead.

Harry P. Lanz resigned, last week, his position with Ferdinand Levy & Co., 929 Chestnut St., to go with a chain manufacturer of North Attleboro, Mass.

Wright, Tyndale & Van Roden, dealers in ceramics and objects of art, secured judgment last week in the local courts against Joseph V. Campbell for \$448.07.

J. E. Caldwell & Co. offer a liberal reward for the return of a gold bead necklace lost by one of their patrons after attending a society function at the Academy of Music.

Jacob Muhr was, last week, elected a life member of the Hebrew Educational Society at its annual meeting. Morris Pfaelzer, a retired jobber and retail jeweler, was made a director.

Gillender & Sons, manufacturers of cut and other glass ware, donated, last week, \$500 to the San Francisco relief funds. The National Optical Co. gave \$50 and the employes of C. F. Rump & Sons chipped in liberally.

Valuable pieces of diamond jewelry from the estate of the late Rufus E. Shapley were disposed of at auction last week by M. Thomas & Sons, and brought prices entirely satisfactory to the Sansom St. dealers who attended.

Horace Sheppard, a son of Joseph M. Sheppard, 520 N. 10th St., who has been engaged in other business for some time past, purposes to return to watchmaking and start in business as a repairer for the trade in the wholesale district.

Out-of-town retailers in this city during the past week included: E. J. Allen, Seaford, Del.; Mr. Harper, of Harper & Taylor, Souderton, Pa.; B. F. Kessler, Mt. Carmel, Pa.; M. K. Laudenslager, Souderton, and Gustave Lanz, Norristown.

J. B. Bechtel, of J. B. Bechtel & Co., is touring the Lehigh Valley for orders which are now to be expected since the coal strike talk is over. Andrew Little, of the same firm, departs this week on a trip through the eastern shore of Maryland.

James G. Maree, formerly one of the best known jewelers in this city, long located in Manayunk, but now retired and living in Germantown at 424 W. Cheltenham Ave., was overjoyed last week to receive word from Thomas O'Neill, a boyhood chum, now residing at Riverside, Cal. O'Neill

is a minstrel and Mr. Maree was himself once a minstrel but he abandoned the theatrical profession for the jewelry business, while O'Neill rounded out his career as a minstrel. Mr. Maree hopes soon to have a reunion party.

The Bailey, Banks & Biddle Co., of this city, has been notified that it has been awarded by Governor Swanson, of Virginia, the contract for a \$5,000 silver service for the battleship *Virginia*. The service is to be presented to the warship by the State of Virginia. The date for the presentation of the service has not yet been fixed. The last award made to Philadelphia jewelers for battleship services was that made to J. E. Caldwell & Co., for the *Pennsylvania*, which cost \$25,000. The *Virginia's* service is to consist of about 50 pieces. The Bailey, Banks & Biddle Co. will make an elaborate punch bowl, tray cups and ladles, coffee and tea services and trays, dessert service and a dinner set, which will include vegetable dishes, a sauce boat and meat platter. The centerpiece and candelabra was made previously for the Colonial Dames of America in Virginia and will form part of the service of the new battleship, although not included in the contract award made by the Virginia State authorities.

A. G. Lee, vice-president of the Jewelers' Club of Philadelphia and one of its charter members, was guest of honor at an exclusive little dinner last night at Boothby's, this city, given to mark his retirement from the trade. Mr. Lee has been manager of the watch department of Wanamaker's store, which position he has resigned to enter into the manufacturing textile business. He has made a contract with the Maynard Co., and will act as general sales agent, with offices in New York City. He will make his home in Ridgewood, N. J. Mr. Lee has been actively engaged in the trade in this city for many years. He started out as a watchmaker, finishing his trade with the Keystone Watch Case Co. Afterward he went with the Bailey, Banks & Biddle Co., where he remained until John Wanamaker determined to open a retail jewelry store in connection with his big department store. Mr. Lee was persuaded to go with him. Since the organization of the Jewelers' Club Mr. Lee has been one of its most active members. He has made himself popular by the manner in which he has sought to enliven the various dinners and entertainments given by the club.

## Attleboro.

Ben and Milton Sandfelder, western salesmen for McRae & Keeler, paid a visit to the home office last week.

Emory J. Sullivan, ex-Consul to Turkey, who visited in the Attleboros, last week, gave out a press interview, in which he declared the manufacturing jewelers are ignoring golden opportunities in the part of Europe where he formerly resided.

J. F. Dean, traveling salesman for Reed & Barton, Taunton, has returned from a successful tour of Pennsylvania. John Nichols, holding a responsible post, has resigned to enter the employ of a large concern in Oneida, N. Y. Walter Hayes, a skilled worker, has resigned to go to England, where he will work at silversmithing.

Stock taking at this factory has led to suspension of work for a few days in some of the rooms the past week.

James E. Blake, of the James E. Blake Co., has personally paid out a considerable amount to benefit the appearance of the center of the town. The change in the grade of the railroad right through the business center, which has advanced so far that trains began to run on the elevated structure, Sunday, has made Railroad Ave. and Mill St. among the most important thoroughfares. Mr. Blake has risen to the occasion by improving at considerable expense the sidewalks and the looks of his factory property on the two streets.

## Boston.

John F. Canning has given a chattel mortgage for \$1,250.

C. W. Hurl, optician, 120 Tremont St., has sold his business to W. D. Hunt.

H. N. Lockwood, watch and jewelry dealer, has moved from 9 Bromfield St. to 61 Bromfield St.

George H. Gutteridge, Maynard, Mass.; John Webb, of Alden Webb & Son, Beverly, Mass., and E. C. Chagnon, Woonsocket, R. I., were in Boston during the week.

C. J. F. Sherman & Son, who have been in the jewelry business at 220 Hanover St., for 50 years, have sold out to James E. Scanlon, who has been employed by them for 15 years. The Shermans will retire from business.

Among the recent contributions to the San Francisco relief fund were the following: Employes of the American Waltham Watch Co., Waltham, Mass., \$2,006.23, and American Waltham Watch Co. (as from Waltham), \$1,000.

Lawrence Percival and bride have gone abroad for their wedding trip. Mr. Percival's father, D. C. Percival, received a cablegram from them May 5, saying they will visit Paris and London and will remain in Europe some three weeks.

Owing to the San Francisco disaster the Order of the Mystic Shrine decided to hold its annual pilgrimage at Chicago, instead of in Los Angeles, Cal. James S. Blake, of Kettell & Blake, will go as a delegate to the meeting, which will be held June 12.

The certificate of incorporation of the Waltham Watch Co., the new concern which will take over the American Waltham Watch Co., as reported in THE CIRCULAR-WEEKLY last week, was filed last week at the State House, and it gives the following schedule of assets to offset the \$11,000,000 stock to be issued: Real estate in Waltham, \$950,000; machinery, \$2,200,000; merchandisc, \$3,300,000; accounts receivable, less bills payable, \$50,000; patents, trademarks and good will, \$4,500,000; total, \$11,000,000. The subscriptions for the capital stock to be issued are as follows, in preferred and common stock, respectively: Ezra C. Fitch, \$1,334,000 and \$2,334,000; Francis R. Appleton, \$1,333,000 and \$2,333,000; Royal Robbins, \$1,333,000 and \$2,333,000; total, \$4,000,000 and \$7,000,000. Ezra C. Fitch will be the president of the company, Royal Robbins the treasurer, and P. W. Carter, clerk.



## AN AUTOMOBILE FREE



# Old Reliable W. & S. B. ★

1866 — 1906

Forty years ago W. & S. Blackinton made the first gold filled, hard soldered, fancy link vest chains. By way of celebrating our

### FORTIETH BIRTHDAY

we beg to announce a plan of direct interest to the entire jewelry trade.

In January, 1907, we will give to the retail jeweler who uses the greatest number of Blackinton chains between May 1, 1906, and January 1, 1907, an Automobile Touring Car of standard grade and 1907 model.

To the retail jeweler who uses the second greatest number we will give an Automobile Runabout of standard grade and 1907 model.

To the retail jeweler who ranks third in this contest we will give a Motorcycle of standard grade and 1907 model.

The Retail jeweler who ranks fourth in this competition will receive an American Watch Lathe of latest design.

All other retail jewelers who use Blackinton chains will share in the following provisions:

Between May 1, 1906 and January 1, 1907, every Blackinton Old Reliable W. & S. B. ★ 1-10 or Globe Filled  $\frac{1}{8}$  vest or Dickens chain will bear an aluminum tag, illustrated herewith. These tags have a definite value and should be preserved.

The sales of Old Reliable W. & S. B. ★ 1-10 chains are enormous and we wish to draw particular attention to our Globe Filled  $\frac{1}{8}$  chains, in view of the constantly increasing demand for the highest grades of gold filled chains.

Upon receipt of forty tags from any retail jeweler, we will send free of charge one of our Globe one-eighth gold filled vest chains. For seventy-five tags we will send two Globe chains and for one hundred tags we will give three Globe chains. Retailers should preserve the tags as fast as goods are placed in stock and should decline to receive from jobbers chains that do not bear the coupon tag.

We offer a choice of twelve patterns of Globe one-eighth gold filled chains in selecting premiums, and illustrations will be mailed free on request. Globe one-eighth gold filled chains are guaranteed to assay one-eighth, are gold soldered and are warranted to give satisfaction for twenty years. Old Reliable W. & S. B. ★ 1-10 chains are gold soldered, and are the perfection of design, finish and durability. All Blackinton chains are made by the Wearbest process which hardens the gold and greatly increases the wearing qualities. This process is owned by us and no other chains are made in this manner.

Retailers who find difficulty in obtaining Blackinton chains may, upon written request, receive a list of jobbers handling the goods in their territory, or a selection package will be sent through any jobber whom the retailer may designate. For further particulars, address the manufacturers and watch this space.

**W. & S. BLACKINTON CO.,** North Attleboro, Mass.



## Pittsburg.

Mr. and Mrs. D. L. Cleeland, Butler, Pa., were in Pittsburg last week.

Henry A. Barrett, of the George B. Barrett Co., is contemplating making a European trip in the hope of benefiting his health.

W. W. Wattles last week disposed of a piece of property, 55 by 121 feet, in Lang Ave., 21st Ward, for which he received \$12,500.

The John M. Roberts & Son Co. last week subscribed \$100 to the local California Relief Fund, which now amounts to over \$300,000, most of which has been forwarded to San Francisco.

The Pittsburg Association of Credit Men held its annual dinner at the Union Club last Wednesday night. The association intends to watch closely all proceedings brought under the bankruptcy act.

It is reported on very good authority that a Cincinnati firm contemplates opening a jewelry store in lower Fifth Ave. in the vicinity of the stores of E. P. Roberts & Sons and the Hardy & Hayes Co.

The annexation of Allegheny to Pittsburg now appears to be practically assured. The court has ordered an election on the question of consolidation June 12, which will be by joint vote of the two cities. If annexation takes place, Pittsburg will have a population of 600,000.

The jewelers in Allegheny who kept accounts at the defunct Enterprise National Bank are breathing easier since it is reported that the sale of the Santa Fe Central Railroad of New Mexico, a large creditor of the bank, may realize a handsome sum. This road was built by the Pennsylvania Development Co., which is the real debtor to the bank.

Joseph G. Wasson, manager of the jewelry department of Joseph Horne & Co., has been made chairman of the investigating Committee of Pittsburg Councils, appointed to inquire into charges made against certain Councilmen and other officials, suspected of accepting money and aiding in the vice traffic. Mr. Wasson leaves shortly for Europe to purchase goods for his firm.

Among the out-of-town merchants who visited Pittsburg last week were the following: Philip Ruprecht, Sharpsburg; S. B. Munhall, Freeport; A. A. Fortney, Morgantown; John M. Kennedy, Waynesburg; F. M. Langnecker, New Brighton; Abe Teplitz, McKeesport; George McGill, Mason-town; Frank F. Robinson, Vandergrift; D. L. Cleeland, Butler; J. S. Murphy, Greensburg; C. H. Bauer, Blairsville; Robert W. Brady, Washington; D. A. Murray, Canal Dover; J. J. Schmidt, Turtle Creek; J. Linenbrink, Rochester.

As soon as the requisition papers can be obtained, Steven Baccario will be brought to Pittsburg from Atlantic City, so the police say, on a charge of N. Gallinger, 1200 Penn Ave., of getting \$2,000 worth of diamonds and several watches on the pretense that he had customers for them. Baccario was arrested Wednesday at the seashore on a telegram sent by Detective Crooks, of this city, charging with larceny by bailee. Baccario had been employed in a downtown club for 15 years and lived in Center St., Wilkesburg. For years he had been trading with Gallinger. He is said to have given Gal-

linger some money in part payment for the jewelry, and said that he would turn over the balance in a few days, but had not been seen since. He disappeared some time ago, and Gallinger reported his loss to the detectives, who traced him to Atlantic City. Steps are now being made to secure requisition papers.

## Lancaster, Pa.

Archie Musser has gone to Waltham, Mass., to take a position.

Frank G. Huber, of the H. S. Meiskey Co., is home from his trip.

M. Rosenstein and wife are home from a trip to Little Rock, Ark.

F. A. Peters, of the H. S. Meiskey Co., has been visiting New York on business.

A. B. Smith, head salesman for Augustus Rhoads, served as a jurymen, last week, in the common pleas court.

Percy W. Appel, of W. W. Appel, participated in the minstrel show given last week by the students of Franklin and Marshall College at Fulton Opera House.

E. R. Kant, C. E. Foose and W. N. Shute, representatives of the Non-Retailing Co., who were here for the past week helping take account of stock, have gone out on the road again.

M. Friedman, of M. Friedman & Co., New York, visited Lancaster last Saturday, accompanied by his bride of a few days. He received hearty congratulations from numerous friends here.

S. Kurtz Zook, who recently removed his optical department to an upper story, has sent his repair department up to keep it company, in order to gain room for his jewelry stock on the lower floor.

Among the out-of-town jewelers who visited Lancaster last week were: Mr. Helm, of F. W. Helm & Co., New Providence, Pa.; C. E. Hinkle, Ephrata; W. J. Frazer, Lincoln; Frank Kessler, Mt. Carmel, Pa., accompanied by Albert Richards; Leonard B. Martin, Cincinnati.

G. E. Fleisher, head watchmaker for Ezra F. Bowman's Sons, is on the sick list. Harry Carson, Bellevue, O., is taking a course in watchmaking at the Ezra F. Bowman Technical School, and J. Tschantre, who took a course in engraving at the school, has returned to Cambridge, Ind.

At the celebration Sunday of the 50th anniversary of the Junior Missionary Society of Trinity Lutheran Church, a beautiful gold plate, mounted on mahogany and exquisitely engraved, all the work of Ezra F. Bowman's Sons, was presented to Rev. Dr. C. F. Krotel, now of New York, who organized the society while he was pastor of Trinity Church.

## New Orleans, La.

Louis Kaufman, a jeweler, who lives at 2304 Magazine St., learned last week that his daughter, Mrs. Loth, her husband and child were uninjured by the fire and earthquake in San Francisco, though in the city at the time.

The Royal Loan & Jewelry Co., Ltd., of this city, has obtained a charter as a corporation, with a capital stock of \$15,000. The officers are: Peres M. Stein, president; Albert Hurwitz, secretary and treasurer, and also the first board of directors.

## Baltimore.

The will of Carl August Steman, probated recently in the Orphans' Court, leaves all his estate to his widow, Marie Steman, and names her executrix without bond. Mr. Steman died March 10.

Some vandal has been passing along the retail district disfiguring large plate glass windows by scratching them. Fourteen merchants have reported the fact in the last few days to the detective department.

Joseph Castelberg, president of the Castelberg National Jewelry Co., is having planned, in conjunction with Martin E. Greenhouse, Philadelphia, Pa., a modern building on the large lot on Baltimore St., which they recently purchased. The plans are not entirely completed as yet.

Edward L. Parker was sentenced to one year in jail, April 26, by Judge Morris, in the United States District Court, on the charge of using the mails for fraudulent purposes. It was stated at that time that Parker was arrested in New York in November and that he was also wanted in Philadelphia for defrauding a jewelry firm there of \$2,270 worth of goods.

George F. Buchholz, president of the Higbie-Barbour Mfg. Co., who announced, a little over a month ago, that the company would remove to Baltimore and erect an up to date silverware plant here, received bids from contractors for the new plant, last week. The bids were all rejected and Mr. Buchholz announced that the structure would be built under his own supervision. The building, as stated in THE CIRCULAR-WEEKLY, will be located on the Franklin Road, and will be three stories high and 50 feet by 150 feet. The work will be followed after plans prepared by Architect Henry J. Tinley.

## Detroit.

Adolph Bunge, 260 Gratiot Ave., will shortly move to 593 Mt. Elliott Ave.

W. A. Sturgeon, of W. A. Sturgeon & Co., has returned from a trip to New York.

Frank Mathauer, with Mathauer & Koester, has returned from a trip to the trade in the State.

Le Heup & Thomas, 80 Michigan Ave., have acquired the lease of the store occupied by Bing Bros., 82 Michigan Ave., and will enlarge their jewelry business.

The new firm of J. Friedberg & Son, 210 Woodward Ave., successors to George Schaffner, held its formal opening last week. Morris Friedberg, junior member of the firm, was with Mr. Schaffner for six years.

Thus far no clue has been obtained to the thieves who stole several hundred dollars' worth of jewelry, watches and old gold from the store of E. D. Trebilcock, of this city. A liberal reward has been offered for the apprehension of the thieves.

About 20 jobbers and manufacturers met at the Hotel Normandie, Friday night, to discuss the advisability of forming an organization among the local trade for the purpose of booming Detroit in the middle states as a jewelry jobbing center. The members of the trade in Detroit believe valuable results would come from such a movement. Another meeting will be held May 19.

# GORHAM SILVER

## GORHAM SPOONS AND FORKS.

¶ So long as May and June continue to be the most popular of "wedding months," so long will the Jeweler at this season of the year be called upon to meet insistent demands for suitable wedding gifts.

¶ None is more generally sought after than the set of Spoons and Forks destined to take its place among the most cherished of family heirlooms.

¶ No wider range of selection can be found than that offered by the various patterns of Gorham Silver Spoons, Forks and Serving Pieces. These are made in more than a score of distinctive designs varying from the least ostentatious to the most elaborately decorative, and put up in convenient chests holding complete sets, from the smallest combination to those containing every essential in flat silverware.

## GORHAM M'F'G CO.



CHICAGO,  
137 Wabash Ave.

Silversmiths and Goldsmiths

Fifth Avenue and 36th Street, New York.

BRANCHES:

NEW YORK,  
23 Maiden Lane.

SAN FRANCISCO,  
120 Sutter St.

LONDON,  
Ely Place.



WORKS: Providence and New York.

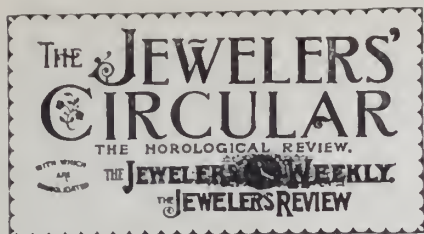

PUBLISHED EVERY WEDNESDAY BY  
**THE JEWELERS' CIRCULAR PUB'G CO.,**  
 11 JOHN ST. COR. BROADWAY, NEW YORK.  
 TELEPHONE: CABLE ADDRESS:  
 1148 CORTLANDT. JEWELAR NEW YORK

VOL. LII. MAY 9, 1906. No. 14.

Subscription in U. S., Canada and Mexico, \$2.00  
 Other Countries in Postal Union, . . . \$5.00  
 Single Copies, . . . . . .10  
 Remit by check or money order. Remittances in money are at sender's risk.

Notices of changes in standing advertisements must be received one week in advance; new matter can be received up to Monday.

No attention paid to communications unless accompanied by full name and address of the writer. This is asked not necessarily for publication, but as an evidence of good faith.

**Index to Special Articles.**

	Page.
A Handsome Diamond Collar. Illustrated on front cover, text on page.....	34
Attleboro Jewelry Manufacturers Favor Proposed Jewelry Trade-School.....	33
Silversmiths' Co.'s Stock Increased.....	35
Jewelry, Clocks, etc., Exported from New York.....	35
Tariff Decision as to Steel Watch Chains....	35
Death of Albert Wiggers.....	37
Death of David B. Lincoln.....	37
New Decisions on Real and Imitation Pearls..	37
Census Report on Jewelry and Silver Trades of Providence.....	39
Proceedings Against McKay Co. Settled....	39
San Francisco Jewelers Resuming Business in New Locations—Other News from the Stricken City.....	41, 43, 44
Imports of Clocks, Jewelry, etc., Into Canada.	45
Meeting to Form National Retail Jewelers' Association Called for Aug. 3 and 4.....	45
Death of William Oscar Cornell.....	45
Death of Kuno F. Keller.....	45
Death of Frank Harmon.....	45
Death of M. Lippert.....	45
Tiffany & Co.'s Foreman Accused of Padding Payrolls.....	47
Receiver Appointed for I. G. Dillon & Son Co.	47
Death of Rev. Henry Dutcher.....	47
Death of A. P. Boynton.....	47
Death of Hezekiah C. Bridgham.....	55
The Diamond Markets.....	61
Third Annual Meeting New Jersey State Optical Society.....	61
Popular Talks on Law—(Continued).....	68d
Patent Department.....	73
The Big Clocks That Give Time to New Yorkers in Manhattan, Brooklyn and the Bronx—The Shopping District.....	79
Why a Watchmaker Put an Inscription on Lincoln's Watch.....	87
A Clock Made of Bone.....	87
External Muscles of the Eye and Ocular Paralysis.....	91
Astigmatism Statistics.....	92
Anatomy of the Nervous System.....	92
Clever Advertising Scheme of a Jeweler in Northern Ontario.....	94
The Way of the Enterprising.....	95
An Attractively Designed Window Display..	95
Workshop Notes.....	97
A Plea for the Manufacture of Hard Paste China in England.....	99
Jewelry, Silverware, etc., Among Presents to the President's Daughter.....	99
Magnificent Candlesticks for Cathedral SS. Peter and Paul.....	101

**Large Gem Importations During April.** **W**ITHOUT a break the importations of precious stones continue to surpass all previous figures, the records of the jewelry examiner at New York, Gen. Geo. W. Mindel, showing that the value of the precious stones and pearls which came into this port last month were \$1,185,000 above the record breaking total of April, 1905; this is not only the largest amount ever recorded for April, but is one of the largest amounts ever recorded for a single month. Of the total, \$3,614,932, the value of the cut stones and pearls reached the enormous sum of \$2,682,707, which was over \$1,170,000 more than the value of these importations a year ago, while the value of the uncut precious stones, principally diamonds, amounted to \$932,224, the largest amount ever brought in during any April on record. It would be safe to say that the figures of last month established a standard that will be hard to pass in the future, no matter how good the business in the precious stone trade may be.

The following table affords a comparison of the values of the importations of precious stones at the Port of New York during April in the past 10 years:

April.	Cut.	Uncut.	Total.
1906.....	\$2,682,707.56	\$932,224.53	\$3,614,932.09
1905.....	1,511,945.78	917,392.41	2,429,338.19
1904.....	808,423.34	651,052.66	1,459,476.00
1903.....	1,449,853.76	508,364.55	1,958,218.31
1902.....	1,118,866.82	422,481.79	1,541,348.61
1901.....	1,579,491.72	718,545.13	2,298,036.85
1900.....	298,021.87	53,632.57	351,654.44
1899.....	583,210.65	472,903.16	1,006,113.81
1898.....	339,172.04	109,265.79	445,437.83
1897.....	21,639.72	31,671.58	53,311.30

**Proposed Jewelry Trade-School for Attleboro.**

**T**HAT the manufacturing jewelers of Attleboro approve of the report of the special commission appointed by former Gov. Douglas to study the subject of boys and girls employed in the State's industries, in so far as it recommends a trade school at Attleboro to teach jewelry-making, is evident from the interviews with the leading manufacturing jewelers of that section, published in another column of this issue; they also seem to acquiesce in the findings of the commission that a great majority of the graduates of the high schools are lacking in that "industrial intelligence" which would be manifest in a child who had been brought up with a technical education and had been taught to develop his eye and hand as well as his mind. The commission which was headed by the Hon. Carroll D. Wright, as told in THE CIRCULAR-WEEKLY, April 18, had a special committee study the conditions in Attleboro, which committee embraced Judge Warren A. Reed, Secretary George H. Martin of the State Board of Education and Mrs. Mary Morton Kehew. The expert who conducted most of the active work of the investigation was Dr. Susan M. Kingsbury.

It is evident that, before giving their final approval to all the suggestions of the committee in regard to a trade school in Attleboro, to be established by the State, many of the manufacturers are anxious to obtain more information as to exactly how such a school will be conducted, what the course of education will be and how the product

of such a school will be marketed (whether in competition with the manufacturers or otherwise); but in the absence of these details it is evident that the manufacturers approve the general plan, and if properly carried out will no doubt give the State authorities their hearty co-operation.

The need of better trained operatives to maintain the standard of work or to advance the quality of the product, particularly in the silverware line, has long been felt, and it is to be hoped that some action will be taken by the authorities of the Bay State Commonwealth toward putting the suggestion of its commission into practice, at an early date, that our Eastern manufacturers may have the benefit of properly trained young operatives, such as the German manufacturer enjoys to a great extent to-day.

**Jewelry Failures During April.** **S**TATISTICS relating to commercial insolvencies during the month of

April just passed show that the number of failures continues to decrease, as compared with the same months of 1905, there being 793 failures last month, as against 833 in the corresponding period of a year ago; the liabilities remained about the same, slightly over \$8,000,000 in each case. Of the total failures last month, 187 were in manufacturing lines, with liabilities of \$2,100,000; 575 were in trading lines, with liabilities of \$3,200,000, and 31 failures were among brokers and transporters, etc., with liabilities of \$2,700,000. On the whole, the total liabilities during the month of April were smaller than during any month since October last.

As far as the figures of the jewelry trade are concerned, the showing for the month is exceptionally good. There have been but 11 failures, with liabilities of \$64,025, an average of \$5,820, as against 13 failures in April, 1905, with liabilities of \$88,194. How these figures compare with those of April in former years is shown by the table giving failures by branches of business, compiled for *Dun's Review*, which records 20 failures in April, 1904, with liabilities of \$62,989; 14 failures in 1903, with liabilities of \$61,839, and 12 failures in 1902, with liabilities of \$107,711.

**Death of Hezekiah C. Bridgham.**

MYSTIC, Conn., May 2.—With the death, April 30, of Hezekiah C. Bridgham, Mystic lost one of its oldest residents and a well-known watchmaker.

Mr. Bridgham, who was 94 years of age, was a native of Middletown. When 14 years old he was apprenticed to Cheney Bros., of East Berlin, for the purpose of learning the watchmaker's trade. In 1840 he opened a store in Norwich, removing in 1852 to New London, where he remained three years, after which he came to Mystic. The deceased was actively engaged in business until two years ago.

Mr. Bridgham's genial nature and happy disposition made a host of friends for him. He is survived by three daughters, one son and several grand and great grandchildren.

Interment was in Yantic Cemetery, Norwich.

# FIRST HANDS



## CROSS & BEGUELIN

Importers and Cutters of Diamonds and Precious Stones

43 Rue de Meslay, PARIS

Telephone,  
2188 Cortlandt

17 Maiden Lane, NEW YORK.

## MOUNT SOME OF YOUR STOCK IN ARCH CROWNS

They will sell more readily because they appear larger and brighter. This is caused by the open "Arch" construction, which admits more light under the stone.

The new Completed Bearing Arch Crown Mounting affords perfect security and protection to the stone. It is made of rolled and toughened stock, and the perfect bearing and tip insure reliable stone setting.

**Arch Crown Mfg. Co** 26 Camp Street  
Newark, N. J.

Cross & Beguelin, New York.  
Kossuth Marx Jewelry Co., New York.  
Schrader-Wittstein Co., Chicago.

Eisenstadt Mfg. Co., St. Louis.  
M. Schussler & Co., San Francisco.  
Leonard Krower, New Orleans.

## Last Week's New York Arrivals.

THE CIRCULAR-WEEKLY each day posts in its office a Bulletin of the latest buyers visiting New York, which every member of the trade is cordially invited to copy.

- AKRON, O., F. B. Goodman (N. O'Neill & Co.), Cadillac.
- BALTIMORE, MD., I. J. Braun, Herald Sq.
- BOSTON, MASS., J. B. Hartford (Gilchrist & Co.), 55 White St.
- BUFFALO, N. Y., J. F. Jones, Herald Sq.
- CHICAGO, J. L. Felsenthal (Felsenthal Bros. & Co.), Herald Sq.
- CINCINNATI, O., Loring Andrews (Loring Andrews & Co.), St. Regis.  
Walter Meyer (Wallenstein, Meyer & Co.), Imperial.
- CLEVELAND, O., W. A. Cronenberger, Astor House.  
J. H. Heiman (Arnstein Bros. Co.), 65 Nassau St.
- DETROIT, MICH., W. A. Sturgeon (W. A. Sturgeon & Co), Holland.
- FRANKLIN, PA., R. L. Keplinger, Herald Sq.
- NEW HAVEN, CONN., E. F. McDermott (The Edward Malley Co.), Grand.  
Miss C. Potter (Howe & Stetson Co.), 75 Spring St.
- PHILADELPHIA, PA., G. Binder, Ashland.
- READING, PA., F. Wilson (T. A. Willson & Co.), Astor House.
- ROCHESTER, N. Y., A. L. Shaw (Sibley, Lindsay & Curr Co.), 454 Broome St.
- SANDUSKY, O., H. Dehnel, Belvedere.
- SAN FRANCISCO, CAL., B. M. Joseph (R. Weill & Co.), Wellington.  
Mr. Lewis (Shreve & Co.), Carter, Howe & Co., 9 Maiden Lane.  
R. L. Radke (Radke & Co.), St. Andrews.
- WASHINGTON, D. C., A. Rosenthal (M. Goldenberg), Grand.  
Mrs. J. C. Nourse (Woodward & Lothrop), Holland.
- WHEELING, W. VA., J. S. Gibb (Delaplin Dry Goods Co.), Imperial.
- WORCESTER, MASS., M. V. H. Densmore (Barnard, Sumner & Putnam Co.), 75 Spring St.

## Importations at the Port of New York.

Weeks Ended May 5, 1905, and May 4, 1906.		
	1905.	1906.
China, Glass and Earthen Ware:		
China	\$78,938	\$83,871
Earthen ware	14,697	15,391
Glass ware	21,540	18,441
Optical glass	2,936	661
Instruments:		
Musical	19,763	17,367
Optical	6,840	7,462
Philosophical	1,436	2,444
Jewelry, etc.:		
Jewelry	23,809	6,657
Precious stones	787,804	638,726
Watches	22,269	37,916
Metals, etc.:		
Bronzes	1,761	2,188
Cutlery	35,748	24,608
Dutch metal	7,495	6,943
Platina	10,066	39,043
Plated ware		294
Silverware	19	50
Miscellaneous:		
Alabaster ornaments		
Amber	8,112	9,008
Beads		3,398
Clocks	5,996	7,827
Fans	5,780	6,661
Fancy goods	5,881	6,340
Ivory	5,378	3,738
Ivory, manufactures of	770	358
Marble, manufactures of	6,494	20,075
Statuary	14,599	7,338

Thomas C. Kunkel moved recently from Weeping Water, Nebr., to Venango, Nebr. Milton, Gardner & Son, Clayville, Pa., have dissolved, Elgy Gardner continuing the business.

### New York Notes.

Judgment for \$120 was filed last week in favor of the Keller Jewelry Mfg. Co. and against Max Paul.

Judgment against the Gattle Jewelry Co. for \$159 was filed last week in favor of Frank P. Hoffman.

N. Schwartz moved last week from 1413 Third Ave. to 1422 Third Ave., where he had leased larger quarters.

I. I. Foster, of Milton L. Ernst, 12 Dutch St., left last week on his western trip, carrying his new line of samples.

Dr. Julius Moskovitz recently took charge of the optical department of the Knickerbocker Jewelry Co., 479 Fulton St., Brooklyn.

J. Freudenheim & Son have moved from the fifth floor to room 408 on the fourth floor of the Jewelers' building, 9 Maiden Lane.

L. Laubheim, of Laubheim Bros., 65 Nassau St., accompanied by his wife, left Saturday for the European diamond markets on the *Kronprinz Wilhelm*.

M. Moussaief and S. Kutner, both of Paris, France, arrived in New York last week and went on to visit the pearl fisheries of the Wabash.

Frederick Goldsmith, of Ingomar Goldsmith & Co., 182 Broadway, sailed April 28 on the *Finland*, and will pass about four months in Europe, most of the time in the diamond markets.

Some of the coins collected by the late Gen. L. P. Di Cesnola, for many years director of the Metropolitan Museum of Art, will be sold May 14 at the office of Lyman H. Low, 14 E. 23d St.

Among the exhibitors at the International Exposition, which opened May 1, in Tourcoing, France, is the Art Metal Goods Mfg. Co., which shows electric lamps in gold, silver and vert antique.

F. L. Peixotto will move this week from 10 Cortlandt St. to 182 William St. Mr. Peixotto several months ago bought out Joseph Friedman, who in turn was the successor of the Corbin Co.

Under a writ of certiorari the duty on metal beads is to be reviewed. The lower courts held that the duty should be 45 per cent. ad valorem as unenumerated articles and not 35 per cent. as beads.

Maurice L. Powers, of Powers & Mayer, 258 Fifth Ave., and Mrs. Powers returned from Europe last week on the *Carmania*. J. W. Mayer, of the same firm, also returned last week on the *Kronprinz Wilhelm*.

Klipper Bros. said yesterday that they will not appeal from the verdict of the jury against them in the suit which they brought against Ira B. Wiley, a jeweler of Springfield, O. The litigation, now ended, was in relation to the sale of a watch valued at \$175.

Charged with stealing six diamond rings valued at \$530, which were entrusted to him on memorandum, Jacob Barnett, 229 W. 15th St., was last week held in the Essex Market Court for the Grand Jury. The complainant was Harry Fagan, diamond dealer at 8 Delancey St. Barnett was released on \$1,000 bail.

Chas. Keller & Co., 73 Nassau St., have recently established a special department devoted to their foreign trade. Jose M.

Iberra, 33 Lamparilla St., Havana, is taking charge of the Cuban business; Joan J. Julia has been appointed South American representative, and offices will be opened in Buenos Ayres, Argentine.

Loring Andrews, of the Loring Andrews Co., Cincinnati, O., arrived in New York this week and registered at the St. Regis. He will sail to-morrow for Europe on the *Amerika*.

Friends of Julius Mamluck, of Julius Mamluck & Co., 68 Nassau St., received word last week that he and the members of his family who were in the train wreck between Cherbourg and Paris, France, escaped without injuries. Mr. and Mrs. Mamluck went across on the *Kaiser Wilhelm II.*, leaving New York, April 21.

A paper at Nyack, N. Y., reports the arrest of a traveling jeweler, who came from New York, on the charge of larceny, by transferring to a creditor a watch entrusted to him for repairs. A strange story is added, to the effect that the jeweler, after he arrived in Nyack, paid \$2 for a wife, buying her from the proprietor of a small eating house.

The sale of the sketches and completed works of Paul Noquet, the Belgian sculptor, who lost his life after a balloon ascension several weeks ago, was conducted last week by a number of his friends in the American Art Galleries, 6 E. 23d St., for the benefit of his mother and sister. Some of the statuettes have been cast in bronze by the Gorham Mfg. Co.

Plans were filed last week by Simon Frankel, of Joseph Frankel's Sons Co., 68 Nassau St., for his new building to be constructed at the southwest corner of Fifth Ave. and 47th St., at an estimated cost of \$200,000. The drawings call for an 11-story building. Maynicke & Franke are the architects. The store in this building has already been leased by Howard & Co., now at 254 Fifth Ave.

John Henry Buck, the well-known expert on old silver, who was for many years head of the ecclesiastical department of the Gorham Mfg. Co., and who is author of several works on old plate, and also of the series of articles on "Old Silversmiths of America," published in THE CIRCULAR-WEEKLY, was recently appointed curator of metal work in the Metropolitan Museum of Art. Announcement of his selection for this responsible position is made in the current issue of the *Bulletin* of the museum. The publication also contains much interesting information in relation to recent accessions of works of art at the institution.

Creditors of A. J. Rand, Holyoke, Mass., representing a majority of the accounts, met last Tuesday in the rooms of the Jewelers Board of Trade, New York, in accordance with a request received from him. He made a statement indicating that his liabilities were \$22,600, and he estimated his assets at \$17,686. This includes a valuation of \$16,145 on stock and fixtures, of which \$3,000 was for fixtures. Part of the stock, he said, was quite old. The accounts receivable amount to \$1,400, and the cash on hand was \$101. After a discussion the creditors decided to accept 25 per cent. in full settlement. Mr. Rand agreed to execute a deed of his assets for the benefit of creditors to a trustee to be selected by the Jewelers Board of Trade. This trustee will conduct

an auction, and out of the proceeds will make the payments on the 25 per cent. basis. The surplus will go back to Mr. Rand.

The case of Simon Goldsmith against the Solidarity Watch Case Co., which was dismissed by Justice Greenbaum of the Supreme Court, as briefly noted a week ago, was an action to recover \$2,500 for alleged breach of a contract for the employment of the defendant on a commission basis. The contract of employment was made Feb. 15, 1903, and the business relations of the plaintiff and the defendant ended Jan. 27, 1901. The plaintiff claimed that he had carried out his part of the contract and had been dismissed without proper cause. The defendant company denied this and charged that he had violated the contract in various ways, such as working for other manufacturers, not turning in collections promptly, obtaining improper percentages, selling to private persons and borrowing money from customers. H. L. Herzog, as attorney for the defendants, made the motion for the dismissal of the case, which was granted by the court. C. H. Machin represented the plaintiff.

Ludwig Nissen, of Ludwig Nissen & Co., 182 Broadway, during the past week has been the recipient of many congratulations from friends in the trade on the 25th anniversary of his entering the jewelry business. On May 1, 1881, he started as a partner of Fred. Schilling under the name of Schilling & Nissen, with a little office on the top floor of 51 Nassau St. Mr. Nissen's career has often been the occasion of articles in the public press, the writers citing him as an encouraging example of the self-made man. To a CIRCULAR-WEEKLY reporter he said yesterday, with a smile, that while not eager for this publicity he cannot object if his experience will in any way be used for the encouragement of young men. When he started in the firm mentioned, he frankly says, he had no previous experience in the jewelry trade, and could scarcely tell gold from brass. More than that, he knew nobody in the trade from whom to buy or to whom to sell. His partner was a repairer. "The first thing I did," said Mr. Nissen, "was to sweep out the office, because I could not stand such a dirty place. The second thing was to make an inventory of the business, which showed that we had \$3,000 less than nothing; that is, we owed that much more than our assets." Mr. Nissen went on the street after orders, and sometimes in the earlier years, after getting an order, had to borrow from the man giving it sufficient money with which to buy the gold. As he went about dealers offered him diamonds and other gems on credit, and he decided that if they could trust him he could afford to be trusted. Schilling & Nissen after two and one-half years changed to Ludwig Nissen & Co., the name which has continued since. Mr. Schilling remained in the firm five years. In 1885 the firm moved to 18 John St. When Mr. Schilling retired, A. C. Chase became a partner. This association continued for five years. After Mr. Chase retired Mr. Nissen admitted to the firm three men who had been in the employ of the firm for many years—Emil Knopf, John W. Ruefer and F. L.

IN THE HEART OF THE JEWELRY DISTRICT.

**Guardian Trust Company,**

170 BROADWAY, COR. MAIDEN LANE, NEW YORK.

**Capital and Surplus - Over \$1,000,000**

Equitable rates of interest allowed on surplus funds.

Collections on out-of-town items handled on reciprocal basis.

FRANK W. WOOLWORTH, President.

GEORGE W. FAIRCHILD, Vice-President.

CHARLES L. ROBINSON, Vice-President.

LATHROP C. HAYNES, Secretary.

ALFRED M. BARRETT, Asst. Sec'y.

Prominent Jewelers  
Among our Directors

LUDWIG NISSEN.

A. K. SLOAN.

LEOPOLD STERN.

**THE ORIENTAL BANK.**

ESTABLISHED 1853.

**182 and 184 Broadway, <sup>Corner</sup> JOHN STREET, NEW YORK.****Capital, - - - \$750,000.00.****Surplus and Profits, 1,100,000.00.****ACCOUNTS FROM THE JEWELRY TRADE ARE SOLICITED.**

R. W. JONES, Jr., President.

NELSON G. AYRES, First Vice-President.

GEO. W. ADAMS, Cashier

LUDWIG NISSEN,

ERSKINE HEWITT,

CHARLES J. DAY,

} Vice-Presidents.

R. B. ESTERBROOK, Assistant Cashier.

**The Market and Fulton National Bank of New York.**

ORGANIZED 1852

**81-83 FULTON STREET.****Capital, \$1,000,000.****Surplus, \$1,335,000.**

ALEXANDER GILBERT, President.

R. A. PARKER - - Vice-President.

T. J. STEVENS, - - - - Cashier.

JOHN H. CARR, - Asst. Cashier.

**Invites the Accounts of Jewelers.****Will extend every facility that good banking will justify.****SAFE DEPOSIT VAULTS.****The Chatham National Bank**

Broadway and John Street, New York

H. P. DOREMUS, Cashier

GEORGE M. HARD, President

W. H. STRAWN, Ass't Cashier

**THE STATE BANK**

376-378 GRAND STREET, NEW YORK

**Capital and Earned Surplus, over \$1,100,000. Deposits over Fourteen Millions.****Offers a favorable market for short and long time jewelry and diamond paper**

*The Mercantile National Bank  
of the City of New York*

*Cordially invites Accounts  
from Good Merchants  
in the Jewelry Trade.*

CONVENIENT LOCATION,  
AMPLE CAPITAL,  
LARGE SURPLUS,  
LONG EXPERIENCE.

*FREDERICK B. SCHENCK, President.*

*MILES M. O'BRIEN, }  
WILLIAM H. TAYLOR, } Vice  
                               } Presidents.*

*JAMES U. LOTT, Cashier,  
EMIL KLEIN, Asst. Cashier,  
ALFRED W. DAY, Asst. Cashier.*

<i>Capital,</i>	<i>•</i>	<i>•</i>	<i>•</i>	<i>\$3,000,000</i>
<i>Surplus,</i>	<i>•</i>	<i>•</i>	<i>•</i>	<i>\$3,000,000</i>

*Broadway, Corner of Dey Street,  
New York.*

# FANS FOR GRADUATION, WEDDINGS, CONFIRMATION.

HEADQUARTERS FOR THE MOST EXCLUSIVE LINE IN THIS COUNTRY.

Similar goods  
are not  
obtainable  
elsewhere.



They are of  
original design  
and my own  
creation.

## NECKLACES

IMITATION PEARL AND FANCY  
BEAD, IN ALL NEWEST SHADES  
AND EXQUISITE COLORINGS.

*Samples of Fans and Necklaces sent on request.*

**LOUIS STEINER, Importer,**  
520 and 522 BROADWAY, NEW YORK.

## Bigalke & Eckert Co.

== IMPORTERS OF ==  
**WATCHES**

Sole Agents for **Haas, Neveu & Cie.** Fine Geneva Watches

Plain Watches in all Styles, Grades and Prices. Chronographs,  
Split Seconds, Repeaters. Fancy Decorated Watches for Ladies.

Finest and Most Extensive Assortment of Flat and Ultra Flat  
Watches in the World.

No. 1 MAIDEN LANE,

NEW YORK



**New York Notes.**

(Continued from page 59.)

Wood. They have continued with him since. Two years ago the firm moved to its present quarters.

E. M. Weinberg & Co. moved last week from 276 New Jersey R. R. Ave., Newark, N. J., to 134 Mott St., New York.

Reuben Cohen, Chicago representative of the Acme Leather Goods Co., is spending a few days at the New York office, 562 Broadway.

Louis Friedlander, of R., L. & M. Friedlander, 30 Maiden Lane, returned Sunday on the *Amerika*. Mr. Friedlander procured some desirable diamonds while abroad.

R. Harris, of Harris & Co., Washington, D. C., who has been in Europe, with his family, for his health since last October, is now on his way home, much improved, and will arrive on the *Zeland*, of the Red Star Line, which is due in this city Monday next.

Henry Steelpflug, who was engaged in the diamond setting business in San Francisco, Cal., at the time of the earthquake, escaped injury and, with his wife, arrived last week in New York. He has rented an office in the S. F. Myers building, 47 Maiden Lane.

George W. Heath & Co. have moved their fountain pen and jewelry factory from 27 Thames St. to 380 Canal St., corner of West Broadway, where additional room and more facilities have been obtained in order to keep up with the growing demand of the business.

Members of the New Yorker Watchmakers' Society will have their annual walk next Sunday. They will go by trolley lines to Englewood and thence by train to Demarest, N. J., where their headquarters will be at the Midway Hotel, conducted by an old watchmaker and member of the society, Julius Friederich.

Charles N. Hancher, Wheeling, W. Va., has been in New York this week, and will sail to-day on the *Baltic* for Europe on his annual buying trip. He will pass several months visiting Amsterdam and Antwerp for the purchase of diamonds, and will spend some time in Paris, Berlin, Munich, Venice and Frankfort-on-the-Main in search of art novelties.

**Jewelers Gold Bars Withdrawn and Exchanged at New York.**

Week Ended May 5, 1906.

The U. S. Assay Office reports:

Gold bars exchanged for gold coin.....	\$443,083.65
Gold bars paid depositors.....	81,897.18
<b>Total .....</b>	<b>\$524,980.83</b>

Of this the gold bars exchanged for gold coin are reported as follows:

April 30.....	\$92,210.45
May 1.....	52,143.49
" 2.....	107,916.07
" 3.....	61,921.94
" 4.....	86,898.76
" 5.....	41,992.94
<b>Total .....</b>	<b>\$443,083.65</b>

Samuel Stone, Carbondale, Pa., and Miss Julia Mendelsohn were recently united in marriage in Wilkes Barre. After the ceremony the couple set out for New York on their wedding trip.

**The Diamond Markets.**

ANTWERP, April 26.—During the past two weeks there was a slight improvement in business, owing probably to the presence of a large number of foreign buyers, among whom were: Messrs. Presburg, M. Slobotsky, Goldschmidt, Eknayan, Hirschelson, Lazaroff, Vuillet, Roulina, Wims, Goldenberg, Slyper, Smale, B. Rapoport, N. Grunzweich, Vet, M. De Vries, Weissberg, Arons, Kricks, all of Paris; Messrs. Herzog, Herzfelder, Ben Rees, Jacob Strauss, New York; Mr. Sickles, Philadelphia; Mr. Fox, Cincinnati; Mr. Samek, Vienna; Messrs. Nava, Bellusky, Milan; Mr. Nelken, Madrid; Mr. Y. E. Slyper, London; Mr. Pollak, Moscow.

The demand for very small, white brilliants and roses of two to four grains still continues, but the sale of small, three-faces, as well as six-faces and brown roses, has fallen off. Large brown roses are being asked for, but not offered. On account of the large demand for rough goods and the scarcity of the same it is expected that there will be another advance.

On the occasion of the World's Fair of Liege in 1905, two well-known diamond merchants were made knights of the Leopold's Order, A. Adler and Mr. Michaux. Mr. Adler has been seriously ill, but is now better.

Work has been begun on the five buildings at Rue Leys for Louis Coetermans, diamond merchant. In one of these buildings will be the statue of Lodewyk van Berken, the inventor of the diamond polishing.

AMSTERDAM, April 25.—Business is still quiet, for though there is no small demand for goods, the desired articles are not obtainable. Very small roses and brilliants find a ready market. Large stones are not so much in demand.

The association of the employers and the diamond cutters made a contract, fixing the salaries for a year from June 1, 1905, to June, 1906, but the committee of the "bond" have been obliged to cancel this agreement, as the members demanded higher salaries than those fixed by the agreement.

**Providence.**

The factory of the Ostby & Barton Co. was closed last week for the annual inspection of boilers and necessary repairs.

It is probable that by the first of next month the new factory of the George W. Parks Co., on Aborn St., will be ready to begin manufacturing.

After a four weeks' trip to Germany and France, William Shackelford, well known in local jewelry circles, is back with a number of suggestions in the stone line.

Harry Fulford, of Fulford & Hobart, has been elected Grand Representative to the Sovereign Grand Lodge, I. O. O. F., from Rhode Island, the honor being conferred upon him at the annual gathering of the State order last week.

The amount of the local jewelers' relief fund for the San Francisco sufferers had reached, Monday, the total of \$3,150.25, a handsome showing by the employers and employes, who have contributed so liberally to aid their brethren in the stricken city.

The Narragansett Hotel presented an im-

mated scene last week, the early buyers having arrived to get a line on novelties and jewelry. Among those registered were H. Estinhausen, St. Louis; Albert Kunstader, Chicago; William Lehman, Baltimore; L. Block, Milwaukee; Herman Pichel, New York; L. Hahn, Cincinnati; George Crompton, St. Louis; Walter Mayer, Cincinnati; D. Bemis, Toronto; James Eastwood, New Glasgow, N. S.; J. L. DeGrazier, Dallas, Tex.; M. Hurvitz, Rochester, N. Y.

**Third Annual Convention of the New Jersey State Optical Society.**

NEWARK, N. J., May 8.—With President F. H. Hewlett in the chair, the third annual meeting of the New Jersey State Optical Society was called to order at 4 o'clock yesterday at 19 W. Park St., this city.

Following the routine business nominations for officers were called for, and the election resulted as follows:

President, L. B. Hilborn; vice-president, Robt. G. Smith; secretary, Jos. J. Hartman; treasurer, Louis A. Rochat.

Executive Committee: J. E. Jacckle (chairman), C. J. Brotherly, F. H. Hewlett, Robt. G. Smith and J. S. Wheeler.

Applications for membership were received from Messrs. De Grote and Croft; the by-laws were suspended and they were duly elected members. A communication, signed Dr. F. J. Monohan, created spirited action. The writer desired membership in the society, stating that though he called himself "Doctor," he was not a physician, but wanted his certificate engrossed "Dr.," as there was no law prohibiting the use of that title by any one. The society, with one voice, disapproved of such action, and voted that Mr. Monohan's money be returned to him and his application refused.

Instead of holding one business and three social meetings each year, the society will hereafter hold four quarterly business meetings. A hearty vote of thanks was tendered the retiring officers, following which President-elect Hilborn made a speech that showed in every sense his fitness for the office and the strict manner in which the society's business will be carried on during the coming year. Following the business session, Prof. R. M. Lockwood lectured upon "Practical Points on Fogging," and Alfred Wenzel upon "Eye Nerve Strain," both of which were highly instructive and interesting.

Having freely partaken of the intellectual feast, the members, in a body, adjourned to the banquet hall to satisfy their more material needs. President Hilborn introduced P. A. Dilworth, of New York, who, after some graceful remarks, asked to be permitted to talk "shop." He then urged that all optometrists charge a fee for examination. This was met with strenuous opposition by the New Jersey members. An impromptu debate was arranged, and Messrs. Dilworth and Ryer took the positive, while Messrs. Hilborn and Lening took the negative side. Later all members were asked to join in the discussion, which was done with a friendliness rarely surpassed. The discussions were warm, as the subject is of vital importance to all, yet it was carried on in an open-spirited manner, and all feel that a great step forward has been taken toward settling this trying question.



## Ball's Official Standard R.R. Watches

WHAT WOULD YOU GIVE FOR A LIFELONG CUSTOMER?

Try this plan.

Sell your next watch customer a "Ball."

Its reliable performance will convince him you are a dealer to be depended on—he'll keep coming back for other things.

The watch will win you his business and friendship for always.

*Write for booklet, and watch this space.*

We want to add a lot of new friends to the Ball family of railroad watch dealers.

### THE WEBB C. BALL WATCH CO.

CLEVELAND  
Ball Building

CHICAGO  
804-6-8 Railway Exchange

ESTABLISHED 1854.

INCORPORATED 1893

JUERGENS & ANDERSEN CO.,  
DIAMONDS,  
MAKERS OF FINE JEWELRY,  
92 TO 98 STATE STREET,  
CHICAGO.

23-25 Looijersgracht Amsterdam, Holland.

# THE HERMAN KECK MFG. CO.

## CUTTERS OF

# DIAMONDS.

### FOR SALE.

A complete diamond cutting outfit of twenty benches, European make, consisting of sawing machines, rounding machines, laps, tongues, dops, scouring stands, etc., all in first class condition. Will sell cheap, if sold in bulk at once, as we have replaced them with American tools.

MANUFACTURING JEWELERS, SILVERSMITHS.  
Recutting and Repairing of Diamonds.

17-19-21-23 West Fourth St.,  
CINCINNATI, O.

## RUDOLPH NOEL & CO.

IMPORTERS OF

Diamonds, Pearls, Rubies, Emeralds, Sapphires, Opals, Olivines,  
Cat's-Eyes, Rose Diamonds and Reconstructed Rubies

2 Tulp Straat, AMSTERDAM

Phon. 1902 John

37-39 Malden Lane, NEW YORK



# WESTERN DEPARTMENT

Western Office:  
204 COLUMBUS MEMORIAL BUILDING,  
CHICAGO.

Telephone:  
4079 CENTRAL,  
CHICAGO.

VOL. LII.

CHICAGO, WEDNESDAY, MAY 9, 1906.

No. 14.

## Chicago Notes.

Geo. J. Gubbins has returned from a western trip.

Sig. Stern, of Stern Bros. & Co., paid a visit to Chicago last week.

M. I. Loeb, of the Dueber-Hampden companies, was in this city last week.

Tom Boylan, with Manning, Bowman & Co., is here from the Pacific coast.

A. Max Holtzheimer has established himself in room 502, Heyworth building.

The name of the Photo Jewelry Mfg. Co. has been changed to the Cruver Mfg. Co.

A new retail jewelry store has been opened on Monroe St., just west of State St.

Edward Alberti, retail jeweler at 900 Milwaukee Ave., will sail for Europe in June.

The Schafer Jewelry Co. has removed from 124 Washington St. to 134 Madison St.

W. A. Fay, with the John T. Mauran Mfg. Co., has returned from a western trip.

E. S. & W. S. Fowler, opticians, have removed from 96 State St. to 143 Wabash Ave.

H. E. Cobb, with the Daggett & Clap Co., returned last week from a visit to the factory.

F. H. Challen, of the Ohio Cut Glass Co., has removed from room 208 to room 201, 35 Randolph St.

Robert L. Clark, with the Towle Mfg. Co., returned last week from San Francisco with his wife and baby.

Dan Axman received the congratulations of his friends, last week, when he became the father of a fine boy.

Henry E. Cohen has secured the gold mounting line of a New York firm, which he will represent in Chicago.

M. L. Levy & Co., San Francisco, have notified the trade here that they have opened offices at 461 13th St., Oakland, Cal.

A telegram to Jack Stanley from J. E. Birmingham, of Shreve & Co., San Francisco, says that "all the boys are well."

G. A. Le Roy, of the Western Clock Mfg. Co., La Salle, Ill., paid a visit to the Chicago office of the company last week.

R. W. Cohen is on a visit to the factory of the Acme Leather Goods Co., New York, which concern he represents in Chicago.

Benj. Allen, accompanied by Mrs. Allen, returned last week from a two months' sojourn at Atlantic City and Lakewood, N. J.

C. E. Child, with the C. M. Robbins Co., left, last week, for the east, to visit his parents, who are reported to be dangerously ill.

E. A. Moore, representing Albro & Kettely and Sikes & Strandberg, has taken an office on the 10th floor of the Silversmiths building.

Larry Edwards, with the Chas. E. Hancock Co., and Jim Edwards, with the B. S. Freeman Co., left Saturday on a trip through the middle west.

Harry E. Farquharson, representing E. A. Potter & Co. and E. D. Gilmore & Co., has removed from room 603 to room 716, Columbus Memorial building.

O. F. Samuelson, Pacific coast salesman for the Towle Mfg. Co., arrived here last week. Mr. Samuelson did not lose his samples, as reported last week.

F. R. Sheridan, with Arnold & Steere, left for the Pacific Coast, Saturday. Mr. Sheridan will return with his wife and family, who have been spending the Winter as Los Angeles, Cal.

Richard Vaeth, Tacoma, Wash., passed through here last week, on his way home. Mr. Vaeth was accompanied by his daughter, who had been attending a college in Massachusetts.

D. B. Ward, formerly with the Woodstock-Hoefler Watch and Jewelry Co., Kansas City, Mo., was here last week buying stock. Mr. Ward has entered the jobbing field in Kansas City.

Harry Jehlinger, formerly jewelry buyer for The Emporium, San Francisco, which was totally destroyed, arrived here last week, with his wife and family. Mr. Jehlinger will settle here.

H. P. Cutter, formerly with Regnell, Bigney & Co., is now living on his fruit farm at Lake Cora, Mich. Mr. Cutter is vice-president of the Independent Fruit Growers' Association of that town.

Herbert W. Allen, of Herbert W. Allen & Co., diamond merchants in the Columbus Memorial building, will sail for Europe the latter part of June on a visit to the diamond markets. Mr. Allen will accompany him.

Aug. Maschmeyer, well known in the silverware and cutlery trade, was here last week. Mr. Maschmeyer has opened a jobbing, silverware, cutlery and cut glass busi-

ness in St. Louis, at 6th and Olive Sts., under the name of the Maschmeyer-Richards Silver Co.

The Bauer Jewelry Co. has been incorporated in Elgin, Ill., with a capital of \$8,000. The incorporators are: William D. Ackermann, Oliver Rystrom and Paul Zumkeller. This is an old established business under a new name. Mr. Bauer, the founder, died two years ago.

J. J. Altpeter, an old time jeweler and politician, died of heart failure last Sunday and was buried Saturday. Mr. Altpeter formerly had a jewelry store at 801 S. Halsted St. In 1878 Mr. Altpeter was elected Alderman in the 19th Ward and served two terms. In 1889 he was made sanitary trustee and served six years.

Charles Conner, alleged to be the man who smashed the window of the Bauman Jewelry Co., last November, was arrested here last week. Joe Bauman identified him as the man who smashed the window and stole a diamond heart valued at \$5,000 and a diamond lorgnette chain valued at \$3,000. The heart was subsequently found and returned to the Bauman Jewelry Co.

Sol Caro, formerly a salesman for Madison & Steele, who was arrested on a charge of embezzlement and robbery by the latter concern, was discharged last week and declared not guilty by a jury in Judge Honore's court. No evidence was heard, the question being whether or not the crime had been committed in the State of Illinois. Judge Honore decided he had no jurisdiction and the jury was instructed to return a verdict of not guilty.

F. M. Drummond, credit man for the Towle Mfg. Co., was held up and robbed, last Wednesday, at 11.30 p. m., in front of his residence, 443 Dearborn Ave., by three young bandits. With one revolver held at his stomach and another at his head, Mr. Drummond was separated from \$58 in cash, a gold watch and chain valued at \$70 and a pearl scarf pin. The police have arrested a man named Riordan, who is suspected of being one of the robbers.

Mr. and Mrs. James Galloway Hallas have announced the marriage of their daughter, Charlotte Louiz, to William Alf Beckingham. The wedding took place April 28, at Grand Rapids, Mich. Mr. Beckingham is buyer and manager of the silverware

# To the Jobbing Trade.



Everything in the way of  
Mountings and Diamond  
Mounted Jewelry.

We especially invite  
you to see our new line  
of rose, green, and rose and  
green finish rings, made  
for the coming season.



department of Pitkin & Brooks, State and Lake Sts. The bride and groom are on a wedding tour and sailed from New York, Wednesday, on the *Teutonic*. They will visit London, Paris, Southampton, Birmingham, Edinburgh, Glasgow and Liverpool, returning in September, via Montreal, Toronto and Buffalo to Chicago.

Disturbances in the money market and the illness of Julius Kahn were given before Judge Bethea last week as the reasons for the delay in the rehabilitation of the Cash Buyers' Union, last week. E. C. Day, the receiver, reported that he had not received a sufficiently large bid for the assets and said that the proposed \$500,000 syndicate had also made no bid. The case was continued. This week Postoffice Inspectors Ketcham and Kimball will present evidence to District Attorney Morrison for his final decision as to whether an officer of the company should be prosecuted for using the mails to defraud.

## Minneapolis and St. Paul.

The New Store, a department store, Minneapolis, is selling out its jewelry department.

Samuel Ruben has left Rentz Bros., Minneapolis, to engage in business for himself at White Bear Lake, Minn.

Pinck Bros., formerly in the manufacturing jewelry business in the Bank of Minneapolis building, Minneapolis, have retired.

George H. Rentz, of Rentz Bros., Minneapolis, mourns the death of a valuable dog, a Boston terrier. The canine was valued at \$500.

A brief description of the early business career of G. B. Eustis, of Eustis Bros., Minneapolis, accompanied by a photograph of Mr. Eustis, appeared in the *Minneapolis News*, May 1.

The White House Department Store will open in St. Paul, at 7th and Cedar Sts., about Aug. 10. Sternberg & Gottschall are the proprietors, and have temporary offices with their wholesale house, at 4th and Wacanta Sts.

Axel Mohn, who was with John Bodfors, Minneapolis, as watchmaker, but left several months ago, to go to San Francisco, was in the ill-fated city during the earthquake and fire. He has since made his way back to Minneapolis, and has resumed his position with Mr. Bodfors.

Oscar Blackburn, for the past eight months instructor in watchmaking at the Minneapolis School of Watchmaking and Engraving, Minneapolis, has returned to his old position as watchmaker and engraver with Weld & Sons, 524 Nicollet Ave., that city, and is no longer connected with the school in any way.

The offer of S. W. Thompson and other stockholders of the Anchor Silver Plate Co. for a release of the city's interest in the site of the company's plant, St. Paul, was laid over two weeks by the Aldermanic Committee on Streets, recently. The stockholders have offered the city \$1,200 for the city's interest in four lots or \$2,500 for the city's interest in two lots. The stockholders have offered to sell their interest to the city for \$5,000, and the matter was deferred until after Dr. Ohage's return from Europe.

## St. Louis

E. L. Bersche, Columbia, Ill., was among the visiting jewelers here last week.

E. A. Reed, of Reed & Barton, was one of the visitors to the local trade last week.

W. R. Haselwood, Bardwell, Ky., was one of the buyers in the local market last week.

Mrs. Ida Spieldoch, formerly with Weiss & Fassett, is now with the E. Maritz Jewelry Mfg. Co.

The members of the Mermod, Jaccard & King Co-operative Association held a meeting Tuesday evening.

James J. Burke, president of the Brooks Jewelry & Optical Co., has purchased a new home in Tower Grove Park.

The Mermod, Jaccard & King Jewelry Co. has been conducting an auction all week with much success. Art goods are being disposed of.

Three watches of the value of \$35 were stolen from the window of Paul Ducommun, 2731 Chouteau Ave., early Monday morning of last week.

George Hess, of the Hess & Culbertson Jewelry Co., has been riding horseback a great deal lately for the benefit of his health, which is greatly improved. Mr. Hess is a familiar sight in the parks on a prancing steed.

Alvin L. Bauman, president of the L. Bauman Jewelry Co., departed Saturday for an extended trip to Europe. Mr. Bauman will sail from New York on May 17 on the American-Hamburg boat *Blicher*. He will go direct to Paris.

The Mermod, Jaccard & King Jewelry Co. furnished nine silver cups competed for in the Marathon race run Sunday under the auspices of the Missouri Athletic Club for the benefit of the San Francisco sufferers. The cups ranged in price from \$250 down.

Joseph Linz, of Joseph Linz & Bros., Dallas, Tex., was here last week, accompanied by Edgar Pike, manager of the diamond department, and Arthur Linz, manager of the mail order department of the same firm. Mr. Linz reports that Texas is in a flourishing condition.

The Scruggs, Vandevoort & Barney Dry Goods Co., and the Simmons Co., two department stores, have consolidated, and will occupy the first eight floors of the Century Annex and a large part of the Century building, which together cover the entire block bounded by 9th, 10th, Olive and Locust Sts. The capitalization was at \$5,250,000. The annex is yet to be built. According to W. J. Holbrook, of the Holbrook-Blackwelder Real Estate & Trust Co., which conducted the negotiations connected with the merger, a well known St. Louis jewelry house has made a proposition to the syndicate to secure the five-story building at 11th and Olive Sts. Mr. Holbrook declined to give the name of the concern.

The Association of Jewelry Jobbers of Missouri is the name given to the organization of the jobbers, mention of which has already been made in THE CIRCULAR-WEEKLY. A meeting of the association was held last Thursday, when the constitution and by-laws submitted by the committee, of which M. Eisenstadt, of the Eisenstadt Mfg. Co.; A. L. Bauman, of the L. Bauman Jewelry Co., and I. N. Hahn, of the S. A. Rider Jewelry Co., are members, were

adopted. The organization will be incorporated and a movement will be made to encourage organizations of jobbers in other cities to become members, making the association national in its scope. In the absence of the temporary chairman, Ed. Massa, of the Bauman-Massa Jewelry Co., Frederick W. Hoyt, of F. W. Hoyt & Co., presided at the meeting.

## Kansas City.

The C. B. Norton Jewelry Co. has increased its capital stock to \$150,000.

H. B. Lindsey has sold his retail jewelry business at 201 E. 12th St to Abe Blicden.

The Kansas City Polytechnic Institute has just put in new machinery for manufacturing jewelry.

H. F. Rover has taken a position in the accounting department of the Woodstock-Hoefler Watch & Jewelry Co.

Charles Moll, who has been in the employ of F. Winkler, has resigned and returned to his home in Gardner, Kans.

Sam Bloom, traveler for the Meyer Jewelry Co., was in this city, last week, having been called in to help entertain the visiting jewelers.

C. B. Norton, of the C. B. Norton Jewelry Co., is making arrangements to leave with the Commercial Club next week, on its trade extension trip through Kansas and Colorado.

The Green Jewelry Co. supplied the medals to the Central High School, which were given as prizes in contests for the best original essays, etc.

Harry Winkler, who has been with Otto Burklund, Osawatomie, Kans., has come back to this city, and will take the place in his father's store formerly held by Charles Moll, who resigned.

Mr. Scott, of Scott & Scott, Junction City, Kans., recently met with an accident, which brought him back to a hospital here again to take further treatment. He is reported to be getting along well.

It is believed that at the next meeting of the City Council C. L. Merry, president of the Merry Optical Co., will be elected a member of the upper house, to fill the vacancy made by the election of one member to the presidency of that body.

A judgment for \$1,170 was, last week, entered against J. R. Mercer, in favor of a real estate firm, which was suing for a commission on the five years' lease recently closed by Mr. Mercer with the United Cigar Stores Co. for the corner of 11th and Main Sts. There was a dispute as to whether Mr. Mercer owed this commission.

The following out of town jewelers called on the jobbers during the past week: A. J. Kibler, Wellsville, Kans.; B. G. Gustafson, Lawrence, Kans.; E. A. Church, Claremore, Ind. T.; Geo. H. Church, Oak Grove, Mo.; C. B. Libby, Weir, Kans.; A. J. Levin, St. Joseph, Mo.; J. A. Schmidt, Leavenworth, Kans.; Otto Burklund, Osawatomie, Kans.; N. M. Porter, Longton, Kans.

The following new pupils were enrolled by the Southwestern Optical College during the past week: R. F. Mann, Wagoner, Ind. T.; E. E. Parnell, Kansas City, Mo.; Albert E. Howell, Excelsior Springs, Mo.; S. T. Reese, M. D., Kansas City, Mo.; C. H. Meyerhoff, Brookfield, Mo.; E. G. Marson, M. D., Cawker City, Kans.; S. M.

Bishop, Springfield, Mo.; J. F. Nasep, Alva, Okla.

Sam W. Ewan, one of the most valued employes of the C. B. Norton Jewelry Co., who numbered his friends by the score in this city, and who left here March 4 to go to New Mexico for his health, died in that territory, May 3, of tuberculosis. Mr. Ewan was 29 years of age, and leaves a widow. He was a Scottish Rite Mason, and the Masons had charge of his funeral, which was held in this city, Sunday. His loss will be keenly felt by many devoted friends, and greatest of all by his employers.

## Omaha.

Chas. Mankey, Manning, Ia., has taken a position with L. Robinson, Glenwood, Ia.

P. E. Flodman, of P. E. Flodman & Co., has returned from an extended trip in Alabama.

Chas. Moorehouse, vice-president of the Kennedy Optical Co., was a visitor in this city last week.

C. L. Shook, of the Shook Mfg. Co., left last week for a two months' trip through the west and northwest.

Sol Bergman, of the Sol Bergman Jewelry Co., is making a business trip through the western part of the State.

E. A. Dayton, of E. A. Dayton & Co., Chicago, but formerly of this city, was a visitor here for a few days recently.

E. E. Muffitt, vice-president of the H. J. Penfold Co., attended a meeting of a medical association held at Lincoln last week.

Chas. Jordan, formerly with the H. J. Penfold Co., visited friends in this city last week prior to leaving for Cincinnati, where he will take charge of his father's business.

Herman Lefferts, formerly of Council Bluffs, Ia., who has spent the past two years in California, is expected to return shortly, when he will re-engage in business in Council Bluffs.

Mrs. Underwood, Murray, Nebr.; C. H. Curley, Belden; J. A. Reuling, Wynmore; Henry Zellers, of Zellers & Kusel, Hooper; Peter Wiese, Deshler, were in this city buying stock last week.

Chas. W. Fleming, Lincoln, Nebr., visited this city, recently, upon the receipt of information that the stock, valued at \$1,000, which was stolen a short time ago from his store had been located in a pawnshop in this city.

J. L. Fitch was recently taken into custody in Beland, Wis., after having been sought for several weeks on a charge of obtaining a gold watch from the store of F. C. Cook, Janesville, Wis., under false pretenses. The timepiece, which was valued at \$30, was recovered.

At the Montreal Board of Trade, recently, the citizens' gift was presented to ex-Mayor Hormidas Laporte, in recognition of his valuable services as alderman and mayor. The gift took the form of a handsome cabinet of solid silver, comprising a complete tea service with tray, and a full service of solid silver knives, forks, spoons and serving pieces. The service was made by Henry Birks & Sons, Montreal.

**GUESSING HAS CEASED TO BE A VIRTUE.**

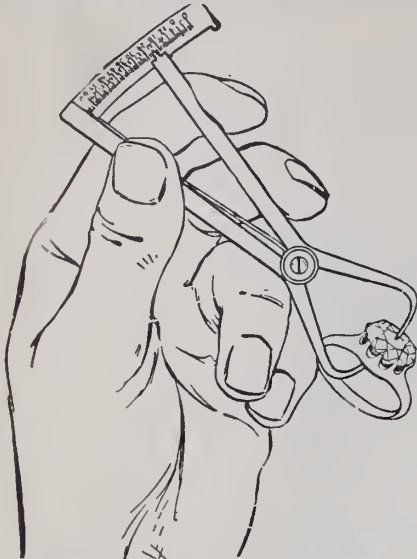

**THE MOE DIAMOND WEIGHT GAUGE**

is the only correct system for determining the weight of mounted diamonds.

**INDORSED BY THE LEADING JEWELERS.**

Those who are not familiar with the device, kindly send for descriptive booklet.

**Charles Moe, Inventor, 80 Adams St., CHICAGO, U. S. A.**

Price for Instrument and Book, \$3.75 prepaid.

May also order from the following agents:  
 D. C. PERCIVAL & CO., Boston; CROSS & BEGUELIN, New York; M. SICKLES & SONS, Philadelphia; NORDMAN BROS., San Francisco; E. & J. SWIGART, Cincinnati; H. BIRKENHAUER & CO., Minneapolis.  
 BACKES & STRAUSS, Sole Agents for Europe and India. London, E. C. 14-17 Holborn Viaduct.

**The Prompt and Accurate**

Mail Order House for Jewelers' Supplies.

**LINDNER & CO.,**  
 CINCINNATI, O.

**San Francisco.**

News was received here recently of the death of J. D. White, Santa Cruz.

L. Plamondon has severed his connection with the California Jewelry Co. and taken a position with Henry M. Abrams.

Mat Moskowitz, watchmaker for the trade here, has changed his name, and will hereafter be content to be called Mr. Mosk.

When the safe of C. Grundel, formerly on Kearny St., was opened, recently, it was found that the coin there had melted and run together, imbedding about 20 diamonds in the mass. The stones appear to be in good condition.

The following opticians, formerly in business in San Francisco, have reopened in that city with more or less complete stocks: Berteling Optical Co., 2505 Clay St.; Henry Kahn & Co., at the Emporium's temporary quarters, Post St. and Van Ness Ave.; Hirsch & Kaiser, 1725 Fillmore St.; Crawford Optical Co., 2076 O'Farrel St.

A. Eisenberg, of A. Eisenberg & Co., has recovered, through the police, \$12,000 worth of diamonds, which have been missing since the day of the great earthquake and fire. The gems consisted of diamond rings and a large diamond star. The diamonds were rescued from the jewelry store on Kearny St. and taken to S. Clayburg, a broker, for safe keeping. Clayburg claimed that the gems had been stolen from him, but when the detectives told him they had proof that he still had them in his possession, he allowed the detectives to open a trunk that was at his home and the diamonds were found stored there. A. Eisenberg refused to prosecute the offender and the jewelry was restored.

The stock in the store of Daniel H. Strock, Hot Springs, Ark., was damaged by a fire which broke out recently in the Sumpter-Little building at that place.

**Pacific Coast Notes.**

Geo. W. Hickox, Albuquerque, N. Mex., visited Santa Fe, N. Mex., on a business trip, recently.

S. Spitz, Santa Fe, N. Mex., has been attending the Spring reunion of the Denver bodies of the A. and A. S. R. of Free Masonry.

John von Breton, Los Angeles, Cal., has decided to close out his stock of jewelry in order to devote his time to the optical business.

H. Britzius and F. Pequegnat, Riverside, Cal., have moved their jewelry stock from the Reynolds block to 850 Main St., next to the Rouse stores.

Mr. Wilson, Los Angeles, Cal., will soon open a store at Ocean Park, Cal., in the building formerly occupied by E. D. Grandmason, who has moved to 153 Pier Ave.

Chas. Kelley, who has conducted a jewelry and watch repairing store at Lebanon, Ore., has sold out and moved to Myrtle Creek, where he may open a store in the near future.

The store of C. P. Houston, Junction City, Ore., was entered recently by thieves, and jewelry valued at about \$200 was taken. Later Mr. Houston received through the mail a letter containing drawings of skulls and bones and a number of fine shavings.

J. H. Sohn, who has been head watchmaker and optician for E. D. Grandmason, Ocean Park, Cal., is about to open a jewelry and optical establishment on Pier Ave., at that place.

The marriage is reported of C. W. Costello, Pleasanton, Kans., to Miss Minnie Peterson.

Thieves smashed the large window in the store of Adolph Mandel, McKeesport, Pa., about a week ago and escaped with a small amount of miscellaneous stock.

**DIAMOND RING MOUNTINGS**

ALL STYLES AT POPULAR PRICES

Diamonds and Precious Stones

High Grade Jewelry

**GEBHARDT BROS.,** Lion Building, CINCINNATI, OHIO

Exact Size.

Exact Size.



A

WILL NOT OPEN WITHOUT AID OF FINGERS



B

NO DANGER of enamel Breaking on Frail Pins When Catch is used

Patentees and Makers of

**VICTORY ATTACHMENTS**

EASIEST APPLIED.

NO POINTS TO SOLDER ON.

Special Size.



EXACT SIZE.



Full Cut

A

B

Threads.

Samples on application. NOTICE.—Victory Button Back has full cut threads throughout. Sold on its merits.

**JOS. NOTERMAN & CO. DIAMONDS**

IMPORTERS AND CUTTERS

Recutting and Repairing odd shaped and chipped stones a specialty. Manufacturers of Mountings and Fine Jewelry. Special Designs Furnished.

CINCINNATI, OHIO.

## Cincinnati.

Hugo Lindenberg, of Lindenberg & Fox, has returned from a business tour of the south.

M. J. Greenwald, 33 Arcade, is about to open his new branch jewelry store in the Arcade.

Arno Dorst, of the Dorst Co., is at his office again, having recovered from a severe attack of fever.

Walter Meyer, of Wallenstein, Meyer & Co., has gone east for 10 days in the interests of the firm.

Lindner & Co. furnished the new machinery which was recently installed as the plant of Herman Pronnitz.

A few nights ago thieves entered the jewelry store of Seiter Bros., 13th and Vine Sts., and stole a lot of jewelry.

Michaelson Bros. have opened up a manufacturing jewelry business on the third floor of the Excelsior building, Race St.

The health of Henry A. Dodt, 26 Emery Arcade, has improved so much that he expects to visit his office during the present week.

J. M. Shields, formerly a material clerk for Thoma Bros., has accepted a position with the W. P. Hitchcock Co., Syracuse, N. Y.

Gebhardt Bros., on account of their increasing business, are enlarging their factory and adding to the machinery and working force.

Loring Andrews, of the Loring Andrews Co., left May 5 for New York, from which city he will sail to-morrow on the *Amerika* for Europe.

James Haslam, representing the John Holland Gold Pen Co., has received word of the safety of his brother, who was thought to be a victim of the San Francisco earthquake.

Joseph Noterman & Co., during the past week, have had their quarters in the hands of painters and frescoers, whose work, when completed, will make these offices among the finest in town.

Sig. Strauss, of Lindenberg, Strauss & Co., has returned from a trip to New York and Atlantic City. C. J. F. Bene, formerly of Bene, Lindenberg & Co., is home from a recent visit to his southern plantation.

Gus Hengehold, watchmaker for Henry Korf, 625 Main St., had a narrow escape, a few days ago, when a ball bat came crashing through a window near which he was working. No damage was done, except to the glass.

During a wind storm which swept over Cincinnati, a few nights ago, the big plate glass corner window in George W. Newstedt's store was shattered and the stock on display was slightly disarranged. None of the stock was broken or stolen.

His many friends in the jewelry trade heard with regret of the recent death of Charles Oppenheimer, a retired merchant and father of Isadore Oppenheimer, of Hahn & Oppenheimer. The deceased was one of Cincinnati's best known and most respected merchants. He died last week at his residence, 546 Hale Ave., Avondale, at the age of 78 years.

The suit brought against B. Greenwald, 514 Race St., and Detective Crim by John Sternberger, an eastern traveling man, was

last week dismissed in the United States Court in this city. Sternberger alleged that the above parties were trying to ruin his business reputation. About a year ago he was arrested by Crim on a charge of purchasing goods from Greenwald's store on memorandum and not paying for them. After the arrest the money due was paid and Sternberger was released; he then brought suit.

Out of town dealers who bought stock here during the past week included: A. Wahlrab, Dayton, O.; Henry Ostendorf, Vincennes, Ind.; A. M. Stamm, Williamsburg, O.; L. C. Eveslage, Ripley, O.; J. G. Davis, Bellefontaine, O.; E. G. Correll, Somerset, Ky.; John P. Hess, Fond du Lac, Wis.; Charles Creighton, Morrow, O.; J. G. Irwin, Harriman, Tenn.; W. C. Carroll, Lebanon, Ky.; O. E. McWaters, Somerset, Ky.; J. T. Schaub, Hope, Ind.; Fred J. Heintz, Lexington, Ky.; Edward Israel, Harrison, O.; Nicholas Sanning, Walton, Ky.; E. Shelman, Irvington, Ky.

## Denver

Meyer Hellerstein has moved to 824 15th St.

J. C. Bloom & Co. are decorating and making extensive alterations in their store.

William Pearson, Louisville, Colo., was visiting the local wholesale dealers last week.

Charles Pierson, Orleans, Nebr., made a flying trip to Denver and Boulder on business last week.

Mr. Murchison, Cheyenne, Wyo., was a recent visitor to the city, combining business and pleasure.

A. M. Jacoby, of Edward Lehman Jewelry Co., has returned from a pleasure trip to California and Arizona.

J. C. Wakefield, Durango, Colo., was a recent visitor in Denver, on his way to California, where he intends to start in business.

H. B. Kortz has purchased the stock of S. Nelson, 929 15th St., and will move from his present location, 917 15th St., to Mr. Nelson's store.

R. C. Hawkins, of the Edward Lehman Jewelry Co., has returned from a business trip to Washington, Montana, Idaho, Wyoming and other parts of the northwest.

Walter Farrell, formerly of J. C. Anderson & Co., Telluride, Colo., was in Denver last week buying from wholesalers for the business he is about to open in Montrose, Colo.

C. N. Welch, of W. W. Hamilton & Co., is on a business trip through Colorado and New Mexico, and S. L. Benty, of the same firm, is at present traveling through the northwest.

A. F. Lowenthal, 37 Maiden Lane, New York, was a recent visitor in Denver, on his way home from the Pacific coast. Directly on reaching New York Mr. Lowenthal will sail for Europe.

O. T. Craig, of Bentley & Craig, Boulder, Colo., was here for a few days last week. He is on his way to the Pacific coast and the northwest for an extended business and pleasure trip.

A large rock was thrown through the window of the Solomon Jewelry Co.'s store early one morning last week, by a mis-

creant, who then quickly rode away on a bicycle. No reason for the act has been discovered.

Henry Jacobson, of Jacobson Bros., has arrived in this city from Los Angeles, Cal. By a fortunate circumstance Mr. Jacobson visited Los Angeles before going to San Francisco and thus escaped the earthquake and the fire.

William Fleischman, of J. C. Bloom & Co., is on a business trip through Kansas. S. H. Sheffel, of the same firm, is traveling in Utah and Wyoming, and S. L. Harrod, another representative, has left for a trip through Illinois and Iowa.

Lyman Bros., 632 16th St., have secured a store in the new Symes building, now being constructed at 16th and Champa Sts., and will move into it July 1. This is the same location occupied by this firm before fire forced its removal to the present store.

Umberto Francesconi was recently added to the engraving department of Joseph I. Schwartz. Mr. Francesconi was formerly a well known grand opera singer, but through bad health lost his voice and was forced to turn temporarily to engraving as a profession.

News has been received by local wholesalers that the firm of Morris & Honeyman, Florence, Colo., has been dissolved owing to the death of Mr. Honeyman. The business has been reorganized and will continue under the name of M. L. Morris & Co. J. W. Wilson will continue as manager.

This city has become a mecca for jewelers who suffered in the San Francisco disaster and who are either on their way east or are trying to obtain positions with firms here. Among those who have called on local jewelers are A. M. Samuels, who will locate here, and H. Merritt Woodbrice, formerly with Shreve & Co., who is on his way to New York. An engraver named Johnson said he lost all his tools and machinery in the fire and was going to his old home in the east in a penniless condition.

Henry Bohm, of the Bohm, Allen Jewelry Co., has left here for San Francisco, to ascertain what losses were sustained by the store in which he was interested there with Harlan P. Bristol, formerly of this city, under the name of the Bohm, Bristol Co. The firm was located at 104-110 Geary St., right in the heart of the district first destroyed by the holocaust. The store was entirely gutted and the only property thought to be saved is a safe containing diamonds and other jewels of great value. Mr. Bohm estimates his loss at \$100,000, only \$30,000 of which will be recovered by insurance. Mr. Bristol escaped unharmed and is now with his family at Fruitvale, Cal. Samuel W. Bowman, Arthur S. Canningham and Andrew Brandt, the salesmen, all former Denver men, are also reported safe. The business was started in the ill-fated city only two years ago, and whether or not it will be resumed depends upon the losses and the business outlook of the city when rebuilt.

Carl Pressentine, Madison, Wis., has sold out and retired.

Albert Thorson, Langdon, N. Dak., has gone to Thief River Falls, Minn., to take charge of the M. E. Wold jewelry store.

## INSURE YOUR LIFE IN A REGULAR LIFE INSURANCE COMPANY

FOR PARTICULARS REGARDING

*An Ordinary Life*  
*20 Payment Life*  
*20-Year Endowment*  
*Partnership or Term Insurance in*

The Equitable Life Assurance Society  
OF THE UNITED STATES

Address

L. A. MILLER, Special Agent  
180 Broadway, NEW YORK

## The Riviere Brass & Bronze Works

cordially invite the Trade to inspect their new line of

## Electroliers, Chandeliers and Brass and Bronze Novelties

now on exhibition in their new showrooms (recently enlarged) at

328-330-332 Seventh Avenue.

(Between 28th & 29th Streets)

NEW YORK CITY



### THIS IS HOW IT HAPPENED.

Some few years ago we determined that first of all we were going to make the best Cuckoo Clocks that brains and skilled craftsmanship could put together; then we were going to sell them for as little as we could.

The expected happened. Quality won out as it always does. We have a country-wide reputation for making the best Cuckoo Clocks that have ever been produced, and with that reputation has come the largest Cuckoo Clock business in the world.

Better write for our new Catalogue.

**AMERICAN CUCKOO-CLOCK COMPANY**  
Cuckoo Clocks and Unusual Clocks  
STATION S. PHILADELPHIA

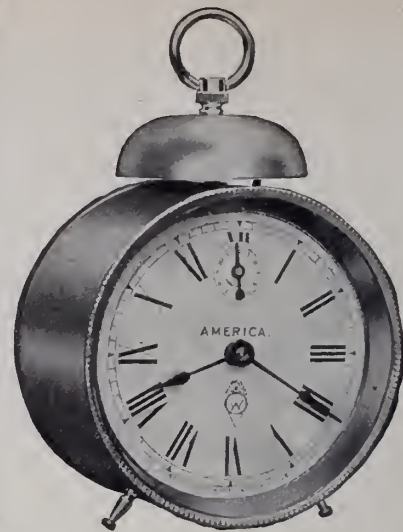

The AMERICA Alarm is a trade-waker for dull stores—a special price on such a necessary article is a good advertisement that pays its own way.

The Western Clock Mfg. Co.  
LA SALLE, ILL.

### LEARN JEWELERS ENGRAVING

"The Engraving School that Graduates Experts."

A fascinating, high-salaried and easily learned trade, taught thoroughly and practically by correspondence. Your instructor is the foremost authority and master workman in the world. We will teach the beginner better engraving by correspondence than he can gain in years of rigid apprenticeship. We will improve the skill of any engraver one hundred per cent, and make him master of the trade. The demand for competent engravers far exceeds the supply.

Send for handsome, illustrated prospectus.  
**PAGE-DAVIS COMPANY.**  
Suite 10, 90 Wabash Avenue, CHICAGO.

"PRACTICAL COURSE  
IN  
ADJUSTING."

PRICE \$2.50.

ALL JOBBERS OR  
JEWELERS' CIRCULAR PUBLISHING CO.



**Indianapolis.**

The family of A. W. Gray, of Gray, Gribben & Gray, has gone to Kansas, where they will spend a month.

No clew has thus far been obtained by the detectives who are working on the Fletcher M. Noe burglary case. About \$400 worth of merchandise was stolen.

C. C. Hyde, formerly at New Castle, was in this city, last week, on his way to Lancaster, O., where he has taken a position as watchmaker and engraver with Charles P. Binger.

David S. Gribben, of Gray, Gribben & Gray, sailed, yesterday, from New York for Naples. He was accompanied by his wife, daughter and son, and will be gone four months.

Federal officers of this city were called to Decatur, Ind., last week, in connection with the arrest of William Goodman, said to be a jeweler, who is wanted in Bradford, O., for violation of the postal laws and for burglary.

Among the patents recently asked for is one on a needle attachment to the graphophone by Harry W. Hicks, a jeweler at Alexandria, Ind., and a buyer here. The new needle attachment will render constant changing of the needle unnecessary.

Nearly all the jewelry confiscated from the I. Groh's Jewelry Co. by Charles H. Grommiger, who committed suicide when the detectives went to arrest him, has been recovered. A large amount of the stock was found in trunks in the young man's rooms. Some more was found in pawnshops.

After successfully defending the English Hotel trophy cup for many weeks, Horace A. Comstock was forced, last week, to surrender it to Jos. Michaelis. Near the close of the match, the springs in Comstock's gun broke, and he had to finish with a borrowed gun. As his own gun was made for a left-handed shooter, Comstock was greatly handicapped by the accident.

Among the out of town jewelers who visited the local jobbers and manufacturers last week were: George L. Spahr, Lebanon; Charles H. Ham, of Blake & Ham Jewelry Store, Frankfort; J. A. Meissen, Cicero; J. A. Pickett, New Castle; Bernhart Maier, Edinburg; A. F. Fox, Plainfield; Louis F. Ott, Veedersburg; William Beatty, West Lebanon; Joseph Booth, of Booth & Son, Tipton; B. F. Turner, of B. F. Turner & Son, Arcadia; Carl Burnhill, Summitville; H. F. Bennett, Lapel, and F. Pennington, Knightstown.

**Cleveland.**

James Iredale is in bankruptcy and his liabilities are said to be about \$5,000.

Chas. Zink, an employe of the Webb C. Ball Co., died last week. The deceased was born in Akron, O., and for a while was employed by the George K. Foltz Co., Akron, until he accepted a position with the Ball concern, two years ago. He is survived by a widow and a child, two years old.

The validity of the "suspicious person" ordinance has been attacked in a habeas corpus proceeding begun last week by Henry Rothbart, a jeweler, who was recently sentenced to the workhouse and to pay a fine of \$50 as a "suspicious person," no

other charge being made against him. In the proceeding for his release the attorneys claim that the ordinance which permits punishment on such a charge is unconstitutional and has been abused in this case. Rothbart was arrested Nov. 10 last, on the ground that "he could not give an account of himself."

**Canada Notes.**

**TRADE CONDITIONS.**

The retail trade is quiet, as is usual at this season. The watch business is dull with little prospect of improvement. The only explanation is that the market is overstocked and dealers carrying enough to supply all ordinary requirements for some time to come. The demand of the retail trade for jewelry is better than usual, especially in plated goods. Local manufacturers are extending their plants and making great efforts to capture the home market, especially in plated jewelry of the American type. Many of them have equipped their factories on the American plan and are likely to meet with a large measure of success in the lines of chains, lockets, cuff links and articles of that description. As they are satisfied with smaller profits than the American houses there seems no reason why, with a favorable tariff, they should not overcome the obstacle of a comparatively limited market, entailing a smaller output. The clock trade continues unsatisfactory, owing to the keenness of competition. Prospects in the silverware line are good and table ware in active demand, in view of the approaching wedding season. Collections are slow and renewals frequent. The rush of immigration westward encourages anticipations of good trade in that quarter, later in the season.

J. A. Grant, Pilot Mound, Ont., has been sold out.

J. W. Gibson, Kingston, Ont., is closing up his business.

Lorne Bricker, Preston, Ont., has assigned to H. C. Edgar.

P. B. Crews, Kingston, Ont., has closed under chattel mortgage.

E. A. Hall, formerly of San Francisco, is opening a store at Frank, Alberta.

Dr. A. E. H. Grupe has gone on a trip to the northwest for J. J. Zock & Co., Toronto, Ont.

Walter E. Kelly, Goderich, Ont., has given a renewal chattel mortgage for \$1,557 to C. L. Welsh.

Wm. Bramley and wife have returned from an extended tour to South America and the West Indies.

W. K. George, president of the Standard Silver Co., was recently elected a director of the Sterling Bank of Canada, Toronto, Ont.

J. H. Jackson, 14 Adelaide St. W., Toronto, Ont., with his brothers, W. J. Jackson and H. A. Jackson, have formed the firm of Jackson Bros., and the new concern has bought out the old business of E. Raymer, Edmonton, Alberta, which they will continue, going into the manufacturing business as well as carrying on a retail business. H. A. Jackson is at present in charge of the Alberta store.

Out-of-town jewelers who called on the Toronto, Ont., trade last week, included: L. A. Jeanneret, Elmira, Ont.; Geo. Hynds, Acton, Ont., and T. A. Grothe, Montreal.

August Bonchard was recently sentenced by Judge Desmoyres in Montreal to two years' imprisonment in the penitentiary for stealing \$175 worth of jewelry and cash from the store of Alfred Mallette, 331 E. St. Catherine St., that city.

Robert Helmer, Olivia, Minn., has been granted a patent on a mechanical toy.

**New Stores and Enterprises.**

W. Farrell will soon open a store in Montrose, Colo.

J. H. Sohn is a new jeweler on Pier Ave., Ocean Park, Cal.

De Soto H. Grant has opened a store in Las Vegas, N. Mex.

Samuel Ruben is about to engage in business in White Bear Lake, Minn.

S. Aislander has begun business in the Haye building, Benwood, W. Va.

Gordon Hanson, Howard, S. Dak., will shortly begin business in Oldham, S. Dak.

Harry R. Barney recently opened optical parlors at 251 W. Market St., East Liverpool, O.

Burt Bradley, formerly with A. M. Ward, Abilene, Kans., has started in business in Mattoon, Ill.

Samuel Higgins, watchmaker, has opened a retail jewelry store at the corner of Ridge Ave. and Diamond St., Philadelphia, Pa.

Hurwitz Bros. & Bloom is the name of a new wholesale house which, last week, opened offices in the new Central building, Rochester, N. Y.

E. L. Griffen, optician, formerly with the L. Manasse Co., Chicago, has started in business on his own account in rooms 602, Columbus Memorial building, in the same city.

The Kortum Mfg. Co. has filed incorporation papers and engaged in business in Attica, N. Y., with a capital stock of \$5,000. The concern will manufacture platers' supplies, etc.

The Reeves Jewelry Material Co. was recently incorporated in St. Louis, Mo., with a capital stock of \$20,000, 70 per cent. of which is paid in. The incorporators are: R. F. Reeves, Joseph Gutfreund and Mary Reeves.

John Wagner, for years optician in the Progressive Co. store in Main St., Buffalo, N. Y., has opened handsome optical rooms at 91 E. Genesee St., that city. The lighting effect in the front windows is most attractive.

The San Diego Onyx Co. has been incorporated to handle onyx from the Santa Catarina quarries in lower California. Among those interested are: Col. Fred Jewell, L. J. Wilde, Chas. Collier, E. A. Hornbeck, E. B. Stuart, E. M. Barber, John F. Schwartz and W. L. Tibbals.

Christian Bauer, watchmaker, lately with Queen & Co., opticians, Philadelphia, Pa., has opened a store of his own at 11 S. 9th St., that city. He intends to conduct a jewelry repairing and watchmaking department as well as an optical department, and has accordingly equipped his establishment.

**Market Price of Silver Bars.**

The following are the quotations of silver bars in London and New York, as reported by Zimmermann & Forshay:

	New York.	London.
May 1.....	\$.66	30 9-16d.
" 2.....	.66	30 9-16d.
" 3.....	.66½	30 11-16d.
" 4.....	.66¼	30 5-8d.
" 5.....	.66¾	30 13-16d.
" 7.....	.66¾	30 11-16d.

August Youngerman, 305 W. 2d St., Davenport, Ia., has sold out to Lembrecht & Co. The new firm, composed of Theo. Lembrecht and Frank C. Kroeger, will continue the business at the old stand.

# Our Traveling Representatives



Among the traveling representatives calling on the Toronto, Ont., trade, last week, were: W. Wilson, R. Hoehn & Co., and a representative of Wagner & Girshley, London, Eng.

C. E. Payne, of L. Gudmann & Sons, Cincinnati, O., has left on his regular trip through Ohio and Indiana. Steve Lensher, of the same house, has made a trip through the northwest.

The following salesmen were in Boston, Mass., the past week: L. C. Martin, Martin, Copeland & Co.; John W. Reddall; Harry Lissauer, Jacobson Bros.; Charles F. Sweasy, Champenois & Co.; E. R. Crippen, Philadelphia Watch Case Co.; Mr. Hickey, Henry Zimmermann & Co.; Robert E. Kehl, F. H. Noble & Co.

Among the traveling representatives who called on the trade in Denver, Colo., recently, were: R. E. Williams, St. Louis Silver Co.; Arthur E. Hall, International Silver Co.; W. S. Willis, Gorham Mfg. Co.; Steve Howard, Wilcox & Wagner and Watson & Newell Co.; T. W. Agnew, New Haven Clock Co.

Traveling representatives who visited Buffalo, N. Y., last week, included: J. A. Granbery, J. A. & S. W. Granbery; Mr. Guggenheim, Ingomar Goldsmith & Co.; P. H. Phelps, Enos Richardson & Co.; Geo. T. Howard, Towle Mfg. Co.; Maurice Kohn, Silbermann, Kohn & Wallenstein; Mr. Linton, E. H. H. Smith Silver Co.; A. N. Dorechester, Chapin & Hollister Co.; Albert Holzinger.

Lancaster, Pa., was visited, recently, by the following traveling representatives: Horace M. Tuttle; Thomas C. Parker, Pittston Cut Glass Co.; William H. Weferling, Riker Bros.; Charles A. Crist, L. E. Waterman Co.; S. A. Lynch, William B. Kerr & Co.; Morris Lewkowitz, D. Ullman & Co.; F. A. Brennan, L. Witsenhausen; Jacob C. Luken, L. H. Keller & Co.; A. J. Winter, Alvin Mfg. Co.; W. L. Blackinton, Kinney Co.; M. Friedman, Jr., Friedman & Co.

Among the traveling representatives who, recently, visited the trade in Detroit, Mich., were: Wallace E. Welch, Hoyt, Obrig & Geiger Co.; Samuel L. Griffin, C. F. Rump & Sons; S. J. Hunter, Wm. I. Rosenfeld; J. T. Griffith, Jr., Carter, Howe & Co.; G. W. Payson, Seth Thomas Clock Co.; Albert Ginzberg, Eliassof Bros. & Co.; Mr. Hickok, Gorham Mfg. Co.; Frank F. Young, Hartford Sterling Co.; A. M. Stern, Goodfriend Bros.; J. G. Hutchinson, Smith & Crosby; Mr. Lucas, A. H. Bliss & Co.; Mr. Maintien, Maintien Bros. & Elliot.

Among the traveling representatives who visited the trade in St. Louis, Mo., last week, were the following: W. C. Barry, Larter & Sons; Edward O. Krauss, Western Watch Case Mfg. Co.; Edgar Huhn, Potter & Buffinton Co.; W. H. Gregory, Strobell & Crane; Richard Merker, Bates Bros. Co.; Henry H. Jacobson, Jacobson Bros.; J. H. Thompson, J. B. Bowden & Co.; A. E. Metteran, Shafer & Douglas; L. H. Smith, Bippart, Grisco & Osborn; F. R. Horton, Carter, Howe & Co.; Henry H. Miller, Hutchinson & Huestis; L. Strauss, C. P. Goldsmith & Bro.; S. E. Bolles, William Scheer; G. A. Jewett, Hamilton & Hamilton, Jr.; J. M. Morrow, American Watch Case Co.; Jul. F. Schuman, Jr., William Kinscherf Co.; Mr. Wilkins, Ostby & Barton Co.; W. A. Moore, F. W. Gesswein Co.; M. W. Potter, J. M. Fisher & Co.; Mr. Joseph, M. B. & H. H. Joseph.

Traveling representatives who visited Omaha, Nebr., during the past week, included: Norman L. Strauss, Jacob Strauss & Sons; H. A. Roff, Brainard & Wilson Co.; Leonard J. Fox, Gustave Fox Co.; W. H. Gregory, Strobell & Crane; H. B. Greene, R. J. Roberts; Joseph Hurd, W. H. Grindley & Co. and Donlon & Co.; Julius S. Mayer, Manser Mfg. Co.; T. B. Ross, John Russell Cutlery Co.; Walter S. Noon, Cory Bros. Co.; Charles Boss, American Cuckoo Clock Co.; E. B. Frank, Pairpoint Corporation; Robert S. G. Edwards, Whiting Mfg. Co.; H. C. Rowbotham, Schrader-Wittstein Co.; John Thornton, Hayden

W. Wheeler & Co.; Charles Stiner, L. Adler & Son; E. Lechler; L. M. Frank, Buffalo Jewelry Case Co.; Harry Oliver, Tarrant & Gismond; Ralph Siegrist, Albert L. Haman; G. L. Titus, International Silver Co.; Julius Laubheim, Eisler & Laubheim.

The following traveling representatives called on the jewelry trade in Kansas City, Mo., last week: T. B. Ross, John Russell Cutlery Co.; Harry S. Aicher, Alvin Mfg. Co.; H. H. Joseph, M. B. & H. H. Joseph; H. E. Cobb, Daggett & Clap Co.; Harry E. Farquharson, E. D. Gilmore & Co.; H. C. Rowbotham, Schrader-Wittstein Co.; J. S. Mayer, Manser Mfg. Co.; Mark Franklin, Bradley Ring Co.; Henry Bloch, L. D. Bloch & Co.; W. A. Moore, F. W. Gesswein Co.; Harry E. Barkman, Jones & Woodland Co.; E. A. Reed, Reed & Barton; Geo. L. Brenning, Dennison Mfg. Co.; Henry H. Jacobson, Jacobson Bros.; W. H. Cushman, Woodman-Cook Co.; George L. Paine, George L. Paine Co.; W. R. Cobb, W. R. Cobb & Co.; Mr. Jackson, Goodell-Pratt Co.; Geo. Weidig, Jos. Fahys & Co.; Mr. Fay, J. T. Mauran Mfg. Co.; Mr. Wilkins, Ostby & Barton Co.; J. G. Hutchinson, Smith & Crosby; Harry S. Aicher, Alvin Mfg. Co.; Walter S. Noon, Cory Bros. Co.

Traveling representatives who called on the Cincinnati, O., trade, during the past week, included: Max Jacoby, Manchester Mfg. Co.; N. Shiman, Shiman Bros. & Co.; W. B. Peck, Waite, Thresher Co.; Frank Collom, Sulzburger Bros.; Fred Kennon, John T. Mauran Mfg. Co.; Fred Carpenter, W. & S. Blackinton Co.; Frank Bloomer, E. I. Franklin & Co.; T. Sherman, S. K. Merrell & Co.; W. Marble, Marble & Co.; John Ruggles, W. H. Bell & Co.; E. A. Kohn, Eastman, Park Co.; W. Sharkey, Ziruth-Kaiser Co.; Charles L. Drown, Ostby & Barton Co.; Mortimer C. Adler, Charles Adler's Sons; W. C. Barry, Larter & Sons; T. S. Sturgis, Perley Bros.; Walter S. Noon, Cory Bros. Co.; Lucien Rockwell, Poole Silver Co.; Harry E. Barkman, Jones & Woodland Co.; C. A. Hulstrom, Wilcox & Evertsen; M. Newhouse, Schultz, Leiss & Co.; Mr. Sideman, Redlich & Co.; W. H. Gregon, Strobell & Crane; Alberto S. J. Schweizer, Ansonia Clock Co.; D. A. Davidson, Wallach & Davidson; G. E. Tinker, William B. Durgin Co.; W. Bernheim, Woodside Sterling Co.; J. F. Ripley, Standard Button Co.; Mr. Huhn, Potter & Buffinton Co.; Maxy L. Potter, J. M. Fisher & Co.; Adolph Weiss, Heinrich, Herman & Weiss; T. G. Frothingham, T. G. Frothingham & Co.; H. A. Scofield, Scofield, Melcher & Scofield; George E. White, White & Rounsville; J. T. Griffith, Jr., Carter, Howe & Co.; W. H. Osborne, R. Wallace & Sons Mfg. Co.

The following traveling representatives called on the trade at Pittsburg, Pa., last week: Louis Hurwitz, Bates Bros. Co.; A. J. Sherrard, Enoch Richardson & Co.; Jesse Carpenter, Horton, Angell Co.; R. C. Read, H. F. Barrows Co.; E. R. Bennett, Waite, Mathewson & Co.; H. B. Kennion, Parks Bros. & Rogers; M. E. Van Bergh, Van Bergh Silver Plate Co.; Geo. Southwick, Payton & Kelley Co.; V. L. Burgesser, Kremenitz & Co.; O. G. Pehon, J. M. Fisher & Co.; N. Shiman, Shiman Bros. & Co.; Charles S. Peckham, J. H. Peckham & Co.; Alberto Schweizer, Ansonia Clock Co.; C. S. Untermeyer, Chas. Keller & Co.; G. F. Brinck, Crescent Watch Case Co.; W. H. Osborne, R. Wallace & Sons Mfg. Co.; George H. Remington, Maintien Bros. & Elliot; H. F. Tourtellot, Waite, Thresher Co.; Edgar Huhn, Potter & Buffinton Co.; Mr. Heyman, Stern Bros. & Co.; H. N. Van Bergen, Snow & Westcott; Mr. Finberg, Finberg Mfg. Co.; Frank W. Bloomer, E. I. Franklin & Co.; D. A. Davidson, Wallach & Davidson; S. C. Corbin, Waterbury Clock Co.; Mr. Rogers, C. H. Cooke Co.; W. T. Sherman, S. K. Merrill & Co.; Fred Casper, Manser Mfg. Co.; C. M. Newcourt, Maple City Glass Co.; A. Kaufman, Ingomar Goldsmith & Co.; J. T. Griffith, Jr., Carter, Howe & Co.; H. H. Meyer, Wm. B. Kerr & Co.; H. B. Carmichael, Bride & Tinkler; J. A. Granbery, J. A. & S. W. Granbery; Charles Perret, Jules Racine & Co.; J. Ira Lester, Milton L. Ernst; J. J. Schwartz, L. Barnett & Co.

Grosse & Kappeler, Dayton, O., are holding an auction sale.

The A. J. Douglas Optical Co., Seattle, Wash., has been succeeded by the Boyer Optical Co.

Thomas Brennan, formerly with the Cross Optical & Jewelry Co., Chester, Pa., has resigned his position and opened optical parlors at 329 Ulrich St., in the same place.

## LETTERS TO THE EDITOR.

### Proposed Association for North Carolina.

GREENSBORO, N. C., April 4, 1906.

Editor THE JEWELERS' CIRCULAR—WEEKLY:

It has been the hope of the writer that some one would come to the front to organize a jewelers' retail association in this State, as such an organization is sadly needed. As no one, however, has appeared upon the scene, the writer has concluded to try to bring about a meeting of all the jewelers in this State. I send you a printed interview I had with the local daily paper, the *Industrial News*, which explains itself.

Now Greensboro, being a central point in this State, having the finest hotel facilities, A. P. Stiely, of High Point, has concluded to call a meeting here to convene July 3, and would like to hear from all jewelers in this State who expect to be present.

The object of this association would be about the same as that of the National Retail Jewelers' Association, with which it is my idea to affiliate. The grocers, hardware men and other merchants have such associations and a great deal of good has been derived from them. Why do we retail jewelers not combine? Is there something in our business that makes us jealous of each other? Why can't we club together, like other merchants, and work together for the good and welfare of our profession, thus making it easier to combat the abuses that have crept into our business and helping to overcome obstacles that grow larger as time rolls on. There is no reason why we stand aloof from each other and I sincerely trust we can have in the State one of the strongest associations in the Union. The writer had several letters from jewelers who have expressed their willingness and financial aid to make this a success.

R. C. BERNAU.

Among the finest jewelry offices recently established are those into which Chas. Keller & Co. and the Keller & Untermeyer Mfg. Co. have moved in the Cockcroft building, 73 Nassau St., New York. The entire seventh floor is occupied, and this gives an open stretch, with light coming from all sides. The partitions constructed provide private offices and a salesroom, rare chiefly of ground glass, which does not shut out the light. Another advantage of having the entire story is that you step from the elevator directly into the quarters of the two concerns. The handsome appearance of the woodwork in antique oak finish at once attracts the attention of the visitor. The floors of the building are of stone and in these offices tiles have been laid in a way to give a pleasing effect. In the front are quarters provided for the Keller & Untermeyer Mfg. Co., and the remainder of the space, about 90 per cent., is devoted to the business of Chas. Keller & Co., the total number of square feet on the floor being 3,500. The jewelry safes are arranged in a row, in front of which are tables convenient for purposes of selection and assorting of stock. Railings set apart a convenient enclosure for the order department. There is also a roomy and admirably equipped workshop. The private offices in the front are large and tastefully fitted. This is also true of the salesroom.

## News Gleanings.

I. Aronson, Portland, Ore., is conducting an auction sale of his stock.

Kessler Bros. & Co., Wellston, O.; have been succeeded by Patridge & Co.

Walter W. Ratcliff, Albert City, Ia., has been succeeded by W. B. Gillham.

J. B. Odom, Clifton, Tex., has admitted a partner, and the firm style is now Odom & Whalton.

Peter F. Geghtol will continue the business formerly conducted by Beghtol Bros., Bennett, Nebr.

Mr. Carlyon, Wrangel, Alaska, was a heavy loser in the fire which destroyed that town, recently.

The Peever-Gorham Mfg. Co., Sisseton, S. Dak., has been succeeded by the Peever-Mercantile Co.

John O. Young, Lacombe, Alberta, Can., has disposed of his business at that place to W. D. Gooderich.

Chas. E. Keever, Fountain City, Ind., is making extensive improvements in the interior of his store.

L. A. Hall has moved his watch repairing establishment from N. 3d St. to S. Front St., Marquette, Mich.

W. Reine, Belgrade, Minn., announces a closing-out sale, due to ill-health, which compels him to retire.

W. H. Appel, Allentown, Pa., has sold his country residence at Park Side, Rittersville, to James Neiss.

The firm of A. W. Biber & Co., Spartanburg, S. C., has dissolved, and the business will be carried on by A. W. Biber.

Henry F. Peters, Moline, Ill., and Miss Irene Sage were united in marriage, May 1, at the home of the bride, in Belvidere.

W. R. Smith, Mount Pleasant, Pa., has moved his store from the Rumbaugh block to a more convenient location in the same town.

Peter Scholl has commenced business in the Diamond Drill building, Crystal Falls, Mich. Mr. Scholl was formerly in business in Chicago.

G. F. Hunt's store, Waverly, Ia., was recently robbed of \$400 worth of watches, rings and other jewelry. There is no clue to the thieves.

The telephone system adopted in Yorkton, Man., was conceived and rendered practicable by Thomas Paul, a retail jeweler of that place.

A bold robbery was committed in Findlay, O., Thursday, when thieves broke into the store of F. E. Brand and escaped with \$600 worth of miscellaneous jewelry.

Isidor Glou, Plymouth, Pa., has secured a patent on a new form of gas jet which will prevent the gas from escaping should the flame be accidentally extinguished.

The interior of the store of H. J. Webb & Co., Springfield, Mass., has been entirely remodeled. New Show cases of mahogany and plate glass have been installed.

Violet Hunt, of Prague, Okla., has the distinction of being the only woman jeweler in that territory. Miss Hunt has the reputation of being a skilled watch and jewelry repairer.

Charles Brehm, giving his residence as Akron, O., was arrested about a week ago, in Youngstown, O., as a suspicious character. When taken into custody Brehm had

in his possession a large amount of bogus jewelry.

John Riley, Jr., Exira, Ia., has gone to Winnebago, Minn., where he has bought a jewelry and optical business. He recently graduated from a school of engraving and optics.

John W. Church, trustee in bankruptcy for William D. Oertel, Syracuse, N. Y., has sold the stock of Peter Nichels for \$128. The stock was appraised at \$755. Referee Stone has confirmed the sale.

The final dividend of 3 1/100 per cent. has been declared to the creditors of E. J. Boyce, Braintree, Mass., who went into bankruptcy, some time ago. This amount is payable at once by the trustee in bankruptcy.

The store of Brittain Bros., Lindale, Ga., was entered by burglars, a short time ago, and jewelry valued at \$100 was stolen. A small part of the loot that had been dropped by the thieves in their flight was subsequently recovered.

T. A. Roberts, Chattanooga, Tenn., has moved from 725 Market St. to 103 E. 8th St. Mr. Tegan, formerly optician for the Geo. W. Meyer Jewelry Co., will have charge of Mr. Roberts' optical department in the new quarters.

F. E. Van Patton, Water and Chester Sts., Meadville, Pa., has gone into business with his brother, Herbert Van Patton, at 281 Chestnut St., in the same town. The new firm will carry a full line of watches, clocks and silverware.

The Mefford Optical and Jewelry Co. is the firm style of a business recently started in Ainsworth, Nebr., by I. W. Mefford. The name of the latter was erroneously published in a previous issue of THE CIRCULAR-WEEKLY as J. W. Nefford.

The trustee of B. E. Arons, Pittsburg, Pa., has filed his final account, but the balance on hand is not sufficient to pay the preferred claims and the cost of the bankruptcy proceedings. There is practically nothing left for the general creditors.

A. W. Flye, Gloucester, Mass., is confined to his home, suffering from a painful injury, sustained a short time ago, when he broke his right leg. The jeweler had been working on a motor boat when a rope broke and allowed a heavy block to fall upon him.

Miss Elva Robertson, daughter of A. F. Robertson, St. Cloud, Minn., recently attempted suicide by cutting her throat and left wrist with a razor. Overwork is believed to have brought on nervous trouble, which unbalanced her mind. Her recovery is doubtful.

It was erroneously reported a short time ago that Cole & McElwain, Atlantic, Ia., had sold out to H. M. Sells. The concern has not sold out, but has changed its firm style to Crowley E. Cole & Co. The business will be continued as heretofore at the old location.

Wayne Cannaday, son of Charles E. Cannaday, a retail jeweler of Schoharie, N. Y., was arraigned in that village, about a week ago, on a charge of murder. He pleaded not guilty. It was alleged that the defendant, during a quarrel, a short time ago, shot and killed Mrs. J. Manchester.

The bankrupt stock of York & Goodnough, Watertown, N. Y., was sold Wednesday afternoon and was bid in by W. H.

Goodnough, father of the junior end of the firm. The price paid was \$1,275. The business will again be conducted at the old location, in charge of R. M. Goodnough.

The diamond mining industry in British Guiana is reported inactive by Consul McMackin, of Georgetown. There were produced in the calendar year 1905, 86,096 stones, weighing 5,315 carats, whereas, in 1904, the number of carats produced was 11,045. Recently a New York syndicate has sent out a working expedition, and the output will be shipped to New York.

Noticed among the sojourners at French Lack Springs, Ind., are the following members of the trade: C. D. Peacock and wife, Chicago; George H. Newstadt, Cincinnati; Fred J. Foster, of Unger Bros., and his mother, Mrs. E. Foster, of Newark, N. J.; S. D. McPhearson, C. Ray Randall & Co., North Attleboro, Mass.; C. H. Davison, Coddling & Heilborn Co., North Attleboro, Mass.

Mrs. Christina Schranger was before Magistrate Finger in Davenport, Ia., last week, charged with attempting to steal a gold pin from the store of the M. E. Nabstedt & Sons Co., at that place. The woman came into the store and asked to look at some pins. When the latter were shown to her she did not seem satisfied. The clerk then turned away to get some others and when she did so Mrs. Schranger crumpled one of the cards with a pin on it in her hand. The little tag hung out between her fingers, however, and the clerk demanded the pin. The woman handed it over and then left the store. The police were notified and the accused was arrested. After the Magistrate had heard the evidence he fined the woman \$100 and costs, which she immediately paid. She was ordered to leave the city. Mrs. Schranger had been arrested before on the charge of shoplifting, Dec. 17, 1904, and had been fined \$100 by Justice Hall and ordered to leave town. She returned a short while ago.

### Newark.

Additional contributions to the funds for the relief of San Francisco have been acknowledged as follows: L. Lelong & Bro., \$100.

The William B. Kerr Co., 144 Orange St., silversmiths, has been incorporated, the authorized capital being \$100,000, with \$1,000 paid in.

Kautzmann & Sussfeld have moved from 477 Washington St. to 116 Arlington St., where they will have double the floor space of the old quarters.

Michol Ianceli, an Italian jewelry peddler, last week caused the arrest at Boston of his brother-in-law, Ernesto Criscoulo, on a charge of larceny. The complainant said that his stock of jewelry was taken one night from his home by Criscoulo, who had been living at the house. When the police arrested the man the missing property was found, it is said.

The Huteson Optical Co., Omaha, Nebr., has issued a beautifully illustrated catalogue of 128 pages, illustrated throughout with delicate half-tone cuts and filled with new ideas for the optician. It will be sent, free of charge, express prepaid, to any one in the trade.

## Popular Talks on Law.

(Copyrighted, 1906, by WILLIAM C. SPRAGUE.)

### CONTRACTS.

(Continued from issue of April 11.)

#### No. 2.—THE CONSIDERATION TO SUPPORT A CONTRACT.

The rule that every promise must have a consideration to support it in order to be good in law; in other words, that every contract must have two sides; and the further rule that the consideration, or that which is agreed to be given for the promise, must not be something which the promisor is already bound in law to give, has frequent application in cases of settlements of existing debts. A owes me, we will say, \$500, and the debt is overdue. I say to him, "Pay me \$450 now and I will release you from the remainder of the debt." He pays me \$450, relying on my promise. Am I bound in law to release him from the remainder of the debt? No, because the consideration for my promise to release him was his paying me \$450, something which he was already bound in law to do. If, however, he had agreed to do something more than he was already bound to do, as, for instance, to pay \$450 at some place other than that provided in the original contract, or to pay me \$450 and do some specified service, then that which was agreed to be done over and above the mere payment of the \$450 would be considered in the law a sufficient consideration to support the agreement to release the debtor from the remainder of the debt.

It is held, however, that if a man owes me \$100 overdue, and I agree to accept something other than money, as, say, a horse in full payment, I cannot thereafter claim that the horse was not worth \$100, and that therefore the debtor still owes me the difference between the value of the horse and the \$100 on the ground of no consideration. If one pays something other than money, whatever its value, in full satisfaction of his debt, and the creditor accepts it, the debt is discharged as completely as if it had been fully paid in money.

Then, too, if the debt is not yet due, the creditor's agreement to accept a part of it at once in full discharge of the whole debt is good, as in that case the consideration is payment before the debt is due, and that is a new consideration—something the debtor was not bound to do.

Where the debt is uncertain in amount, or is in dispute, it is held that a promise to give a release on the payment of a certain amount of money is good, even although it may be afterward found that the real amount due was more.

If a creditor receives in full payment from his debtor some obligation due the debtor from a third person, the debt is discharged, even although the transferred debt is smaller than the one for which it is given in payment.

If a person to whom a debt is due agrees to accept a negotiable promissory note for a less amount than the debt and gives a discharge, he is bound to do so, the theory being that the advantage the creditor gets from the note, it being negotiable, is sufficient consideration.

It was held that a promise of extra pay

to sailors in consideration of their agreeing to finish a voyage for which they had signed articles was without consideration. So was a promise to pay a witness for attendance at court more than the fees prescribed by law. So was a promise to reward an officer for arresting a criminal whom the duties of his office required him to arrest.

The whole question as to whether or not a promise to pay less than the whole debt will discharge the debt on the payment of the lesser amount depends entirely upon whether or not what is agreed to be done by the debtor is something which in law he is already bound to do. If there is anything to be given or to be done by him other than he is bound by law already to do, there is sufficient consideration for the promise to release, and the promisor will be bound.

A promise made to one in consideration of his forbearing to sue is made on valid consideration. A promise made to one in consideration of his forbearing to collect a debt or to enforce payment is made on good consideration, provided the forbearance be for a definite or reasonable time. A forbearance not to prosecute a demand which is found not to exist in law or in fact is no consideration.

If a creditor agrees to give up part of his debt in consideration of the debtor's giving him new or additional security, his promise will have a good consideration and be valid.

Then, too, in order for the consideration to be legal, it must not be something in the past. Thus, if one does work for me gratuitously and I afterward voluntarily promise to pay him for it, I am not bound in law to keep the promise, the consideration having been something in the past. So if I have bought a horse and not at the time required a warranty, and I afterward go to the person from whom I bought it and ask for a warranty, a warranty then given, unless something is paid or promised to be paid on it, is not valid in the law.

If I promise to repay to strangers what they may pay out in the future in taking care of my sick son who is of full age, the promise is supported by a valid consideration, and is legally binding. If, however, strangers take care of my sick son, who is of full age, and I afterward promise to reimburse them, my promise is without consideration, as it is based upon past acts. I may be morally bound to do so; but I am not legally so bound.

It has been held that where the act is done at the request of another person under such circumstances that the law will imply a promise to pay what the service is worth, a subsequent promise to pay will be binding, the theory being that the parties have reduced to a certainty what they have purposely left undetermined.

As an exception to the rule that promises cannot be based on a consideration that is past we name promises to pay debts barred by the statute of limitations or by discharge in bankruptcy. Courts so holding have declared that the moral obligation to pay a debt barred by statute or by discharge in bankruptcy is sufficient to uphold the promise.

Another rule is that the consideration must be something possible. A promise to

do something that cannot in the nature of things be done is not a valid consideration to support a contract. Not only a thing which is physically impossible, but also a thing which is legally impossible cannot be made a consideration. A mere stockholder in a corporation cannot execute a legal deed for the corporation. A promise by a stockholder to do so would not be a legal consideration for a contract.

The question arises as to whether the fact that one is morally obliged to do a thing will make his promise to do it valid as a consideration for a contract. We have seen that where one is legally bound to do a thing his promise to do it will not make a legal consideration. The rule is that a moral obligation will not uphold a promise.

There is one other point we should consider before passing from the subject of consideration. Sometimes a consideration is said to fail. If I promise to pay a man \$100 in consideration of his agreeing to sell me his chestnut colt, the consideration supporting my promise to pay is his promise to convey the title to the animal to me. If before he does so the horse dies, there is a total failure of consideration. There is absolutely no way possible by which he may fulfil his agreement.

Where a patent right was a consideration of a contract, and it was found that the patent right was void, the consideration was said to have failed. The mere fact that a patent right that constituted the consideration of a contract could not be applied to any useful purpose and was of no value did not constitute a failure of consideration.

A promise to pay money for notes which afterward are found to be forged is another instance of a promise given for a consideration that has failed. There is such a thing, too, as a partial failure of consideration, in which case the party injured may recover for so much as has failed.

Before passing from the question of consideration, let us emphasize the fact that a court will never examine into the mere adequacy of price or consideration, that is, it will not consider whether the price or consideration was large or valuable enough. Courts do not attempt to make contracts for people. They will not answer the question as to whether one person received enough for what he gave, or whether one promise was worth the other. The only time when the question of adequacy can come up is when fraud is charged and the gross inadequacy of the consideration is brought in as evidence of the fraud. Mere inadequacy of consideration, however, is not enough to warrant a court in setting aside a contract.

(To be continued.)

Charles S. German, Varna, Ill., recently sold out to Charles Berggren, the local postmaster. Mr. German has moved to Henry, in the same State.

A plot to blow up the Von Hof Hotel, in Mansfield, O., was recently discovered by L. A. Ott, a jeweler. Mr. Ott lighted a match and a flame of gas shot up from a radiator to the ceiling. An investigation showed that some one had, with a rubber tube, filled every radiator with gas.

INDEX TO ADVERTISEMENTS.

Aikln, Lambert & Co.....	103	Goodfriend Bros. ....	42	Oriental Bank .....	58
Allsopp & Allsopp .....	22	Gorham Mfg. Co.....	54	Orkin Bros. ....	30
Alvin Mfg. Co.....	Inside front cover	Griffoul, August .....	104	Osmun-Parker Mfg. Co.....	20
Amerleau Cuckoo Clock Co.....	68	Guardian Trust Co.....	58	Ostby & Barton Co.....	18
Amerleau Gem & Pearl Co.....	48	Guerlin, Wm., & Co.....	100	Page-Davis Co.....	68
Amerleau Platinum Works .....	102	Hagstoz, T. B., Ltd.....	104	Palrpoint Corporation .....	100
American Ring Co.....	30	Hall's Studio .....	98	Parks, G. W., Co.....	19
American Waltham Watch Co.....	78	Handel Co.....	98	Passmore Gem Co.....	48
Arch Crown Mfg. Co.....	56	Harris & Harrington.....	Outside back cover	Patek, Philippe & Co.....	88
Arnstein Bros. & Co.....	Outside back cover	Haskell, Henry C. ....	72	Penfold, Wm. C., Co.....	89
Art Stamping & Mfg. Co.....	22	Hedges, A. J., & Co.....	20	Perelval, D. C., & Co.....	50
Austin, John, & Son.....	Outside back cover	Hedges, Wm. S., & Co.....	42	Philadelphia Watch Case Co.....	83
Aztec Turquoise Co.....	40	Helntz Bros. ....	Inside back cover	Potter & Bullinton Co.....	29
Bagg, Perline & Co.....	41	Heller, L., & Son.....	38	Potter Shell Works .....	46
Ball, Webb C., Watch Co.....	62	Herpers Bros. ....	96	Power, Chas. L., & Co.....	42
Baschkopf, Jacob .....	88	Hilrsh & Hyman.....	Outside back cover	Powers & Mayer .....	15
Bassett Jewelry Co.....	30	Hodenypl & Walker.....	38	Prior, Charles M.....	24
Bates & Bacon .....	17	Hotel Normandie .....	76	Prybil, P.....	104
Bealmear, H., & Co.....	98	Hotel Schenley .....	76	Racine, Jules .....	88
Berge, J. & H.....	96	Hotel St. James.....	76	Reichhelm, E. P., & Co.....	96
Bigalke & Eckhart Co.....	60	Howard, E., Clock Co.....	88	Renzlehanen, W. F., Co.....	104
Bigney, S. O., & Co.....	4	Hraba, Louis W.....	96	Revell, A. H., & Co.....	Outside back cover
Billings, Chester, & Son.....	40	Humphrey, John B.....	40	Ries & Armstrong .....	102
Bishop, R. W.....	96	Hutchison & Illestis .....	31	Riviere Brass & Bronze Works.....	68
Blackinton, R., & Co.....	17	Illinois Watch Co.....	13	Robert, Edmond E.....	84
Blackintou, W. & S., Co.....	52	International Silver Co.....	8	Rockford Watch Co.....	76
Blancard & Co.....	90	Irons & Russell .....	30	Roger Williams Silver Co.....	29
Boote, Edward .....	98	Jacot Music Box Co.....	98	Roseman, A.....	46
Borrelli & Vitelli .....	42	Jeandheur, F., Jr.....	96	Ross, Saltman & Anderson.....	28
Boston Jewelry Co.....	72	Jeanne, Frederick A.....	46	Roy Watch Case Co.....	86
Bowden, J. B., & Co.....	18	Johnston, W. J., Co.....	10, 11	Rudolph & Suedeker .....	76
Bradley Polytechnic Institute .....	84	Juergens & Andersen Co.....	62	Rumpp, C. F., & Sons.....	102
Brower, Maurice .....	48	Juergensen, Jules.....	76	Saunders, Meurer & Co.....	42
Bruhl Bros. & Heenus Co.....	Outside back cover	Kahn, L. & M., & Co.....	Outside back cover	Schiff, M.....	20
Bryant, M. B., & Co.....	18	Kaiser, David, & Co.....	14	Schultz, Leiss & Co.....	25
Buckley, Sam'l, & Co.....	40	Kassel, Abe .....	102	Scofield & DeWyngaert.....	25
Burrington & Co.....	20	Keck, Herman, Mfg. Co.....	62	Sessions Clock Co.....	89
Carter, Howe & Co.....	21	Keit & Woodland .....	22	Seymour, Cassius W.....	40
Chatham National Bank .....	58	Keystone Watch Case Co.....	82	Shiman Bros., & Co.....	64
Chopard Frères .....	50	Klipper Bros. ....	84	Smith, Alfred H., & Co.....	36
Columbia Jewelry Mfg. Co.....	88	Kohlhusch, Herman, Sr.....	28	Smith, E. H. H., Silver Co.....	102
Conley & Straight .....	104	Kohn, Alois, & Co.....	20	Snow & Westcott .....	24
Cooper Diamond Co.....	40	Koshland & Italie Co.....	26	Sohn & Hyman .....	48
Cooper & Forman .....	24	Kremetz & Co.....	23	Solidarity Watch Case Co.....	42
Cottle, S., Co.....	21	Laugendorf Watch Co.....	86	Spencer, E. L., Co.....	31
Crohn, M.....	25	Larter & Sous.....	34	Sprague Law School .....	40
Cross & Beguelin .....	28, 56	Lelong, L., & Bro.....	Outside back cover	State Bank .....	58
Crouch & Fitzgerald.....	26	Leshner, Whitman & Co.....	90	Steiner, Louis .....	60
Culman, C.....	96	Levy, Robt.....	27	Steinreich, G. L., & Co.....	102
Daffy, C. M.....	104	Lewy & Cohen .....	100	Stern Bros. & Co.....	12, 46
Day, Clark & Co.....	21	Lindner & Co.....	66	Sternau, S., & Co.....	16
De Selms Watch School.....	84	Lissauer & Co.....	38	Stevens & Co.....	90
Diamond Point Pen Co.....	104	Loeb, Wm., & Co.....	30	Stiven, John S.....	104
Didisheim, Hipp. & Bro.....	86	Lorsch, Albert, & Co.....	Outside back cover	Strauss, Ignaz, & Co.....	Outside back cover
Donnelly, J. J.....	96	Low, Martin, & Taussig .....	38	Strauss, Jacob, & Sons.....	46
Doran, Bagnall & Co.....	30	Love, Edwin, & Co., Inc.....	30	Street, Geo. O., & Sons.....	21
Dorffinger, C., & Sons.....	98	Luthy & Hine .....	24	Tavannes Watch Co.....	72
Dulk, Robert .....	22	Lyons Gem Co.....	40	Thomas, Seth, Clock Co.....	76
Dunbar, Leach, Garner Co.....	96	Maebert & Reiss .....	96	Toner, Eugene S., Co.....	26
Dunn, Thomas J., & Co.....	23	Maple City Glass Co.....	98	Trenton Watch Co.....	88
Durand & Co.....	20	Market & Fulton National Bank.....	58	Trout, Charles L., & Co.....	22
Eden, C. H., Co.....	103	Marx, A. & C.....	96	Wadsworth Watch Case Co.....	6, 7
Eichberg & Co.....	46	Mathey Bros., Mathez & Co.....	76	Wagner Mfg. Co.....	28
Elgin National Watch Co.....	80	Mercantile National Bank.....	59	Waite-Thresher Co.....	31
Eliassof Bros. & Co.....	76	Meyerowitz Bros. ....	38	Washburn, C. Irving .....	25
Ellis & Co.....	26	Miller, L. A.....	68	Weizenegger Bros. ....	25
E. P. H. Chain Catch.....	100	Miller, Fuller & Whiting.....	29	Wells, Chester H.....	100
Fahys, Joseph, & Co.....	1	Moe, Chas.....	66	Wendell & Co.....	5
Fairchild & Co.....	98	Moore & Sons .....	22	Western Clock Mfg. Co.....	68
Favre-Jacot, Georges, & Co.....	84	Mount & Woodhull.....	44	Wheeler, Hayden W., & Co.....	36
Feeley, W. J., Co.....	25	Mueller Lapidary Co.....	46	White, Wm. A., & Sons.....	72
Forman Co.....	103	Myers, S. F., Co.....	52	Whiteside & Blank .....	21
Forsinger, J. W.....	89	Newark Cut Glass Co.....	98	Whiting & Davis .....	16
Foster, Theodore W., & Bro. Co.....	32	Nissen, Ludwig, & Co.....	44	Whiting, Frauk M., & Co.....	28
Four-Track News .....	100	Noel, Rudolph, & Co.....	62	Whiting Mfg. Co.....	9
Freund, Henry, & Bro.....	9	Nonnenmann, A., & J. Aschenbrenner.....	100	Wightman & Hough Co.....	29
Friedlander, R., L. & M.....	outside back cover	Noterman, Jos., & Co.....	66	Witsenhausen, L.....	24
Garreaud & Griser .....	24	Ohan, G.....	102	Wodiska, Julius .....	26
Gebhardt Bros. ....	66	Ollendorf, L., Co.....	46	Wolfshelm & Sachs .....	103
Gesswein, F. W., Co.....	96	Oppenheimer Bros. & Veith.....	36	Wood, C. F., & Co.....	Outside back cover
Goldsmith, Leo .....	46	Oppenheimer, H. E., & Co.....	36	Wood, J. R., & Sous.....	2, 3

## Special Notices.

Payable invariably in advance.

Rates 75c. per insertion for notices not exceeding 25 words; additional words, 2c. each.

SITUATIONS WANTED, 1c. a word each insertion; minimum charge, 25c.

Heavy type, 5c. a word; minimum charge, \$1.25.

Display cards, \$2.00 per inch.

In all cases, if answers are to be forwarded, 10c. extra to cover postage must be enclosed.

*All answers to advertisements addressed care The Jewelers' Circular-Weekly, should be sent to the New York Office, unless the Chicago Office is specifically mentioned.*

## Situations Wanted.

YOUNG MAN (22) wishes position as salesman or to work inside in wholesale house. "Wholesale, 6263," care Jewelers' Circular-Weekly.

FIRST CLASS WATCHMAKER, also fair engraver, desires position in west; best of references. Address L. W. Crahen, Butte, Mont.

YOUNG MAN (29), A1 salesman; for many years with large jobbing house; trade around New York. "Hustler, 6231," care Jewelers' Circular-Weekly.

SALESMAN, with well established trade in middle west, is open for engagement with manufacturing jeweler. "M., 6222," care Jewelers' Circular-Weekly.

YOUNG MAN (24) wishes position in wholesale house as stock clerk or salesman; 10 years' experience. "G. J. R., 6262," care Jewelers' Circular-Weekly.

BY YOUNG MAN, as letter and monogram engraver and plain jewelry repairer, desires to learn optical trade. F. M. Smith, 138 E. 6th St., St. Paul, Minn.

EXPERIENCED ENGRAVER, first class on letter and monogram work; open for position; best reference. Address "S. B. N., 6252," care Jewelers' Circular-Weekly.

BY A FIRST CLASS watchmaker; German; five years in country; 15 years' experience; age 29; have tools; my specialty is watch work. Geo. Brandt, Trinidad, Colo.

FIRST CLASS WATCHMAKER, with nine years' experience on fine watches; good references; salary not less than \$20 a week. Address R. T. Drumtra, Altenburg, Mo.

REFRACTIONIST and watchmaker desires position by June 1; young man of good habits; own tools and instruments. Address "June, 6266," care Jewelers' Circular-Weekly.

ENAMELER wants position; good all around man; badges, emblems, jewelry and transparent work; quick and steady. Address "Enameler, 6242," care Jewelers' Circular-Weekly.

YOUNG MAN (20) desires position in a wholesale jewelry house; good penman; experienced in general office work; reference. "J., 6243," care Jewelers' Circular-Weekly.

WANTED, A POSITION as engraver, book-keeper, cashier and saleslady; good references; terms reasonable. Address "Enquirer, 5877," care Jewelers' Circular-Weekly.

WATCHMAKER desires position, city or out of town; many years of practice here and in Europe; have American tools; references. Gotsdanker, 32 Windsor Place, Brooklyn, N. Y.

POSITION WANTED by first class watchmaker with high class jewelers; accustomed to waiting on trade; first class references. Address "W.," 129 Washington St., Newark, N. J.

WATCHMAKER, 35 years of age; good appearance; careful workman; fine tools; accustomed to taking in work; open for engagement. "B., 6241," care Jewelers' Circular-Weekly.

YOUNG MAN wishes position as watchmaker and plain engraver; can repair jewelry and wait on trade; eastern Pennsylvania preferred. "Pa., 6213," care Jewelers' Circular-Weekly.

POSITION WANTED; cut glass salesman; 10 years' experience; good references given; kindred lines considered. Address "C. G., Salesman, 6168," care Jewelers' Circular-Weekly.

WATCHMAKER, engraver; fine workman; very good salesman; 17 years' experience; age 32; A1 references; wants position with good house. "S., 6265," care Jewelers' Circular-Weekly.

A FIRST CLASS retail salesman, who desires to make a change early in the Fall, would like to correspond with firm in need of A1 man. "J. H., 6147," care Jewelers' Circular-Weekly.

FIRST CLASS manufacturing and repairing jeweler and A1 stone setter; \$20 per week; a rare chance to get good steady man; married. Address "Jeweler," 202 Court St., Memphis, Tenn.

ENGRAVER, young man desires position to finish trade with first class engraver; good letterer on flat ware; samples on request; A1 references. "L., 6232," care Jewelers' Circular-Weekly.

FIRST CLASS manufacturing jeweler of business ability, wants position as foreman of jewelry factory; 14 years' experience at bench; references. Address "Ability, 5465," care Jewelers' Circular-Weekly.

POSITION by plain watchmaker; six years' experience; have all tools; not afraid of work; strictly sober; moderate salary to start; reference exchanged. Address P. O. Box 101, Roxton, Texas.

A1 MANUFACTURING JEWELER, who has given up his own business lately, wants first class position in shop, where there is advancement; references. "Jeweler, 6244," care Jewelers' Circular-Weekly.

YOUNG MAN (22), having 2½ years' experience, wants position as assistant watchmaker under good man, to complete trade; am good on clocks and jewelry; best of references. Address F. G. Berger, Newark, N. Y.

WANTED, POSITION; young man, 22 years; four years' experience as second watchmaker; fair engraver; have own tools; southwest city preferred; best of references. Address "U., 6250," care Jewelers' Circular-Weekly.

WATCHMAKER and engraver, 20 years' experience; have tools; fast, accurate and clean; on account of change in firm desire position; state salary you can pay and hours of labor. "Watchmaker," care Mr. Clark, 143 Grand St., Albany, N. Y.

FIRST CLASS watchmaker wants a permanent position with a reliable house; over 20 years' experience; competent on fine and complicated work; fine tools; best of references. Address "L. F. V.," care Emile Dreyer, Room 9, 77 Nassau St., New York.

EXPERT WATCHMAKER, with long experience in all grades of complicated and fine Swiss and American watches; able to take full charge of watch department; own tools; best reference; wants steady and permanent position; \$16 to \$18 per week. "Expert, 6185," care Jewelers' Circular-Weekly.

HAVE YOU NEED for a reliable employe; 22 years' experience in the trade in New York and other cities; 12 years in responsible positions; now out of jewelry business and desire to return; open to any offer from good house; credentials of the best. "York, 6209," care Jewelers' Circular-Weekly.

## Help Wanted.

WANTED, a watchmaker to go into Michigan. Apply H. F. Hahn & Co., 156 Wabash Ave., Chicago, Ill.

WANTED, a good engraver; to assist on watches; steady position to a good, sober man; send samples. "J., 6238," care Jewelers' Circular-Weekly.

WANTED, for retail jewelry store in New York City, a bright salesman prefer one who is a watchmaker. "H, 6248," care Jewelers' Circular-Weekly.

WANTED, SALESMAN of long experience to sell good line of rings and jewelry for the middle west. "N. Y. Z., 6257," care Jewelers' Circular-Weekly.

WANTED, an experienced traveling salesman in optical and material line, by southwestern firm. "T., 6218," care Jewelers' Circular-Weekly.

YOUNG MAN WANTED to repair jewelry, clocks and do engraving; steady position; state salary and experience. A. Hawkins, 727 Eighth Ave., New York.

WANTED, first class watch and French clock repairer; good position for right man; must have A1 reference. W. J. Wolf, 43 Columbus Ave., New York.

WANTED, experienced jewelry salesman for jobbing trade; eastern territory; references required. Address "Z., 6221," care Jewelers' Circular-Weekly.

WANTED, WATCHMAKER, one who can do plain engraving; permanent position; reference required. Jos. De Roy & Sons, 307 Smithfield St., Pittsburg, Pa.

ASSISTANT WATCHMAKER, jeweler and clock repairer; state age, experience and salary wanted; also give reference. Address P. O. Box 392, Wheeling, W. Va.

FIRST CLASS letter and monogram engraver on jewelry and watches; permanent position; references required. Lambert Bros., Third Ave., cor. 58th St., New York.

WANTED, AT ONCE, good watchmaker; must be capable all around man and willing to wait on trade; send reference; salary, \$18. J. A. Oswald, Crawfordsville, Ind.

WANTED, an A1 traveling salesman; territory, Pennsylvania to Missouri; well established territory; commission or salary. Fred Kaufman, 565 Broadway, New York.

WATCHMAKER wanted, at once; young man preferred; steady position; out in the country; wages from \$12 to \$15. Address Emile Dreyer, 75 Nassau St., New York.

WANTED, good engraver, who also understands repairing jewelry and clocks; permanent position to first class man. Address J. W. Forsinger, 2 Maiden Lane, New York.

WANTED, WATCHMAKER, young man or old man, for repairing; about 70 watches per week; no tools needed; fan in the shop; state price wanted. F. C. Rivoire, Napoleonville, La.

ENGRAVER WANTED; man who is familiar with engraving as well as lettering, etc., for manufacturer; permanent position and good salary for right man. A. Bloedel, Milwaukee, Wis.

SALESMAN WANTED, on commission, to handle an up-to-date line of jewelry cases, display stands and trays in New York City and on the road. "S. P., 6034," care Jewelers' Circular-Weekly.

WANTED, WATCHMAKER; a thoroughly first class workman, who understands complicated work and fine Swiss watches; permanent position; good wages. "L., 6234," care Jewelers' Circular-Weekly.

WANTED, a first class watchmaker, jeweler, engraver and optician; must be a first class all around man; strictly sober and honest; good job for a good man; send references. Muncy & Godwin, Gainesville, Ga.

ENGRAVER to go to North Carolina; first class, all around engraver, enamel cutter, etc.; some knowledge of jewelry work if possible; position permanent; address, with references, etc. H. Mahler's Sons, Raleigh, N. C.

A SALESMAN WANTED with trade in New York and eastern States to carry a complete jobbing line; only an A1 man is wanted and must have established trade. "Established, 6227," care Jewelers' Circular-Weekly.

WANTED, to go to Virginia, first class jeweler and engraver; one who can take entire charge of department in first class store; an excellent opportunity for a capable young man. "Opportunity, 6225," care Jewelers' Circular-Weekly.

WANTED by jewelry and watch house, salesman for middle west. Address, "A. G., 6180," care Jewelers' Circular-Weekly.

WANTED a first class watch salesman with an established trade; good salary to the right man. Address, Rockford Watch Co., Rockford, Ill.

WANTED AT ONCE, an experienced practical optician and salesman; good salary and permanent position. Albert Pfeifer & Bro., Little Rock, Ark.

GOOD WATCHMAKER, jeweler, salesman and fair engraver in city near Pittsburg, Pa.; must be able to take charge of store at times; state age, experience and salary wanted. Address "Adjustable, 6237," care Jewelers' Circular-Weekly.

**HELP WANTED.—Continued.**

WANTED, AT ONCE, a competent watchmaker, plain engraver and jewelry repairer; permanent position; salary, \$20 week; chance of advancement; references and sample of engraving in first letter; apply at once. A. Rabinowitz, Stamford, Conn.

WANTED, by exclusive Chicago diamond house, two first class salesmen, one for Chicago and one for the road; must be experienced, control trade and furnish bonds. Address "Chicago, 6233," care Jewelers' Circular-Weekly, 103 State St., Chicago, Ill.

WANTED, a first class watchmaker, engraver and jeweler; surroundings pleasant; position permanent; one capable of taking charge of repair department; splendid opening for good man; state age, experience, etc. H. B. Dodge, 42 Market St., Lynn, Mass.

WANTED, a young man with experience as salesman in retail store, in flourishing Virginia town; mechanical experience would be advantageous, but not necessary; splendid chance for a young man who wants to advance himself. "Advancement, 6226," care Jewelers' Circular-Weekly.

WANTED, a first class all round jeweler, one who is capable of doing first class repairing and making new goods; particularly diamond work; good wages and steady work guaranteed to the right man; none but sober, steady men need apply. Address "Reliance, 5940," care Jewelers' Circular-Weekly.

WANTED, MAN familiar with manufacture of nickel silver forks and spoons for plating, including rolling, blanking, shaping, forming and polishing of German silver metal, for position as general foreman; must possess good executive ability; salary, \$1,560 up. Call or write, Hapgoods, Suite 511, 309 Broadway, New York.

WANTED, strictly first class combination man (watchmaker, jeweler and engraver); must be sober and well recommended; good salary and permanent position to good man; must be a willing worker, rapid and very thorough; state salary expected and send sample engraving first letter. Thos. Van Auken & Co., 516 Pearl St., Beaumont, Tex.

AN EXPERIENCED gold and silver thimble maker; steady position to the right man; write stating experience, references, etc. Ketcham & McDougall, 45 York St., Brooklyn, N. Y.

WANTED for New York City, inside jewelry salesman and stock man; also salesman and watchmaker; salary \$18 to \$25 per week. Address with particulars, "Permanent, 6161," care Jewelers' Circular-Weekly.

RING SALESMAN; an experienced ring salesman having an established trade with best retail jewelry stores; state experience; only high class men with ability considered. Address, "Manufacturer," P. O. Box 881, New York.

SALESMAN WANTED by Newark manufacturers of silver toilet and hollow ware, for New York City and vicinity; young man who is acquainted with the jewelry and department store trade and also out-of-town buyers; to such a man a good commission deal will be made; in answering state by whom at present employed, also reference. "Newark, 6081," care Jewelers' Circular-Weekly.

ANNOUNCEMENT; on or before June 1, we will make room for a limited number of young beginners, to learn and perfect themselves in the art of practical watch repairing; we train them quicker and with closer attention than the crowded horological schools. For terms or other information apply direct or by letter to Maebert & Reiss, practical and theoretical watchmakers, 71-73 Nassau St., cor. John St., New York.

**Side Lines Wanted.**

WANTED, a side line to sell to the jewelry trade in Pennsylvania, Ohio and West Virginia, from Aug. 1; thorough acquaintance with the trade. "Line, 6204," care Jewelers' Circular-Weekly.

WANTED, several good lines for New York City, in addition to those now carried; experienced man. Address "E., 6269," care Jewelers' Circular-Weekly.

WANTED, by experienced traveling salesman, on commission, a line either of jewelry, combs, silver, watches, or some line for jewelers in west and northwest States. "Commission, 6230," care Jewelers' Circular-Weekly.

**Business Opportunities.**

AN OPTICIAN can rent part of store with a jeweler, at 719 Fulton St., Brooklyn, N. Y.

FOR SALE, jewelry store in Brooklyn, with or without stock; reasonable. "O., 6219," care Jewelers' Circular-Weekly.

JEWELRY and optical store, doing a fine business in a growing Massachusetts town; only optician in town. "V., 6239," care Jewelers' Circular-Weekly.

\$10,000 JOBBER'S stock for sale, at any reasonable price; consisting of all kinds of diamond jewelry as well as other jewelry and watches. "Stock, 6036," care Jewelers' Circular-Weekly.

JEWELRY STORE for sale on one of the main streets in Brooklyn, with or without stock; reasonable terms; dissolution of partnership cause of selling. Address Breslavsky Bros., 654 Broadway.

NOTIFY ME if you wish to retire from business or have any old stock that you want to dispose of; I pay the highest cash prices for such stock, a great deal more than any auctioneer would pay. M. Kleinman, Room 14, 41 Maiden Lane, New York.

PARTNER WANTED, man about 30, who is well acquainted with the jewelry trade and can invest about \$5,000 in an old established manufacturing jewelry concern of A1 reputation. Address "Maiden, 6228," care Jewelers' Circular-Weekly.

FOR SALE, jewelry store, with optical business and watch and jewelry repair trade; population very near 2,000; no jeweler or watchmaker; good reason for selling; write at once as this is a special opportunity for a good man. Address "Good Chance, 6217," care Jewelers' Circular-Weekly.

QUICK ACTION by corresponding with us; we buy your entire stock; or send us your surplus stock of watches and diamonds; we originated this method and have twenty years of quick action and good service to our credit. Joseph Brown & Co., Fifth Ave. and Madison St., Chicago, Ill.

FOR SALE, first class factory, for manufacture of rings; valuable good will and large line of customers free; full line or part of samples below cost; office fixtures, traveling outfits, safes and all machinery and tools at very low figure. Address "Mark, 6255," care Jewelers' Circular-Weekly.

FOR SALE, a jewelry business, a success and established for years, has the utmost confidence of the people; a town of 3,000 in north Mississippi and on two main lines of railroad; health unsurpassed; educational town; electric lights; water works; sewerage; stock and fixtures about \$7,000; can be reduced; clean, up-to-date stock; business expenses low; last annual sales footing \$10,958.73; work, \$1,220; do not think this opportunity can be surpassed with capital invested; only correspondence with persons of reliability and who mean business will be answered. Address "D., 6157," care Jewelers' Circular-Weekly.

DO YOU WISH TO RETIRE? We buy jewelry stores to any amount; also entire stocks of jewelry, diamonds, watches, silverware, fixtures, etc.; we are known all over the United States to pay highest spot cash; notify us, we will call on you at once; all business transacted we handle strictly confidential. Address Brooklyn Purchasing Syndicate, 608 Broadway, Brooklyn, N. Y., or Tel. 2328, Williamsburg.

**For Sale.**

600 SMALL DIAMOND rings to sell at 60 cents on the dollar. M. Kleinman, Room 14, 41 Maiden Lane, New York.

FOR SALE, wooden partition, counter, wardrobe, iron railing, show case, etc., at bargain. Room 24, Sheldon Building, 68 Nassau St., New York.

FOR SALE or exchange, new Francis engraving machine with type; will exchange for optical instruments. "N., 6235," care Jewelers' Circular-Weekly.

AN ENTIRE SET of fixtures of an up-to-date jewelry store, for sale; also store room for rent; owner retiring on account of ill health. Chas. A. Kuhn, Hanover, Pa.

FOR SALE, one Francis engraving machine with complete set of attachments and type; in good condition; bargain if taken at once. "Bargain, 6270," care Jewelers' Circular-Weekly.

ONE Excelsior swaging machine, No. 4, for hollow wire work; capacity, 1½ inch down, with nine pairs of dies, included, for sale at half its value. Inquire Crossmire & Ackor Co., 42 Walnut St., Newark, N. J.

FOR SALE; first class ring factory; in perfect running order; electric motor and all machinery as a whole or in parts; will sell cheap to save rent. Address "Electric, 6254," care Jewelers' Circular-Weekly.

BRAND NEW SET of mahogany trays, stack, lined with best quality green velvet; trays that would regularly cost \$2 each will sell for \$1 each; trays in set as follows: 18 watch trays, size 11½ x 11¼; 10 ring trays, size 11½ x 6¾; 24 plain trays, size 11½ x 11¼; 2 locket trays, size 11½ x 11¼; 10 ring trays, size 11½ x 11¼; 2 chain trays, size 14¼ x 11½; 10 plain trays, size 11½ x 10¾. Address "Trays, 6223," care Jewelers' Circular-Weekly.

**To Let.**

DESK ROOM or part of office to let. 3 Maiden Lane, Room 53, New York.

TO SUBLET, a particularly light and desirable office; reasonable rent; in Prescott Bldg., Room 87, 65 Nassau St., New York.

TO LET, part of an exceptionally desirable office; excellent light; opportunity for precious stone business. Room 1207, Myers Bldg., 49 Maiden Lane, New York.

TO LET, part of an exceptionally desirable office, with fine north light; opportunity for precious stone business or manufacturing agent. Room 48, Lorsch Bldg., 37 Maiden Lane, New York.

TO LET, in center of jewelry district, 31 Maiden Lane, New York, one door from Nassau St., second, third and fourth lofts; good light and air; very desirable. Address F. J. Whiton, 130 Broadway, New York.

PART OF OFFICE to lease; good light; suitable for watchmaker, diamond broker or dealer in precious stones; desk, chairs and shelf furnished. Address "Cockcroft Building, 6246," care Jewelers' Circular-Weekly.

WILL RENT to desirable party desk room with office privileges in light attractive office; manufacturer's representative or diamond dealer preferred. "Maiden Lane, 6114," care Jewelers' Circular-Weekly.

**Wanted to Purchase.**

WANTED TO BUY a retail jewelry store; traffic trade in New York City. Apply "Retail, 6205," care Jewelers' Circular-Weekly.

WANTED, diamond scale, enclosed; must be in perfect condition and cheap. Geo. W. Heath & Son, 350 Canal St., New York.

ANTIQUA JEWELRY WANTED; also all kinds of jewelry containing old mine diamonds and precious or semi-precious stones. Send them all to Chas. S. Crossman & Co., The "Old Mine" Diamond House, 3 Maiden Lane, New York, who will make you an immediate cash offer.



**THE TRADE**

desirous of keeping in touch with modern, profit-producing methods, should always consult the 500 pages of

**OUR BIG CATALOGUE,**

with its 30,000 illustrations and long list prices. We send this splendid book free on request.

*S. F. Myers & Co.*

Headquarters for Dueber-Hampden Watches.  
WHOLESALE JEWELERS

The New S. F. Myers Bldg. 47C-49 Maiden Lane New York.

## Boston Jewelry Manufacturing Co.

### The Mounting and Repairing House of New England.

We eclipse all others in design, quality, promptness and finish of work.

A line of entirely new styles in mountings always on hand.

**Jewelers' Building,  
BOSTON, MASS.**

### Optical Notes and Briefs.

The J. J. Boyd Optical Co., York, Pa., has applied for a charter of incorporation.

Dr. A. W. McAllister, Jefferson City, Mo., has been appointed consulting oculist for the State Penitentiary.

G. H. Goodwin, Tracy, Minn., has located in Marshall, Minn., where he has opened an optical establishment.

The jewelry store of B. D. Olmstead, Udall, Kans., has been destroyed by fire, along with other business houses.

The North American College of Optics, of Highfield, Md., was incorporated, May 1, in Hagerstown, Md., by W. M. and Frank Happel, G. W. Kettoman, A. A. Fox and J. Warren Kettoman.

Bert Bradley, who has been with A. M. Ward, Abilene, Kans., has been married and is now locating in the jewelry business for himself in Mattoon, Ill.

The Maine Optical Co., Augusta, Me., has bought the business of C. H. Russell, of that city, and moved into the store occu-

piated by him. The Maine Co. will occupy three floors of the building, with sales-room on the ground floor and factory on the second floor.

The New England Optical Co., 232 Merrimac St., Lowell, Mass., has sold its optical business to John A. McAvoy.

E. C. Roberts, Red Wing, Minn.; A. C. Wilson, Minneapolis, and M. M. Morrison, Osage, Ia., recently met in Rochester, Minn., with Prof. J. W. Grainger, of that city, to consider a plan of work and a course of study for the new college of optometry soon to be opened by the College of Optometry of the State of Minnesota.

Edward E. Arlington, chairman of the legislative committee of the New York State Optical Society, and Mrs. Mary D. Farrington were married Tuesday evening, May 2, at the home of Rev. Dr. S. Banks Nelson. Mr. and Mrs. Arrington left on an evening train for Montreal and Northern Canada.

The Indiana Optical Society held its Spring meeting at the New Denison Hotel, Indianapolis, Ind., Thursday and Friday of last week. There were only a few members in attendance. Discussion for the most part was centered on legislation that will be urged at the next meeting of the Indiana General Assembly. The society will probably ask the Legislature to pass a bill creating a board to examine and give certificates to eye specialists who wish to practice in the State.

The Bangor Jewelry & Optical Co., which has been incorporated under the laws of Maine, with A. P. Trask as treasurer, bought the stock and fixtures of J. R. Mosher, who failed not long ago. Mr. Trask had held the stock under a mortgage. The concern is doing business at 71 Main St., Bangor, Me., with R. H. Williston in charge of the optical department and F. E. Mincher and G. E. Chase, formerly with W. C. Bryant, in charge of the jewelry department.

G. H. Sherman has gone out of the jewelry business in Paola, Kans.

W. H. Yates has purchased the jewelry store of M. E. Cook, in Novinger, Mo.

Ed Black, a jeweler of Phoenix, B. C., has moved into new and better quarters.

**HENRY C. HASKELL**

Designer and Maker

Correspondence invited for Special Articles of every description, gold or silver, from exclusive designs.

15 West 27th Street, New York

### Desirable Factory Space,

17 John Street, New York.

Very reasonable. Power furnished. Apply to

**WM. A. WHITE & SONS,**  
62 Cedar Street, N. Y.

# QUALITY COUNTS

The Increasing Sale of = = = **TAVANNES WATCHES**

Proves their worth as timekeepers

**FULLY GUARANTEED**

For sale through the jobbing trade



**TAVANNES WATCH CO.,**  
2 & 4 Maiden Lane, New York.





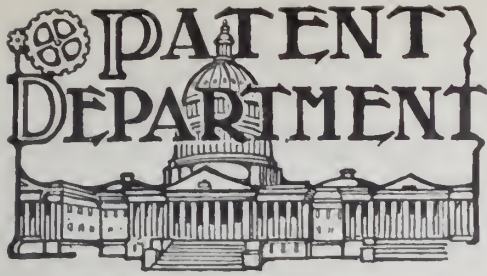

[IN WHICH IS CONTAINED A LIST OF THE LATEST PATENTS GRANTED BY THE UNITED STATES AND GREAT BRITAIN, THE UNITED STATES PATENTS THAT HAVE EXPIRED AND THE REGISTERED TRADE-MARKS.]

UNITED STATES PATENTS.

ISSUE OF MAY 1, 1906.

**S19,121. HOLDING AND GRIPPING PLIERS.** JOHN CARTER, Malden, Mass., assignor to the Globe Optical Co., Boston, Mass. Filed Jan. 18, 1906. Serial No. 296,597.

Holding and gripping pliers for opticians' use comprising a pair of co-operating longitudinally-slotted jaws; the outer upper face of one of said



jaws being formed directly in rear of its nose end with a depression to permit the free movement of the frame under operation and the inner face of the other of said jaws being formed with a transverse groove adapted to receive the curved lens-holding part of a strap.

**S19,272. STEREOSCOPE.** CHARLES FRAZER, Bennington, Vt. Filed Dec. 20, 1905. Serial No. 292,577.

In a stereoscope, in combination, the box or eye-guard *a*; the bar or frame *c* extending from said box or eye-guard; a slide mounted on said bar and provided with means for holding the photograph or view; a handle rotatively supported by said bar or frame; the bar *f* secured to the under side of

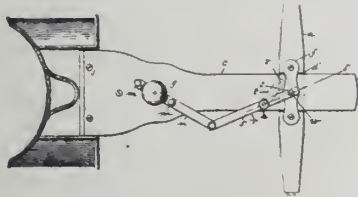

the slide and extending across the under side of the frame *c*; a pivot-pin extending downward from said bar *f*; the bar *n* rigidly connected at one end with the handle; the bar *r* pivotally connected at one end with the forward end of the bar *n* and provided near its outer end with the notch or screw *s*; the latch *t* pivotally connected at one end with the bar *r* and provided near its outer end with the notch or recess *v*; and means for swinging said latch from its connected end whereby its notch may be moved into engagement with said pivot-pin.

**S19,294. FOUNTAIN-PEN.** HENRY B. LEVY New York. Filed Aug. 22, 1905. Serial No. 275,216.

A fountain-pen comprising a barrel, a piston therein, and a pen-covering cap, said cap having



an elongated neck adapted for insertion into the barrel and to be detachably connected with the piston to act as a piston-rod therefor.

**S19,444. HAIR-STRAIGHTENER.** SIMON E. MONROE, Boston, Mass., assignor, by direct and mesne assignments, of one-third to Benjamin F. Jackson, Boston, Mass., and one-third to James H. McDonough, Chelsea, Mass. Filed Sept. 21, 1903. Serial No. 173,963.

A hair-straightener comprising a body portion

having a metallic back piece provided with a chamber, rigid metallic teeth carried by said body portion, those teeth which are beneath the chamber



being hollow and communicating with the chamber, and bristles also secured to the body portion and interspersed between the teeth.

**S19,568. WATCH.** ROBERT MANTHEY, Bridgeport, Conn. Filed Oct. 26, 1903. Serial No. 178,482.

In a watch free from center wheel and center wheel pinion, the combination with a main-wheel arbor rotating from left to right, and a minute

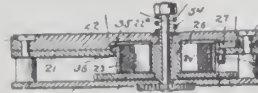

wheel in frictional engagement therewith, said minute-wheel having its axis in alignment with the axis of the main-wheel arbor, of a cannon-pinion, a pinion intermediate the cannon-pinion and the minute-wheel, and a dial-wheel, dial-pinion and hour-wheel.

**S19,574. TICKET-CASE.** NEWTON W. MOORE, Windber, Pa. Filed Oct. 26, 1905. Serial No. 284,574.

A ticket-holder consisting of a casing of rectangular form, a cover hinged at one edge to one of the longer sides of the casing and adapted to



overlap the opposite edge and a portion of the back of the casing and to be secured to said back, a frame mounted in said casing, a roller journaled in said frame, and adapted to receive a roll of tickets, and a block arranged within the casing, said casing having an opening at one end for the passage of the tickets from the roll, and said lid or casing having a cut-away portion to permit the tickets to be gripped.

**S19,590. COLLAR AND CUFF BUTTON.** CHARLES S. PEDERSON, Alstad, Wis. Filed April 11, 1905. Serial No. 255,041.

A collar-button comprising two members, each provided with a peripheral flange adapted to en-

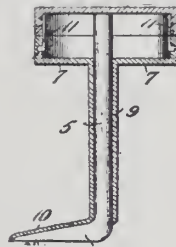

gage with each other and form a cylindrical head, a stem projecting from one of the members and having a laterally-projecting arm at its free end, and a sleeve projecting from the other member and formed with a housing to receive the stem, said stem being rotatably mounted in the sleeve, and means for locking the members, said means being housed and concealed by the members.

**S19,603. MATCH-BOX.** JAMES W. SAUNDERS, Reynolds, Ill. Filed Dec. 4, 1905. Serial No. 290,233.

A match-box comprising a hollow body portion



having an open end, a removable closure for the open end, said closure having an opening therein

at its lower portion, a slide movable into and out of position to close the opening, means for holding the slide yieldably in operative position, a pin carried by the slide for movement of the latter against the action of the spring, a longitudinally-extending gutter disposed within the body portion in position to discharge matches therefrom through the opening of the closure, upwardly-divergent wings carried by the gutter and resting against the sides of the body portion, and a vertical plate secured within the body portion and lying with its lower portion between and in spaced relation to the wings.

**S19,680. EASEL.** JOHN WEBER, Newark, N. J. Filed Dec. 13, 1905. Serial No. 291,647.

In an easel of the class described, a card or plate, in combination with a brace attached at one end to the card or plate and having its other end

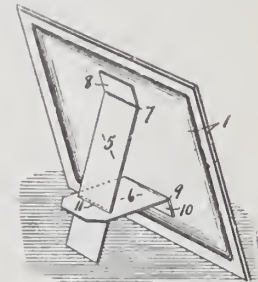

adapted to swing to and from the plate and provided with a transverse slot of substantially the same width lengthwise of the brace as the thickness of the leg, and a leg attached to one end of the plate and having its other end passed through said slot to establish a sliding interlocking connection with the brace.

DESIGNS.

**37,971. WATCH CASE.** JOHN BAIN, Pittsburg, Pa. Filed Feb. 26, 1906. Serial No. 303,126.



Term of patent 7 years.

**37,972. CLOCK-FRAME.** STANLEY M. LAWSON, Cincinnati, O. Filed March 12, 1906. Serial

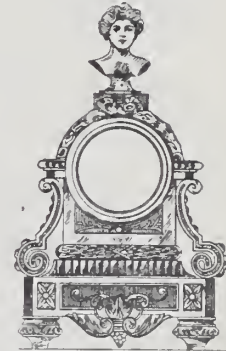

No. 305,725. Term of patent 3½ years.

**37,978. FOUNTAIN-PEN HOLDER.** FRANK A. WEEKS, Plainfield, N. J. Filed March 10,

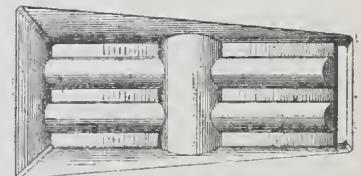

1906. Serial No. 305,414. Term of patent 7 years.

**37,973. CLOCK-FRAME.** STANLEY M. LAWSON,

Cincinnati, O. Filed March 16, 1906. Serial

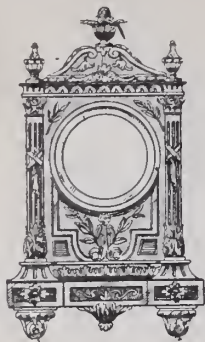

No. 306,470. Term of patent 3½ years.  
37,974. CLOCK-FRAME. STANLEY M. LAWSON,  
Cincinnati, O. Filed March 19, 1906. Serial

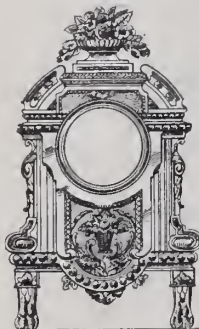

No. 306,936. Term of patent 3½ years.  
37,975. CLOCK-FRAME. STANLEY M. LAWSON,  
Cincinnati, O. Filed March 22, 1906. Serial



No. 307,549. Term of patent 3¼ years.

#### UNITED STATES TRADE-MARKS.

[The following trade-marks have been adjudged entitled to registration under the Act of Feb. 20, 1905, and are published by the Patent Office in compliance with Sec. 6, of said act, which provides: "Any person who believes he would be damaged by the registration of a mark may oppose the same by filing notice of opposition, stating the grounds therefor, in the Patent Office, within 30 days after the publication of the mark sought to be registered, which said notice of opposition shall be verified by the person filing the same before one of the officers mentioned in Sec. 2, of this act. If no notice of opposition is filed within said time the Commissioner shall issue a certificate of registration therefor, as hereinafter provided for."]

PUBLISHED MAY 1, 1906

SER. No. 2,631. SALVE FOR THE TREATMENT OF SORE EYES. THE E. E. SUTHERLAND MEDICINE Co., Paducah, Ky. Filed April 21, 1905.

## EAGLE EYE

The arbitrary words "EAGLE EYE."

SER. No. 5,356. HAND-MIRRORS, MANICURE SETS, TOILET AND TOOTH BRUSHES, TOILET-TRAYS AND BOXES OF ENAMELED WARE. J. C. DOWD & Co., New York. Filed May 12, 1905.

## Ebonoid

The word "EBONOID."

SER. No. 11,542. METAL-POLISH. PHILIP H. SOLOMON, St. Louis, Mo. Filed Aug. 11, 1905.

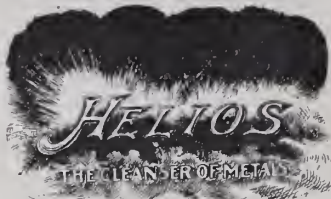

The words "HELIOS THE CLEANSER OF METALS" displayed on a background representing clouds and auroral radiations.

SER. No. 12,013. MEDALS AND BADGES. CALVIN W. LITTLE, Montclair, N. J. Filed Aug. 26, 1905.

## LITTLE SYSTEM

The words "LITTLE SYSTEM" arranged in oppositely-curved lines.

SER. No. 12,176. WATCHES. WEBSTER C. BALL, Cleveland, O. Filed Sept. 2, 1905.

## COMMERCIAL

The word "COMMERCIAL."

SER. No. 14,695. ELECTRO-PLATED HOLLOW WARE, ELECTRO-PLATED OR SILVER-PLATED TABLE WARE, AND ELECTRO-PLATED OR SILVER-PLATED FLAT WARE. GORHAM MFG. Co., Providence, R. I. Filed Nov. 15, 1905. Used 10 years.

## GORHAM

The word "GORHAM."

SER. No. 16,263. WATCHES, WATCH-MOVEMENTS, WATCH CASES AND WATCH PARTS. WILLIAM F. DOLL, New York. Filed Jan. 17, 1906. Used 10 years.

## DOLL

The word "DOLL."

SER. No. 17,302. ORNAMENTAL WATCH AND NECK CHAINS. ANNIE M. HALE and EDWIN E. HALE, North Attleboro, Mass., executors of estate of Oscar M. Draper, deceased. Filed Feb. 23, 1906. Used 10 years.

## NONPAREIL

The word "NONPAREIL."

TRADE-MARKS REGISTERED MAY 1, 1906.

51,993. FOUNTAIN-PENS. L. E. WATERMAN Co., New York.

The arbitrarily-associated representation of a globe, a fountain-pen extending across the same, and a line extending from the pen-point and surrounding the globe.

Filed May 5, 1905. Serial No. 4,348. Published March 6, 1906.

52,174. WATCH CASES AND WATCH

MOVEMENTS. HAYDEN W. WHEELER & Co., New York.

The character "W," with the letters "H" and "W" within the loops thereof.

Filed April 20, 1905. Serial No. 2,378. Published March 6, 1906.

52,192. COMBS. DR. HEINRICH TRAUN & SOHNE, Hamburg, Germany.

The representation of a man sawing a log of wood with a comb. Filed July 21, 1905. Serial No. 10,678. Published March, 1906.

#### UNITED STATES PATENTS THAT HAVE EXPIRED.

[Reported especially for THE JEWELERS' CIRCULAR-WEEKLY by R. W. Bishop, Patent Attorney, Washington, D. C.]

Issued April 30, 1889.

402,135. ENGRAVING AND CHASING MACHINE. W. W. BRADLEY, Newport, Ky., assignor to J. C. Dueber, same place.

402,171. CUTTING-OFF MACHINE FOR JEWELERS' STOCK. F. L. LEWIS, Providence, R. I.

402,176. CUFF-HOLDER. C. O. McCASLAND, Denver, Colo.

402,314. ART OF ENGRAVING. W. S. EATON, Sag Harbor, N. Y., assignor to Fahys Watch Case Co., same place.

402,316. ENGRAVING MACHINE. C. H. FIELD, Providence, R. I.

402,320. METHOD OF SECURING BLADES TO METAL HANDLES. HORACE GLINES and W. W. HOLMES, Bridgeport, Conn.

402,309. ELECTRICAL CLOCK. A. M. J. and V. J. A. M. JANSEN, San Willibrord, Curacao.

402,343. REPEATING WATCH. CHARLES MORLET, Hoboken, N. J., assignor of one-half to Prosper Nordman, New York.

402,359. TIME-REGISTER. H. W. SMITH, St. Louis, assignor of one-half to H. C. Baker, Kansas City, Mo.

402,380. WATCH-ENGRAVING MACHINE. AMI ZUAHLEN, Philadelphia, Pa.

402,417. FOUNTAIN-PEN. S. D. DIAS, New York.

402,466. CANDELABRUM. THOMAS MCGOVERN, New York.

402,473. WATCH-PENDANT. PAUL PERRET, Chaux-de-fonds, Switzerland.

402,486. UMBRELLA. SIMON SCHWARTZ, Joplin, Mo.

Designs issued April 26, 1892, for 14 years.

21,497. PAPER-WEIGHT. WILLIAM LANYON, Jr., Pittsburg, Kans., assignor of one-half to N. V. Lanyon, same place.

21,500. BOTTLE. J. P. CHERRY, Nashville, Tenn.

21,509. BOTTLE. MAX OBERFELDER, Chicago.

Designs issued May 2, 1899, for 7 years.

30,643. MEDAL. H. K. SOLBERG, Clarkfield, Minn.

30,647. FINGER-RING. C. H. PFELL, Chicago.

30,648. LADLE. W. A. JAMESON, Niagara Falls, N. Y.

30,649. SPOON. W. A. JAMESON, Niagara Falls, N. Y.

30,653. FLOWER-HOLDER. CORA N. LITTLEHALE, El Paso, Tex.

30,655. ERASER-HOLDER. L. W. FABER, New York.

30,665. LAMP. L. C. TIFFANY, New York., assignor to Tiffany Glass and Decorating Co., same place.

30,705. PIN-CUSHION. CORRY JONES, New York.

Burglars who recently broke into the store of C. W. Fleming, Lincoln, Nebr., escaped with watches, diamonds and miscellaneous jewelry valued in all at about \$1,000. The way in which the thieves gained entrance was unique. A skylight over the storeroom in the rear of the store was shattered, a rope was attached to an iron projection, and the intruders slid down. They then raised a window opening into the store proper, by means of a lever, and went direct to the front show window, which was filled with stock.

**BRITISH PATENTS.**

(ABRIDGMENTS OF SPECIFICATIONS, 1904, FROM *The Illustrated Official Journal.*)

ISSUE OF APRIL 19, 1906.

**28,423. SIGHT-TESTING APPARATUS, MICROSCOPES.** S. CZAPSKI, Jena, Saxe-Weimar, Germany. Dec. 27.

Relates to an instrument for making observations and measurements in connection with the eyes of a patient while they are accommodated for distant vision. The tubes  $b^1, b^2$  are held parallel by the end-pieces  $d^1, g$ , the former being shaped to fit the bridge of the nose, and the latter having a shade

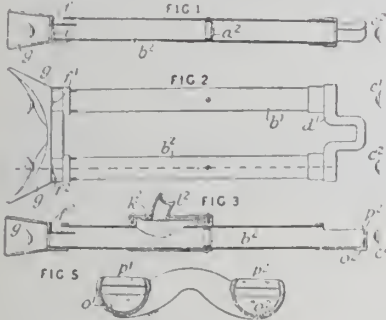

for the operator's face. A lens  $a^2$  is fixed in each tube in such a manner that a mark  $f^1$  and one of the patient's eyes occur approximately at the principal foci, and hence the marks  $f^1, f^2$  are seen as at a distance. The operator will similarly observe the patient's eyes, and, in order that the two may not be seen superposed, a prism  $i$  is inserted at the end of the tube. In a modification, a shutter  $k^2$ , Fig. 3, with a finger-stud  $l^2$  is provided, so that each eye may be examined separately, and a scale  $p^2, o^2$ , shown enlarged in Fig. 5, is arranged to measure the interocular distance, the lower part  $o^1, o^2$  giving the distance between the lenses for long-distance spectacles, and the upper  $p^1, p^2$ , graduated to a larger scale, giving the distance for reading spectacles.

**28,460. TIME-CHECKING APPARATUS FOR WORKMEN.** C. GEDDES, Water St., Liverpool. Dec. 27.

To register and signal the occasions on which workmen and employes spend excess time in latrines, a time-alarm apparatus is set in motion by the removal therefrom of the latrine key, and the door and lock of the latrine are so arranged that the key cannot be removed unless the door is closed.

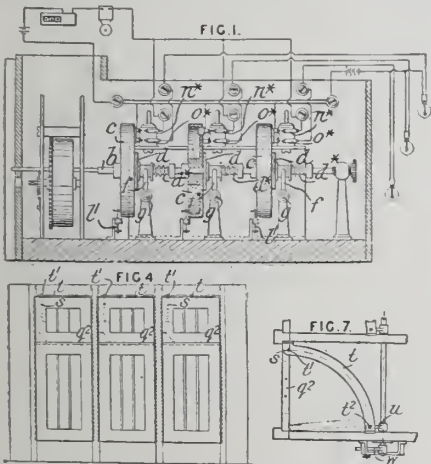

Each key is hung from an arm on its spindle  $g$ , Fig. 1, and the fork  $f$  being thereby urged to the right keeps the spring  $a^*$  compressed. Upon removal of the key, the spring presses the friction clutch  $d$  to the left and locks the weighted drum  $c$  to a spindle  $b$  which is constantly driven by clockwork. Metal plates carried by the drum make contact, after a certain angular movement, between spring plates  $n^*$  in a bell and counter circuit, and also between similar plates  $o^*$  in a circuit containing a lamp in the latrine, which is thereby lit up and warns the occupant. When the key is replaced, the drum is freed and is returned to its normal position by the counterweight, a pivoted stop  $l^1$  and a pin arresting the motion. The latrine has lower doors without locks upon

which small upper doors  $q^2$ , Fig. 4, overlap, so that in the only possible position for removal of the key, when the bolt  $s$  takes into the hole  $t^1$ , both the upper and the lower doors are shut and locked. To prevent locking in any other position and consequent return of the key to stop the time-alarm apparatus, the bolt is kept from rising in any position of the door save the closed one by a quadrantal guard  $t$  shown in plan in Fig. 7. Normally, the maximum opening of the door is determined by a stop  $u$ . When, however, it is desired to use the latrines apart from the time-signal, this stop may be displaced by the external handle  $z$  and the upper door may then be locked open and the key removed by allowing the bolt to rise into the second hole  $t^2$ . To prevent use of a latrine twice in a given time by the same employe, a metal check identified by his number may be put through a slit into a locked box when he returns the key.

**28,533. STYLOGRAPHIC PENS.** B. W. WARWICK, London, N. Dec. 28.

The writing-needle of a stylographic pen is set at an angle to the length of the pen so as to be perpendicular to the writing-surface when in use. The needle F, Fig. 2, is carried by a screw or plug G in a crosshead E, Fig. 3, set at an angle of about 40 degrees to the axis of the pen. The needle may be coiled to form a spring as shown in Figs. 2 and

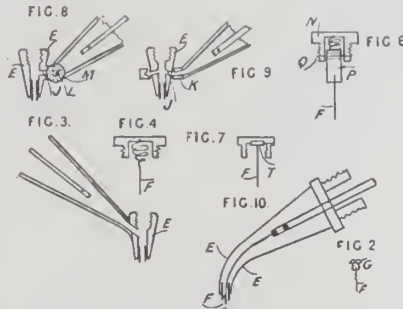

4, or attached to a tympanum T, Fig. 7, or to a spring-controlled oscillating hock P, Fig. 6, held by a slot and pin Q in the plug N. To adjust the angle of the crosshead E, it may have a tongue M so as to be clamped in a recess in the end of the pen by a screw L, a duct J supplying the ink. To prevent unequal wear of the writing-point, the plug E, Fig. 9, may be carried in the ring K formed on the end of the pen and having a supply groove to feed the duct J. The head E is sprung into the ring during manufacture. In another form, the end section E, Fig. 10, of the pen, and the needle F are both curved to bring the writing-point to the desired position.

**28,565. WATCHES.** A. BAUME (trading as Baume & Co.), Holborn Circus, London. Dec. 28. Drawings to specification.

*Stop-Mechanism, Dials, Hands.*—For purposes such as yacht racing, in which it is necessary to know the amount of time left before a signal will be given, two dials are provided at the back and front of a watch respectively, and hands on the same shaft sweep round these dials. If the numbering is the same on both dials, the hands turn in opposite directions relatively to the dials and one will give the time that has elapsed and the other the time that is to elapse. The hands are set to zero in the usual way, and the watch may have one of its dials to register time as in an ordinary watch.

**28,739. HOOK FASTENINGS.** P. L. WEEGER, Buffalo, N. Y., U. S. Dec. 29.

Relates to a fastening applicable to belts, garters, necklaces, neckties, etc. The fastener consists of two parts 1, 2 made of spring steel. The member

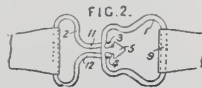

1 is a continuous ring formed with a straight bar 9 for attaching to the article to be fastened, and an inwardly-projecting spear head 5. The other member 2 is formed with two parallel legs 11, 12 terminating in hooks 3, 4, adapted to form a spring connection with the spear head 5 as shown. The parts are disconnected by turning the member 1 at right-angles to the other member.

**28,751. EYE-PROTECTORS AND GOGGLES.** E. MIROVITCH, Paris. Dec. 29. (Date applied for under Patents Act, A.D. 1901, March 24.)

Pince-nez protectors or goggles are constructed

so that the eye-chambers are ventilated, and so as to be readily folded into a small space. The glasses  $a$  are set in bands A, fitted on eye cups B, which have soft india-rubber heads  $b$  and flexible ventilating tubes  $c, c^1$  with flared outer ends. Each pair of ventilating-tubes may be enclosed in a casing of flexible material. The nose-bridge D is

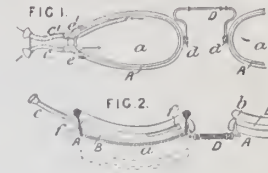

secured to the eye cups by ball-and-socket joints  $d$ , and its central part consists of a spring-pressed slide clamped in adjusted position by a screw or other stop. Each eye cup carries two loops  $e, e^1$ , connected by cords to an elastic band which is passed round the head to keep the goggles in position. Each band A may be secured in its eye cup by a pin  $f$  and a spring  $f^1$  carrying a projecting pin and a disengaging push-piece.

**28,823. LENSES.** M. BENTZON and A. H. EMERSON, both in London. Dec. 29. Patent not yet due for sealing.

Relates to solid bifocal lenses, particularly for spectacles and eyeglasses, and to apparatus for making them from single pieces of glass, etc. The lenses may be constructed in such a way, as shown in Fig. 2, that there is no ridge or step between

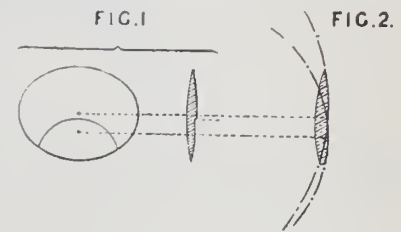

the parts of different curvature. Fig. 1 shows a lens with such a ridge. The two curvatures may be formed at one operation by a machine carrying two or more tools as shown in Fig. 8, or glass on which one of the curvatures has already been produced may be operated on by a machine carrying a single tool as shown in Fig. 3. Two single-tool machines may be used together. The glass-carriers are supported on a table slide 2, while the tool-carrying spindle 4 is rotatable in bearings on a carrier head 5 adjustably clamped

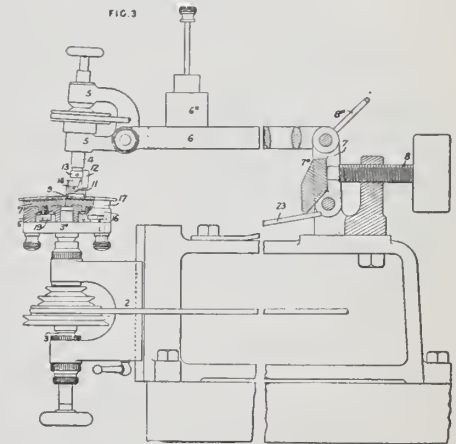

to an arm 6 pivoted to a lever 7 which carries a block 7 adjusted by a screw 8 and a spring 23, to enable the position and inclination of the tool spindle to be adjusted. The pressure of the tool on the work is adjusted by weights 6 on the arm 6. A support 8 is provided for the arm 6 when turned back. The tool 9 is shown attached to the spindle 4 by a ball 11 engaging a spring 14, and a tongue 12 engaging slots in the tool and in a collar 13. The tools may rotate in the reverse direction to or in the same direction as the lens-holder, or the lens-holder may be stationary and the tools made to revolve as well as rotate. Approximately the desired curvature is produced by steel, etc., rough-grinding tools, after which

**SETH THOMAS CLOCK COMPANY.**

Established 1813.

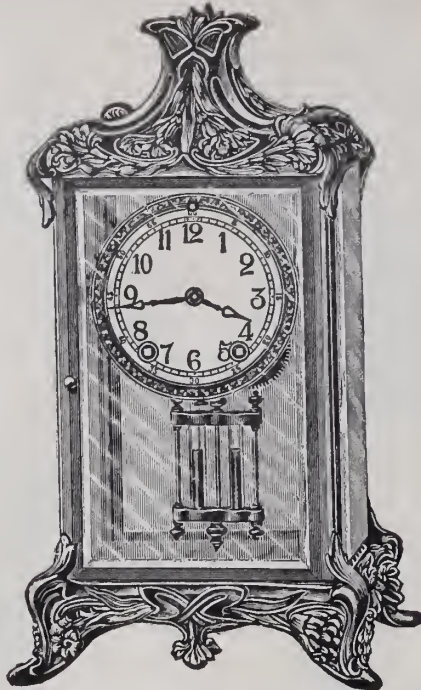

**EMPIRE No. 12.**

Metal Case.

Gold Plated  
and Lacquered.

8-day,  
half-hour strike.

Cathedral Bell.

Height,  
14 inches.

List, \$22.00.

If your jobber cannot supply you, write to us for a list  
of those who handle our clocks.

**SETH THOMAS CLOCK COMPANY,**

51 Maiden Lane, New York.

70 Wabash Avenue, Chicago.

**Hotel Schenley,**

Pittsburgh, Pa.



12 minutes' car ride from Fifth Ave.  
and Smithfield St., or East Liberty Sta-  
tion. Fireproof, surrounded by three  
acres of garden, away from the dirt,  
smoke and noise. Catering to refined  
patronage.

'Phone, 236 Schenley.

**Hotel Normandie**

**DETROIT, MICHIGAN**

American Plan, \$2.50 to \$4.00. European Plan,  
\$1.00 to \$3.00. First class cafe in connection.

GEORGE FULWELL, Proprietor

Headquarters For Jewelry Salesmen

*The* **ST. JAMES**

Corner Walnut and Thirteenth Streets  
PHILADELPHIA, PA.

**The Ideal Hotel of Philadelphia**

European Plan EUGENE G. MILLER, Mgr.

**JULES JÜRGENSEN**

**Watches and Chronometers**

PARIS—"THE GRAND PRIX"—1900

S O L E

RUDOLPH & SNEDEKER,  
65 Nassau St., New York

A G E N T S

WATCHES OF PRECISION.

**Mathey Bros., Mathez & Co.**

Manufacturers and Importers of

**Superior, Plain and Complicated Watches.**

Sole Agents for

**CHAS. H. MEYLAN.**

SMALL WATCHES A SPECIALTY.

WATCHES DEMAGNETIZED.



12 SIZE MOVEMENTS.

Brassus, Switzerland

21 MAIDEN LANE, NEW YORK.



12 SIZE SPLITS.

**Rockford Watches Speak for Themselves.**

**Eliassof Bros. & Co.**

IMPORTERS  
AND  
JOBBER OF

**DIAMONDS  
WATCHES  
JEWELRY**

9-11-13 MAIDEN LANE,  
NEW YORK.

100 STATE STREET,  
ALBANY, N.Y.



A LARGE ASSORTMENT OF DIAMOND  
MOUNTED JEWELRY CARRIED IN STOCK.

smooth-grinding tools of softer metal, such as brass, and then polishing-tools are used. The polishing-tools may be covered with felt which has been boiled in pitch. To enable the curvature produced to be independent of the curve of the grinding-surface of the tool, tools with hollowed or recessed undersides are used, so that their grinding-surface is greatest at the parts which tend to grind away quickest. The curvature produced depends on the relative surface velocities of the lenses and tools, and the relation between the two is adjusted according to the curvature required. When two lenses are operated on together, as shown in Fig. 3, their adjacent edges may be cut

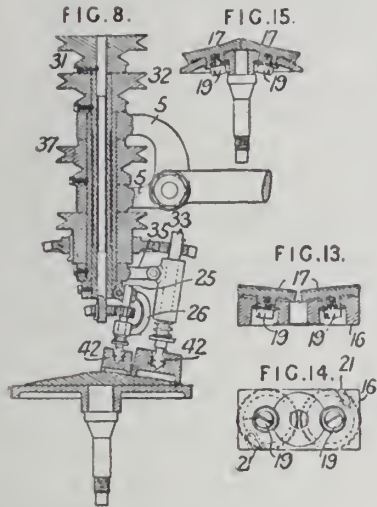

flat to bring them close together, and filling-pieces may be placed in the gaps between them, to form a complete circle of glass. Fig. 8 shows two tools arranged to produce the two curvatures simultaneously on a piece of glass which may afterwards be cut up and treated as desired. The tools have square holes engaged by square parts 42 on tool-spindles 25, 33 supported as shown and rotated and revolved at the desired speeds by pulleys 31, 32, 37, etc., through the gearing shown. The supporting-arms 26, 35 can be replaced by longer or shorter ones according to the size of the piece of glass operated on and the relative areas of the two curved surfaces. A single tool is used on the inner surface, while two or more tools may be used simultaneously on the outer surface. Two or more glass-holders 17 arranged at an angle to one another as shown in Figs. 3 and 13 may be secured to a block 16 with inclined seats by screws 19 as shown, and the block may be secured to the chuck 3\* by bolts, the head of which engage undercut curved slots 21, Fig. 14, in the block. Fig. 15 shows a modification in which the blocks 17 are formed with curved faces and are secured to a curved holder. Wedges or washers may be used to tilt the lens-holder when desired. In solid bifocal lenses with a ridge between the two surfaces, the ridge is obscured or left unpolished to prevent reflection, and its sharp edge is chamfered to prevent injury when coming in contact with a hard surface. The polishing of the ridge may be prevented by a strip of copper or the like.

**28,842. CLOCKS.** T. WEISSER, Allemaque, Heidelberg, Germany. Dec. 30.

*Cuckoo Mechanism.*—Relates to the production of cuckoo, quail, or trumpet calls by a hand-operated device independent of the clockwork. A chain *c* is attached to the arm *i* fixed to the

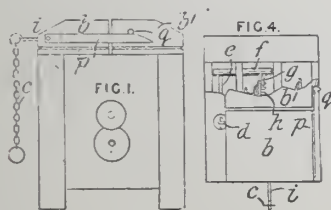

bellows *b*, which are connected by an arm *p* and pin *q* to the bellows *b*<sup>1</sup>. The bellows are thus operated one after the other to give the usual call. The bellows are also worked by the pin-wheel *h* of the striking-mechanism through the tappet *g*, arbor *f*, arm *e*, and connecting-rod *d*. On the chain

being pulled by hand, the tappet *g* rises from the pin-wheel *h* and does not interfere with the striking-mechanism.

**28,849. WORKMEN'S TIME RECORDERS.** W. M. LLEWELLIN, Bristol. Dec. 30.

In apparatus more particularly of the type described in Specification No. 20,432, A.D. 1902, a workman's signature or identifying-mark upon a time-sheet is automatically stamped with the time. The sheet is fixed to a clock-driven drum *C*, Fig. 1, which draws it from a spring-controlled spool *A*, and it is signed through the aperture *L*. The

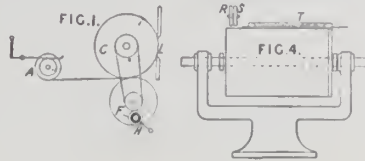

drum and a minute type-wheel are geared to move together, and by the employment of suitable inking apparatus the proper minute will be printed in the margin of each line. Carried round by this wheel is an hour-type-wheel *F* provided with a star-wheel for a spring detent upon the larger wheel, and also engaging a fixed transfer pawl *II*, the arrangement thus printing the hour at every change. In Fig. 4, the type wheels *R*, *S* are shown mounted slightly above the record drum, which is written upon through a slot *T* and then lifted by a lever and yoke to imprint the time, a spring-pawl and ratchet-wheel feeding on the drum between each movement. Preferably, each workman makes two or more consecutive entries; a third wheel may also be added for the date.

**28,850. WORKMEN'S, ETC., TIME-RECORDERS.** W. M. LLEWELLIN, Bristol. Dec. 30.

Various improvements in workmen's and other time-recorders are described. In order to obtain a sharp imprint on the diagram in the index-lever type of recorder, the lever *A*, Fig. 1, has hinged to it a casing *E* carrying a spring-controlled plunger *D*<sup>1</sup>. On depression of the lever into the number plate, the ring *D* causes a resistance to the movement until the plunger *D*<sup>1</sup> lifts, the stroke being then completed sharply. In the card and platen

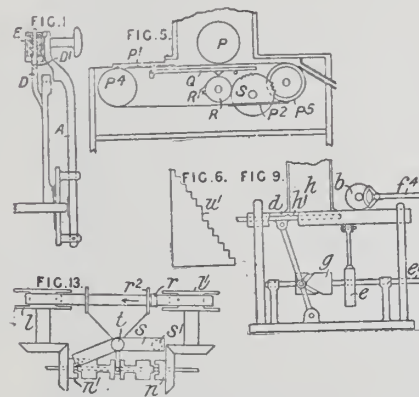

type of machine, the platen may be hinged and lifted to the type-wheels, on striking which electric contact is made and a bell rung, or the platen may be operated as shown in Fig. 5. Card-holders *P*<sup>1</sup>, *P*<sup>2</sup> are attached to an endless band over wheels *P*<sup>4</sup>, *P*<sup>5</sup>. The latter is driven by gearing from a wheel *S* which drives a pinion *R*, a projection *R*<sup>1</sup> on which lifts the platen *Q* to the type-wheels *P*. At one portion of the wheel *S*, a number of teeth are cut away so that the card is stationary as it is lifted to the type-wheels. The card-guide, operated by clockwork, for spacing the record on the card for successive days, has a double step *u*<sup>1</sup> so that a line shall not be missed for a Sunday or other regular holiday. In the form shown in Fig. 9, the workman first sets the three levers *f*-4 to his number, and then gives a handle attached to the shaft *e*-1 one revolution. The platen *d* is moved by the cam *g*, and a projection *hl* seizes the lowest card in the magazine *h* and carries it forward under the type-wheels *b*, to which it is lifted by the eccentric *e*. Means for controlling the feed of the inking ribbon for such machines are such that, when one spool becomes full, the direction of winding changes. In the form shown in Fig. 13, the spools *1*, *1*<sup>1</sup> are driven by bevel

gearing through clutches *n*, *n*<sup>1</sup>. Near the end of the ribbon is fixed a clip *r*, which comes up against a guide *r*-2 and depresses the end *s* of a tube pivoted at *t* and carrying a ball *s*-1. The ball then rolls down, and on coming into contact with the end of the tube puts the clutch out of gear. Another feed-motion, in which the ribbon, when the spool is full, presses on the roller and puts the clutch out of gear, is also described. Similar levers to that shown at *f*-4, Fig. 9, may be applied to the machines described in Specifications Nos. 2627 and 20,432, A.D. 1902, and No. 1448, A.D. 1904.

**29,006. FACE GAUGES.** J. H. HALES, Newport News, Virginia, U. S. Dec. 30.

An optician's frame gauge for ascertaining the measurements for spectacle frames is shown in Fig. 1. The measuring-square 6 and the sliding measure 4 are shown in Figs. 4 and 5; when not in use, they are stowed between the front and back

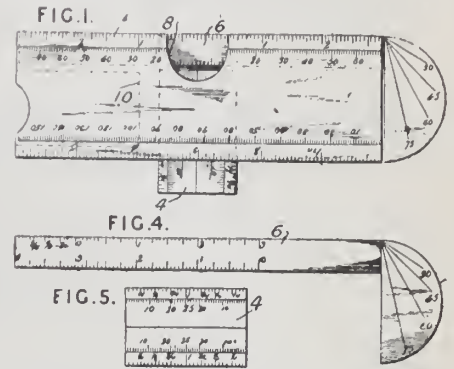

of the gauge, the square 6 along the top, and the measure 4 in the end compartment 10. The rounded head 7 of the square 6 is marked angularly to give when in use the angle of tilt of the lens with reference to the line of the nose. The recess 8 is such as to accommodate the highest bridge. The sliding measure 4 is adapted to slide at right-angles to the body of the gauge. The various scales are in inches or in millimeters, and the body of the gauge may be covered with information, advertisements, etc. The gauge is preferably made of celluloid.

Complete specifications accepted April 11, 1906. 1905.

**10,785. BOW FOR WATCH-PENDANTS.** GARNER.

**15,165. INKSTAND.** DARKE.

**16,112. INKSTAND.** DAVIDSON.

**19,694. STUD.** MASON.

**20,424. HAIR-CURLER.** STARTIN.

**24,424. HAT-PINS AND HAIR-PINS.** POTTS.

**25,263. PIN-TONGUE.** DOVER.

**26,227. COLLAR-BUTTON.** DANKWORT. 1906.

**4,890. BROOCH-PIN FASTENING.** TRIPP. Applications filed April 2 to April 7, 1906.

**7,841. BELT.** K. M. LERMIT, Birmingham.

**7,865. HAT-FASTENER.** ALFRED MARSHALL, Ruddington, Nottingham.

**7,848. PURSE.** W. S. HARNETT, Finsbury, London.

**7,984. BROOCH.** H. A. IVES and D. W. JEFFERY, Colchester, Essex.

**8,043. MATCH BOX.** W. T. IVES, London. Complete specification.

**8,086. SPECTACLES.** ROBERT LOGAN, Glasgow.

**8,090. UMBRELLA.** R. T. KREUTZFELDT, Burlington Chambers, Birmingham.

**8,201. NECKTIE-FASTENER.** JAMES MASON and ANTHONY CLEGG, 4 Cooper St., Berry, Lancaster.

**8,224. THIMBLE ATTACHMENT.** NEIL LEITCH, Wick, Caithness, N. B.

**8,250. FASTENING DEVICE.** ARTHUR GRAF, London.

**8,334. TEAPOTS, URNS, ETC.** R. F. KEELING and J. A. HOLLINGTON, Birmingham.

**8,428. WATCH BRACELET.** ARTHUR THORNEYWORK, London.

**8,436. BRACELET.** ANDREAS DAUB, Strand, London. Complete specification.

# WALTHAM WATCHES

---

We beg to announce the issuing of the following described 16 size movements:

## 16 SIZE, $\frac{3}{4}$ PLATE, S. W. MOVEMENTS

LEVER SETTING

OPEN FACE

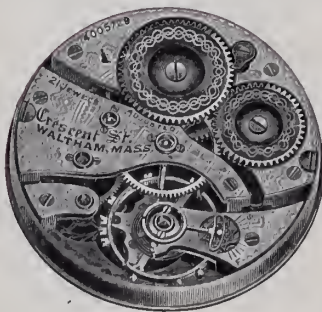

Crescent St., Nickel;

21 Fine Ruby Jewels; Raised Gold Settings; Jewel Pin Set without Shellac; Double Roller Escapement; Steel Escape Wheel; Exposed Sapphire Pallets; Compensating Balance, Adjusted to Temperature, Isochronism and Five Positions; Patent Breguet Hairspring, Hardened and Tempered in Form; Patent Micrometric Regulator; Tempered Steel Safety Barrel; Exposed Winding Wheels; Double Sunk Dial.

---

**AMERICAN WALTHAM WATCH CO.,**

**WALTHAM. MASS.**

# THE HOROLOGICAL REVIEW.



## How Father Knickerbocker Marks *the* Hours

Prominent Clocks That Give the Time to New Yorkers in Manhattan, Brooklyn and the Bronx.

(Continued from issue of May 2.)

### THE SHOPPING DISTRICT.



**T**AKE Herald Square as the next starting point. That liveliest section of our bustling city, owing to its swarm of feminine visitants by day, passes under the respectable title of "shopping district," but includes those

quarters where the great glare of the "white lights" casts its nightly effulgence, and the policeman's task gained the proverbial claim for luscious remuneration (of the side issue source) that earned the sobriquet of "Tenderloin." Well representative of all the much variegated classes of mankind dwelling within our city's walls are the three clock-crowned edifices facing this triangular open space.

The prosperous "fourth estate" is ably represented by the *Herald* building in its ornate Italian garb. But it is its clock which now chiefly calls for our attention. Since March 21, 1895, eight times in each 24 hours the large crowd gathers in front of the 35th St. portal to gaze on the activities of the two heroic bronze figures of workmen who, with their large hammers, sonorously beat out the hours at XII, I, IV and VI. To the rear of these lifelike figures towers a majestic statue of Minerva, goddess of all industrial arts.

That realistic "striking" scene of never-failing public interest is composed entirely of bronze, including the bell, and was imported by James Gordon Bennett from France. The figures of the workmen and Minerva are masterly creations of the brilliant French sculptor-genius Antonin Jean Carlés.

The hammer of the eastern figure weighs 20 pounds and the other 40 pounds. Credit is due to the E. Howard Clock Co. for the intricate, delicate mechanism that so accurately carries out its performance in all weathers. The spark of vitality that creates

the periodical animation of the group is electric. Perhaps a lay explanation of the true inwardness of the mechanism may prove of interest to some readers of THE CIRCULAR-WEEKLY.

The clock movement and the mechanism which works the two bronze figures are situated in a small room directly below the figures. From the clock dial a cluster gear



CLOCK, WIND DIAL AND BRONZE FIGURES ON THE HERALD BUILDING.

# The Balance of Business

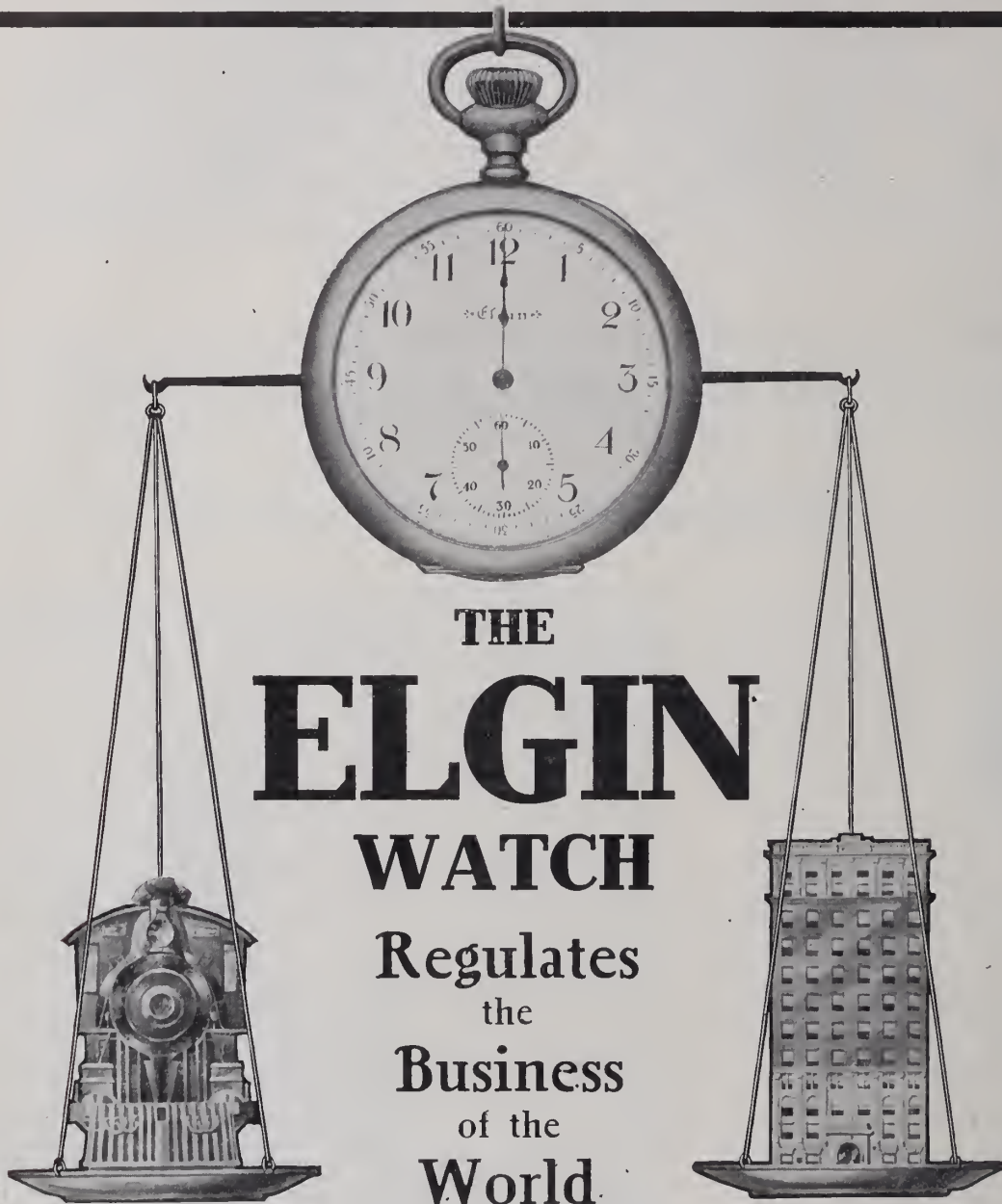

Indispensable to modern life, the Elgin Watch is ever in increasing demand—and the balance of business goes to the store that carries a full stock of Elgin Watches.

See Jobbers' list for prices or write the Company.

Every dealer is invited to send for the Elgin Art Booklet, "Timemakers and Timekeepers," illustrating the history and development of the watch.

## ELGIN NATIONAL WATCH COMPANY

Factories, Elgin, Illinois, U. S. A.  
General Offices, 131 Wabash Ave., Chicago.

New York Office, 11 John Street.  
San Francisco Office, 206 Kearny St.



carries a rod up six feet, then extends 12 feet east and finally in the building six feet to a regular tower clock. This time-piece is connected by electric wires with the machinery especially made for moving the bronze figures. An electric contact is driven by a wheel on the arbor of the es-

of the building, act on the movement.

Two large main wheels carry heavy cam wheels, whose large teeth lift and drop the striking levers. These striking levers connect by a hammer chain to overhead levers, through which the power is transmitted to foot levers, and thence through the foot levers to other overhead levers in the base of the statue of Minerva. These last levers connect directly with the striking figures. The first motion turns them slightly away from the bell, giving the workmen the appearance of getting ready to strike; the next motion brings them back to the bell, causing the hammers to strike a sharp blow.

But why this peculiar selection of hours struck? That question arises in most minds when they learn that at XII, I, IV and VI o'clock only do the hammers acclaim the time. Well, at noon the army of working men stay their labors for their frugal repast and brief respite. At one o'clock they re-

bringing the future, with its unknown needs closer hour by hour.

But the strong influence of the present, to exchange hard-earned dollars for body comforts and adornment appeals to the purse of tempted humanity through the



CLOCK OVER MAIN ENTRANCE OF MACY'S BUILDING.

capement wheel of the clock. This contact makes and breaks an electric circuit at exactly XII, I, IV and VI o'clock, both night and day.

When the contact is made, the electric current, passing through a powerful magnet in the mechanism for moving the fig-



CLOCK AT THE CONTINENTAL HOTEL.

turn to work; at four they lay down their tools after eight hours of toil, and at six the honest workman sits down with his family to enjoy his well-earned supper. From the accompanying illustration it will be noted that a wind dial acts as mate to the clock dial, affording weather information simultaneously with giving the passing public the time of day.

Facing this elegant home of journalism is the inviting clock-adorned façade of the Dime Savings Bank building, which seems to appeal to the toilers from their meagre pecuniary incomes to lay aside those frequent instalments of mites which on arrival of the proverbial "rainy day" will serve to pay passage to the next stage of profitable labor, or with constant yearly growth may aid to comfort those last passing years, when decrepitude denies the bodily powers that earn a daily wage. The savings bank clock's hands point the warning message to the workman that the present, with its possibilities, is rapidly fleeting,



THEO. A. KOHN & CO.'S STREET CLOCK.

clock face over the spacious entry of Macy's mammoth emporium on the third side of triangular Herald Square. And wealth flocks into those doors, alluring the undecided to join the merry throng, cast thrift to the winds and enjoy life's pleasures while health and wages last.

But, to the visitor who has enjoyed the



CLOCK TOWER UNION DIME SAVINGS BANK.

ures, trips a heavy steel lever from its hold in a programme wheel of the heavy striking movement on the machine. When the lever is released, it lets the power of about 30 weights, aggregating about a ton, which are suspended by a steel cable in another part



CLOCK ON THE BREWSTER BUILDING.

hospitalities of the metropolis, there will remain memories of hostelries in this section, such as the Gilsey House clock, 35 years at its corner, those of the Cadillac, Continental, Fifth Ave., whose time dials face the pedestrian to remind him of vacuities in his internal economy and invite to



{ Actual size  
of new folder }

There is Satisfaction in Seeing  
what is Being Purchased. The

## Jas. BOSS WATCH CASE

is truly a visible investment.  
Visible to you as a dealer.  
Visible to your customers.

**A NEW FOLDER IS READY—showing the remarkably strong construction and proportion of gold used in BOSS cases. Furnished to all dealers upon request. Dealer's card printed on them without cost. Write for quantity. Address**

DESK C, ADVERTISING DEPT.

## The Keystone Watch Case Co.

PHILADELPHIA

New York  
Chicago

Cincinnati  
San Francisco



The New Patterns of

## CROWN CASES

maintain the up-to-the-times policy of seasonable designs in the same quality of construction that has made the Crown Line such a satisfactory one for the dealer to sell.

---

Philadelphia Watch Case Company,  
RIVERSIDE, NEW JERSEY



# ZENITH

## MOVEMENTS

Give the

**RIGHT TIME  
EVERY TIME  
For a LIFE TIME**

**Grand Prize, Paris Exposition, 1900**

Made in O size, 12 size, 16 size, all grades  
Hunting or Open Face, Pendant Set

INTRODUCED FOR THE FIRST TIME IN AMERICA, THOUGH ONE OF  
THE BEST KNOWN WATCHES IN EUROPE FOR GENERATIONS

Manufactured by

**GEORGES FAVRE-JACOT & CO., Locle, Switzerland**

HIPP. DIDISHEIM & BRO., Sole Agents, { 49 MAIDEN LANE, NEW YORK.  
COLUMBUS BUILDING, CHICAGO.

# Always in the Lead

AMONG HIGH GRADE WATCHES.

First in Quality, Adjustment, Durability, Style.  
New Grades, New Sizes, New Improvements.

# Vacheron & Constantin,

GENEVA, SWITZERLAND.

FITS ALL SIZES  
OF  
AMERICAN CASES.



SPECIAL GRADES  
FOR  
RAILROAD MEN.

# EDMOND E. ROBERT,

SOLE AGENT,

3 MAIDEN LANE, NEW YORK.

## Mother of Pearl Clock.

SPECIALTY:

**PEARL WATCHES**  
Ladies' and Gentlemen's

Nurses'  
Watches,  
Repeaters and  
Chronographs.

Extra flat watches  
in Gold, Silver, Gold  
Filled and Gun  
Metal.

Enameled  
Watches  
of all kinds.

Write us  
immediately  
if interested  
in the new  
season's  
offerings.

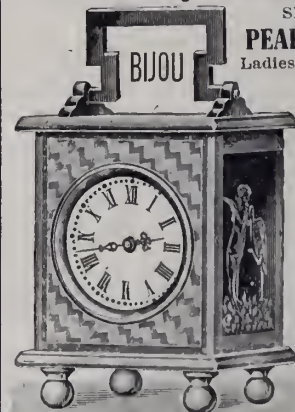

Exact Size—Cylinder and Lever Movement.

**KLIPPER BROS.,**

59 Maiden Lane, NEW YORK.

**Horological Department,  
BRADLEY POLYTECHNIC INSTITUTE,  
Formerly Parsons Horological Institute,  
PEORIA, ILLINOIS.**

**Largest and Best Watch School in America.**  
We teach Watch Work, Jewelry, Engraving, Clock Work,  
Optics. Tuition reasonable. Board and rooms near  
school at moderate rates. Send for Catalog of Information.

### LEARN WATCHMAKING AT HOME

by THE De SELMS CHART SYSTEM, copyrighted and patented. The  
most simple, practical and up to the minute method of learning.

Saves you time and money while learning and puts you in a position to  
more than double your income.  
50 million timepieces to be repaired. Accurate time is a necessity in the  
business world. When time is money the watchmaker gets his share of  
profit. Positions for graduates. Booklet free. Write to-day.

**The De SELMS WATCH SCHOOL,**

109 Perry Street, ATTICA, INDIANA.

breakfast, luncheon, dinner and supper.

Theo. A. Kohn & Co.'s sidewalk clock, nearly in front of the Waldorf's regal caravansary, attracts the attention of its wealthy patrons to gold, silver and gem adornment, but painted in antique bronze coloring to match the façade of their well-known, handsome store, there is a likeness

to the legal right to such clocks furnishing accurate time to the passing crowd, while compensating the owner by steering some of those pedestrians into his store.

Continuing downtown along Fifth Ave. brings one to sidewalk clocks in front of E. M. Gattle & Co.'s store, corner of 38th St., and Jacob Dreicer & Son's.

Along Broadway in this section are located the Bank of New Amsterdam's sidewalk clock, facing the Metropolitan Opera House, and Brewster's old landmark, facing old Longacre Square (later named Times Square). A little further uptown brings one in sight of the handsome bronze fugal and clock in the tower of Witmark & Son's "Busy Bee" headquarters on 37th St.

Within these same purlieus lies unbrageous Union Square, where the handsome mounted clock of the Tiffany building did, for so many years, useful public service. Its absence is badly felt by neigh-

proverbial sardine is fully lived up to on that block. And the handsome Howard 'skeleton dial of the clock set in the face of Stern Bros.' dry goods store is scanned every moment by many thousands of bargain purchasing femininity.

Talking of this block on 23d St. reminds



THE OLD TIFFANY CLOCK ON THE FIRM'S NEW BUILDING.

to so many of these numerous street clocks that no special interest would be attached to it, were it not that it "got into the courts" one fine day; that is to say, when it stood in front of the former store, 56 W. 23d St., suit was brought against the owners to remove the timepiece as an obstruction in-



MERMOD, JACCARD & KING JEWELRY CO.'S CLOCK.

bors. While in its old position that timepiece had an aspect imposing, but by its removal to the gorgeous Fifth Ave. palace it suffers from the splendor of its surroundings almost to obliteration. However, the visitor on Fifth Ave. who is blinded to the Tiffany dial, will assuredly sight that of the Mermod, Jaccard & King Jewelry Co., located in the site rendered historical as the former abode of the world renowned infidel and lecturer, "Bob" Ingersol. The Jaccard clock is of bronze and of characteristic style, taking Western Union time. But a few doors from here is the steeple clock of the Brick Presbyterian Church, corner of 37th St.

It would be hard to find a denser throng of shoppers on any street of the shopping district during the busy hours than will be found on 23d St., between Fifth and Sixth Aves. Hard, because the condition of the



CLOCK TOWER ON JEFFERSON MARKET.

the writer of the same block on 14th St., or, to be more exact, it does not remind him so much as that the moment he turns his back on either he cannot tell one from the other in his memory—the same terrible press of womankind, the same bewildering array of eternal feminine adornment and requirements, each store a repetition of its neighbor, and, to make the similarity more confusing, there is a clock on just the same side of the street and about the same distance from Sixth Ave., but this time it is a sidewalk clock, and the word "Rothenburg's" appears instead of "Stern Bros." And this saves its character, in the writer's mind, after he sees the clock. Of course, to the ladies, dry goods and the stores that hold them are easily recognizable, they are as an "open book"—a school primer.

Then, again, Sixth Ave. is well clock represented. J. A. Linherr's sidewalk clock, opposite the big "14th St. Store," the Lefkowitz clock, of similar description, on the corner of 17th St. And while on Sixth Ave. the majestic clock tower of the Jefferson Market Police Court building, with its magnificent architectural lines, must not remain unmentioned. This Seth Thomas clock, with its dial of over eight feet in diameter, 85 feet above the sidewalk, has, since its installation in 1876, watched the gathering in within the walls of its building of many thousands of the Tenderloin's criminal population. Could its hands write they would tell volumes of sad stories of the bitter fruit of a gay youth and a list of past and present dwellers in the prisons beneath its tower would resemble in size a large city directory. Its timely light at night is seen from quite a distance.

This tower clock is an exemplification of the many ills and perils the lofty public



STREET CLOCK AT FIFTH AVE. AND BROADWAY.

jurious to the neighbor's business. And in June, 1891, the case came up for "hearing." The judge listened patiently to all the evils the complainant could bring against that timepiece, but decided that it could stay, as it was of public use and neither took away light nor otherwise interfered with the complainant's affairs. Thus the Kohn & Co. sidewalk clock established a precedent as

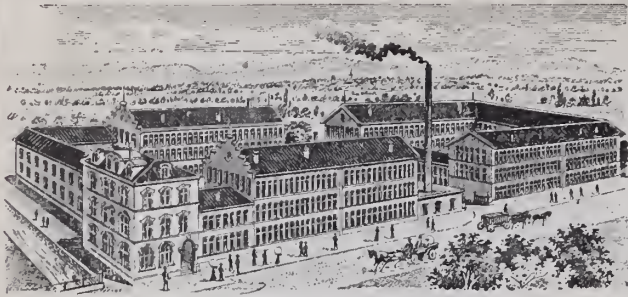

This illustration shows our main factory exactly as it exists, where 3,000 complete watches are made daily.

# LANGENDORF WATCH CO.

CHAUX-DE-FONDS, SWITZERLAND.

It will be of great interest to every jeweler to learn that we are devoting our full attention to this market. The existing conditions in the watch trade have convinced us that there is a long felt want for moderate priced, but accurate Swiss Watches.

We wish to call your attention to our LONVILLE MOVEMENT. It has a lever escapement and is being made in Os, 12s and 16s, fitting perfectly all American cases. This movement is salable and profitable. Our Watches and Movements will be introduced in this market bearing the following names:

- |          |          |
|----------|----------|
| SOLDALE  | HIGHMERE |
| BONDALE  | LONVILLE |
| CLAREFAX | NAMTOC   |
| PEARLHAM | LADY MAY |

SOLE AGENTS FOR UNITED STATES,

**BYRON L. STRASBURGER & CO.,**  
17 Maiden Lane, New York, N. Y.

# The Carmen Watch Bracelet

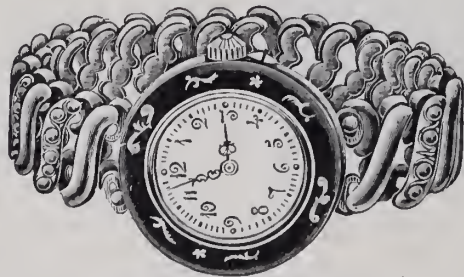

**GOLD FILLED**

WITH ENAMEL BEZEL ALL  
SHADES OR PLAIN GOLD FILLED

**BOTH BRACELET AND WATCH  
ABSOLUTELY GUARANTEED**

During the present great vogue of Bracelets, Jewelers  
will find these a profitable novelty to handle.

**HIPP. DIDISHEIM & BRO.**

Chicago Office, Columbus Bldg. 49 Maiden Lane, New York.

IF IT'S A

# ROY

TRADE MARK

IT'S STANDARD

ROY



**Roy  
Watch Case  
Company**

are the only manufacturers of solid gold watch cases from assayed gold. In the Roy factory every melting of gold bars from the United States Mint is carefully assayed to show the exact quality of the product, so that the Roy trade-mark guarantees absolutely that the fineness of the gold is exactly as stamped in every Roy solid gold watch case.

**NEW SEASON'S STYLES**  
for sale by all jobbers who appreciate reliable quality and superior workmanship.

**ROY WATCH CASE  
COMPANY,**



21-23 Maiden Lane,  
NEW YORK.

SAN FRANCISCO.  
LONDON, ENG.

timepiece is heir to. When first erected the hours were struck on a great bell, whose tones were audible throughout a wide area. But the vibrations were found to affect the tower. And, in fear of the bell's pulsations shattering the very building itself, the hours have been told off by the mute hands alone, to avoid jeopardizing alike the lives of the judge and his officials in the court below and those of the other dwellers perforce.

Another well known and largely consulted timepiece is the elaborately gilded Dorton sidewalk clock on 23d St., near the corner of Madison Sq.

Meandering along Broadway, one strikes a little bevy of sidewalk clocks, such as



PROCTOR'S STREET CLOCK.

that in front of Proctor's, near 28th St., calling to continuous performances in that home of vaudeville; in front of Lindo Bros.' jewelry store, and still another before Browning, King & Co.'s clothing emporium.

Two very useful sidewalk clocks are located at both entrances of the Lincoln Trust Co.'s building, 25th and 26th Sts.

(To be continued.)

### A Handsome "Grandfather's" Clock.

ALL German town halls have, after an old custom, wine cellars of their own, of which the most celebrated is that of the free town of Bremen. Many of these town halls have been rebuilt recently and enlarged according to the greatly increased populations of the greater German towns.

One of the finest buildings of this kind is the new town hall of Leipzig, for whose wine rooms a very peculiar grandfather's clock was presented by one of the wealthy citizens. The clock is made in oak by the well-known firm of Etzold & Popitz. The decorations are chiseled in bronze, and show the insignia of Leipzig as a university and a center of commerce.

Several mottos are engraved round the dial and upon the case, one of which says that "to the happy no clock chimes the hour." and another, that the Aldermen should not forget to moisten the clay of their discussions by a good glass of wine now and then, for "dry lamps would not burn."

### Why a Watchmaker Put an Inscription on Lincoln's Watch.

AMONG the jurors serving in the Supreme Court recently was one 84 years young. He said so himself. He looks and acts just as young as he says he feels. This man is Jonathan Dillon, of 46 W. 117th St., New York. He has been engaged in the watchmaking business for the best part of 74 years.

Mr. Dillon, who has a remarkable memory and an interesting fund of reminiscence, tells a new story which has to do with Abraham Lincoln.

"When the Civil War broke out," said Mr. Dillon, "I was in the employ of M. W. Galt & Co., on Pennsylvania Ave., near 7th St., in Washington. I was the only Union sympathizer working in the shop.

"I was working upstairs when Mr. Galt came up. He was very much excited, and gasped:

"Dillon, war has begun; the first shot has been fired.'

"At that moment I had in my hand Abraham Lincoln's watch, which I had been repairing. It was a gold, hunting case, English lever watch. The late John Hay told me afterward that it was the first watch Mr. Lincoln ever owned.

"I was in the act of screwing on the dial when Mr. Galt announced the news. I unscrewed the dial, and with a sharp instrument wrote on the metal beneath:

"The first gun is fired. Slavery is dead. Thank God we have a President who at least will try.'

"Then I signed my name and the date. So far as I know, no one but myself ever saw the inscription, and I do not know into whose hands Mr. Lincoln's watch fell at his death."

Mr. Dillon was born in the city of Waterford, Ireland, where his ancestors had been watchmakers for generations.

"I have newspapers," he said, "containing my father's and grandfather's advertisements back 150 years. I was never out of work for 24 hours at a time until I retired."

"How long ago was that?" the old watchmaker was asked.

"Well, I wouldn't like to admit that I have quit yet," was the reply. "My eyes are not as good as they were once, but they are still as good as those of any one I know. When I was younger I frequently amazed friends by standing on Jersey City Heights and reading signs in Manhattan. My friends often accused me of locating and learning them before I crossed the river, but that was not the case. I could actually read them at that distance."

The law does not oblige a citizen to serve as a juror after he is 70 years old. Mr. Dillon rather enjoys the work.—*N. Y. Times.*

William G. Langdon, who was probably the oldest clockmaker in active business in the United States, died recently in Boston, Mass., at the age of 95. He had been a clock maker 75 years.

The Neuchatel watch factories are busy over a large order from Japan, which is going to present to its soldiers and sailors watches of special pattern as souvenirs of the war.

### A Clock Made of Bone.

AN interesting curio in the possession of Joseph Gibbs, 1306 Franklin Ave., St. Louis, Mo., is a clock made almost entirely of bone, the only exception being the running works. Mr. Gibbs, who purchased the unique clock, about a month ago, from a private family, who did not know its history, thinks that the clock is of English make. It is wound up by means of a main-spring and a chain.

The clock, which is about six inches high,

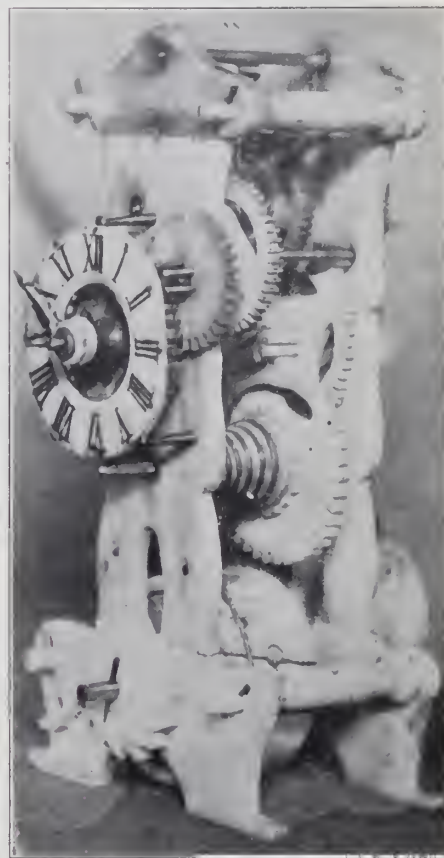

UNIQUE CLOCK MADE OF BONE.

shows evidence of age. It contains 10 wheels, all made of bone. The carving was all done by hand. The clock keeps perfect time.

### Horological Notes.

A CHINESE firm at Chefoo, with an American member, handling a cheap American watch, desires to buy watches of higher price and better quality. This firm handles chiefly American goods, and is extending its business by opening branches.

Retiring Customs Collector John T. Rich, Detroit, Mich., was recently presented with a clock by the employees of the customs service in his office. The clock is of Italian marble, with lacquered gold ornaments at the top. Two lacquered gold candelabras stand beside it, and shed soft rays of light over the marble face. On the base of the clock is affixed a gold plate with the following inscription: "In commemoration presented to the Hon. John T. Rich by the employees of the United States Customs office, Feb. 28, 1906."

For *BEAUTY* of *DESIGN*, *PERFECTION* of *FINISH* and *RELIABILITY* Combined with *Moderate Price*

# TRENTON WATCHES ARE UNEQUALLED



No. 140. Bridge Model, 16 Size, 15 Jewel, Hunting and Open-Face, Pendant Setting.

A sample line is convincing. They are pendant setting in all sizes, fitting regular pendant setting cases, decorated dials and Louis XV hands.

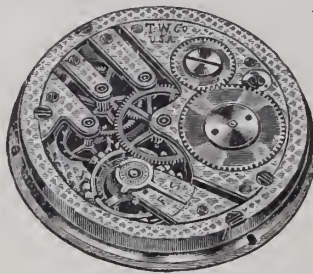

No. 320. Bridge Model, 12 Size, 7 Jewel, Hunting and Open-Face, Pendant Setting.

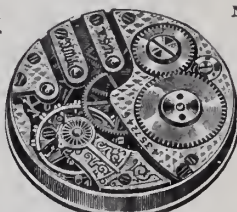

No. 100. Bridge Model, 0 Size, 7 Jewel, Hunting and Open-Face, Pendant Setting.

A NEAT SIGN  
OR ADVERTISING  
BOOKLET FOR  
THE ASKING

JOBBER SELL  
TRENTONS.  
PRICE LIST ON  
APPLICATION.

Manufactured and Guaranteed by  
**Trenton Watch Co., - Trenton, New Jersey.**

## The New Continental Watch Co.'s Movements.



0, 12 and 16 Size. 7 to 21 Jewels.  
All Bridge Model and Pendant Set.

Fitting all American cases without any change, interchangeable pendant set, have steel scape wheels, exposed pallets, double roller, Arabic or Roman dials, with and without marginal figures. CONTINENTAL WATCH CO. on bridges, C. W. CO. on dials except otherwise ordered. Special name or nameless movements require four months' time for delivery. Packed in glass show box inside paper box. No expense has been spared to make these movements the best on the market for the money. Every movement absolutely guaranteed. A full line of finished material constantly on hand.

For Sale by all Jobbers.

**JULES RACINE & CO.,** Exclusive Importers,  
103 State St., Chicago. 37 MAIDEN LANE, NEW YORK.

## 46 out of 99 PRIZES

were awarded to

# PATEK, PHILIPPE & CO.

In the Timing Contest of the Astronomical Observatory in Geneva, for the year 1905, comprising: The only First Unique Prize for Best Average Running; 2 First Prizes out of 3; 5 Second Prizes out of 10; 8 Third Prizes out of 18; 9 Fourth Prizes out of 24; 10 Honorable Mentions out of 23; 11 Simple Mentions out of 21. 11 Manufacturers participated.

68 NASSAU ST., NEW YORK.

GENEVA, SWITZERLAND.

## "Practical Course in Adjusting." Price \$2.50.

All Jobbers or Jewelers' Circular Publishing Co.

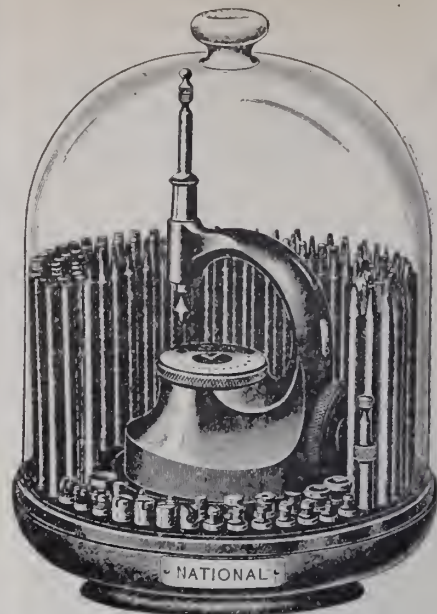

## Our Special 60 Days' Offer

The above Staking Tool with 100 Punches and 24 Stumps for \$16.00, less 6% Cash with order. Mention this paper.

Buy the **Columbian Brand** American Made Balance Staffs and Balance Jewels, Etc.



Balance staffs, Balance jewels, Cap jewels, Plate jewels, Roller jewels, and Mainsprings. They are the best made and we guarantee all our brand to give entire satisfaction or we shall replace them with new material.

## THE COLUMBIAN JEWELRY MFG. CO.,

Importers and Jobbers of  
Watchmakers', Jewelers' and Opticians' Supplies.  
ROOMS Nos. 427 to 430 CENTRAL BLOCK,  
PUEBLO, COLO.

John A. Blair, Manager.

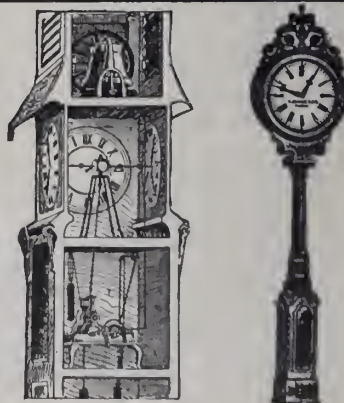

MAKERS OF

## Tower and Street Clocks

For particulars write us, mentioning The Jewelers' Circular-Weekly

**E. HOWARD CLOCK CO.,**  
EST. 1842. BOSTON, MASS., U. S. A.

**JACOB BASCHKOPF,**  
**DIAMOND SETTER,**  
LETTER AND MONOGRAM  
**ENGRAVER,**  
9-13 MAIDEN LANE,  
NEW YORK.

Room 701  
Jewelers' Bldg.



## Buy Watches in Metropolitan Markets

**N**EW YORK AND CHICAGO are admittedly the greatest metropolitan markets of this country. They afford the widest selections, the best transportation facilities, most thorough organizations and most favorable conditions generally. Buy your watches in these markets.

These offices in New York and Chicago are watch centers for this continent. Communicate with whichever one is nearest and most convenient. Efficient service assured.

### J. W. FORSINGER,

LEADING AMERICAN WATCHES AND MOVEMENTS

CHICAGO  
103 STATE ST.

NEW YORK  
2 MAIDEN LANE



## Sessions Clocks

Superior finish. Reasonable prices.

Have you seen our

**New and Exclusive Designs**  
in Mantel and Hanging Clocks?

Write for Catalog and supplement.

### The Sessions Clock Co.

Main Office and Factories,  
Forestville, Connecticut, U. S. A.

New York Salesrooms,  
37 Maiden Lane.



### WHOLESALE

# DUEBER-HAMPDEN COMPLETE WATCHES

The conceded friend makers for the retail dealer. We are certain that we can help you make customers if you will write us for prices on Chains, Rings and all kinds of High-Grade Jewelry.



## WM. C. PENFOLD CO.

WHOLESALE JEWELERS

AND AGENTS FOR DUEBER-HAMPDEN WATCHES

818-820 Chestnut St., Philadelphia, Pa.

## False Value In Karat Mark Only

**YOU ARE** acquainted with the general qualities of gold filled goods. You know that the 12 karat mark alone does not signify value. Of course the gold used is 12 karat, but a very natural question is "how much is used?"  $\frac{1}{30}$  -  $\frac{1}{40}$  or even thinner shells of gold make a fine appearance on first inspection.

**YOU KNOW,** however, that these extremely thin shells will not wear and give the satisfaction for which they are often guaranteed. In buying goods for your own use you are pretty certain to look for the quantity figure as well as the karat mark. Your customers, by continued trade, will repay the same consideration.

**THE S-Q** lines of optical goods always bear the quantity figure. They are thoroughly honest goods, backed up and guaranteed in every particular by a firm which has a reputation for making good.

**YOUR OPTICAL DEPARTMENT** might get in touch with us. We are always pleased to furnish information; we also feel sure that it would be mutually advantageous.

**STEVENS & COMPANY**

PROVIDENCE

RHODE ISLAND



### It's the Little Things that count.

The dainty little things that appeal at once to the casual observer. If it's useful, as well as ornamental, so much the better. Here is a LITTLE THING, so very useful and so pretty in design and finish, that you have but to show one to make a sale, and it yields a BIG PROFIT. It is called

## The Automatic Eye-Glass Holder

Can be used as well for a Pencil Holder. It is made in Enamel, Gold, Silver and Rolled Plate, in a variety of artistic designs. We fully guarantee every Holder. We mean it, and will replace any Holder that fails to satisfy. Samples sent upon request. Send for catalogue.

Est. 1832. **Ketcham & McDougall, Manufacturers,**  
37-39 MAIDEN LANE, NEW YORK.  
ALSO MAKERS OF THE LEADING LINE OF TRIMMLES.



**A Press and They're On!  
A Press and They're Off!**

The most practical Eye-Glass holder in existence—the double pin attachment keeps it from turning sideways. No points or rough edges to tear the lining of the coat. Prevents loss or damage.

**Leshner, Whitman & Co.,**

Dept. F, 670 BROADWAY, NEW YORK

FOREIGN HEADQUARTERS:  
38 Shoe Lane, London, England.  
40 Rue de l'Echiquier, Paris.  
34 Yonge St., Toronto, Ont.

## BLANCARD & CO.,

96 MAIDEN LANE,  
NEW YORK.

WELL MADE GOLD FINDINGS.

# OPTICAL DEPARTMENT

## External Muscles of the Eye and Ocular Paralysis.

(By DUNCAN MATHESON MACKAY, M.D., in the *Optician and Photographic Trades Review*.)

THE action of the individual orbital muscles and the effect of paralysis of one or more of them are admittedly not easy to keep in mind, especially by those who do not have to diagnose cases of strabismus every day. Even oculists find it convenient to employ a diagram, either real or mental, by which they may recognize from the character of the diplopia the particular muscle or muscles which are affected. So far as I am acquainted with the diagrams appearing in the text-books usually available to students and practitioners,

cornea to the left (that is, "wheel-motion" to the left). ("In speaking of the inclination of the vertical meridian of the cornea it is the upper extremity of this meridian which is meant."—Swanzy.) Similarly, isolated contraction of the right inferior rectus would: (a) move the summit of the cornea downward and inward, and (b) incline the vertical meridian of the cornea to the right. The arrows on the horizontal line indicate the direction in which the summit of the cornea moves with isolated contraction of the external or internal rectus.

Further, the starting-point of each inclined arrow on this horizontal line indicates the position in which the cornea must be in order that isolated contraction

adducted the elevating and depressing action of the elevators and depressors is least and when the eye is abducted the "wheel-motion" action of these muscles is least.

As a matter of fact, however, no regard needs to be paid to the "wheel-motion" in the diagnosis, by means of the diplopia, of paralysis, except in the case of examination of the obliquus superior, the action of which muscle is best tested when the eye is adducted.

A glance at the diagram therefore at once reveals, in the case of paralysis of one rectus (superior or inferior), that the defect of movement of the eye is most distinctly seen—or, in other words, that the difference in height between the two images (false and true) is the greatest—if the eye under examination be elevated or depressed while in the position of abduction; that is, for example, in the case of the right eye when it is turned to the right and upward, or to the right and downward.

In the case of paralysis of one oblique the defect of movement is most distinctly seen—or, in other words, the difference in height between the two images is the greatest—if the eye under examination be elevated or depressed while in the position of adduction—that is, for example, in the case of the right eye when it is turned to the left and upward or to the left and downward.

This may be translated into practice thus: if in any case of paralysis of an elevator or depressor the defect of movement of the eye (or the difference in height between the two images) is greater in the abducted position of the eye than in the adducted position, one knows it is a rectus which is paralyzed. In the opposite condition, where the defect of movement (or the difference in height between the two images) is greater in the adducted position of the eye than in the abducted, one knows that it is an obliquus which is paralyzed.

A single example may still further elucidate the diagnosing of the paralysis from the examination of the double images by the use of this diagram. If the flame of the candle placed in the middle line reveals double images separated by distance in height, and if this distance in height increases the more the candle is lifted up, one knows it is an elevator that is paralyzed—and an elevator of that eye, the image of which stands the higher (the image belonging to each eye is recognized, of course, by the aid of a colored disc held before one of the eyes).

Suppose, now, that this is the right eye. If, then, the elevated candle, always at the same height, be moved to the right and

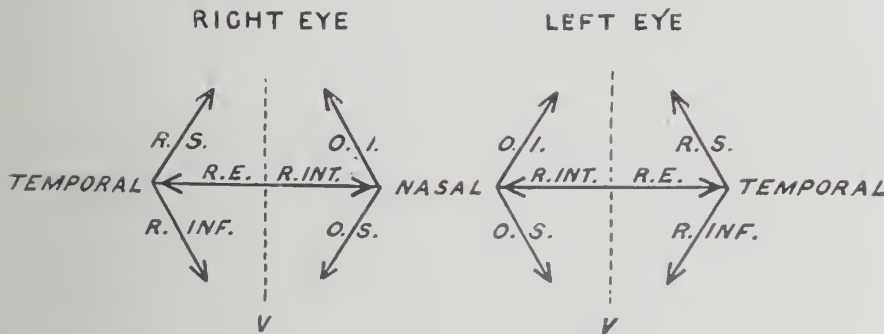

DIAGRAM SHOWING THE POSITION OF THE EYE IN WHICH THE GREATEST "WHEEL MOTION" ACTION IS EXERTED.

there is not one which is, in my opinion, so concise and so easily grasped as that of Prof. Elschmig, of Vienna.

I have therefore ventured to epitomize the article in which he introduced it to his German-speaking confrères and which is published in the *Wiener klinische Wochenschrift* of Aug. 28, 1902. The same subject is dealt with by Prof. Elschmig in the *Encyklopadie der Augenheilkunde*, published by O. Schwarz. The diagram is a modification of one by Prof. Schnabel, which has been much in vogue in Austria up to now.

In the diagram each of the arrows representing the action of the individual elevators and depressors (rectus superior, obliquus inferior, obliquus superior, rectus inferior) indicates (a) the direction in which the summit of the cornea would be moved by isolated contraction of the muscle concerned, and (b) by the inclination of the arrows toward the vertical, the position imparted to the vertical meridian of the cornea, by the same contraction.

For example, isolated contraction of the right superior rectus would: (a) move the summit of the cornea upward and inward, and (b) incline the vertical meridian of the

of an elevator or depressor may have the greatest elevating or depressing effect. That is to say, the rectus superior and the rectus inferior (for example) exert the greatest effect as to elevation and depression of the cornea when the eye is in the abducted position; and the obliquus superior and the obliquus inferior exert their greatest effect as to elevation and depression when the eye is in the adducted position.

Also, since the "wheel-motion" action of the elevators and depressors in each case is in the inverse ratio to the elevating or depressing action—the greater the elevating or depressing action the slighter the "wheel-motion" action and *vice versa*—there is evident from the diagram the position of the eye in which each elevator and depressor is able to exert the greatest "wheel-motion" action; that is, the rectus superior and rectus inferior exert the greatest "wheel-motion" action when the eye is in the adducted position and the obliquus superior and obliquus inferior exert their greatest "wheel-motion" action when the eye is in the abducted position.

The opposite of these two statements is true also—namely, that when the eye is

## Optical Department.

left, and if the distance in height between the two images increases as the candle is moved to the right (so that the eye tends to the abducted position) and diminishes as the candle is moved to the left (so that the eye tends to the adducted position), then we know that it is that elevator, the elevating action of which is the strongest in the abducted position, which is paralyzed—that is, in this case the rectus superior of the right eye.

It is important in practice, when the elevators and depressors are being examined, to allow the patient to pay attention only to the distance in height between the images; the lateral interval, whether the diplopia be homonymous or crossed, is not only irrelevant but often perplexing and deceptive.

Further details of the diagnosis of the paralysis of the muscles of the eye by the use of this diagram are to be found in the article in the *Encyklopadie*, already referred to.

With reference to the foregoing article, the following letter appears in the *Lancet*:

Sirs—May I draw Dr. D. M. Mackay's attention to a paper which appeared in the *Clinical Journal* of March 27, 1895, entitled "The Position and Rotation of the False Image in Paralytic Diplopia Represented Diagrammatically"? The diagram which I there published shows the following points: (1) Direction of action of the muscles of the eyeball; (2) primary deviation of the eye in paralytic squint; (3) position of the false image in diplopia; (4) quality of the diplopia; and (5) rotation or torsion of the false image both for vertical and horizontal images. I venture to think that this diagram is as "concise and easily grasped" as the one Dr. Mackay publishes.—I am, Sirs, yours faithfully, R. Bruce Ferguson (M.D.).

## Astigmatism Statistics.

OUT of about 3,000 cases of astigmatism, 32 per cent. were affected with simple hypermetropic astigmatism; 26 per cent. with compound hypermetropic astigmatism; 25 per cent. with simple myopic astigmatism; 11 per cent. with compound myopic astigmatism, and 6 per cent. with mixed astigmatism. The meridian of greatest refraction was horizontal in 1,081 cases, vertical in 349, and oblique in 164.

It is claimed by Mr. Van de Borg, who made the report, that even in cases where the astigmatic error was of only 1.00 diopter the visual acuity was seldom quite normal after correction, with a very rapid decrease in visual acuity with increase of error. As a rule, the improvement of vision was greatest when the meridian of greatest refraction was horizontal.

It appears strange that normal visual acuity could not be obtained in cases wherein the error amounts to only 1.00 diopter, and it seems safe to say that had a careful test been made and properly ground and adjusted lenses been supplied, the visual acuity, in these cases, would have been brought up to normal without difficulty.

## Anatomy of the Nervous System.

(Lecture recently delivered before the Rochester Optical Society by DR. RALPH H. WILLIAMS.)

KNOWLEDGE of the human body has progressed by gradual stages to the point which it has attained to-day. The first knowledge was practically confined to the bones. Later the gross anatomy became well understood, and in the time of Aesculapeus, the Father of Medicine, no conception was had of the structure and function of either the system of arteries and veins or of the ramifications of the nervous systems. If they observed these tissues they made little study of them and knew nothing of their functions.

Later came Harvey's discovery of the circulation of the blood and its recognition was followed by a wave of medical theory which sought to put the fluid of life into the blood stream which would give everlasting life. Before this time the practice of medicine was based largely upon superstition, and consisted in the administration of the vilest substances that could be concocted by the ingenious mind of the practitioners. With the advent of the knowledge of the circulation of the blood came the first real progress in the science of the healing art. While much of the old was still retained, there was much real investigation instituted, the value of which remains to-day. A more thorough study of the human body was instituted, with the result that vague ideas of the nervous system were secured, though for many years with little result.

To-day there is no portion of the human body, unless it be the lymphatic system, that is so little really understood as is the nervous system. There is no portion of the body upon which there is a greater range of theories propounded, all of which have a goodly following of eminent men, than there is of the nervous system. Its anatomy, gross and microscopic, is indeed as well known as one could ask, but it is only in recent years that its functions have been intelligently studied.

Too much has been taken for granted and conclusions have been drawn without the warrant of experiment. The German investigators have probably done more to give to the world accurate scientific data regarding the functions of the various portions of the nervous system than any other nationality. Foremost among these men is Landouisi, who has probably paved the way to a more complete knowledge of this inexhaustible field than any other man.

An absolute and complete knowledge of this wonderful mechanism we will never have. We must always stop short of the solution of the principal of life, and that, after all, is the real secret of the nervous system. Much we can know, however, and to thoroughly understand all that is already known to have stood the test of experiment, is no small task and infinitely beyond the possibilities of three necessarily short lectures. If I shall have been able to give you even a limited insight of practical value into the structure and function of the controlling mechanism of our human frame I shall feel that the time has been well spent.

In dealing with the nervous system, I have determined to take it up in three sections. First, the anatomy, gross and microscopic; second, the physiology; third, the

sympathetic system and the reflexes. This will, I believe, divide the subject into its most important divisions, giving each its due time.

The first section, involving the anatomy, is, to all appearances, the larger of the three, and in bulk it is large and correspondingly difficult, but I believe that it is infinitely more important that you get a few good impressions of the function of the nervous system, the sympathetic and its reflexes than to spend much good time in going into the minutia of the anatomy and histological structure of nerve tissue.

The nervous system is primarily divided into two great systems—the cerebro spinal, or the nervous system of animal life, and the sympathetic, or the nervous system of organic or unconscious life. The cerebro spinal, with which we will deal to-night, consists of the brain, spinal cord, and its nerve terminals, and ganglia. Both the brain and cord are constructed of what is termed gray and white matter. The white matter composes the lines of communications, while the gray matter constitutes that portion of the nervous system which receives, co-ordinates and initiates impulses.

The white matter, which is in reality nerve fibers, consists microscopically of a central axis-cylinder or transmitting substance, enclosed by the "White substance of Schwann," and this in turn is covered by a fibrous nerve sheath and a bundle of nerves are bound together by another fibrous sheath called the neurilemma. The whole structure is practically identical with the construction of the common telephone cable. The axis-cylinder represents the copper wire conductor, the white substance of Schwann corresponding with the rubber insulation, and the nerve sheath with the paper or cloth insulation outside of that, while the neurilemma is symbolized, though roughly, by the leaden coating of the cable.

The delicacy of structure and some conception of size can be had from the following facts. The ordinary telephone cable holds, I understand, about 500 wires at the outside and is something over two inches in diameter. On the other hand, the optic nerve, the size of which you are all familiar with, averaging, I believe about one-eighth to three-sixteenths of an inch, contains, it is estimated, about 500,000 nerve fibers, each one of which is capable of breaking up at its termination into an arborization of fibrils.

Nerve fibers originate in nerve cells either in the spinal cord or brain and terminate either in plexuses or end plates, according to their functions. The central termination of nerve fibers is as yet but little understood. The peripheral terminations have been carefully studied under the microscope, and it is possible to state with considerable assurance of accuracy that motor nerves end in the muscular fibers in end plates, while the sensory nerves terminate in the more expansive nerve plexuses which receive impressions. It will be impossible for me to give you more than a superficial idea of the structure of the brain, but I will endeavor to touch upon the plainer points which have the greatest practical value.

The brain is divided into four great divisions, as follows: The cerebrum, cerebellum, pons varolii and medulla oblongata.

The cerebrum, which is the seat of rea-

## Optical Department.

son, the special senses, and the final recording center for the entire body, occupies all of that portion of the skull lying above a line drawn around the head from the eyebrows in front to the occipital protuberance behind. Its great size in man in proportion to his weight, and its complexity distinguish the brain of man from that of the lower animals.

The structure of the brain differs from that of the cord by the fact that in the structure of the brain the gray matter is located on its outer surface, while the white matter, or nerve fibers, are situated internally. In the cord this arrangement is reversed.

The cerebrum is divided into two lateral halves or hemispheres, which are connected together by a great white commissure called the corpus callosum (callous body) from the fact that it is hard and dense. This commissure connects the various centers on opposite sides of the brain.

Each hemisphere is divided by fissures into five lobes, as follows: The frontal lobe, which is the largest of the five, extends from the anterior border of each hemisphere extending back to the vertex to a point about even with the crown of the head. From this point draw a line to about an inch and one-half above the upper attachment of the ear and thence to the outer angle of the eye.

The parietal lobe extends from the frontal lobe back to about the parieto-occipital suture, and down to a line drawn from this suture to the point about one and one-half inches above the upper attachment of the ear.

The temporo-sphenoidal lobe lies below and outside the frontal and parietal lobes and extends from the angle of the orbit in front to about one and one-half inches back of the ear.

The occipital lobe occupies the remaining triangular space at the back below the parieto-occipital suture down to the lower line of the cerebrum.

The central lobe of Island of Reil lies in a deep fissure between the frontal and temporo-sphenoidal lobes and is covered by them.

Each lateral half of the cerebrum contains within its substance a cavity known as the lateral ventricle of the brain. These cavities are filled with a spinal fluid and connect with the third ventricle and thence into the fourth, of which I will speak later, and from there on into the central canal of the spinal cord. These cavities are probably to allow for expansion and contraction of the brain, according to the amount of blood drawn to the part. In acute congestion or inflammation of the brain the surface of this cavity is covered with minute red particles showing the exudation of blood into the space.

Directly below the ventricles lies the optic thalamus, the caudate and lenticular nuclei, of which mention will be made later, and the internal capsule. The internal capsule lies between the lenticular nucleus and the optic thalamus and is the bundle of white fibers extending up from the spinal cord, medulla and cerebellum to be distributed throughout the cerebrum. The blood sup-

ply of this capsule is extensive and is liable to disease, resulting in apoplexy or paralysis, according to its severity. The space being so small, a slight hemorrhage will cause sufficient pressure in some instances to entirely suspend the action of the nerves on the side of the brain affected.

In addition to the gray matter of the cerebrum and cerebellum there are the following ganglia lying at the base of the brain:

The olfactory bulbs lie directly beneath the frontal lobes and upon the cribriform plate of the ethmoid bone, directly above the nasal cavity. They are ganglia of the sense of smell and are connected with the two hemispheres by the olfactory tracts.

The optic thalami, the great sensory ganglion, is situated in the floor of the lateral ventricle.

The corporata striata, which is the great motor ganglion, lies in the floor of the lateral ventricle and consists of the caudate and lenticular nuclei.

The corpora quadrigemina, or optic lobes (four in number), lie beneath the posterior lobes of the brain, near the union of the cerebrum with the cerebellum. These form two ganglia for vision.

The tuber annula are in the body of the pons varolii. It is probably the seat of indistinct sensation.

There are in the brain five ventricles, as follows: The lateral, two in number, which have been described. The third ventricle, which is connected with the two laterals and lies between the two optic thalami on the base of the brain. The fourth ventricle, connected with the third, and lying in a space between the cerebellum and the medulla. It is considered by some to be a simple enlargement of the central canal of the cord. In its floor lie the centers of many of the most important nerves and automatic functions of the body. The fifth ventricle is a closed space lying between the membranes, which bind the lateral ventricles internally.

The mid brain comprises those structures which connect the cerebrum with the cerebellum and medulla, and includes the following structures: The pons varolii is the great white transverse commissure that is seen at the base of the brain in front of the medulla. Its fibers connect the hemispheres of the cerebellum with each other and with the medulla.

The crura cerebri, or roots of the cerebrum, extend from the pons to the corpora striata and optic thalami and consist of fibers which pass from the medulla to the ganglia named, and thence upward to the gray matter of the hemispheres through the internal capsule.

The corpora quadrigemina are really a portion of the mid brain. They lie directly back of the third ventricle and under the posterior portion of the corpus callosum. They are four in number, the two anterior being known as the nates and the two posterior and smaller ones, the testes. They are connected with the optic thalami and optic tracts by four bands and with the cerebellum by a white cord on each side. They constitute the center of vision.

### THE MEDULLA OBLONGATA.

This ganglia or portion of the brain is really the upper enlarged portion of the

spinal cord extending from the upper border of the atlas to the pons. As the spinal cord passes into the skull it bends forward the anterior surface of the medulla lying upon the basilar process of the occipital bone. Its posterior surface, which is turned up toward the cerebellum, forms the floor of the fourth ventricle. It is divided into two lateral halves by the continuation upward of the anterior and posterior median fissures of the cord. It contains gray matter scattered through its substance in a much less regular manner than in the cord from which the cranial nerves from the fifth to the 12th, inclusive, arise entirely or in part.

In the medulla also lie the centers for the vaso motor and cardiac nerves, of which I will have something to say in a later lecture. There are also the centers for the control of respiration, phonation, deglutition, mastication and expression. The medulla is roughly shaped, like an inverted truncated cone. As it ascends it increases in breadth faster than in its antero-posterior diameter, giving it a flattened appearance.

Roughly speaking, the columns of the cord are continued upward into the medulla, though with a slight rearrangement. For instance, the pyramidal tracts, the great motor tracts of the cord, are crossed over to the other side in the medulla, or a large portion of them do, thus forming what is known as the crossed pyramidal tract, and explaining why in a case of paralysis you will find one side of the body affected, while the opposite side of the face will not be involved.

In addition to the crossed pyramidal tract there is the direct pyramidal tract, which is continued up on the same side to the cerebrum and cerebellum. The fibers of the direct pyramidal tract are said to cross over in the cord, however, at various levels as they progress downward.

In the medulla the pyramids lie on each side of the median fissure. On the outer side of the pyramids are two oval shaped eminences that are not found in the cord. They are known as the olivary bodies and consist of white matter outside and gray and white matter within, and constitute one of the important nerve centers of the medulla.

(To be continued.)

### A New Color Theory.

It is reported by the *British Medical Journal* that Dr. Eldredge-Green has for years been propounding a new theory of color vision, which, however, is just beginning to receive due recognition.

The theory does away with the necessity for the theories of Helmholtz and others, and will undoubtedly be generally accepted when fully presented.

Oscar A. Johnson, Elbow Lake, Minn., has sold out to John N. Rovang, formerly of Fergus Falls, in the same State.

D. P. Paul, Norfolk, Va., contemplates erecting a four-story building at the corner of Granby St. and City Hall Ave., at a cost of about \$50,000. Mr. Paul will reserve the first floor and a portion or all of the second floor for his retail jewelry business.



That this department shall prove mutually beneficial to our readers, it is desirable that the members of the trade generally communicate with THE JEWELERS' CIRCULAR-WEEKLY regarding any advantageous device or plan which they are utilizing in connection with their business.

### Clever Advertising Scheme of a Jeweler in Northern Ontario, Canada.

A CLEVER scheme for reaching the tourist and traveling trade, especially during the Summer months, has been adopted

is six feet long and 42 inches high. All the fixtures and the woodwork are of quartered oak, in the natural finish.

A handsome partition separates the store from the workshop. In the center of the partition is placed a large three-ton bur-

of 10 candle power each. In the show window there are two lights of 32 candle power each, while the counter cases contain 12 lights of eight candle power each. The workshop is equipped with every modern device for the repairing and adjusting of watches, and the whole establishment is considered one of the finest in Northern Ontario.

### Recent Catalogues and Booklets.

A NOTABLY fine catalogue of 196 pages has been received from John C. Pierik & Co., Springfield, Ill. The catalogue measures 6½x9½ inches. The cover pages are of a straw tint, printed in bluish green and black and embellished in the center by a fantastic design, consisting of two dragons. The first inside cover page shows an interior view of the store, the back cover page shows a view of the Pierik building, while the inside back cover contains a line reproduction of the exterior of the store, displaying to good advantage its spacious plate glass windows.

The first page of the catalogue gives some general instructions to the prospective purchaser in ordering stock. Following this are beautiful large half-tone illustrations of jewelry of all kinds, the half-tones of diamonds being especially good. Interspersed



WESTERN SIDE OF THE STORE OF J. A. MORROW, PARRY SOUND, ONT.

by J. A. Morrow, Parry Sound, Ont., whose establishment is illustrated this week. Mr. Morrow sends a clerk, or goes himself, to the different Summer hotels and there secures a list of guests each day. In this way he builds up a good mailing list and addresses to each name a neat postal card bearing on one side an interior view of his establishment. At the present time, when the post card craze is about at its height, the scheme ought to be particularly effective. If the cards are not retained by the older tourists they will at least be added to the album collection of the tourists' children and the jeweler will thus receive a generous amount of advertising.

The store is 50 feet long and 13 feet wide, the height of the ceiling being 11½ feet. As may be seen from the illustration there is a goodly amount of show cases, the main wall case being 16 feet in length, eight feet in height, and 27 inches deep. Under the wall case proper are drawers and cupboards.

There is a large plate-glass mirror in the center of the wall case, which is equipped throughout with paneled plate-glass windows. On the east side of the store are the five counter cases and salesman show case. Each counter case

glar and fireproof safe. On either side of the latter is a swinging door leading into the workshop. On each side of the safe,



A PERSPECTIVE VIEW OF THE EASTERN END OF THE ESTABLISHMENT.

between the swinging doors and the walls, there are panels of plate-glass mirrors with beveled edges.

The store is lighted by 12 electric lights

between the pages of the regular half-tone reproductions there are colored lithographic plates showing necklaces, stone set brooches, La Vallières, etc., in their natural color.

**Storekeeping Department.**

This is a buyers' guide worth having and one which will certainly not be thrown into the waste basket.

\* \* \*

The Michigan Optical Co., Detroit, Mich., is sending out an attractively printed catalogue, about 7x9 3/4 inches. The cover pages are of a dark olive hue, printed in gold, the design being a spectacle frame, the extended bows of which form a border to enclose the concern's imprint. There are 40 pages, generously illustrated.

**Why Some Advertising Doesn't Pay.**

NOT enough is paid for some of it, and not enough attention is paid to some of it.

We very rarely get more than we pay for—oftentimes less. A paper that has "cheap" rates gives "cheap" results. Scattering an advertising appropriation among "cheap" papers instead of putting it all in the few leading and seemingly high-priced papers is the reason why it doesn't pay. Advertising is like the sunbeams—the stronger the glass and the more concentrated the rays, the deeper they burn.

Some say advertising isn't any good because an inch ad. won't keep their shop crowded with orders. Would they say that coal was worthless because a shovelful wouldn't get up steam in a boiler?

Some say that advertising doesn't pay because they put an ad. in a paper and let it stay until its gets mouldy with age—never change it. Wouldn't they stop reading this paper in short order if the reading matter should be the same week after week? Readers have the same right to ignore the ad. that is the same old thing every week.

Some print an ad. with the name, address and goods they manufacture without a solitary reason why their goods are better than the "other fellow's." They'd get rid of a salesman pretty quick who made a practice of calling on people and simply leaving his card. And an ad. is only another kind of a salesman. And on the other hand it's just as big a mistake to try to crowd the contents of a catalogue in a small space.—*Engineering and Mining Journal.*

**Publicity Prattle.**

"VOT you mean by dose, huh?" queried the member of the little German band.

"You are always blowing your own horn," said the f. b. in explanation.

"Dot vos where you don'd know somedings, meppy," replied the wind jammer. "Dis was a porrowed puggle, alreaty."—*Chicago News.*

\* \* \*

New life is needed in the advertising, when the business of a concern that advertises is not going forward. A business that advertises ought to be going forward, and not simply holding its ground. Ordinary advertising will avail to secure the latter result, but good advertising means positive progress; supposing always that there is nothing in the character or management of a store to counteract its effect.—*Rhode Island Advertiser.*

**The Way of the Enterprising.**

AN effective advertising scheme was carried out by S. D. Burritt, Rochester, N. Y. for the Easter trade. In his big automobile, Mr. Burritt visited the different high schools and private academies and when the students came forth he presented each with an elegant ribbon book-mark. In several cases Mr. Burritt had to ride from the scene on account of the crowd which gathered about his machine. Friday and Saturday he gave away the souvenirs to all who came to his store, and if he did not sell every one, he did have his name on the lips of many who in the future are more than likely to call on him.

\* \* \*

Ryrie Bros., Ltd., Toronto, Ont., held their Easter opening Saturday, April 7, when the store was tastefully decorated with choice flowers and plants, including azaleas, Boston ferns, large palms and Easter lilies. A special feature was a glass-covered table

**Attractively Designed Window Display Recently Made by a Western Jeweler.**

DECATUR, Ill., May 2, 1906.

Editor THE JEWELERS' CIRCULAR—WEEKLY:

I enclose a photograph of my latest window display, which does not show up very well in the photo, although it is good in reality. The pyramid containing cut glass revolves. On the top are wires, bent in a half circle, covered with smilax, and on the ends are hung china cups and white eggs, with prices and descriptions written on the eggs. In the small, long cups are rabbits, holding prices. The words, "Easter, 1906," are in the center of the table, part of which can be seen, and are made of different colored stones.

At the bottom is a duck in full dress, watch, chain, stud, etc. The watch is a silver one, and the duck's four children are presenting to him a more handsome one—a gold watch and chain. At the right is a hen on a setting of diamonds. Several eggs



ATTRACTIVE JEWELRY DISPLAY BY ED. T. JENISON, DECATUR, ILL.

with a large center vase of brides' roses, the base displaying a profusion of lilies of the valley, etc. During Easter week enormous crowds were attracted by a unique window display consisting of a design representing an Easter dove measuring about one foot from tip to tip and composed wholly of diamonds, no setting being visible. It embraced over 1,200 stones valued at \$65,000 and was displayed upon a black velvet ground with brilliant effect. The crowds who thronged to see it were so large as to interfere with pedestrian traffic.

\* \* \*

C. F. Jakeman, Norfolk, Va., is attracting attention to his display window by "Educational Window Display," articles on which were begun in the issue of THE CIRCULAR—WEEKLY of March 21, 1906, and concluded May 2 last.

Roy Murray, Clay Center, Kans., is now at Altoona, Kans.

F. Willman, Stillwater, Minn., has disposed of his business interests at that place to Peter Gaalaas.

are nearly broken open, showing diamond rings and watches within, with appropriate cards, some of which latter I took from THE CIRCULAR—WEEKLY. Mr. Duck states he will give his old watch to Hen-rietta.

One card by the side of an egg which contains a diamond reads, "Eggs, \$780 per doz., or \$65 each." The prices are marked on cardboard, cut out in the shape of chicks.

The window was designed and built by me, and I have heard much comment regarding it. I believe I have gotten as much credit for the idea as I have for the attractiveness of the window.

The picture was taken before the window was finished, as two large Easter lilies were later placed in the background.

Yours truly,  
ED. T. JENISON,

B. C. Weiler, Armstrong, Mo., has discontinued business.

Mr. Henderson, of Henderson & Clopton, Lufkin, Tex., has sold out his interest in the business, which will be carried on by M. L. Clopton, Jr., alone.

What Tool is of More Importance to THE MAKERS OF FINE JEWELRY than

A FIRST CLASS SAW ?

SHARP—TRUE—UNIFORM  
—PERFECTLY TEMPERED



Such is the **ZEUNER SAW.**  
TRY THEM, for "Only the Best are Good Enough," and only the Best are Cheap. Trial orders promptly filled under guarantee of perfect satisfaction, which applies also to our "AMERICAN SWISS FILES."

**E. P. REICHELME & CO.,** 23 JOHN STREET, NEW YORK.

**HERPERS BROS.,**  
MAKERS OF  
**SETTINGS**  
IN 10, 14 AND 18 KARAT GOLD AND IN PLATINUM.  
ALSO A COMPLETE LINE OF GALLERIES AND FINDINGS.

BRACELET SHELLS  
FIVE SIZES  
ROUND AND OVAL

SECTION

OFFICE AND FACTORY NEWARK, N. J. U. S. A.  
NEW YORK BRANCH 41-43 MAIDEN LANE

**GLARDONS' SWISS FILES**  
are the  
**HIGHEST STANDARD**  
of Excellence.  
We are Sole Agents for the United States and Canada.  
**F. W. Gesswein Company,**  
Established 1868. Incorporated 1896.  
WILLIAM DIXON, PRES.  
Dealers in Fine Tools and Supplies,  
39 John Street, New York.

**CULMAN BALANCE - CHUCK**  
For Refinishing Balance Pivots, without removing the Hair-spring or Roller, and protecting them while the pivots are being polished.  
Over 1000 Sold the First Year.  
Made for the principal lathes and will be made for any lathe for which I receive 10 orders.  
Hundreds of watchmakers testify that this chuck is what I claim it to be,  
**Practical, Safe, True and the Greatest Time-Saver ever Offered to a Practical Watchmaker.**  
Send for one and try it.  
Order from your material jobber or direct from the patentee and maker.  
**C. CULMAN, 316 N. Sixth Street, - ST. LOUIS, MO.**

**CRUCIBLES.**  
Jewelers' Supplies, Etc.  
Established 1850.  
**J. & H. BERGE,**  
95 John Street, NEW YORK.

**F. JEANDHEUR, Jr.**  
Rear 17 John St., N. Y. Third Floor.  
Gold and Silver Plating  
SPECIAL WORK AND COLORING  
IN ALL SHADES A SPECIALTY.  
Established 1868. PLATINA PLATING.

**ROLLED GOLD PLATE  
SEAMLESS WIRE AND TUBING**  
**DUNBAR, LEACH, GARNER CO.,**  
MANUFACTURERS,  
ATTLEBORO, MASS.

**PATENTS**  
obtained on inventions and designs. Trade-marks, prints and labels registered.  
**R. W. BISHOP,**  
ATTORNEY AT LAW,  
908 G Street N. W., Washington, D. C.

We are now located at  
41 and 43 MAIDEN LANE,  
NEW YORK.  
For 20 years at 73 Nassau Street.  
**J. J. DONNELLY,**  
GOLD AND SILVER PLATER.

Established 1879. Manufacturer of  
**LOUIS W. HRABA,** Fine Leather Goods,  
29 East 19th St., New York. Exclusively for the Jewelry Trade.

**A & M**  
IVORY HANDLES AND NOVELTIES  
Direct Importers and Manufacturers of **IVORY, STAG** and **HORN** for the Cutlery and Silversmith Trade.  
ESTABLISHED 1890. TELEPHONE, 2698 FRANKLIN. **210-212 Canal St., New York.**

**MAEBERT & REISS**  
WATCHMAKERS TO THE TRADE  
Wheel Cutters and Adjusters  
Accurate Work—Low Prices—Quick Returns.  
We receive parcels by mail or express from all over the United States.  
71 and 73 NASSAU ST., Corner John,  
(The New "Cockcroft" Bldg.) NEW YORK.  
"PRACTICAL COURSE IN ADJUSTING."  
Price, \$2.50.  
All Jobbers or Jewelers' Circular Publishing Co.





[Answers are also solicited from our readers to the questions published on this page.]

**QUESTION No. 1548.—Flux for Gold Sweeps.**—Can you kindly tell me the best compound or flux to be mixed with gold sweeps after it has been burnt down?

C. O.

**ANSWER:**—The usual flux for melting down gold consists of equal proportions of powdered borax and saltpeter added and melted with the whole mass.

**QUESTION No. 1549.—Wood Alcohol.**—Can you tell me if wood alcohol will spoil the burner in a chafing dish lamp?

C. S. B.

**ANSWER:**—If wood alcohol is pure, or 95 per cent. proof, it will not harm your lamp.

**QUESTION No. 1550.—Gold and Silver Powders.**—How can I make gold bronze powder, also light green, pink, brown and silver colors? Please give me the ingredients, also a method for enamel such as painters use on iron and wood, in quantities of 25 to 50 pounds.

M. F.

**ANSWER:**—You probably would not be as likely to get as good results from recipes for bronze powders and also enamels as you would from both powders and enamels which are now placed upon the market by reputable manufacturers. The cost of preparing them would be greater than if you bought these materials ready for use. These materials are put together in a scientific manner and mechanically mixed and prepared by means of machinery. Results are obtained in their application which can hardly be obtained when they are self-prepared.

**QUESTION No. 1551.—Gold Coloring by Dry Battery.**—Please inform me of a good gold coloring to use with dry battery. I have several recipes for the zinc strip, but find that it does not answer as well as the electric battery.

L. D. G.

**ANSWER:**—Dry batteries cannot be used advantageously for gilding or coloring, but a small battery would answer very well. The simplest way to make a gold solution is by dissolving one-quarter pound of cyanide of potassium in one-half a gallon of distilled water and add to this one-quarter of an ounce of chloride of gold, using a gold anode for the deposit. See Workshop Notes No. 1400 (Dec. 6, 1905), No. 1373 (Nov. 1, 1905).

**QUESTION No. 1552.—Gold Solders.**—I have had a great deal of trouble with the different karats of gold solder which I have purchased. Can you give me the component parts of the different kinds of solder to be used in the general run of making and repairing jewelry.

C. W.

**ANSWER:**—A very hard solder for 18-karat gold is: Fine gold, 9 parts; silver, 2 parts; copper, 1 part. Soft and easy running solder for 18-karat gold: Fine gold,

12 parts; silver, 7 parts; copper, 1 part. Very hard solder for 14-karat gold: Fine gold, 3 parts; silver, 2 parts; copper, 1 part. Easy running solder for 14-karat gold: Fine gold, 2 parts; silver, 0.5 parts; copper, 0.5 parts.

Solders for less than 11-karat:

No.	Fine gold.	Silver.	Copper.	Zinc.
1.....	1 part	2 parts.	1 part.	.....
" 2.....	1 part.	2 parts.	.....	.....
" 3.....	1 part.	.....	2 parts.	.....
" 4.....	12 parts.	5 parts.	.....	5 parts.

**QUESTION No. 1553.—Sterling Silver Alloy.**—Please give me an alloy for sterling silver, something that will not blister very much and will work well under the spinning tool and drawing press. I now use the well-known formula—silver, 925 parts, and copper, 75 parts.

S. S. A.

**ANSWER:**—It has been found by experiment that the addition of cadmium to the silver and copper improved the sterling so that it can be spun and drawn on the press more successfully than when no cadmium at all is used. The oxide of copper which is formed during the melting is the cause of the difficulty. The more oxide copper contains, the less malleable it is. The same is true of any of the copper alloys. The presence of oxide of copper in sterling silver determines whether the sheet metal will be bad or good. For an alloy that possesses all the required qualities for sterling silver the proportions are: Fine silver, 462.5 ozs.; Lake copper, 35.0 ozs.; cadmium, 2.5 ozs. To produce this properly put the granulated copper in the bottom of the crucible and put the silver on top of it. Then cover with fine charcoal and when the whole is melted add the cadmium by forcing the sticks under the surface, otherwise it would burn away.

**QUESTION No. 1554.—To Preserve Gilt Frames.**—What is the best method of keeping frames that have been gilded in good condition?

M. G. F.

**ANSWER:**—Water should never be put on frames which are gilded. They are usually lacquered, and the water would soon destroy the lacquer, so that the frames would have to be continuously polished. Wipe them off with a dry chamois if possible; if this has no effect, then slightly moisten a cloth and wipe off just enough to remove the dust.

**QUESTION No. 1555.—Etching Silver Deposit.**—How is the etching done on silver deposit for glass or porcelain?

E. S. D.

**ANSWER:**—According to the *Metal Industry*, glass or other metallic substances which are being used in the silver deposit industry are completely covered with silver. The design is painted out and the surplus silver is reduced by a current. A five per cent. solution of pure nitric acid and aluminum

plates is used as a cathode. This procedure gives a pure metallic nitrate of silver solution, which can be prepared so as to be added to the regular depositing bath. Owing to the thickness of the deposit, the solution needs repairing very often. A six hour deposit can be reduced in the etching bath very rapidly.

**QUESTION No. 1556.—Razor Hones.**—Can you tell me how the razor hones are made?

B. W.

**ANSWER:**—The *Scifensieder Zeitung* gives the following information to make razor hones: "They are often made entirely of alum. The alum is dissolved in an equal quantity of water, and the solution is evaporated. Glycerine, muriatic sublimate and methol are added, and the hot mixture is poured into sheet metal molds. It hardens to a crystalline mass, which is ground smooth with water. The hones are best packed in metallic boxes.

**QUESTION No. 1557.—Making Cup-Shaped Articles.**—I am trying to make cup-shaped articles out of a flat piece of copper by drawing up the edges. The size is about two inches in diameter and one inch deep. I made a die and forced the proper size, but the pieces have come out badly wrinkled on the edges. Is there any way of preventing the wrinkles without the use of an expensive die and blank holder arrangement?

D. C. S.

**ANSWER:**—Do the cutting out and pressing up in one operation, with a combination die. This is arranged so that a blank holder is held in place with a rubber bumper which prevents wrinkles forming on the edges. Where one wants to use only the die without the blank holder, then it is best to turn the edges over on the spinning lathe in such a way that they are turned up from  $\frac{3}{8}$  to  $\frac{1}{2}$  inch. This cup-shaped blank may then be forced through the die, leaving the edges unwrinkled. This method does not only apply to copper, but will work equally as well on brass, aluminum or other sheet metals.

**QUESTION No. 1558.—Porous Plaster Molds.**—Kindly inform me how to make a plaster mold that can be used for casting the soft metals—silver and brass. I have used the plaster of paris molds for the softer grade of metals, but was not successful with silver and brass.

P. P. M.

**ANSWER:**—A composition for porous plaster molds has been patented by J. G. Weyer, Providence, R. I., which is claimed to be suitable for molds for fine and delicate lines and for brass, silver and the softer grades of metal. This mold is made by using calcined plaster of paris and finely screened coal ashes. The screened ashes are mixed with water to the consistency of thick cream and the plaster of paris is mixed the same way. The two pastes are then mixed together in about equal proportions. This is used to produce the mold in the usual manner in which plaster molds are made. The ashes with the plaster will produce a mold that is very porous, enabling the castings to run full more readily than by any other method. After the molds are made they should be dried for five or six hours at a heat of about 250 deg. F.

Frank Glab, Shelbyville, Ind., has sold out to J. McCleskey.

**C. DORFLINGER & SONS,**  

---

 36 MURRAY STREET, NEW YORK.

*Works, White Mills, Wayne Co., Penna.*

Manufacturers of plain  
 and cut Table Glassware  
 of the highest quality.



**ENGLISH :: GLASS.**

Large Assortment of  
 FANCY VASES,  
 GENTRE PIEGES and  
 ROCK CRYSTAL STEM WARE,  
 Particularly adapted for the  
 Jewelry Trade.  
 Write for particulars.

Sole Agent for the Celebrated CAULDON CHINA.  
**EDWARD BOOTE,**  
 46 West Broadway :: New York.



No. 502, Berry Saucer - MIGNONETTE.  
**Maple City Glass Co.,**  
 CUT GLASS TABLEWARE,  
 Hawley, Pa.

SALESROOMS:  
 New York—H. B. Stites, 253 Broadway.  
 Baltimore—Green & Thomas, 33 S. Charles  
 St.  
 Boston—Sweetser-Bennett Co., 101 Tremont  
 St.  
 Buffalo—J. R. Stadlinger, 685 Main St.  
 Indianapolis—J. A. Dugan Co., 22 S. Capl-  
 itol Ave.  
 Duluth—Duluth Crockery Co., 6th Ave. and  
 West St.  
 Denver—Western Selling Co., 1617 Law-  
 rence St.



12 Designs. No. 4083D.

**The Hit of the Season.**

Two Assortments of 10 inch  
 Hand Painted Plates of our  
 own make, most suitable for  
 Plate rails and window dis-  
 plays.

Assortment No. 4083, \$9 00 doz.  
 Assortment No. 4084, 13.50 doz.

**THE HANDEL CO.,** MERIDEN,  
 CONN.

**FAIRCHILD & COMPANY**  
 225 to 233 Fourth Ave. NEW YORK CITY.

Manufacturers of GOLD PENS, PENCILS,  
 PENHOLDERS, SEGAR CUTTERS, SPE-  
 CIALTIES, PENCILS SET WITH JEWELS.

*Style, quality and workmanship acknowledged  
 the very best.*



**Jewelers, Notice!**  
 WE want one first-class Jeweler in every  
 city and town to handle our line of  
 CUT GLASS (exclusively).  
**NEWARK CUT GLASS CO.,**  
 Newark, N. J.

**JACOT MUSIC BOX CO.,**  
 IMPORTERS.  
 Stella and Ideal Music Boxes,  
 39 UNION SQUARE, N. Y.

**Photographs**  
 FOR JEWELERS' USE IN METAL FRAMES.  
 Choicest selection to be found anywhere.  
 Samples on application.  
**HALL'S STUDIO, 1456 Broadway, New York**

**CLOCKS, BRONZES, CUT GLASS and ART NOVELTIES.**  
 WHOLESALE DISTRIBUTORS **COMMUNITY SILVER** SEND FOR CATALOGUE  
**H. BEALMEAR & CO., 234-236 Park Avenue, Baltimore, Md.**

# THE CONNOISSEUR



*Devoted to Art Pottery, China, Marbles, Bronzes, Cut and Decorated Glass Ware, Bric-à-Brac, Lamps, Art Metal Wares, Fancy Goods and Kindred Lines.*

## A Plea for the Manufacture of Hard Paste China in England.

A CONTRIBUTOR to *The Pottery Gazette*, of London, argues that if the English manufacturers of china are to hold their own in the home and foreign markets they must make hard paste as well as soft paste china ware. It is argued that while the soft paste gives the maximum of beauty it cannot compete, when cheapness and durability are the desired factors, with the hard paste china of Germany and other countries. The writer says:

How comes it that there is not in England a manufactory of hard paste china? It would not be easy to answer the question without entering into a long, and perhaps not very profitable inquiry concerning the history and requirements of this very beautiful and commercially valuable ware. We have no wish to appear pessimistic or to cry through our pottery towns that the glory is departed from our bone china making districts. Yet is there a manufacturer of that most beautiful ware who does not feel in his heart a foreboding that he has before him a stormy, difficult, not to say impossible, future?

It is admitted on all hands that the soft paste or English porcelain is the most beautiful material in existence for tea, coffee, and dinner services. Its beauty is not denied by anyone, nevertheless we feel assured that in the future the sale of this ware will be more and more restricted, and that, while for high class and elaborately decorated ware it has a long and glorious future, for those articles where it comes into competition with the cheap German ware it cannot hold its own. This sense of danger has made many of the English manufacturers turn longingly to the idea of a duty upon imported china. How far this would help them in the home market is uncertain, but it is pellucidly clear that no help for our export trade is to be found in that direction. In foreign, and especially the American market, we must offer a better article at a lower price than our competitors, or retire from the trade.

Now the simple fact is—and there is no use hinking that fact—that hard china is better from the user's point of view than soft china; it is not merely that the soft china is somewhat dearer, but it has not the life of the hard china. Hard china, simply because it is harder, wears longer, is more difficult to break, keeps its decoration longer, and is at every point, except that of beauty, superior to its soft paste competitor. We do not believe there is anyone in the trade, whatever may be his wishes, but acknowledges in his heart the facts to be as we state. The experience in the American market will, we believe, hear this out triumphantly.

What then must be done? We believe there is only one course open to the English maker, and that is to face the difficulty boldly and determine to overcome it. Hard china can be made of English materials we know, for we have seen it. Nor do we for a moment doubt that Staffordshire possesses men of such energy and intelligence that they will bring the experiments of the laboratory to the test of the warehouse and cost account, and come off triumphant. This may be expensive, but, if the china trade is to be maintained, it must be done, and the china manufacturers must join together to carry out experiments and determine on the best method of procedure, so as to benefit all concerned. To revolutionize a trade, to introduce a new material, to adopt new methods, to accustom the workmen to new ideas of treatment in manufacture, is always a difficult

and serious undertaking, but it is necessary in this case.

We further think these difficulties have been somewhat magnified. It is asserted that the cost of production abroad, especially in Germany and Austria, is so low that English labor cannot compete, that remains to be seen. It has been proved conclusively in other branches of the ceramic trade that English labor is the cheapest in the market. Nothing is more common to find Englishmen who have been a few months in some foreign factory shaking their heads and confessing with regret that they see no chance of England competing with the foreigner, but ask the same men after three or four years' experience, what do they say then? The glamor has worn off, the unskilfulness, slowness, ignorance of the workmen has come to light; the low rate of wages remains, but the rate of production is equally low; and men, who have been heard to speak enthusiastically of foreign workmen on a three months' experience, have been heard to speak just as disparagingly after three years. In spite of everything seeming to the contrary, we believe it will be found that the English artisan potter is the cheapest in the world, and he is undoubtedly far and away the best. We think then there is not much reason to fear results from the point of view of labor.

Where, then, is the great difficulty? Doubtless in method the body is quite different, and has to be discovered and brought to perfection; the method of treatment must be changed; the setting, firing, glazing, must all be relearned, and here it behoves those concerned to walk carefully. What is to prevent our people taking a lesson from the practice of our Continental neighbors? Many an Englishman has been engaged to show the Continental potters how to produce their ware; indeed, there is scarcely a Continental pottery of note where Englishmen are not or have not been employed for this purpose.

Let the china makers take a lesson from this. There are, on the Continent, good men at the head of hard china works, one of whom would, we do not doubt, gladly accept a post as pioneer in this class of work in England. The first attempts would be necessarily slow and expensive, but we should be put at once on the right methods and saved much waste and loss in futile experiments. What is required is bold, united and prompt action. Will our manufacturers take it? It is their question, they must settle it.

## Industrial Art Exposition in Paris.

FROM June to October of the present year an International Arts and Crafts Exposition will be held in the Champs Elysees, embracing ceramics, glass, crystal and kindred industries, under the title of "Exposition Internationale des Arts et Industrie du Feu" (International Exposition of Arts and Industry of the Fire). This exhibition will be under the protectorate of the French Ministries of Commerce, of Public Works, of Instruction and of the Fine Arts, as well as under that of a committee consisting of prominent persons.

For the purpose of obtaining information, prospectuses, etc., a card to Monsieur Ch. Bing, General Director, Exposition Internationale des Arts and Industries du Feu, 19 rue St. Roche, Paris, will bring forth all the information an American manufacturer may desire.

## Jewelry, Silverware, Clocks and Watches Among the Wedding Presents to the President's Daughter.

WHILE estimates of the value of the wedding presents given to the daughter of President Roosevelt when she became Mrs. Longworth were not much more than guess work, yet the Washington correspondents seem to agree that the articles are not to be duplicated for less than \$250,000, and some of the papers have said that \$500,000 would not be an exaggeration of their cost. Included in the presents were numerous articles of jewelry, precious stones, clocks, watches, cut glass, decorated china and novelties.

From Emperor William of Germany came a bracelet hand wrought in Roman gold and set with diamonds and sapphires. This bracelet came in a case of aluminum leather embossed with the imperial arms of the house of Hohenzollern. The gift of Emperor Francis Joseph of Austria was a diamond and pearl pendant, presented on behalf of his Majesty by Baron Hengelmüller. The King of Italy sent a mosaic table inlaid with gold. King Alfonso of Spain, who is himself a prospective bridegroom, gave the bride several pieces of antique jewelry. The President of France sent a personal present in the form of two Sèvres vases.

A necklace of diamonds, each three-fourths of a carat in weight, was Mr. Longworth's gift to the bride. Mr. Longworth ordered this necklace in Cincinnati soon after the return of the Taft party from the Orient and several weeks before the engagement was announced from the White House.

The gift of Cuba to the daughter of the President on her wedding day was a rope of pearls purchased in Paris by the Cuban Minister there. It was forwarded to Señor Quesada, the Cuban Minister in Washington, and presented by him in behalf of the Government and people of the Island. The President and Mrs. Roosevelt gave to the bride a corsage ornament of emeralds and diamonds. This was presented to Mrs. Longworth about a fortnight before her marriage, and she wore it first at a reception at the White House.

A massive centerpiece of silver and a set of plates made in Baltimore were presented by Secretary and Mrs. Bonaparte. The bowl is exquisitely ornamented with lace work and with open work around the rim.

The Vice-President and Mrs. Fairbanks gave a set of oyster cocktail cups of heavy silver. The stand is of plain silver, engraved with the initials "A. L. R." The holders are of silver lattice work and the cups are of belek ware.

Secretary and Mrs. Metcalf gave a silver



# FANS

Fan Season is here, and we are prepared for it with the choicest line that has ever been imported from Paris. These dainty creations are appropriate for Graduation, Confirmation, Weddings, and in fact for any occasion where taste and exclusiveness are requisite.

SEND FOR A SELECTION, MENTIONING PRICE  
**LEWY & COHEN**  
 530 BROADWAY, NEW YORK

Importers of Fans, Brooches, Mounted Side and Back Combs, French Bead Necklaces in mother-of-pearl effects, and THE "MEDICI CHAIN," a new French creation in fan chains.

## The PAIRPOINT CORPORATION NEW BEDFORD, MASS.

Superior  
 Silver  
 Plated  
 Ware

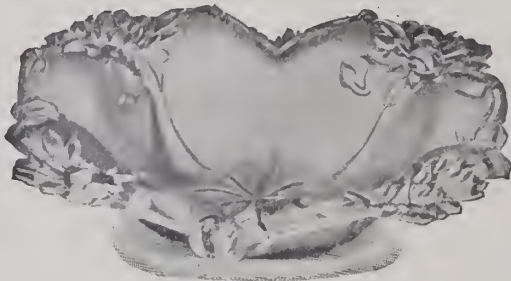

Rich  
 Cut Glass  
 Ware  
 Electroliers  
 Etc.

No. 6629 Bon Bon.

Branches  
 38 Murray St., NEW YORK CITY  
 120 Sutter St., SAN FRANCISCO, CAL.  
 Temple Bldg., MONTREAL, P. Q.

### Photo Books!



## GUERIN CHINA of LIMOGES, FRANCE.

Our gold incusted patterns are recognized by the trade as "STANDARDS." This line, because of its quality and rich effects, is especially desirable for Jewelers.

### Wm. Guerin & Co.

Sole Agent: CHARLES STREIFF, 33 Park Place, New York.



Try Wells' Perfect Ring Adjusters  
 1 doz. asst. sizes 10k gold filled (gold on front, twice as thick as on back), \$2.00.  
 1 doz. asst. sizes solid 10k gold, \$3.75.  
 1 doz. asst. sizes metal, 85c. Ask your jobber for them, or I will send, prepaid, at once (only on receipt of price), two samples—one small and one medium large gold filled and one metal adjuster for 50c. Address

CHESTER H. WELLS, Jeweler Meshoppen. Pa.

A. Nonnenmann & J. Aschenbrenner,  
 114-118 East 23d St., New York.

Original Designers for Platinum, Gold and Silver Jewelry. Artistic Designs for Silverware and Novelties furnished at shortest notice.

- 1. Snap complete.
- 2. Outside of Snap.
- 3. Inside of Snap.

## The E. P. H. Patent NON-PULL-OUT Neck Chain Snap

is a patented snap that insures the wearer against loss of

CHAIN or CHARM  
 for it positively will not pull out

Made in 10 and 14 Karat Gold and in Gold Filled.

Can be had of the following Wholesale Selling Agents:

- Messrs. W. Green & Co.,  
 81 Nassau St., New York.  
 M. Sickles & Sons, Philadelphia  
 E. A. Cowan & Co., Boston  
 E. & J. Swigart, Cincinnati  
 Swartzchild & Co., Chicago  
 Nordman Brothers, San Francisco  
 Leonard Krower, New Orleans  
 Bauman-Massa Jewelry Co., St. Louis

### PRICES.

- 14 Karat—Small, \$7 per doz. net  
 Large, \$7.50 per doz. net
- 10 Karat—Small, \$6 per doz. net  
 Large, \$6.50 per doz. net
- Gold Filled—Small, \$2 per doz. net  
 Large, \$2.25 per doz. net

## CRANBERRY LAKE REGION OF THE ADIRONDACK MOUNTAINS

a section full of large fish is described in New York Central Lines Four-Track Series No. 32, which contains a beautiful map of this region printed in four colors. Copy will be sent free, postpaid, on receipt of a two-cent stamp by George H. Daniels, Manager, General Advertising Department, Room 61-A, Grand Central Station, New York.

THE



TAKE YOU TO THIS REGION FROM EVERY DIRECTION

C. F. DALY, Passenger Traffic Mgr. NEW YORK  
 W. J. LYNCH, Passenger Traffic Mgr. CHICAGO

tankard. Ex-Secretary and Mrs. Paul Morton gave a Limoges dinner set of 12 pieces. Secretary and Mrs. Shaw contributed a chocolate set of Royal Worcester. Secretary and Mrs. Taft presented a diamond locket. Attorney-General Moody tendered the bride a pair of silver candlesticks, uniquely chased.

Minister and Mme. Quesada gave eight pieces of silver, gold lined, and repoussé work in the fleur de lis pattern. Each piece is marked with the monogram of the bride, "A. L. R." Mr. Grip, the Swedish Minister, sent the bride a vase.

Members of the Taft party who visited the Orient last Summer presented a necklace and pendant comprising 18 large and 120 small diamonds set in platinum. The large aquamarine is of a bluish-green tint and is cut in a heart shape. This is said to be one of the finest stones of the class in the country.

The gift of the New York delegation in the House of Representatives, including all of the Republican members and four Democrats, Messrs. Sulzer, Towne, Cockran and Goulden, was a set of glass ware in colors. In the set are five dozen wine glasses and a dozen plates to hold as many finger bowls. There are a dozen champagne glasses, a dozen for port, another dozen for claret, as many for hock and 12 for cordials. The glasses are of special design, and every effort was made to turn out a perfect product in each case. The glasses, plates and finger bowls were all in a large white ease lined with white silk. No two pieces are alike.

Members of the Congressional Committee on Foreign Relations presented a loving cup designed by the Gorham Mfg. Co. The cup is of sterling silver and stands 13½ inches in height. It has a capacity of seven and one-half pints, is round and has the regulation three handles. About the rim of the cup is an acanthus leaf border and the handles are beaded on either side. A clover leaf design is arranged about the bowl near the base, and the standard is beaded and chased.

Ten watches and nearly 50 clocks were received, so that there is no reason why the young couple should not know the time of day. The clocks come in almost every variety, from carved wood Swiss timepieces to a French gold clock set with diamonds, the gift of the French Ambassador and Mme. Jüsserand. There is a watch of green enamel with emeralds as a centerpiece. Another watch is ornamented with blue sapphires and diamonds, and a third with turquoise and pearls.

One of the parasols made as a part of the trousseau had a frame of hardened gold and a handle of white enamel topped with rock crystal four inches long. Three others have jeweled handles. One is in a cream-colored enamel ending in a large pigeon-blood ruby, surrounded by diamonds and with a circlet of small pearls at the bottom.

Chas. G. Bruffee, who was arrested a short time ago on a charge of breaking and entering the store of E. A. Whipple & Sons, Springfield, Mass., and stealing five pairs of opera glasses and two telescopes, pleaded not guilty when arraigned in the local police court about a week ago.

**Magnificent Candle-sticks for Cathedral of SS. Peter and Paul, Indianapolis.**

SIX magnificent candle-sticks, one of which is shown in the illustration, on this page, have recently been completed for the Catholic Cathedral of SS. Peter and Paul, a new edifice in Indianapolis, Ind. These candle holders, which are to be placed upon the main altar, are five feet in height and are made of bronze, heavily plated with gold.

The design, drawn by Wm. Renwick,



MAGNIFICENT CANDLE-STICK FOR CATHEDRAL SS. PETER AND PAUL.

a New York architect, is in the style of the Italian renaissance and calls for much elaborate molding. At the base of each candle-stick, on each of the four sides, is a cherub in relief.

The candle sticks were made at the bronze works of the Gorham Mfg. Co., in Providence, R. I., under the supervision of A. A. Buck.

Branch No. 7, Brotherhood of Silver Workers, held its second annual ball at Trainmen's Hall a short time ago. There was an unusually large attendance.



**CHINA BERRY SETS IN PRETTY EFFECTS.**

**A**MONG the line of china for which Bawo & Dotter, 26 Barclay St., New

York, have experienced a lively demand within a few weeks were the strawberry sets on which the representation of the berries was so realistic that one would readily imagine that the luscious fruit was lying on the dishes, instead of being shown in a painted picture. There are also being shown many berry sets in which roses were painted against a graduated brown tint, with a gold line encircling the outside edge of each piece. Berry dishes and salad sets are also shown with painting representing ideal heads. These pieces represent the latest progress in decalcomanie transfer work, and the unpracticed eye would see no difference between these transfers and genuine paintings. The heads are in multi-color effects, offset with a deep green or brown shaded background, and edged with a border of gold lace, while the rim of each piece is of gold. A pretty assortment of tea cups is from the company's Carlsbad works, showing mythological scenes, true to original paintings, placed on the panels. The cups are thin and graceful in form, with gold lace edging and rich gold handles.

**NOVELTIES IN ROYAL DOULTON.**

**I**N the new sales-rooms of William S. Pitcairn, 44 Murray St., buyers will be

pleased to note the increased facilities for the display of Royal Doulton china and earthen ware in staple lines and novelties. The entire four-story building, except the ground floor, has been leased by Mr. Pitcairn. There has recently been received quite a large number of handsome rail plates for mantel and walls. The centers are painted by well known artists, the subjects ranging from fish and game to flowers and even landscapes. Another attractive line is the Capo di Monte style, ornamented with hunting scenes modeled in relief and painted in colors. This collection includes many pretty vases, tea sets, tobacco jars, candlesticks, claret jugs and mugs. In the earthen ware department the "friar" groups continue prominent, having received a number of accessions, showing the latest fancies of the artists who have been treating this series of subjects. The ware comes in brown background, decorated in black. In another collection the artists have given their attention to automobile subjects, and the result is altogether satisfactory. The scenes are characteristic of the sport and are painted in the brightest of hues. This line of earthen ware includes special pieces, plates, jugs, vases and tankards.

THE RAMBLER.

New Designs

# Vanity Bags

Best Fittings



Vanity Bag 7545 S. C.

We have a choice collection for fine jewelry trade.

SEND FOR ILLUSTRATIONS

**C. F. RUMPP & SONS**  
Fine Leather Goods  
**PHILADELPHIA**

New York Salesroom: 683 and 685 Broadway



Vanity Bag 7546 S. L.

## EVERY SMOKER WANTS ONE

The most useful pocket lighter ever invented. Throw away your matches. The "Instanto" produces a steady flame, without matches, by simply removing the cover, as shown in illustration. Lights a cigar, gas jet, kindles a fire, or shows the way in the dark. Useful every day and night of the year.



Pat. June 27, '05

## The "Instanto" Pocket Cigar Lighter

("Instanto")  
(Trade Mark)

**IGNITED BY AIR**

("Instanto")  
(Trade Mark)

Will not ignite unless exposed to the air. Absolutely safe. Always dependable. Conveniently carried in the vest pocket. With ordinary care is practically indestructible. Sterling Silver, Solid Gold and Gold-filled. Special prices upon application.

The Public and Trade are cautioned against purchasing other Cigar Lighters of a similar nature.

The Jewelry Trade, Wholesale and Retail, will find the "Instanto" an unusually good seller, as it is extensively advertised in all the leading magazines.

**G. L. STEINREICH & CO.,**

190-196 West Broadway, New York

1/2 size.



*Abe Fassel*

MANUFACTURERS OF  
**FINE CASES**  
OR  
JEWELRY AND  
SILVERWARE

TRAYS FOR TRAVELERS  
FINE VELVET AND LEATHER NOVELTIES

671-673-675 HUDSON ST.  
HERRING BUILDING  
NEW YORK.

### Expert WATCH and Chronometer REPAIRING FOR THE TRADE.

When others fail you we guarantee satisfaction. A trial will convince. Prices very reasonable.

List will be sent on request.

**G. OHAN, 37-39 Maiden Lane, Lorsch Bldg., Room 27. NEW YORK.**

### "Perfect Yourself"

in ENGRAVING and EXPERT WATCH WORK. Take a Post-Graduate Course.

**RIES & ARMSTRONG, Macon, Ga.**

### Encyclopedia-Dictionary

and reference hand-book of the Ophthalmic Sciences. Price, \$2.50.

The Jewelers' Circular Pub. Co., 11 John St., N. Y.

## E. H. H. SMITH SILVER CO.

BRIDGEPORT, CONN.

Silversmiths' Building,  
CHICAGO, ILL.

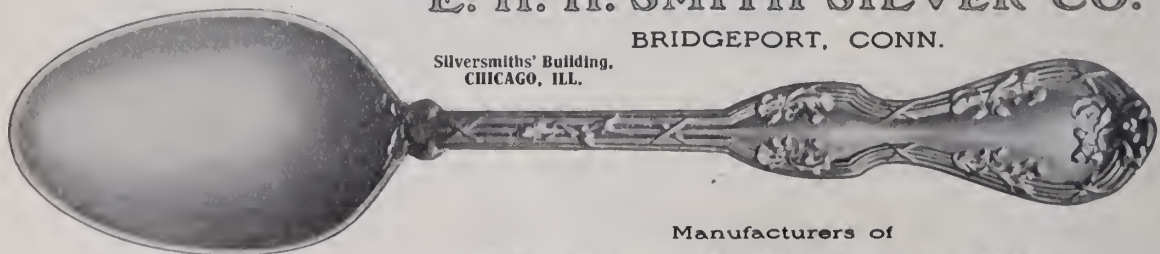

THE OAK.

Manufacturers of

**Sterling Effects in Plate**

**PLATINUM** **AMERICAN PLATINUM WORKS**  
NEW YORK OFFICE 41 Cortlandt Street **NEWARK, N. J.**



## These High-Grade Combs

and many others are included in our

**\$25.00**

Sample Assortment



No, you mustn't jump at the conclusion that, because our prices are way down, our goods are not suitable for good trade. In putting up this Sample Assortment we have aimed at—and accomplished—3 things—

- 1.—To give a representative line of high-grade Combs at an acceptable figure—from your point of view.
- 2.—To prove that the designs and patterns in the "Checo" Line please the large majority of ladies and misses.
- 3.—To show you the profit possibilities of a good Comb assortment.

**NOW,** if you send for this trial assortment of Combs, you are not obliged to keep them if unsatisfactory. Send them back—that's all. We'll give you a square deal—guarantee satisfaction or money back. Same way with our



### \$15 BRACELET ASSORTMENT

which includes a splendid range of attractive, well-made and quick-selling designs. You can order this assortment, and return any or all that don't satisfy you.

**C. H. EDEN CO.**  
ATTLEBORO, MASS.

New York Office - - 699 Broadway.  
Largest Manufacturers of Combs, Hair Ornaments and Inexpensive Jewelry in America.



## SIGNS

**A**N attractive front is a business necessity. Artistic signs are an important adjunct. We make the right kind.

"No trouble to ship out of town."

**THE FORMAN CO.**  
SIX LIBERTY PLACE  
NEAR MAIDEN LANE - - NEW YORK

**Trade-Marks** of the Jewelry and Kindred Trades.  
Second Edition. Price, \$3.00. The Jewelers' Circular Publishing Co., 11 John St., New York.

## REMOVAL NOTICE

We now occupy the new store of

**The Lorsch Building, 35 Maiden Lane, N. Y.**

## WOLFSHEIM & SACHS

MAKERS OF

Fine Boxes, Trays and Novelties for Jewelers and Silversmiths

**35 MAIDEN LANE, N. Y.**

Telephone, 3518 John.

*Mercantile Fountain Pen*

## The Best Self-Filling Attachment

made and guaranteed by

**AIKIN, LAMBERT & CO.,** 19 Maiden Lane, NEW YORK.

Retail Price:

**\$3.00**

**\$3.50**

**\$4.50**

Send for Price Lists and Discounts.



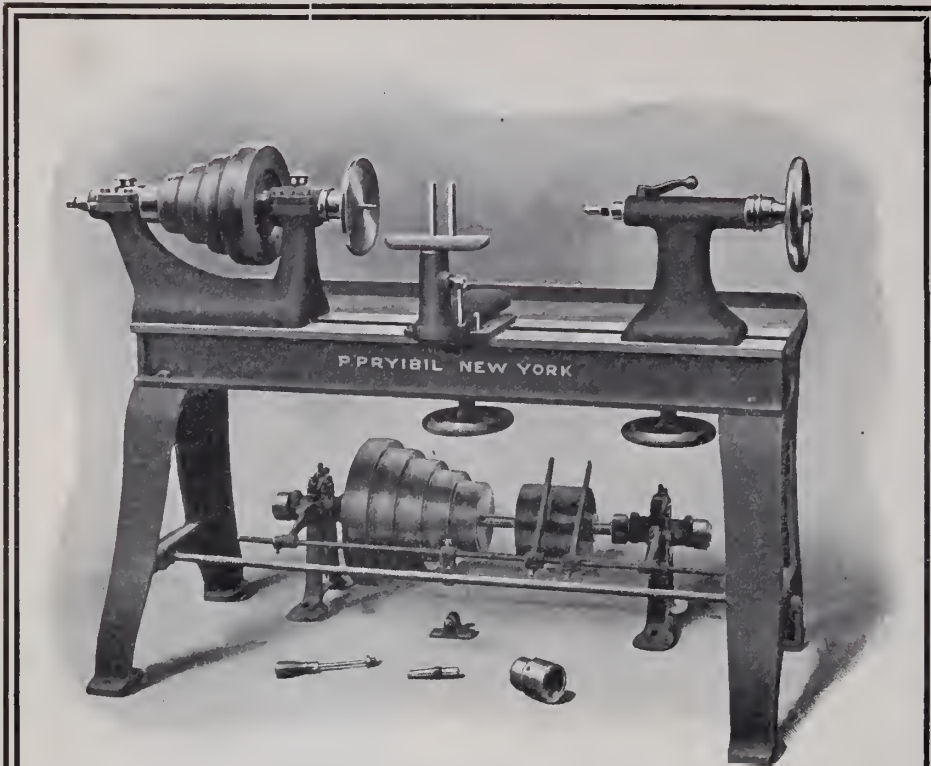

Above Cut Shows Our

## METAL SPINNING LATHE

We manufacture these lathes in sizes from 12-inch to 44-inch Swing, and can equip sizes 18-inch and larger with our Chucks for oval work.

Write for Catalogue

**P. PRYIBIL, 512-524 W. 41st St., New York.**

**MERIT:—**

**DISPATCH:—**

Two of the many pertinent factors that make us excel.

### CONLEY & STRAIGHT,

Gold and Silver Refiners,  
Assayers and Sweep Smelters,

236 EDDY STREET, - PROVIDENCE, R. I.

Dealers in Fine Gold,  
Silver and Copper.

All kinds of Gold  
and Silver Anodes.

### Automatic Bright Annealing Furnace

Bates & Peard Patent, Birmingham, Eng.

For Manufacturing Jewelers and Silver-smiths and Watch Case Makers.  
Free from Oxides or Scale.

Illustrated Catalogue by

C. M. DALLY, Agent, 29 Broadway, N. Y.

Mention this paper.

### CASTINGS

Gold, Silver, Bronze, Brass,  
German silver, Copper & Iron,  
Supply Jewelers, Silversmiths,  
Die-makers, Mould-makers, etc.

L. D. Tel. 2072 L.

Unbreakable Bronze Forces. Hard Bronze Engraving Plates. Cast Iron Forces for making Steel Dies.

Chandler, Undercut Work, Statuary.  
AUGUST GRIFFOUL, 313 HALSEY STREET,  
NEWARK, N. J.

## WM. F. RENZIEHAUSEN CO., GOLD and SILVER REFINERS

Sweep Smelters, Assayers and Analytical Chemists

Rolling of FINE AND STERLING SILVER a Specialty.

Long Distance Telephone, 3759-R.

45-49 Oliver Street, NEWARK, N. J.

## JOHN S. STIVEN, Gold and Silver Chaser.

Room 219, Electrical Exchange Building.

156 LIBERTY STREET. NEW YORK.

**EVERY REPAIRER** should have a copy of "THE JEWELRY REPAIRER'S HAND BOOK." The Jewelers' Circular Publishing Co. Price, 75 cents.



### WE BUY

Old Gold and Silver Filings, Polishings, Sweeps, Hand Washings, etc. We will make accurate valuations and hold consignment subject to your acceptance. If valuation is not satisfactory, we reship to you at our expense.

**WE PAY FOR OLD GOLD:**

22 K. 88c. per dwt.	12 K. 48c. per dwt.
20 K. 80c. " "	10 K. 40c. " "
18 K. 72c. " "	8 K. 32c. " "
16 K. 64c. " "	6 K. 24c. " "
14 K. 56c. " "	4 K. 16c. " "

MARKET RATES FOR SILVER AND PLATINUM.

Try us and you will appreciate our Squareness, Promptness and Accuracy.

**T. B. HAGSTOZ, Ltd.,** Main Office, 709 Sansom St., Philadelphia, Pa.  
SMELTERS, ASSAYERS, REFINERS.

### WE SELL

Gold, Silver and Platinum, various qualities, rolled flat or drawn to wire of any gage.

**PRICES OF ALLOYED GOLD:**

10 K. 48c. per dwt.	14 K. 64c. per dwt.
12 K. 56c. " "	16 K. 72c. " "
18 K. 80c. per dwt.	

Gold and Silver Solder, either from formulas furnished or our own. "T. B. H." Alloy, 25c. per oz. Guinea Gold, 75c. per lb. Shot Copper, 40c. per lb. We will send tables for alloying without charge. They save figuring.

## DIAMOND POINT FOUNTAIN PENS



No. 2WC \$7.50 per dozen. Guarantee in every box.

Largest Manufacturers of Popular Price Fountain Pens in the United States.

Send for Illustrated price list of 14 Kt. Gold Fountain Pens.

Good case assortment 1 dozen pens, \$9.00.

**DIAMOND POINT PEN CO.**

100-102 Beckman Street, New York





P 2719



P 2792

## Fahys Permanent Filled Case.

Fahys Permanent Gold Filled Cases have more gold value than any other filled case on the market at the same price.

They have solid gold joints and solid gold French bows; French bows are stronger as well as more artistic.



P 2794

There is nothing made in a gold filled case to compare with this case.



P 2725

JOSEPH FAHYS & CO.

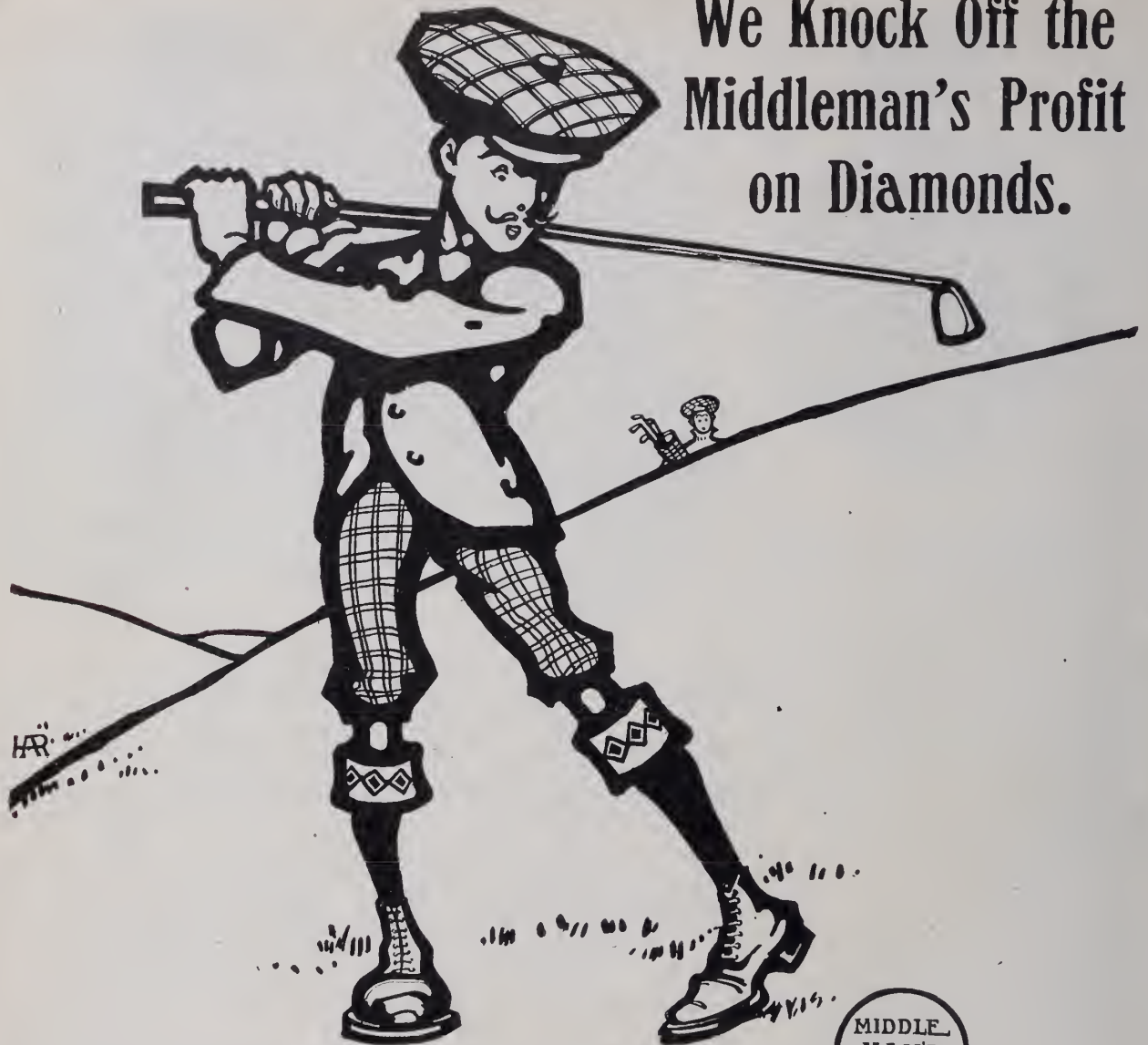

We Knock Off the  
Middleman's Profit  
on Diamonds.

Fact I.—We cut our own diamonds in our own factory.

Fact II.—We employ no salesmen.

Fact III.—We sell direct to the retail dealer.

Either, then, we make a 3-fold profit or we sell for lower prices. An easy way to prove whether the former or latter is true, is to send to us for a selection package and compare our prices with others' the next time you want any diamonds.

Buy direct from the cutter and you'll never fizzle on a sale.



**J. R. WOOD & SONS,**

DIAMOND CUTTERS,

No. 2 Maiden Lane,

New York.



They will come to you for their wedding ring.  
Sell them the best wedding ring in the market.  
A ring you can unconditionally guarantee to be  
exactly what it is represented to be.

A ring of our manufacture. With all its excel-  
lence it costs no more than inferior ones.

**J. R. WOOD & SONS,**

RING MAKERS,

2 Maiden Lane,

New York.

# We Have Doubled our Line for the Fall Trade

in Vest Chains, Guard Chains, Fobs, Locketts, Grand Paris, etc., coupled with a large number of new ideas which we will not dwell upon at this time. When you see our line you will wonder at our new creations, and it will bother you to know how we can give you so much for the money. Don't mention it to anyone.

## Design, Workmanship, Quality and Durability

are the four factors which have made the

# BIGNEY CHAINS

the most popular in the market to-day. They are handled and worn by more people than any other make.

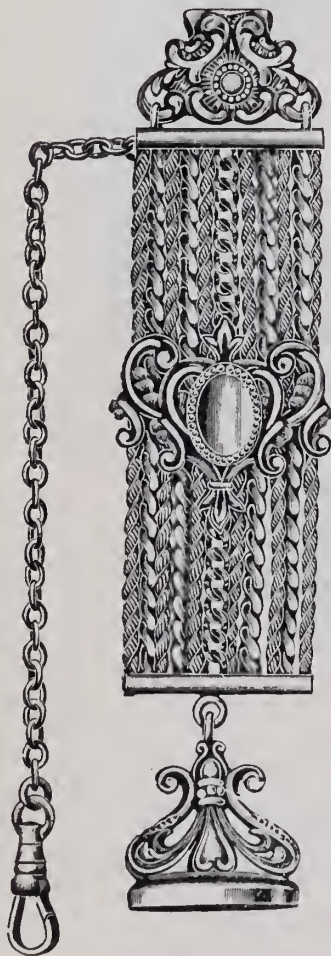

# S. O. Bigney & Co.

NEW YORK OFFICE,  
3 MAIDEN LANE.

FACTORY, Attleboro, Mass.

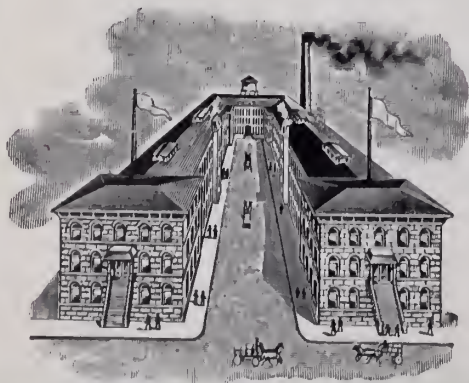



YOU  
 CAN SECURE THAT  
 CLASS PIN ORDER  
 BY SHOWING



OUR DESIGNS AND SAMPLES.



WE ARE HEADQUARTERS.



WRITE TO EITHER FACTORY.



WENDELL & COMPANY,



103 AND 105 WILLIAM ST.,



NEW YORK.

57 WASHINGTON ST.,



CHICAGO.



---

## A Watch Case That Will Answer.

---

**W**HAT VIRTUES do you look for in a 20-year Watch Case, what degree of wear, finish, beauty? Set your own standard, and don't be afraid of setting it too high. The

# WADSWORTH

(Warranted)

# TWENTY-YEAR

Watch Case can answer for itself, surpassing expectations, more than meeting every reasonable demand and requirement.

Popular because good; economical because reasonable in price but high in merit.

---

### *The* Wadsworth Watch Case Co.

CHICAGO  
Columbus Building

SAN FRANCISCO  
717 Market St.

NEW YORK  
49 Maiden Lane

FACTORY, DAYTON, KY.

---

---

---

## The Thinnest and Most Compact Models,

Handsome Designs, Perfect Workmanship  
and Reliable Quality.

# WADSWORTH

Gold and Gold Filled

# WATCH CASES

Represent the Highest Art in American  
Case-Making.

Ask your Jobber for them.

---

### *The* Wadsworth Watch Case Co.

CHICAGO  
Columbus Building

SAN FRANCISCO  
717 Market St.

NEW YORK  
49 Maiden Lane

FACTORY, DAYTON, KY.

---

---

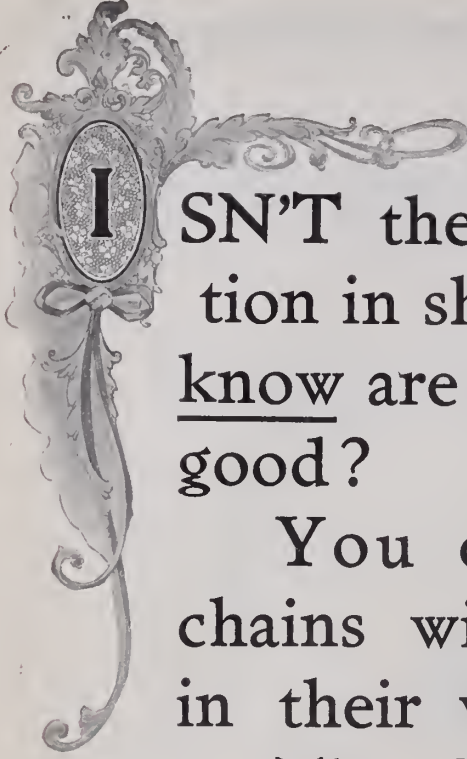

---

**I**SN'T there a deal of satisfac-  
tion in showing goods that you  
know are solidly and uniformly  
good?

You can show Simmons  
chains with entire confidence  
in their worth and reliability.

The Simmons line is good  
all through; every chain can  
be depended upon to make  
good; every link measures up  
to the Simmons standard of  
quality and dependability.

---

**R. F. SIMMONS COMPANY**  
Main Office and Works, Attleboro, Mass.

SALESROOMS, 9-13 MAIDEN LANE, NEW YORK, 42 MADISON STREET (HEYWORTH BUILDING), CHICAGO

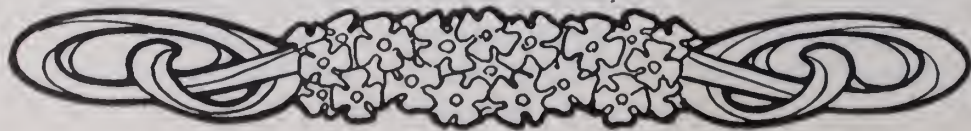





**A**MONG the various historical styles of decoration suitable for silverware, none has attained a more lasting popularity than that associated with the name of Louis XIV of France, le Grand Monarque. ¶ It is for this reason that the Whiting Company have decided to introduce a novel and original treatment of this favorite form of French Renaissance applied to a very complete line of Hollow Ware, characteristic examples of which will be here shown from time to time.



**WHITING MFG. CO., SILVERSMITHS**

Broadway and 19th Street, New York.

# **Profit and Prestige**

**is a combination**

to gain and maintain.

Every

**Retail Jeweler**

can earn it by selling

## **Dueber-Hampden Watches**

The Best American Watch.

Sold on its reputation and merit.

**The W. J. JOHNSTON COMPANY,**

Wholesale Agents of the Leading American Watch Companies,

**Fifth Avenue and Market Street, Pittsburgh, Pa.**

## The Greatest Recommendation

ever given to

# Illinois Watches and Hamilton Watches

was, by their greatest rival in the Watch Business, in these few words: **"They have robbed us of our Railroad Watch Business."**

The conclusion is clear, but the statement is ambiguous.

**The Railroad Watches most in demand are the Watches that are the best for the purpose, and it is an indisputable fact that the**

**Most Reliable Railroad Watches in the World  
are the Illinois and Hamilton Watches.**

**The W. J. JOHNSTON COMPANY,**

Wholesale Agents of the Leading American Watch Companies,

**Fifth Avenue and Market Street, Pittsburgh, Pa.**

# STERN BROS & CO



## STYLE

Style is a most important factor in diamond mountings.  
 Our large line of diamond mountings show correct style and perfect finish.  
 As we are importers and cutters of rough diamonds, we have exceptional facilities for selling.

**DIAMOND JEWELRY AT POPULAR PRICES**

**STERN BROS. & CO., 33-43 Gold Street, New York**  
 MANUFACTURERS TO THE JOBBING TRADE EXCLUSIVELY

Salesroom and Offices,  
 Diamond Department:  
 68 Nassau Street, New York

Diamond Cutting Works:  
 142 West 14th Street, New York

Branch Offices:  
 103 State Street, Chicago, Ill.  
 29 Ely Place, London  
 12 Tulp Straat, Amsterdam



GREAT MANY of the leading jewelers of America are pushing the sale of *ILLINOIS WATCHES* because of their superior quality.

If you are not entirely satisfied with the line of watches you have been selling, we would be glad to have you try a few of our manufacture.

We are sure you will find them satisfactory in every way and of greater value than comparative grades of other makes.

If your jobber does not carry them, write us for price list and discounts.

# Illinois Watch Company

## SPRINGFIELD.

Retail selling prices of  
Railroad grades established  
and maintained.



## THE STURDY BRACELET.

The Original Secret Lock and Joint Bracelet. Patented Feb. 28 and July 4, 1905. Made in 14k. Gold Filled. Also in 10k. and 14k. Gold. Plain, Chased and Stone Sets by



### J. F. STURDY'S SONS,

Makers of the Sturdy Line of  
Standard Watch Chains.

MAIN OFFICE AND WORKS,  
ATTLEBORO FALLS, MASS.

SALESROOMS :  
7 MAIDEN LANE, NEW YORK.  
713 MARKET ST., SAN FRANCISCO.

Established 1865.

*"We never follow the Fashion, the Fashions Follow Us."*

MAURICE L. POWERS.



JOSH W. MAYER.

## Special Announcement.

OUR MR. MAURICE L. POWERS and MR. JOSH W. MAYER have returned from abroad after spending considerable time in purchasing large lots of Diamonds, Pearls, Emeralds, Rubies, Sapphires and other precious stones. Many of these stones have been specially selected and cut to order for goods to be used in the productions for our coming exhibition. It is impossible to enumerate the choice quantity and quality of these importations.

Our Designers have lately returned from the foreign countries, after securing the newest and most desirable effects for the coming season's wear. These will harmonize perfectly with the stones procured by this firm.

On account of the unusual number of requests from Jewelers all over the country, who found it impracticable to visit our former exhibitions, we have changed the date for this coming display, to be held in our offices, to August 13th-18th inclusive.

Once a visit always a visit.

### POWERS and MAYER,

Makers of Diamond Mounted Jewels THAT SELL,

258-260 Fifth Avenue,

NEW YORK.

We are always pleased to ship goods on memorandum when satisfactory references are given.



No. 929.

The New

4 IN ONE

ASH-RECEIVER  
FOR SMOKERS

This cut represents the Four-in-one Ash-receiver with parts separated. When the parts are nested, one complete ash-receiver is formed. It is especially adapted for a party of gentlemen who require more than one ash-receiver. Made in Brass, Nickel-plate, Copper and Silver-plate. Our catalogue of Smoking Articles sent on request.

New York Showrooms:

Park Place, cor. Broadway,  
Opposite Post Office.

S. STERNAU & CO.

Makers of Coffee Machines, Chafing Dishes and  
Their Accessories, Fancy Kettles, Trays,  
Smoking Sets, etc.

Office and Factory:

195 Plymouth Street,  
Brooklyn, N. Y.



**NORMA**  
TRADE MARK

Plain and Chased Link, Bright Finish.  
It fits the wrist with a velvet-easy  
grasp. No stiff spring but a flexible  
bracelet, and the most comfortable  
of any.

No. 253.

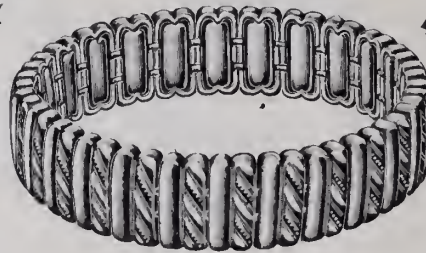

**NORMA**  
TRADE MARK

These bracelets may also be had with  
stone (close set, Rose, Amethyst,  
Sapphire, or Aquamarine), signet  
and locket ornaments.  
The jobbing trade can depend upon  
its possessing the most merit at  
the least price.

THE NEW

**NORMA** Patented **ADJUSTABLE BRACELETS**

(Quality Guaranteed)

ARE SOLD AT POPULAR PRICES RANGING FROM

**\$16.50 to \$36.00 per dozen**

Send for our new illustrated booklet of patterns and prices.

Made only by **The F. H. SADLER CO.**, 80 County St., ATTLEBORO, MASS.

NEW YORK OFFICE: 180 BROADWAY, Room 43

Address all communications to Attleboro, Mass.



We Make

# BRACELETS

both in Joint and Nethersole — with and without stones.  
Call on us for the P. & B. Co. lines of

FOBS, LOCKETS,  
TIE CLASPS, BROOCHES,  
SCARF PINS,  
HAT PINS.



BABY PINS, BEAD NECKS,  
CUFF BUTTONS,  
CROSSES, BRACELETS,  
AND WAIST SETS,



Potter  
&  
Buffinton  
Co.,

Providence,  
R. I.

NEW YORK OFFICE,  
65 Nassau Street.

San Francisco Office,  
206 Kearny Street.



5425

5400

8269

5423



# Tortone Combs

IN ENDLESS STYLES.

There has been an avalanche of orders. The selling has been tremendous among the jewelers handling our **Tortone Shell Combs**.

**Tortone Shell Combs** are a trade attraction and a sales factor, besides being the nearest like tortoise shell of any comb manufactured. They'll increase the sales of your shell goods department.

Order a few of the styles illustrated and let us add a small assortment of the latest creations. You will be agreeably surprised at the matchless values and distinctiveness of the designs.

Mounted combs are just as appropriate for gifts as jewelry and silver.

**TERMS**—2 per cent. 10 days; 30 days extra.

Mail your order to-day.

## E. & J. BASS,

MAKERS OF TORTONE HAIR ORNAMENTS,

573-575 Broadway, New York.

5425—Leaf design, rose-gold finish, set with rhine stones and four large stones, all delicate shades; *per dozen, \$12.00.*

5400—Fancy art silver mounting set with fourteen rhine stones; *per dozen, \$8.50.*

8269—Floral pattern, rose-gold finish, set with four pearls and one large stone, in center. All colors; *per dozen, \$4.00.*

5423—Lily design, rose-gold finish, set with eight rhine stones and colored stone center; *per doz. \$6.00.*

Combs can be had in shell or amber—shell will be sent unless otherwise specified.

**We make back and side combs with gold plated borders, plain and beaded, at \$4.00 per dozen up.**



# THE Bracelet Hit OF THE Season.

THE illustrations, which are exact size, show two of the best selling Bracelets of a big bracelet season.

Made of Rolled Plate, Pierced, Engraved—a neat, strong joint and catch—with and without stones, from ½ to 1¼ inches wide.

Our line offers an unsurpassed range of styles.

ASK YOUR JOBBER—HE HAS THEM.

**WHITING & DAVIS, Plainville, Mass.**  
NEW YORK OFFICE, 7 MAIDEN LANE.

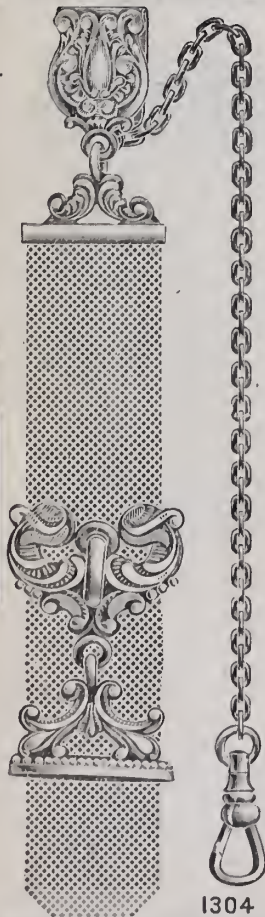

1304

# BATES & BACON,

ATTLEBORO, MASS.

Makers of

HIGH GRADE CHAINS.

The BEST SAFETY FOB is one of our specialties; Gent's Vests, Dickens, Lorgnettes, Secret Locket Chains, Locketts, Chate-laines, and the unexcelled

## "Bates" Bracelet

"KANT-KUM-OFF"

We make these Bracelets in

### Seven Sizes.

Just on the market—A New Flat Seamless Wire Bracelet, made with the "WINNA" Joint and Catch. Patented.

Ask your jobbers for OUR GOODS.

New York Office, 9 Maiden Lane.  
Chicago Office, 103 State Street.

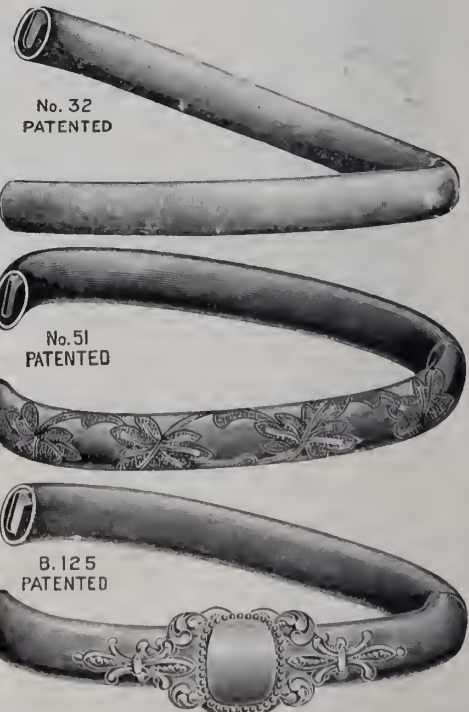

# ZIMMERMAN'S ELK MASTERPIECE.

Ever on the alert to improve our already most popular line of Elk emblems, we have added what we consider the most wonderful reproduction of an Elk head in gold ever attempted. This is known as the Zimmerman Masterpiece of an Elk.



This Elk head is an exact reproduction in gold of Zimmerman's masterpiece, "The Elk," which is world famous, having received prizes at every exhibition where shown. Every line in the painting has been faithfully reproduced by us in the emblem.

We are making this head in two sizes (medium and small), in both gold and silver, and in various finishes, also combining it with the dial, with and without diamonds and other precious stones. If your jobber does not handle our line, send for a selection package. Our Phenomenal success has inspired many imitations. There is but one line of FOX Emblems, and all goods of our make are stamped with this trade-mark:  A quantity or low price may sell the first bill, but quality as well is required to get succeeding orders. Our goods are of the highest standard of quality.

## THE GUSTAVE FOX CO.,

14-16 East Fourth Street, Cincinnati, Ohio.

Branches in Antwerp and Oakland, Calif. (Temporarily).

# Bastian's Class Pins and Badges

When you handle Bastian Bros' Class Pins and Badges, you handle goods that are known to every intelligent person wherever English is spoken. We have advertised extensively and persistently in Leading Magazines until the name of Bastian bears the same relation to class pins that the name Elgin does to a watch.

No other manufacturer can meet our prices—it is an impossibility for him to do so—because we own the only patented process whereby one girl with one machine can do the work of six skilled workmen.

Note these Prices:

Silver-Plated Pins, per doz.,	\$1.00
Sterling Silver Pins, "	2.50
Gold Plate . . . . .	3.00
Solid Gold . . . . .	15.00

### 25% Discount to Retailers

Silver-Plated Pins retail at 10 cents and Sterling Silver at 25 cents. They are finely made of heavy metal, and on the Sterling Silver Pins the best French enamel is used.

We also make to order Badges, Medals and Buttons in either Gold, Silver, Bronze or Ribbon, and we rigidly guarantee everything we make.



16



17



3002



149



192



19



7



89



21



8178



60



73



11



98



58



59



90



93



71

OUR HANDSOME NEW CATALOGUE IS FREE TO JEWELERS.  
**BASTIAN BROS.,** N. 21 South Avenue,  
 ROCHESTER, N. Y.

# FANS FOR GRADUATION, WEDDINGS, CONFIRMATION.

HEADQUARTERS FOR THE MOST EXCLUSIVE LINE IN THIS COUNTRY.



Similar goods are not obtainable elsewhere.

They are of original design and my own creation.

## NECKLACES

IMITATION PEARL AND FANCY BEAD, IN ALL NEWEST SHADES AND EXQUISITE COLORINGS.

Samples of Fans and Necklaces sent on request.

### LOUIS STEINER, Importer,

520 and 522 BROADWAY, NEW YORK.

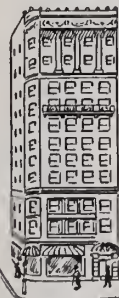

NEW YORK OFFICE  
826 FIFTH AVE. COR 329 ST  
IN THE "NEW WHOLESALE DISTRICT"

Our New Line for the Coming Season is NOW READY.

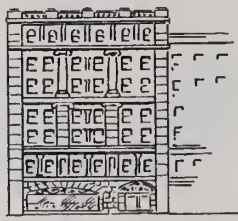

REMOVED FROM  
25 MAIDEN LANE

## 2 Moves May 1, 1906.



NEWARK N. J.

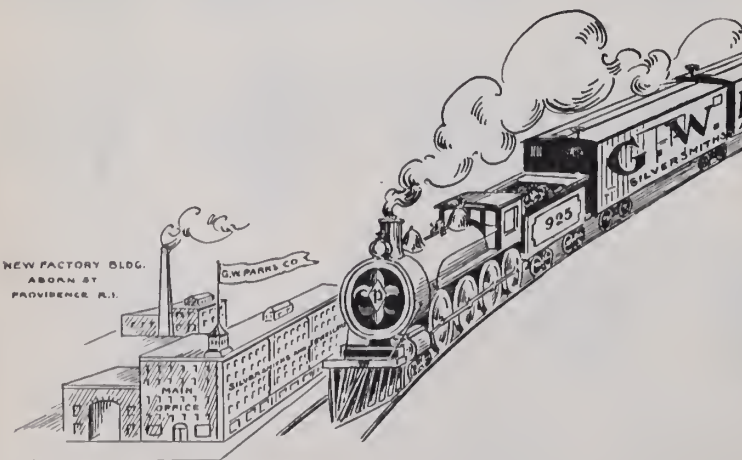

This illustration shows our double move.  
MAIN OFFICE AND WORKS FROM NEWARK, N. J.  
TO PROVIDENCE, R. I.

NEW YORK OFFICE FROM MAIDEN LANE,  
To "The New Uptown Wholesale District"

## G. W. PARKS CO.

Makers of Sterling Silver Wares.  
PROVIDENCE, R. I.

GOLD  
RINGS

BROOCHES AND MOUNTINGS

Also GOLD FILLED RINGS, including the popular THREE CROWN

Ostby & Barton Company respectfully announce to the jobbing trade that their fall line comprising many new and original designs is now ready.

OSTBY & BARTON COMPANY

New York, 13 Maiden Lane  
Chicago, 103 State Street

PROVIDENCE, R. I.



**W**E have kept all the little Brownies busy and some big ones too, and now we are pretty comfortably installed on the twelfth floor of the "Cockcroft Building," Corner Nassau and John Streets. We never were in such shape to hustle out your orders. Send them in and watch the result, or come up to the office and let us show you.

**HENRY FREUND & BRO.,**

Cockcroft Building, 71 Nassau St., cor. John St., NEW YORK.

Elk and F. O. Eagle Goods  
a Specialty.



"Sellers of Sellers."

# The Allsopp Rings

THE UP-TO-DATE LINE OF  
**SIGNET AND SET RINGS**



In twenty years we have built up a business second to none in Rings exclusively. ALLSOPP QUALITY, DESIGN and WORKMANSHIP appeal to the most fastidious. It will pay you to examine a selection package.

**A ★**  
TRADE-MARK.

**ALLSOPP BROS., ALLSOPP BUILDING, Newark, N. J.**



## BRACELETS

Carved,  
Engraved,  
Plain or  
Mounted.

**C. P. GOLDSMITH & CO.,**  
33-43 Gold Street,  
NEW YORK.



Everything New Under the Sun  
IN MODERN JEWELRY  
OF EVERY DESCRIPTION

## Signet Rings

(OUR OWN MAKE)

**A SPECIALTY.**

We Solicit Memorandum Orders.

**L. Witsenhausen**

**47-49 Maiden Lane,  
New York.**

Manufacturers of **MODERN JEWELRY**  
Chicago, 405 Masonic Temple.  
(L. KATLINSKY.)



**"GRIP"**  
The King of all card games, price 25c.; sample pack 16c., two 30c., eight \$1.00. Sent prepaid at once (only on receipt of price). See last week's issue of Circular for prices of my Ring Adjusters which every jeweler should have in stock. Order 1 doz. asst. Enclose the amount. Mention order No. J and I will forward a sample pack of Grip extra. Order them to-day.

**CHESTER H. WELLS, Jeweler, Meshoppen, Pa.**

# The Bowden Rings

ARE COMPLETE IN VARIETY, CORRECT IN  
QUALITY AND PERFECT IN FINISH. WE  
MAKE EVERY VARIETY OF FINGER RINGS.

**J. B. BOWDEN & CO.,**

1 Maiden Lane.

NEW YORK.

# AMERICAN CHURCHES

REPRESENTED IN OUR SOUVENIR GOODS.



**A** NATION'S CHURCHES are among its most interesting institutions. In addition to their deep religious and social significance, their ecclesiastical architecture often possesses features of great beauty; and a wealth of intimate associations clusters about such edifices.

THE CUT SHOWS TRINITY CHURCH, BOSTON, IDENTIFIED WITH THE FAME OF ITS GREAT PASTOR, THE LATE PHILLIPS BROOKS. THE STRUCTURE IS REGARDED AS THE MASTERPIECE OF RICHARDSON, AMERICA'S MOST NOTED ARCHITECT.

Our Souvenirs represent this and many other interesting Churches, including Old Swede's Church, Wilmington, Del.; St. Paul's Church, Norfolk; St. Louis Cathedral, New Orleans; the Mormon's Temple, Salt Lake; the Cathedral, City of Mexico, etc.

## K. & O. Co.

MFRS  OF

Britannia Novelties, Hollow Ware Copper and Fancy Metal Goods.

Salesroom 425 Broadway, NEW YORK, N.Y. | Office & Factory 366-388 Butler St. BROOKLYN, N.Y.



SOME MORE SOLID GOLD BARRETTEs.



These designs are absolutely original, made in 10K. gold, and characteristic of first class workmanship. Fashion dictates the use of the BARRETTE for artistic hair treatment where refined taste is concerned. They are lively sellers and profitable to handle. Write us for prices.

## SCHULTZ, LEISS & CO.

OFFICES:

14 John Street, New York. 103 State Street, Chicago.

FACTORY:

Cor. Oliver and McWhorter Streets, Newark, N. J.

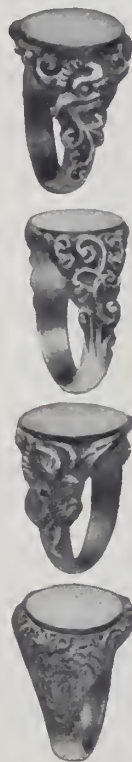

Quality and Finish Consistent With Twenty Years' Experience



Original and Exclusive Designs

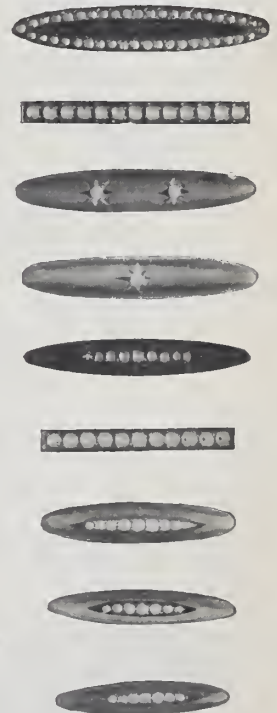

## MOORE & SON,

NEWARK, N. J.

ESTABLISHED 1886.

INCORPORATED 1903.

## Expert Workmanship in Lorgnettes.



EXPERIENTIA  
DOCET

Chains to Accompany Lorgnettes.

THE fitness of things is carefully regarded in the Chains we make to go with our Lorgnettes. Each has its appropriate Chain, one supplementing the other beautifully. Two sales instead of one, where shown.

PRICES: \$30.00 to \$300.00



EXPERIENTIA  
DOCET

**Durand & Company,**

49-51 Franklin Street,  
Newark, N. J.

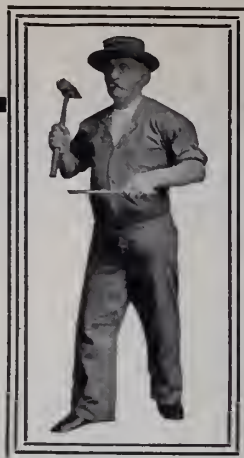

## SOLID GOLD CHAINS

The selling price of our goods is based on the cost of honest materials, plus the cost of the very best workmanship it is possible to procure. The usual large selling cost is absolutely eliminated—we have no salesmen. You get the benefit of this system of honesty in manufacture and economy in selling, when you buy our

## SOLID GOLD CHAINS



TRADE MARK

For 56 years, exacting Jewelers have found our chains ready sellers, very profitable to handle and most durable in service. Our prices are very low. We will be pleased to send you a selection package.

1850 1906

**ALOIS KOHN & CO.**

Makers of

**SOLID GOLD CHAINS**  
of every kind.

16-18 Maiden Lane  
New York

## EVERYTHING IN MOURNING JEWELRY.

**A. J. HEDGES & CO.,**

Makers of Exclusive Designs in 14k. Jewelry,  
14 JOHN STREET, NEW YORK.

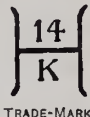

TRADE-MARK

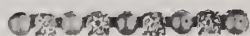

TRADE 14 MARK

**OSMUN-PARKER MFG. CO.**

MAKERS OF

Fine Pearl and Diamond Goods

338 Mulberry Street, NEWARK, N. J.

ESTABLISHED  
1871.

Factory and Office: Newark, N. J.

INCORPORATED  
1900.

## CARRINGTON & CO., Patent Pocket Match Box

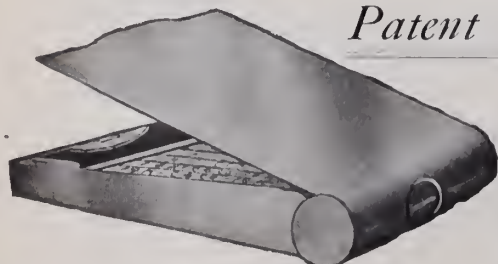

14K. ONLY IN STOCK.

Book Safety Matches with  
Steel Cigar Cutter.  
(Patented.)

Sales Agent:  
7 Maiden Lane,  
NEW YORK.



**M. SCHIFF**

Established 1876

82-84 Nassau St., N. Y.

'Phone 801 John.

Manufacturer of fine  
Diamond Mountings, Locketts  
and Buttons. Patentee of

**THE NEW IMPROVED  
Ear Screw**

The only one on the market  
of its kind, absolutely secure.  
Special attention paid to all  
order work.





## Our Gold and Shell Barrettes.

**T**HE SWING OF TIME'S pendulum restores the vogues of former days. Thus Dame Fashion renews her youth. To-day it is the Barrette.

IN GOLD.

Our showings in Gold Barrettes present attractive varieties of design and decoration. Many in the artistic Colonial Engraved effect. Others with superior Vermicilli Decoration. Graceful showings in fancy Applied Work. Pearl mountings. Fancy stones.

IN TORTOISE SHELL.

Our Shell Barrettes include Gold mountings and dainty Pearl settings.

## Day, Clark & Company

14 KARAT ONLY



25

Maiden Lane  
New York



## WHITESIDE & BLANK

### JUNE BRIDEGROOMS



Are selecting gifts for  
BEST MAN AND USHERS.

A Suggestion:

SCARF PINS—*Rich Scroll Designs.  
Pearl Mounted.*

*Soft Rose Finish.*

CUFF BUTTONS *Heavy Link or Post.  
New Pierced Style.*

*Strong Etched Effects.*

SEAL FOBS—*Ribbon Mounted.*

*All Finishes.*

*Gold or Stone Base.*

*The fancy of engraving these tokens makes the new lapped top button and the gold base seal fob peculiarly appropriate as gifts from the groom.*

NEWARK, N. J.,  
Lafayette and Liberty Streets.

NEW YORK,  
14 and 16 John Street.

ESTABLISHED 1841.

## Carter, Howe & Co.

TRADE



MARK

MANUFACTURERS OF

## Gold Jewelry,

9, 11, 13 MAIDEN LANE,

-

NEW YORK.

FACTORY, NEWARK, N. J.

A. CARTER.

G. R. HOWE.

W. T. CARTER.

W. T. GOUGH.

## SCARF PINS

TRADE MARK

Established in New York 1837.

## Geo. O. Street & Sons.

24 JOHN ST., NEW YORK.  
103 STATE ST., CHICAGO.

# THE MOUNTING THAT SELLS

Earscrews,  
Earrings,  
Studs,  
Scarf Pins,  
and Rings  
of every description.



Pat. Oct. 24, 1905.

Made in  
Platinum,  
18K.,  
14K.,  
all sizes.

It gives light and brilliancy to the stone.

Manufacturer of a general line of Platinum,  
18K. and 14K. Mountings.  
Prompt attention given to special order work.  
Estimates and designs submitted.  
Diamonds recut and repaired.

## JULIUS WODISKA,

40 JOHN STREET,

NEW YORK.

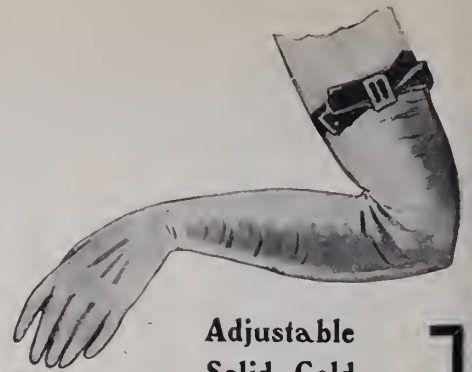

Adjustable  
Solid Gold

## Glove Garters

in Gold, Silver and Plated.

THAT NEW THING.

OUR

Showings of Gold, Gold Filled  
and Silver Jewelry for Spring  
are complete in

- |             |                   |
|-------------|-------------------|
| Brooches    | Crosses           |
| Links       | Rosaries          |
| Scarf Pins  | Fobs              |
| Bracelets   | Combs             |
| Hat Pins    | Waist Sets        |
| Buckles     | Collar Supporters |
| Dog Collars | La Vallieres      |
- etc.

Chas. L. Trout & Co.  
15 Maiden Lane, New York.

# ALLSOPP & ALLSOPP'S

HIGH CLASS

## BRACELETS

MOUNTED IN COMBINATIONS OF

Dia. and Pearl  
Dia. " Sapphire  
Dia. " Emer'lds  
Dia. " Baroques

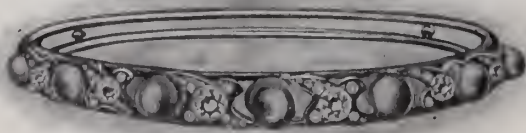

Amethysts  
Topazes  
Peridots  
Aquamarines  
Etc.

18-20 COLUMBIA ST.



TRADE-MARK.

NEWARK, N. J.

## SAM'L BUCKLEY & CO.

English Fancy Goods.



Carry in New York a full line of

### ENGLISH PLATED WAITERS.

118-122 Holborn, E. C.,  
London, England.

100 William St., New York.

## ROBERT DULK, DESIGNER,

Etching in Gold and Silver,  
Telephone, 3960 Chelsea.

No. 70 5th Avenue, NEW YORK

"THE BRACELET HOUSE."

## KENT & WOODLAND,

BRACELETS FOR EVERY WOMAN AND MISS.

16 John Street, New York.

San Francisco Office,  
Care JULIUS A. YOUNG.

"Nethersole Bangles,"  
Plain and with Stones.

"Pinhole" Secret Snap,  
with and without pre-  
cious and semi-precious  
stones.

# MONOGRAMS.

In Gold, Silver and Plate.



A complete line of Two and Three-Letter Monograms always in stock.

SPECIAL DESIGNS TO ORDER.

Elegant  
Silk Ribbon  
and  
Leather Strap  
FOBS.

Always  
Acceptable as  
Gifts.

A Beautiful Solid  
14-K. Gold  
Monogram Fob  
with Ribbon and  
Swivel, complete,  
any three  
letters desired,  
for

**\$10.00**

Send for new  
Illustrated Catalogue,

showing the largest  
selection of stock  
Fob Monograms,  
from 50c. in Gold Plate  
upward.

Create a demand for  
these Fobs by display-  
ing a few samples in  
your window.



1260.

### WIDE STRAP FOB.

English Pig Skin, Tan or  
Black, Take your choice.

Monograms to order, two  
or more letters, same  
price.

Gold Plated...each \$4.50  
Gold Filled...each 7.50  
14-karat Gold. each 15.00

These prices are list  
and subject to discounts  
as shown in our new  
illustrated catalogue.

**OUR  
SPECIALTY :**

MONOGRAMS  
AND INITIALS FOR  
POCKET BOOKS,  
BAGS, ETC.

Send for Fob and Monogram Catalogue  
or other information to

**Thomas J. Dunn & Co.,**  
101 and 103 Chambers St.,  
Dept. J. NEW YORK CITY.

# Look for the Stamp

on back of



The Standard American Collar Button.

# Krementz Collar Buttons and Studs

## The Government Stamp

on every bar of gold issued by the U. S. Assay Office giving its Quality, Weight and Value, is known and accepted all over the world as absolutely correct.

## The Kremmentz Stamp

is universally recognized by dealers and wearers with the same confidence.



# KREMENTZ & CO.,

49 Chestnut Street,

Dept. A.

NEWARK, N. J.

Send for booklet "The Story of a Collar Button"—Free

## Bridesmaids' and Ushers' Pins

We would suggest something with color. Brooches, Scarf Pins and Handy Pins with Amethysts, Topazes, Garnets, Peridots, Aquamarines, Jades and Baroque Pearls. We have a large variety of patterns at moderate prices.

REGARDING OUR FOBS WE HAVE NOTHING TO SAY—  
THEY SPEAK FOR THEMSELVES.

### SNOW & WESTCOTT,

Makers of Good Jewelry for Over Seventy Years,

21 MAIDEN LANE,

NEW YORK.

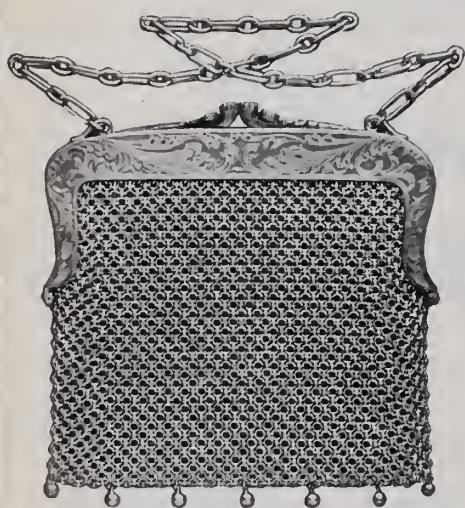

## S. Cottle Co.

are showing an entirely new and exclusive line of Gold and Silver BAGS and PURSES, also many lines of BRACELETS—all of superior workmanship and design.

31 East 17th Street,  
New York.

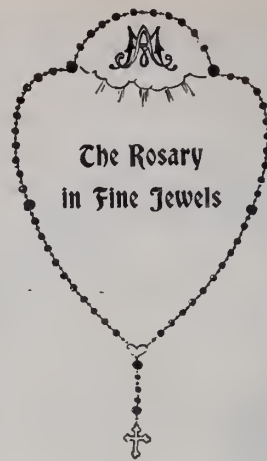

The Rosary  
in Fine Jewels

Fine Rosaries in pure and imitation stone. Mounted in solid gold and rolled gold-plate

ALL COLORS.

Our special illustrated catalogue will give interesting advice regarding prices and discounts.



MADE BY

### The W. J. Feeley Co.

Providence, Rhode Island,

Ecclesiastical Art Metal Workers.

ADOLPH LUTHY.

PERCY W. HINE.

## LUTHY & HINE,

13 EAST 30TH STREET, - NEW YORK.

MANUFACTURERS OF

### Artistic Gold and Platinum Mounted Diamond Jewelry.

Odd and Exclusive Patterns in NECKLACES, BROOCHES, BRACELETS, RINGS, RIBBON COLLARETTES, Etc.

MOUNTED WITH AQUAMARINES, PERIDOTS, AMETHYSTS AND OTHER PRECIOUS STONES.

(DIAMOND MOUNTED COMBS A SPECIALTY.)



BROOCHES, SCARF PINS, ETC.

Up-to-Date CREATIONS

14 K. Gold on Sterling Silver

Prices that are Unequaled

Quality Guaranteed.

Ask Your Jobber

THE MACKAY JEWELRY CO.,

235 Eddy Street,

PROVIDENCE, R. I.



THE CROWN PATENT SAFETY GUARD.



For Scarf Pins Studs and Lace Pins. The most practical and only adjustable one invented. Price, \$1.50 per doz. For sale by all wholesale jewelers and material houses. Sample by mail, 25c; in 10k. gold, \$1.00; 14k., \$1.25. M. CROWN, Maker and Inventor, 48 and 50 Maiden Lane, N. Y.

## WM. SMITH & CO.,

Office, 9-13 Maiden Lane, N. Y.

Manufactory, 61 Peck St., Providence, R. I.

Established 1854.

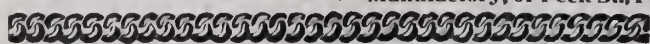

Manufacturers of

### GOLD AND SILVER CHAINS,

Gold, Silver and Plated Chain Trimmings,

Also GOLD AND SILVER KEY CHAINS AND BRACELETS.



Timer is 1/8 Larger than cut

# THE OLD RELIABLE Centennial

SPLIT SECOND TIMER

*"None better made"*

Now is the time to order TIMERS for the Spring and Summer trade—suitable for racing purposes or for mechanical uses.

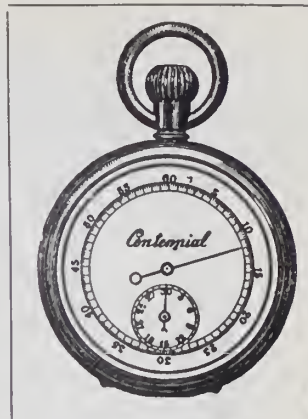

Timer is 1/8 larger than cut

## CROSS & BEGUELIN, Manufacturers, New York.

Lily  
of the  
Valley

✻

*Made in  
Sterling  
Silver  
Only*

FRANK M. WHITING & CO.  
NO. ATTLEBORO, MASS.

## The Comb House

We manufacture a complete line of

### FINE MOUNTED COMBS

in 14 K., 10 K., Sterling Gilt and Gold Filled.

Also all kinds of PLAIN, REAL and IMITATION TORTOISE SHELL COMBS.

### Wagner Manufacturing Co.

41 Union Square,  
New York. Factory, Lorimer St. and Throop Ave., B'klyn, N. Y.

Repair Work  
a Specialty.

## Something for the Baby

The "Baby Nethersole" Bracelet is the cutest creation of the season, and the latest fad for the little ones. Made only in 10K.

**SIZES?**

For the Misses and Adults as well.

Our well known reputation as the house that produces specialties that sell is still maintained by the progressive jeweler.

*Write us for prices.*

### Scofield & DeWyngaert

N. Y. Office	Factory
9-11 Maiden Lane	50 Walnut Street
C. C. Pickford	NEWARK, N. J.

THE BABY NETHERSOLE

## HERMAN KOHLBUSCH, Sr.,

ESTABLISHED 1859.

Manufacturer of Fine Balances and Weights  
for every purpose where accuracy is required.

Office and Salesroom, 194 BROADWAY, NEW YORK.  
Send for Price List. Tel. 370 Cortlandt.

Design  
Illustrated

No. 7957

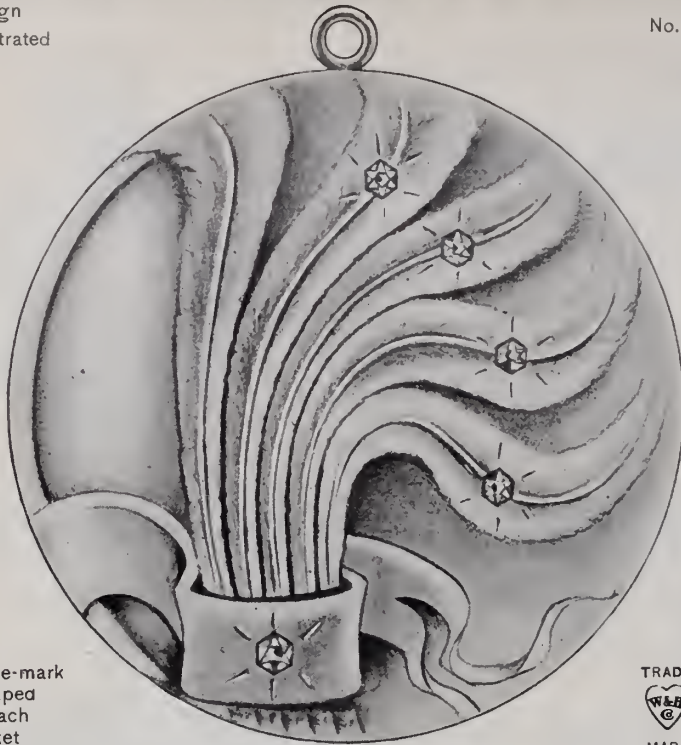

Trade-mark  
stamped  
in each  
Locket



Our **LOCKET** creations continue to be the standard for workmanship and design. Originality and quality have combined to render the excellence of W. & H. Lockets unsurpassed.

3 Maiden Lane **Wightman & Hough Co.** Providence, R. I.  
New York

1876

1906

# Hutchison & Huestis

RING  
MAKERS

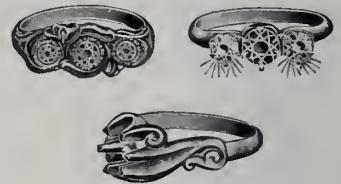

JADE  
is in vogue

SEE OUR  
JADE RINGS  
Jobbing Trade Only

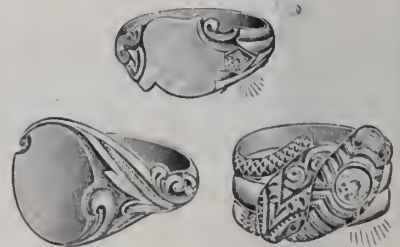

FACTORY  
PROVIDENCE, R. I.

185 EDDY STREET

NEW YORK  
3 Maiden Lane

CHICAGO  
Columbus Building  
HARRY H. MILLER

## BARRETTES

If one will pause for a moment to consider Quality, Price and Design, the conclusion is always the same, we have the Premier Line. This applies to Barrettes, and the A.O.T.G. Lines of



- |            |                  |
|------------|------------------|
| Combs      | Baby Pins        |
| Brooches   | Crosses          |
| Scarf Pins | Waist Sets       |
| Bracelets  | Hat Pins         |
| Barrettes  | Collarettes      |
| Buttons    | Silver Novelties |

LOOK FOR THE TRADE-MARK

MARK.  
**ALWAYS  
ON  
THE  
GO.**

**MILLER, FULLER & WHITING,**  
MANUFACTURING JEWELERS,  
N. Y. Office, 9-11 Maiden Lane. N. ATTLEBORO, MASS.

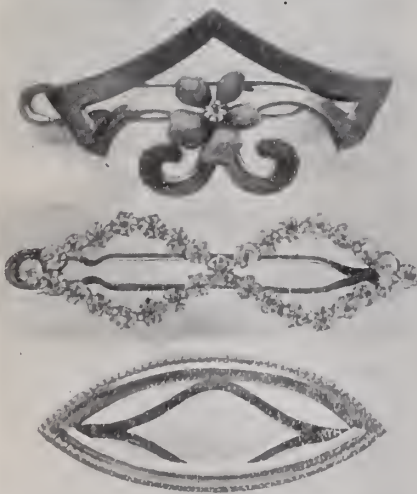

**Roger Williams Silver Co.,**  
PROVIDENCE, R. I., AND NEW YORK, 860 BROADWAY.

**Sterling Only.**

RICH DESIGNS :: :: :: Photos on Application.

**W**ait  
**A**nd See  
**I**n the "Celebrated Case"  
**T**  
**E**  
**T**  
**H**  
**R**  
**E**  
**S**  
**H**  
**E**  
**R**  
**'**  
**S**  
**G**  
**O**  
**O**  
**D**  
**S**  
**S**  
**E**  
**L**  
**L**

**Waite-Thresher  
 Company**

61 PECK ST., PROVIDENCE, R. I.

7 Maiden Lane,  
 NEW YORK.

1203 Heyworth Bldg.  
 CHICAGO, ILL.



## BROOCHES

WE have over four hundred styles of Gold Brooches set with all the popular stones in vogue; not at fancy prices, but at figures that cause them to sell.

We have Gold Barrettes in a variety of shapes and styles.

*Insist upon seeing the designs  
 of Gold Jewelry made by the*

**E. L. SPENCER COMPANY,**

*Makers of Gold Jewelry for the Jobbing Trade.*

ORDERS PROVE OUR GOODS SELL.                      SAMPLES ONLY.

95 Chestnut Street,

PROVIDENCE, R. I.

New York Office, 9-11-13 Maiden Lane.

EVERYTHING IN LOCKETS AND CHAINS.

THE BASSETT JEWELRY CO.,

PROVIDENCE, R. I.



## OUR Silver GOODS

Jewelry and Novelties are Original, Artistic and Sellers. Our name stands for the best of everything in our line at our prices.

**THE W. H. SAART CO., Attleboro, Mass.**

**OFFICES: 713 Market St., San Francisco.**

**103 State St., Chicago. 204 St. James St., Montreal.**

**49 Maiden Lane, New York.**

Toilet Goods  
 Wrist Bags  
 Buckles  
 Bracelets  
 Hat Pins, etc.



F. & B.  
"ARMLET"  
Secret Joint  
Pat. ~~pending~~  
Size 2 3/4 in.

- |           |                           |                                      |
|-----------|---------------------------|--------------------------------------|
| 474       | 476                       | 477                                  |
| 474 POL.  | 476 Rose Gold Half Chased | 477 Rose Gold, Half Chased, 5 Stones |
| 475 ROM.  | 507 O. E.                 | 522 O. E.                            |
| 506 O. E. | 530 Rose Gold Full "      | 546 Rose Gold " " 6 Brillants        |
|           | 538 O. E.                 |                                      |

Color of stones as ordered, Amethyst, Ruby, Sapphire, Olivene, Topaz, Aquamarine, Almondine, Turquoise and Rose Stones.

Bracelets made with secret joint and push catch. High-grade Seamless Gold-filled Stock. Each bracelet in fine leatherette covered box.

See our Lines of Goods for Articles suitable for gifts.

A full line of PHOTO. FRAMES in both Sterling Silver and 14 K. Gold Filled. CROSSES, PENDANTS, NECK CHAINS, LORNETTE CHAINS, LOCKETS, CHARMS, VEST, DICKENS and FOB CHAINS, BRACELETS, PINS, BROOCHES, EARRINGS, LINK BUTTONS, SCARF PINS, HAT PINS, BARRETTE PINS, WAIST SETS, HAIR CHAIN MOUNTINGS, DOG COLLARS and BELT BUCKLES, RIBBON BOOK-MARKS and a large variety of useful



BRACELET 473 ROSE.  
COLOR OF STONES AS ORDERED.

Amethyst, Ruby, Sapphire, Olivene, Topaz, Aquamarine and Turquoise.

Two of the above Bracelets snapped together, makes a nice dog collar 14 in. long.

473



Locket  
2825  
Rose



Pin  
3632  
Rose and Green  
Brillants



Pin  
3647 Pearls  
3648 Brillants  
3649 Turquoise



Pin  
3629  
Baroque Pearls  
and Brillants



Locket  
2826  
Rose



Hair Barrette  
3660 Pearls  
3659 Brills.



Cuff Pin  
3624  
Roman



Cuff Pin  
3622  
Roman



Hair Barrette  
3652 Pearls  
3651 Brills.

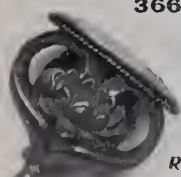

Hat Pin  
710  
Rose and Green  
Polish Signet

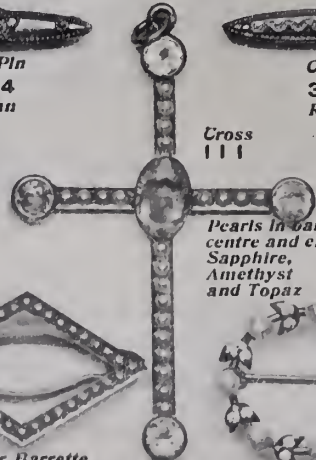

Cross  
111  
Pearls in bars,  
centre and ends.  
Sapphire,  
Amethyst  
and Topaz



Hat Pin  
705  
Rose  
Polish Signet



Links  
751 Rose



Hair Barrette  
3658 Pearls  
3657 Brillants



Pin  
3603 Baroque Pearls  
and Brillants



Links  
758 Green  
757 Rose

These are only a few examples of our new goods; see our complete lines.

Sterling  
Silver  
Novelties.

MANICURE and TOILET SETS and pieces, also DESK SETS, SEWING SETS, TRAVELING SETS, SHAVING SETS, SMOKING SETS, FLASKS and other goods suitable for gentlemen's use.

Do not fail to order a few of our new bracelets,

"The Armlet"

**Theodore W. Foster & Bro. Co.**  
MANUFACTURING JEWELERS AND SILVERSMITHS,  
100 Richmond Street, Providence, R. I.



**Handsome Trophy Won at Brooklyn Riding and Driving Club Show.**

ONE of the chief events of the Brooklyn Riding and Driving Club's show of 1906, which was held in the arena at the Prospect Park Plaza in the week beginning April 23, was the contest for the Loeser cup for Fours. This solid silver cup was offered for the first time a year ago, when it was then won by Alfred G. Vanderbilt. The cup was won this year by W. H. Moore.

This cup is somewhat massive in its proportions and distinctly handsome. On one

**Recent Decisions by General Appraisers on Precious Stones, Jewelry and Kindred Lines.**

Decisions by the Board of United States General Appraisers in cases involving duties on articles of jewelry, precious stones and kindred lines, were announced last week as follows:

**PEARLS, STRING.**—Protest of J. M. Colton against the assessment of duty by the Collector at New York. *Neresheimer v. United States* (T. D. 25876) followed, relating to pearls, string.

**ROCK CRYSTAL INTAGLIOS.—IMITATION PRECIOUS STONES.**—Protest of Nordlinger &

Goodfriend Bros. against the assessment of duty by the Collector at New York. G. A. 6285 (T. D. 27108) followed, relating to rock crystal intaglios.

**IMITATION DIAMONDS.**—Protest of H. B. Clafin Co. against the assessment of duty by the Collector at New York. So-called similis were held to have been properly classified as imitation diamonds under Par. 435, Tariff Act of 1897.

**PRECIOUS STONES IN THE FORM OF BEADS.**—Protest of D. Lisner & Co. against the assessment of duty by the Collector at New York. Under the authority of G. A. 6097 (T. D. 26586), precious stones in the form of beads were held dutiable under Par. 435, Tariff Act of 1897, as precious stones, cut but not set.

**TOY BRACELETS.**—Protest of Spiegelberg & Co. against the assessment of duty by the Collector at New York. Certain bracelets were held dutiable as toys under Par. 418, Tariff Act of 1897, as claimed by the importers. *Strauss v. United States* (T. D. 26903) followed.

**IMITATION PEARLS.**—Protest of H. Nordlinger's Sons against the assessment of duty by the Collector at New York. G. A. 6088 (T. D. 26554) followed, relating to imitation pearls.

**METAL VEST CHAINS.—JEWELRY.—MILLINERY ORNAMENTS.**—Protest of Spiegelberg & Co. against the assessment of duty by the Collector at New York. Certain millinery ornaments were held dutiable as manufactures of metal under Par. 193, Tariff Act of 1897, as claimed by the importers. G. A. 6130 (T. D. 26653) followed. Vest chains composed of metal were held to have been properly classified as jewelry under Par. 434.

**GILDED PICTURE FRAMES.**—Protest of Ferdinand Bing & Co.'s Successors against the assessment of duty by the Collector at New York. G. A. 6218 (T. D. 26885) followed, relating to gilded picture frames.

**TOY BRACELETS.**—Protest of Moses Norris against the assessment of duty by the Collector at Baltimore. A portion of the merchandise in controversy, consisting of bracelets and necklaces, was held dutiable under Par. 418, Tariff Act of 1897, as toys, as claimed by the importer. G. A. 6297 (T. D. 27156) followed.

**IMITATION PEARLS.**—Protest 168684 of Benedict & Warner. April 27, 1906. Same as above.

**INCORUSTED STONES.—IMITATION PRECIOUS STONES.**—Protest of E. A. Bliss & Co. against the assessment of duty by the Collector at New Haven. On the authority of G. A. 6342 (T. D. 27292) the Board sustained the importers' contention that incrustated stones are dutiable as imitation precious stones under Par. 435, Tariff Act of 1897. The Board also sustained the contention that other articles, consisting of imitation precious stones decorated, were dutiable as manufactures of paste under Par. 112, Tariff Act of 1897. The remainder of the merchandise was held to have been properly classified as metal buttons under Par. 414.

**SPANGLED ARTICLES.**—Protests, etc., of Veit, Son & Co. against the assessment of duty by the Collector at New York. G. A. 6323 (T. D. 27240) followed, relating to spangled articles.



THE LOESER CUP FOR FOURS—WON BY W. H. MOORE.

side there is etched an excellent representation of a four-in-hand, with the inscription, "Presented by Frederick Loeser & Co. to the Riding and Driving Club of Brooklyn." On the other side is an etching of a horse's head encircled in a laurel wreath. Above this is a place for the names of the winners. The face is gracefully modeled and ornamented, and the handles are prettily fashioned. The design was the work of Wm. C. Hulick, of Frederick Loeser & Co., and the cup was made by Geo. W. Shiebler & Co., New York.

Mamluck against the assessment of duty by the Collector at New York. G. A. 6088 (T. D. 26554) and G. A. 6285 (T. D. 27108) followed, relating to rock crystal intaglios and imitation precious stones.

**IMITATION PEARLS.—BEADS.**—Protest of Benedict & Warner against the assessment of duty by the Collector at New York. G. A. 6088 (T. D. 26554) followed, relating to imitation pearls pierced, which were held to have been properly classified as beads under Par. 408, Tariff Act of 1897.

**ROCK CRYSTAL INTAGLIOS.**—Protest of

# ACTIVITY

## The Keynote of Our Progress

A series of pictures showing  
various forms of active life.



### JUST OVER

By constant training and endeavor, the pole vaulter—inch by inch—increases the height of his jump. By constantly adding new ideas and patterns to our various lines of rings, we want to merit an increase in our business.

If you will let our salesmen show you our stock of rings—for man, woman and child—you will find many new and attractive patterns in the line. This means we would like more business. May we do it with you?

4  
over  
40  
years  
Ring Makers

Larter & Sons  
21-23  
Maiden Lane  
New York



### ELSIE BEE'S FASHIONS.

NOVELTIES SEEN IN A LADY'S RAMBLES AMONG THE  
JEWELERS.

FOR the Summer girl, gowned in white, is an exquisite little watch of finest white enamel, with chatelaine pin to match, and both are beautifully ornamented with overlaying gold filigree.

\*

New parasol mountings, in a case, consist of a twisted tortoise-shell handle with loop end; points and extension top to match.

\*

A new ring, recently seen, simulates a small diamond bow, with one large loop on top, in the center of which is a fine diamond.

\*

In a bracelet noticeable for the unique effect of contrast, very close and beautiful squares of gold filigree alternate with open squares set with gems.

\*

As a novelty in sleeve links some open figures, such as ovals, diamonds, squares and ovals elongated to a point, are shown in gold corded effects, with a single diamond in the center.

\*

A blue fan is rather taking embroidered in gold thread in a design suggestive of Japanese art. A black fan has a floral design carried out in appliqué of white lace braid, with white pearl sticks.

\*

In contradistinction to the light, open style of setting in the use of diamonds with pearls, or stones of color, is the most elaborate diamond work, as in a large brooch, encrusted with large, round pearls, gray and white.

\*

As mentioned some months ago, bangles, and also heavy chain and wide gold bracelets, are pre-eminently the style for out-of-door wear with elbow gloves, which have become a great feature of Spring and Summer styles, and such bracelets, as well as those of more delicate outline, are in great demand. A single bracelet is generally worn at present.

\*

Nothing prettier has been shown in the line of ladies' watches for some time than the new style that has a chain to match the watch attached. A charming little model, with richly chased case of yellow gold, is set with diamonds. The long chain is composed of slender, fancy beads of yellow gold, about half an inch in length, alternating with diamonds.

\*

Some new fans in the soft pastel shades of blue, pink and red, now so popular in the smartest costumes, are rendered particularly attractive by well chosen treatment. The mounts are of silk, sometimes inset with gold gauze, and decorated with pretty, conventional designs running on a line with the sticks. The sandalwood frames are beautifully treated with a pattern in gold. Both gold and silver spangles are used on the mounts for medium priced fans.

ELSIE BEE.

## Reported to the Senate.

### Interstate Commerce Committee Acts Favorably on Jewelry Trade's Gold and Silver Stamping Law.

WASHINGTON, D. C., May 9.—The Senate Committee on Interstate Commerce has reported back to the Senate the Jewelry Trade's Gold and Silver Stamping Bill introduced by Representative Vreeland, with only two amendments; one to reduce the fine and imprisonment from six months and \$1,000 to three months or \$500, and the other, to make it operative one year after its passage, instead of six months. No special report will be made.

The bill has made unusually quick progress, having passed the House of Representatives on April 16. It is now No. 3,528 on the Senate calendar.

The act as passed by the Senate is as follows, the words in brackets being those of the House bill that were stricken out and those in italics are new. The bill reads:

*In the Senate of the United States, April 17, 1906. Read twice and referred to the Committee on Interstate Commerce, May 8, 1906. Reported by Mr. Aldrich, with amendments.*

#### AN ACT

FORBIDDING THE IMPORTATION, OR CARRIAGE IN INTERSTATE COMMERCE OF FALSELY OR SPURIOUSLY STAMPED ARTICLES OF MERCHANDISE MADE OF GOLD OR SILVER OR THEIR ALLOYS, AND FOR OTHER PURPOSES.

*Be it enacted by the Senate and House of Representatives of the United States of America in Congress assembled,* That it shall be unlawful for any person, firm, corporation, or association, being a manufacturer of or wholesale or retail dealer in gold or silver jewelry or gold ware, silver goods or silverware, or for any officer, manager, director, or agent of such firm, corporation, or association to import or export or cause to be exported into or exported from the United States for the purpose of selling or disposing of the same, or to deposit or cause to be deposited in the United States mails for transmission thereby, or to deliver or cause to be delivered to any common carrier off transportation from one State, Territory, or possession of the United States, or the District of Columbia, to any other State, Territory, or possession of the United States, or to said District, in interstate commerce, or to transport or cause to be transported from one State, Territory, or possession of the United States, or from the District of Columbia, to any other State, Territory, or possession of the United States, or to said District, in interstate commerce, any article of merchandise manufactured after the date when this act takes effect and made in whole or in part of gold or silver, or any alloy of either of said metals, and having stamped, branded, engraved, or printed thereon, or upon any tag, card, or label attached thereto, or upon any box, package, cover, or wrapper in which said article is incased or inclosed, any mark or word indicating or designed or intended to indicate that the gold or silver or alloy of either of said metals in such article is of a greater degree of fineness than the actual fineness or quality of such gold, silver, or alloy, according to the standards and subject to the qualifications set forth in Sections 2 and 3 of this act.

Sec. 2. That in the case of articles of merchandise made in whole or in part of gold or of any of its alloys so imported into or exported from the United States, or so deposited in the United States mails for transmission, or so delivered for transportation to any common carrier, or so transported or caused to be transported as specified in the first section of this act, the actual fineness of such gold or alloy shall not be less by more than one-half of one carat than the fineness indicated by the mark stamped, branded, engraved, or printed upon any part of such article, or upon any tag, card, or label attached thereto, or upon any box, package, cover, or wrapper in which such article is incased or inclosed; except that in the case of watch cases and flat ware, so made of gold or of any of its alloys, the actual fineness of such gold or alloy shall not be less by more than 3-1000 parts than the fineness indicated by the mark stamped, branded, engraved, or printed upon such article, or upon any tag, card, or label attached

thereto, or upon any box, package, cover, or wrapper in which such article is incased or inclosed: *Provided*, That in any test for the ascertainment of the fineness of any article mentioned in this section, according to the foregoing standards, the part of the article taken for the test, analysis, or assay shall be such part or portion as does not contain or have attached thereto any solder or alloy of inferior fineness used for brazing or uniting the parts of said article: *Provided further*, That in the case of any article mentioned in this section, in addition to the foregoing tests and standards, the actual fineness of the entire quantity of gold or of its alloys contained in such article, including all solder and alloy of inferior fineness used for brazing or uniting the parts of such article (all such gold, alloys, and solder being assayed as one piece), shall not be less by more than one carat than the fineness indicated by the mark stamped, branded, engraved, or imprinted upon such article, or upon any tag, card, or label attached thereto, or upon any box, package, cover, or wrapper in which such article is incased or inclosed, it being intended that the standards of fineness and the tests or methods for ascertaining the same provided in this section for articles mentioned therein shall be concurrent and not alternative.

Sec. 3. That in the case of articles of merchandise made in whole or in part of silver or any of its alloys so imported into or exported from the United States, or so deposited in the United States mails for transmission, or so delivered for transportation to any common carrier, or so transported or caused to be transported as specified in the first section of this act, the actual fineness of the silver or alloy thereof of which such article is wholly or partly composed shall not be less by more than 4-1000 parts than the actual fineness indicated by any mark (other than the word "sterling" or the word "coin") stamped, branded, engraved, or printed upon any part of such article, or upon any tag, card, or label attached thereto, or upon any box, package, cover, or wrapper in which such article is incased or inclosed; and that no such article or tag, card, or label attached thereto, or box, package, cover, or wrapper in which such article is incased or inclosed shall be marked, stamped, branded, engraved, or printed with the word "sterling" or "sterling silver" or any colorable imitation thereof, unless such article or parts thereof purporting to be silver contains 925-1000 parts pure silver; and that no such article, tag, card, label, box, package, cover or wrapper shall be marked, stamped, branded, engraved, or printed with the words "coin" or "coin silver" or colorable imitation thereof unless such article or parts thereof purporting to be silver contains 900-1000 parts pure silver: *Provided*, That in the case of all such articles whose fineness is indicated by the word "sterling" or the word "coin" there shall be allowed a divergence in the fineness of 4-1000 parts from the foregoing standards: *Provided*, That in any test for the ascertainment of the fineness of any such article mentioned in this section according to the foregoing standards the part of the article taken for the test, analysis, or assay shall be such part or portion as does not contain or have attached thereto any solder or alloy of inferior fineness used for brazing or uniting the parts of such article: *Provided further*, That in the case of any article mentioned in this section, in addition to the foregoing tests and standards, the actual fineness of the entire quantity of silver or of its alloys contained in such article, including all solder and alloy of inferior fineness used for brazing or uniting the parts of such article (all such silver, alloys, and solder being assayed as one piece), shall not be less by more than 10-1000 parts than the fineness indicated by the mark stamped, branded, engraved, or imprinted upon such article, or upon any tag, card, or label attached thereto, or upon any box, package, cover, or wrapper in which such article is incased or inclosed, it being intended that the standards of fineness and the tests or methods for ascertaining the same provided in this section for articles mentioned therein shall be concurrent and not alternative.

Sec. 4. That in the case of articles of merchandise made in whole or in part of an inferior metal, having deposited or plated thereon or brazed or otherwise affixed thereto a plating, covering, or sheet composed of gold or silver, or of an alloy of either of said metals, and known in the market as rolled gold plate, gold plate, gold filled, silver plate, or gold or silver electroplate, or by any similar designation, so imported into the United States, or so deposited in the United States mails for transmission, or so delivered to any common carrier, or so transported or caused to be transported as specified in the first section

of this act, no such article, nor any tag, card, or label attached thereto, nor any box, package, cover, or wrapper in which such article is incased or inclosed, shall be stamped, branded, engraved, or imprinted with any word or mark usually employed to indicate the fineness of gold, unless such word or mark be accompanied by other words plainly indicating that such article or part thereof is made of rolled gold plate, gold plate, or gold electroplate, or is gold filled, as the case may be, and no such article, nor any tag, card, or label attached thereto, nor any box, package, cover, or wrapper in which such article is incased or inclosed, shall be stamped, branded, engraved, or imprinted with the word "sterling" or the word "coin," either alone or in conjunction with other words or marks.

Sec. 5. That each and every person, firm, corporation, or association, being a manufacturer of or a wholesale or retail dealer in gold or silver jewelry, gold ware, silver goods, or silverware, who or which shall knowingly violate any of the provisions of this act, and every officer, manager, director, or managing agent of any such corporation or association having knowledge of such violation and directly participating in such violation or consenting thereto, shall be deemed guilty of a misdemeanor, and upon conviction thereof in any court of the United States having jurisdiction of crimes within the district in which such violation was committed or through which has been conducted the transportation of the article in respect to which such violation has been committed, shall be punished by a fine of not more than [one thousand] *five hundred* dollars or imprisonment for not more than [six] *three* months, or both, at the discretion of the court. Whenever the offense is begun in one jurisdiction and completed in another it may be dealt with, inquired of, tried, determined, and punished in either jurisdiction in the same manner as if the offense had been actually and wholly committed therein.

Sec. 6. That the expression "article of merchandise" as used in this act shall signify any goods, wares, works of art, commodity, or other thing which may be lawfully kept or offered for sale.

Sec. 7. That all articles of merchandise to which this act applies which shall have been transported into any State, Territory, District, or possession of the United States, and shall remain therein for use, sale, or storage, shall, upon arrival in such State, Territory, District, or possession, be subject to the operation of all laws of such State, Territory, District, or possession of the United States to the same extent and in the same manner as though such articles of merchandise had been produced in such State, Territory, District, or possession, and shall not be exempt therefrom by reason of being introduced therein in original packages or otherwise.

Sec. 8. That this act shall take effect [six months] *one year* after the date of its passage. Passed the House of Representatives April 16, 1906.

Attest:

A. McDowell, Clerk.

### Rochester Optical Society Elects Officers for the Ensuing Year.

ROCHESTER, N. Y., May 9.—The regular meeting of the Rochester Optical Society was held in the office of Clark & Bowen, this city, yesterday at 8 P. M. A well known nose and throat specialist gave an interesting lecture, showing how the optometrist might distinguish headaches caused by nose and throat affections. The matter of Saturday closing was brought up and discussed, and it was the opinion of the society that if the large stores closed the opticians would close also.

Applications for membership were received from Geo. L. Andrus and Chas. F. Vanderpool, of Rochester, and John D. Murdock, Geneseo, and were ordered referred to the executive committee.

The following officers were elected: President, H. M. Bestor; vice-president, A. D. Bliss; secretary, H. I. Sumeriski; treasurer, H. C. Mielke; executive committee, Edward Benedict (chairman), Arthur Pellow, Ellery Handy, Milton Goodman and Parry Newman.

# HAYDEN W. WHEELER & Co.



## MOUNTED DIAMONDS



**O**UR stock of Mounted Diamonds contains the Latest and Newest Designs. Made from best Selected Material. Finest Hand Made Mountings. Quality, Style and Lowest Price consistent with this standard.

AMSTERDAM  
2 TULP STRAAT

BROOCHES, RINGS, SCARF PINS, BRACELETS, ETC.

LONDON  
50 HOLBORN VIADUCT

2 MAIDEN LANE, NEW YORK

TELEPHONE  
7365 CORTLANDT

ORDER

# DIAMONDS

ON MEMORANDUM FROM

## ALFRED H. SMITH & CO.

170 BROADWAY, NEW YORK.  
Corner Maiden Lane.

London,  
4 Holborn Viaduct.

Chicago,  
103 State Street.

## Oppenheimer Bros. & Veith.

Cutters of Diamonds,

65 NASSAU ST. (PRESCOTT BUILDING), NEW YORK.

AMSTERDAM,  
2 Tulp Straat.

LONDON,  
40 Holborn Viaduct.

CUTTING WORKS,  
Cor. Union & Nevins Sts., Brooklyn.

## HENRY E. OPPENHEIMER & CO.,

51 Holborn Viaduct, London.  
50 Rue de Chateaudun, Paris.  
7 Place Loos, Antwerp.

Tel. 621 Cortlandt

3 MAIDEN LANE, NEW YORK.

DIAMONDS, PEARLS AND PRECIOUS STONES.

MEMORANDUM ORDERS SOLICITED.

### Interesting Quiz at the Regular Monthly Meeting of the Optical Society of the City of New York.

The regular monthly meeting of the Optical Society of the City of New York was held Wednesday, May 9, 1906, at 8 o'clock, in the optical parlors of A. Martin, 17 W. 28th St., New York, with 34 members in attendance.

President Offenhauser, Sr., was absent through illness, and the chair was filled by First Vice-President J. E. Meyer, who called the meeting to order.

Applications for membership were received from Walter Carlin, 380 2d St., Brooklyn (proposed by Mr. Levin); A. F. Mittacher, 341 E. 86th St., New York (proposed by Mr. Hohl); H. Schuman, 1762 Madison Ave., New York (proposed by Mr. Frank).

These were laid on the table, as usual, for action at the next meeting. The recording secretary was empowered to cast a vote for the election of H. J. Pippitt, Port Jervis, N. Y., as a member of this society.

The financial secretary, Mr. Levin, reported that an account had been opened with the Mercantile National Bank in the name of the society, and that 34 members had enrolled as participants in the two years' course, and five more came in on the evening of this meeting, making a total of 39 enrolled thus far.

Mr. Ryer, who was scheduled to speak before the convention of the New England Association of Opticians in Boston, Mass., May 15-16, was elected by the society as a delegate to represent it there. Mr. Dilworth gave an interesting prelude to the quiz by Prof. Lockwood, by reading part of an article, "Eyestrain as a Cure for Diseases of the Digestive Organs," and was listened to with much interest.

He dwelt on the necessity of the members paying great attention to the work in hand and said that all should understand that none, including himself, could successfully pass the examination without coming up to a certain standard. His remarks were followed by a hearty round of applause.

Prof. Lockwood then began his quiz on the first four lessons in Henderson's "Lessons on the Eyes," calling on the various members indiscriminately, and illustrating the various bones, etc., by means of a human skull, which had been provided for the purpose. This first night's work was very successful, and most of the members responded quickly and correctly to the questions asked.

At the end of the Professor's quiz it was decided that the secretary send to each of the members of this section only a list of the questions asked. The members are to bring the answers in at the next meeting, when they will be reviewed and corrected if necessary.

#### QUIZ QUESTIONS PROPOUNDED AT THE MEETING.

- (1) Name the seven bones of the orbit.
- (2) What is the function of the orbicularis muscle?
- (3) What muscle holds the eyelid close to the eyeball?
- (4) Which muscle runs through a loop or pulley?
- (5) Where is the location of the lachrymal gland?
- (6) Where do most of the nerves of the eye enter the orbit?
- (7) With what is the orbit of the back of the eyeball filled?

- (8) What is Tenon's capsule, and what is its function?
- (9) Name the six extra-ocular muscles.
- (10) Where do they arise?
- (11) Where are they attached to the lobe of the eye.
- (12) Do the ocular muscles pull straight backwards?
- (13) What muscle lifts the upper eyelid?
- (14) What nerves supply the muscles of the eye?
- (15) What gives strength and toughness to the eyelids?
- (16) What are the meibomian glands?
- (17) What are the canthi of the eye?
- (18) Describe the lachrymal gland.
- (19) Describe the excretory apparatus working in conjunction with the same?
- (20) Describe the conjunctiva.
- (21) Where is the fornix of the conjunctiva?
- (22) Describe the eyeball in general terms.
- (23) How many coats has the eyeball, and what are they?
- (24) Describe the cornea.
- (25) Describe the sclera.
- (26) Describe the iris.
- (27) Describe the spaces of Fontana and the canal of Schlemm.
- (28) Describe the ciliary body.
- (29) Describe the choroid.
- (30) Describe the vitreous.
- (31) Describe the retina.
- (32) Describe the optic disk.
- (33) Describe the optic nerve.
- (34) What is the optic commissure and what purpose does it serve?
- (35) Describe the decussation of the optic nerve fibers.

### Millville, N. J., Jeweler Looking Up Record of Man He Accused of Larceny.

MILLVILLE, N. J. May 9.—A. M. Kendall, 120 High St., this town, is anxious to learn if any members of the trade have had any transactions with a man named Frank I. Hall or Lafayette Stainrook, who is committed to jail here awaiting trial, next September, on a charge that he swindled Mr. Kendall out of two watches valued at \$50. As Mr. Kendall has been investigating the career of the prisoner he is anxious to learn about any previous transactions he may have had in the jewelry trade, and asks that brother jewelers who may know Hall, write to him at the earliest possible moment.

The alleged crime for which Hall is now in jail was committed April 18, 1892, at which time the complainant says Hall got up an entertainment for a local lodge of Red Men, and obtained the watches on the ground that they were to be voted to the two most popular members. Hall had previously deposited in a local bank a check for \$1,000, drawn on a Boston bank, and on the strength of this deposit obtained credit and standing for his enterprise. After he had left town suddenly it was discovered that the check which he deposited was worthless. He did not attempt to draw upon his account, however, and no charge was made against him by the bank.

Mr. Kendall claims that he had traced Hall to a number of cities and that the latter had operated in Bloomfield, N. J., and in other towns. The prisoner was arrested at Trenton, N. J., April 18, but the local charge against him was waived in order that he might be brought to Millville for trial on Mr. Kendall's complaint.

Hall or Stainrook is about 70 years old, weighs about 150 pounds, is five feet, nine inches high, has blue eyes and gray mustache. He has a scar upon each leg above the ankle and a wound on the wrist.

### Controversy Between McKay Co., Washington, D. C., and James C. Buchanan, Taken to the Courts.

WASHINGTON, D. C., May 10.—A suit in equity has been filed by the McKay Co. against James C. Buchanan, in which an injunction is sought. The bill of complaint sets forth that the complainant company was incorporated on Jan. 20, 1906, for the purpose of doing a retail jewelry business. At that time Buchanan was doing a jewelry business at 1115 F St., N. W., and on Jan. 20, 1906, he and his wife executed a bill of sale conveying to the McKay Co. all his stock. In this bill of sale was a provision that the McKay Co. was to occupy one-half of the premises, 1115 F St., and the entire store later, when Buchanan gave up his optical business. It was further agreed that Buchanan was to relinquish his optical business within a few months and turn over the whole premises to the McKay Co.

It is now alleged that Buchanan has since attempted to sell out his optical business coupled with the right of occupancy of said premises; that he was instrumental in bringing proceedings against the McKay Co. by inducing Louis Costaggini to petition the court for the appointment of a receiver for the McKay Co. These proceedings were subsequently dismissed by the court at the instance of both parties to the suit. These acts of Buchanan's, so the complainant company alleges, have injured the business of the McKay Co., and, if they are persisted in, will ruin it altogether.

The court is asked to restrain Buchanan from entering upon the premises, 1115 F St., or in any manner interfering with the complainant company. A temporary injunction was granted.

### Texas Jeweler Accused of Smuggling Gems and Jewelry Across Mexican Border.

SAN ANTONIO, Tex., May 9.—Before United States Commissioner Neill last week Louis Leschenger, a jeweler of Houston, waived examination on the charge of smuggling, and was admitted to bond in the sum of \$2,500 to await the action of the United States Grand Jury, which is in session this week.

Mr. Leschenger was brought to this city from Eagle Pass, at which place he had previously been arrested by Collector Dowe and Deputy Collector Baldwin on a charge that he had brought into the United States, without properly declaring the same, diamonds, Swiss watches and jewelry to the amount of \$1,500. Mr. Leschenger, who is represented here by his attorney, Winchester Kelso, has declined to make any statement except to say that he is guilty of no intent to defraud the Government.

Unless the case against Leschenger is immediately dismissed by the Grand Jury an action *in rem* to forfeit the articles claimed to have been smuggled will also be begun in the United States Court.

Mr. Rauber, of the Rauber & Wollensak Optical Co., Inc., Rochester, N. Y., has retired from that firm, and the style hereafter will be Wollensak Optical Co., Inc.



### AMETHYST

In Siberian, Brazilian and D'Auvergne qualities, in all shapes and sizes. Golden and Madeira topaz. Half, round and bouton pearls. Reconstructed rubies, opals, garnets, and doublets in the fancy colors and fancy shapes—uniform grades, especially selected for the American Market.

## *L. Heller & Son*

Importers of Precious and Imitation Stones.

New York, 51 Maiden Lane  
Paris, 5 Cite Trevisé

Providence, 212 Union Street  
Idar, 14 Hauptstrasse

TELEPHONE 219 JOHN.

GEORGE H. HODENPYL.

WALTER N. WALKER.

# DIAMONDS

AND

## DIAMOND JEWELRY

# HODENPYL & WALKER

Unique  
and

Staple Patterns

### 170 Broadway, New York

Corner of Maiden Lane

TELEPHONE, 1898 CORTLAND

Repairing and Recutting

Diamonds

a Specialty,

<p>OUR <b>40th</b> YEAR</p> <p>IN BUSINESS</p> <p>1866-1906</p>	<p><b>DIAMONDS</b> LOOSE AND MOUNTED</p> <p><b>CASES and MOVEMENTS</b> ALL MAKES AND GRADES</p> <p><b>JEWELRY</b> GOLD AND PLATED</p>
<p>ORDERS SOLICITED FROM RESPONSIBLE JEWELERS.      GOODS SENT ON SELECTION.</p> <p>All our goods are either direct importations, our own manufacture or bought for cash, enabling us to offer special inducements in prices and terms.</p>	
	<p>EST. 1866.</p> <p><i>Lissauer &amp; Company</i></p> <p>Importers.</p> <p>2 TULPSTRAAT, AMSTERDAM.</p>
<p>12 MAIDEN LANE, (ONE FLIGHT UP)</p> <p>P. O. Box, 1625, <b>NEW YORK.</b></p>	

# JOBGING STONES

IMITATION and GENUINE

ORDERS OF ALL SIZES SOLICITED.

## MARTIN LOW & TAUSSIG,

51 Maiden Lane, New York.      139 Mathewson St., Providence, R. I.

Telephone, 2817-John.      Telephone, 3037-Union.

## MEYEROWITZ BROS.,

IMPORTERS OF **DIAMONDS,** 37-39 MAIDEN LANE, NEW YORK CITY

A Complete Line of Precious, Semi-Precious and Imitation Stones. Mail orders promptly attended to.

## Echoes of the Gattle Failure.

### Trustee's Judgment Against David Mayer Reversed on Appeal and Suit Against Herman Levy Decided.

Two decisions were rendered in the last week in the cases growing out of the failure of Hyman Gattle, who was in the diamond business at 65 Nassau St., New York, until June 16, 1903, when a petition in bankruptcy was filed against him. Both cases were brought against creditors on the ground that they had received improper preferences, the defendants being David Mayer and Herman Levy. The decision in Mr. Mayer's case, which was handed down by the Appellate Division, First Department, of the New York Supreme Court, was in his favor, reversing the judgment awarded last June by Justice Fitzgerald and a jury. In the Levy case Justice Fitzgerald now decides on questions of law unfavorably to Mr. Levy in one respect and in his favor on another branch of the case.

The two suits were brought by Simon T. Stern, as trustee in bankruptcy of Hyman Gattle's estate. The Jewelers Board of Trade has been back of the trustee in the litigation, and its attorneys, Hastings & Gleason, represented him in each case.

In the Mayer case the appeal to the Appellate Division was from a judgment ordering the defendant to return a quantity of jewelry valued at \$2,200. The court reverses the judgment, and orders a new trial with costs to the appellant to abide the event. The court was not a unit in so deciding, however. The majority opinion was written by Justice Houghton, the other justices concurring, except Justice Ingraham, who wrote a dissenting opinion.

In the majority opinion the court says that according to the evidence Mr. Mayer called at Gattle's office just prior to the failure and obtained a brooch and other articles of jewelry, saying that he wished to show them to his wife and might buy them for her. Later Gattle demanded the return of the jewelry, and Mayer, who was a creditor for \$3,000, and this was refused. Thereafter Gattle began replevin proceedings, which were interrupted by the bankruptcy case.

The court holds that there was certainly no intention on the part of Gattle to give an illegal preference to Mayer. If any charge can be made, said the court, it is that Mayer obtained the property by deceit, but in such a case the remedy is not to be found in the suit to recover for an alleged illegal preference. The trustee in bankruptcy, who stands in Gattle's shoes, could sue in replevin or in some other action. The court holds that the court below erred in not granting the motion made by the defendant's counsel at the close of the plaintiff's case for a dismissal on the ground that the evidence was at variance with the complaint.

In Justice Ingraham's dissenting opinion he says that while Mayer may have obtained the jewelry originally by deceit, yet he held it as a creditor, and such continued possessions constituted an illegal preference in violation of the bankruptcy law. The Justice says that at the trial, if the defendant intended to raise objection to the character of the action he should have entered his objection when the evidence was being

presented, and should not have waited until after the plaintiff had completed the case. In the Justice's opinion it would be inequitable, after a valid case had been made out against the defendant, to allow him to take advantage of his own deceit. Justice Ingraham says that in his opinion the court below properly allowed the question to go to the jury.

Gilbert & Mayer appeared in this case as attorneys for Mr. Mayer.

It was stated at the office of Hastings & Gleason that new proceedings will be taken at once against Mr. Mayer under a section of the bankruptcy law. It was said that an amended complaint will be served, and as the value of the property has been admitted by Mr. Mayer, the future litigation will be simplified.

In the case against Herman Levy a verdict was rendered Thursday by Justice Fitzgerald in the Special Term of the Supreme Court, New York. Under the terms of the decision Mr. Levy is ordered to turn over to the trustee a quantity of jewelry which has been valued at \$2,000. The trustee, besides seeking to have this jewelry returned, also included in an amended complaint a demand for a much larger quantity of jewelry, roughly valued by various witnesses at \$40,000 and more. The court does not sustain this latter and larger demand.

The jewelry which Mr. Levy is ordered to return to the bankrupt estate consists of 119 articles, and he has admitted from the beginning that he received this merchandise, a list of which was offered in court as "Exhibit I." The other jewelry demanded by the complainant he denied receiving.

The particulars of this case have been mentioned from time to time in THE CIRCULAR-WEEKLY and were quite fully set forth May 24, 1905, in an account of the trial before Justice Fitzgerald. Just before Gattle failed Mr. Levy took possession of the 119 articles of jewelry as security for his debt. The attorneys for the trustee charged in effect that Mr. Levy, as the creditor on the spot, having an office in the same building where Mr. Gattle did business, had practically taken all the assets, but this contention is not sustained by the court. Justice Fitzgerald in his opinion severely criticizes Gattle and indicates that the court did not believe the testimony given at the trial by Gattle and his wife and their bookkeeper, Master-son. The essential part of the opinion says:

Master-son testified that earlier on the day upon which he delivered to Levy the goods listed upon Exhibit I, he had delivered to him a great quantity of other merchandise; that his only reason for doing so was a request coupled with a statement by Levy, that "he had a customer for some pendants downstairs." He said that on this occasion Levy was accompanied by his son, and that trays of rings and pendants were carried away by these two persons in telescope cases and otherwise, and that all of this was permitted by him to be done without retaining any memorandum or getting a receipt.

The improbability of this tale was emphasized by the manner in which it was told, and the efforts of Gattle and his wife to support it involved them in contradictions numerous and irreconcilable. Mr. Gattle swore that he examined the stock between May 15 and June 10, and that he valued it at \$75,000, but on the 10th of June, in presence of his wife and defendant, he stated its value was between \$40,000 and \$50,000, his wife on that occasion differing from him and insisting that it was worth \$60,000. Upon the trial Mrs. Gattle swore that the value of the stock on June 9 was

\$43,360.73, or \$16,000 less than she had previously claimed.

Gattle's purchases between November, 1902, and June, 1903, amounted to \$62,827.43. During that same period he had raised on pledges of stock \$80,000 and covered up these questionable acts by marking the word "sold" opposite the entries of the numbers in the stock book corresponding with the lot or stock numbers of the goods pawned, and his liabilities amounted to between \$110,000 and \$130,000.

He kept no proper books from which even a shadowy surmise as to the amount of stock at any of these times on hand could be made. He had also endeavored to dispose of the pawn tickets, not hesitating to make false statements in his attempts to deceive prospective purchasers. Mrs. Gattle and Master-son were fully informed of all of these incriminating facts.

A record is thus presented fairly reeking with dishonesty and fraud and without a scrap of reliable evidence to support any finding in plaintiff's favor on the amended averment of the complaint. I am, however, fully satisfied that defendant thoroughly understood Gattle's insolvent condition at the time he received the admitted property. The examination of the safe he then made was sufficient notice of that, and, upon the whole case, it would be a reflection upon Mr. Levy's remarkable shrewdness and cunning to hold otherwise.

Judgment for plaintiff for delivery of articles specified in Exhibit I, with costs. Settle decision and judgment upon notice.

The defendant in this case was represented by Jellenik & Stern.

### Police of Binghamton, N. Y., Arrest Man and Woman Whom They Claim Are Noted Jewelry Thieves.

BINGHAMTON, N. Y., May 10.—The police of this city believe they made a most important arrest in taking into custody Frank Kelley and Mary Hennessey yesterday, claiming that the prisoners are well known "pennyweight" thieves. The arrest was made in the jewelry store of J. S. Newing, Court and Collier Sts., about 11 A. M. by Acting Chief Abel and Detective Stephenson.

Kelley was taken only after a hard fight with the detective, and his companion was grabbed by the acting chief as she was about to go away during the altercation. The two had been looking at diamonds at Mr. Newing's counter just previous to the arrest, and when taken to the station house and searched a number of articles were discovered. A diamond ring valued at \$30, which was found on Kelley, was identified by the police as a piece which had formerly been in Mr. Newing's stock. In its place in the tray, they say, a ring with a much smaller stone was found.

The police claim that Kelley's companion's real name is Mary Mack. She is a handsome woman about 26 years old, five feet three inches high, has dark brown hair and blue eyes. From her as well as from Kelley a number of pieces of jewelry were taken. Kelley is about 35 years of age, five feet three inches high, weighs about 125 pounds and has a small sandy mustache.

Mr. Newing swore out a complaint against both prisoners, charging them with grand larceny in the second degree. They were held for examination May 19 in \$2,000 bail, which they were not able to furnish, and were sent to jail.

J. B. Ball has been succeeded in business in Joplin, Mo., by Ball & Putman.

Philip Lyzen, watchmaker, formerly engaged in business on W. Leonard St., Grand Rapids, Mich., has taken a position with Joseph Siegel, at the same place.

# Chester Billings & Son

1840

Successors to  
Kandel, Barmore & Billings

1906

Importers of Diamonds  
Other Precious Stones, and  
Pearls, Diamond Jewelry

1840, Kandel & Barmore; 1866, Kandel, Barmore & Co.; 1880, Kandel, Barmore & Billings; 1897, Chester Billings & Son

New York, 58 Nassau Street, 29 Maiden Lane  
London: 22 Holborn Viaduct, E. C. Paris: 53 Rue de Chateaudun  
Amsterdam: 2 Tulp Straat



THE TRADE

desirous of keeping in touch with modern, profit-producing methods, should always consult the 500 pages of

OUR BIG CATALOGUE, with its 30,000 illustrations and long list prices. We send this splendid book free on request.

*S. F. Myers & Co.*

Headquarters for Dueber-Hampden Watches.

WHOLESALE JEWELERS  
The New S. F. Myers Bldg. 476-49 Maiden Lane New York.

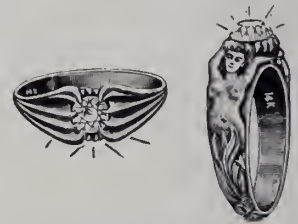

Manufacturer of  
Diamond Mountings and  
Diamond Set Jewelry  
Importer of  
Diamonds and Precious Stones

**A. S. Hirshberg,**  
373 Washington Street, Boston, Mass.

Cable Addresses: { Ashir, Boston.  
Hochschüler, Antwerp.

## REMOVAL NOTICE!

**THE LYONS GEM CO.,**

Have Removed to  
**35 Maiden Lane, New York.**

A FULL AND COMPLETE LINE OF PRECIOUS,  
SEMI-PRECIOUS AND IMITATION  
STONES ALWAYS IN STOCK.

Our Specialty is Scientific Rubies.

Local and out of town jobs promptly attended to at reasonable prices. Send us your mountings to be set with matched stones. A trial order will convince you that our prices are right, and our goods select.

**THE MUELLER LAPIDARY CO.,**

248 Halsey Street, Newark, N. J.

**CUTTERS**

Precious and Semi-Precious Stones.

**Trade-Marks** of the Jewelry and Kindred Trades.  
Second Edition. Price, \$3.00. The Jewelers' Circular Publishing Co., 11 John St., New York.



## COOPER'S SUN RAY DIAMOND

HAS 100 per cent. more brilliancy than any other style of cutting.

**We Challenge the World.**

Send your old mine and yellow diamonds to be recut; if the effect is not 100 per cent. better, NO CHARGE.

## COOPER DIAMOND

Cutting and Polishing Industry of America

49 MAIDEN LANE, NEW YORK.

Factories, 8th Ave. & 18th St., Brooklyn.



TRADE-MARK.

## AZTEC TURQUOISES

Mines: MINERAL PARK, ARIZONA.



TRADE-MARK.

Of true CERULEAN BLUE, the rarest and most fashionable shade. Turquoises bearing Company's trade-mark are GUARANTEED. A new Turquoise will be given without question to replace any that discolors. The leading Jewelers of the World sell AZTEC TURQUOISES.

## THE AZTEC TURQUOISE COMPANY,

12-16 JOHN STREET, NEW YORK.

THE BOSTON DIAMOND HOUSE

## JOHN B. HUMPHREY CO.

387 Washington St., Boston, Mass.

We are receiving Monthly Shipments of Diamonds from our Brazilian Mines, which are on exhibition at our Boston Office.

Cutters of  
DIAMONDS

Cutters of  
DIAMONDS



## San Francisco Jewelers Pluckily Resume Business.

**Wholesale and Retail Firms Rapidly Finding Locations—Many Obtain Quarters in the Jewelers' and Silversmiths' Building—Other Towns That Suffered.**

SAN FRANCISCO, Cal., May 9.—The wholesale jewelers are already doing business again, and there is a general feeling throughout the trade that the revival will be quick and complete. Several of the wholesale dealers are preparing to go east to look over the situation and make any new arrangements that may be necessary. With one or two exceptions all of the wholesale jewelers will return to this city from Oakland within the next few weeks. As a general rule quarters have already been secured in buildings which are now being constructed.

The retailers will, generally speaking, be a little slower in getting under way. Such concerns as Shreve & Co., Hammersmith & Field, the W. K. Vanderslice Co. and Col. A. Andrews will probably make an early start, but the smaller stores will naturally wait for insurance and building matters to be settled. Some will even postpone reopening until the city has been so far rebuilt that the inhabitants will again have time to think of luxuries.

The most important movement in the trade during the week was the securing of a jewelers' and silversmiths' building here. The former Kamm building, at 717 Market St., has been renamed and will hereafter be known as the Jewelers' and Silversmiths' building. It will be occupied exclusively by wholesale jewelers and silversmiths and by the supply trade.

A. I. Hall & Son, who are located temporarily with H. Morton, at 1151 Broadway, Oakland, expect to get into their new quarters in the Jewelers' and Silversmiths' building, Market St., here about May 15. Some little delay may be caused by the difficulties in transporting the company's two new safes, now in the Southern Pacific Railway yards, to the Kamm building and in hoisting them to the new quarters of the company.

Julius A. Young, now temporarily located in the Globe Hotel, Broadway, Oakland, has arranged for quarters in the Jewelers' and Silversmiths' building, into which he will move before June 1.

H. C. Van Ness & Co., formerly located at 115 Kearny St., opened their safes this week and found all of the stock intact. It was reported that a quantity of melted silver was stolen from the company's quarters by looters before it could be rescued by the owners. This firm will soon open at 717 Market St.

H. Morton, Oakland, Cal., is now opening his new store at 1151 Broadway. He has two new safes in the freight sheds here which will be installed in the new store during the coming week. Mr. Morton hopes to have everything in complete running order by May 15.

Nordman Bros. have opened temporarily at 2505 Clay St., from which place they will shortly remove to the Jewelers' and Silversmiths' building.

The Morgan & Allen Co., which is making its temporary quarters at 1867 Post St., has also arranged for permanent offices and salesrooms in the Jewelers' and Silversmiths' building.

The Nathan-Dohrmann Co. was one of

about two dozen retailers that formed a compact, last week, agreeing to take united action in the matter of a temporary location. The Executive Committee appointed by these retailers selected a site on Van Ness Ave., which will accordingly become temporarily the retail center of San Francisco.

The Columbia Loan Office & Jewelry Store, formerly located at 9 Grant Ave., has now opened for business at the southwest corner of Ellis and Hyde Sts.

Wm. B. Glidden, agent for R. Wallace & Sons Mfg. Co., E. G. Webster & Son, and Wm. S. Hicks & Son, who was burned out here in the big fire, is located temporarily at 1116 Broadway, Oakland. Mr. Glidden will return to this city just as soon as new quarters can be prepared for him in the Jewelers' and Silversmiths' building.

W. E. Graves, a jobber in silverware and cut glass, formerly at 120 Sutter St., is located temporarily in the Globe Hotel building, Broadway, Oakland, from which place he will remove to the Jewelers' and Silversmiths' building here in about two weeks.

Henry M. Abrams, who had been at 708 Market St., will go to the Jewelers' and Silversmiths' building, and expects to be installed there before June 1.

Wm. Glindemann, a jeweler and watchmaker, formerly in the Examiner building, at the corner of 3d and Market Sts., has announced that he will reopen in substantially the same location as soon as the building can be rebuilt.

Armer & Weinschenk have arranged for new supplies on a large scale, and will resume business in the Jewelers' and Silversmiths' building within two or three weeks. This firm was located at 220 Sutter St. before the fire and earthquake.

Anderson & Lewis, wholesale jewelers, who were burned out, will also follow the trade into the Jewelers' and Silversmiths' building within the next few weeks.

Burr W. Freer, formerly in the Spreckles building, at the corner of Market and 3d Sts., will soon be located in the new jewelry center. Mr. Freer represents the New England Watch Co. and other eastern houses.

Ehrenberg & Wurfheim, formerly at 126 Kearny St., in the Thurlow block, have established temporary offices at 1067 Broadway, Oakland, where mail and express matter is being received. The firm has not yet secured a salesroom, but will arrange to remove to this city as soon as suitable quarters can be obtained.

The Alphonse Judis Co. expects to move back to its old quarters in the Mutual Savings Bank building very soon. The concern is at present located on Broadway, near 12th St., Oakland.

F. R. Deremer & Co. are settled in temporary quarters at 217 Church St.

The Gorham Mfg. Co. still has offices at 1103½ Broadway, Oakland, where it will remain until a desirable location can be obtained here.

Shreve & Co. opened offices May 14 at 1103½ Broadway, Oakland.

J. B. Whitney & Co., successors to J. B. Whitney, the new partner being W. J. Browne, are now at 1116 Broadway, Oak-

land, but will shortly move into the Jewelers' and Silversmiths' building, in this city.

The following letter, received by THE CIRCULAR-WEEKLY from Shreve & Co., is self-explanatory:

SAN FRANCISCO, Cal., May 8, 1906.

Editor THE JEWELERS' CIRCULAR-WEEKLY:

This is addressed to you in behalf of the jewelers and silverware workers of San Francisco. The conditions here since the fire are such that an appeal for assistance to their fellow workmen throughout the country is imperative, and in their behalf we address this letter, with a request that you publish it and arrange, if possible, through your publication, to bring this condition and this appeal to the attention of the various trade organizations throughout the Eastern States.

There is now being organized in the jewelry and silverware trades here a Jewelers and Silverware Workers' Relief Association. It will be composed of the wholesale and retail firms, with relief committees selected from among the workmen in these trades, and this association requests that contributions of money and clothing of all kinds, particularly underwear and shoes, be supplied, suitable for all ages from earliest infancy to grown men and women; such contributions should (that is, clothing, where the packages are small) be sent by express immediately, and money by bank draft or money order, payable to the above named association at San Francisco. The conditions which will exist here among the workmen during the next three or six months will be serious, and the organization is being formed anticipating these conditions. The further particulars, as to the officers of the association, will be communicated to you later, as soon as determined, which will be within the next six or seven days.

As funds have already been received from the Mauser Mfg. Co. and their employes and from the Greenleaf & Crosby Co., we expect to turn these funds over to the association when its organization is completed.

We make this appeal for the organization to save time in obtaining results.

Yours very truly,

SHREVE & Co.,  
By Bruce Bonny.

Attention has been forcibly called in the last week to the fact that jewelers in the smaller cities of California suffered losses in the earthquake which at any other time would have evoked the utmost sympathy and prompt assistance of people in the trade, but which have been partly overlooked in view of the awful calamity in San Francisco.

G. W. Mabie, of Mabie, Todd & Bard, pen and pencil manufacturers, 30 Fulton St., New York, was on a western trip at the time of the earthquake and on the Saturday following arrived in Chicago. Here, on request, he gave his check for \$500 to the fund being raised by the stationers of that city, and said that he would give an equal amount on his return to New York. By the time he got back to this city he had heard of the misfortune of jewelers in the smaller cities and decided to divide the

**WM S. HEDGES & CO.,**

IMPORTERS AND CUTTERS OF

**DIAMONDS.**

Precious Stones and Pearls.

**170 Broadway, Corner Maiden Lane, New York.**

27 Holborn Viaduct, London.

**Saunders, Meurer & Co.** Cutters and Importers of

**DIAMONDS** AND OTHER  
PRECIOUS STONES

FINE PEARLS A SPECIALTY.

65 Nassau St., cor. John St., Prescott Building, Telephone, 1613 Cortland, **NEW YORK.**

**Chas. L. Power & Co.,** Cutters and Importers,

**DIAMONDS**

AND OTHER PRECIOUS STONES,

170 Broadway, corner Maiden Lane, **NEW YORK.**

27 Holborn Viaduct, London.

**GOODFRIEND BROS.,**

IMPORTERS AND CUTTERS OF PRECIOUS AND IMITATION STONES.

**Pearls**

**Rubies**

**Sapphires**

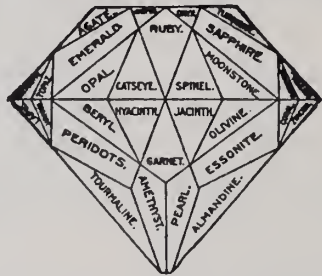

**Tourmalines**

**Gem Corals**

**Opals**

**Emeralds**

COPYRIGHT, 1895, BY GOODFRIEND BROS.

256 Westminster St., Providence, R. I.  
10 Rue Cadet, Paris.

Tel. No. 682 Cortl't.

9-11-13 Maiden Lane, New York.

**CORAL**

**BORRELLI & VITELLI,**  
CORAL MANUFACTURING COMPANY,

All kinds of Coral—DROPS, BUTTONS, LENTILLES.  
CORAL NECKLACES, Graduated and Uniform.

**PINK AND WHITE CORAL A SPECIALTY.**

GOLD MEDAL, ST. LOUIS, 1904.  
GRAND PRIX, LIEGE, 1905.

3 Via Amedeo, Torre del Greco, Italy. 32 Rue d'Hauteville, Paris, France.

401 Broadway, New York.

Telephone, 5412 Franklin.

**CORAL**

**CORAL**

**Mr. Retailer:**

The Jobbers  
are taxing  
us to our  
utmost capacity  
with orders  
for the best  
line of  
Gold Watch  
Cases we ever  
created.

You will be  
pleased with  
their selections,  
we assure you.

**"WATCH OUT"**

**SOLIDARITY**  
**Watch Case Co.**

Established 1885.

3 Maiden Lane, New York.

GENERAL SELLING AGENTS

JOHN W. SHERWOOD

FRANK E. HARMER

\$500. He accordingly sent \$200 to Santa Rosa, \$200 to San José and \$100 to Oakland. At the same time he called attention of the relief committee of the Board of Trade to the distressed conditions of jewelers in these smaller places, and said that if the committee would expend \$500 in relieving the distress of the Santa Rosa jewelers he would add \$100 to what he had already sent.

Mr. Mabie, since sending his donations to the cities mentioned, has received a number of interesting letters, which set forth quite fully the conditions of the jewelers in those cities. John Hood, of Santa Rosa, gave an especially vivid account of the destruction brought in that city by the earthquake. L. V. Carter, one of Santa Rosa's jewelers, and his wife were killed and all the jewelers in the place practically lost everything they had. The letter to Mabie, Todd & Bard, which is dated May 4, follows:

"We appreciate very much your sympathy and help you have extended to us in the hour of terrible calamity.

"Mayor Overton is an old friend of mine, and I know that whatever you send him will be placed to the best advantage. It is being used to provide employment for those in need. As is often the case, the smaller places may be overlooked, when they really suffer more than the large cities. As it was, the earthquake was more severe here than in San Francisco, and what the earthquake left went up in flames. Our losses in lives and property was more in proportion than theirs. There was not a business house left standing, and 13 blocks out of 16 were burned. We had plenty of water, but were handicapped by the buildings falling on the engines and some valuable teams. The fire broke out in so many places that it was all we could do to keep it from spreading to hotels and some of the lodging houses, where there were a number of persons buried in the ruins.

"Our loss in killed will run close to 100 and several hundred were more or less injured. All the jewelers were caught in the earthquake, and all but Al Sawyer were in the burned district. My loss was \$25,000, with \$8,000 insurance, safe in good condition. Mr. and Mrs. Carter, both killed; loss \$10,000; don't know about insurance; safe not opened. Mr. E. F. Heath, loss \$5,000; no insurance; contents of safe ruined; H. K. Eckstrom, loss \$2,500; insurance \$250; contents of safe ruined. A. P. McGregor, loss \$500; no insurance. Max Noack, \$500; no insurance. Robert Kirk, \$500; no insurance. Al Sawyer, \$250; no insurance; not burned.

"I will have enough to pay my debts if I get my insurance, but I wish to call attention to the other watchmakers and jewelers that were not so fortunate as I was: Mr. Heath, the jeweler, and Messrs. H. R. Eckstrom, A. P. MacGregor, Max Noack and Robert Kirk, who have lost all their tools and nearly everything they had. Four of them have families dependent upon them, and Mr. Noack lost everything but his nightshirt. I was going to suggest that in case you were going to send any more money that, instead of sending it to the Mayor, send them some tools and material. They are placed in a very bad fix, as they

have been buying from San Francisco, which city is not in a position to help them. They are working at anything they can get at present, but in a place like this, where all merchants will be more or less embarrassed, and there will be a number thrown out of employment, they will have a hard job getting work. In San Francisco people had some time to save something, but it was all over with us in 30 seconds. So if you could send them some money or tools and material (the sooner the better), it would put them on their feet again. You could either send it to me or direct to them.

"I will have enough, with what I get from the insurance companies and what I saved from my safe, to pay all my debts, so I am a little more fortunate than the others.

"Hoping you will be able to help them, as I think they are all deserving, and again thanking you for what you have done for us.  
Yours truly,  
"JOHN HOOD."

Other letters which Mr. Mabie received included the following from the Mayor of Oakland:

OAKLAND, Cal., May 5, 1906.  
Messrs. Mabie, Todd & Bard, New York, N. Y.:  
Gentlemen—I am in receipt of your check for \$100 to be used for the benefit of the people rendered homeless by the San Francisco disaster. I also notice that you have decided to send \$500 more in addition to your original contribution of \$500, to San Francisco, and you will distribute same among the smaller cities. Your prompt and generous action is greatly appreciated and you may rest assured that the money will be used where it will do the most good. Yours very truly,  
FRANK K. MOTT.

Would suggest that Santa Rosa be favored. They need help badly.

Letters from the Mayors of Santa Rosa and San José each acknowledge the receipt of \$200 from Mr. Mabie and return thanks in a most feeling manner.

Mr. Hood, under date of May 7 wrote to THE CIRCULAR—WEEKLY, of which he is an old subscriber, emphasizing the fact that the watchmakers and jewelers of Santa Rosa are placed in a very unfortunate position. He said that they traded mostly in San Francisco, where the jobbers are now unable to render assistance. All the jewelers, he says, are anxious to go to work if they can get tools and material. Mr. Hood adds: "As our loss in life and property was nearly as much as Charleston, S. C., with one-fifth the population, you can imagine how much damage was done. As I am out of my own stationery I have to make use of anything I can get. I expect to get started up as soon as I get a location."

W. L. Carter, whose death is announced in the above letter, was well known in the jewelry trade, as he was a practical jeweler, and had been in the business for over 30 years. Many years ago he conducted a store at Grand Lodge, Mich., but met with reverses, and in 1886 he became manager for the business of his wife, Fanny W. Carter, who died in 1891. For a while he acted as agent for her estate, and a few years later moved to San Luis Obispo, where he remained for some time, and finally settled in Santa Rosa, March, 1898. Here he married again. His second wife, Mrs. L. V. Carter, purchased the business in the estate of his former wife, and since that time it has been conducted under her name,

but run under the management of W. L. Carter.

Contributions to the Jewelers Board of Trade's San Francisco Relief Fund acknowledged up to last week amounted to \$32,619. The board received the following since that time: Emma O. Hartwig, \$50.53; M. Bolotin, \$26; Wallach & Davidson, \$25; Heintz Bros., \$100; Jos. Fahys & Co., \$500; Jas. C. Aikin, \$50; D. C. De Lara, \$5; E. Aron, \$2; S. J. Cohen, \$2, making a total of \$760.53, and a grand total to date of \$33,379.53.

**New Members Elected by the Jewelers' Security Alliance.**

The regular monthly meeting of the executive committee of the Jewelers Security Alliance was held on Friday, the following members being present: President Sloan, Vice-Presidents Wood and Champenois, Chairman Butts, Treasurer Karsch, Secretary Noyes and Messrs. Abbott, Alford, Bowden, Brown and Stern of the committee. The following new members were admitted:

C. S. Allison & Son, Owosso, Mich.; S. H. Avey & Co., Auhurn, Nebr.; Frank R. Cooley, Bound Brook, N. J.; A. Engelmann, Chicago; W. C. Flatau, Omaha, Nebr.; Chas. W. Fleming, Lincoln, Nebr.; Harry C. Kahn, Philadelphia, Pa.; Fred Marcus, Denison, Tex.; Jos. M. Parker, Jr., Philadelphia, Pa.; Philleo & Nutting, Oelwein, Ia.; Staudt & Co., Tiffin, O.; L. J. Viersen, Chicago; J. A. Aumert, Chicago; C. A. Holmes, New Berlin, N. Y.; Frank R. Montgomery, Sandusky, O.; C. Rech & Son, Newark, N. J.; C. F. Wood, Altoona, Pa.; J. H. Bate & Co., Barnesville, Ga.; Chas. A. Daniels, Gilhertsville, N. Y.; J. Forstrom, Chicago; W. Forstrom, Chicago; Furbish, Swift & Fisher, North Attleboro, Mass.; E. & F. Gleim, Ottawa, Ill.; Mrs. B. Gottlieb, Pine Bluff, Ark.; E. W. S. Pratt, Corvallis, Ore.; J. M. Prockter, Chicago; David Stern, Chicago; Chas. Eshenger, Sr., Cincinnati, O.; J. H. Hasenritter, Hermann, Mo.; Thos. Lockhart, Kenosha, Wis.; James H. Mills, Newberg, Ore.; A. I. Polan, Charleston, W. Va.; J. Saueremann, Milwaukee, Wis.; Frank Tarrant, Rochester, N. Y.; B. W. Thien, Milwaukee, Wis.; T. S. Arthur, Fond du Lac, Wis.; Birley & Son, Oshkosh, Wis.; J. R. Chapman & Co., Oshkosh, Wis.; O. G. Cogizer, Weeping Water, Nebr.; Gordon & Reamer, Meadville, Pa.; Rainey & Aely, Pittsfield, Mass.; J. Freshman, Vactor, Colo.; Floyd J. Wemett, Livonia, N. Y.

**Jewelers Gold Bars Withdrawn and Exchanged at New York.**

Week Ended May 12, 1906.  
The U. S. Assay Office reports:  
Gold bars exchanged for gold coin.....\$405,999.62  
Gold bars paid depositors..... 115,700.20

Total .....	\$521,699.82
Of this the gold bars exchanged for gold coin are reported as follows:	
May 7.....	\$72,205.30
" 8.....	36,362.72
" 9.....	76,998.49
" 10.....	45,599.23
" 11.....	164,552.01
" 12.....	10,281.87
Total .....	\$405,999.62

**Market Price of Silver Bars.**

The following are the quotations of silver bars in London and New York, as reported by Zimmermann & Forshay:

	New York.	London.
May 8.....	\$.663 $\frac{1}{4}$	30 7-8d.
" 9.....	.67	31d.
" 10.....	.67	31d.
" 11.....	.663 $\frac{1}{4}$	30 7-8d.
" 12.....	.67	30 15-16d.
" 14.....	.663 $\frac{1}{4}$	30 13-16d.

ADDISON W. WOODHULL, President.  
FRANK K. HUFF, Vice-President.

GILBERT T. WOODHULL, Treasurer.  
WILLIAM J. McQUILLIN, Secretary.

## MOUNT & WOODHULL,

IMPORTERS OF

DIAMONDS,  
OTHER PRECIOUS STONES,  
PEARLS, ETC.

MAKERS OF

FINE  
DIAMOND  
JEWELRY.

26 Maiden Lane,

(Southwest Corner Nassau Street)

NEW YORK.

PARIS ADDRESS:  
5 SQUARE DE L'OPERA.

**BAGG, PERINE & CO.,**  
RARE SPECIMENS OF  
DIAMONDS AND OTHER  
PRECIOUS STONES,  
21 & 23 MAIDEN LANE, NEW YORK.  
Tel. No. 6226 Cortlandt.

EMERALDS,  
DIAMONDS  
AND  
PEARLS.

RUBIES AND  
SAPPHIRES.

CABLE ADDRESS:  
MILBAGG.

A word to the wise is sufficient

"GEMFINDER"

## Crossman Company

There is nothing that appeals more to a June bride for her bridesmaid's gifts than the dainty and inexpensive Necklaces and Pendants that we make.

3 Maiden Lane, - New York.

### New England Watchmakers' Club Holds Interesting Meeting at Boston, Mass.

Boston, Mass., May 9.—The New England Watchmakers' Club held a meeting at room 6, Lowell building, Massachusetts Institute of Technology, last evening. There was a good attendance, and it was decided to continue the organization with the present officers and the addition of several non-Boston members to the directorate, so as to increase the interest of watchmakers at other places and to prevent the club becoming exclusively a Boston institution.

Several interesting papers on details of watchmaking and repairing were read by members of the club. Mr. Kendrick, of Kendrick & Davis, watch toolmakers of Lebanon, N. H., who is a member of the club, offered two sets of fine pearl handled watchmakers' screw drivers for the best two papers and the committee on award awarded them to C. M. Smith, who is with Gordon & Bergen, this city, and to F. J. Whilton of 345A Washington St., Boston.

Mr. Smith's paper treated of the balance and escapement on readjusting watches. Mr. Whilton's paper was on rebushing plates and uprighting wheels by the use of a staking tool. After calling attention to the fact that in many watches—especially those of foreign make—the center and fourth wheels are not upright, he spoke of wheels being thrown out of upright by the plate holes becoming too large or elliptical. He then described the method of bushing when the workman had a full set of tools, the method used at the Waltham factory, and the method pursued by workmen who did not have a full set of tools. He offered suggestions of a simple method of uprighting and bushing by the aid of a good staking tool and a few accessories, which he described and of which he showed diagrams. He finished with the description of the operations of bushing the lower center pole and putting a new shoulder or pivot to lower center; operations often necessary in repairing foreign made watches.

One of the committee on award commented on the great practical value of Mr. Whilton's paper.

The club will hold its next meeting May 22. There is some talk of a banquet in the not far distant future.

### Death of A. Grebles.

SILVERTON, Colo., May 9.—It was with deep regret that the many friends of A. Grebles, one of the oldest jewelers of the State, heard that he had died suddenly last week of apoplexy. Mr. Grebles is survived by two sons and a daughter.

The deceased was a pioneer of the San Juan, and was about 90 years of age. He was the founder of the Grebles Jewelry Co., which conducted business in Silverton successfully for many years, but owing to his age had for some time not taken active part in the management of the concern. For a while his business was managed by H. O. Woodbury. Mr. Grebles was prominent both as a merchant and a jeweler and was highly respected in the community. In the Masonic Order he stood very high, and the funeral, which took place Sunday last, was under the auspices of that fraternity.

**New Step Rate Assessment Plan of the Jewelers' League Now In Operation.**

At the regular monthly meeting of the Executive Committee of the Jewelers' League of New York, held recently, the following members were present: President Street, Vice-Presidents Greason, Karsch and Lissauer, Messrs. Gough, Sloan, Hodenpyl, Wormser and Secretary Marsellus. The usual routine of business was transacted and a number of applicants admitted to membership from Chicago, Jersey City, Brooklyn and New York. Nineteen requests were received from members desiring to increase the amount of their insurance, which requests were duly approved and granted.

The plan recently adopted by the League at its annual meeting, held in January last, which went into effect on May 1, is meeting with general approval as it is not only equitable and just, but it places the League on a sound and thoroughly scientific basis and gives assurance to its certificate holders that it will pay the certificates that it has issued or may issue in the future in full.

The plan is generally considered by the management to be the best ever adopted to place on a sound basis a society which has heretofore operated under the post-mortem assessment plan. The League is deemed to have acted wisely in selecting a plan which is a modification of the natural premium and level premium, and such a combination of the two correct plans of life insurance it is believed will commend itself to all the members of the League as well as to persons desiring life insurance at a low cost in a good sound organization.

The new plan which is in operation this month is what is known as the yearly "step-rate," and has the endorsement of the best actuaries and promises to place the organization on a thoroughly enduring basis. The past record of the League shows that it has paid to beneficiaries of deceased members over \$3,000,000, and never disputed or compromised a claim since its organization.

Following is the monthly rate of payments graded according to the age at joining, which began this month.

TABLE OF RATES.

Age.	Sec. 1.	Sec. 2.	Sec. 3.	Sec. 4.	Sec. 5.
	\$1,000.	\$2,000.	\$3,000.	\$4,000.	\$5,000.
21.....	\$0.64	\$1.28	\$1.92	\$2.56	\$3.20
22.....	.65	1.30	1.95	2.60	3.25
23.....	.67	1.34	2.01	2.68	3.35
24.....	.69	1.38	2.07	2.76	3.45
25.....	.71	1.42	2.13	2.84	3.55
26.....	.73	1.46	2.19	2.92	3.65
27.....	.75	1.50	2.25	3.00	3.75
28.....	.76	1.52	2.28	3.04	3.80
29.....	.78	1.56	2.34	3.12	3.90
30.....	.80	1.60	2.40	3.20	4.00
31.....	.82	1.64	2.46	3.28	4.10
32.....	.84	1.68	2.52	3.36	4.20
33.....	.86	1.72	2.58	3.44	4.30
34.....	.89	1.78	2.67	3.56	4.45
35.....	.92	1.84	2.76	3.68	4.60
36.....	.96	1.92	2.88	3.84	4.80
37.....	.99	1.98	2.97	3.96	4.95
38.....	1.02	2.04	3.06	4.08	5.10
39.....	1.06	2.12	3.18	4.24	5.30
40.....	1.10	2.20	3.30	4.40	5.50
41.....	1.14	2.28	3.42	4.56	5.70
42.....	1.18	2.36	3.54	4.72	5.90
43.....	1.23	2.46	3.69	4.92	6.15
44.....	1.28	2.56	3.84	5.12	6.40
45.....	1.32	2.64	3.96	5.28	6.60
46.....	1.37	2.74	4.11	5.48	6.85
47.....	1.44	2.88	4.32	5.76	7.20
48.....	1.50	3.00	4.50	6.00	7.50
49.....	1.56	3.12	4.68	6.24	7.80
50.....	1.64	3.28	4.92	6.56	8.20
51.....	1.72	3.44	5.16	6.88	8.60
52.....	1.80	3.60	5.40	7.20	9.00

53.....	1.91	3.82	5.73	7.64	9.55
54.....	2.02	4.04	6.06	8.08	10.10
55.....	2.13	4.26	6.39	8.52	10.65
56.....	2.27	4.54	6.81	9.08	11.35
57.....	2.40	4.80	7.20	9.60	12.00
58.....	2.54	5.08	7.62	10.16	12.70
59.....	2.67	5.34	8.01	10.68	13.35
60.....	2.80	5.60	8.40	11.20	14.00
61.....	2.94	5.88	8.82	11.76	14.70
62.....	3.10	6.20	9.30	12.40	15.50
63.....	3.30	6.60	9.90	13.20	16.50
64.....	3.53	7.06	10.59	14.12	17.65
65.....	3.75	7.50	11.25	15.00	18.75

**Preparations for Meeting to Form Retail Jewelers' Association of South Dakota.**

ABERDEEN, S. Dak., May 9.—Preparations are under way to make the meeting for the purpose of forming a State association of jewelers, which will be held here on June 1, a success in every way. It is the endeavor of those behind the movement to have the meeting about the same time as the State Optical Association, so that the attendance will be large. The first week in June was decided on, as this is the time that the State Traveling Men's Association will meet here, with the result that reduced rates will be given by the railroads on tickets for this town.

A. W. Voedisch, D. G. Gallett and O. B. Tripp are in a great measure responsible for the progress that the movement has made. They have sent letters to jewelers in all sections of South Dakota inviting them to be present at the meeting. The answers which they have received have been most gratifying, indicating that there will be a large attendance. It is expected that the project of forming a State association will be enthusiastically received, and that the jewelers of South Dakota will line up with those of other States in an organization of which they can be proud.

**Death of W. H. Loomis.**

RAWLINS, Wyo., May 9.—W. H. Loomis, who died suddenly May 5 of pneumonia, was prominent in the retail trade in this section, having been in business in Rawlins continuously since 1892. He was essentially a repairer, but carried a small stock, and was well thought of in the trade and community.

The deceased was prominent in fraternal orders, being Past Exalted Ruler of the Elks in this town and had been elected delegate to the convention of that order, which is to be held at Denver. He was also a member of the Eagles, the I. O. O. F, the W. O. W. and the Jewelers Security Alliance.

Mr. Loomis is survived by a widow and two sons.

**Walter Oates, Little Rock, Ark., Goes Into Bankruptcy.**

LITTLE ROCK, Ark., May 9.—Walter Oates, a watchmaker, has filed a voluntary petition in bankruptcy in the United States Circuit Court. According to the schedules filed with his petition his liabilities are about \$1,000; among the assets claimed as exempt are merchandise and his homestead.

Mr. Oates began business here about two years ago, and though a practical man of good reputation, industrious and able, he has had little capital. He is a negro and about 32 years old. His liabilities in the trade are not large, and he has practically no creditors in the big centers.

**Well Known Swindler Rearrested Immediately After Serving a Three Years' Term in Sing Sing Prison.**

ST. LOUIS, Mo., May 9.—Advices have been received here of the arrest while on the way from Sing Sing of Lewis McDowell, alias Albert L. Brown. Immediately before his arrest McDowell had just finished serving a term of three years in the New York State prison for swindling Tiffany & Co., New York, out of a diamond brooch, by passing as J. Pierpont Morgan, Jr., on Nov. 3, 1903.

The charge upon which McDowell is being held now and for which he probably will be extradited from New York, is swindling the Mermod, Jaccard & King Jewelry Co., securing a diamond brooch



LOUIS C. M'DOWELL, Rearrested on St. Louis charge.

valued at \$1,500 from that firm upon the representation that he was William J. Lemp, Jr., son of a wealthy brewer. The fraud occurred several years ago, McDowell was convicted, but escaped.

McDowell is said to be wanted in a dozen cities for work similar to that above described. He represented himself to be the son of prominent men and, during his career, which, the police say, began in 1896, he practiced many swindles.

McDowell was convicted here and sentenced to three years in prison. While being taken to the penitentiary at Jefferson City, he and another convict to whom he was shackled, jumped from the train at Glencoe, Mo., and both escaped. McDowell is said to be a convincing talker and a fashionable dresser. The brooch which he secured here was never recovered.

The career of Brown or McDowell has been traced at various times in the pages of THE CIRCULAR-WEEKLY. On Oct. 14, 1903, an account was given of his arrest in New York. At that time he was passing in various stores as J. P. Morgan, Jr. He had succeeded in obtaining a diamond pin from Tiffany & Co. and had also swindled other firms. He was sent up on the Tiffany charge.

Charles C. Nowen, Collinwood, O., has been succeeded by G. R. Brainard.

Frank Murdock, Ligonier, Pa., recently moved his stock into larger quarters.

# EICHBERG & CO.,

IMPORTERS AND CUTTERS OF

## DIAMONDS,

65 NASSAU STREET,

(Prescott Building.)

NEW YORK.

# STERN BROS. & CO.,

IMPORTERS AND CUTTERS OF

## DIAMONDS,

CUTTING WORKS:  
138-142 West 14th St., N. Y.

CHICAGO,  
103 State Street.

LONDON,  
29 Ely Place.

68 Nassau St.,

NEW YORK.

**A. ROSEMAN, 9-11-13 Maiden Lane, New York**

IMPORTER OF

# DIAMONDS

Maker of Diamond Jewelry



TRADE-MARK.

Established 1872

HEADQUARTERS FOR

# AMERICAN WATCHES

IMPORTERS

## DIAMONDS

CUTTERS

# Jacob Strauss & Sons

14 MAIDEN LANE

NEW YORK

**LEO GOLDSMITH, IMPORTER OF DIAMONDS**

TELEPHONE: 4115 CORTLAND.

and Precious Stones. Headquarters for Reconstructed Rubies and Sapphires. All sizes and forms.

9-13 MAIDEN LANE.

NEW YORK.

## SOHN and HYMAN

IMPORTERS OF PRECIOUS AND IMITATION STONES

Crystals Engraved and Painted from Photo. Crests and Coats of Arms Engraved. Stone Seal Engravers and Incrusters. Lapidary Work a Specialty.

JOBING STONES A SPECIALTY

47 and 49 Maiden Lane,

NEW YORK

# AMERICAN PEARLS

*From Ten to Ten Thousand Dollars Each.*

MAURICE BROWER, 16 John St., New York.

## TRADE-MARKS

OF THE JEWELRY AND KINDRED TRADES.  
Over 4,000 Marks. Second Edition. Price, \$3.00.  
The Jewelers' Circular Pub. Co., 11 John St., N. Y.

### Opposes Transfer.

Former Vice-President of Gorham Mfg. Co. Seeks to Prevent Carrying Out of Plans Adopted at Annual Meeting.

PROVIDENCE, R. I., May 12.—A bill of complaint was filed last Friday in the office of the clerk of the United States Circuit Court by George H. Robinson in the suit he is bringing against the following defendants: Edward Holbrook, John S. Holbrook, John F. P. Lawton, Frederick P. Lawton, E. Frank Aldrich, George E. Martin, Henry S. Sprague, Russell Grinnell, Herbert J. Wells and the Gorham Mfg. Co. This action is an outcome of the proceedings taken at a meeting held recently by the stockholders of the Gorham Mfg. Co., at which it was decided to increase the capital stock of the Silversmiths' Co. of New York for the purpose of making certain changes in the system of conducting the several affiliated silverware companies. An account of the action at that meeting was published last week in THE CIRCULAR-WEEKLY. All the stockholders voted in the affirmative, except Mr. Robinson, the vote standing 32,265 shares in the affirmative and 3,251 in the negative. At the time Mr. Robinson intimated that he would appeal to the courts in an effort to prevent the other stockholders from carrying out the plan which they had agreed upon.

In the complaint Mr. Robinson sets forth that the Silversmiths' Co. and the Gorham Mfg. Co. have been under the control of the defendants, and that if they carry through their plan the business of the latter would be diverted to the Silversmiths' Co., involving loss to stockholders in the Gorham Mfg. Co. The plaintiff asked for a preliminary injunction restraining the respondents from carrying out their plans. The hearing on this question was set down for Wednesday of next week at 10 A. M.

To-day the respondents appeared by their counsel, Richard B. Comstock, of Comstock & Canning, and filed a stipulation agreeing to take no action regarding the transfer of stock until the further order of the court. Walter B. Vincent, of Vincent, Boss & Barnfield, representing Mr. Robinson, objected to the stipulation, and asked that a restraining order be issued instead, but Judge Brown held that the stipulation was sufficient until the hearing on the motion for a preliminary injunction.

The respondents in the suit have made no statement as yet as to their position. A gentleman acquainted with the circumstances said: "Mr. Robinson, under the proposed plan, would have the same right as any other stockholders to exchange his stock in the Gorham Mfg. Co. for Silversmiths' stock. If he prefers he may sell his Gorham stock outright, or he may retain it, being treated just the same as all the stockholders. It is absurd to say that anybody desires to divert business from the Gorham Mfg. Co., for every stockholder knows that if the plan is carried through the dividends of the Silversmiths' Co. will depend chiefly on the Gorham Mfg. Co.'s earnings."

E. J. Santhony, formerly at Bedford, O., is now at Carrollton, O.

**Death of John J. Cumberson.**

LAFAYETTE, Ind., May 10.—John J. Cumberson, a prominent merchant of this town, who for a number of years was connected with the jewelry trade and was head of the old firm of Cumberson & Co., died last night at his home, 245 Wood St., West Lafayette, after a week's illness. The deceased had been in failing health for the past two years, and the immediate cause of his death was cancer of the tongue.

Mr. Cumberson was born in New York, March 30, 1833, and as a young man, in 1851, he came to Lafayette and entered the employ of P. P. Emerson, then a well known local jeweler. With Mr. Emerson he mastered the details of the jewelry business and remained until 1874, when the latter retired and Mr. Cumberson bought out the business. The deceased associated himself with Del K. Rising and Leo Kachlein, forming the firm of Cumberson & Co., which continued business under that style. Mr. Kachlein withdrew in a few years and Mr. Cumberson withdrew in 1891, finally selling out his entire interests to Mr. Rising. He later went into the grocery business, but retired entirely about 1898.

Mr. Cumberson was a quiet and unassuming man, with affable and courteous ways, which made him popular with all who knew him. Careful as a merchant, public spirited as a citizen, he was well thought of in the business community and prominent in all affairs which affected Lafayette. He was a lover of nature and outside of business spent much of his time fishing and on the water.

The deceased was twice married, but survived both wives. He leaves four daughters, Misses Carrie and Lottie Cumberson, Mrs. Bonnell and Mrs. Richard E. Crane, and a son, Perry A. Cumberson.

**E. D. Trebilcock, Detroit, Mich., Recovers Stolen Jewelry—Several Arrests Made.**

DETROIT, Mich., May 12.—Four colored men and four colored women were taken into custody, Friday night, on suspicion of being implicated in the robbery of E. D. Trebilcock's jewelry store, 324 Woodward Ave., on the night of April 19, when about \$2,000 worth of goods were taken. A sack containing most of the missing jewelry was found at 92 Clinton St., where a number of the suspects were arrested. Mr. Trebilcock identified most of the plunder as stock taken from his store.

The prisoners are not positively known to have had previous police records, except Harry Williams, alias Charles Walker, who, the authorities believe, was the leader. William Kindell left a ring at a jewelry store to be repaired, which was recognized. Walker had a number of diamonds when arrested. Not all of the plunder belonged to Jeweler Trebilcock, and the police believe the loot is part of the proceeds of another robbery.

J. C. Wakefield is a new jeweler in Healdsburg, Cal., where he has succeeded E. L. & L. W. Cheney.

J. W. Taylor, Gadsden, Ala., recently presented to the West Gadsden fire company a handsome stop watch with which the firemen can accurately time their practice races.

**National Monthly Import and Export Statistics.**

WASHINGTON, D. C., May 8.—The records of the Treasury Department contain the following comparative statistics of interest to the jewelry trade for March, 1905 and 1906, and for the nine months ended February, 1906:

	IMPORTS.		9 Months Ending—	
	Mch., 1905.	Mch., 1906.	Mch., 1905.	Mch., 1906.
Clocks and parts of.....	\$26,361	\$32,225	\$395,105	\$438,366
Watches, materials and movements.....	189,963	192,017	1,875,705	1,952,437
Diamonds, glaziers' diamonds, etc., not cut, and watch jewels (free).....	687,213	1,015,277	7,741,893	7,657,642
Diamond dust or bort (free).....	189,357	1,871	340,594	96,655
Diamonds, not set (dutiable).....	1,589,744	2,255,711	12,672,420	17,613,121
Precious stones, rough or uncut (free).....	17,423	12,402	271,908	105,391
Precious stones and pearls, not set (dutiable)....	612,682	371,278	3,523,061	3,772,753
Jewelry and manufactures of gold and silver.....	76,541	146,769	1,062,440	1,416,441

EXPORTS OF FOREIGN MERCHANDISE.			
	Mch., 1905.	Mch., 1906.	
Clocks and parts of.....	\$64	.....	\$1,782
Watches, materials and movements.....	35	.....	14,090
Diamonds, rough, including miners', glaziers', etc. ....	.....	\$279	.....
Diamonds, not set (dutiable).....	.....	19,888	1,282
Precious stones and pearls, not set (dutiable)....	37	53	332,996
Jewelry and manufactures of gold and silver....	1,781	55	29,509

EXPORTS OF DOMESTIC MERCHANDISE.			
	Mch., 1905.	Mch., 1906.	
Clocks and parts of.....	\$100,015	\$118,835	\$870,384
Watches and parts of.....	111,448	96,301	811,946
Jewelry and manufactures of gold and silver....	132,055	159,606	1,034,162
Plated ware .....	52,277	79,740	522,745

**Importations at the Port of New York.**

Weeks Ended May 12, 1905, and May 11, 1906.		
	1905.	1906.
China, Glass and Earthen Ware:		
China .....	\$106,403	\$124,644
Earthen ware .....	12,754	9,580
Glass ware .....	35,377	32,287
Optical glass .....	31	2,989
Instruments:		
Musical .....	17,532	6,869
Optical .....	4,015	7,632
Philosophical .....	1,570	695
Jewelry, etc.:		
Jewelry .....	5,095	10,062
Precious stones .....	730,330	602,051
Watches .....	30,863	21,483
Metals, etc.:		
Bronzes .....	1,023	2,333
Cutlery .....	36,483	13,642
Dutch metal .....	90	1,258
Platina .....	42,842	66,525
Plated ware .....	395	.....
Silverware .....	.....	783
Miscellaneous:		
Alabaster ornaments .....	123	79
Amber .....	635	2,091
Beads .....	4,715	3,898
Clocks .....	4,540	4,498
Fans .....	18,978	11,336
Fancy goods .....	3,084	13,463
Ivory .....	866	13,770
Ivory, manufactures of....	324	396
Marble, manufactures of....	8,523	16,115
Statuary .....	1,289	4,908

**Piedmont, W. Va., Jeweler and Clerk Assaulted and Tied Up by Thieves Who Steal Cash and Escape.**

PIEDMONT, W. Va., May 9.—The police authorities of this section are doing everything in their power to run down two negroes who, last Saturday, assaulted and robbed James Feaster, a local jeweler, and his clerk, Mr. Callihan. Though some clues have been obtained, the men have not yet been located.

Mr. Feaster started to close his store at 11 o'clock Saturday evening, after having locked the jewelry in the safe, when two unknown negroes entered while he was counting his cash, and, after a fight, succeeded in binding and gagging both Mr. Feaster and his clerk. Owing to the fact that the stock was locked up, the thieves were able to get but little, but they managed to secure \$97 in notes and change, Mr. Feaster's diamond ring and Mr. Callihan's gold watch.

Mr. Feaster and the clerk were left helpless in the store by the thieves, but their predicament was discovered by some persons passing by, a short time later, when they were released and immediately gave the alarm, but by that time the negroes had escaped.

The police Monday received word from Cumberland to the effect that a local policeman had been shot in the stomach at Rockwood by one of two negroes, who had been ejected from a Baltimore & Ohio freight train at Hyndman. It is believed that these were the two men that robbed Mr. Feaster.

**Jewelers Cautioned to be Wary of Masonic Railroad Engineer With Suave Manners.**

LAFAYETTE, Ind., May 9.—The trade is warned to be careful in dealing with a man who says he is a railroad engineer and passes as a 32d degree Mason, as he recently obtained a quantity of merchandise and money from merchants of this town. According to C. H. Ankeny & Co., the man obtained the goods on various plausible pretexts and then disappeared. He was last heard of in San Bernardino, Cal.

The man who gave the name of Souser while here, is unusually large, being about 6 feet 3 inches high, and weighing about 280 pounds. He is about 35 years old, has a florid complexion and dark hair. He is a good talker, has a suave manner and tells a plausible story.

Among the indictments reported last week at Cincinnati, O., were two against Grace Ethel, alias Mabel Hall, the bogus Salvation Army girl, who made a specialty of robbing jewelers. One indictment charges her with securing \$91 from the Oskamp Jewelry Co. by means of a forged check and the false representation that she was the daughter of F. D. Prentice. The second indictment charges that she secured \$90 in the same manner from the Duhme Jewelry Co.

SEND TO US ANY QUANTITY OF

# AMERICAN PEARLS

WE BUY FOR CASH.

Send by registered mail or express; we will make an offer by return mail. We will also buy any quantity of

## BAROQUE PEARLS (SLUGS).

# BUNDE & UPMAYER CO.,

Mack Block,

MILWAUKEE, WIS.

## R. BLACKINTON & CO.,

ESTABLISHED 1861.

3 MAIDEN LANE, NEW YORK.

FACTORY, NORTH ATTLEBORO, MASS.

### Manufacturing Jewelers and Silversmiths.

TRADE  MARK.

Toilet and Manicure Articles, Flatware, Sterling and German Silver Wrist Bags, Gent's and Ladies' Card Cases, Variety Boxes, Jewel Boxes, Match Safes, Picture Frames, Belt Buckles, Cigar Cases, Penknives and up-to-date Novelties.

R. BLACKINTON ESTATE.

W. B. BALLOU,  
WALTER BALLOU,

R. BLACKINTON, JR.  
J. R. MORSS.



### Silver Deposit

### Iridescent and Green Glass

ALSO IN

### Crystal Glass

**B**ASKETS in all shapes. Great sellers for weddings, etc. Always appropriate and acceptable gifts.

Only House to Decorate These in Silver. Phenomenal Sellers.

Depasse Manufacturing Co.  
41-43 Maiden Lane, New York

## Eliassof Bros. & Co.

IMPORTERS  
AND  
JOBBERS OF

### DIAMONDS WATCHES JEWELRY

9-11-13 MAIDEN LANE,  
NEW YORK.

100 STATE STREET,  
ALBANY, N.Y.



A LARGE ASSORTMENT OF DIAMOND  
MOUNTED JEWELRY CARRIED IN STOCK.



### American Association of Wholesale Opticians Holds Annual Meeting at New York and Elects Officers.

The annual meeting of the American Association of Wholesale Opticians took place Monday in the Astor House, New York. J. T. Brayton, Chicago manager of the Julius King Optical Co., as president of the association, occupied the chair. Edgar Brown, of McIntire, Magee & Brown, Philadelphia, Pa., acted as secretary in the absence of the incumbent of that position, A. Reed McIntire, who is now abroad.

Following is a list of those who were present: Edwin Beekwith, New York; D. V. Brown and Andrew Brown of D. V. Brown, Philadelphia, Pa.; H. E. White, of the Columbus Pharmaceutical Co., Columbus, O.; S. Galeski, of the S. Galeski Optical Co., Richmond, Va.; J. E. Brown, of the Geneva Optical Co., Geneva, N. Y.; A. G. Barber, of Globe Optical Co., Boston, Mass.; B. H. Blank, of Hammel, Riglander & Co., New York; John H. Hardin, of F. A. Hardy & Co., Chicago; J. T. Brayton, of the Julius King Optical Co., Chicago; Walter G. King and Leo Wormser, of the Julius King Optical Co., New York; Henry Kirstein, E. Kirstein Sons Co., Rochester, N. Y.; B. Maier, Baltimore, Md.; J. M. Webster, Milwaukee Optical Co.; E. A. Brown, of McIntire, Magee & Brown, Philadelphia, Pa.; C. N. Quimby, Boston, Mass.; Chas. Beard, of Sisco & Beard, Inc., St. Paul; J. E. Spencer, of the Spencer Optical Co., New York; S. Schimmel, of Sussfeld, Lorsch & Co., New York; Ed. J. Kornfield, of Toric Optical Co., New York; J. E. White, of White, Haines Optical Co., Columbus, O.; Michael Woolf, New York.

Morning and afternoon sessions were held. Reports of officers were submitted and in the afternoon new officers for the ensuing year were elected as follows: President, Leo Wormser, of the Julius King Optical Co., New York; vice-president, A. Reed McIntire, of McIntire, Magee & Brown, Philadelphia, Pa.; secretary and treasurer, J. B. White, of White, Haines Optical Co., Columbus, O. Directors—J. T. Brayton, of Julius King Optical Co., Chicago; A. V. Brown, of D. V. Brown, Philadelphia, Pa.; H. E. Kirstein, of E. Kirstein Sons Co., Rochester, N. Y.

In the evening a beefsteak dinner was given at Healy's, 66th St. and Columbus Ave., for which covers were laid for 25, and this closed the session in an enjoyable manner.

Mr. Wormser, the new president, has been vice-president in the last year. The new vice-president, has been secretary and treasurer in the last year.

### Special Railroad Rates for Those Attending the Iowa Retail Jewelers' Convention in Des Moines, Ia.

DES MOINES, Ia., May 10.—The Iowa Retail Jewelers' Association will hold its annual convention at the Chamberlain Hotel, in this city, June 14 and 15. The association is preparing an elaborate souvenir program, which will be sent prior to the convention to those who intend to be present.

Secretary-Treasurer J. H. Lepper, Mason City, Ia., reports that he is of the opinion that the attendance will be exceptionally

large, as correspondence which he has received recently from jewelers throughout the State indicates. In a circular letter which he is sending out, Mr. Lepper requests those who wish to attend to secure a receipt for the amount paid for railroad tickets when purchasing them. This receipt is to be handed to Mr. Lepper at the hotel here, either on June 13 or 14, when the passenger association agent will be present to stamp the tickets so as to entitle the purchaser to return home any time within three days after the convention at one-third fare.

The officers of the association are: President, F. W. Jameson, Ashton, Ia.; vice-president, J. M. Nabstedt, Davenport, Ia.; secretary-treasurer, J. H. Lepper. The Executive Committee includes: Mr. Lepper, F. W. Jameson, J. M. Nabstedt, E. J. Price and M. Hurlbut.

The Iowa State Association of Opticians will hold their annual convention at the same hotel during the two days previous to the jewelers' convention.

### Police Say Young Jewelry Clerk Confessed That He Robbed Employers and Stabbed Young Girl Employee and Himself.

Developments in the last week have indicated that Jacob Meyrowitz, the 16-year-old office boy, who was arrested in April on the charge of stabbing Bella Hecht, the stenographer in the office of Meyrowitz Bros., 57 Maiden Lane, New York, had been pilfering from the firm. It is now charged that he took money from letters, and also stole a quantity of reconstructed rubies and perhaps other jewelry. He is said to have destroyed a number of notes or checks, fearing that they might lead to the detection of his thefts. The members of the firm say that the total loss, they are positive, will not exceed \$500. The destruction of the checks and notes puts them to considerable inconvenience, but does not involve any real loss.

The police gave out, Monday, a statement that Meyrowitz had made a confession saying that he had stabbed the girl, who was one year his senior, because he suspected that she had learned of some of his thefts and was about to expose him. The day before the stabbing he had been accused by Miss Rose Meyrowitz, who had been left in charge of the office during the absence of the members of the firm, of taking \$5 from a letter. He denied that he had done so, and concluded that the stenographer had given the information, which led to his being accused. In his confession he said that he approached Miss Hecht from behind, as she was leaving the telephone booth, and this accounts for the fact that she was not entirely certain as to who had done the stabbing. Afterward he inflicted several slight wounds on his arms and legs in order to divert suspicion.

Since the stabbing the boy has been confined to Bellevue Hospital by the direction of the police. Miss Hecht, whose wounds were serious, is recovering.

The reports in the daily papers, as to the amount of the office boy's thefts, are declared by the members of the firm to be greatly exaggerated. Young Meyrowitz, who is a distant relative of the members of the firm, may be sent back to Riga, as there is a disposition not to prosecute him.

### Virginia Jewelers Fighting Commission's Award of Contract to Supply Silver Service for Battleship "Virginia."

NORFOLK, Va., May 11.—Few actions have ever incensed the jewelry trade of the entire State as has the decision of the commission created by the Legislature to select and have made a silver service for the U. S. battleship *Virginia*. Although a large number of Virginia jewelers bid for the contract and submitted plans the contract was awarded by the commission to the Bailey, Banks & Biddle Co., Philadelphia, which company had previously made some pieces of silver to be given by the Colonial Dames of this State to the boat. The Philadelphia firm's successful design was in harmony with these pieces.

The jewelers of this State are angry because they understood the service was to be designed by a Virginia artist and supplied by a Virginia firm, and claim they knew nothing about the Colonial Dames' gift, and if the commission wished a silver service of that kind they should have made it known when the bids were solicited.

The agitation which has been going on in the newspapers for some time has resulted in a formal action being taken by the Retail Merchants' Association, of this city, whose Board of Directors met in special session last night and adopted the following resolutions:

*Whereas*, The Legislature of Virginia passed an act creating a commission to have designed and made a silver service for the United States battleship *Virginia*; and,

*Whereas*, It appears, from articles in the newspapers, that the contract has been awarded to a firm of non-resident dealers from sketches of some unknown artisan, instead of being designed by a Virginia artist, of whom the State has several of world-wide reputation, and the purchase made through a foreign house, instead of some firm of silversmiths doing business and paying taxes in this State; and,

*Whereas*, It appears that the Governor of the State and the Speaker of the House of Delegates favored the placing of the order with some Virginia firm of silversmiths, which view was successfully opposed by the three other members of the commission, entertaining sentiments to the contrary; therefore, be it

*Resolved*, By the board of directors of the Retail Merchants' Association of Norfolk, Va., that it is the sentiment of this association that for a silver service ordered by the State of Virginia, to be used on a United States battleship, built in this State, and named after it, in honor of it, paid out of the funds of this State, with the money of the taxpayers thereof, the design should have been the work of a Virginia artist, and the order placed with a Virginia firm, dealing in this specific line.

*Resolved*, That the secretary of this association be instructed to ascertain the facts and how the vote stood both by name and office in the commission, in order that due credit may be given to those who favor the Virginia merchants and native talent, and that the said facts and a copy of these resolutions be sent to each of the other retail merchants' associations of this State and the members of the said commission.

*Resolved*, That if the said service and merchandise has not been definitely contracted for that the merchants of this State be given an opportunity to submit a design, worthy of the purpose for which the contribution was made by the State Legislature, and that the said design be submitted to Virginia merchants, regular dealers in silverware, for competition as to prices.

The secretary of the organization was also requested to communicate with similar organizations in the State as well as the State Retail Merchants' Association to urge them to protest against the act of the commission.

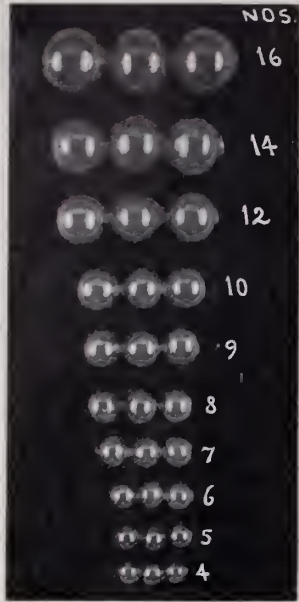

# THE DEMAND FOR PEARLS IS ENORMOUS

## FASHION DICTATES PEARLS

Our stock is the largest and most complete in America of the finest Fish-Skin Pearls. Prices range from

**30c. to \$25.00 per String**

Selection packages sent on request.

# CHOPARD FRÈRES

MAKERS OF ART JEWELRY NOVELTIES.

49 Maiden Lane - - - NEW YORK

FACTORY: 35 Rue Des Trois Bornes, PARIS, FRANCE.

# QUALITY COUNTS

## The Increasing Sale of = = = = TAVANNES WATCHES

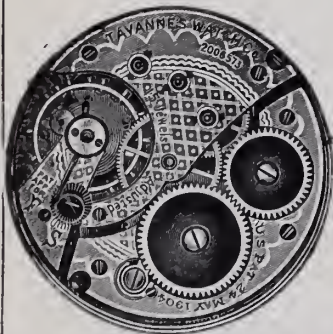

Proves their worth as timekeepers

FULLY GUARANTEED

For sale through the jobbing trade



## TAVANNES WATCH CO.,

2 & 4 Maiden Lane, New York.



# America's Recognized Leading Jewelry Auctioneer

Established 1885.

At present conducting a sale of the stock of the late firm of Messrs. Edelhoff Bros. & Co., 574 Fifth Ave., New York City. This is one of the highest grade jewelry stocks ever offered at auction in America. Write me for confidential results of this sale or call and hear me sell. Sales daily, 12 noon to 5:30 P. M. I personally conduct all large sales. Write me for advice, terms, etc.; it costs you nothing.

**DAN I. MURRAY, No. 3 Maiden Lane, New York.**

Established 1885.

## In Annual Convention.

### Sixth Annual Joint Meeting of Missouri and Kansas Opticians.

KANSAS CITY, Mo., May 11.—The sixth annual joint convention of the Missouri and Kansas associations of opticians was held here May 8 and 9, and it was by far the best meeting ever held in this city in point of attendance and otherwise. It was a convention of workers, as the hall was filled all the time during the reading of the papers and speechmaking, showing that those present were looking for information rather than a good time.

The forenoon of Tuesday was taken up with the preliminary work, the address of welcome by the Mayor and the responses from the two associations, by Claude M. Wheeler for Missouri and F. W. Hunt for Kansas.

The afternoon session followed the programme which had been arranged to the point where gold medals were to be awarded for the best papers on certain subjects, one for each State, and this part of the programme was carried over until Wednesday morning. When the papers were called for there had been none submitted by either State, and as the Meyer Jewelry Co. had the medals there ready for the awarding it was voted that they be given to the presidents of each State organization.

The interesting lectures and papers included: "The Optician As An Advertiser," C. A. Range, Trenton, Mo.; "Light, Health and Lenses," Dr. Arthur F. Campbell, Topeka, Kans.; a "Chalk Talk," Dr. S. W. Lane, and "Suggestion in the Practice of Optometry," Dr. Leo G. Hafner, De Soto, Mo. The latter paper was especially interesting, dealing with incidents to illustrate the idea of the author, which was to show the optician that by mind concentration, if studied and perfected in the right manner, he could so influence the mind of customers as to improve their eyes very materially by suggestion.

An official photograph was taken just before dinner, and after the close of the business session in the afternoon there was a banquet given the visitors at the Midland Hotel, in the evening, by the Kansas City wholesale and manufacturing jewelers.

Optical legislation was the subject of the talk of C. W. Brown, M.D., of Brunswick, Mo., who brought out considerable discussion. It was the opinion expressed by the meeting that optical legislation was needed, not only by the optician, but by the public, as it would place the profession on a higher basis by compelling practitioners to pass an examination before a State examining board.

In speaking of this movement, Dr. A. H. Hatch, Jefferson City, Mo., said: "The prime purpose of this movement is to elevate the profession to the status to which it belongs, with the practitioner of medicine and surgery. The fact is that any one who knows the least bit about the fitting of glasses to the eyes and can tell to a limited degree when a pair of eyes are defective may put out his sign as an optician. This is an injustice to the profession itself, and, needless to say, it is an injustice to the public generally. Why, in this State even a barber must stand an examination as to his competency before he is allowed to follow

his trade, and I don't see why an optician should not be compelled to do the same."

The session was closed by the election of officers by each of the organizations. For the Missouri association the following officers were chosen: President, M. E. Smith, Boonville; first vice-president, C. E. Range, Trenton; second vice-president, F. Hafner, De Soto, Mo.; secretary and treasurer, Elmer Schmidt, Washington, Mo.; Robert D. Worrell, Mexico; Louis Megede, Richmond; Dr. A. H. Hatch, Jefferson City, and J. W. Talbot, Nevada, were elected members of the Executive Board.

The officers elected for the Kansas association were: President, F. W. Hunt, Topeka; first vice-president, J. Q. A. Sheldon, Manhattan; second vice-president, A. A. Marion, Blue Rapids; secretary and treasurer, Walter Starcke, Junction City; Walter Sperling, Seneca; W. J. Lewis, Topeka, and Otto Burklund, Osawatimie were elected members of the Executive Board.

On Thursday morning, following the close of the optical convention, the jewelers present were called together for the purpose of organizing separate associations. This was accomplished in the forenoon without much delay, as those who stayed over for this meeting were almost of a single mind regarding the needs of such an organization and the possibility of united action remedying many of the evils that they now have to contend with. The idea of this meeting was merely to get together and form a working organization, such as was done six years ago by the opticians, and from that nucleus to spread out and cover the entire trade of the State.

The Missouri jewelers organized by electing the following officers: President, R. D. Worrell, Mexico; first vice-president, Claude Wheeler, Columbia; second vice-president, S. J. Huey, Excelsior Springs; secretary and treasurer, C. E. Range, Trenton, and G. W. Kern, Kansas City; G. E. Reed, Lebanon, and F. W. Pilcher, Mexico, were elected as an Executive Committee.

The Kansas jewelers elected the following officers: President, Walter Sperling, Seneca; first vice-president, C. C. Stevenson, Pittsburg; second vice-president, Tom M. Hutto, Kingman; secretary and treasurer, Frank E. Pirtle, Council Grove, and J. W. Phillips, Chanute; J. C. Haupt, Peabody, and Arthur West, Galena, were elected as an Executive Committee.

The following opticians and jewelers were among those in attendance at the joint convention:

Dr. A. H. Hatch, Jefferson City, Mo.; J. W. Talbot, Nevada, Mo.; J. M. Barnes, Sarcocixie, Mo.; G. E. Read, Lebanon, Mo.; W. A. Vawter, Marshall, Mo.; Geo. H. Schriener, Lebanon, Mo.; L. G. Hafner, De Soto, Mo.; Chas. Weber, Lexington, Mo.; C. J. Miller, California, Mo.; C. F. Bass, Louisiana, Mo.; F. W. Pilcher, Mexico, Mo.; W. H. Mayer, Lawson, Mo.; R. F. Mann, Salina, Kans.; Mrs. R. F. Jones, Red Cloud, Nebr.; T. A. Jones, Red Cloud, Nebr.; W. T. Nevitt, Archic, Mo.; Claud Wheeler, Columbia, Mo.; S. J. Huey, Excelsior Springs, Mo.; R. Worrell, Mexico, Mo.; Thos. A. Craig, Mason, Mo.; C. E. Range, Trenton, Mo.; E. L. Thurber, Warrensburg, Mo.; S. M. Bennett, Warsaw, Mo.; Elmer Schmidt, Washington, Mo.; Louis Megede, Richmond, Mo.; A. A. Thacker, Madison, Mo.; J. Kechnel, Hale, Mo.; D. F. Carpenter, Moberly, Mo.; M. B. Gordon, Braymer, Mo.; W. W. Whiteside, Liberty, Mo.; L. O. McKee, Norborne, Mo.; C. C. MeLeese, Davenport, Nebr.; M. E. Schmidt, Boonville, Mo.; W. C. Lambert, St. Louis, Mo.; J. H. Herkill, Lincoln, Nebr.; Geo. L. Evington, Lebanon, Nebr.; C. E. Tieman, California, Mo.; W.

Z. Allen, Stanberry, Mo.; Harry Sturges, Independence, Mo.; S. M. Coffman, Braymer, Mo.; C. A. Clement, Springfield, Mo.; H. T. Carson, Kansas City, Kan.; L. E. Arnel, Holton, Kans.; F. W. Hunt, Burlingame, Kans.; F. H. Gaines, Butler, Mo.; C. W. Struby, Green City, Mo.; P. J. Duke, Marceline, Mo.; W. F. Hammond, Manchester, Kans.; J. C. Haupt, Peabody, Kans.; L. S. McNamar, Highland, Kans.; P. H. Young, Dodge City, Kan.; B. A. Strickler, Salina, Kans.; J. F. Nasep, Alva, Okla.; J. W. Day, Stephenville, Tex.; Geo. M. McEekron, Concordia, Kans.; Ed. Sedgwick, Kansas City, Kans.; I. E. Griffin, Elk City, Kans.; C. C. Stevenson, Pittsburg, Kans.; Alfred M. Ward, Abilene, Kans.; H. F. Baier, Salina, Kans.; Willard B. Hale, Weatherford, Okla.; Mrs. W. B. Hale, Weatherford, Okla.; Francis W. Norvell, Stuttgart, Ark.; Frank L. Reid, Grenola, Kans.; Thomas M. Hutto, Kingman, Kans.; T. S. Mendenhall, Burr Oak, Kans.; W. P. Beal, Hutchinson, Kans.; J. A. Lukens, Bucklin, Kans.; J. Q. A. Sheldon, Manhattan, Kans.; C. H. Paxton, Paola, Kans.; W. I. Smith, Stockton, Kans.; A. A. Marvin, Blue Rapids, Kans.; W. T. Lloyd, Washington, Kans.; F. E. Pirtle, Council Grove, Kans.; L. S. Grimm, Jewell, Kans.; J. A. Mosher, Burlington, Kans.; J. M. Ditto, Russell, Kans.; J. W. Phillips, Chanute, Kans.; Violet E. Hunt, Prague, Okla.; Chas. Hoyt, Kansas City, Kans.; J. F. M. Lloyd, Pond Creek, Okla.; H. A. Tibbals, Emporia, Kans.; Mrs. F. W. Hunt, Burlingame, Kans.; T. E. Coffman, Toronto, Kans.; J. O. Van Voorhies, Osawatimie, Kans.; Arthur West, Galena, Kans.; A. G. Madison, Beloit, Kans.; Mrs. P. H. Young, Dodge City, Kans.; Otto Burklund, Osawatimie, Kans.; E. E. Foreman, Greenleaf, Kans.; O. W. C. Smith, Mountain View, Okla.; Walter Fasemeyer, Kansas City, Kans.; Mabelle A. Mears, Denver, Colo.; E. L. Levin, St. Joseph, Mo.; C. D. Ragsdale, Kansas City, Kans.; L. A. Chess, Kansas City, Kans.; Jas. B. Calder, Junction City, Kans.; Harry Z. Paulsen, Albuquerque, N. M.; D. D. Williams, Emporia, Kans.

The visiting ladies attending the optical convention were entertained the evening of May 9 with a banquet of their own at the Midland Hotel, and that was followed by a theater party at the Grand Opera House. The occasion was a very enjoyable one, and was taken part in by the following ladies:

Mrs. Emma Bockris, Atchison, Kans.; Mrs. P. H. Young, Dodge City, Kans.; Mrs. W. B. Hale, Weatherford, Okla.; Mrs. R. F. Jones, Red Cloud, Nebr.; Mrs. Frank E. Pirtle, Council Grove, Kans.; Miss Beatrice Lynch, Ft. Wayne, Ind.; Mrs. H. T. Tibbs, Kansas City, Kan.; Mrs. F. W. Hunt, Burlingame, Kans.; Dr. Violet E. Hunt, Prague, Okla.; Dr. F. W. Norvell, Stuttgart, Ark.; Miss Mabelle A. Mears, Denver, Colo.; Mrs. S. J. Huey, Excelsior Springs, Mo.; and the following from Kansas City, Mo.: Mesdames S. E. Woodstock, Louis Meyer, C. B. Norton, C. A. Kiger, C. L. Merry, Geo. H. Edwards, C. C. Hoefler, L. H. Ludwig, Fred Merry, Chas. Sheldon, Harry L. Goodwin, E. L. Chamberlain, Win. E. Huston, A. E. Pittenger, N. J. Williams, and Drs. C. A. Daly, Helen L. Kestler and E. A. Lane.

### Death of C. L. Childers.

ABBEVILLE, Ga., May 9.—C. L. Childers, who has been in business here upward of a year, was found dead last Sunday in his bed. His wife says he retired at 10 o'clock, as usual, and in about one hour's time he waked her with groanings and died shortly afterward. It is presumed that he died from morphine.

Several letters were found in the room addressed to his wife, saying that he soon hoped to be in another world. He leaves a widow and two children.

Mr. Childers came here from Mansfield, Ga., and was highly regarded in this community.

During the fire which broke out at 5 S. Main St., Wilkes-Barre, Pa., a short time ago, the stock of Clark & Engle, retail jewelers, who occupied the ground floor of the building, was damaged by water to the extent of \$450.



**AN AUTOMOBILE FREE**



# Old Reliable W. & S. B. ★

1866 — 1906

Forty years ago W. & S. Blackinton made the first gold filled, hard soldered, fancy link vest chains. By way of celebrating our

## FORTIETH BIRTHDAY

we beg to announce a plan of direct interest to the entire jewelry trade.

In January, 1907, we will give to the retail jeweler who uses the greatest number of Blackinton chains between May 1, 1906, and January 1, 1907, an Automobile Touring Car of standard grade and 1907 model.

To the retail jeweler who uses the second greatest number we will give an Automobile Runabout of standard grade and 1907 model.

To the retail jeweler who ranks third in this contest we will give a Motorcycle of standard grade and 1907 model.

The Retail jeweler who ranks fourth in this competition will receive an American Watch Lathe of latest design.

All other retail jewelers who use Blackinton chains will share in the following provisions:

Between May 1, 1906 and January 1, 1907, every Blackinton Old Reliable W. & S. B. ★ 1-10 or Globe Filled  $\frac{1}{8}$  vest or Dickens chain will bear an aluminum tag, illustrated herewith. These tags have a definite value and should be preserved.

The sales of Old Reliable W. & S. B. ★ 1-10 chains are enormous and we wish to draw particular attention to our Globe Filled  $\frac{1}{8}$  chains, in view of the constantly increasing demand for the highest grades of gold filled chains.

Upon receipt of forty tags from any retail jeweler, we will send free of charge one of our Globe one-eighth gold filled vest chains. For seventy-five tags we will send two Globe chains and for one hundred tags we will give three Globe chains. Retailers should preserve the tags as fast as goods are placed in stock and should decline to receive from jobbers chains that do not bear the coupon tag.

We offer a choice of twelve patterns of Globe one-eighth gold filled chains in selecting premiums, and illustrations will be mailed free on request. Globe one-eighth gold filled chains are guaranteed to assay one-eighth, are gold soldered and are warranted to give satisfaction for twenty years. Old Reliable W. & S. B. ★ 1-10 chains are gold soldered; and are the perfection of design, finish and durability. All Blackinton chains are made by the Wearbest process which hardens the gold and greatly increases the wearing qualities. This process is owned by us and no other chains are made in this manner.

Retailers who find difficulty in obtaining Blackinton chains may, upon written request, receive a list of jobbers handling the goods in their territory, or a selection package will be sent through any jobber whom the retailer may designate. For further particulars, address the manufacturers and watch this space.

**W. & S. BLACKINTON CO.,** North Attleboro, Mass.

# Our Traveling Representatives



Benj. Westervelt, of the New England Watch Co., is now making his Spring tour through New York State.

Edgar Kahn, of D. Jacobs & Co., Cincinnati, O., has recovered from his illness and will be on the road again about July 1.

C. B. Goldsmith, with Lindenberg & Fox, Cincinnati, O., is now on his last western trip for the season. Lee Kahn, of this house, is making his last trip of this season in the south.

J. H. Spiro, who represents a number of eastern houses on the Pacific coast, and who formerly had headquarters in San Francisco, is now located at 968 Madison St., Oakland, Cal.

Arthur H. Buck, representing Abel Bros. & Co., was in Oakland, Cal., last week, on a trip along the Pacific coast. He came down from Seattle and Portland and will return east by way of Los Angeles.

Among the traveling representatives who recently visited in Detroit, Mich., were: J. M. Marrow, American Watch Case Co.; Albert Ginzberg, Eliassof Bros. & Co.; J. C. Bigalke, Bigalke & Eckert Co.

The traveling representatives of eastern jewelry houses have, with one or two exceptions, avoided San Francisco since the big fire. Several who reached Los Angeles, last week, have returned east without going north.

Lancaster, Pa., was visited, last week, by the following travelers: A. E. J. Winter, Alvin Mfg. Co.; H. O. Theohald, J. Hoare & Co.; W. S. Gardner, Bassett Jewelry Co.; Jacob C. Lenden, Jacob H. Keller & Co.; D. Newhoff, Wm. Lehman & Co.

The following traveling representatives were looking for orders in Toronto, Ont., last week: George Smith, Theodore W. Foster & Bro. Co.; Frank Glaenger, Glaenger & Co.; E. F. Kirken-daugh, Oneida Community, Ltd.; H. S. Spang, E. Ingraham Co.; L. W. Arnold, Western Clock Mfg. Co.; M. Liebenstein, Wagner & Gerstley.

The following salesmen were in Boston, Mass., during the week: Samuel L. Howland, Joseph Frankel's Sons; E. M. Knapp, J. A. & S. W. Granber; Alexander W. Rothschild, Rothschild Bros. & Co.; C. A. Gallagher, Sinnock & Sherrill; George C. Ferris, R. Blackinton & Co.; Charles Theurer, Crane & Theurer; Edward A. Sweet, Sussfeld, Lorsch & Co.

Among the traveling representatives recently in Savannah, Ga., were: V. A. Picard, Pryor Novelty Co.; I. Speyer, Goldsmith Bros.; F. H. Dana, Bip-part, Griscom & Osborn; Arthur Totten, J. B. Bowden & Co.; Geo. H. Wright, Unger Bros.; Jerome M. Lissauer, R., L. & M. Friedlander; Morris Lissauer, Zach. A. Oppenheimer; A. M. Stevens, Enos Richardson & Co.

Among the traveling representatives who visited Buffalo, N. Y., last week, were: Charles Perret, Jules Racine & Co.; E. Horton, Mandeville, Carrow & Crane; Percy D. Lucas, Frank W. Smith Co.; Benjamin Schloss, A. Wallach & Co.; J. C. Corbin, Waterbury Clock Co.; Stephen O. Howard, Wilcox & Wagoner Co.; C. P. Young, White-side & Blank; Mr. Sylvia, Pairpoint Corporation; J. E. Worthington, Worthington & Raymond.

Traveling representatives in Omaha, Nebr., during the past week, included: L. R. Cram, H. F. Hahn & Co.; B. J. Hirshorn, Hodenpyl & Walker; G. D. Lawrence, Reed & Barton; John A. Lassau, Martin, Copeland & Co.; Philip Noel, Rudolph Noel & Co.; S. W. Abbey, E. Ira Richards & Co.; Mr. Buehl, A. L. Blackmer Co.; W. T. Good-fellow, King & Eisele; G. W. Finckenauer, Alvin Mfg. Co.; J. L. Adler, E. M. Weinberg & Co.; John O. Slemmons, J. B. Bowden & Co.; W. F. Adams, Simpson, Hall, Miller & Co.; William Strauss, Louis Kaufman & Co.; Ralph Siegrist, Albert L. Haman; Arthur H. Schmitt, Luthy & Hine; W. S. Adams, P. W. Lambert & Co.; George F. Heidert, C. F. Rumpp & Sons; R. E. Williams, St. Louis Silver Plate Co.; Charles Boss, American Cuckoo Clock Co.; H. E. Hastings, H

Hohenstein Co.; Fred H. Felger, F. & F. Felger; Mr. Edward, Whiting Mfg. Co.

Among the traveling representatives who called on the trade in St. Louis, Mo., last week, were the following: Charles E. Lochner, Hayes Bros. Co.; Julius S. Mayer, Mauser Mfg. Co.; Arthur H. Schmitt, Luthy & Hine; C. L. Krugler, Mandeville, Carrow & Crane; J. M. Curtis, Meriden Silver Plate Co.; C. L. Hartshorn, Krenmentz & Co.; Harry S. Aicher, Alvin Mfg. Co.; F. R. Krugler, Henry A. Kirby Co.; Wallace E. Welch, Hoyt, Obrig & Geiger Co.; J. E. Simonson, Ludwig Nissen & Co.; M. Hulstrom, International Silver Co., successors to Meriden Britannia Co.; W. S. Sharkey, Ziruth-Kaiser Co.; Mortimer C. Adler, Charles Adler's Sons; F. A. Chace, Jr., Charles M. Robbins Co.; W. H. Osborne, R. Wallace & Sons Mfg. Co.; James Nakaf, Whiting Mfg. Co.; Mark Franklin, Bradley Ring Co.; Mr. Sideman, Redlich & Co.

Among the traveling representatives who visited the trade in Pittsburg, Pa., last week, were the following: Charles B. Burgess, Frank M. Whiting & Co.; Fred H. England, Frolichstein, England & Klein; Mr. Strandberg, Sykes & Strandberg; A. J. Sherrard, Enos Richardson & Co.; Harry E. Berkman, Jones & Woodland Co.; Mr. Stanley, estate of O. M. Draper; John A. Keane, Ostby & Barton Co.; Chas. H. Clark, W. G. Clark & Co.; DeForest Ely, Harbour Silver Co.; Alberto Schweizer, Ansonia Clock Co.; H. J. Hildebrand, H. C. Lindol & Co.; Mr. Ford, Ford & Carpenter; E. M. Bliss, Bliss Bros. & Co.; Mr. Day, Day, Clark & Co.; R. H. Sedley, Sloan & Co.; W. H. Race, Meriden Silver Plate Co.; Wm. W. Middlebrook, B. A. Ballou & Co.; Edwin F. Skinner, Roy Watch Case Co.; Mr. Fisher, Furbish, Swift & Fisher; Mr. Franklin, Jules Franklin; Wm. Matschke, A. Joralemon & Son; F. E. Good, Philadelphia Watch Case Co.; H. N. VanBergen, Snow & Westcott; J. E. Simonson, Ludwig Nissen & Co.; H. F. Tourtellot, Waite, Thresher Co.; G. L. Sweet, R. F. Simmons Co.; Charles Perret, Jules Racine & Co.; W. J. Parker, Osmun-Parker Mfg. Co.; E. J. Walther, D. F. Briggs Co.

The following traveling representatives called on the trade in Kansas City, Mo., during the past week: Mr. Rogers, C. H. Cooke Co.; George Southwick, Payton & Kelley Co.; George E. White, White & Rounselle; W. S. Dudley, Rogers, Smith & Co.; R. C. Read, H. F. Barlow Co.; Mr. Williams, Warren & Williams; J. W. Stoneburner, Capron Co.; Fred H. Felger, F. & F. Felger; W. Sharkey, Ziruth-Kaiser Co.; G. Fred Perry, F. H. Sadler Co.; Max L. Jacoby, Manchester Mfg. Co.; Fred H. Carpenter, W. & S. Blackinton Co.; J. E. Simonson, Ludwig Nissen & Co.; B. J. Hirshorn, Hodenpyl & Walker; Chas. E. Lochner, Wm. S. Pitcairn; S. W. Abbey, E. Ira Richards & Co.; C. H. Davison, Coddling & Heilborn Co.; Wm. T. Smith, International Silver Co.; R. B. Carr, Link & Angell; James Baker, Frank M. Whiting & Co.; W. F. Adams, International Silver Co.; Richard Robinson, Bugbee & Niles Co.; F. E. Hyatt, Philadelphia Watch Case Co.; B. A. Noble, Sturtevant, Whiting & Bigelow; H. G. Pfardresher, Geo. L. Brown & Co.; Mr. Moore, F. W. Gesswein Co.; P. A. Wilkinson, J. J. Sommer & Co.; Walter Marble, Marble, Forester & Co.; A. R. Dorchester, W. E. Richards & Co.

Among the traveling representatives who called on the Cincinnati, O., trade, the past week, were: Mr. Goldberg, Untermeyer-Robbins Co.; Helmer Thompson, F. H. Noble & Co.; Irving J. Swartz, L. Barnett & Co.; Mr. Finberg, Finberg Mfg. Co.; Mr. Briggs, D. F. Briggs Co.; M. Donlin, McGraw, Donlin & Co.; A. Sussfeld, Kautzmann & Sussfeld; J. Frank Coupe, D. A. White Co.; Fred England, Frolichstein, England & Klein; Larney Edwards, C. E. Hancock Co.; F. A. Sisson, E. A. Bennett & Co.; I. Foster, Milton L. Ernst; Mr. Joseph, Wildpret & Saacke; W. A. Lamb, Geo. H. Fuller & Son Co.; Stephen C. Howard, Wilcox & Wagoner Co.; Mr. Delano, Day, Clark & Co.; H. E. Vincent, Simpson, Hall, Miller & Co.; William H. Middlebrook, B. A. Ballou & Co.; Lewis L. Squire, F. H. Cutler & Co.; G. C. Bennett, Waite, Mathewson & Co.; Wade W. Williams, Warren & Williams; J. Jacoby, Providence Stock Co.; L. Jones and J. Marsh, C. A. Marsh & Co.; H. R. Sweet, R. F. Simmons Co.; Charles C. Offerman, William Smith & Co.; E. J. Waltber, D. F. Briggs Co.; Maurice Kohn, Silberman, Kohn & Wallenstein; C. A. Whiting, Whiting & Davis; William W. Middlebrook, B. A. Ballou & Co.; Charles S. Peckham, J. H. Peckham & Co.; W. D. Sinnock, Ehrlich & Sinnock; Mr. Stanley, estate of O. M. Draper; Charles Clark, W. G. Clark & Co.; Mr. Metcalf, Plainville Stock Co.; A. A. Greene, A. A. Greene Co.; Louis Goldberg, J. Solinger & Co.; Mr. Remington, Carter, Qvarnstrom

& Co.; Arthur Dolan, Moore Mfg. Co.; Mr. White, Geo. L. Vose Co.; Gus Stranberg, Sykes & Stranberg; Mr. Carpenter, Horton, Angell Co.; Mr. Cobb, Daggett & Clap Co.; Ernest Block, Louis Stern; Burt Noble, Sturtevant & Whiting & Bigelow; Harry Scofield, Scofield, Melcher & Scofield; Fred Brigham, Cheever, Tweedy & Co.; Clarence Settle, Manchester Mfg. Co.; Harry Farquaharson, E. D. Gilmore & Co.; W. Sumner Blackinton, S. O. Bigney & Co.; W. R. Shute, Kohn & Co.

## Buffalo, N. Y.

T. C. Tanke, Main and Eagle Sts., is soon to increase his shop and salesroom force, in addition to making many needed improvements to his store room.

Peter Fullwood, Wellsboro, Pa., has accepted employment with Mr. Ullenbruch, 519 Main St., as head watchmaker, succeeding Julius Machan, resigned.

Samuel Freed has taken charge of Jireh Kinney's watchmaking department, succeeding the late Wm. T. Lampmann, who died in Thorold, Ont., a few weeks ago.

The Freeman Jewelry Co., 84 Seneca St., recently put three traveling representatives on the road. The company has increased its capital stock and made extensive alterations in the store.

C. F. Chouffet, 379 Main St., has let the contract for the construction in the rear of his store of an extension, in which he will have an elevated private office, which will overlook his main salesroom.

E. A. Eisele, of the wholesale house of King & Eisele, with his wife and daughter, returned on Tuesday of last week from a trip to Europe. Mr. Eisele says he was much benefited in health by the journey.

Paul Foerster, 134 Seneca St., whose store was robbed of a tray of diamonds, a number of weeks ago, has abandoned hope of recovering the bulk of his stolen jewels. Though \$3,000 worth of diamonds were taken, but about \$700 worth were returned to the New Orleans police after the arrest of William Harrington in that city. Harrington is now awaiting trial here on a charge of grand larceny, first degree. William Lobe, arrested in connection with the Foerster robbery in Memphis, Tenn., last week, was released on habeas corpus proceedings, and will probably never be brought to trial here for the alleged crime, as the case against him is regarded by the Buffalo police as a very weak one.

On Tuesday of last week an unusual incident made pedestrians in lower Main St. laugh heartily. Patrolman Casey was passing the pawnshop and jewelry store of Moses Cohen, 201 Main St., and was directly under Mr. Cohen's "three-ball" sign, when it dropped, one ball at a time. The first ball hit the policeman on top of the head, bounced upward, finally striking the sidewalk and rolling into the gutter. Mr. Casey, with angry face, whirled around and looked up just in time to receive, in quick succession, full in the face, the remaining two gilded spheres. Then he ran, for his thoughts were crowded with earthquakes and the like. The shouts and the bystanders' laughter, however, had the effect of checking his flight and restoring his good humor.

J. L. Hastings, Mohawk, N. Y., has sold out to Oscar Day, and will move to Meridian, Ind., where he will open a larger store.

# GORHAM SILVER POLISH

## THE SAFEST AND THE BEST

¶ Every Jeweler finds himself constantly appealed to by his customers for advice as to the best manner in which they may keep their household silver-ware in good order.

¶ The well-informed Jeweler has but one recommendation to make—the use, namely, of Gorham Silver Polish, which many years of sedulous experiment have succeeded in making the best and safest preparation in the world for the purpose indicated.

¶ The Gorham Mfg. Co., therefore, take the opportunity of reminding the trade in general that Gorham Silver Polish is supplied by them in the form of convenient cakes only.

¶ At the same time for those who desire it, the familiar Gorham Silver Powder is still supplied.

¶ The use of either of these preparations cannot be too highly recommended.

## GORHAM M'F'G CO.



CHICAGO,  
137 Wabash Ave.

Silversmiths and Goldsmiths

Fifth Avenue and 36th Street, New York.

BRANCHES:

NEW YORK,  
23 Maiden Lane.

SAN FRANCISCO,  
120 Sutter St.



LONDON,  
Ely Place.

WORKS: Providence and New York.

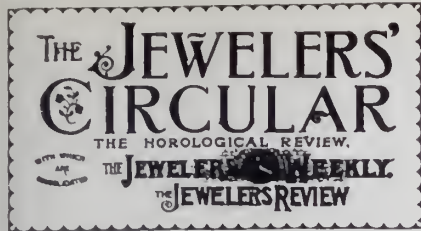

PUBLISHED EVERY WEDNESDAY BY  
**THE JEWELERS' CIRCULAR PUB'G CO.,**  
 11 JOHN ST. COR. BROADWAY, NEW YORK.  
 TELEPHONE: CABLE ADDRESS:  
 1148 CORTLANDT. JEWELAR NEW YORK

VOL. LII. MAY 16, 1906. No. 15.

Subscription in U. S., Canada and Mexico, \$2.00  
 Other Countries in Postal Union, . . . \$5.00  
 Single Copies, . . . . .10

Remit by check or money order. Remittances in money are at sender's risk.

Notices of changes in standing advertisements must be received one week in advance; new matter can be received up to Monday.

No attention paid to communications unless accompanied by full name and address of the writer. This is asked not necessarily for publication, but as an evidence of good faith.

**Index to Special Articles.**

	Page.
A Unique Display of Diamonds Worth \$200,000. Illustrated on front cover, text on page.....	99
Handsome Trophy Won at Brooklyn Riding and Driving Club Show.....	33
Recent Customs Decisions on Jewelry, etc....	33
Elsie Bee's Fashions.....	34
Jewelry Trade's Stamping Bill Reported Favorably to the Senate by Interstate Commerce Committee.....	35
Rochester Optical Society Elects Officers.....	35
Quiz at Monthly Meeting O. S. C. N. Y.....	37
Jeweler Wants Information About F. I. Hall. McKay Co. Sues James C. Buchanan.....	37
Texas Jeweler Accused of Smuggling.....	37
Decisions in Two Cases Growing Out of Hyman Gattle's Failure.....	39
Police of Binghamton, N. Y., Arrest Alleged Jewelry Thieves.....	39
San Francisco Jewelers Rapidly Finding New Locations—Other California Towns That Suffered.....	41
New England Watchmakers' Club Holds Interesting Meeting at Boston.....	44
Death of A. Grebles.....	45
New Step Rate Plan of the Jewelers' League. To Form Association in South Dakota.....	45
Death of W. H. Loomis.....	45
Walter Oates in Bankruptcy.....	45
Well Known Jewelry Crook Rearrested.....	45
Geo. H. Robinson's Suit vs. Gorham Mfg. Co. and Its Officers.....	46
Death of John J. Cumberson.....	47
Detroit Jeweler Recovers Stolen Jewelry.....	47
Imports and Exports of Jewelry.....	47
Jewelers Warned Against Masonic Engineer... Piedmont, W. Va., Jeweler and Clerk Assaulted and Robbed.....	47
Annual Meeting American Association of Wholesale Opticians.....	49
Coming Convention of Iowa Jewelers.....	49
Police Say Jeweler's Clerk Confessed to Assault and Robbery.....	49
Virginia Jewelers Fight Award for Battleship Silver Service.....	49
Joint Convention of Kansas and Missouri Opticians.....	51
Death of C. L. Childers.....	51
Death of James C. Donnell.....	55
Recent Publications.....	79
The Big Clocks That Give Time to New Yorkers in Manhattan, Brooklyn and the Bronx—Brooklyn Bridge and Third Ave. Watch Repairing—(Continued).....	81
America's First Town Clock.....	84
The Optometrist's Catechism—(Continued).....	93
Anatomy of the Nervous System.....	95
Decoration Day Advertising.....	97
Souvenir Cards as Advertising.....	97
Decoration Day Window Displays.....	98
A Biblical Business Card.....	99
The Enameling of Jewelry—(Continued).....	101
Use of Copper in Ancient Times.....	103
Marie Antoinette's Earrings Sold at Auction.....	103
The Making of Porcelain.....	103
Reports on Pearl Fishing in Mexico and Australia.....	105
Gold Used in the Manufacture of Jewelry by Various Countries.....	105

Further Progress of **T**HAT the merits of the Jewelry Trade's Gold and Silver Stamping Law, introduced by Congressman Vreeland, are appreciated by our Representatives and Senators is evident from the great success the measure has met with so far at the hands of Congress. As already reported in detail, this bill obtained unusual consideration from the members of the Interstate Commerce Committee of the House of Representatives, which committee unanimously reported it favorably; the House taking it up under a suspension of rules it was passed April 16 by an unusually large majority. The bill then went to the Senate, where it was referred to the Interstate Committee, and though practically in the hands of that committee but a few days, has already been acted upon and reported favorably to the Senate, as told in another column of this issue. It is now in the Senate calendar and stands an excellent chance of being passed at this session.

We again call the attention of the members of the trade in all sections of the country to the importance of letting their Senators hear from them in regard to this measure in order that all the members of that body may appreciate how great is the desire on the part of the jewelry trade, retail and wholesale, to have this law enacted, and also how important and necessary such a measure is for the protection of the public as well as the trade in every section of the country. That unanimous approval which has been given to this measure by the manufacturing wholesale and retail trade, and that work has been done in its behalf by jewelers in all sections of the country speaks well for the standard of business morality of the industry as a whole, and no doubt has had much weight with the Members of Congress in the way of proving that the measure is one drawn for the general welfare of all and not in the interest of any particular branch or section of the trade.

This interest in the measure as well as the co-operation of all jewelers should be made manifest now to the greatest extent possible in order to insure a speedy enactment of the law, and there is no better way of showing this than by jewelers writing personal letters or telegraphing to the Senators from their States, calling attention to the merits of the bill and the benefits accruing to the trade and public. The act may come up for consideration at any time now, and the sooner that Senators hear from their constituents the better the chances of the bill.

**C**UBAN trade-marks are just now receiving the attention of the Merchants' Association of New York, which has sent out a circular letter on the subject to business men in various lines, including jewelry. The association is endeavoring to obtain action by the Government which may induce the Cuban Republic to furnish the same degree of protection to American trade-marks that is now given in this country to Cuban trade-marks.

The cause of complaint is found in the Cuban law, which gives to the registrant of

a trade-mark the absolute and exclusive right to the use of that mark. As a result, a citizen of Cuba may register any well-established and valuable trade-mark not already registered in the island and thus become the sole and exclusive owner of that mark in the domains of the Cuban Republic. As pointed out by the association, this may be done without the knowledge of the original American owner, and further, when the American, either directly, or through distributors, tries to place in the island merchandise bearing his original trade-mark, such goods are immediately subject to confiscation. The Cuban who registered the trade-mark has then both a criminal and a civil action against the American owner for infringement.

It is said that a number of American manufacturers have already been subjected to blackmail by irresponsible Cubans, who make a practice of stealing and registering valuable American trade-marks for the sole purpose of demanding tribute of the American owners. In the United States, as is well known, the priority in use of a trade-mark, when established, is conclusive as to the right of ownership, even against registration. Cubans as well as all other people may enforce such rights in the courts of this country, and it is but just and fair that the American should have an equal right to protect his trade-mark and names under the Cuban law.

It is time that Congress or the Administration gave some attention to this important question and obtained from Cuba, by treaty or otherwise, some measure to protect our manufacturers who sell to this island and from infringement of rights and blackmail of this character.

**Death of James C. Donnell.**

BOSTON, Mass., May 15.—James C. Donnell, president of the Ripley-Howland Mfg. Co., died, Saturday last, May 12, at his former home in Saco, Me. The cause of death was apoplexy.

Mr. Donnell had been connected with the Ripley-Howland Co. for 26 years, representing the concern during the greater part of that time in Massachusetts, Rhode Island and Connecticut. On the reorganization of the company, in February last, he was elected president, succeeding William Z. Ripley, who retired from the company.

About a year ago Mr. Donnell was seriously ill for a number of months, but he recovered, apparently, and resumed his trips through the territory which he had visited for so many years, much to the gratification of his many friends in the trade, with whom he had always been one of the most popular traveling men in New England.

Mr. Donnell was a member of the Boston Jewelers' Club, the Boston Athletic Club, and the State of Maine Club. He was about 56 years of age, was born in Saco, Me., and was educated in the public schools of that city. Deceased was a man of sterling and upright character, and possessed a host of friends, who held him in the highest esteem. He was unmarried, and is survived by a brother and sister.

Services were held at his former home at Saco, Me., to-day, and at Forest Hills Cemetery, this city, where the remains were cremated.

# FIRST HANDS



## CROSS & BEGUELIN

Importers and Cutters of Diamonds and Precious Stones

43 Rue de Meslay, PARIS

Telephone,  
2183 Cortlandt

17 Maiden Lane, NEW YORK

### ARCH CROWN MOUNTINGS IMPROVE DIAMONDS



NOTE CONCAVE TIP

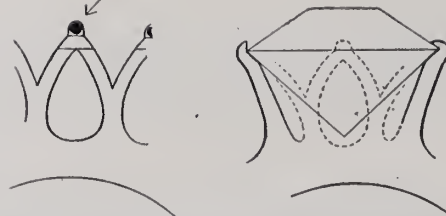

### COMPLETED BEARING ARCH CROWN MOUNTINGS INSURE PERFECT SETTING

All Arch Crown Mountings are now furnished with Complete Bearings, the success of which was instantaneous; unsolicited testimonials coming to us daily attesting to its worth. This important improvement in diamond mountings has overcome many vexations owing to inferior stone setting. A perfect result is certain, since bearings and tips are fully prepared in advance and a close contact with the stone must follow.

Samples cheerfully sent on approval, a trial invariably proves convincing.

**ARCH CROWN MFG. CO. 26 CAMP ST. NEWARK, N. J.**

Cross & Beguelin, New York.  
Kossuth Marx Jewelry Co., New York.  
Schrader-Whitstein Co., Chicago.

Eisenstadt Mfg. Co., St. Louis.  
M. Schussler & Co., San Francisco.  
Leonard Krower, New Orleans.

### Last Week's New York Arrivals.

THE CIRCULAR-WEEKLY each day posts in its office a Bulletin of the latest buyers visiting New York, which every member of the trade is cordially invited to copy.

- BALTIMORE, MD., L. Kann (Kann Bros. Silver Co.), Hoffman.  
M. Schneeberger (Goldenberg Bros. & Co.), Albert.  
Miss N. E. Williams (Cohn-Coblens Co.), Grand.
- BINGHAMTON, N. Y., C. F. Sisson (Sisson Bros., Welden Co.), Grand.
- BRIDGEPORT, CONN., G. A. Fairchild (G. W. Fairchild & Sons), Vendome.
- BUFFALO, N. Y., A. Block, Imperial.  
L. Meyers, Breslin.
- CHICAGO, J. L. Felsenthal (Felsenthal Bros. & Co.), Herald Sq.  
M. Fleishman (M. S. Fleishman Co.), Vendome.  
J. Floersheim (J. Floersheim Co.), Woodstock.  
S. Carson (Carson, Pirie, Scott & Co.), 115 Worth St.
- CINCINNATI, O., J. A. Herschede (Frank Herschede), Imperial.
- CLEVELAND, O., Benj. V. Arnstine (Arnstine Bros. Co.), Hotel Astor.  
H. W. Arnstine (Arnstine Bros. Co.), Hotel Astor.
- DANVILLE, VA., Otto Salsman, H. S. Kramer, 51 Maiden Lane.
- ERIE, PA., G. A. Disque, Park Ave.
- GRAND RAPIDS, MICH., L. J. Rosenthal (Jno. C. MacInnes Co.), Prince George.
- KNOXVILLE, TENN., P. J. Briscoe, Jr. (Daniel Briscoe Bros. & Co.), Imperial.
- MARIETTA, PA., G. F. Stibgen (L. R. Stibgen), Astor House.
- MERIDEN, CONN., J. J. Killeen (A. S. Thomas), Normandie.
- MONTREAL, QUE., A. Eaves, Imperial.
- PITTSBURG, PA., J. C. Wasson (J. Horne Co.), St. Denis.
- PROVIDENCE, R. I., A. Ainsworth (Blanchard, Young & Co.), Broadway Central.
- ST. LOUIS, MO., E. C. Weidlich (Wm. Weidlich & Bro.), Broadway Central.
- TROY, N. Y., T. E. Burney (G. V. S. Quackenbush & Co.), Wolcott.  
B. Marks, Wellington.  
M. Marks, Sinclair House.
- WORCESTER, MASS., A. J. Moir (Jno. C. MacInnes Co.), Prince George.

### Columbus, O.

J. R. Kyle, who has been traveling for the White-Haines Optical Co., has resigned and will start a jewelry and optical store at Xenia, O.

Frank B. Ross went to Wheeling, W. Va., Wednesday, having been appointed one of the appraisers of the stock of the I. G. Dillon & Son Co., which has gone into the hands of a receiver.

The Secretary of State last week issued incorporation papers to the Hartman Jewelry Co., of Wapakoneta. The capital stock is \$10,000, and the incorporators are George, R. W., C. S. and Sabina Hartman.

J. H. O'Daniel, who was so seriously injured in an automobile accident, two weeks ago, is able to be out again, in a much dilapidated condition. A blood clot formed on the optic nerve as one result of his injuries, very seriously affecting the sight of the left eye, but physicians think the clot will eventually be absorbed.

F. M. French, Albany, Ore., is holding a sale of hand painted china in order to close out that line.



## New York Notes.

The Hoyt, Obrig & Geiger Co. moved last week from 11 Union Sq. to 35 W. 31st St., where offices and factory are now located.

John P. Schmidt, designer for David Kaiser & Co., who is in Europe visiting the jewelry centers, will return early in June.

A Jaffe & Son, diamond importers, formerly of 51 Maiden Lane, recently moved their offices to the Myers building, 49 Maiden Lane.

M. Gattle, of Gattle, Ettmger & Hammel, 68 Nassau St., and Mrs. Gattle returned May 5 on the *Cedric* after passing three months in Europe, principally on the continent.

Cortland E. Hastings, who was a member of the old firm of Carter, Hastings & Howe, sailed last Thursday on the White Star Line steamship *Cretic*, for Italy, where he will pass six months.

Charged with receiving goods in a pawnbroker's shop from a minor, Goodman Edelstein was tried last Wednesday in the Court of Special Sessions, Jamaica, L. I., and was fined \$50.

United States Appraiser Whitehead resigned last week, saying that he intended to engage in business. His resignation was accepted by Secretary Shaw in a letter expressing appreciation of the retiring officer's work.

A quantity of Favril glass was contributed by the Tiffany Studios to the sale conducted last week in the American Art Association's gallery, Madison Sq., for the benefit of the California Artists' Relief Fund.

An announcement is being sent to the trade by Henry C. Haskell, 15 W. 27th St., inviting correspondence from jewelers who desire up-to-date designs for unusual articles. Design plates are sent out free for the asking.

David Kaiser & Co. are now comfortably settled in new offices on the 12th floor of 12 John St., the former office on the 11th floor having been added to the factory, which now comprises the entire floor of 1,800 square feet.

Oscar S. Straus, of L. Straus & Sons, 42 Warren St., gave notice last week that he will not consent to act on the board of trustees of the New York Life Insurance Co. after the expiration in a few months of his present term.

The W. S. Smith Co. was incorporated last week and will have a factory for plating and oxidizing metals. The capital is \$4,000 and the incorporators are: W. S. Smith, A. Smith, Brooklyn, N. Y.; Lewis V. Halse, Hoboken, N. J.

One of the directors of the new national bank, which is to be established in the vicinity of Wall, Beaver and Pearl Sts., is A. K. Sloan, the president of Sloan & Co. The bank will start with a capital stock of \$200,000 and \$100,000 surplus, Martin W. Littleton being the president.

C. E. Settle, who for 10 years represented O. M. Draper and the estate of O. M. Draper, has accepted a position as western representative of the Manchester-Smith Co., Providence, with a New York office at 9 Maiden Lane. Mr. Settle will at once start on the road with a new line of sample chains.

Ralph B. Brahe, who for over three years was connected with the Seth Thomas Clock Co., on May 1 associated himself with Wm. J. Ward, 13 Maiden Lane, as eastern representative. Mr. Brahe, in former years, was salesman for an Attleboro jewelry concern, and is well acquainted through his present territory.

Henry Carpenter, 79 Broadway, Flushing, L. I., last week received a letter from his brother, Wm. Carpenter, who lives in San Jose, Cal., in relation to the earthquake shock. The writer said that the chimney fell on his house which was considerably wrecked, but that no member of his household was hurt.

In speaking recently of the death of Charles S. Shiebler, it was said that after the retirement of A. K. Shiebler & Son from the business, it was thereafter taken up by J. P. D. Shiebler. It should be said, to avoid misconception, that the American Watch Case Co. bought the stock and good will of the retiring company.

G. A. Henckel & Co., who recently removed their offices and factory from 21 E. 13th St. to 536 W. 22d St., have improved their show room. Larger quarters have enabled them to introduce show cases of more liberal proportions than they formerly had, and a much more comprehensive display of their manufactures is now made.

To the fishing streams of Labrador turn the thoughts these days of A. K. Sloan, the president of Sloan & Co.; E. C. Fitch, president of the American Waltham Watch Co., and D. J. Carroll, director of the Chatham National Bank. They will start June 5 on their annual trip and will pass two months angling on the Romaine River and thereabouts.

A verdict in favor of Philip Rodenberg, 3 E. 125th St., was announced last week by the Ninth Municipal Court in a case brought against the jeweler by Charles Stahlhut. The plaintiff claimed that he had left with the jeweler a watch to be repaired and that it had afterward been given to the wrong man. Benjamin Franklin, the jeweler's attorney, in his defense claimed that the disappearance of the watch was due to a plot to mulct the jeweler.

Udall & Ballou will move about July 1 from 499 Fifth Ave. to 574 Fifth Ave., having obtained a transfer of the lease of the store formerly occupied by Edelhoff Bros. & Co., from Rawson L. Wood, the receiver of that company. The sale of the Edelhoff stock and fixtures by the receiver to William Barthman, 174 Broadway, was confirmed last Wednesday by Justice Scott, of the Supreme Court. The price, as finally settled, was \$30,445.

Many jewelers, as members of the Seventh Regiment, participated in the big anniversary banquet given recently by that organization. Among those in the trade who are members of the regiment are the following: Wm. A. Bryant, of M. B. Bryant & Co.; H. C. Perley and C. N. Perley, of Perley Bros.; Joseph P. Meurer and Wm. V. Laurino, of Saunders, Meurer & Co.; Harry Canfield, with the Roy Watch Case Co.; E. F. Pancoast, with the Howard & Cockshaw Co.; George W. Street and H. L. Street, of George O. Street & Sons.

During the San Francisco earthquake, John Heuser, an office boy, saved for the Elgin National Watch Co. the company's insurance policies, 300 watch movements and other property valued at \$2,000. "The first telegram our San Francisco agent sent after the earthquake stated that he was personally safe," said President Charles H. Hurlburt, as repeated in a Chicago paper, "but that the office and stock had been destroyed. Later we learned that Heuser had rushed into the building after the quake and saved the watch movements and other valuable property. I do not think our loss will exceed \$2,500."

Because a quantity of diamonds belonging to L. S. Barnett, an installment dealer, were said to have been swallowed by an elephant at Coney Island one day last week, friends began to extend their sympathy to the loser. It was said in the daily papers that while Mr. Barnett was showing the precious stones, valued at \$5,000, to the lion tamer, an elephant came along, thrust his trunk over the tamer's shoulder and ate the gems. In answer to a question Mr. Barnett said a day or two later that the missing diamonds had been recovered, and it was clear that he is not the man to spoil a good story told by a press agent.

Detectives who have been trying to trace jewelry stolen by Jos. Mateski, called the "Masonic" burglar, last week caused the arrest of B. Konigsberg, jeweler at 616 Second Ave., New York, and his clerk, Samuel Goodman, charging them with receiving stolen property. Highly colored stories, apparently the product of the combined imagination of detectives and reporters, were published in several papers. It was said that of \$100,000 worth of jewelry stolen by Mateski from homes in Flatbush and other parts of Brooklyn portions valued at \$50,000 had been found by detectives in Mr. Konigsberg's jewelry store. One of the papers gave a picture of the store. It was said that when Mateski was placed in his cell two detectives, concealed in an adjoining cell, heard him make an arrangement with a prisoner who was to be released the next day to carry a message to Konigsberg. The burglar's object, it was said, was to get bail and also to warn the jeweler to secrete the property. A day or two later the papers discredited their earlier stories as to the cunning work of the detectives and placed the value of the property seized by the officers in Mr. Konigsberg's store at \$1,000 instead of \$50,000. Mr. Konigsberg told a reporter of THE CIRCULAR-WEEKLY that he had never seen the burglar. The articles taken by the detectives from his store, he said, were 23 in number and had been left with him by various customers to be repaired. The total value, he believed, was not more than \$17 or \$18. Several of his customers, he said, have already identified their jewelry taken by the police. Mr. Konigsberg added that he never buys any metal from strangers or from people outside of the trade and that the charge against him was entirely baseless. In the Tombs Police Court Magistrate Wahle on Friday asked the detectives for their evidence against the jeweler and his clerk. The officers asked for more time and were given until to-day. Geo. R. Simp-

(New York Notes continued on page 61.)

IN THE HEART OF THE JEWELRY DISTRICT.

# Guardian Trust Company,

170 BROADWAY, COR. MAIDEN LANE, NEW YORK.

Capital and Surplus - Over \$1,000,000

Equitable rates of interest allowed on surplus funds.

Collections on out-of-town items handled on reciprocal basis.

FRANK W. WOOLWORTH, President.

GEORGE W. FAIRCHILD, Vice-President.  
CHARLES L. ROBINSON, Vice-President.

LATHROP C. HAYNES, Secretary.  
ALFRED M. BARRETT, Asst. Sec'y.

Prominent Jewelers  
Among our Directors

LUDWIG NISSEN.  
A. K. SLOAN.  
LEOPOLD STERN.

# THE ORIENTAL BANK.

ESTABLISHED 1853.

182 and 184 Broadway, <sup>Corner</sup> JOHN STREET, NEW YORK.

Capital, - - - \$750,000.00.  
Surplus and Profits, 1,100,000.00.

*ACCOUNTS FROM THE JEWELRY TRADE ARE SOLICITED.*

R. W. JONES, Jr., President.  
NELSON G. AYRES, First Vice-President.  
GEO. W. ADAMS, Cashier

LUDWIG NISSEN,  
ERSKINE HEWITT, } Vice-Presidents.  
CHARLES J. DAY, }

R. B. ESTERBROOK, Assistant Cashier.

# The Market and Fulton National Bank of New York.

ORGANIZED 1852

81-83 FULTON STREET.

Capital, \$1,000,000. - Surplus, \$1,335,000.

ALEXANDER GILBERT, President.  
R. A. PARKER - - Vice-President.  
T. J. STEVENS, - - - - Cashier.  
JOHN H. CARP, - - Asst. Cashier.

**Invites the Accounts of Jewelers.**

Will extend every facility that good banking will justify.

**SAFE DEPOSIT VAULTS.**

# The Chatham National Bank

Broadway and John Street, New York

H. P. DOREMUS, Cashier

GEORGE M. HARD, President

W. H. STRAWN, Ass't Cashier

# THE STATE BANK

376-378 GRAND STREET, NEW YORK

Capital and Earned Surplus, over \$1,100,000. Deposits over Fourteen Millions.

Offers a favorable market for short and long time jewelry and diamond paper

# *The Mercantile National Bank of the City of New York*

*Cordially invites Accounts  
from Good Merchants  
in the Jewelry Trade.*

**CONDENIENT LOCATION,  
AMPLE CAPITAL,  
LARGE SURPLUS,  
LONG EXPERIENCE.**

*FREDERICK B. SCHENCK, President.*

*MILES M. O'BRIEN,* } *Vice*  
*WILLIAM H. TAYLOR,* } *Presidents.*

*JAMES V. LOTT, Cashier,*  
*EMIL KLEIN, Asst. Cashier,*  
*ALFRED W. DAY, Asst. Cashier.*

<i>Capital,</i>	.	.	.	<b>\$3,000,000</b>
<i>Surplus,</i>	.	.	.	<b>\$3,000,000</b>

*Broadway, Corner of Dey Street,  
New York.*

## WELL CUT STONES

GREATLY ENHANCE THE VALUE OF

## FINE JEWELRY

ALL SIZES AND SHAPES OF

## PERIDOTS

CUT TO ORDER FROM CLEAN ROUGH

At Reasonable Prices.

### AMERICAN GEM & PEARL CO.

14-16 Church Street  
NEW YORK

LONDON, 16 Holborn Viaduct  
PARIS, 39 Rue de Chateaudun

From MINES to MARKET



Three-Quarter Size

### New Pierced Nethersole Bangles

14 karat, Size 7 1/2 inches. Suitable for wearing over the new long gloves

### COOPER & FORMAN

Office and Factory, 3 Maiden Lane, N. Y.

Makers of Diamond Jewelry

Festoon Necklaces  
Lockets  
Cuff Buttons

Brooch Pins  
Scarf Pins  
Bracelets

## INSURE YOUR LIFE IN A REGULAR LIFE INSURANCE COMPANY

FOR PARTICULARS REGARDING

*An Ordinary Life*

*20 Payment Life*

*20-Year Endowment*

*Partnership or Term Insurance in*

The Equitable Life Assurance Society

OF THE UNITED STATES

Address

L. A. MILLER, Special Agent

180 Broadway, NEW YORK

## THE WASHBURN SECURITY MAGIC NUT

Automatic Holder for all sizes of scarf-pin wire. Guaranteed. for ear studs, scarf pins, etc.



EAR WIRES

for unpierced ears.



SAFETY CATCH

For brooches, etc.

Can be applied to any work where pin tongues are used.



Open.



Closed.



Open.



Closed.

Descriptive Circular on Application.

Pearl drilling and Adjusting a specialty.

Special Order Work and Repairing.

C. IRVING WASHBURN, 12-16 John St., N. Y.

## RINGS

WM. LOEB & CO.

101 Sabin St.,

Providence, R. I.

New York Office, 37 Maiden Lane.

## New York Notes.

(Continued from page 57.)

son has been retained by the jeweler as his attorney.

A. M. Bachrach, watch case manufacturer, 51 Maiden Lane, has gone out of business.

Charles Eisen, formerly a jeweler of 692 Myrtle Ave., Brooklyn, was released, last week, from the Manhattan State Hospital at Central Islip, L. I., having been declared competent again to manage his affairs.

Chas. L. Power, of Chas. L. Power & Co., 170 Broadway, accompanied by Mrs. Power, will sail next Saturday for Europe on the *Columbia* and will visit the diamond markets of London, Amsterdam and Antwerp.

Robert E. Lemert, who was formerly in business in Maiden Lane, has brought suit for \$25,000 damages against Mr. and Mrs. Ludwig Juchom, the parents of his wife. He charges that they enticed her away from him.

A certificate was filed last week incorporating the business of W. W. Harrison, umbrella and can manufacturer, 1149 Broadway, under the style of the W. W. Harrison Co. The authorized capital is \$25,000, all paid in.

C. Staiger, formerly member of Jung, Staiger & Klitz, has started in business with his two sons, W. E. Staiger and Hugo M. Staiger, under the firm name of Staiger Sons. Their office will be in the Minden building, 926 Broadway, Brooklyn.

Announcement is made that the buffing and grinding motors of the Holtzer-Cabot Electric Co., Brookline, Mass., are no longer sold through its former agents, and that the company will after this sell the motors direct to the jewelry trade.

L. Lachman, of the Acme Plating Works, 17 John St., has started on a six weeks' trip through the west and will stop at Buffalo, N. Y.; Detroit, Mich., and other cities, calling on the trade. During his absence George Lachman will have charge of the office and factory.

Otto Salzman, Danville, Va., called at THE CIRCULAR-WEEKLY office last Friday on his first trip to the city in 16 years. Mr. Salzman is one of the oldest subscribers to THE CIRCULAR-WEEKLY, having taken it continuously for the past 35 years. He is making his headquarters with H. S. Kramer, 51 Maiden Lane.

W. A. Salmon, of the Riviere Brass & Bronze Works, 330 Seventh Ave., expects to resume his trip on the road about May 25 with a new line of samples. His seven trunks were destroyed in the burning of the Palace Hotel at San Francisco, and he was, therefore, obliged to discontinue his trip until new samples are prepared.

Robert P. Hunter, formerly with Rudolph C. Hahn & Co., has temporarily assumed charge of the New York office of the Geo. L. Paine Co., 9 Maiden Lane, and will continue in charge until George Angell recovers from the serious injuries which he suffered in the fall of an elevator in a Fulton St. building, Brooklyn.

Roger Weiss, a jewelry designer, and Miss Jessie Ballou, 317 Gates Ave., Brooklyn, were married last week by Magistrate Mayo. The bridegroom, in asking the magistrate to perform the ceremony, ex-

plained that he had been sent to Paris by his firm and, therefore, he and his bride concluded to hasten the ceremony so that they could go together.

Dan I. Murray is now conducting an auction sale of the stock of Edelhoff Bros. & Co., 571 Fifth Ave., which was turned over to the receiver at the time of the failure. The sale is to continue daily, beginning at 12 o'clock noon, until the stock is all sold. The store is opened each day an hour before the sale begins in order to give purchasers an opportunity to examine the stock.

Complaints have been made recently by occupants of the Criminal Courts building that the clocks get out of order altogether too often. Magistrate Wahle, of the Tombs Police Court, wrote a letter last week to the custodian of the building demanding that a clock keeping more exact time be placed in his court room. It is said that all the clocks in the building will be subjected to an overhauling.

An injunction is being sought by Thomas McCarty, who carried on a mail order business in New York under the style of the Oriental Perfume Co. and distributed watches as premiums, against the Postmaster-General. A fraud order was recently issued against McCarty, barring him from the use of the mails. He claims that he conducted the business legitimately, and he has begun suit in the District Supreme Court at Washington.

Judgment for \$11,284 was filed last week against Morris A. Forgotson, who had a pawnbrokers' sales store at 178 Bowery, and in favor of L. Schlessinger as receiver of the Federal Bank. Bankruptcy proceedings were begun in February of last year against Forgotson. The judgment, now filed, was taken on a note which was among the assets of the Federal Bank, the note not having been included in the schedules filed by the bankrupt.

On the charge of larceny preferred by his employers, L. W. Sweet & Co., 39 Maiden Lane, John F. Kelly, a collector, was, last week Friday, held in \$1,000 bail in the Tombs Police Court. It is charged that Kelly held back \$178 of money that he had collected on instalment accounts. It is also said that the bond furnished by Kelly when he entered the company's employ has proved worthless. The collector lived at 1051 Avenue D, Bayonne, N. J. It is the intention of his employers to press charges against him in Jersey City also.

At a meeting of the Board of Directors of the Jewelers Board of Trade held last Thursday, M. Luther Bowden, of J. B. Bowden & Co., 1 Maiden Lane, was unanimously elected a director, filling the vacancy caused by the resignation of Henry K. Dyer, who recently retired from the Dennison Mfg. Co. The following firms were unanimously elected to membership: Wm. I. Allsopp, Newark, N. J.; Benedict Mfg. Co., East Syracuse, N. Y.; Dreyer, Lochau & Ohm Co., Chicago; Oscar T. Jonassohn, New York; Lawrence Mfg. Co., Newark, N. J.; Mason, Howard & Co., Attleboro, Mass.; Scott Bros. Co., Chicago, Ill.

According to charges made by Isaac Wolf, 118 Bowery, his junior clerk, Louis Macharowsky, 18 years old, has disappeared with seven diamond rings, two brooches, one pair of diamond earrings and

other jewelry, valued altogether at \$2,000. Mr. Wolf believes that the youth went to Chicago. The day before the disappearance the jeweler reproved the clerk for getting down to work late in the morning, and told him that if he could not come in time not to come at all. When Macharowsky did not report for work the next morning the jeweler looked over the stock and noted that many articles were missing. He then asked the police to look for the clerk. Macharowsky boarded at 9 Goerck St.

A fine of \$20 was imposed last Wednesday on W. F. Boyer, a diamond setter at 16 Maiden Lane, by the Court of Special Sessions, for assaulting Joseph Hoffman, also a diamond setter, who occupies an adjoining office. Mr. Boyer paid the fine. The particulars as to the difficulties between the two men were published in THE CIRCULAR-WEEKLY several weeks ago, when the arrest was made. Mr. Hoffman charged that he was set upon as he was entering his office by Mr. Boyer, and was seriously beaten. The men had quarrelled in relation to the charge for a petty piece of work which Boyer sent to Hoffman to do. Mr. Hoffman claimed that thereafter he was annoyed in a variety of ways by his neighbor, the trouble culminating in the assault.

Selem A. Gemeil, a Syrian, giving his place of residence as 17 Rector St., was brought before Judge Holt in the United States District Court, Monday, and pleaded guilty to a charge of smuggling a quantity of watches and jewelry. He was fined \$100 and paid this amount, besides the duties on the articles. Gemeil was a passenger on the steamship *St. Louis*, arriving in New York in the last week of April. He had a quantity of watches suspended on a string hanging down his back. One of the watches had an alarm attachment and the tinkling of its bell was noticed by Inspector Timothy Donahue, who searched the man and made the arrest. In all there were 43 watches, besides some jewelry. One of the watches was being brought here, it is said, especially for a Stock Exchange broker. It had a dial showing the time in London, Paris, Chicago and St. Louis.

While J. H. Raccicot, jeweler and watch dealer, at St. Johns, P. Q., was buying a ticket for Montreal at the Grand Central Station last Wednesday just before the 7 o'clock train started, his sample case, containing watches, chains and other jewelry, was stolen. He told the police that his case was quite heavy, weighing perhaps 75 pounds, and he placed it on the floor while he paid for his ticket. When he turned around again the case was gone. Mr. Raccicot said that he had been calling for several days on people in the trade. He thought that somebody who knew the value of the samples might have followed him to the depot for the purpose of robbing him. In the reports given out by the police it was said that the property was worth \$3,000, but this figure was somewhat exaggerated. Mr. Raccicot carried little jewelry, most of the stock being in watches. He spends most of his time on the road and travels considerably between Montreal and New York. He is the jeweler whose watches, after he sold them to a New York dealer, were held up at Rouse's Point several months ago by a customs inspector because

# Bigalke & Eckert Co.

== IMPORTERS OF ==  
**WATCHES**

Sole Agents for **Haas, Heveur & Cie.** Fine Geneva Watches

Plain Watches in all Styles, Grades and Prices. Chronographs, Split Seconds, Repeaters. Fancy Decorated Watches for Ladies.

Finest and Most Extensive Assortment of Flat and Ultra Flat Watches in the World.

No. 1 MAIDEN LANE,

NEW YORK



## A Thoughtful Look

into the subject of 10K. Jewelry will convince you that my goods have that beauty of design and high quality of workmanship that make them the pride of the retailer's stock.

Locketts,	Pen Knives,	Bead Necks,
Buttons,	Cigar Cutters,	Heart Charms,
Brooches,	Bracelets,	Fobs,
Match Boxes,	Scarf Pins,	Tie Clasps, etc.

mounted or unmounted, made in **"10K. THAT IS 10K."**

*Send for Selection Package.*

**ROBT. LEVY,** MANUFACTURING JEWELER,  
 Green and Columbia Streets, NEWARK, N. J.

of a failure to comply with a technical rule of the department.

Sealed bids for the assets of Edwin C. Heathcote, jeweler at 13 Maiden Lane, who is now in bankruptcy, will be received at the office of the trustee, 258 Broadway, until May 24.

An announcement was sent out yesterday by the Jewelers Board of Trade to the effect that a package of diamonds had been lost some time since May 11. In the package were 20 brilliants, weighing 20 $\frac{1}{4}$  less 1/32 carats.

Among the jewelers taking part in the 11th annual convention, opened Monday by the National Association of Manufacturers in the Waldorf-Astoria, is Ludwig Nissen, of Ludwig Nissen & Co., who is chairman of the convention committee.

The Aikin-Lambert Co. was recently incorporated to carry on the gold and fountain pen manufacturing business conducted prior to this time under the style of Aikin, Lambert & Co. The capital stock is \$150,000. Directors: J. C. Aikin, H. S. Aikin, New York; W. B. Raymond, Brooklyn.

Austin M. Hill, Jr., formerly with the old house of Heller & Bardell until the dissolution of that firm, and later with Bergstein & Son, and Gustave Schmidt, for 16 years foreman for Bergstein & Son, have formed a partnership under the style of Hill & Schmidt, manufacturing jewelers, at 71 and 73 Nassau St.

About \$2,000 loss was caused last Wednesday by fire in the jewelry store of Simon Lubow, at 1612 Madison Ave. The explosion of a can of gasoline started the flames, which gutted the store and, breaking the windows, were climbing to the upper stories when the fire engines arrived. Mr. Lubow had his stock insured, but not fully.

One day last week a man entered the store of Abraham Koppel, 766 Third Ave., and asked to see some rings. Then the stranger picked up a diamond ring valued at \$150, Mr. Koppel says, and ran. The jeweler gave chase and was joined by Patrolman Fitzpatrick, who happened to be near the store. The man was followed and after a long chase was captured and taken to the 51st St. police station. The police say that they found in his possession the diamond ring that he had stolen and also other jewelry. The man gave the name of August Haack.

Another postponement was granted last week in the case of John B. Brosseau, accused of stealing from Tiffany & Co., by padding the payrolls of the workshop, of which he was long the foreman. The delay was at the request of the defendant's counsel, and Magistrate Wahle said that the case must be heard to-morrow. It is understood that the company has refused an offer made in behalf of Brosseau to make a cash payment in restitution. As the issue is of a criminal character it cannot be settled without the consent of the court, and it is said that the members of the company do not desire a settlement.

The store of Abraham Wolfson, Lawrence, Kans., was broken into one night recently by burglars, who escaped with several hundred dollars worth of miscellaneous jewelry. The safe was blown open by dynamite and the noise was deadened by means of blankets.

## Pittsburg.

An auction is being conducted at 505 Wood St.

S. Sable, an auctioneer, has opened up a branch store at 205 Smithfield St.

Sam F. Sipe last week contributed \$100 to the local California relief fund.

D. I. Seifert, Monessen, Pa., is conducting an auction, intending to quit business.

L. Plainer has opened a store at Donora, Pa. He was formerly proprietor of a store in Center Ave., Pittsburg.

Abraham Lewis is rejoicing over the arrival of a boy at his home. He entertained a large number of local jewelers at his home last Sunday.

Among the out-of-town merchants visiting this city last week were the following: A. L. Doberneck, Derry; J. F. Murphy, Dawson and W. R. Hill, Fayette City.

L. J. Seleznick & Co., 143 Smithfield St., are selling out their stock at auction and July 1 will reopen with a big stock of new goods. The present storeroom is to be altered and newly furnished at considerable expense.

A carload of fixtures for the new store of E. P. Roberts & Sons arrived last week. It will be several weeks before the firm will be able to occupy the new quarters, which is several doors above the present location in Fifth Ave.

H. G. Wasson, head of the jewelry department of the firm of Joseph Horne & Co., who has been chairman of the committee investigating charges made against Pittsburg councilmen for grafting, has resigned from the committee because he leaves this week for Europe.

H. M. Seal, a former partner of A. Johnson, in the jewelry business at Carnegie, Pa., who was thought to have been in the San Francisco fire and earthquake, has been heard from. He is safe and well. He sold out his interest in the business to Mr. Johnson, who recently sold his interest to Charles Zugswarth and retired. Mr. Seal writes to friends here that he escaped injury. Much apprehension was at first felt for his safety.

An information was laid last Wednesday by A. Diamond, McKeesport, who swore out a warrant for the arrest of Harry Kessler, charging him with larceny by bailee. Diamond alleges that Kessler has fled with two diamonds, valued at \$190, having borrowed the jewels to inspect them, preparatory to buying them. Kessler is 21 years old, an Austrian, and is said to have gone to Scranton. A telegram has been sent to the Scranton authorities. Mr. Diamond is a diamond dealer and jeweler. If Kessler is caught he will be brought back to Pittsburg for trial.

Steven Baccario, who is charged by N. Gallinger, 1200 Penn Ave., with swindling him out of \$2,400 worth of diamonds and jewelry, was brought back May 11 from Atlantic City, where he was arrested a week or so ago. Baccario had jet black hair, but since his arrest his hair has turned snowy white. It is alleged in the informations that on March 4 he secured jewelry to the amount stated from Mr. Gallinger on the pretext that he was to sell it to a customer, and four days later fled from the city. He was traced to Philadelphia, Washington and New York, and later arrested at the

seashore. Baccario made several attempts to kill himself since his arrest. At the police station in Atlantic City he released a bolt which held the framework of an iron bed against the wall and let it fall on his head, the blow being sufficiently hard to render him insensible. He also made an attempt to hang himself, while he has made repeated attempts to cut the veins in his throat with his finger nails. He declares that he will yet make away with himself. He is being kept under constant surveillance. When arrested at Atlantic City 36 pawn tickets were found on his person, which had been issued by Pittsburg pawnshops. The police will make an investigation of the pawnshops and endeavor to ascertain how they came to do such a large amount of business with one man.

## Lancaster, Pa.

Elmer Shertzler, with T. Wilson Dubbs, is on the sick list, suffering from a carbuncle.

Isaac Cohen, who came here from Geneva, Switzerland, has taken a position as watchmaker with M. Edelstein.

G. E. Fleisher, head watchmaker for Ezra F. Bowman's Sons, has returned to his duties, after a serious illness.

A. H. Rosenstein, president of the Lancaster Silver Plate Co., is home from a visit to Philadelphia and Baltimore.

Maurice Shortle, Rochester, N. Y., was in Lancaster County last week looking over the ground, with a view to opening a jewelry store.

Parke Weiseman, watchmaker, who left Lancaster, a few years ago, going to Chicago, will open a jewelry store in Cincinnati next month.

John Cloutier, a jeweler of Montreal, Can., aged 55 years, died here, last week, while visiting a sister. Death resulted from stomach troubles. The body was sent to Montreal for burial.

A man giving the name of Thomas Bigler was arrested last week in Chester County for swindling people with worthless eyeglasses, by representing himself as agent for a reputable concern. He is believed to be the same man who, some time ago, tried this game in several towns of Lancaster County.

Abraham Bitner, who was head of the Hamilton Watch Co.'s factory when it was known as the Lancaster Watch Co., is lying at St. Joseph's Hospital, seriously ill, having had an attack of paralysis. One entire side of the body and his speech are affected.

Alvin A. Joliet, Alliance, O., a former student of the Ezra F. Bowman Technical School, has taken a position at Richmond, Va., with the Nowlan Co. Elmer Pierce, a student of the school, is in Milton, Pa., this week, helping out G. Dal Fox & Bro. during the State shooting tournament.

The retail jewelry store of A. Holzman, 94 Whitehall St., Atlanta, Ga., was flooded with water during a fire which broke out at 92 Whitehall St., a short time ago, and destroyed property worth \$20,000.

D. F. Wetzel, Spokane, Wash., has purchased a large warehouse on the north side of Pacific Ave., west of Front St., that place, for \$14,500. The purchase was made as an investment.

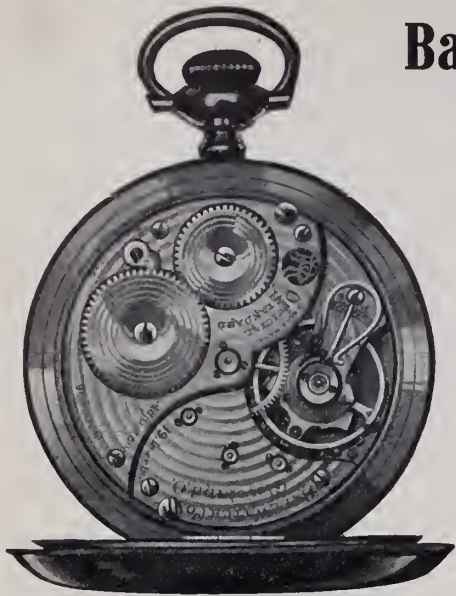

## Ball's Official Standard R.R. Watches

WHAT WOULD YOU GIVE FOR A LIFELONG CUSTOMER?

Try this plan.

Sell your next watch customer a "Ball."

Its reliable performance will convince him you are a dealer to be depended on—he'll keep coming back for other things.

The watch will win you his business and friendship for always.

*Write for booklet, and watch this space.*

We want to add a lot of new friends to the Ball family of railroad watch dealers.

### THE WEBB C. BALL WATCH CO.

CLEVELAND  
Ball Building

CHICAGO  
804-6-8 Railway Exchange

ESTABLISHED 1854.

INCORPORATED 1893

## JUERGENS & ANDERSEN Co., DIAMONDS,

MAKERS OF FINE JEWELRY,  
92 TO 98 STATE STREET,  
CHICAGO.

23-25 Lecliersgracht Amsterdam, Holland.

# THE HERMAN KECK MFG. CO.

CUTTERS OF

# DIAMONDS.

### FOR SALE.

A complete diamond cutting outfit of twenty benches, *European make*, consisting of sawing machines, rounding machines, laps, tongues, dops, scouring stands, etc., all in first class condition. Will sell cheap, if sold in bulk at once, as we have replaced them with American tools.

MANUFACTURING JEWELERS,

SILVERSMITHS.

Recutting and Repairing of Diamonds.

17-19-21-23 West Fourth St.,  
CINCINNATI, O.

## RUDOLPH NOEL & CO.

IMPORTERS OF

Diamonds, Pearls, Rubies, Emeralds, Sapphires, Opals, Olivines,  
Cat's-Eyes, Rose Diamonds and Reconstructed Rubies

2 Tulp Straat, AMSTERDAM

'Phone 1902 John

37-39 Malden Lane, NEW YORK





# WESTERN DEPARTMENT

Western Office:  
204 COLUMBUS MEMORIAL BUILDING,  
CHICAGO.

Telephone:  
4079 CENTRAL,  
CHICAGO.

VOL. LII.

CHICAGO, WEDNESDAY, MAY 16, 1906.

No. 15.

## Chicago Notes.

Herman Bloedel, Milwaukee, Wis., was a Chicago visitor last week.

The Union of Working Jewelers recently made a demand for an eight-hour work day.

Loftis Bros. & Co. have incorporated with a capital of \$500,000, the incorporators being Samuel T. A. Loftis, Francis E. Matthews, Edwin C. Gage.

A. C. Becken has bought all the tools and material stock of the Calvin Clauer Co., and has started a new department, making a specialty of these lines.

Mrs. H. Phillip Epstein, wife of the proprietor of Tiffley's Jewelry Co., 146 S. Clark St., has just returned from a two months' visit spent with relatives in New York.

A. P. Dupuis, formerly assistant jewelry buyer for Mandel Bros., has taken the Chicago agency for the Rex cuff button and opened an office in the Hartford building.

S. Schlientz, formerly with Benj. Allen & Co., has taken the Chicago agency of the Century Material Co., and has opened an office at room 19, McVicker's Theater building.

The National Clock & Mfg. Co., of this city, has been incorporated with a capital of \$10,000 to manufacture clocks and novelties. The incorporators are: W. E. Hunter, B. W. Evans and A. C. Fordham.

The scheme of Chicago jewelry workers to bring their fellow workmen who suffered in the San Francisco earthquake to Chicago and divide their work here with them in order to afford them practical relief has fallen through.

Miss Ethel Eberhart, daughter of John Eberhart, 285 92d St., South Chicago, has been chosen May Queen of the annual commencement festival of St. Mary's Academy, Notre Dame, Ind. Miss Eberhart was chosen from among 300 students.

Mr. and Mrs. Henry S. Daniels, 4317 Vernon Ave., will be at home to their friends Sunday, May 20, 3 to 6 p. m. and 7 to 10 p. m., this being the 20th anniversary of their marriage. Mr. Daniels is credit man for Jos. Brown & Co.

"Kid" Connors was arrested last week on a charge of smashing the window of the Bauman Jewelry Co. early in the Winter and stealing a diamond heart and chain valued at \$9,000. Connors was arraigned May 8 and bound over to the Criminal

Court in \$3,000 bail. He was sent to jail.

Amelia M., daughter of Christian Jackle, New York, who was recently married to J. W. Aiken, a well-known traveling man, with her husband, has been spending some time in this city on a wedding trip. Among other cities which Mr. and Mrs. Aiken will visit during their honeymoon is Denver, Colo., after which they will return to New York.

James Reddick, public administrator, has assumed charge of the estate of the late Max Lippert, the Chicago jeweler, who died suddenly in Sioux City, Ia., in April. Mr. Lippert's business in the Columbus Memorial building has been closed, and the stock will be sold. The stock appraisal has not been completed, but will be about \$5,000. With outstanding accounts and cash in the bank the estate will amount to about \$17,000. There are few debts.

Charles H. Hulburd, president of the Elgin National Watch Co., is one of the 32 trustees named to take charge of the affairs of a theater for art in Chicago. The sum of \$55,000 has been raised for the project and Steinway Hall secured for the first season, which will open this Fall. Mr. Hulburd is taking a prominent part in the affairs of the new enterprise, which will have a permanent home in Michigan Ave. if the first season proves a success.

The scheme to rehabilitate the Cash Buyers' Union, First National Co-operative Society, by raising \$500,000 has failed, and on Friday Judge Bethea instructed Receiver E. C. Day to arrange for the sale of \$300,000 worth of the assets of the company. S. O. Levinson, representing the men behind the reorganization scheme stated in court that the failure to raise the necessary \$500,000 to put the company on its feet was due primarily to the San Francisco earthquake, Chicago bankers preferring to keep ready cash on hand for investments that promised greater returns than did the Cash Buyers' proposition. Judge Bethea refused to allow the receiver to conduct an auction sale because the law provides that a trustee to be elected by the creditors must do this unless the property is perishable.

Armel Bros., Holton, Kans., are about to enlarge their store and put in a complete line of new fixtures.

## Toledo, O.

Scharbach Bros. have removed from 313 Cherry St. to more comfortable quarters at 505 Summit St.

W. R. McFadden, for 12 years employed by a leading retail jeweler here, has started in business for himself at 407 Summit St.

At a meeting of the Board of Directors and stockholders of the Merrill & Broer Co., held May 7, the old officers were re-elected for 1906.

Norman C. Hascall recently commenced proceedings for remission of the forfeiture of a piece of jewelry, the personal property of his wife, on which the Treasury officials insisted full duty should be paid, when Mr. and Mrs. Hascall returned from Europe some time ago. Mr. Hascall refused to pay and began proceedings to lay the case before the Secretary of the Treasury. An application for this purpose having been filed in the United States District Court at New York, the matter was referred to United States Commissioner Alexander to hear and take testimony. Testimony of witnesses in this city was taken last week on commission and this will be introduced when the proceedings are formally opened in the city of New York.

The trade of this city have been interested in proceedings brought by J. G. Boutelle, a retail jeweler and fancy goods dealer at 111 Summit St., against a watchman. Some time ago the store of John Mitchell, Jr., a pawnbroker and neighbor of Boutelle, was entered by thieves, who were frightened away by a night watchman before they stole anything. The local papers gave the story great prominence, and this did not meet with the approval of Mr. Boutelle, who cut a clipping from a paper, pasted it in front of his store and headed it "Another Fake Robbery." The jeweler's act aroused the ire of a friend of the watchman, who took off the sign and destroyed it. Then Mr. Boutelle had words with the watchman in a restaurant, and the watchman knocked him down and pummeled him. Boutelle at once had the watchman arrested for assault, but the judge discharged the prisoner, saying that Boutelle's act started the trouble. Mr. Boutelle's right eye was badly blacked in the scrimmage.

# To the Jobbing Trade.



And you skip an opportunity of knowing that we make a most complete line of mountings, both set and unset, and sell at reasonable prices.

**Diamond Tiffany Bunch Rings**  
**Diamond Assorted Bunch Rings**  
**Diamond Gents Bunch Rings**

**Diamonds sold by the carat.**  
**Mountings at our regular prices.**

Largest assortment ever shown.



## Cincinnati.

Philip Zoellner, Portsmouth, O., was a visitor here last week.

H. Promnitz is at business again after a three weeks' siege of illness.

Joseph Phillips, of the Sterling Glass Co., has returned from a week's stay in New York.

Word has been received here that A. Herman, of Herman & Loeb, arrived safely at Carlsbad, Ger.

A. A. Spiegel, of the Gustave Fox Co., is calling on the trade in Chicago and the southwest.

John Holland, Sr., of the John Holland Gold Pen Co., spent a part of last week in Columbus, O.

John A. Herschede, of the Herschede Hall Clock Co., is making a business trip through the east.

Richter & Phillips have begun making alterations to their establishment, which will greatly improve their quarters.

Steven Lenbusher, of L. Gutmann & Sons, with his wife, left, Monday, for New York, from which port they were to start on a tour abroad.

J. H. Leitz, watchmaker for Louis Hummel, 9 Emery Arcade, celebrated, May 11, at his home, 1760 Vine St., his 25th wedding anniversary.

Wallenstein, Meyer & Co., about July 1, will be represented in the west by Elmer Wallenstein, who was lately added to the road force of this company.

George W. Newstedt, 4th and Race Sts., and August Newstedt, of Lindenberg, Strauss & Co., are enjoying a 10 days' sojourn at French Lick Springs, Ind.

Charles Lurie, formerly with L. Sive, Elwood, Ind., was here last week purchasing stock for the new jewelry and optical store which he has opened at Marion, Ind.

Out of town dealers who were here during the past week, not elsewhere mentioned, included: J. B. Morross, Dayton, O.; D. A. Lamb, Wilmington, O.; William Shire, Paris, Ky.; J. P. Hess, Fond-du-Lac, Wis.; F. Maier, Bowling Green, Ky.; Andrew Clooney, Maysville, Ky.; Frank B. Carey, Lebanon, O.; Edward Mueller, Hamilton, O.

About 8 p. m., May 7, while William Fink was preparing to close his jewelry store at 1424 Main St., a negro, who had been standing in front of the door for some time, pulled a stone from under his coat and smashed the glass. Hastily grabbing a tray of rings, valued at about \$1,000, the thief ran away and escaped. In the loot were 12 diamond rings, with stones ranging from  $\frac{1}{4}$  to  $\frac{1}{2}$  carat. It has since developed that the negro disposed of the plunder at a second hand store at 1822 Central Ave., as the second hand dealer's wife started out to sell the rings among the jewelers. The dealers suspected that the goods had been stolen and notified the police, who apprehended the woman as she was leaving one of the stores. The rings were identified by Mr. Fink, who has now recovered much of the stolen property.

M. L. Bowen has sold his business in Fort Madison, Ia., to Mr. Scheffer.

W. H. Griffin has purchased the business of P. B. Guthrie, Hughes Springs, Tex.

## Kansas City.

F. G. Puffer, Kansas City, Kans., enrolled at the Kansas City Polytechnic Institute last week.

Eunice Sayre has taken a position as engraver with the jewelry department of the Jones Dry Goods Co.

Sixty of the opticians attending the convention last week were graduates of the Southwestern Optical College, of this city.

A. M. Bennett, Warsaw, Mo., has finished his course at the Kansas City Polytechnic Institute, and returned home ready to practice.

Noble L. Fuller, of the Edwards & Sloane Jewelry Co., left last week for New York, where he will be in the market until about June 1.

E. S. Villmoar, with the C. B. Norton Jewelry Co., which concern he represents in Missouri and Texas, was a visitor to the house last week.

Dr. J. W. Tyrell has finished his course with the Kansas City Polytechnic Institute, and will go to Seattle, Wash., to engage in business for himself.

J. C. Haupt, Peabody, Kans., is another of the boys of the Kansas City Polytechnic Institute who has finished his course and returned home.

Mrs. Lynch, mother-in-law of A. E. Pittenger, of the Kansas City Horological School, died suddenly while visiting in Medford, Okla., recently.

Otto A. Knaul, who covers Missouri, Kansas and Nebraska for the Woodstock-Hoefer Watch & Jewelry Co., was in the city to meet his many friends at the convention, last week.

G. T. Sewell, a graduate of the Kansas City Horological School, is about to locate in Iola, Kans. T. E. Coffman, from the same school, is going to locate in Toronto, Kans., where he has purchased the store of J. A. Robinson.

It was found that a great many of those who attended the convention here had failed to register, including the following: S. Rhodes, Ulysses, Nebr.; J. A. Lukens, Bucklin, Kans.; J. Keehnel, Hale, Mo., and F. S. Shepard, Clarence, Mo.

The following new pupils have just enrolled with the Southwestern Optical College: Ida L. Hale and Wm. B. Hale, Weatherford, Okla.; W. G. Chestnut, Kansas City, Mo.; S. P. Campbell, Kansas City, Mo.; L. T. Medley, Yellville, Ark., and T. M. Hutto, Kingman, Kans.

C. L. Merry, president of the Merry Optical Co., as expected last week, was selected as a member of the upper house of the City Council. His election was by the upper house itself to fill the vacancy caused by the election of one of their number to the presidency of the upper house.

The banquet given the visiting jewelers and opticians by the local manufacturers and jobbers was a success from start to finish, and that meant from 7 p. m. to 12 p. m. There were a number of speeches, some very excellent vaudeville stunts and plenty of good cheer. One of the most interesting speeches of the evening was delivered by Father Dalton, of the Catholic Church, and it was on very short notice. He took as his subject a book he had purchased years ago in an old book store in Europe, giving the early history of optics,

and was able to post all those present on some of the early practices which, while they would hardly do to follow now, were very interesting to listen to.

## St. Louis

F. S. Brickey, De Soto, Mo., was among the visiting jewelers in St. Louis last week.

C. F. Mathey, vice-president of the Mermod, Jaccard & King Jewelry Co., served on the jury last week in the Circuit Court.

Julius Harwitz is the latest to enter the retail jewelry field in St. Louis. Mr. Harwitz has opened a store at 1423 Pendleton Ave.

Matthew Gassman, 2740 Hickory St., a brother-in-law of James J. Burke, president of the Brooks Jewelry & Optical Co., died last week.

H. Crompton, of the L. Bauman Jewelry Co., has returned from a visit to New York, Bridgeport, Providence and Attleboro on business for that firm.

Fred Simon, Collinsville, Ill.; L. A. Holdener, Belleville, Ill., and William McKinley, Little Rock, Ark., were among the visiting jewelers here last week.

Joseph J. McKenna, of the Bauman-Massa Jewelry Co., has returned from a trip through Indian Territory and Arkansas. He reports the southwest in a flourishing condition.

Joseph Auer, of the Bauman-Massa Jewelry Co., departed recently for a visit to New York, Providence and other eastern cities on a buying trip. While in New York he will be a guest at the New Astor.

Among the jobbers and manufacturers who visited St. Louis last week were the following: Wade W. Williams, of Warren & Williams; J. A. Granbery, of J. A. & S. W. Granbery, Newark, N. J.; Ernest A. Rose, of Weigle & Rose, Newark, N. J.; J. C. Bigalke, of the Bigalke & Eckert Co., New York.

Sam H. Bauman, president of the Bauman-Massa Jewelry Co., departed Tuesday for New York, whence he will sail on the *Kaiser Wilhelm II.* for an extended European trip. Mr. Bauman will visit London, Amsterdam, Antwerp and Paris during his two months' visit abroad. While in New York Mr. Bauman will be at the New Astor Hotel.

J. J. Samesraugher, manager of the New York store of the Mermod, Jaccard & King Jewelry Co., will return here shortly, as the branch of that firm in the metropolis will be closed. H. C. McCleary, who also went from this city to New York, will likewise return. C. F. Mathey, vice-president of the firm, is authority for the announcement of the closing of the branch store.

License Commissioner Clifford has instituted his annual crusade against itinerant vendors who flock to the city each Summer and neglect to take out licenses. A young man who was recently arrested at 12th and Olive Sts. for attempting to dispose of a tray filled with paste diamonds, gave the name of Anthony Economos. He had \$120 in his possession when taken into custody.

The Vann Mercantile Co. has been incorporated in Albuquerque, N. Mex., to succeed the jewelry and drug business of S. Vann & Son.

## Indianapolis.

T. W. Gardner is recovering from a severe attack of pneumonia.

Emil Kernel, watchmaker for Carl L. Rost, is building a double house in Madison Ave.

Charles Bernloehr, watchmaker for Chris. Bernloehr & Bros., is visiting along the Pacific coast.

Carl L. Rost has returned from Logansport, where he attended the State meeting of the T. P. A.

J. H. Reed, who is making a trip through the west, is spending this week at San Francisco viewing the earthquake ruins.

T. B. Westker, formerly with Hart & Raber, Anderson, Ind., has taken a position as watchmaker with Krauss & Sector.

Ernie Newlin has retired from the firm of Newlin & Schmelz, 26 S. Illinois St. The business will be continued by J. W. Schmelz.

John Taylor has taken a position with Gray & Taylor, 365 Massachusetts Ave. He formerly was connected with the First National Bank, at Madison, Ind.

A gold nugget, weighing 3 dwts., 7 grains, was picked up recently on the farm of Ikko Matsumoto, in Morgan County. A company has been organized to prospect for gold on the farm.

A handsome gold badge, studded with pearls, has just been finished by C. B. Dyer. It will be given by the Indianapolis Woman's Whist Club as a prize for the highest score at the national convention of Women's Whist Clubs, to be held at St. Louis next month.

The A. P. Craft Co. is making several additions to its shop force. Three men have been taken on recently and others will be added. The firm is now observing the half Saturday holiday policy. The shop closes at 1 o'clock on Saturdays. Retail jewelers belonging to the Merchants' Association have decided to close their places of business at 5 o'clock every afternoon except Saturday during July and August.

Many out of town jewelers were in the city last week, calling upon the local jobbers and manufacturers. Among the number were: Mr. Barnes, of Barnes & Foster, Spencer; H. A. Pauley, Bloomington; J. F. Harding, Brownsburg; B. Maier, Edinburg; Aaron Pursel, Noblesville; D. S. Whittaker, Lebanon; Mr. Raber, of Clark & Raber, Anderson; J. M. Seifert, Mulberry; C. E. Hodgen, Kokomo; Ross J. Haseltine, Kokomo; J. W. Hudson, Fortville; H. Wheeler, Dana, and J. A. Pickett, New Castle.

## South Bend.

Cleiss & Clauer are holding an auction sale prior to remodeling their store. Harding & Gregory are conducting the sale.

J. Lott Losey is offering a solid gold watch charm to the first Central League player who makes a home run before June 1 on the local baseball grounds.

The Elks held a fair in South Bend last week. Frank Mayr & Sons contributed a hall clock, O. P. Noisom gave a silver plated baking dish, Frank C. Toepp gave a cut glass bowl and J. Lott Losey gave a mission clock. The South Bend Watch Co. gave two of its high-grade watches.



# A. C. BARD & CO.

IMPORTERS AND CUTTERS OF **DIAMONDS**

Loose or mounted goods on memo. to responsible dealers.

**103 STATE ST., CHICAGO. COLUMBUS MEMORIAL BUILDING.**

## Anniversary Clock

TRADE-MARK REGISTERED.

All **genuine** Anniversary Clocks running 400 days, bear the above name plainly lettered on the dials.

**Beware of Imitations** and infringements of our trade-mark.

Every up-to-date jeweler should have the Anniversary Clock in stock.



Parlor Mantle Regulator, No. 4.  
Height, 15 1/4 in.; width, 10 1/4 in.; Porcelain Dial, 4 in.



If you wish the ordinary 400-day clock, with brass base, we have it at \$8.00 each, but do not guarantee or recommend it.

**THE BOWLER & BURDICK CO.,**  
CLEVELAND, O.

Sole Agents for the U. S. Send for Catalogue.



The AMERICA Alarm is a trade-waker for dull stores—a special price on such a necessary article is a good advertisement that pays its own way.

The Western Clock Mfg. Co.

LA SALLE, ILL.

## LOOK

AT THE NAME

you see on



## REIS' Advertising Tape

and you will find in every instance it is that of a

**Prosperous Merchant.**

It costs very little more than common string, and besides being neat and attractive is a *continuous advertisement.*

Made in various widths and colors.  
Write for Samples and Prices.

**G. REIS & BRO.,**



640 Broadway, New York.

# JOS. NOTERMAN & CO. DIAMONDS

IMPORTERS AND CUTTERS

Recutting and Repairing odd shaped and chipped stones a specialty. Manufacturers of Mountings and Fine Jewelry. Special Designs Furnished.

CINCINNATI, OHIO.

## San Francisco.

Carrau & Green have opened temporary quarters at 1390 Waller St.

F. W. Carter, Santa Rosa, Cal., and his wife were killed by the earthquake.

J. S. Dinkelspiel has opened a pawnshop and jewelry store at 2408 Fillmore St., in the new retail district.

The Alexandria Diamond Palace, formerly located on Market St., continues in business on Fillmore St., near Pine St.

Brittain & Co., formerly in the retail jewelry business at 120 Geary St., have opened a retail hardware store on Van Ness Ave., in the new retail district.

W. R. Landram, representative of Simons Bro. & Co., formerly located at 120 Sutter St., was pleased to find the contents of his safes in a fair condition.

M. L. Levy, of M. L. Levy & Co., formerly in business at 115 Kearny St., opened his safes, yesterday, only to find that everything in them was destroyed or melted.

C. F. A. Sturts, formerly in business in the Adams building, Kearny St., reports that the contents of the safes in his store were found to be but little injured.

The safes of the Harris Loan Office & Jewelry Store, at 105 Stockton St., were dragged from the ruins last week and opened. The contents, valued at \$40,000, were ruined. The insurance amounted to \$15,000.

Sing Woe, formerly in the jewelry business at 935 Dupont St., whose vaults were opened, last week, found the contents either melted or destroyed. Later about \$2,000 worth of melted silver and gold was stolen and cached, but was afterward traced and recovered.

Rudolph Schwartzkopf, manufacturers' agent, formerly located in the Crocker building, has arranged to locate in Los Angeles for the time being. From that point he will cover the coast trade until such time as conditions seem favorable to again establish himself in this city.

G. Marcus, president of the California Jewelry Co., has returned from New York, which place he had reached on his way to Europe at the time of the big fire. It is understood that after completing his arrangements here he will return east and will later go on to Europe. The company is now located in the Delger building, corner of 14th St. and Broadway, Oakland.

The remainder of the old safes of A. I. Hall & Son, in the Aronson building, were opened, last week, and everything was found in good condition, although in some cases there had been a little sweating. It will be necessary to return all movements and watch cases to the factories for repair. The company's diamond safe was opened without difficulty by the combination and the contents were found to be absolutely uninjured. A. W. Huggins, president of the concern, will go east shortly, to arrange for new stock for the company's new store here.

J. B. Whitney & Co., consisting of J. B. Whitney and W. J. Browne, have succeeded J. B. Whitney as representatives of the Holmes & Edwards Silver Co., the Derby Silver Co., the Ingraham Co. and the American Cuckoo Clock Co. on this coast. Mr. Whitney was formerly located at 120

Sutter St., and the new firm is located temporarily at 1116 Broadway, Oakland. The loss at 120 Sutter St. was total. Mr. Whitney's home, at 605 O'Farrell St., this city, was also burned. The home of W. J. Browne, 1251 Willard St., escaped the general destruction. At the time of the earthquake Mr. Browne was at the St. James Hotel, San José, where he escaped with his life, notwithstanding the partial destruction of the hotel. The new firm of J. B. Whitney & Co. has already secured quarters in the Jewelers and Silversmiths' building here, into which it will shortly move.

## Detroit.

George Chambers, Mt. Clemens, Mich., was in Detroit, recently, on the way home from a western trip.

J. M. Harrison has taken his old position with the Chas. A. Berkey Co., made vacant by the resignation of Chas. H. France.

Fire last week gutted the Inglis block, at Flint, Mich., causing damage of \$45,000. Among the losers was S. M. Cooley. His loss is covered by insurance.

Roehm & Son, 184 Woodward Ave., deny the report that they have sold their lease to the Caille automatic slot machine concern. They will continue business at the present place.

Geo. Swan, aged 54 years, a brother of Judge Henry Swan, of the United States Court, died recently after a lingering illness. The deceased was for many years well known as a jewelry expert.

After an existence of 20 years, the partnership of Wright, Kay & Co. has been ended and a corporation has been formed under the same name. The paid-up capital is \$300,000 and the majority of the stock is owned by members of the former partnership. Several of the older clerks have taken blocks of stock and four or five business men of Detroit have purchased shares. The business was started March 1, 1872, under the name of Roehm & Wright, and was changed to Wright, Kay & Co., 14 years ago. At a stockholders' meeting of the firm, May 14, H. M. Wright was elected president and general manager; John Kay, vice-president, and F. A. Kelsey, secretary-treasurer.

## Pacific Coast Notes.

C. B. Linn, Prescott, Ariz., has returned to his home after a visit to Hot Springs, Ark.

Lindi & Son, San Francisco, and H. Welch are visiting friends in San Miguel, Cal., and will remain until Mr. Lindi can rebuild on the old site of his store.

E. A. Gilson, formerly of Calistoga, Cal., is visiting in St. Helena. Mr. Gilson lost everything in the San Francisco fire and for the present will remain in St. Helena.

J. C. Wakefield has succeeded E. L. & L. W. Cheney, former proprietors of the Red Front Jewelry Store, Healdsburg, Cal., and has ordered goods from the east. Mr. Wakefield will make a specialty of work in the optical line.

The death is reported of J. T. Nelson, of the Nelson Jewelry Co., Cotter, Ark.

## Denver

Paul Weiss has returned from a three months' trip to Europe. Mr. Weiss made an extensive visit to the optical centers of France and Germany, and a foot tour through Switzerland, his native land.

William Oppenheim has purchased part of the stock of S. Cohen & Co., Victor, Colo. Mr. Cohen has gone to reside in New York. The balance of the stock was purchased by a Cripple Creek firm.

S. S. Parr, manager of the Columbian Optical Co., here, has stolen a march on his friends and surprised them with the announcement of his marriage to Mrs. Ellen Arnold, who is also connected with the concern.

The will of Stanton Penderly, partner in the Ford Optical Co., who committed suicide March 26, during a fit of temporary insanity, caused by an abscess on the brain, has been probated. His interests in the optical business are to be divided according to the terms of the writ among his three sisters, Beatta, Grace and Alice, and his brother, Newton. He also left an insurance policy for \$6,000 and some shares in a mining company. C. E. Ford, his former partner, is named as co-executor. The will was written on an ordinary sheet of note paper, and the language indicates that the testator contemplated suicide while drawing it up.

Several trophies to be given in contests among teams at the convention of the Elks, which meets here this Summer, have been on exhibition during the past week in the windows of the Bohm-Allen Jewelry Co. A handsome loving cup has been donated by the Derby Silver Co., Derby, Conn. A cut glass bowl valued at \$150, is the gift of T. G. Hawkes & Co. A \$200 gold watch has been donated by D. Gruen, Sons & Co. Mouser Bros. are represented by a beautiful silver cup. A gold elk's tooth charm has been presented by Henry Freund & Bro., New York. Three other prizes which are suggestive of Colorado's riches are a bar of silver, given by the citizens of the Silver Plume Mining Camp; a gold bar valued at \$750 from Silverton, Colo., and another bar of silver, presented by the Idaho Springs Lodge of Elks.

## Savannah, Ga.

R. Van Keuren, of R. Van Keuren & Co., presented to the Savannah Golf Club a silver cup to be contested for annually. It will be known as the Van Keuren Cup.

Mr. Van Keuren was recently elected a member of the advisory board of the Real Estate Owners' Association of Savannah.

John C. Schwartz, trustee in bankruptcy for Simon & Sternberg, claims the bankrupts have not accounted for property worth \$8,600. He has brought the matter to the attention of A. H. MacDonnell, referee in bankruptcy.

Calvin C. Moyer, Orwigsburg, Pa., is building an addition to the side of his property on W. Market St.

The store of O. J. Dodge, Barre, Vt., was damaged by a fire which broke out at that place last Wednesday afternoon, and destroyed property in the Quinlin block valued at about \$8,000.

## Providence.

A number of the shops are still engaged in their Spring house cleaning, boilers being inspected and other necessary repairs made.

The will of Charles Vigneron, whose death was recorded in THE CIRCULAR-WEEKLY recently, has been filed for probate and has been referred for hearing in the Municipal Court in this city this week.

The George H. Cahoon Co. has taken out articles of incorporation to manufacture jewelry, with a capital stock of \$75,000. The incorporators are George H. Cahoon, C. M. Van Slyck and E. S. Chaffee. The concern will remain in Providence.

William V. Brown, who died last week, was well known to many of the jewelers and was for many years a journeyman jeweler. He learned the trade in the early '70s, but later drifted away from it and engaged in other pursuits.

The local fund for the relief of the San Francisco jewelers is steadily growing and has reached approximately \$8,000. None of this had up to last accounts been remitted, but will be as soon as a committee is designated by the San Francisco jewelers to handle its disposition.

The Gorham Orchestra recently gave the fourth in its series of socials and the event was one of the most successful the organization has yet held. An entertaining programme was presented and at its conclusion dancing was enjoyed. The affair was held in the Casino at the works and the proceeds will be devoted to the fund for the relief of the San Francisco sufferers.

Miss Mary E. Lowry, who has for some time been in the employ of the Ostby & Barton Co., in the shipping department, was presented last week with several bouquets and a handsome etching, as she had decided to sever her connection with that firm. The presentation took Miss Lowry somewhat by surprise, but she made a fitting response. She has been in the employ of the concern since 1888.

The Rodenberg-Smith Co. has gone out of business and Edwin A. Smith and W. H. Manchester have incorporated the business under the style of the Manchester-Smith Co. The capital stock is \$75,000 and Edwin A. Smith is the president and William H. Manchester is treasurer. M. S. Rodenberg has formed a copartnership with M. J. Dunn under the firm name of Dunn & Rodenberg.

According to the provisions of the will of W. O. Cornell, filed last week, the deceased jeweler made a number of public bequests, the Children's Friendly Society, the Society for the Prevention of Cruelty to Children, Cornell University, Tufts College, Animals, the Society for the Prevention of Cruelty to Children, Cornell University, Tufts College, Home for Aged Colored Women and Shelter for Colored Children being among the beneficiaries.

The employes of Martin, Copeland & Co. had an enjoyable outing at Emery Park, Saturday. The party went down by special cars and on arrival at the grounds proceeded to engage in various athletic sports. The ball game was won by the single men, the bachelor twirler proving too much for the benedicts. At noon a chowder was served and at 4 o'clock a genuine Rhode Island

clam dinner was enjoyed. More sports and a social hour in the Casino brought the day to a successful close.

B. A. Ballou & Co., incorporated last week, the incorporators being Barton A. Ballou, Portsmouth; Frederick A. Ballou, Barrington, and George C. Anderson, Pawtucket. According to the articles filed with the Secretary of State, the concern is constituted for the purpose of engaging in the business of buying, selling and dealing in jewelry and other merchandise and for the transaction of such other business as is connected therewith or is incidental thereto. The capital stock is \$100,000 and an additional \$100,000 in preferred stock.

## Attleboro.

Louis J. Lamb, of C. H. Allen & Co., has gone to Philadelphia for medical treatment, having been in ill-health for several months.

John W. Luther, of J. W. Luther & Co., has gone to Maine for recuperation in the wilderness. Mr. Luther's health has not been as good as formerly, and he has experienced particular trouble with his eyes.

A force of linemen is busy making radical changes in the arrangement of poles and wires all through the factory district in the center of the town, which is occupied almost wholly by jewelers. The erection of the new cement shop for Charles H. and William C. Tappan, of the D. F. Briggs Co., is the primary cause of the changes.

The Dunbar, Leach, Garner Co., through Treasurer Edwin F. Leach, last week, filed with the Secretary of the Commonwealth its annual corporation report. The figures show: Manufactures, \$9,914; machinery, \$13,030; cash and debts receivable, \$41,813; merchandise, \$9,092; stock, \$8,000; accounts payable, \$30,483; surplus, \$35,416.

Edgar M. Docherty, who has held a responsible position with the Bristol Mfg. Co. for the past three years, severed his connection with that firm last week, having accepted a similar position with a Providence firm. His associates presented him with a handsome gold watch, a Bigney fob, and a \$20 gold piece.

F. H. Sadler & Co., through Treasurer Frank H. Sadler, last week filed its annual corporation report. The figures show: Machinery, \$5,400; cash and debts receivable, \$32,959; manufactures and merchandise, \$48,158; patent rights, \$5,000; good will, \$5,000; miscellaneous, \$11,649; trade-marks, \$400; stock, \$60,000; accounts payable, \$438; surplus, \$52,683.

Hon. Sidney O. Bigney, of S. O. Bigney & Co., was on the boat bound for New York, a few nights ago, and found a bridal couple on board, the bride a former employe of his jewelry establishment in Attleboro. He insisted on inviting them to lunch, and on their acceptance the "lunch" proved to be a sumptuous banquet.

S. W. Card & Co., manufacturing jewelers, Mansfield, Mass., last week, through Treasurer D. E. Harding, filed with the Secretary of the Commonwealth its annual corporation report. The figures show: Real estate, \$20,000; machinery, \$28,000; cash and debts receivable, \$58,696; manufactures and merchandise, \$15,236; stock, \$50,000; accounts payable, \$74; surplus, \$71,858.

## North Attleboro.

George K. Webster is planning to build a handsome residence on Washington St.

Thompson & Remington, Plainville, Ore., are to make an addition 28 by 30 feet to their shop on E. Bacon St.

The factories of the Paye & Baker Mfg. Co. and the Estate of O. M. Draper have granted their employes the customary Spring and Summer half holiday on Saturday afternoons.

Arthur C. Sylvester has resigned as president of the local Fish and Game Association. Because of his residence in Providence he is unable to hold the office.

A tank burst at the Company Shops Friday morning, and caused the offices of the H. D. Merritt Co., Estate of O. M. Draper and E. Ira Richards & Co. to be flooded. But very little damage was done.

Local jewelers are exhibiting much interest in baseball, and teams have been formed among the employes of Maintien Bros. & Elliott, the Codding & Heilborn Co., Sadler Bros. and the W. & S. Blackinton Co.

At the meeting of the North Attleboro Country Club, last week, Orin W. Clifford was chosen president and C. Ray Randall and Edgar L. Hixon vice-presidents. Herbert French, Donald Le Stage and Herbert J. Straker were also elected to office.

The J. F. Sturdy's Sons Co. has been incorporated under the laws of the State of Rhode Island for the manufacture and sale of jewelry, etc. Frederic E. Sturdy, Herbert K. Sturdy and Frank M. Sturdy are the incorporators. The capital is \$300,000.

The burglary at the Miller, Fuller & Whiting factory, which was reported in the last issue of THE CIRCULAR-WEEKLY, was a more serious blow to the firm than would seem from the value of the articles taken. The great loss was in pins and brooches on the pattern boards, which made it necessary to recall a line that was on the market in order to secure duplicates. The watchman at the Whiting building has reported to the police that last Wednesday night a second attempt was made to rob firms in that building, but he says he frightened the men away by discharging his revolver.

## Omaha.

T. L. Combs, of T. L. Combs & Co., is serving on the jury.

C. S. Peterson, watchmaker, formerly with A. B. Hubermann, has taken a position with Joseph P. Frenzer.

Walter Lodge, of the Mawhinney & Ryan Co., is home from a trip to Hot Springs, S. Dak.

Mr. Patch, with C. A. Tucker, Lincoln, Nebr., was in this city, visiting friends and replenishing stock, last week.

L. A. Borsheim, of Brown & Borsheim, has returned home from a watch inspection tour over the Missouri Pacific Railway.

Edward Niewohner, Columbus, Nebr., president of the Nebraska Jewelers' Association, was here, last week, purchasing stock.

Out of town buyers in this city, last week, were Harry Dixon, North Platte; A. G. Kupka, Schuyler; W. W. Bell, Yutan.

Dr. F. C. Little, Bloomfield, Nebr., has sold his store, and will leave shortly for the west, where he expects to look around for a new location.

## Connecticut.

John Lynch, Bridgeport, was recently granted a patent on a design for forks, spoons, etc.

The engagement was recently announced of Miss Mabel Harris to Abram Frank, a retail jeweler of Bridgeport.

The Silver City Cut Glass Co., which was contemplated about a year ago in Meriden, contemplates moving its plant to another city.

The store of Alexander Weed, Stamford, was slightly damaged by a fire which broke out in the building occupied by him, last week.

Valentine Ashforth, for several years in the employ of the C. F. Monroe Co., Meriden, has resigned and taken a position in New Jersey.

The engagement has just been announced of Miss Evelyn M. Goodsell and Edward A. Jennings, treasurer of Jennings Bros. Mfg. Co., Bridgeport.

The Seth Thomas Clock Co., Thomaston, is among other corporations which are interested in the projected extension of the Terryville trolley system to Thomaston.

Frederick H. Mann, formerly in the employ of the Parker Clock Co., Meriden, is reported to be seriously ill at St. John's Sanitarium in Hartford, where he recently underwent an operation.

The Bradley & Hubbard Mfg. Co., Meriden, has contributed \$100 to the fund for the relief of the family of the late Allen S. Butler, the fireman who lost his life during a recent fire at the concern's factory.

A patent was granted to Wilson E. Porter, New Haven, on a new form of watch barrel arbor, May 8. Among other patents granted was one to A. Bannatyne on a Waterbury wheel for clocks and watches.

Robert Denison, a foreman for some time in the employ of the Waterbury Clock Co., Waterbury, recently received from his fellow workmen a handsome diamond ring on the occasion of his resignation from his position.

The body of John G. Baker, formerly in the employ of J. H. Sessions & Son Co., Forestville, was found floating in a pond on West St., Southington, Thursday night. The deceased had at one time resided in Plainville.

Frank Harman, a traveling representative well known in Danbury, died at his home, Tuesday of last week. The deceased had visited Danbury at frequent intervals during the past 18 years. He is survived by a widow and one daughter.

Geo. H. Wilcox has been chosen vice-president of the Meriden Country Club, and Charles T. Dodd, secretary and treasurer. Mr. Wilcox and Charles T. Dodd, together with Samuel Dodd and W. F. Parker, have also been chosen members of the club's Board of Governors.

The large electric sign which was recently placed upon the side of factory "E," International Silver Co., Meriden, facing the railroad tracks, was illuminated for the first time on Tuesday evening, of last week. The display was made in order to test the wiring and was left in operation for about one hour.

A number of adjusters who had been employed on piece work by the New Haven Clock Co., New Haven, discontinued work

May 9, after a request for higher wages had been denied them by Assistant Superintendent King. According to Mr. King, the strikers' demands were unreasonable. The number of hands involved is comparatively small, and their absence does not embarrass the company in any way.

## Newark.

Percy M. Layman and Sydney C. Straus have been admitted into the firm of Schults, Leiss & Co.

Wm. T. Gardner, who formerly had a jewelry store at Park Ave., Paterson, was locked up in the county jail in that city last week on an indictment charging him with forgery.

Edmond C. Chase, who was employed in the silverware factory of the Wm. B. Kerr Co., 144 Orange St., did not return home from work last Saturday, and his wife, becoming anxious, has asked the police to assist in finding him.

Clark & Merigold, electroplaters and colorers, have opened quarters at 46 and 48 Oliver St., Newark, N. J. Mr. Clark was for many years with Geo. H. Cahoon & Co., of Providence, R. I., and Mr. Merigold with Capron & Co. and other eastern houses.

Edward Hasse was arrested last week at Fair Haven, N. J., on the request of the police of Boston, Mass. It is said that he sold spectacles made of plain glass, and also sold a worthless eye wash, taking in part payment the patients' old spectacles, which were of value.

In the District Court at Paterson one day last week the case of Jos. Stouffer, Iowa City, Ia., against Mary Decker to recover \$90, the price of a quantity of cheap jewelry, was tried. The evidence indicated that the jewelry was sold by the Lyon Taylor Co., of Iowa City, to Mrs. Decker's husband during her absence from the store. The company later assigned the claim to the plaintiff in the present suit. The defense was that Mr. Decker had no authority to buy for his wife, under whose name the business is conducted. It was also claimed that when he signed the paper agreeing to pay the \$90 he did not understand the character of the document. It was further said Mrs. Decker placed the jewelry in storage and repudiated the transaction. Judge Lewis, after hearing the evidence, decided that there was no valid claim against Mrs. Decker.

## Paris Letter.

PARIS, May 1.—Owing to labor troubles and the general strike of the jewelry employes, who demand eight instead of 10 hours' work on the same salary basis as formerly, the diamond market has been extremely quiet. The agitation expected today, when all the various branches of industry will demand the eight-hour day, has hurt business, and, further, as the legislative election in France will take place, the majority of merchants are holding back their purchases until after this event. There have been few transactions with Italy, while business with Spain is not much better.

A new syndicate has been formed under the name of the Union des Diamantaires et Bijoutiers, Mr. Grosfilleix acting as president. The membership has already reached 200.

Leo Weill & Frere is the name of a new firm on the Rue de la Paix, which succeeds the old Philip business. The capital is 200,000 francs.

## Boston.

W. H. Weisman has bought the jewelry business of L. C. Sargent & Son, Clinton, Mass.

V. Holy has moved his repairing institute from room 65, Jewelers' building, to 49 Bromfield St., where he will engage in the retail jewelry business as well.

The American Waltham Watch Co. has begun work on the extension to its factory, which will parallel the river and will be 94 by 28 feet. It will be constructed of brick and steel.

Rev. F. L. Hopkins is president and E. S. Walsh is clerk of a corporation, with a capital of \$10,000, which will manufacture combs, hair pins, and hat pins in Baldwinville, Mass.

The Business Men's Association of Waltham, Mass., directed the fourth annual merchants' week in that city last week. The American Waltham Watch Co. Band gave concerts on several evenings.

The Shreve, Crump & Low Co., through Treasurer William P. Shreve, filed, last week, its annual corporation report. The figures show: Machinery, \$5,000; merchandise, \$525,000; cash and debts receivable, \$187,021; capital stock, \$375,000; accounts payable, \$80,552; surplus, \$261,469.

The following jewelers were in Boston during the week: George T. Springer, Portland, Me.; Mr. Chapin, of Bruce & Chapin, Worcester; A. P. Zundborg, Worcester; Mr. Herbert, of the Dean-Herbert Co., Manchester, N. H.; Frank Ricard, Lowell; John Webb, of Alden Webb, Beverly; Mr. Kendrick, of Kendrick & Davis, Lebanon, N. H.; U. C. Smith, Brockton; W. H. Weisman, Clinton; E. F. Welch, Westboro; Frank P. Moore, Stonington, Me.; C. W. Clough, Pawtucket, R. I.; E. C. Chagnon, Woonsocket, R. I.

The Massachusetts Retail Jewelers' Association held a meeting in the American House in Boston, on May 10. There were 26 members present, including W. E. Van Wert and Walter B. Snow, of Boston; U. Charles Smith and Herman S. Hewett, of Brockton; Fred C. Newhall, of Lynn; R. C. Gow, of Cambridge; Charles P. Forbes, of Greenfield, and E. H. Dunbar, of Norwood. Fred C. Newhall, president of the association, presided. The meeting was principally devoted to organizing. J. L. Shepherd, of Philadelphia, was present as a guest of honor. The association will meet on the third Thursday of each month. The officers are as follows: President, Fred C. Newhall, of Lynn; vice-president, Charles P. Forbes, of Greenfield; secretary and treasurer, E. H. Dunbar, of Norwood. Advisory board—Walter B. Snow, of Boston, and R. C. Gow, of Cambridge.

Aid Bros., Gallatin, Mo., have been succeeded by F. P. Wynne.

Hans E. Foss, Brooten, Minn., has been succeeded by John Stalker.

H. Piesinger, Montgomery, Minn., has gone to Le Seuer Center, in the same State.

## Philadelphia.

Harry Toplis has opened a shop for watch repairing for the trade at 125 S. 7th St.

I. M. Garfinkel & Co. were made defendants, last week, in a suit instituted against them by Stiffel & Freeman, safe manufacturers, to replevin a safe.

The Bailey, Banks & Biddle Co. has already started work on the silver service for the battleship *Virginia*, the contract for which was only recently awarded the firm.

Charles Beerhalter, 719 Sansom St., has leased a retail store on 5th St., below Lehigh Ave., which he will open shortly. Mr. Beerhalter is now a watchmaker for the trade.

The rare coins collected by the late Harlan Smith, New York, were disposed of in this city, last week, at auction, and brought \$23,000, a figure breaking all records for such sales.

A. L. Smyth, 1711 South St., has leased a store at 5123 Baltimore Ave., to which he will remove about June 15, when extensive alterations and improvements will have been completed.

Sol Sickles, of M. Sickles & Sons, who departed recently on an extended pleasure trip through the west, has reached Arizona, according to dispatches received from him in this city.

J. Albert Caldwell, senior member of the firm J. E. Caldwell & Co., sailed, last week, on the American liner *Philadelphia* for Europe on his annual trip, combining business with pleasure.

J. Warner Hutchins, Charles Diesinger and William G. Blair were guests, Saturday, in New York of Charles L. Power, of Charles L. Power & Co., diamond importers, at the wedding of Mr. Power's daughter, and later at a reception held in the new Hotel Astor.

Charles Chamberlain, for years in business in Ambler, Pa., has abandoned his retail store in that suburb and will engage in the contracting and building business. Mr. Chamberlain's abandonment of the jewelry business in Ambler leaves that town without a watchmaker or jeweler.

James G. Maree, formerly one of the best known jewelers of this city, but for some years retired, celebrated his 55th wedding anniversary last week at his home, 424 W. Cheltenham Ave., Germantown. A dinner and musicale in honor of the event was given by his son-in-law, William L. Nassan.

The widow of Josiah C. Siddons, who 25 years ago was a silversmith in this city, died last week at her home, 3240 N. Broad St., at the age of 90 years. She was well known because of her activity during the Civil War in caring for Union soldiers who reached this city on their way to or from the war.

I. M. Garfinkel & Co., 1217 Market St., recently offered creditors, who met at the company's request, a composition of 20 per cent. on all claims. It is proposed to pay 10 per cent. June 10, 5 per cent. July 10 and 5 per cent. Aug. 10. The liabilities of the firm are estimated at \$25,000, and the assets are estimated at \$9,000.

Out of town retailers here during the week included: G. A. Jacot, South Bethlehem, Pa.; Frank Tyack, Reading, Pa.; E. L. Thomas, Phoenixville, Pa.; H. L. Phil-

lips, Smyrna, Del.; J. L. Johnston, Norristown, Pa.; L. C. Reisner, Lancaster, Pa.; David Krause, North Wales, Pa.; C. M. Banks, Wilmington, Del., and Valentine A. Hirst, Altoona, Pa.

Some especially valuable pieces of historic jewelry, plate and ceramics were disposed of by the will of the late Edward Shippen Willing, which was admitted to probate here last week. The pieces are heirlooms, many of them having belonged originally to such families as King Louis Philippe, Ellen Willing du Cuelbrock, Lord Cornwallis, General Washington's secretary, etc. Mrs. John Jacob Astor, of New York, his daughter, receives most of the costly heirlooms of jewelry.

Mrs. Kate Hassler, one of the most picturesque retail jewelers of the city, who for more than half a century has conducted a store at 3416 Market St., was robbed again last week. This time a colored man made off with two gold filled watches only, while her watchmaker, Berthold Thiele, aged 70 years, was in the rear of the store. Two years ago Mrs. Hassler was bound and gagged in her store by thieves and the entire place was looted. As in the first case, there is no clue to the thieves.

### Optical Notes and Briefs.

Mr. Wilson, of the Wilson Drug Co., Atkinson, Nebr., has made application for membership in the Nebraska State Optical Society.

Miss E. S. E. Waltz has been placed in charge of the optical department of the J. N. Adam Co.'s store, at 388 Main St., Buffalo, N. Y.

A. T. Gray, member of the Failing Optical Co., 455 Main St., Buffalo, N. Y., is remodeling his beautiful residence, 163 Loring Ave.

H. J. Penfold, of the H. J. Penfold Co., Omaha, Nebr., has gone to Toledo and Chicago on business for the local organization, "Ak-Sar-Ben."

The C. P. Goerz Optical Works have opened temporary offices at 1107 Turk St., San Francisco, Cal. L. J. R. Holtz, of this house, recently arrived from New York with a new stock of lenses and cameras.

Henry Kahn & Co., formerly in the optical business at 642 Market St., San Francisco, Cal., have joined with a number of leading retailers in other lines and selected quarters for temporary use on Van Ness Ave.

The Buffalo, N. Y., Optical Society has issued elegantly embossed membership certificates to the following: E. V. Syrcer, Buffalo; W. Gale, North Collins; C. F. Cushing, Niagara Falls; J. P. Simcox, Buffalo; C. H. Gros, Cuba; L. W. Aldridge, Floy L. Akin, Buffalo.

J. W. Jarvis, optician, 461 Main St., Buffalo, N. Y., returned from a week's visit in New York Sunday. He attended the Grand Lodge of Masons and visited members of the optical trade in the Metropolis. Mr. Jarvis recently increased his shop force in his Buffalo establishment.

The Bacon Optical Co., 411 Essex St., Lawrence, Mass., has sold out to Mathew J. Fowler and Albert E. Nye, who will continue the business. Mr. Fowler was for nine years with the Fox Optical Co., Buffalo, N. Y., and Mr. Nye spent six years

with N. C. Rublee & Co., Fitchburg, Mass.

B. B. Combs, Omaha, Nebr., treasurer Nebraska State Optical Society, reports the officers of the society are preparing a bill governing the practice of optometry for the next Legislature. The bill, it is claimed, is intended to prevent the passage of the medical bill.

Besides those already mentioned the following San Francisco opticians have opened temporary offices as follows: Chinn-Beretta Optical Co., 466 13th St., Oakland, Cal.; California Optical Co., 2109 Fillmore St., San Francisco; Geo. H. Kahn, 2026 Steiner St., San Francisco, and the Bausch & Lomb Optical Co., 1629 Geary St., San Francisco.

Hereafter the Buffalo Optical Society's monthly meetings will be held at the Lafayette Hotel, Buffalo, N. Y., except on special occasions, as next month, when the members will be the guests of C. F. Cushing at Niagara Falls. At the last meeting R. M. Lockwood, editor of the *Optical Journal*, New York, addressed the society on the general outlook in the trade. Dr. Cook also spoke on "Some Diseases Opticians Should Recognize."

Dr. Horace B. Hyde was arraigned in the police court in Rochester, N. Y., May 8, charged with practicing medicine without a license, inasmuch as he prescribed for an eye trouble for Frank Rabshaw. The alleged offense took place, Dec. 31, 1905. The defendant pleaded not guilty, and the case was adjourned until to-day, May 16. The defendant claimed in his defense that he had not practiced medicine, but had sold and fitted eyeglasses.

The fifth annual meeting of the Virginia State Optical Association was held Wednesday, at Murphy's Hotel, Richmond, Va. Two sessions were held, one at 2.30 p. m. and the other at 8.30 p. m. The officers elected for the ensuing year were: President, V. B. Gilbert, Richmond; vice-president, W. T. Blanton, Farmville; secretary, W. Wayt Royall, Martinsville; treasurer, F. S. Bullington, Richmond; Executive Committee—Dr. A. Weck, chairman, Norfolk; W. E. Hull and J. Harris Hales, Newport News; H. L. Lang, Staunton, and L. W. Clark, Radford.

The 12th annual meeting and third convention of the New England Association of Opticians opened last night at the American House, Boston, Mass., and will continue to-day and this evening. An exceptionally interesting programme has been provided and the members believe that the meeting will be one of the most successful in the history of the association. The members registered yesterday morning from 9 to 12 in the exhibition hall on the ground floor of the hotel, where several optical and electrical instruments are exhibited. Among those who are on the programme to address the meeting are: A. Martin, "The Modus Operandi in Eye Sight Testing"; R. Conger, of the Sheldon School of Scientific Salesmanship, "Scientific Salesmanship"; Dr. A. C. Campbell, Topeka, Kans., "The Health Ray Lens"; F. P. Simons, "Is the Time Ripe for a Recognized College of Optometry, and Where Should It Be Established"; Briggs S. Palmer, "Systematizing an Optical Business." A full report of the meeting will be published in next week's issue of THE CIRCULAR—WEEKLY.



## Canada Notes.

H. Gauvreau has bought the business of S. Laporte, Ottawa.

McNichol & Pettrick, Stratford, Ont., are closing up their business.

Henderson & White recently opened a store at Lion's Head, Ont.

Judgment has been obtained against W. J. Allen & Co., Glace Bay, N. S., for \$745.

W. J. Wray & Co. have bought out the Western Jewelry & Novelty Co., London, Ont.

W. Bramley, Montreal, has enlarged his factory and is about to remodel and enlarge his offices.

T. Coffin, Jr., of the Montreal Optical Co., has been touring Ontario in the interest of his concern.

Ewert Bros., Rossland and Nelson, B. C., have dissolved, each partner taking one of the branches.

J. H. Young, recently manager for W. E. Jones, Brantford, Ont., succeeds the latter in the business.

The Smith, Patterson Co. has moved from St. James St. to new premises on St. Antoine St., Montreal.

Ezra C. Fitch, manager of the American Waltham Watch Co., Montreal, was in Toronto, Ont., last week.

A. F. Low, Vancouver, B. C., has sold out to L. A. Doll. He has given Mr. Doll an absolute bill of sale for \$1,000.

W. T. A. Proctor, Toronto, Ont., representative of the Montreal Watch Case Co., left last week on a trip to Europe.

Edgar Arnold, Kentville, N. S., has moved his store to Webster St. and has had the interior attractively fitted up.

M. Coehenthaler has removed from his downtown store and opened a new store at 448 St. Catherine St. W., Montreal.

The stock of P. B. Crews, Kingston, Ont., has been taken possession of under a chattel mortgage. The store is not closed.

Walter J. Barr, manager of the Goldsmiths' Stock Co., Toronto, Ont., has gone to New York on a purchasing trip and will stop at the Manhattan.

Geo. G. Robinson & Co., one of the oldest jewelry firms in Montreal, have retired from business. The stock has been sold by auction.

J. H. Willmott, late traveling representative of the Gorham Mfg. Co., Montreal, has accepted a similar position with Roden Bros., Toronto, Ont.

John Rounds & Son are refitting their premises in the Coristine building, Montreal. This is a branch of the sterling silver works of Sheffield, Eng.

The manufacturing firm of Eaves Bros., Montreal, has removed from St. George St. to Bleury St., the removal having been found necessary owing to increasing business.

Thomas C. Johnson, Halifax, N. S., is having a handsome brick and stone jewelry store built at Truro, N. S., which will be managed by his son, George Johnson, who has been doing business at Truro for several years.

For the second time recently, the jewelry store of Joseph Pony, St. Catherine St., Montreal, has been broken into and a quantity of jewelry stolen. The last time, Mr. Pony, who lives over the store, heard the

noise downstairs and descended, armed with his revolver. The thieves escaped.

A report has been made to Mr. McCaskill, chief of the Quebec provincial police, that several men have been selling valuable jewelry at Joliette, Que., during the past week. The circumstances have given rise to the suspicion that the jewelry is the proceeds of burglaries that have taken place in Montreal, and the authorities are making an investigation.

James L. McDougall, 39 years of age, is charged with having obtained money by false pretenses from D. Spenard, St. Catherine St., Montreal. McDougall bought some goods, for which he tendered a check, stating that it was not to be cashed until the end of the week. He also obtained some cash, the difference between the figures on the check and the price of the goods. McDougall spent the Winter in jail for shoplifting and is well known to the police.

The premises of the Goldsmiths' Stock Co., on the northwest corner of Yonge and Wellington Sts., Toronto, Ont., have been completely remodeled and greatly extended, the alterations being just completed. The change gives the concern 15,000 feet of floor space and doubles the office accommodation. The main entrance hall, with fittings in quartered oak, is very attractive. The company is henceforth confining itself strictly to the wholesale branch of the trade.

Isaac L. Michalson has registered as the president of I. L. Michalson & Sons, Montreal, diamond merchants and makers of rings. The other members of the company are Harris Michalson, vice-president; Robert Goltman, secretary-treasurer, and I. Michalson, director. The business was established in 1885, and I. S. Goldenstein and Moses Michalson were afterward admitted as partners. These have since retired to set up in business as jobbers in Montreal on their own account.

J. Cornelius, who, for over a quarter of a century, had his jewelry store at Granville St., Halifax, N. S., has just moved to Hollis St. The change was made necessary owing to the Bank of Commerce purchasing the premises in which his stock had been located and which is being torn down to make way for a handsome bank building. Mr. Cornelius' new store has been splendidly fitted up and is one of the principal business thoroughfares of the city.

Walter C. Rix, optician, Ilion, N. Y., has been elected President of that village.

M. E. Wold, Thief River Falls, Minn., has closed his store for the Summer.

The Opticians' Club of Columbus was formally organized at a meeting at the Chittenden Hotel, Columbus, O., last week. It is composed of both dealers and employees. A committee was appointed to secure rooms, where a library will be established and monthly lectures held. The officers are: F. W. Wallis, president; R. E. Cole, vice-president; W. G. Bancroft, treasurer; J. R. Crawford, secretary. Executive committee—J. B. White, chairman; L. W. Lewis, N. E. Harris, Frank McGuire and H. E. White. After the meeting a banquet was enjoyed, the members being the guests of the White-Haines Optical Co.

## New Orleans, La.

A. Godbold, well known in the local trade, contemplates engaging in business in one of the smaller towns of the State.

Theodore Vorhaben, of Theo. J. Vorhaben & Bro., 809 Baronne St., is contemplating a short trip to the country.

Gabe Hausmann, of T. Hausmann & Sons, was a leading spirit in the recent burlesque circus given by the local lodge of Elks.

J. Julius Weinfurter, as chairman of the City Park Committee, arranged a splendid programme for the opening of the pleasure ground last Sunday. In the big street pageant, given in the forenoon, Mr. Weinfurter rode in front as grand marshal.

The sale still continues at A. M. Hill's old establishment, 635 Canal St., and goods are knocked down under the auctioneer's mallet every morning and afternoon. When the sale is completed and the judgment satisfied, Mr. Hill will replenish his stock and continue his business as formerly.

Now that the battleship *Louisiana* has been completed and will be turned over to the Government shortly, the committees having in charge the taking up of subscriptions to purchase the vessel a fine silver service have gone to work with new energy. Several meetings have been called to take place at one of the leading hotels, and a big entertainment is planned to add to the funds already collected. The committees want \$2,500, but at the present time they are far short of that amount. The fund for the silver service to be given the battleship *Mississippi* by the people of Mississippi has just passed the \$1,000 mark.

## Minneapolis and St. Paul.

The Boasberg Optical Co., 13 S. 7th St., Minneapolis, has been succeeded by Mr. Kobe.

John S. Allen, Minneapolis, has been in Fergus Falls, Minn., serving as a member of the Federal jury.

A. U. Wetsel, Minneapolis, is about to move from 409 Nicollet Ave. to new quarters on S. 7th St., between Nicollet and First Aves., South.

A. F. Pommerleau, of Munns & Pommerleau, was a juror in the Bechtel case, in which was involved a scandal in a Minneapolis life insurance concern.

The R. G. Winter Jewelry Co., Minneapolis, now located at 327 Nicollet Ave., has secured the lease at 608 Nicollet Ave., and will move to the new location about Sept. 1.

The jewelers of the Twin Cities are making use of the new curb lamps in goodly numbers. In Minneapolis recent additions to the list include: W. M. Stone, Edward Olson, A. Schultz, C. M. Erickson, White & MacNaught, Cohen Watch & Jewelry Co., S. Gittelson and others. In St. Paul the gas company is circulating petitions for the work, and it is carried through by blocks, so that all stores are equally favored if the line of curb lights is decided upon.

Oscar Anderson, Velva, N. Dak., was injured in the recent wreck at Clover Creek Junction, Pa. Mr. Anderson was on his way to Berlin, Ger., where he expects to make his home.

## News Gleanings.

C. E. Barker & Co., Colorado Springs, Colo., have sold out to W. S. Mitchell.

Willard Levee, Little Falls, N. Y., has made extensive improvements in his store. Edw. M. Timpane, Troy, N. Y., recently had a new plate glass front put in his store.

Vanderbilt & Donnelly will open their new store in Amsterdam, N. Y., on or about June 1.

The stock of the Elite Jewelry Co., Mapleton, Ia., was entirely destroyed by fire, recently.

Elmer L. Gard, Barberton, O., has disposed of his business interests at that place to Schwauer Bros.

S. E. Leshner, Bucyrus, O., has admitted Mr. Dunlap as partner. The firm name is now Leshner & Dunlap.

Several itinerant vendors of bogus jewelry were recently ordered to leave the town of McKeesport, Pa.

O. M. Roseboom, Frankfort, O., has added a millinery department, which he will conduct in connection with his jewelry business.

W. W. Wells, Lodi, O., has moved into his handsome new store in the First National Bank building.

T. Coffman has bought out J. A. Robinson, Toronto, Kans., and will continue the business at that place.

H. W. Clowe, Jr., Winchester, Va., has just leased new quarters in the new Williams building, at that place.

Harry A. Dillon, Gloversville, N. Y., recently returned from one of his periodical fishing trips in the Adirondacks.

J. C. Mitchell, formerly with L. S. Robinson, Glenwood, Ia., has purchased the store of Harry J. Engels, Red Cloud, Nebr.

E. H. Treiber, Scotland, S. Dak., will soon move into new and larger quarters. He will add china ware and cut glass to his stock.

Chas. H. Paris is now fully settled in his new store on River St., Troy, N. Y. He has added a number of new fixtures to his store equipment.

Wright & Co., Coshocton, O., have moved into the Hotel building and have enlarged their business, having added a musical instrument department.

Chas. A. Hagadorn has discontinued his store at Canajoharie, N. Y., and moved his stock to his residence, where he will also include the sale of pianos.

John L. Hastings, Mohawk, N. Y., has sold his business to Oscar E. Day and removed to Sheridan, Ind., where he will continue in the retail jewelry business.

V. E. Jacobs & Co., Jacksonville, Fla., formally opened their newly furnished store at 135 W. Bay St., on Wednesday. Patrons were given souvenirs and regaled with music.

A fire which recently broke out in the building occupied by the jewelry store of W. R. Bell, Murfreesboro, Tenn., wrought considerable damage. The loss is partially covered by insurance.

A. Hermann, optician, Watertown, N. Y., has brought suit for \$10,000 damages for alleged slander against Willard D. Nellis, of the same place. Nellis denies the accusations of the optician.

Harold A. Neece, Williamsport, Pa., recently received as a gift from a relative in

New York a violin which has been in the family for 200 years. The instrument is believed to be a genuine Stradivarius.

E. H. Wetherhold, Allentown, Pa., has just awarded the contract for the erection of an addition to his store at 723 Hamilton St. The new structure will be of brick, two stories high and will measure 13 by 23 feet.

Benjamin Mayer, Atlantic City, N. J., has leased the store at 1616 Atlantic Ave., and moved his stock to that location. He was formerly at 1612 Atlantic Ave. for a number of years. The new premises have been remodeled.

M. Jaffe has sold his interest, in the Jaffe Jewelry & Loan Co., 2009 Second Ave., Birmingham, Ala., to Julius Jaffe, who is now the sole owner. The business will be continued under the same name and at the same place by the new owner, who assumes all indebtedness of the firm.

The partnership of Blakeslee & Lord, Goldfield, Nev., has been dissolved by mutual consent, Walter A. Lord having bought out the interest of George T. Blakeslee. Mr. Lord continues the business and assumes all the liabilities and assets in Goldfield. Mr. Blakeslee is in business at Tonopah, Nev.

W. W. Mitchell, a retail jeweler of Dallas, Tex., recently reported to the Police Department that 16 watches, a diamond ring and several other articles of jewelry had mysteriously disappeared from his establishment. Their disappearance was discovered about two hours after the store had been closed.

A movement recently begun by the jewelry clerks in Richmond, Va., to have their employers close their establishments at 6 o'clock every evening has resulted unsuccessfully, owing to the refusal of one Broad St. jeweler to comply with the wishes of the rest. At present the stores are kept open until seven o'clock.

Charles A. Regnaudin, an aged and well-known resident of Akron, O., who died at his home, 266 E. South St., recently, was for many years a jeweler and was a resident of Akron for the past 38 years. The deceased was 79 years old and was prominent in fraternal circles. He was a Mason and a member of the Summit Lodge No. 50 I. O. O. F. A widow and several children survive. The funeral services were held from his late home, and the interment was in Glendale.

H. M. Niswanner was taken into custody May 7 in Greensboro, N. C., on a charge of being implicated in the robbery of a jewelry store in Baltimore, Md., Nov. 15, 1905. When searched, several watches and chains were found in the possession of the prisoner, and a large amount of jewelry was also found in the man's apartments at 242 E. Washington St. Niswanner declared that the stock belonged to J. B. Ellington, and had been entrusted to him for sale. He denied all knowledge of the Baltimore robbery and, in the absence of any incriminating evidence, was released.

For assaulting J. A. Strachan, a jeweler at 220 Whitehall St., Atlanta, Ga., J. Robinson, a negro, was recently fined \$25 and costs and bound over to the Superior Court. The jeweler went to Robinson's house in search of a customer who was his debtor and, it was alleged, was kicked by the negro.

## New Stores and Enterprises.

Gordon Hanson has begun business in Oldham, S. Dak.

John E. Campbell has opened a store in Highmore, S. Dak.

Corinne Rousiel has registered as A. LeMontre, Montreal, Can.

Homer Sharp has started in business on his own account in Dundee, N. Y.

Joseph Fussman last week opened a repairing shop in Moorestown, N. J.

J. L. Sabbath & Co. is the name of a new firm of wholesale jewelers, in Montreal, Can.

Anthony Joseph recently opened a store on Gerrish St., in the Davison block, Windsor, N. S.

J. R. Kile recently opened a watch and jewelry repairing establishment at Cunningham, Kans.

On Monday of last week Frank Sutherland opened his new store at 122 Broadway, Buffalo, N. Y.

Julius Harwitz is a new jeweler in St. Louis, Mo., where he has opened a store at 1423 Pendleton Ave.

Daniel Arthur Ungaro, general engraver, formerly with Strawbridge & Clothier, Philadelphia, Pa., has opened a shop of his own at 717 Sansom St.

G. T. Sewall, who has been in attendance at the Kansas City Horological School, Kansas City, Mo., will open a large store at Iola, Kans., this month.

Edward J. Geibel, watchmaker, formerly with E. P. Percival, 221 N. 8th St., Philadelphia, Pa., has opened a repairing shop for the trade at 1439 N. 10th St., in that city.

W. L. Calkins, formerly in charge of the optical department of Estberg & Sons, Waukesha, Wis., recently began business on his own account at 509 Grand Ave., at the same place.

W. R. McFadden has engaged in the jewelry business on his own account at 407 Summit St., Toledo, O. Mr. McFadden was formerly in the employ of W. H. Broer, of the same place.

The City Jewelry Store, Pelham, Ga., has just been incorporated, with a capital stock of \$2,000. The incorporators were C. L. Taylor, John C. Wilson, F. S. Perry, J. B. Lewis and E. E. Cox.

A certificate of incorporation was filed, recently, by Nathan Dardik, of New York, who will engage in business in Watertown, N. Y., under the name of the Northern New York Optical Co.

The Equity Watch Co. is another new concern which was incorporated in New York, May 13, with a capital stock of \$25,000. The directors are Jacob Katz and B. Luria, New York, and E. Pearsall, Brooklyn.

The Consolidated Optical Mfg. Co. is a new concern which was recently incorporated in New York, with a capital of \$10,000 to deal in optical goods. The incorporators were: Abraham L. Fried and K. P. Fried, of New York, and R. Van Buskirk, Bayonne, N. J.

An engraving school has been opened in the rear of the jewelry store of I. H. McConkey, Johnstown, N. Y., under the name of the National Engraving School. The school has a large number of students, both male and female, and conducts both day and evening sessions.

INDEX TO ADVERTISEMENTS.

Adams & Singleton .....	92	Forstinger, J. W. ....	86	Novelty Engineering Ass'n .....	100
Alklu, Lambert & Co. ....	106	Foster, Theodore W., & Bro. Co. ....	32	Ohan, G. ....	92
Allsopp & Allsopp .....	26	Four-Track News .....	94	Omega Watches .....	91
Allsopp Bros. ....	22	Fox, Gustave, Co. ....	19	Oppenheimer Bros. & Velth. ....	36
Alsterlund, H. E., & Co. ....	106	Freund, Henry, & Bro. ....	21	Oppenheimer, H. E., & Co. ....	36
Alvin Mfg. Co. ....	Inside front cover	Friedlander, R. L. & M. ....	Outside back cover	Oriental Bank .....	58
American Gem & Pearl Co. ....	60	Garraud & Griser .....	74	Osmun-Parker Mfg. Co. ....	24
American Platinum Works .....	108	Gesswein, F. W., Co. ....	100	Ostby & Bartou Co. ....	21
American Waltham Watch Co. ....	80	Goldsmith, C. P., & Co. ....	22	Parks, G. W., Co. ....	20
Arch Crown Mfg. Co. ....	56	Goldsmith, Leo .....	46	Patek, Philippe & Co. ....	90
Arnstein Bros. & Co. ....	Outside back cover	Goodfriend Bros. ....	42	Penfold, Wm. C., Co. ....	86
Art Stamping & Mfg. Co. ....	104	Gorham Mfg. Co. ....	54	Pomfret-Goldy School .....	100
Austin, John, & Son. ....	Outside back cover	Griffoul, August .....	107	Potter & Buffinton Co. ....	17
Aztec Turquoise Co. ....	40	Guardian Trust Co. ....	58	Power, Chas. L., & Co. ....	42
Bagg, Perlne & Co. ....	44	Hagstoz, T. B., Ltd. ....	108	Powers & Mayer .....	15
Baker, Geo. M. ....	Outside back cover	Harris & Harrington. ....	Outside back cover	Prior, Charles M. ....	92
Ball, Webb C., Watch Co. ....	64	Hedges, A. J., & Co. ....	24	Prybill, P. ....	107
Bard, A. C., & Co. ....	68	Hedges, Wm. S., & Co. ....	42	Racine, Jules .....	92
Baschkopf, Jacob .....	94	Helntz Bros. ....	106	Reichenhelm, E. P., & Co. ....	100
Bass, E. & J. ....	17	Heller, L., & Son. ....	38	Reis, G., & Bro. ....	68
Bassett Jewelry Co. ....	31	Hershberg, A. S. ....	40	Renzichausen, W. F., Co. ....	108
Bastlan Bros. ....	19	Hodenpyl & Walker .....	38	Revell, A. H., & Co. ....	Outside back cover
Bates & Bacon .....	18	Holtzer Cabot Electric Co. ....	107	Ries & Armstrong .....	100
Benlmar, H., & Co. ....	102	Hotel St. James .....	106	Riviere Brass & Bronze Works. ....	102
Berge, J. & H. ....	107	Howard, E., Clock Co. ....	92	Rockford Watch Co. ....	92
Bigalke & Eckhart Co. ....	62	Hraba, Louis W. ....	102	Roger Whitams Silver Co. ....	30
Bigney, S. O., & Co. ....	4	Humphrey, John B. ....	40	Roseman, A. ....	46
Billings, Chester, & Son. ....	40	Hutchison & Huestis .....	30	Roy Watch Case Co. ....	88
Bishop, R. W. ....	107	Illinois Watch Co. ....	13	Rudolph & Snedeker .....	90
Blackinton, R., & Co. ....	52	Jacot Music Box Co. ....	102	Rumpp, C. F., & Sons. ....	104
Blackinton, W. & S., Co. ....	48	Jeandheur, F., Jr. ....	108	Saart, W. H., Co. ....	31
Blancard & Co. ....	104	Jeanne, Frederick A. ....	44	Sadler, F. H., Co. ....	16
Boote, Edward .....	102	Jewelers' Cir. Pub. Co. ....	Inside back cover	Saunders, Meurer & Co. ....	42
Borrelli & Vitelli .....	42	Johnston, W. J., Co. ....	10, 11	Schiff, M. ....	24
Boston Jewelry Co. ....	106	Juergens & Andersen Co. ....	64	Schultz, Leiss & Co. ....	23
Bowden, J. B., & Co. ....	22	Juergensen, Jules .....	90	Seofield & DeWynngaert .....	29
Bowler & Burdick Co. ....	68	Kahn, L. & M., & Co. ....	Outside back cover	Sessions Clock Co. ....	86
Bradley Polytechnic Institute .....	108	Keck, Herman, Mfg. Co. ....	64	Shlman Bros., & Co. ....	66
Brower, Maurice .....	46	Kent & Woodland .....	26	Simmons, R. F., Co. ....	8
Bruhl Bros. & Henius Co. ....	Outside back cover	Ketcham & McDougall .....	94	Smith, Alfred H., & Co. ....	36
Buckley, Sam'l., & Co. ....	26	Keystone Watch Case Co. ....	85	Smith, E. H. H., Silver Co. ....	104
Bunde & Upmeyer .....	48	Kilpper Bros. ....	74	Smith, Wm., & Co. ....	28
Cahoone, C. H., & Co. ....	74	Kohlbusch, Herman, Sr. ....	29	Snow & Westcott .....	28
Carrington & Co. ....	24	Kohn, Alols, & Co. ....	24	Sohn & Hyman .....	46
Carter, Howe & Co. ....	25	Koshland & Italie Co. ....	92	Solidarity Watch Case Co. ....	42
Chatham National Bank .....	58	Kremenz & Co. ....	27	Spencer, E. L., Co. ....	31
Chopard Frères .....	50	Kronheimer & Oldenbusch Co. ....	23	State Bank .....	58
Conley & Straight .....	108	Langendorf Watch Co. ....	90	Steiner, Louis .....	20
Cooper Diamond Co. ....	40	Larter & Sons .....	34	Stern Bros. & Co. ....	12, 46
Cooper & Forman .....	60	Lelong, L., & Bro. ....	Outside back cover	Sternau, S., & Co. ....	16
Cottle, S., Co. ....	28	Levy, Robt. ....	62	Stiven, John S. ....	104
Crohn, M. ....	28	Lewy & Cohen .....	74	Strauss, Ignaz, & Co. ....	Outside back cover
Cross & Beguelin .....	29, 56	Lissauer & Co. ....	38	Strauss, Jacob, & Sons .....	46
Crossman Co. ....	44	Loeb, Wm., & Co. ....	60	Street, Geo. O., & Sons. ....	25
Crouch & Fitzgerald .....	107	Lorsch, Albert, & Co. ....	Outside back cover	Sturdy's, J. F., Sons .....	14
Dattelbaum & Friedman .....	104	Loth, Joseph, & Co. ....	74	Tavannes Watch Co. ....	50
Day, Clark & Co. ....	25	Low, Martin, & Taussig .....	58	Thomas, Seth, Clock Co. ....	88
Dederick's Sons, James II. ....	108	Lowe, Edwin, & Co., Inc. ....	74	Trenton Watch Co. ....	88
Depasse Mfg. Co. ....	48	Luthy & Hine .....	28	Trout, Charles L., & Co. ....	26
De Selms Watch School .....	100	Lyons Gem Co. ....	40	U. S. Electro-Chemical Co. ....	100
Diamond Point Pen Co. ....	106	Mackey Jewelry Co. ....	28	Wadsworth Watch Case Co. ....	6, 7
Didisheim, Hipp., & Bro. ....	90	Maebert & Reiss .....	74	Wagner Mfg. Co. ....	29
Donnelly, J. J. ....	108	Maple City Glass Co. ....	102	Waite-Thresher Co. ....	31
Dorfinger, C., & Sons. ....	102	Market & Fulton National Bank. ....	58	Washburn, C. Irving .....	60
Dulk, Robert .....	26	Mercantile National Bank .....	59	Wells, Chester H. ....	22
Dunbar, Leach, Garner Co. ....	108	Meyerowitz Bros. ....	38	Wendell & Co. ....	5
Dunn, Thomas J., & Co. ....	27	Miller, L. A. ....	60	Western Clock Mfg. Co. ....	68
Durand & Co. ....	24	Miller, Fuller & Whiting .....	30	Wheeler, Hayden W., & Co. ....	36
Eichberg & Co. ....	46	Moore & Sons .....	23	White, Wm. A., & Sons. ....	73
Elgin National Watch Co. ....	82	Mount & Woodhull .....	44	Whiteside & Blank .....	25
Eliassof Bros. & Co. ....	48	Mueller Lapidary Co. ....	40	Whiting & Davis .....	18
Ellis & Co. ....	94	Murray, Dan I. ....	50	Whiting, Frank M., & Co. ....	29
E. P. H. Chain Catch. ....	106	Myers, S. F., Co. ....	40	Whiting Mfg. Co. ....	9
Eye-Fix Remedy Co. ....	94	Newark Cut Glass Co. ....	102	Wightman & Hough Co. ....	30
Faays, Joseph, & Co. ....	1	Newburgh, R. ....	90	Witsenhausen, L. ....	22
Fairchild & Co. ....	104	New York Standard Watch Co. ....	84	Wodiska, Julius .....	26
Favre-Jacot, Georges, & Co. ....	91	Noel, Rudolph, & Co. ....	64	Wolfsheim & Sachs .....	108
Feeley, W. J., Co. ....	28	Nonnenmann, A., & J. Aschenbrenner. ....	102	Wood, C. F., & Co. ....	Outside back cover
Forman Co. ....	108	Noterman, Jos., & Co. ....	68	Wood, J. R., & Sons .....	2, 3

## Special Notices.

Payable invariably in advance.

Rates 75c. per insertion for notices not exceeding 25 words; additional words, 2c. each.

SITUATIONS WANTED, 1c. a word each insertion; minimum charge, 25c.

Heavy type, 5c. a word; minimum charge, \$1.25. Display cards, \$2.00 per inch.

In all cases, if answers are to be forwarded, 10c. extra to cover postage must be enclosed.

*All answers to advertisements addressed care The Jewelers' Circular-Weekly, should be sent to the New York Office, unless the Chicago Office is specifically mentioned.*

## Situations Wanted.

YOUNG MAN (23) wishes position on the road or in wholesale house; reference furnished. "O., 6310," care Jewelers' Circular-Weekly.

YOUNG MAN (22) wishes position as salesman or to work inside in wholesale house. "Wholesale, 6263," care Jewelers' Circular-Weekly.

YOUNG MAN (22) wishes position as salesman or to work inside in wholesale house. Address "L., 6297," care Jewelers' Circular-Weekly.

ENGRAVER, experienced in engraving and setting of bracelets, wishes steady position. Address "W., 6271," care Jewelers' Circular-Weekly.

FIRST CLASS WATCHMAKER, 14 years' experience, desires position; best references. Address "D., 6303," care Jewelers' Circular-Weekly.

ENGRAVER will do engraving free in exchange for board in the country; address giving and receiving full particulars. Walter Hohl, 407 E. 122d St., New York.

YOUNG MAN wants to help out in jewelry store; selling, Saturdays 1 to 10 P. M.; 14 years' experience; references. "Salesman, 6301," care Jewelers' Circular-Weekly.

BY A FIRST CLASS watchmaker; German; five years in country; 15 years' experience; age 29; have tools; my specialty is watch work. Geo. Brandt, Trinidad, Colo.

WATCHMAKER desires position, with high class jewelers; accustomed to waiting on trade; first class references; no engraving. "W.," 129 Washington St., Newark, N. J.

SALESMAN, five years' experience, selling department and jewelry stores in middle west, is open for a similar position. "A. B. R., 6312," care Jewelers' Circular-Weekly.

FIRST CLASS WATCHMAKER, with nine years' experience on fine watches; good references; salary not less than \$20 a week. Address R. T. Drumtra, Altenburg, Mo.

WANTED, A POSITION as engraver, hook-keeper, cashier and saleslady; good references; terms reasonable. Address "Enquirer, 5877," care Jewelers' Circular-Weekly.

SITUATION WANTED by watchmaker and jeweler; A1 salesman; understands optics; full set of tools; best references. Address R. S. Goodhart, 451 Douglass St., Reading, Pa.

POSITION as inside salesman; nine years' experience; will prove myself a hustler; first class references; age 27 years. Address "Faithful, 6292," care Jewelers' Circular-Weekly.

POSITION WANTED; cut glass salesman; 10 years' experience; good references given; kindred lines considered. Address "C. G., Salesman, 6168," care Jewelers' Circular-Weekly.

WATCHMAKER, engraver; fine workman; very good salesman; 17 years' experience; age 32; A1 references; wishes position with good house. "S., 6265," care Jewelers' Circular-Weekly.

A FIRST CLASS retail salesman, who desires to make a change early in the Fall, would like to correspond with firm in need of A1 man. "J. H., 6147," care Jewelers' Circular-Weekly.

ENGRAVER, young man desires position to finish trade with first class engraver; good letterer on flat ware; samples on request; A1 references. "L., 6232," care Jewelers' Circular-Weekly.

FIRST CLASS manufacturing jeweler of business ability, wants position as foreman of jewelry factory; 14 years' experience at bench; references. Address "Ability, 5465," care Jewelers' Circular-Weekly.

POSITION by plain watchmaker; six years' experience; have all tools; not afraid of work; strictly sober; moderate salary to start; reference exchanged. Address P. O. Box 101, Roxton, Texas.

SALESMAN (23), three years' experience with established trade in New England, New York and Pennsylvania, is open for engagement with manufacturing jeweler. "B., 6313," care Jewelers' Circular-Weekly.

BY JUNE 1, salesman with trade among the retail jewelers in Pennsylvania, West Virginia, New York and Ohio, is open for engagement with manufacturing jeweler. "W., 6311," care Jewelers' Circular-Weekly.

FIRST CLASS watchmaker wants permanent position; competent to take full charge; large experience on fine and complicated work; fine tools; best of references. Address "Time, 6290," care Jewelers' Circular-Weekly.

FIRST CLASS ENGRAVER; experienced in all kinds of letter and monogram work, desires position with good, reliable firm as engraver and salesman, or as engraver only; can furnish best of references as to character and ability. Address L. H. Pohlman, 133 E. 74th St., New York.

HAVE YOU NEED for a reliable employe; 22 years' experience in the trade in New York and other cities; 12 years in responsible positions; now out of jewelry business and desire to return; open to any offer from good house; credentials of the best. "York, 6209," care Jewelers' Circular-Weekly.

ANY MANUFACTURER contemplating opening a branch office in St. Louis and requires services of reliable, competent, well known man, address "St. Louis, 6276," care Jewelers' Circular-Weekly.

TO WHOM IT MAY CONCERN; any manufacturer or jobber desiring the services, as traveling salesman, of a man 37 years old, 18 years' experience in large retail jewelry stores, temperate, good appearance, fine address, will do well to communicate with one who desires only first class position, where ability and energy count; New York City and southern references; southern territory preferred. "Ability," care S. A. Speidel, 1363 Carrie Ave., Columbus, O.

## Side Lines Wanted.

WANTED, by a Texas traveling man, a good line of hand painted china as a side line on commission. Address "China, 6272," care Jewelers' Circular-Weekly.

WANTED, several good lines for New York City, in addition to those now carried; experienced man. Address "E., 6269," care Jewelers' Circular-Weekly.

WANTED, by experienced traveling salesman, on commission; a line either of jewelry, combs, silver, watches, or some line for jewelers in west and northwest States. "Commission, 6230," care Jewelers' Circular-Weekly.

## Help Wanted.

WANTED, a watchmaker to go into Michigan. Apply H. F. Hahn & Co., 156 Wabash Ave., Chicago, Ill.

WANTED, a man of experience; must be good salesman, engraver and familiar with repair work. L. Black Co., Detroit, Mich.

WANTED, WATCHMAKER and engraver; good wages and splendid opportunity for reliable man. Address H. R. Baltzer, Covington, Tenn.

WANTED, a fine engraver and good optician; permanent position; send sample of engraving and reference. Edwards & LeBron, Chattanooga, Tenn.

WANTED, a clockmaker, assistant to watchmaker; good wages and steady position for the right man. Address Emile Dreyer, 75 Nassau St., New York.

WANTED, traveling salesman with established trade, for Wisconsin, Minnesota, etc. King, Raichle & King, wholesale jewelers, Buffalo, N. Y.

RING SALESMAN; an A1 ring salesman, with well established retail jewelry trade. Address "Manufacturer, 6302," care Jewelers' Circular-Weekly.

WANTED, an A1 traveling salesman; territory, Pennsylvania to Missouri; well established territory; commission or salary. Fred Kaufman, 565 Broadway, New York.

SALESMAN WANTED on commission, to sell diamond mountings, lockets, buttons, etc., for New York, Philadelphia and nearby. M. Schiff, 82 Nassau St., New York.

WANTED, good engraver, who also understands repairing jewelry and clocks; permanent position to first class man. Address J. W. Forsinger, 2 Maiden Lane, New York.

WANTED, by jobbing jewelry house, a salesman with established trade, for south or west; exceptional opportunity for the right man. "E., 6304," care Jewelers' Circular-Weekly.

WANTED, a first class watchmaker, competent of handling customers; steady man of good habits; permanent position. Apply Hartdegen & Co., Broad and West Park Sts., Newark, N. J.

WANTED, an ambitious young man as city salesman, for jewelry; one acquainted with department stores preferred; good references required. Call, Room 22, 401 Broadway, New York.

WANTED, WATCHMAKER, young man or old man, for repairing; about 10 watches per week; no tools needed; fan in the shop; state price wanted. F. C. Rivoire, Napoleonville, La.

ENGRAVER to go to North Carolina; first class, all around engraver, enamel cutter, etc.; some knowledge of jewelry work if possible; position permanent; address, with references, etc. H. Mahler's Sons, Raleigh, N. C.

A SALESMAN WANTED with trade in New York and eastern States to carry a complete jobbing line; only an A1 man is wanted and must have established trade. "Established, 6227," care Jewelers' Circular-Weekly.

WANTED, a man to take care of our engraving department, repair jewelry and clocks and take care of stock; good, permanent position for good man; must give reference; any one can fill this place. Austin & Prescott, Batavia, N. Y.

WANTED, to go to Virginia, first class jeweler and engraver; one who can take entire charge of department in first class store; an excellent opportunity for a capable young man. "Opportunity, 6225," care Jewelers' Circular-Weekly.

WANTED by jewelry and watch house, salesman for middle west. Address, "A. G., 6180," care Jewelers' Circular-Weekly.

WANTED a first class watch salesman with an established trade; good salary to the right man. Address, Rockford Watch Co., Rockford, Ill.

WANTED, AT ONCE, a competent watchmaker, plain engraver and jewelry repairer; permanent position; salary, \$20 week; chance of advancement; references and sample of engraving in first letter; apply at once. A. Rabinowitz, Stamford, Conn.

SIDE LINE for experienced salesman, calling on best jewelry trade in New York, Pennsylvania and East; well known; popular 10-K. and 14-K. jewelry line, with big inducements; address with full particulars. "N., 6282," care Jewelers' Circular-Weekly.

WANTED, a first class watchmaker, engraver and jeweler; surroundings pleasant; position permanent; one capable of taking charge of repair department; splendid opening for good man; state age, experience, etc. H. B. Dodge, 42 Market St., Lynn, Mass.

TRAVELING SALESMEN to sell Swiss watches; those having experience in some branch of the jewelry line and have covered the west, northwest and southwest. Address Western Selling Agency, Omega Watches, A. M. Holzheimer, Gen. Mgr., Heyworth Bldg., Chicago, Ill.

WANTED, a young man with experience as salesman in retail store, in flourishing Virginia town; mechanical experience would be advantageous, but not necessary; splendid chance for a young man who wants to advance himself. "Advancement, 6226," care Jewelers' Circular-Weekly.

**HELP WANTED.—Continued.**

**WANTED**, a first class all round jeweler, one who is capable of doing first class repairing and making new goods; particularly diamond work; good wages and steady work guaranteed to the right man; none but sober, steady men need apply. Address "Reliance, 5940," care Jewelers' Circular-Weekly.

**WANTED**, strictly first class combination man (watchmaker, jeweler and engraver); must be sober and well recommended; good salary and permanent position to good man; must be a willing worker, rapid and very thorough; state salary expected and send sample engraving first letter. Thos. Van Auken & Co., 518 Pearl St., Beaumont, Tex.

**RING SALESMAN**; an experienced ring salesman having an established trade with best retail jewelry stores; state experience; only high class men with ability considered. Address, "Manufacturer," P. O. Box 881, New York.

**ANNOUNCEMENT**; on or before June 1, we will make room for a limited number of young beginners, to learn and perfect themselves in the art of practical watch repairing; we train them quicker and with closer attention than the crowded horological schools. For terms or other information apply direct or by letter to Maebert & Reiss, practical and theoretical watchmakers, 71-73 Nassau St., cor. John St., New York.

**FACTORY FOREMAN**; must be up-to-date and capable to take full charge of factory producing 14k. jewelry; one who can produce new designs and develop the business preferred; excellent opportunity for the right man; address with references. "Progressive, 6305," care Jewelers' Circular-Weekly.

**Business Opportunities.**

**GOOD, PAYING** watch repair business, in fine health resort town of 3,000, in western North Carolina; invoice about \$1,500. Address "Jeweler," Box 226, Hendersonville, N. C.

**FOR SALE**, jewelry store, Wayne County, N. Y., manufacturing town of 6,000; small stock; best location; snap for young man with little money. "New York, 6309," care Jewelers' Circular-Weekly.

**SALESMAN** or financial man with \$5,000 is offered opportunity to enter young and busy manufacturing concern; have connections with best stores but in need of above man. "Fifth Ave., 6298," care Jewelers' Circular-Weekly.

**STAIGER & SONS** would like to represent leading jewelry houses in Brooklyn and on Long Island. 926 Broadway, Brooklyn, N. Y.

**PARTNER WANTED**, man about 30, who is well acquainted with the jewelry trade and can invest about \$5,000 in an old established manufacturing jewelry concern of A1 reputation. Address "Maiden Lane, 6228," care Jewelers' Circular-Weekly.

**FOR SALE**, optical business in Pittsburg; this is an exceptionally good opportunity; reason for selling, have two places and can't attend to both; rent, \$1,300; lease, three years; price, \$1,500, part cash, balance by notes, Wm. J. Adler, 1625 Boardwalk, Atlantic City, N. J.

**CASH FOR WATCHES** and diamonds; send them at once and get your money by return mail. Joseph Brown & Co., Fifth Ave. and Madison St., Chicago, Ill.

**FOR SALE**, first class factory, for manufacture of rings; valuable good will and large line of customers free; full line or part of samples below cost; office fixtures, traveling outfits, safes and all machinery and tools at very low figure. Address "Mark, 6255," care Jewelers' Circular-Weekly.

**DO YOU WISH TO RETIRE?** We buy jewelry stores to any amount; also entire stocks of jewelry, diamonds, watches, silverware, fixtures, etc.; we are known all over the United States to pay highest spot cash; notify us, we will call on you at once; all business transacted we handle strictly confidential. Address Brooklyn Purchasing Syndicate, 608 Broadway, Brooklyn, N. Y., or Tel. 2328, Williamsburg.

**For Sale.**

**FOR SALE**, at 50 cents on the dollar, 135 purple lined trays. Address Albert Pfeifer & Bro., Little Rock, Ark.

**FOR SALE** or exchange, new Francis engraving machine with type; will exchange for optical instruments. "N., 6235," care Jewelers' Circular-Weekly.

**AN ENTIRE SET** of fixtures of an up-to-date jewelry store, for sale; also store room for rent; owner retiring on account of ill health. Chas. A. Kuhn, Hanover, Pa.

**FOR SALE**; first class ring factory; in perfect running order; electric motor and all machinery as a whole or in parts; will sell cheap to save rent. Address "Electric, 6254," care Jewelers' Circular-Weekly.

**FOR SALE**, a job lot of diamond jewelry bought at bankrupt sale, consisting of cluster brooches, scarpins and rings; sent on memo. bill to well rated jewelers; prices will surprise you; get my advice, where to buy or sell; it costs you nothing. Dan I. Murray, Broker, 3 Maiden Lane, New York.

**To Let.**

**DESK ROOM** or part of office to let. 3 Maiden Lane, Room 53, New York.

**TO LET**, part of office. Apply Room 40, 6th floor, 37 Maiden Lane, New York.

**TO LET**, part of an exceptionally desirable office, with fine north light; opportunity for precious stone business or manufacturing agent. Room 48, Lorsch Bldg., 37 Maiden Lane, New York.

**TO RENT**, very desirable office; third floor; north light; excellent opportunity for precious stone business or manufacturing jeweler. Apply Room 307, Broadway-Maiden Lane Bldg., 170 Broadway, New York.

**PART OF OFFICE** to lease; good light; suitable for watchmaker, diamond broker or dealer in precious stones; desk, chairs and shelf furnished. Address "Cockcroft Building, 6246," care Jewelers' Circular-Weekly.

**Wanted to Purchase.**

**WANTED**, a small lathe; something larger than a watchmaker's lathe; state make, size and price. W. M. McNeal, Atlanta, Ga.

**Desirable Factory Space,**

17 John Street, New York.

Very reasonable. Power furnished. Apply to

WM. A. WHITE & SONS,  
62 Cedar Street, N. Y.

**"PRACTICAL COURSE  
IN  
ADJUSTING."**

PRICE \$2.50.

ALL JOBBERS OR

**JEWELERS' CIRCULAR PUBLISHING CO.**

**Trans-Atlantic Voyagers.**

TO EUROPE.

Steven Laubasher, of L. Gutmann & Sons, Cincinnati, O., will sail this week.

S. Lindenborn, New York, and Mrs. Lindenborn, sailed, last week, on the *Kronprinz Wilhelm*.

J. Albert Caldwell, of J. E. Caldwell & Co., Philadelphia, Pa., will sail Saturday on the *Philadelphia*.

Cortland E. Hastings, formerly of Carter, Hastings & Howe, New York, sailed last Thursday on the *Cretic*.

Charles L. Power, of Charles L. Power & Co., New York, and Mrs. Power, will sail next Saturday on the *Columbia*.

FROM EUROPE.

J. Van Wezel, of S. L. Van Wezel, New York, returned, recently, on the *Kronprinz Wilhelm*.

M. Gattle, of Gattle, Ettinger & Hammel, New York, and Mrs. Gattle returned, May 5, on the *Cedric*.

E. A. Eisele, of King & Eisele, Buffalo, N. Y., with his wife and daughter, returned, last week.

**Recent Reappraisements of Diamonds,  
Jewelry and Kindred Lines.**

Reappraisements of diamonds and jewelry have been announced in the last week by the Board of United States General Appraisers, New York, as follows:

Diamonds from A. Bamdas, Antwerp, exported March 20, 1906, entered at New York (File No. 39181); findings of Board No. 2: Prices as published in reappraisement No. 6724, April 16, 1906; reappraised value affirmed.

Manufactures of coral from Francesco de Simone, Naples, exported March 6, 1906, entered at New York (File No. 39321); findings of Board No. 2: Price as published in reappraisement No. 6824, April 23, 1906. Reappraised value affirmed.

Silver filigree jewelry from Bevengi Guiseppa, Genoa, exported Dec. 3 and 22, 1905, entered at El Paso (File Nos. 39398 and 39630); findings of Sharretts, G. A.: Entered at 26, advanced to 25 lire per gram.

Mrs. M. J. Saks, Blossburg, Pa., contemplates moving her stock into new quarters adjoining the First National Bank in Wellsboro, Pa., about June 1.

Lucretia S. Williams, widow of the late T. A. Williams, for many years a jeweler in Orange, Mass., died May 9, at her home at that place, aged 33 years.

Henry Freund & Bro. are now settled in their new quarters in the Cockcroft building, New York. They have a very large space with light on three sides from 14 windows, six of them facing the north, thus giving excellent facilities for the diamond end of the business. Their new safe and fixtures are not yet in place, but sufficient may be seen to indicate that they will have most attractive offices in which all departments will have ample room for expediting the increasing business. This is the third time the firm has had to increase its quarters since it started, 10 years ago, under its present style. The firm will be pleased to welcome at their office members of the trade coming to New York, and every convenience will be placed at the disposal of visitors. Two beautiful specimens of the noble elk will adorn the walls of the new office, calling attention to the firm's business in the line of Elk jewelry.



# FANS

Fan Season is here, and we are prepared for it with the choicest line that has ever been imported from Paris. These dainty creations are appropriate for Graduation, Confirmation, Weddings, and in fact for any occasion where taste and exclusiveness are requisite.

SEND FOR A SELECTION, MENTIONING PRICE

**LEWY & COHEN**  
530 BROADWAY, NEW YORK

Importers of Fans, Brooches, Mounted Side and Back Combs, French Bead Necklaces in mother-of-pearl effects, and THE "MEDICI CHAIN," a new French creation in fan chains.

Supremacy  
of the  
"Egyptian"  
Pearls.

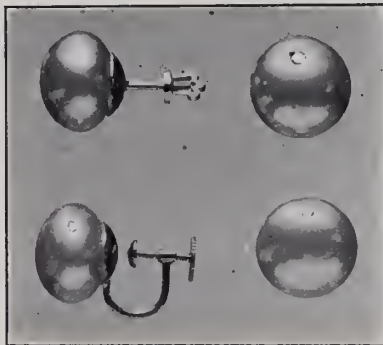

Ear Drops,  
Scarf Pins,  
Rings,  
Studs, etc.

THE IRIDESCENCE, perfection of color, and natural weight of "EGYPTIAN" Pearls render them superior to all other artificial pearls. The illustration shows some of our Ear Drops, with attachments for either pierced or unpierced ears. Pearls are shaped round for mounting in point settings, and flat top or button shape for invisible cup settings. The mountings are in 10 and 14 karat gold.

**GEORGE H. CAHOONE COMPANY,**

Makers of Artistic Jewelry.

PROVIDENCE—7 Beverly Street.

NEW YORK—9 Maiden Lane.

# Ribbons

in stock and special designs **MADE TO ORDER**, in large or small quantities, to use with medals and for club purposes. Correspondence invited.

JOSEPH LOTH & CO., Manufacturers, 65 Greene Street, New York.



Ladies' Fancy Stone Rings  
and Stone Scarf Pins  
in 10K. that defy  
competition.

Our reputation for making the finest and most complete line of 10-K. gold band rings is still maintained—ask your jobber.

THE  
**EDWIN LOWE & CO., Inc.**

F. W. BODWELL, V.-Pres. and Gen. Mgr.,  
116 Chestnut St., PROVIDENCE, R. I.

New York Representative, E. T. Wilson, 180 B'way.  
Western Representative, S. H. Brower.

## Mother of Pearl Clock.

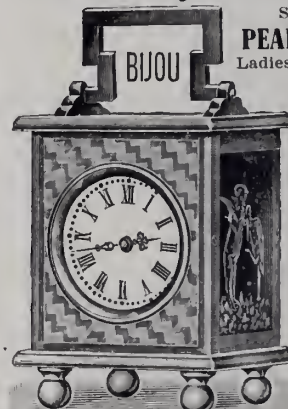

SPECIALTY:  
**PEARL WATCHES**  
Ladies' and Gentlemen's  
Nurses'  
Watches,  
Repeaters and  
Chronographs.

Extra flat watches  
in Gold, Silver, Gold  
Filled and Gun  
Metal.

Enameled  
Watches  
of all kinds.

Write us  
immediately  
for information  
if interested  
in the new  
season's  
offerings.

Exact Size—Cylinder and Lever Movement.

**KLIPPER BROS.,**  
59 Maiden Lane, NEW YORK.

## MAEBERT & REISS

WATCHMAKERS TO THE TRADE  
Wheel Cutters and Adjusters

Accurate Work—Low Prices—Quick Returns.  
We receive parcels by mail or express from all  
over the United States.

71 and 73 NASSAU ST., Corner John,  
(The New "Cockcroft" Bldg.) NEW YORK.

## GARREAU & GRISER

68 & 70 Nassau St., New York.

**LAPIDARIES.** PRECIOUS  
STONES  
EMS in Unique Cuttings.

**An Indispensable Book**  
FOR MANUFACTURERS, JOBBERS  
AND RETAILERS ALIKE IS  
**TRADE-MARKS**

OF THE  
**JEWELRY and KINDRED TRADES,**  
PRICE \$3.00.

PUBLISHED BY  
THE JEWELERS' CIRCULAR PUB. CO.,  
11 John St., Cor. Broadway, New York.

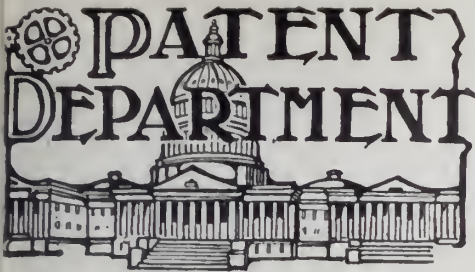

[IN WHICH IS CONTAINED A LIST OF THE LATEST PATENTS GRANTED BY THE UNITED STATES AND GREAT BRITAIN, THE UNITED STATES PATENTS THAT HAVE EXPIRED AND THE REGISTERED TRADE-MARKS.]

UNITED STATES PATENTS.

ISSUE OF MAY 8, 1906.

819,708. WHEEL FOR CLOCKS OR WATCHES. ARCHIBALD BANNATYNE, Waterbury, Conn., assignor to the Bannatyne Watch Co., Waterbury, Conn. Filed June 29, 1901. Renewed Oct. 10, 1905. Serial No. 282,163.

A wheel of the character described comprising an arbor, a wheel and collet on the arbor, and a series of pins extending through both wheel and

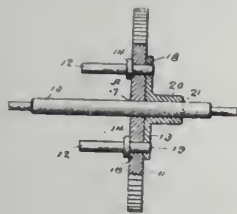

collet, each pin having one end headed down and having an integral shoulder, the wheel and collet being secured together between the shoulders and the headed-down ends of the pins, the other ends of the pins being free.

819,713. STEM-WINDING WATCH. NUMA BEGUELIN, Solothurn, Switzerland. Filed Sept. 16, 1904. Serial No. 224,703.

A watch hand setting and winding mechanism comprising a longitudinally-movable winding and

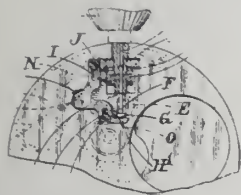

setting pin, a rotatable sleeve, a crown-pinion loosely mounted on said sleeve, a double clutch longitudinally movable on said sleeve, a slide operated by the winding and setting pin, a pin on said slide, a strong spring acting against said pin, a pivoted clutch-operating lever and a spring acting against the tail of said lever in opposition to the first-named spring.

819,714. STEM-WINDING MECHANISM. NUMA BEGUELIN, Solothurn, Switzerland. Filed Sept. 16, 1904. Serial No. 224,705.

In a watch-hand setting and winding mechanism,

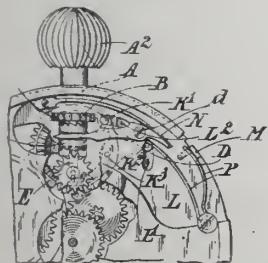

a pivoted lever, two pins thereon, a pivoted clutch-operating lever situated between the pins, and a spring acting on one pin, and a second spring act-

ing against the tail of the clutch-operating lever,

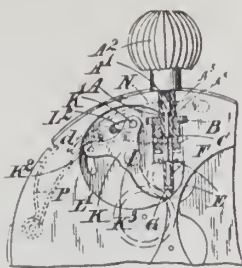

substantially as set forth.

819,719. FOUNTAIN PEN. FRANCIS C. BROWN, New York. Filed July 7, 1905. Serial No. 268,711.

In a fountain-pen, the combination of the upper and lower feed-tongues adapted to receive the nib between them, the brace arranged to engage the ink-returner located between the lower feed-tongue and forward portion of the lower feed-tongue and the brace and grooved transversely on the side facing said brace.

819,809. PENDULUM-BEAT ADJUSTER. ERNEST W. SARTOR, Paducah, Ky. Filed July 13, 1905. Serial No. 269,522.

In combination with an escapement-wheel and a verge controlling the same, a verge-carrier rotatably mounted coaxially with said escapement-

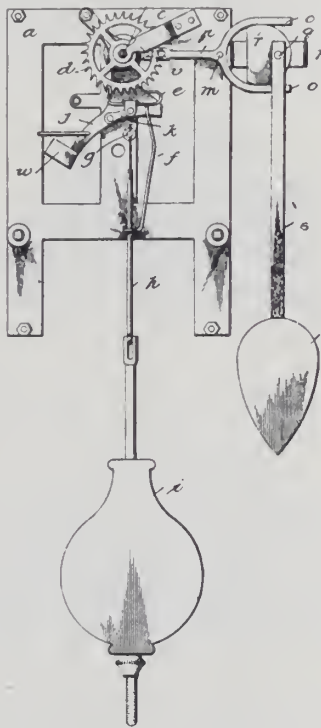

wheel; a lever one end of which is connected with said verge-carrier and the other end of which is forked; a cam which controls the forked end of said lever; and an arm for controlling said cam.

819,875. CIGAR-TIP CUTTER. LOUIS E. GARIGUS, Newark, N. J. Filed Oct. 10, 1905. Serial No. 282,144.

A cigar-tip cutter comprising a chambered shell or box, consisting of a pair of oppositely-arranged and centrally-perforated dish-shaped disks formed with an opening in a portion of the marginal edge

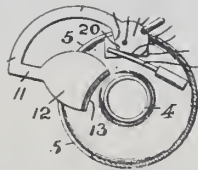

of said shell or box, a pin extending from disk to disk, and a cutting mechanism pivotally arranged on said pin, consisting of an enlarged portion provided with a pair of straight and angularly-arranged marginal edges, a curved or segmental arm extending from said enlarged portion, said arm conforming to the configuration of the opening in the marginal edge of the shell or box, and serving

as a closure for said opening, a cutter connected with said segmental or curved arm, a spring secured between said disks, said spring having its free end portion in engagement with either of said straight marginal edge portions of the enlargement of said segmental or curved arm, and a finger-piece upon the enlargement of said segmental or curved arm, extending from the marginal opening of said shell or box, serving to open said cutting mechanism and to limit the outward movement of the same.

819,927. HAIR-FASTENER. FRANK B. ROGERS and CHARLES H. DITTMER, Maddux, MOHT. Filed Oct. 18, 1905. Serial No. 283,323.

A hair-fastener comprising a pair of forked pins, the prongs of which are presented toward each



other, the head of one of said pins having an opening, and the head of the other pin a socket, and a pin slidably mounted in the aforesaid opening, and extensible into the socket, and removably secured therein.

819,948. OPTICAL INSTRUMENT. AMBROSE SWASEY and GOTTLIEB L. FECKER, Cleveland, O., assignors to the Warner & Swasey Co., Cleveland, O. Filed Nov. 22, 1905. Serial No. 288,617.

In an optical instrument, the combination of a tubular body, a tube slidable in said body, but prevented from rotating therein, a wall in said tube provided with three apertures, the wall having a

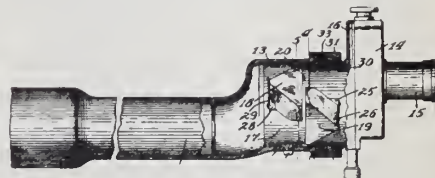

recess in one face including two of such apertures, an optical element seated in such recess, a post projecting from said side of the wall, a clip secured on said post and clamping said optical element in said seat, the wall having a recess on its opposite face including the third aperture, and one of said other apertures, an optical element seated in such recess, a post projecting from such latter face of the wall, and a clip secured to said latter post and engaging said latter optical element to secure it in position.

819,950. CALENDAR-CLOCK. ELAH TERRELL, Columbus, O. Filed April 15, 1905. Serial No. 255,682.

In a time-indicating mechanism, the combination with a minute-wheel, an hour-wheel provided in its side with a depression, a day-wheel and a month-wheel, and a fixed projection supported in juxtaposition to the month-wheel, of a plurality of plungers carried by the month-wheel adapted to

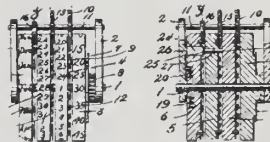

intermittently engage with the fixed projection, a pin carried by the day-wheel and arranged to be engaged by one of the plungers and forced into engagement with the depression of the hour-wheel to lock the hour-wheel to the day-wheel when the said plunger engages with the fixed projection.

820,061. ICE-CREAM SPOON. DOSIER H. MOTTLELLER, Chicago, assignor of one-fourth to Ritley N. Baylies and one-fourth to Fred N. Baylies, Chicago. Filed Sept. 26, 1905. Serial No. 280,174.

In an ice-cream spoon, the combination with the bowl and handle of the spoon of a scraper located



and operating in the bowl, a rock-shaft extending longitudinally of and parallel with and carrying the scraper, a return-spring for the rock-shaft, a winding-spool fixed on the outer end of the shaft and a cord, and a lever having the cord attached to its outer end for operating the scraper within the bowl of the spoon.

820,067. POCKET ASH-RECEPTACLE. LAVINIA D. RICHARDSON, Fredericksburg, Va. Filed June 22, 1905. Serial No. 266,511.

A device of the class described fashioned to

simulate a living creature, comprising a unitary hollow elastic body substantially circular in cross-section and provided with a slit in its wall serving

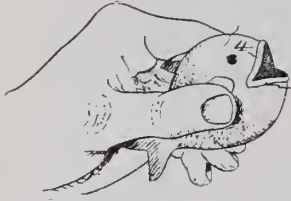

as the mouth of such creature, said body being otherwise imperforate, said slit being reinforced about its edges and being normally closed and adapted to be opened by compressing the walls of said body.

**820,123. SPEED-TIMING APPARATUS.** ALDEN L. McMURTRY, New York. Filed June 8, 1904. Serial No. 211,685.

In a speed-timing apparatus, the combination of a main electric circuit and source of energy, a series of stop-watches grouped at a desired point, means for simultaneously starting all the watches, local

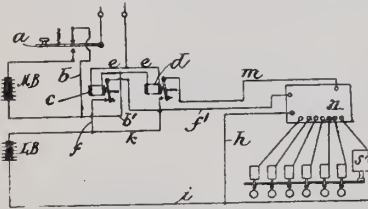

means controlled by impulses of current in the main circuit for independently stopping the respective watches, and means located at any desired point or points in the main circuit for controlling it to thereby actuate said local means to successively stop the watches.

**820,174. LENS-MOUNTING.** VINCENT BERTOLINI, Chicago, assignor to F. A. Hardy & Co., Chicago. Filed Dec. 19, 1904. Serial No. 237,536.

As a new article of manufacture, a lens-mounting having a post comprising a pair of parallel arms located one above the other, and a portion



connecting them and forming the inner end of the post, a pair of straps proceeding outward from said arms, respectively, and a pair of bracing-tongues directly jointing the outer extremities of the arms and proceeding upward and outward therefrom.

**820,252. WATCH-BARREL ARBOR.** WILSON E. PORTER, New Haven, Conn., assignor to the New Haven Clock Co., New Haven, Conn. Filed June 19, 1905. Serial No. 265,855.

A one-piece spring-harrel arbor for timepieces, having an annular flange transversely broken for the production of a hook to be engaged by the inner end of a coiled spring formed at its inner



end with a hole for the reception of the hook which is narrower than the width of the spring and also having two annular shoulders corresponding to each other in diameter but smaller in diameter than the said flange which is located between them, and the said arbor also having two journals on which it runs and being adapted to have a spring-barrel applied to it and the said shoulders preventing the extreme inner end of the spring from tilting and being disengaged from the hook.

**820,382. SAFETY-PIN.** THERON S. CARROLL, Winsted, Conn. Filed Dec. 24, 1898. Serial No. 700,198.

A safety-pin comprising a pin-bar and a pin-

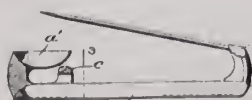

point shield for the pointed end of the pin-bar, the pin-bar having a segmental bend without a

coil, the pointed end of the pin-bar normally tending to move away from the pin-point shield when disengaged therefrom, and means engaging the pin-bar at the segmental bend and acting to limit said movement of the pointed end of the pin-bar and also acting as a stop to prevent fabric through which the pin-bar is inserted passing to and around said bent part of the pin-bar.

DESIGNS.

**37,988. NAIL-FILE.** ERNST RUETTIGERS, New



York. Filed March 19, 1906. Serial No. 306,935. Term of patent 7 years.

**37,999. GLASS VESSEL.** BENJAMIN FRANKLIN DAVIES, West Hoboken, N. J., assignor to L. Straus & Sons, New York. Filed March



15, 1906. Serial No. 306,303. Term of patent 7 years.

**38,000. CUT-GLASS VESSEL.** WILLIAM C. ANDERSON, Lansing, Mich., assignor to the Libbey Glass Co., Toledo, O. Filed March



26, 1906. Serial No. 308,181. Term of patent 7 years.

**38,001. CUT-GLASS VESSEL.** DENNIS F. SPILLANE, Toledo, O. Filed March 26, 1906.



Serial No. 308,182. Term of patent 7 years.

**38,002. CUT-GLASS VESSEL.** DENNIS F. SPILLANE, Toledo, O., assignor to the Libbey Cut Glass Co., Toledo, O. Filed March 26,

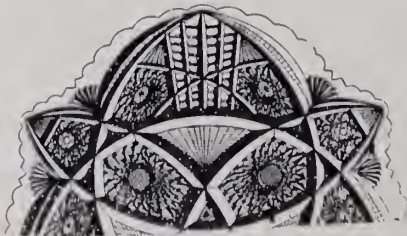

1906. Serial No. 308,183. Term of patent 7 years.



**37,989. SPOON OR SIMILAR ARTICLE.** GEORGE CHAMBERS and ROBERT J. STEWART, Mount Clemens, Mich. Filed April 7, 1906. Serial No. 310,580. Term of patent 14 years.

**38,003. DRINKING-TUMBLER.** HUGO THUEMLER, Pittsburg, Pa. Filed March 23, 1906.

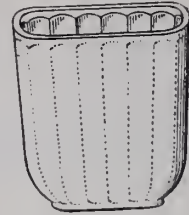

Serial No. 307,727. Term of patent 3 1/2 years.

**37,990. HANDLE FOR FORKS, SPOONS AND SIMILAR ARTICLES.** JOHN LEECH, Bridgeport, Conn., assignor to the International Silver Co., Bridgeport, Conn. Filed March



31, 1906. Serial No. 309,226. Term of patent 7 years.

**37,991. HANDLE FOR SPOONS, FORKS AND SIMILAR ARTICLES.** CHARLES T. PAYE, North Attleboro, Mass., assignor, by mesne

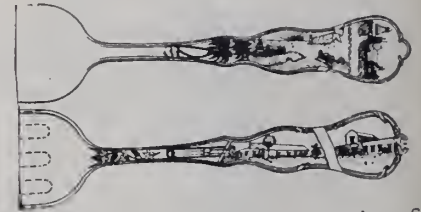

assignments, to Chris W. Ernsting, San Diego, Cal. Filed April 5, 1906. Serial No. 310,181. Term of patent 7 years.

**UNITED STATES PATENTS THAT HAVE EXPIRED.**

[Reported especially for THE JEWELERS' CIRCULAR-WEEKLY by R. W. Bishop, Patent Attorney, Washington, D. C.]

Issued May 7, 1889.

**402,620. DRINKING-CUP.** JOHN SCHUE, Rochester, N. Y.

**402,672. BROOCH-PIN.** MENDEL HOWARD, New York.

**402,685. CUFF-FASTENER.** C. L. MOORE, Worcester, Mass.

**402,701. BROOCH-PIN.** BRUNO VON BULTZING-SLOWEN and MENDEL HOWARD, New York, said Bultzingslowen assignor to said Howard.

**402,769. BAG-LOCK.** CHARLES REINISCH, Newark, N. J.

**402,823. ELECTRIC CLOCK.** E. G. HAMMER, Brooklyn, N. Y.

**402,837. INKSTAND.** G. R. G. JONES, Louisville, Ky.

**402,861. TRAVELING-BAG.** MORRIS SCHWERIN, Newark, N. J.

**402,864. FOUNTAIN-PEN.** L. A. SHATTUCK, Bloomsburg, Pa.

**402,914. PENCIL-SHARPENER.** J. R. FOSTER, Stoncham, Mass.

**402,916. COMBINED PAPER-WEIGHT, CALENDAR AND MUSICAL WATCH.** ELLA N. GAILLARD, New York.

**402,917. CLOCK-STRIKING MECHANISM.** D. J. GALE, Forestville, Conn.

**402,969. COFFEE OR TEA POT.** G. E. RAYMOND, Chicago, Ill.

**402,972. TIMEPIECE.** HUGUES RIME, Paris, France, assignor to the Societe Armand Schwab at Frere, same place.

**403,003. FINGER-NAIL TRIMMER.** C. P. TENER, Hillsborough, O.

**403,021. PEN.** J. L. ACKERMAN, Lowell, Ind. Designs issued May 9, 1899, for 7 years.

**30,714. BREAST-PIN.** M. R. SWAN, Manilla, Ia.



**BRITISH PATENTS.**

(ABRIDGMENTS OF SPECIFICATIONS, 1901, FROM *The Illustrated Official Journal.*)

ISSUE OF APRIL 25, 1906.

**29,157.** F. M. BRITAIN, Croydon, Surr'y. Dec. 30.

Dinner plates are provided with hemispherical

FIG. 2.

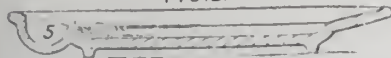

receptacles in the rim for the reception of condiments.

**29,195.** WORKMEN'S TIME RECORDERS. F. M. HOWARD, Liverpool, Dec. 31.

A lever 4, Fig. 1, is turned round a dial to a definite position for each operator, and the end pressed into a hole, thus causing printing wheels 9, 10 to be lowered into contact with a corresponding column on a record drum. Means for centering the minute wheel 9 and sounding a bell, an ink ribbon feed, and an automatic device for shifting the printing mechanism along the drum at prearranged times are provided. The printing wheels 9, 10 are mounted in a pivoted frame 13 which is

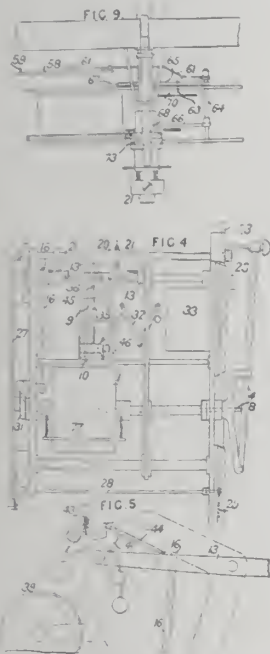

connected by a spring to a rod 16 passing through the frame as shown in Fig. 5. This rod 16 is actuated from the operating lever 4 by a push-pin 8 as shown, an in-and-out-of-action piece 31 being provided for disconnecting the mechanism. The minute wheel 9 is driven by a cantilever connection 32 from a clock 33; this allows the printing wheels to be shifted along the record drum 1 by a nut 20 and screwed spindle 21 operated either by a handle 23 or automatically as described below. The spindle 21 also actuates an indicator 29 through rods 27, 28, thus showing the position of the print. The minute wheel is centered by a blade 36 pivoted to the frame 13 and linked to the nut 20, this blade engaging a notched wheel 35 when the frame 13 is lowered. If the blade 36 lodges on a tooth the printing-wheels cannot descend. A bell 39, Fig. 5, is struck at each print, but not if the blade 36 does not enter the notch. A bell-hammer is carried by a block 41 pivoted on the main framework and connected by a spring to an adjustable bracket 43. An arm 44 on the block 41 slides along the pivoted frame 13, when the latter is lowered, and meets the rod 16. Further lowering stretches the spring until the rod 16 passes below the frame 13, the spring connection of the frame with this rod allowing this. At this point, the arm 44 is released, and the bell-hammer springs forward and strikes. If the frame is held by the blade 36 resting on a tooth, the spring is not stretched enough for the hammer to strike. In a modified form, the hammer block 41 is pivoted to the bracket 43, raised against a spring and released by a rocking catch on the pivoted frame 13, and pulled by another spring. The printing-mechanism

is shifted along the drum automatically by the escapement device shown in Fig. 9. The clock drives a disk 58 having holes to receive pins 59 which raise an arm 61 at prearranged time. This arm 61 is connected to another 63, both being loose on a spindle 64 having fixed to it two other arms 65, 66. The arm 65 engages a one-notched disk 67 of a spring-driven train, and the arm 66 a stop 68 on another wheel of this train. When the arms 61, 63 are raised, the latter raises the arm 65 and consequently the connected arm 66, the train advancing until the raised arm 63 meets another stop 70. The arms 61, 63 are lowered directly after, allowing the disk 67 to make one revolution. This causes the screwed spindle 21 to be revolved once, through a clutch 73, and the printing-wheels shifted a corresponding distance along the recording-drum. The clutch 73 can be disengaged by a push-pin and the printing-wheels returned to their initial position by the handle 23. A locking-piece is provided and can be turned to prevent rotation of the spindle 21. A special ink ribbon feed is driven by a pawl 45 from the centering-blade 36, Fig. 1. A thickened part of the ribbon engages a rocking-piece when the ribbon has to be rewound, and causes the spindle of the wheel 16 to be shifted by a spring. The recording-drum 1 is hollow, and the ends of a ruled time-sheet are inserted through a slit and held by a spring-pulled bar 77.

**29,196.** WORKMEN'S TIME-RECORDERS. F. S. HOWARD and F. M. HOWARD, both of Liverpool, Dec. 31.

The machine described in Specification No. 23, 454, A.D. 1898, is modified so that time records may be obtained upon cards used in ascertaining the cost of work as well as upon the usual time-sheet. Such a card is inserted by hand between



the guide-plates B, A of which the former is free to move laterally, while the latter can be adjusted according to the six days of the week by means of a handle X, slot E, and set-screw D, the adjustment being with reference to the plate C, which is fast to, and moves on the same guides as the printing carriage G. The card is slipped under the sheath Q which bears marks for comparison with cross-lines upon the card to aid in positioning the record. The printing-wheels are brought down to impress by the lever and print through an aperture in the guide-plate A.

**29,215.** TIME-CHECKING APPARATUS. W. M. LLEWELIN, Bristol, Dec. 31.

In apparatus for recording the time of entry into, and exit from, a lavatory or similar place, two check-operated mechanisms are employed, Fig. 1 being a front view of the first and Fig. 5 a side view of the second. A clock, when inserted through a slot B, moves a pivoted detent lever C and frees

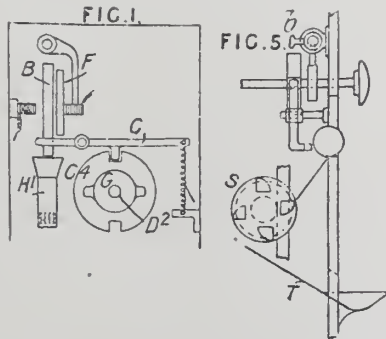

a notched disk C<sup>1</sup>. This allows the disk spindles D<sup>2</sup> to be rotated by external handles. The first spindle D<sup>2</sup> is turned until a cam disk G on it raises a platen and prints the hour and minute from corresponding type-wheels. A second disk makes an electric contact, and by means of pivoted electromagnets draws back a bolt and causes a plate

F, Fig. 1, to cover the first slot B. The second spindle is turned to withdraw a second bolt b, Fig. 5, allowing the door to be opened, and in this case the check used falls into a pocketed drum S. The drum spindle is connected by ratchet gear to a vertical rack on the door which is moved by a fixed striking-piece when the door is shut. This turns the drum for part of a revolution. The second bolt b can be moved by hand or by a spring or is reopened, and on the closing of the door the drum S is rotated so that the check used is returned by a guide T. Also, a disk on the drum spindle makes a second electric contact, this having the reverse effect to the other. The first slot B is thereby opened, and the first bolt reinserted. Finally, the check returned by the guide T is placed in the first slot B, allowing a second print to be made. The checks correspond to their users, and may ordinarily be kept on a board. Their order in the receptacle P<sup>1</sup>, Fig. 1, corresponds to that of the records. The provisional specification mentions that the printing-mechanism may be that described in Specification No. 1448, A.D. 1904, and that the two checks used may finally be passed into separate slots, both these slots being closed during the occupation of the lavatory.

**29,229.** ADVERTISING. G. McDONALD, Newcastle upon-Tyne, and G. W. KENYON, Hampstead London, Dec. 31.

Relates to apparatus for advertising in connection with clocks, in which the timepiece controls the display of the advertisements. Fig. 1 shows the clock with the advertisement-carrying drum a below. On the fourth or other suitable wheel c of the timepiece are fixed four pins c<sup>1</sup>, equally spaced

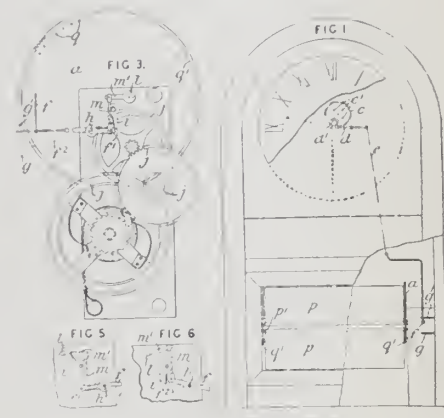

apart and acting in turn upon the short arm d<sup>1</sup> of a lever d. The lever d is connected by a cord, wire, or chain e to a lever f, of such length that very little power is required to operate it. The lever f moves between the stops g, g<sup>1</sup>, and is pivoted at h by a spindle with which it rotates. Its shorter end f<sup>1</sup>, when in the position f<sup>2</sup> shown in Figs. 3 and 6, prevents the detent lever i from rotating. The clockwork train j, j operating the drum a is thus stopped until the lever f comes into the position shown in Fig. 5, when the detent i is released and makes half a revolution until it meets the stop l. The pin c<sup>1</sup> is then at half-way along the arm d<sup>1</sup>; when the arm d<sup>1</sup> is released, the lever f descends, the end f<sup>1</sup> rises and through the spindle h and links m, m<sup>1</sup> raises the stop l. The detent i is thus released, and rotates until it again engages the end f<sup>1</sup>, when the process is repeated. The advertisements are mounted on the drum a by means of cards p on wires p<sup>1</sup>, the ends of which pass through holes q in the end disks q<sup>1</sup> of the drum, these holes q being so spaced apart that the half-revolution of the detent i allows the train j sufficient motion to change the displayed advertisement. The advertising-mechanism is driven by a spring preferably a little stronger than those generally used in clockwork.

**29,239.** WORKMEN'S TIME-RECORDERS. J. J. STOCKWELL, London, E. C. Dec. 31.

The going-train of type-wheels driven from the clock-spindle is modified to secure better alignment, locking and quick transfer of the motion between the different wheels; and the printing-handle operates a punching-mechanism whereby the record cards are fed downwards upon completion of each line. The main type-wheel spindle c, Fig. 3, is driven from the clock through a crank with a pin engaging with a slotted wheel, but controlled as to its motion in the slot by means of springs whereby slight relative motion during printing is allowed, and has fixed upon it the minute-wheel and its justifying-wheel e, Fig. 4,

the latter carrying a pin to engage and move at each revolution a toothed wheel on the shaft *p*. The shaft has a pin-and-recess wheel *o* which cooperates intermittently with the justifying-wheel *k* attached to the date wheel *j* and with its aligning-pawl *l* to change the date daily. Normally, the minute-wheel is free, but the operation of the

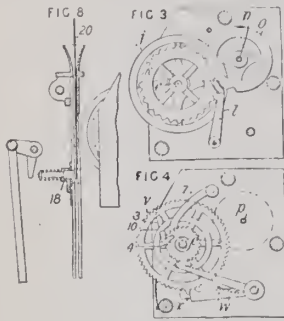

printing-handle brings a double aligning-pawl *x, y*, Fig. 4, into gear with its justifying-wheel, which carries a spring pivoted piece *3* movable at right-angles to the plane of the wheel by contact with a projection upon the framework. This movement brings a pin *4* on the pivoted piece into gear with the justifying-wheel *2* corresponding to the hours and feeds it one unit, a pin on the locking-pawl *7* and a recess in a ring *10* unlocking the justifying-wheel for the purpose. Fig. 8 shows the record card *20* held in guides before the type-wheels, and resting with one of its lower corners on a small plate. When the card and its carriage have moved transversely until the last entry on a given line is being printed, the punch *18*, operated as shown at each stroke of the printing-handle, cuts off the corner in question so that the card falls into position for recording on the next line.

**29,260.** CLIP FOR NECKTIES, ETC. C. C. CALDER and R. G. EUSTACE, Bedford Park, both in London. Dec. 31.  
The clip is made from a length of metallic wire,

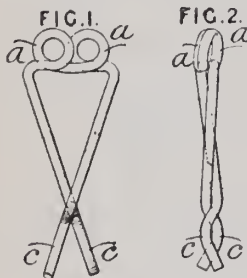

which is bent into the form shown in Figs. 1 and 2 with one or more loops *a* and the reversely curved portions *c* for gripping the tie, etc.

**29,522.** FIELD GLASSES. K. MARTIN, Rathenow, Prussia, Germany. Dec. 31.

In order to give increased stereoscopic effect in one position, and to allow observations to be taken

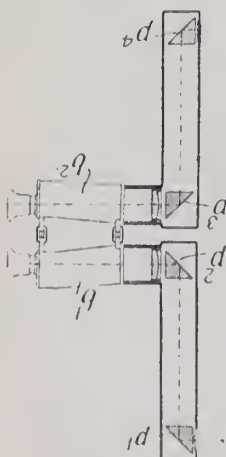

from behind cover in another position, a prismatic or other binocular *b*, *b'* carries at its objective ends two tubes, containing prisms *p*, *p'*, *p''*, *p'''*,

or equivalent mirrors. The ends of the prism tubes fit over the ends of the objectives and are held in position by friction. When in the position shown, the tubes give an increased stereoscopic effect, and when they are turned so as to be parallel to one another an observation may be taken from behind cover. The tubes may be detached and the binocular used in the ordinary manner.

**29,561.** LENSES. H. D. TAYLOR, Mount Villas, Yorkshire. Dec. 31.

To increase the amount of light transmitted by a lens system the loss of reflection is minimized by tarnishing the lens surfaces to a brownish slate tint, by immersion, in the case of the dense barium crown and flint glasses, in a dilute acid mixture of ammonium sulphide and nitric acid. An aqueous solution of sulphuretted hydrogen or sulphurous acid will also produce similar effects. The light-transmitting power of a lens of four surfaces treated in this manner is stated to be increased by about 11 per cent.

**29,567.** SMOKERS' COMBINATION ARTICLES. A. MYERS and L. MYERS, both of Birmingham. Dec. 31.

A combined stopper and cleaner for tobacco pipes is adapted for the pocket. The stopper consists of a disk *1* formed on the end of a tubular part *2*, while the cleaner consists of a blade or

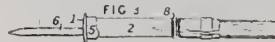

stem *6* which passes through a hole in the disk *1* and has a clip *5* or other suitable means for gripping and sliding on the part *2*. A bead *8* prevents the cleaner from being withdrawn out of engagement with the hole in the disk. The article may also serve as a pencil-point protector as shown in Fig. 3, as a pencil holder, and as a casing for a pocket pencil case.

Complete specifications accepted April 19, 1906.  
1905.

**13,731.** THREADING ATTACHMENT FOR STUDS. ALFORD & ALFORD.

**17,899.** BROOCH. WYNN.

**19,482.** HAIR-PIN DEVICE. JORDAN.

**24,752.** KEY-RING. CALVO.

1906.

**73.** WATCH BRACELET. JULES GRUMBACH-PICARD and RENE GRUMBACH.

**4,170.** CUFF-LINKS. OWEN.

**4,548.** HAIR-PIN. JEWELL.

**4,797.** HAT-FASTENER. LESSER.

Applications filed April 9 to April 14, 1906.

**8,575.** COLLAR-SUPPORT. O. G. GOODMAN, Birmingham.

**8,596.** NECKTIE-RETAINER. J. T. COPE, Birmingham.

**8,732.** POCKET-BOOKS, CARD-CASES, ETC. R. H. ANNISON, CHARLES HARPER and ELLA L. DALE, Gray's Inn, London.

**8,857.** FOUNTAIN-PEN. DUNCAN CAMERON, Birmingham.

**8,860.** CUFF-HOLDER. G. L. SCHEFFER, London. Complete specification.

**8,927.** COMB DECORATION. CHARLES JEFFREYS, Stepney, London.

**8,939.** NON-TARNISHABLE SILVER. S. O. COWPER-COLES, Westminster, London.

**8,998.** CIGAR CASE. S. J. DAVIS, Birmingham.

UNITED STATES TRADE-MARKS.

[The following trade-marks have been adjudged entitled to registration under the Act of Feb. 20, 1905, and are published by the Patent Office in compliance with Sec. 6, of said act, which provides: "Any person who believes he would be damaged by the registration of a mark may oppose the same by filing notice of opposition, stating the grounds therefor, in the Patent Office, within 30 days after the publication of the mark sought to be registered, which said notice of opposition shall be verified by the person filing the same before one of the officers mentioned in Sec. 2, of this act. If no notice of opposition is filed within said time the Commissioner shall issue a certificate of registration therefor, as hereinafter provided for."]

PUBLISHED MAY 8, 1906

SER. No. 3,254. STERLING SILVER HOLLOW

WARE, STERLING-SILVER FLAT WARE, AND STERLING-SILVER TOILET ARTICLES. R. WALLACE & SONS MFG. Co., Wallingford, Conn. Filed April 27, 1905.



A stag's head, heraldic roll, and the letters "R W & S."

SER. No. 4,138. BLADES FOR POCKET-KNIVES, RAZORS, TABLE-CUTLERY, ETC. A. BALDWIN & Co., LTD., New Orleans, La. Filed May 3, 1905.



The representation of an arrow spanned by the capital letters "I C K," with the letters "u r" and "e e n" above and below the shaft of the arrow, which together form the sentence "I Cut Keen."

SER. No. 6,568. SILVER-PLATED FLAT WARE, HOLLOW WARE AND TABLE WARE. Wm. A. ROGERS, LTD., New York. Filed May 25, 1905. Used 10 years.

EXTRA {COIN SILVER} PLATE

A pair of opposed braces. Arranged upon either side of the braces are the words "EXTRA" and "PLATE," and within the braces are the words "COIN SILVER."

SER. No. 10,168. WATCHES AND PARTS THEREOF. ADOLPHE SCHWOB, New York. Filed July 12, 1905. Used 10 years.

Tavannes Watch Co.

The name "TAVANNES WATCH Co."

SER. No. 10,170. WATCHES AND PARTS THEREOF. ADOLPHE SCHWOB, New York. Filed July 12, 1905. Used 10 years.

Bijou Watch Co.

The words "BIJOU WATCH Co."

SER. No. 12,042. SILVER HOLLOW WARE, FLAT WARE AND TABLE WARE. WILCOX & WAGONER Co., New York. Filed Aug. 26, 1905.



A circular wreath and upon it a conventional sword.

SER. No. 13,610. HAIR-PINS. GEORGE LITTLEFORD, Cincinnati, O. Filed Oct. 14, 1905.

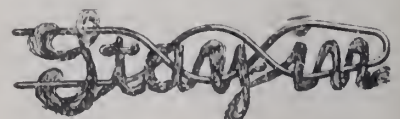

A representation of a twisted hair-pin having coiled about the limbs thereof the word "STAY-IN," said word being of script and formed of strands of hair.

SER. No. 17,389. ANTI-FRICTION METALS OR ALLOYS. MAGNOLIA METAL Co., New York. Filed Feb. 28, 1906. Used 10 years.

MAGNOLIA

The word "MAGNOLIA."

SER. No. 17,630. STERLING AND SOLID SIL-

AFER HOLLOW WARE, FLAT WARE AND TABLE WARE. GORHAM MFG. Co., Providence, R. I. Filed March 7, 1906. Used 10 years.

**GORHAM**

The word "GORHAM."

SER. NO. 17,903. CUT GLASS. RICHARD MURR, San Francisco, Cal. Filed March 15, 1906.

KOH-I-NOOR

The word "KOH-I-NOOR."

SER. NO. 18,393. MATERIAL FOR CLEANING AND POLISHING METAL, GLASS, MARBLE, AND THE LIKE. THE MATCHLESS METAL POLISH Co., New York and Chicago. Filed March 31, 1906. Used 10 years.



The words "CHAMPION BAR POLISH" appearing on a circular field.

TRADE-MARKS REGISTERED MAY 8, 1906.

52,301. METAL-POLISH. JAMES B. HILL, Los Angeles, Cal.

The words "METAL LIFE." Filed July 3, 1905. Serial No. 9,745. Published March 13, 1906.

52,306. CLOCK-MOVEMENTS. SCHLENKER & KENZLE, Schwenningen, Germany.

A representation of a wheel having 12 spokes, each of which spokes bears a number inclosed in a circle, such numbers running consecutively from "1" to "12," inclusive. At each side of said wheel is an extended wing. Used 10 years.

Filed June 29, 1905. Serial No. 9,390. Published March 13, 1906.

52,381. SPECTACLES AND EYEGLASSES AND THEIR MOUNTINGS AND PARTS. STEVENS & Co., Providence, R. I.

The letters "S Q." Filed Nov. 21, 1905. Serial No. 14,879. Published March 13, 1906.

52,411. STEEL AND PLATED PENS. C. HOWARD HUNT PEN Co., Camden, N. J.

The phrase "A PEN IS ONLY AS GOOD AS ITS POINT" which is shown inclosed in quotation marks.

Filed Jan. 16, 1906. Serial No. 16,221. Published March 13, 1906.

**A Correction.**

The article entitled "Ancient and Modern Jewelry Compared," which appeared in THE CIRCULAR-WEEKLY May 2, was copied from April issue of *Fabrics, Fancy Goods and Notions*, and was credited to that journal in our columns because it was published therein as an original article. We learn, however, that instead of this being original with *Fabrics, Fancy Goods and Notions* the article was written by Emil Freund and published in the *Manufacturing Jeweler*, Feb. 22, to which journal credit should properly have been given.

Charles H. Wyman, Colorado Springs, Colo., has consolidated the businesses which he carried on at 26 S. Tejon St., that city, and at his branch at Manitou, Colo., and will conduct both under one roof in his new and commodious quarters, 19 E. Pike's Peak Ave. He will hereafter carry a full line of jewelry, curios and art goods.

**Recent Publications.**

**SKIASCOPY WITHOUT THE USE OF DRUGS**, by R. M. LOCKWOOD. A practical treatise for the optometrist. Published by the Frederick Boger Pub. Co., New York. Bound in paper, 50 cents.

NO subject is so keenly interesting to the optometrist as skiascopy. No book has done more to simplify and make the test practical than the one under notice. In his usual lucid style and practical manner, Mr. Lockwood has put this subject within the reach of all, avoiding the complex and vague expressions that have heretofore proven a hindrance to the student.

Beginning with the origin and nature of the test, he leads, step by step, through the various methods of applying it. He shows when and why the test may be depended upon and when and why it is not trustworthy. The apparatus needed, the position, kind, and size of light, the size and kind of mirror required, the best size of sight-hole, are rationally discussed.

The reason for the shadow going "with" and "against" is explained. The way to avoid scotomata and the use to which the oftentimes annoying catoptric images may be put are points of value.

Other points made clear are: The nature and use of the schematic eye; methods of "fixing" the eye under test; the use of a second mirror as a finder; getting the sharpest reflex; the focus of the observer's eye; the nature and variations of reflexes; the size and edges of the ocular glow and what they mean; the qualitative method; the two principal meridians, their location and their neutral point; transpositions; checking up the findings; the effect of the skiascope; controlling the accommodation; holding the patient's attention; easy methods; the differential test; dynamic skiametry; outline skiascopy; the retino-skiameter; the ophthalmometer-scope, and the stigmatometer.

Following the discussion of the above mentioned topics are a number of illustrative cases that really illustrate. Thirty-eight illustrations are contained in the book.

Some of the author's own expressions show with what fairness of judgment and even tenor he treats his subject, hence we quote:

"Now, skiascopy has been held by those who use eyedrops to be valueless without previous paralysis of the ciliary muscle, but since the prospective patients are declining to permit the use of drugs, it therefore becomes necessary to either devise some method by which the art can be practiced without the drops, or else to give up the shadow test altogether.

"The work is not a résumé of what has already been done by others, but is to a considerable extent original in character, and has led to the following conclusion: Skiascopy without drugs is far more exact than skiascopy with drugs, but the practice of the art in the former case requires far more deftness, attention to detail and patience.

"As to the accuracy of the method, the author has always assumed that the subjective method is right, and that the objective method must be made to agree, if possible, and that when this agreement cannot be had it is due to the fact that the refraction, as determined by the skiascope is not along the same visual line as when the test types

are used, and that, therefore, there is some irregular condition present, which may or may not have a diagnostic importance."

Technicalities are avoided, and the test is herein boiled down to its very simplest, most understandable form, and affords one more incontrovertible proof that optometrists, and not medical practitioners, are the proper men to treat the subject of optometry.

**DOWNING'S UNITED STATES CUSTOMS TARIFF 1897.** Revised Jan. 1, 1906. Cloth, 16mo, 661 pages. Published by R. F. Downing & Co., New York. Price, \$2.

TO the importer in the jewelry and kindred trade there is no more valuable hand book published than this treatise on the present tariff law with its alphabetical list, giving the duty on every article that is covered by tariff, directly or indirectly, and the schedules or paragraphs under which such duty is levied. Although this is a hand book of the present tariff law passed in 1897, it has gone through three editions, and is now in its fourth, the list being revised up to Jan. 1 of this year. Among the features of the volume besides the full text of the customs law and the alphabetical arrangement of merchandise, with the rate of duty, etc., are the text of the French, Portuguese, German, Italian, Cuban and Swiss reciprocity treaties, the Customs Administration Act of 1890; the Pure Food Act of March, 1903; a list of parcels post countries; general shipping instructions and advice to tourists; rules for ascertaining duty; a list of the ports to which merchandise may be transported in bond, etc., while at the back are a number of tables such as the metric weights and measures; extension of pounds sterling into dollars and cents; the value of marks of Germany, and the Belgian, French and Swiss francs into dollars and cents, as well as Spanish pesetas, Grecian and Italian liras.

Altogether the volume contains information that will answer practically all the questions that will come before the importer in the ordinary course of his business.

**A Remarkable Collection of Freak Diamonds.**

A REMARKABLE collection of "freak diamonds" is now reposing at the Dore Gallery in blissful unconsciousness of the many thousands of curious and admiring eyes which will be privileged to gaze upon their beauties, says the *London Truth*.

The collector, a philanthropic diamond merchant, who prefers to remain unknown, has taken endless trouble in acquiring these rare and valuable gems, and will devote the proceeds to be accrued from their exhibition to building a home for poor girls in South London.

Quaint figures of men, birds, fishes, flowers, flags, daggers, swords, are all to be seen fashioned out of single stones. An almost perfect representation of the late Mr. Gladstone is seen in one gem; whilst to another the addition of a miniature tall hat in gray felt has admirably lent itself to the illusion of a head of John Bull. A "C. I. V." is depicted with the aid of a miniature khaki uniform to complete the *mise-en-scene*, whilst near him rests a diamond "Ally S'oper."

# WALTHAM WATCHES

---

We beg to announce the issuing of the following described 16 size movements:

16 SIZE,  $\frac{3}{4}$  PLATE, S. W. MOVEMENTS

LEVER SETTING.

OPEN FACE

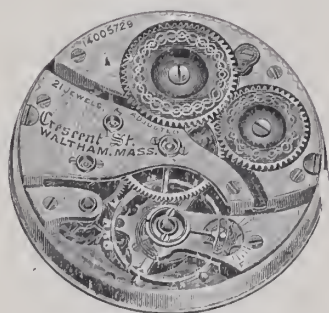

Crescent St., Nickel;

21 Fine Ruby Jewels; Raised Gold Settings; Jewel Pin Set without Shellac; Double Roller Escapement; Steel Escape Wheel; Exposed Sapphire Pallets; Compensating Balance, Adjusted to Temperature, Isochronism and Five Positions; Patent Breguet Hairspring, Hardened and Tempered in Form; Patent Micrometric Regulator; Tempered Steel Safety Barrel; Exposed Winding Wheels; Double Sunk Dial.

---

AMERICAN WALTHAM WATCH CO.,

WALTHAM, MASS.

# THE HOROLOGICAL REVIEW.



## How Father Knickerbocker Marks *the* Hours

Prominent Clocks That Give the Time to New Yorkers in Manhattan, Brooklyn and the Bronx.

(Continued from issue of May 9.)

CLOCKS SEEN FROM THE BROOKLYN BRIDGE.

SEEN from a distance, the beautiful lines of the slender spider-web structure of the bow that spans the East River from Manhattan to Brooklyn appears little able to safely carry its hundreds of thousands of

In the crowding of that Rubicon morning and evening during the "rush" hours, time is assuredly "the essence of the contract." And, whether the coursing of the underpaid clerk looking forward to a tongue lashing from the "boss" or the Wall St. broker vowing letters of anathema to the daily papers as he mentally views stacks of dol-

of the perturbed transitory throng than during the morning and evening "rush" hours over Brooklyn Bridge.

The bridge passenger's craving for exact knowledge of the hour, or, rather, the minute, is amply appeased by time dials of a dimension easily readable from the cars. On the north side at the Brooklyn end of the big span is Robert Gair & Co.'s large tower clock. Its 12-foot dial stares boldly out from the new queer looking factory at the foot of Washington St. The building, a modern monolith consisting of a mass of reinforced concrete, representing the very latest form of fireproof structure, is a thing of safety, perhaps, but assuredly not one of beauty. The timepiece, from its 125-foot



TIMEPIECE ON THE ROBERT GAIR CO.'S BUILDING.

toilers daily between the sister boroughs. But the actually capacious advantages imparted to the steel structure by the mechanical genius of its engineers is largely minimized by the incapacity of the transportation companies, into whose merciless care the question of passage has been given. In fact, at times the exasperating conditions reach a point sufficiently extreme to tempt the suspicion of an impish determination to harrow to breaking point the hearts of the traveling horde. As a magnified "bridge of sighs" the Brooklyn autotype buries by its magnificent horrors the Venetian structure into oblivion.



LARGE CLOCK OF THE EAGLE WAREHOUSE & STORAGE CO.

lars slipping away from his grasp through inability to get at the pile of telegrams and correspondence lying unopened on his desk, the vehemence of expletive is equally heartfelt. Hotter feeling would assuredly melt the metal bands that bind those two river banks.

And evenings the returning crowds, fagged with their mental or physical strain, lose more of their largely diminished vitality in renewed vituperation at the wasteful stops and lagging progress as they think of the spoiling dinner, steaming its odoriferous lusciousness on the air, and the good wife's patience oozing away with the waning freshness of the viands.

Never is time more closely concentrated in the human mind; nowhere the outdoor dials more eagerly scanned by all and each

elevation above the sidewalk, is at the most conspicuous position for reading.

On the south side of the bridge stands an old and faithful servant to the traveling public in the form of the big dial in the Eagle Warehouse Co.'s big edifice.

Passing over the bridge the skyline on its northern side is broken by the big clock in the tower of R. Hoe & Co.'s great factory on Grand St., whence issue those mammoth printing presses to stamp in lasting words, on the entire world's newspapers, the thoughts of men that revolutionize humanity and its civic methods. The Hoe dial, distinctly visible from the bridge, is too distant to decipher the position of the hands by the ordinary naked eye, but to one's left (on the south side) peers up from Manhattan's terra firma, as we cross the river,

Where  
Time is Money



Every-  
where

that accurate time is valued the Elgin Watch is needed. Every man who requires exact time in the execution of his business is a prospective customer for the dealer who carries

# ELGIN WATCHES

Every Elgin Watch is fully guaranteed against original defect, insuring satisfaction to both buyer and seller.

See Jobber's list for prices, or write the Company.

Every dealer is invited to send for the Elgin Art Booklet, "Timemakers and Timekeepers," illustrating the history and development of the watch.

## ELGIN NATIONAL WATCH CO.

Factories, ELGIN, Illinois, U. S. A.  
General Offices, 131 Wabash Ave., Chicago.

NEW YORK OFFICE,  
11 John St.

SAN FRANCISCO OFFICE,  
206 Kearny St.

Where  
Time is Life



the *Police Gazette's* characteristic clock, which was installed in its unique structure, the Fox building, many years ago, by the Ansonia Clock Co.

As proof of the powerful claims these public time serving elements have on humanity a recent incident is worth relating. The editor of that well-known sporting paper wrote *THE CIRCULAR-WEEKLY*, a few days ago, that, upon the accidental stoppage for one day of the *Police Gazette* clock, his journal was simply inundated with telegrams, letters and postal cards inquiring why the mechanism had gone out of commission

even thumbpiece, and, with its glazed face, forms an attraction which none could pass without notice. The idea originated in the

formation expressed by numerous sidewalk clocks, such as C. Jackles', which has kept time near 53d St. since 1885. Lambert's



R. HOE & CO.'S CLOCK, GRAND AND SHERIFF STS.

and asking information as to when its useful functions would again be available to the public.

CLOCKS SEEN FROM THIRD AVE. "L."

After crossing the bridge, should we continue up Park Row and the Bowery, we will pass hosts of sidewalk clocks and window timepieces, which serve to recall the fact that this was once New York's great retail jewelry district. No tower clock of any importance, however, strikes our eye until we reach the entrance to Third Ave., there to gaze on one of New York's most noted and useful landmarks.

In the venerable pile of Cooper Institute is located a clock facing south on the Bowery's changing population. Calling to study and civic discussion, this dial has timed for many years the entry of studious hundreds of thousands by day, and by night has called forth congregations to crowd its halls for political harangues of the reformer and to listen to didactic art and science lectures.

Something strictly unique in outdoor timepieces is seen in front of 151 E. 14th St., near Third Ave. It is an exact reproduction on a leviathan scale of an 18 size railroad watch, so close a fac-simile as to contain in its makeup winder, stem, joint,



THE WELL KNOWN CLOCK ON THE FOX BUILDING, OVERLOOKING BROOKLYN BRIDGE.

brain of Charles A. Keene, about six years ago, when he placed it in front of his Fulton St. store. On moving to his present

large four-faced clock, of more elaborate design, at the corner of 58th St., has been a landmark for the past 18 years, and F.



COOPER INSTITUTE CLOCK AT JUNCTION OF THIRD AND FOURTH AVES.

Broadway quarters he sold the peculiar timepiece to its present owner.

And this brings one well into Third Ave., with its wholesome love of free timely in-

Beinhauer's, near 61st St., comes next. This nearly brings one to the Third Ave. R.R. Co.'s car stables at 67th St., with the anomalous three time dials, one above the other,

==  
 A NEW  
 AMERICAN  
 MADE  
 MOVEMENT  
 ==

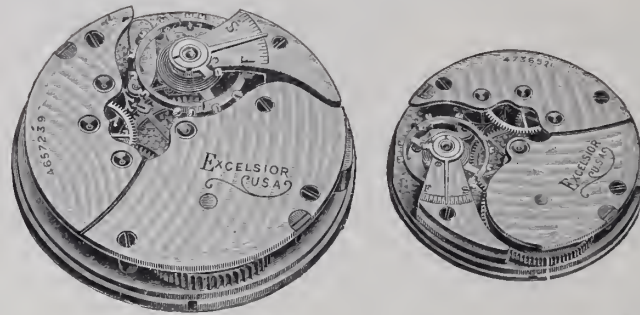

==  
 MADE FOR THE  
 JEWELRY  
 TRADE  
 ONLY  
 ==

# “THE EXCELSIOR”

in 18 and 6 Size— $\frac{3}{4}$  Plate

A New Price-Protected Thin Model  
 for Hunting or Open Face

18 Size—Hunting—Lever Set  
 18 Size—Open Face—Pendant Set  
 6 Size—Hunting and O. F.—Pendant Set

Nickel Damaskeened or Gilt, 7 Jewels, Cut Expansion Balance,  
 Breguet Hair Spring, Stem Wind, White Enameled Dial

Give the “EXCELSIOR” a Trial

SECURE CONFIDENTIAL LIST FROM YOUR JOBBER



# Are You Securing Your Share of "Betsy Ross" Sales?



## BETSY ROSS Territory

The Betsy Ross Memorial Association has 957,922 members. Here is where they live. Most of them will buy the Betsy Ross Watch if you let them know about it. Isn't this a substantial nucleus of trade?

### Six New England States

Massachusetts, 60,570	New Hampshire, 3,480	
Rhode Island, 17,070	Maine, 2,520	
Connecticut, 16,850	Vermont, 1,290	
		<b>101,280</b>

### Four Middle States

Pennsylvania, 295,080	New Jersey, 97,110	
New York, 210,780	Delaware, 4,830	
		<b>607,800</b>

### Eleven Southern States

Maryland, 23,040	North Carolina, 600	
West Virginia, 1,620	Texas, 570	
Virginia, 1,560	South Carolina, 300	
Louisiana, 1,500	Alabama, 270	
Florida, 750	Mississippi, 90	
Georgia, 690		
		<b>30,990</b>

### Twenty-four Western States

Ohio, 28,800	Oregon, 1,890	
Illinois, 19,590	Kansas, 1,740	
Indiana, 9,630	Utah, 1,170	
Missouri, 8,190	Tennessee, 1,080	
California, 7,800	Washington, 930	
Wisconsin, 6,960	North Dakota, 870	
Michigan, 6,060	Montana, 570	
Kentucky, 3,300	South Dakota, 330	
Minnesota, 3,090	Arkansas, 300	
Iowa, 2,940	Idaho, 210	
Nebraska, 2,760	Nevada, 180	
Colorado, 2,190	Wyoming, 60	
		<b>110,640</b>

### Territories and Colonies

New Mexico, 480	Oklahoma, 60	
Hawaii, 330	Ladrone Islands, 60	
Philippine Islands, 210	Indian Territory, 30	
Alaska, 120	Porto Rico, 30	
Arizona, 60		
		<b>1,380</b>

District of Columbia, 8,280	
U. S. Navy, 330	
<b>8,610</b>	

### Foreign Countries

Canada, 180	Scotland, 30	
France, 150	South Africa, 30	
England, 120	Italy, 30	
Greece, 90	Germany, 30	
Rep. of Colombia, 60	China, 30	
Cuba, 60	Costa Rica, 30	
Australia, 60	Mexico, 30	
Nova Scotia, 30		
		<b>960</b>

In club form, 866,220	
In miscellaneous form, 91,702	
Grand total, 957,922	

## All Territory is "Betsy Ross" Territory

**EVERYWHERE;** you will find members of that Patriotic Society, The Betsy Ross Association. All are interested in its work and objects, and anything of a sentimental and historical nature will find favor with them. In memory of Betsy Ross, the maker of our First National Flag, we created

# Betsy Ross Watches



They are better value for the money than any other O size watch.

Hunting or Open Face, 7 Jewels, Jas. Boss 20 Year Case, Pendant Set, Nickel Movement.

We have a very interesting folder—in colors—illustrating the Betsy Ross Watch and telling how and where she made the first American flag. We print your name on them and furnish free as many as you can use. Send your business card.

## The Keystone Watch Case Co.

PHILADELPHIA

New York  
Chicago

Cincinnati  
San Francisco

## STEADY DEMAND FOR WATCHES.

**W**HILE THE DEMAND for most articles fluctuates more or less with varying seasons, the WATCH suffers less from these changes than other products. This is because it is less an article of luxury than of utility; it may be classified among the "necessities." Time is observed in Summer as in Winter; in social engagements as in business; by the tourist as by the stay-at-home.

Whatever the season or the object, these Offices are fountainheads for the supply of Watch demands.

### J. W. FORSINGER,

LEADING AMERICAN WATCHES AND MOVEMENTS

CHICAGO  
103 STATE ST.

NEW YORK  
2 MAIDEN LANE

### Sessions Clocks

Superior finish. Reasonable prices.

Have you seen our

**New and Exclusive Designs**  
in Mantel and Hanging Clocks?

Write for Catalog and supplement.

**The Sessions Clock Co.**

Main Office and Factories,  
Forestville, Connecticut, U. S. A.

New York Salesrooms,  
37 Maiden Lane.



WHOLESALE

## DUEBER-HAMPDEN COMPLETE WATCHES

The conceded friend makers for the retail dealer. We are certain that we can help you make customers if you will write us for prices on Chains, Rings and all kinds of High-Grade Jewelry.

**WM. C. PENFOLD CO.**

WHOLESALE JEWELERS

AND AGENTS FOR DUEBER-HAMPDEN WATCHES

818-820 Chestnut St., Philadelphia, Pa.

the two upper dials being bare of hands.

Taking the elevated railroad, it brings the traveler uptown in full sight of the handsome clock in its elevated tower of the Ehret Brewery, at 92d St. Continuing one's trip through Harlem, passing the clocks in front of the stores of William Koontz, at 114th St. and E. Laubheim, at

**Horological Notes.**

**A** PAMPHLET describing the "Pheils Universal Time Indicator," with drawings and specifications, has just been issued. It is claimed for the apparatus therein described that by showing the longitude and time of every place at a glance, this time indicator simplifies the study of these subjects. It cannot be gainsaid that popular information on this subject is scant, and a great want for educational purposes has been supplied by this invention. Hitherto only mariners, surveyors of geodetic measurement and college graduates have had the full grasp of this subject and the want of knowledge among the traveling public has been shown to great disadvantage and all explanatory publications with illustrations ought to have a wide and unlimited circulation. The only defect which can be rem-

structure is surmounted by the German eagle. Herr Woszner used no machinery all the carvings having been done by hand.

Clockmakers were highly honored in past ages, says the *New York Press*. Tompion, the "father of English clockmaking," and Graham, the watchmaker, were buried in the same grave in the nave of Westminster Abbey. A marble slab bore this in-



WATCH-SHAPED CLOCK, 14TH ST., NEAR THIRD AVE.

125th St., the traveler passes over the Harlem River and comes in sight of the big clock in the square tower of Estey Piano Co.'s factory, at 135th St. and Lincoln Ave.

Another important clock in the Bronx,



ESTEY CLOCK AT 135TH ST.

which may be seen from the "L" station at 161st St., is that in the hardware factory of William Keil & Son, at 162d St., near Melrose Ave. Situated in a square tower, the four dials of the timepiece are to be seen for many blocks to the north, east, south and west, and for years it has given the hour to the residents of Melrose and West Morrisania.

(To be continued.)



CLOCK TOWER ON EHRET'S BREWERY.

edied is the supplying of equation of time tables as solar time *only* is not sufficiently exact.

A wonderful clock has been finished, according to the "Landindustrie," by a clockmaker named Woszner at St. George, in the Black Forest. This timepiece, which was completed after 18 months' labor, is adorned with various artistic and elaborate carvings in wood. The dial is supported on either side by two allegorical figures representing angels, 16 inches high, holding the arms of the grand duchy of Baden. One of the angels strikes a gong every five minutes. Between these statuettes there are moving figures of a lion in mortal combat with a serpent. The dial is crowned by a moving figure of St. George, which slays the dragon every time the clock strikes the full hour. The whole



LAMBERT BROS.' STREET CLOCK.

scription: "Here lies ye body of Thomas Tompion, who died November 20, 1713, aged 75. Also Geo. Graham, Watchmaker and F. R. S., whose curious inventions do honor to ye British genius, whose accurate performances are ye standard of Mechanic



FOUR-DIAL TOWER CLOCK ON KEIL'S FACTORY, 163D ST., NEAR MELROSE AVE.

Skill. He died ye 16th of November, 1751, in ye 78th year of his age." This slab was removed in 1838 and a small lozenge of marble inscribed "Tompion 1713" and "Graham 1751," was substituted.

For *BEAUTY* of *DESIGN*, *PERFECTION* of *FINISH* and *RELIABILITY* Combined with *Moderate Price*

# TRENTON WATCHES ARE UNEQUALLED



No. 140. Bridge Model, 16 Size, 15 Jewel, Hunting and Open-Face, Pendant Setting.

A sample line is convincing. They are pendant setting in all sizes, fitting regular pendant setting cases, decorated dials and Louis XV hands.

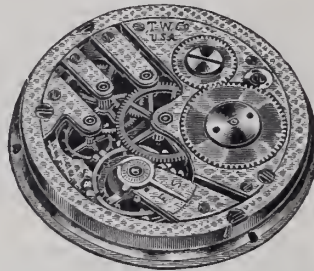

No. 320. Bridge Model, 12 Size, 7 Jewel, Hunting and Open-Face, Pendant Setting.



No. 100. Bridge Model, 0 Size, 7 Jewel, Hunting and Open-Face, Pendant Setting.

A NEAT SIGN OR ADVERTISING BOOKLET FOR THE ASKING

JOBBER SELL TRENTONS.

PRICE LIST ON APPLICATION.

Manufactured and Guaranteed by **Trenton Watch Co., - Trenton, New Jersey.**

IF IT'S A

# ROY

TRADE MARK  
IT'S STANDARD



O Size Bassine Engraved Cases, made from assayed Gold, quality as stamped.

**ROY WATCH CASE COMPANY,**



21-23 Maiden Lane, NEW YORK.

SAN FRANCISCO. LONDON, ENG.

## SETH THOMAS CLOCK COMPANY.

Established 1813.

### VISTA.

Burnished Gold and Bronze Finish, with Gold Panel. Height, 12 3/4 inches.



8 Day.  
Half Hour Strike. Cathedral Bell. 4 1/2-inch Porcelain Dial.

List, \$15.00.

**SETH THOMAS CLOCK COMPANY,**

51 Maiden Lane, New York.

70 Wabash Avenue, Chicago.

## Watch Repairing.

By H. REINECKE.

(Continued from issue of May 2.)

THE isochronous adjustment for the long and short vibration of the balance is made, as a rule, in the condition of the balance spring, and as the temperature adjustment is made by a specially constructed balance and by changing its center of gyration the mode of adjusting the two can only be harmonized by the use of the fusee and the application of it again becomes a necessity in chronometers and watches of a high grade.

This digression leads to the consideration of the utility of stopworks in watches with the going barrel, of which a number of different styles have been invented, but of



PUNCHING PLIERS.

which the maltese stopwork is the principal survivor. The original object of this and other stopworks by the leading French horologists in the 18th century was to limit the use of some of the coils of the main spring in the going barrel to those which were more equal in tension and free from coil friction, and in this manner to obviate the use of the fusee. The maltese stopwork was probably retained, as it seemed best adapted to the other use of preventing the over winding of the main spring. In this capacity it is at present much used by the Swiss in the manufacture of cylinder watches. In cheap and machine-made watches with the lever escapements it has largely been abandoned.

As the watch repairers meet it almost daily, a few remarks regarding it may be in order. The star wheel, or maltese cross,

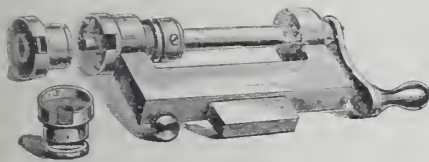

A WATCHMAKER'S WINDING BARREL.

revolves with the main spring barrel four times. Each time it passes a finger fixed to the barrel arbor, passes into and out of a slit. At the beginning of the fifth revolution the finger, owing to the form of the star wheel, stops it. The finger should be somewhat longer than the circular part of the star wheel that acts as a stop, which should be of a sensibly larger radius than the rest of the wheel. The finger should be of proper width so that the neck may be left of sufficient strength without coming in contact with the corners of the spaces as the finger enters and passes out.

The screw should be cut with a fine thread and should have a head as large as the star will allow. The employment of the maltese stopworks is often objected to on account of the room needed for accommodating them, and while a cylinder watch is probably better with such a stopwork, a

lever watch does just as well without it, and the increased room is better employed by increasing the motive power, particularly in low-priced watches. Besides the stopwork there are three other points connected with the subject of the main spring, namely, the hook, the punch and the winder.

Hooks are of two kinds; one for the barrel of the fusee watch and one for the going barrel watch. The hooks for the attachment in the former are riveted to the main spring in a round hole and the hook is made of a rectangular square piece of steel of a thickness about one-third of the width of the main spring and about twice as broad or nearly so. The end faces for forming the hook are filed at an angle of about 15 degrees.

The hook for attachment in the case of the latter (the going barrel) is a round stud screwed into the side of the barrel from the inside, the end being finished to the proper shape before the pin is removed from the screw plate. The outer waste end may be used for a holder. The hook should not project in the inside of the barrel much more than the thickness of the spring and its width should not exceed the width of the oblong hole punched in the end of the spring by the punching pliers.

A round hole in the end of the spring, allowing its attachment to the work, is apt to break out very easily. In softening the extreme end of the spring not more should be heated than is absolutely necessary. The end of the spring is apt to break or bend in a knee when the barrel is not properly filled by the diameter of the barrel arbor and the coiled up spring. In replacing a broken spring in the barrel the proper tool should be used and the one here shown is to be recommended. It is certainly much preferable to the old pattern, in which the spring is coiled up between the fingers, whereby the fingers are often injured and the spring receives the cause of a future break, of being kinked and roughly handled.

This winder consists of a barrel with a slit in the side, as shown, and a false bottom, which may be pushed forward to eject the spring from the winder into the barrel. There are several winding barrels of different sizes to cover the whole range of watch barrels usually met with.

(To be continued.)

E. A. Collburn, who is soliciting subscriptions for a town clock to be placed in the court house tower in McPherson, Kans., reports that over \$800 has already been given. Many of the signers have promised \$50 and \$25 subscriptions and none less than \$5. Mr. Collburn expects to raise \$1,000 in large subscriptions and will then turn the work over to the City Federation of Woman's Clubs, which will complete the canvass.

Paul Wiggins, something of a clock collector, has a novel timepiece in his home which is quite accurate, though antique and clumsy. It is a metal cup with a small hole in the bottom—that and nothing more. It holds about a quart. Wiggins empties it and sets it upon the surface of a tubful of water, where it gradually fills and sinks. The hole in the bottom is of a size to admit just enough water to accomplish the submersion in exactly one hour.

## America's First Town Clock.

AN old clock that has done duty in Guilford, Conn., for more than a century, and has been recuperating in a belfry for nearly a hundred years since, is to be brought out for exhibition in a few days to testify that Guilford was the first town in the United States to own a town clock, says the *New York Sun*.

The little town was founded by the Rev. Henry Whitfield in the Fall of 1639. He was a clergyman of the Church of England and came to this country for more religious liberty. He hadn't been here long before the First Church was founded. The society is still in existence.

The members of his flock met with him at his home here, which is now the State Historical Museum. In 1643 the first church building was erected on the Guilford Green and stood until early in 1700 when a new edifice was put up to replace the old building, torn down.

Just as soon as the new church was finished members of the congregation began to make plans for a bell. The bell was secured, but then a steeple had to be built to put it in.

In 1726 the steeple was completed, but the church tower looked lonely to the Guilfordites without a clock. At a meeting of the church officers it was voted that the town must have a clock.

There was no such thing as a town clock in the Colonies. Ebenezer Parmelee was the mechanical genius of Guilford, and the church called upon him to see what he could do in the clock line.

After considerable experiment Parmelee turned out the clock which has since borne his name and which made him famous in the Colony. It is a big, cumbersome affair, made entirely of wood. It was wound by means of a big crank, which the sexton of the church had to operate every Monday morning.

Dials were placed on the four sides of the steeple and this town had the only town clock in the country and the only tower and bell in the Colony.

Whenever the clock got out of order Parmelee was called upon by the church committee to repair it. After some years of labor of this kind his services as clock tinker were rewarded by the citizens of this place, who voted on Dec. 15, 1741, to free him from services in town offices so long as he continued to keep the clock ticking. The old clock did service until a new one replaced it in 1830.

Amid the cobwebs and owls it was left neglected and forgotten for years. Then somebody asked what had become of the old timepiece and searching parties found it, covered with the dust of a century, in the church tower. With it were the weights, composed of barrels of stones, that had been used for many years to run it.

The townspeople then wanted the old timepiece taken down and given a place of honor among the relics of this place, but the church society was unwilling to relinquish it entirely. Recently it was voted at a church meeting to lend the clock to the local historical society, and in a few weeks it will take its final journey to the old Whitfield house, now the village museum.

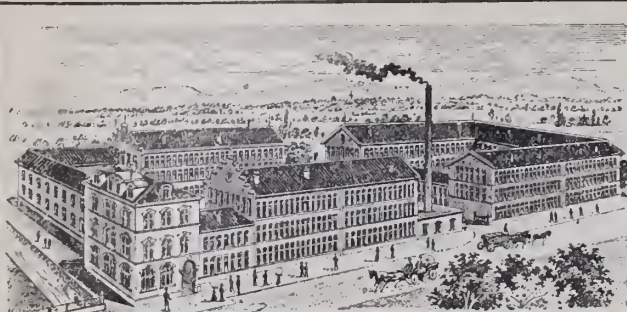

This illustration shows our main factory exactly as it exists, where 3,000 complete watches are made daily.

# LANGENDORF WATCH CO.

CHAUX-DE-FONDS, SWITZERLAND.

It will be of great interest to every jeweler to learn that we are devoting our full attention to this market. The existing conditions in the watch trade have convinced us that there is a long felt want for moderate priced, but accurate Swiss Watches.

We wish to call your attention to our LONVILLE MOVEMENT. It has a lever escapement and is being made in Os, 12s and 16s, fitting perfectly all American cases. This movement is salable and profitable. Our Watches and Movements will be introduced in this market bearing the following names:

- |          |          |
|----------|----------|
| SOLDALE  | HIGHMERE |
| BONDALE  | LONVILLE |
| CLAREFAX | NAMTOC   |
| PEARLHAM | LADY MAY |

SOLE AGENTS FOR UNITED STATES.

**BYRON L. STRASBURGER & CO.,**  
17 Maiden Lane, New York, N. Y.

## SECURE Your Agency NOW!

One in each locality. For the Unexcelled

## NARDIN WATCHES and CHRONOMETERS.

Plain and Complicated Watches in all Grades.

General Agent

**R. NEWBURGH,**

12-16 John Street,

NEW YORK.

## 46 out of 99 PRIZES

were awarded to

## PATEK, PHILIPPE & CO.

In the Timing Contest of the Astronomical Observatory in Geneva, for the year 1905, comprising: The only First Unique Prize for Best Average Running; 2 First Prizes out of 3; 5 Second Prizes out of 10; 8 Third Prizes out of 18; 9 Fourth Prizes out of 24; 10 Honorable Mentions out of 23; 11 Simple Mentions out of 21. 11 Manufacturers participated.

68 NASSAU ST., NEW YORK.

GENEVA, SWITZERLAND.

**JULES JÜRGENSEN**  
Watches and Chronometers

PARIS "THE GRAND PRIX" - 1900

SOLE  
RUDOLPH & SNEDEKER,  
65 Nassau St., New York  
AGENTS

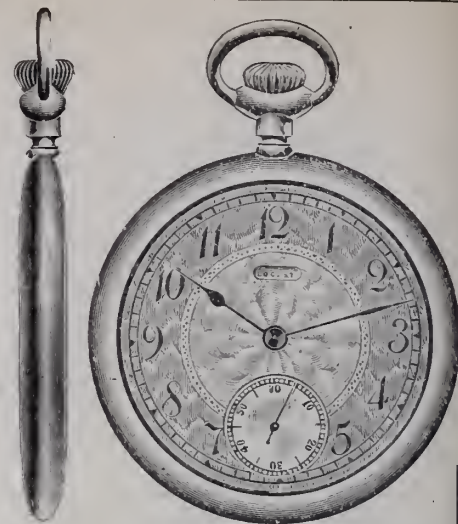

Actual Size.

# LOCUST

Extra Thin Model,

SEVEN JEWEL,  
LEVER,  
PENDANT SET,

CASED IN

## Bassine 30 Year Filled

Screw Back and Bezel,  
also in  
Silver, Gun Metal  
and  
Solid Nickel Case.

BEST VALUE EVER OFFERED.

TRY THEM.

WE GUARANTEE EVERY  
LOCUST WATCH.

All Parts Interchangeable.  
Finished Material Always on Hand.

IF YOUR JOBBER CANNOT  
SUPPLY YOU,  
WRITE US.

**Hipp. Didisheim & Bro.,**

49 Maiden Lane,  
New York.

Chicago Office, - Columbus Bldg.



# ZENITH

## MOVEMENTS

Give the

**RIGHT TIME  
EVERY TIME**

For a **LIFE TIME**

**Grand Prize, Paris Exposition, 1900**

Made in O size, 12 size, 16 size, all grades

Hunting or Open Face, Pendant Set

INTRODUCED FOR THE FIRST TIME IN AMERICA, THOUGH ONE OF THE BEST KNOWN WATCHES IN EUROPE FOR GENERATIONS

Manufactured by

**GEORGES FAVRE-JACOT & CO., Locle, Switzerland**

HIPP. DIDISHEIM & BRO., Sole Agents, 49 MAIDEN LANE, NEW YORK.  
COLUMBUS BUILDING, CHICAGO.

# OMEGA

MOVEMENTS ARE FINE TIME PIECES.

All made with Lever Escapements and Double Roller.  
Pendant Set. Fitting American Cases.

**Made in 6 Different Grades.**

10 LIGNE. 11 LIGNE. 0 SIZE. 12 SIZE. 16 SIZE.

From 7 Jewels to 21 Jewels,  
Adjusted to heat and cold and 5 positions.

*Why is it so many watch movements are sold under the plea that they are just as good as the Omega? There must be a reason.*

PRICES NOT ADVERTISED IN ANY JOURNAL.

SELLING AGENTS:

**EDMOND E. ROBERT, CROSS & BEGUELIN,**

3 MAIDEN LANE,  
NEW YORK.

17 MAIDEN LANE,  
NEW YORK.



A Trial will convince you of their merits. Send for price list.

# Koshland & Italic Co.

702 Chestnut Street, PHILADELPHIA, PA.

## FAHYS FILLED CASES.

We handle exclusively

Fahys Permanent  
Guaranteed Permanently.

Fahys Montauk  
Guaranteed 20 years.

Brooklyn Bristol  
Guaranteed 25 Years.

Brooklyn Windsor  
Guaranteed 20 years.

SEND FOR SELECTION PACKAGE.



### C. L. Guinand Split Chronographs with Minute Registers

**The Turfman's Standard.**

Remarkable for accuracy and reliability. Are cased in Gun Metal, Silver filled and Gold. Prices reasonable.

Imported exclusively by

### Jules Racine & Co.,

Importers of all grades of Watches and Movements.

103 State Street, Chicago. 37 Maiden Lane, New York.

Established 1855.

# ADAMS & SINGLETON,

Successors to BROOKS & PIKE,

Manufacturers of

## Fine Diamond Mountings.

Special Attention Given to Order Work.

364 Washington Street, Boston, Mass.

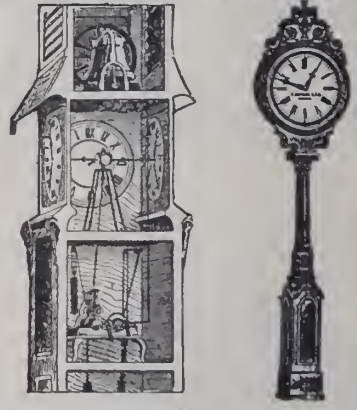

MAKERS OF

## Tower and Street Clocks

For particulars write us, mentioning The Jewelers' Circular-Weekly  
E. HOWARD CLOCK CO.,  
EST. 1842. BOSTON, MASS., U. S. A.

## DESIGNS For Silverware, Novelties and Jewelry . . . FINE ETCHING

Even if you have your own designer, don't you think it a good policy to use an "outside" idea once in a while? Try one of ours.  
CHARLES M. PRIOR (PHONE 1224 HARLEM) 1683 Madison Ave., New York

## Expert WATCH and Chronometer REPAIRING FOR THE TRADE.

When others fail you we guarantee satisfaction. A trial will convince. Prices very reasonable.  
List will be sent on request.  
G. OHAN, 37-39 Maiden Lane, Lorsch Bldg., Room 27. NEW YORK.

# Rockford Watches Speak for Themselves.



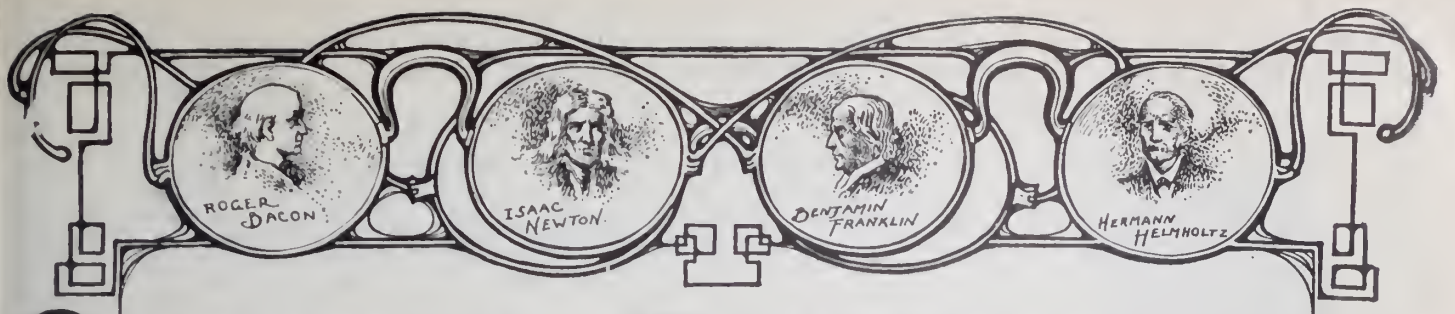

# OPTICAL DEPARTMENT

## The Optometrist's Catechism.

A SERIES OF QUESTIONS AND ANSWERS ON ELEMENTARY OPTICS, IN CATECHETICAL FORM.

By E. Le Roy Ryer.

Copyright, 1903, by THE JEWELERS' CIRCULAR PUBLISHING CO.

(Continued from issue of April 11, 1906.)

Q.—(650) How may we find the position and size of the image of an object formed by a convex spherical lens?

A.—Let AB, Fig. 79, represent the object. Let A be a point not situated upon the principal axis. Starting from A, draw the line ANA', passing without deviation through the nodal point or optic center, N,

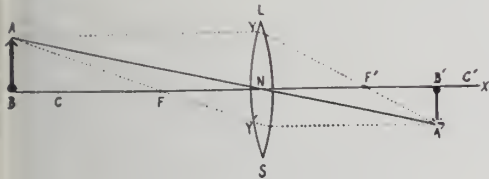

FIG. 79.

of the convex spherical lens, LS. Another ray, AL, parallel to the principal axis, BX, will necessarily pass, after refraction, through F', the principal focus. The point, A', where these two rays, AA', and YA', intersect, is the image of A. Having this point, we need only erect upon the principal axis the perpendicular A'B', and A'B' is the image of AB. The above is an example of how the image is formed when the object is beyond the principal focus F, and the center of curvature C, in which case, as

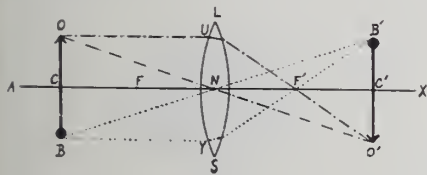

FIG. 80.

will be seen by reference to Fig. 79, the image A'B', is smaller than the object AB, and is inverted and real. The position of the object in relation to the lens will, however, determine the size and position of the image.

Thus Fig. 80 represents the object, OB, at the center of curvature, C, of the convex spherical lens, LS; to find its image, draw the secondary axis, ONO', from O, which

is the line passing undeviated from A through the nodal point or optic center, N, of the lens; then draw OU, representing a

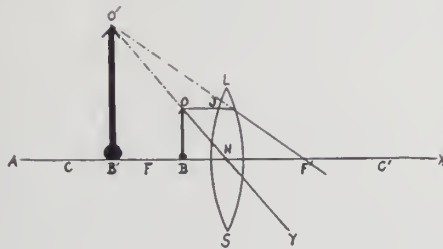

FIG. 81.

ray from O parallel to the principal axis, AX, which will necessarily pass, after refraction, through the principal focus, F'.

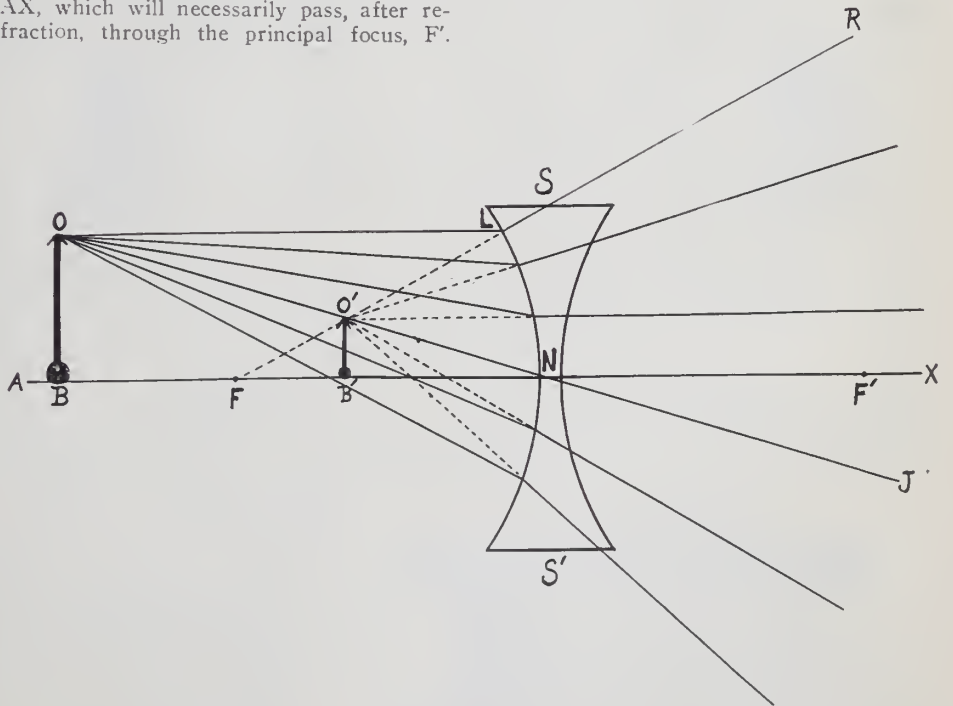

FIG. 82.

This line or ray, UF'O', intersects the secondary axis, ONO', at O' and thus O' is the image of the point, O. By similar construc-

tion B' will be found to be the image of the point B, and all intermediate points would be located in a similar manner, and the image of OB found to be located at O'B'. This image will be exactly the same size as the object, and will be real and inverted.

The third example, Fig. 81, shows the object, OB, situated inside of the principal focus, F; that is, between the principal focus and the lens. To find its image, draw from O the ray ONY, passing through the nodal point or optic axis, N, of the convex lens, LS; from O also draw the ray, OJ, parallel to the principal axis, AX, which, after refraction, must necessarily pass through the principal focus, F'. As these two rays are divergent, they can only be made to intersect by projecting them backward toward O', which point is the image of O. This point is, of course, negative. Having this point, we only need erect the perpendicular to the principal axis, AX, to have the image O'B' of the object, OB. This image will be larger than the object and will be erect and virtual.

Should the object be placed at the principal focus, no image will be formed what-

ever, the refracted rays forming merely a parallel series of rays or a beam of light.

Q.—(651) What relations exist between

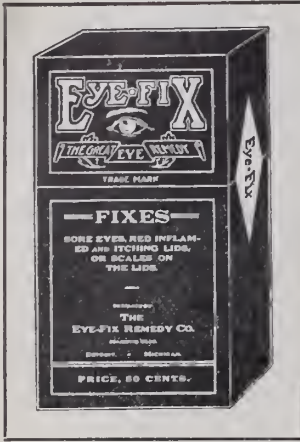

# HAVE You Signed the EYE-FIX Contract?

**W**E have adopted the Serial Number Price Restriction Plan, and are now sending contracts to all opticians and druggists in the United States. This contract stipulates that EYE-FIX shall not be retailed for less than 50 cents. As the cost to dealers is \$3.60 per dozen, you can readily see that the

**Retail Profit is 66<sup>2</sup>/<sub>3</sub> per cent.**

The demand for EYE-FIX is steadily increasing, and there is no proprietary article in the market that can be handled with more confidence and satisfaction.

Opticians will find EYE-FIX a valuable aid in preparing the eyes for a proper measurement for glasses. It is an effective tonic and antiseptic—absolutely harmless and non-irritant—and does not dilate the pupil. As a safe and sure cure for eye trouble of every nature, EYE-FIX has no equal. Dealers can recommend it to do all that is claimed for it. **Every package contains a tube of EYE-FIX SALVE, as well as a bottle of liquid.**

*Samples and further particulars will be furnished the trade upon request.*

**THE EYE-FIX REMEDY COMPANY**

**DETROIT, MICHIGAN**

DEPARTMENT NO. 17.

## The Thimble House.



No. 149.

Thimbles are not a side line with us—They are our main business. We study Thimbles, our designers study thimbles, our workmen study thimbles—The result is the finest and largest line of Thimbles on the Market.



No. 136.

**KETCHAM & McDOUGALL,**

Manufacturers,

37 @ 39 Maiden Lane, New York.

Send for Catalogue.

Established 1832.

ALSO MAKERS OF THE NEW AUTOMATIC EYE-GLASS HOLDERS.



## ELLIS & CO.

Plated goods on copper with sterling silver mounts.

Rolled plated goods, Trays, Waiters, etc.

10 Holborn Viaduct, London.  
Hall St., Birmingham, England.

## CRANBERRY LAKE REGION OF THE ADIRONDACK MOUNTAINS

a section full of large fish is described in New York Central Lines Four-Track Series No. 32, which contains a beautiful map of this region printed in four colors. Copy will be sent free, postpaid, on receipt of a two-cent stamp by George H. Daniels, Manager, General Advertising Department, Room 61-A, Grand Central Station, New York.

THE



TAKE YOU TO THIS REGION FROM EVERY DIRECTION

C. F. DALY  
Passenger Traffic Mgr.  
NEW YORK

W. J. LYNCH  
Passenger Traffic Mgr.  
CHICAGO

**JACOB BASCHKOPF, DIAMOND SETTER, LETTER AND MONOGRAM ENGRAVER,**

9-13 MAIDEN LANE,

Room 701  
Jewelers' Bldg.

NEW YORK.

**Optical Department.**

the object and image, regarding relative sizes and positions? In other words, if it be known at what distances the object and image are from the lens, can their relative sizes be estimated?

A.—Yes; for the size of the image created by a convex spherical lens is, to the size of the object, as their distances from the optical center of the lens are to each other. For example, if it were found that the object was 40 inches away from the optic center of the lens, and the image

istics of the image formed by a concave spherical lens?

A.—The image is always on the same side of the lens as the object, and is therefore always a virtual image. The refracted rays, always being more divergent than the incident, as if they came from a nearer object, cause the image, in all cases, to appear smaller.

Q.—(654) How may the above mentioned magnifying and minifying properties of the convex and concave spherical lens be illustrated experimentally?

A.—Figs. 83 and 84 represent this. In Fig. 83, O represents an object to be looked

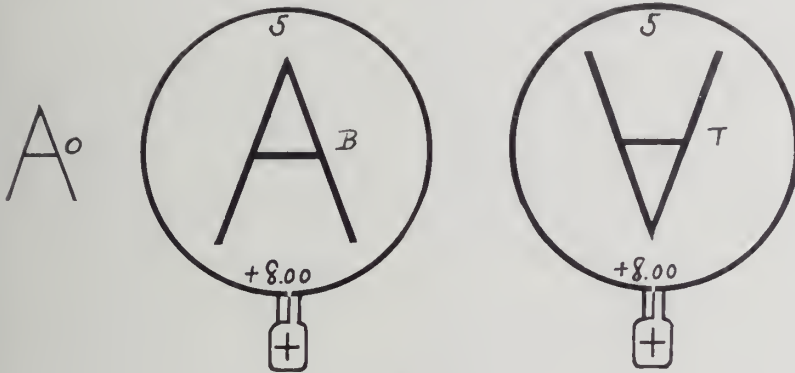

FIG. 83.

was 20 inches away, then the image would be just half the size of the object.

Q.—(652) How may we find the position and size of the image of an object, formed by a concave spherical lens?

A.—Fig. 82 shows how an image is constructed by a concave spherical lens. OB represents the object, perpendicular to the principal axis of the double concave spherical lens, SS'; the ray, ONJ, passes through the lens without deviation, inasmuch as it is a secondary axis passing through the

at. When the + 8.00 D. convex spherical lens is held nearer to the object than the focal length of the lens (in this case, inside of eight inches), the image, B, will appear upright and larger; when the lens is further from the object than the focal length the image, T, will appear larger, but inverted. In Fig. 84 O represents an object to be viewed through a concave spherical lens. When the object is inside the focal length the image, B, will appear upright and smaller; when the object is further from

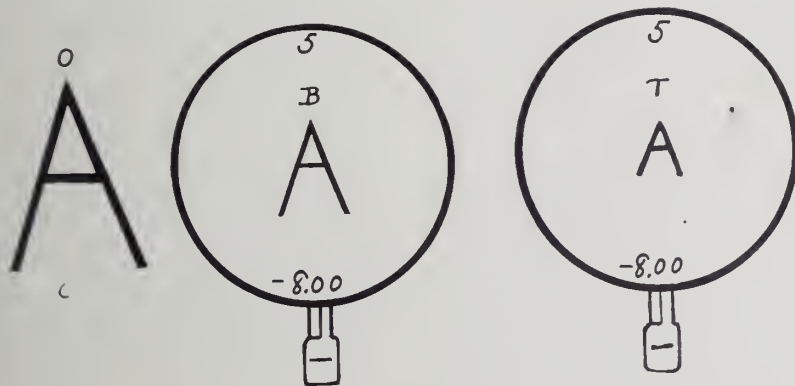

FIG. 84.

nodal point or optic center, N. The ray, OL, parallel to the principal axis, AX, passes out of the lens in a direction as if it came from the principal focus, F, and is directed toward R. Therefore, rays given off from the point, O, are divergent. Prolonging them backward, they meet at O', which is, therefore, the virtual image of the point, O. Letting fall the perpendicular from O', we obtain the virtual image O'B' of the object, OB.

When the object is further from the lens than its focal length the image will appear still smaller, as T, and the further off it is moved, the smaller will it appear. It is always upright, however, and herein differs from the image of a convex lens.

(To be continued.)

D. N. Strayer is selling out his jewelry store in Stratton, Nebr.

The United American Opticians of New York have opened a store at 283 State St., Bridgeport, Conn.

**Anatomy of the Nervous System.**

(Lecture recently delivered before the Rochester Optical Society by DR. RALPH H. WILLIAMS.)

(Continued from issue of May 9.)

A POSTERIOR view of the medulla shows on each side of the median fissure the continuation upward of the posterior or sensory columns of the cords. Only here the column of Goll becomes the funiculus gracilis and that of Burdach, the funiculus cuneatus. These funiculi pass upward to about the upper portion of the medulla, when they practically terminate in nuclei of the same name, the nerves ending in arborizations around cells in the gray matter of its respective nucleus.

These cells in turn give off fibers which pass in various directions, some to communicate with neighboring centers, but the majority joining to form what is known as the fillet or superior decussation or crossing of the pyramids. It is at this point (the fillet), in the pons that the sensory fibers cross over to the opposite side of the brain. You will thus observe that the crossing of control is complete; the motor fibers cross either at the decussation of the pyramids or at various levels in the cord, and the sensory nerves in the fillet. These sensory nerves, after leaving their nuclei in the medulla often pass through several such relay stations as they have just left before reaching the cortex of the brain. The funiculus gracilis and cuneatus pass upward vertically until they reach the lower border of the fourth ventricle when they pass deeper into the structure of the medulla.

The fourth ventricle is a diamond shaped space made up on its floor of gray matter, and it is here the greater number of the cranial nerves have their superficial origin.

The cerebellum is composed of three lobes, two large lateral lobes and one flattened central lobe of vermis; it lies in the inferior occipital fossæ, beneath the posterior cerebral lobes. Its structure is similar to that of the cerebrum as regards the presence of the gray matter outside and the white inside, but here the similarity ends. The convolutions of the cerebrum are much greater in extent than in the cerebellum, where they are simply small folds. On cross section the cerebellum presents a peculiar appearance, the white substance looking very much like the branching of a tree or shrub, hence the name given it, of arbor vitæ.

The two hemispheres of the cerebellum are connected with one another and send peducles upward to the cerebrum and down to the medulla oblongata. The cerebellum is the great center for the co-ordination of organic impulses.

**THE SPINAL CORD.**

The spinal cord is that portion of the cerebro spinal nerve system which is encased within the spinal column. It is about 16 inches in length, extending from the lower border of the atlas above to the lower border of the first lumbar vertebræ below, where it terminates in the cauda equina, which passes on down the spinal canal, giving off the lumbar sacral and coccygeal nerves at their proper levels.

The spinal cord and brain are covered by three membranes, first, the dura mater, or hard membrane. In the skull this membrane forms the lining membrane of the

## Optical Department.

cranial bones and is attached thereto. In the spinal canal this membrane is not attached to the vertebræ, but is connected to them by fibrous connections. The arachnoid is a serous membrane or sack filled with fluid for the protection of the spinal cord and brain. The pia mater is the vascular membrane of the cord and brain, containing within its substance the arteries, veins and nerves which nourish it. In the spinal cord it is connected to the dura mater by a fibrous band of 20 serrations or triangular projections. These projections support the spinal cord in its proper position in the spinal canal.

The cord is composed of gray and white substance. Unlike the brain, the gray matter or nerve tissue lies in the center and is surrounded by the white substance or nerve fibres. On transverse section the cord will be observed to present the appearance in its center of two crescentic masses, with a connecting portion or isthmus. The four horns of these crescentic gray masses are called, respectively, the anterior and posterior horns.

Between both the anterior and posterior horns will be observed a cleft running well into the structure of the cord. These are known, respectively, as the anterior and posterior median fissures. These fissures cut in almost to the gray matter, but leave a slight commissure of white matter at the bottom of each to connect the white matter of each side of the cord.

The spinal cord is not of the same diameter throughout. It has two pronounced swellings, one in the cervical region of the spine and one in the lumbar. In both of these locations the gray matter forms the greater part of the spinal cord on account of the fact that the cord gives off such a large number of large and important nerves at these two points. That is, in the cervical region there is the brachial plexus, which supplies the arms and a considerable portion of the thorax, while in the lumbar region are given off the large nerves supplying the legs and pelvis.

In the center of the gray matter of the cord can be observed with the naked eye a small opening. This is the central canal of the cord which connects with the ventricles of the brain and is filled with a serous fluid.

In addition to the anterior and posterior median fissures there are two antero-lateral and two postero-lateral fissures corresponding with the places where the anterior and posterior horns of the cord come to the surface. These fissures are practically formed by the anterior and posterior roots of the spinal nerves being given off at these points.

The cord is divided, roughly, into four columns on each side: The anterior or pyramidal column, which is continuous with the pyramids of the medulla; the lateral column, which is continuous with the lateral columns of the medulla; the posterior median column, or the column of Burdach, which is continuous with the funiculus cuneatus of the medulla, and the posterior column, or the column of Goll, which passes up to the funiculus gracilis of the medulla.

These divisions are further divided into

ascending and descending tracts. That will be taken up with the physiology of the nervous system. You will bear in mind, however, that the anterior columns represent the motor impulses, while the posterior columns carry sensory impulses. In other words, the anterior columns are sending out to the periphery while the posterior columns are carrying impulses to the centers.

### THE SPINAL NERVES.

The spinal nerves, of which there are 31 in number—eight cervical, 12 dorsal, five lumbar, five sacral and one coccygeal—arise each from the spinal cord by two roots from the anterior and posterior horns of the cord; a motor and sensory root, which join together. Before their union, however, we find upon the sensory root a ganglion, known as the sensory ganglion. Each spinal nerve contains both motor and sensory nerves and is divided almost immediately after the union of the two roots, into two branches, the posterior of which is comparatively unimportant, as it simply supplies the muscles and integument of the back, and the anterior branches, which are of more importance, and will be taken up singly.

The spinal nerves are given off corresponding to the vertebræ whose name they bear. Thus the first cervical nerve escapes above the first cervical vertebra, and the remainder through the corresponding intervertebral foramina. Each spinal nerve gives off and receives into its anterior branch a communicating nerve from the sympathetic system. Thus is the nervous system of conscious life coupled with that of unconscious life.

The cranial nerves, of which there are 12 pairs, may be briefly described as follows: (1) The olfactory nerve, governing the sense of smell, arises by two roots, one each from the cerebrum and basil ganglion, the optic thalamus and the corpus striatum. It is distributed over the mucus membranes of the nose. (2) The second nerve, the optic, which principally concerns you, arises from the optic commissure and deeply from the optic thalamus, corpora geniculata, two small ganglions located back of the optic thalamus, just outside the corpora quadrigemina, and make their exit through the optic foramen.

The optic commissure is formed by the optic tracts, which lead forward from the deep origin of the nerve. Its minute structure you are too familiar with for me to presume to add to your information.

The optic nerve is particularly liable to neuritis or atrophy in connection with disease of the central nervous system. The cause of this is a little uncertain, unless it is due to the fact that the optic nerve is sheathless except for covering given it by the membranes of the brain, which continue upon it into the orbit, and the inner or perinural sheath, which is continuous with the pia mater of the brain, passes into the structure of the nerve with the arteria centralis retinae and is intimately connected with the structure of the nerve. Hence any inflammatory process which involved the membranes of the central nervous system could be readily communicated to the optic nerve. After passing into the orbit it receives a communicating branch from the sympathetic ganglion on the fifth nerve (Meckel's).

The third nerve, or motor oculi, the motor nerve of the eye, supplying all the muscles of the orbit except the superior oblique and the external rectus, has its origin in a center located between the third and fourth ventricle. As it passes forward it receives an important filament from the sympathetic and also receives a communicating branch from the ophthalmic division of the fifth nerve.

It enters the orbit through the sphenoidal fissure and supplies all of the recti muscles except the external. It supplies the inferior oblique, the superior palpebral and sends a branch to the lenticular ganglion. It also supplies the contractor fibers of the iris and ciliary muscles.

Paralysis of this nerve is comparatively common and may arise from a variety of causes. Paralysis of some of its fibers sometimes occurs without interference with the function of the others. Paralysis of the fibers to the levator palpebral is quite common, and is at times complete. Dilatation of the pupil may result from the paralysis of the sphincter fibers of the iris and loss of accommodation, as the sphincter pupillæ, the ciliary muscle and the internal rectus are paralyzed.

The fourth nerve, known as the patheticus, has for its sole function the supplying of the superior oblique muscle. It arises deeply from a point just posterior to the corpora quadrigemina. There is a communication between the deep root of this nerve and that of the third nerve. It receives fibers from the sympathetic and the ophthalmic division of the fifth. The paralysis of this nerve suspends the function of the sup. obl. muscle and prevents the patient from turning the eye downward and outward. Any effort to do this, causing the eye to turn inward, produces double vision. It is first manifested by the inability of a patient to go downstairs owing to the fact that the double vision produces two separate sets of stairs.

The fifth nerve is the largest cranial nerve. It is a nerve of motion, sensation and taste. It resembles a spinal nerve in that it arises by two roots and has a ganglion developed on its posterior root. It also has a very large part to play in the trophic impulses of the parts it supplies.

It arises from centers in the floor of the fourth ventricle, the motor root being derived from the pyramidal body, while the motor root is derived from the lateral columns of the medulla. It also receives communicating branches from the sympathetic, and it is either through the sympathetic or through ascending columns in the cord that the nerve ultimately receives its origin in the cord from as low as the fifth dorsal vertebra.

As the nerve passes forward there is formed upon the sensory root a large ganglion, the Gasserian, the motor root passes forward beneath this ganglion, having no communication with it, but joins outside the cranium with one of the trunks from it. The nerve is primarily divided into three great divisions, the ophthalmic division, the superior max. and inferior max. The two first divisions are purely sensory, while the third is both sensory and motor, and also carries nerve of the special sense of taste.

(To be continued.)



# RETAIL JEWELERS ADVERTISING

The use of this department is open to every retail jeweler and optician. Forward for criticism your newspaper ads., booklets, catalogues, novelties, circulars, etc. Ask advice and offer suggestions. Replies in these columns are unbiased. Make letters as full and particular as you desire. Every letter and ad. sent will receive full attention, though the publication of the matter may sometimes be delayed several weeks.

## Decoration Day Advertising.

**D**ECORATION DAY has not only come to be recognized as a good and fitting occasion for window displays, but it is not less a time for the promulgation of special advertisements. For such there can not be a better opportunity. It is as though it had been made to order.

The day stands just at the beginning of Summer. Aside, too, from the significance of the special occasion, the celebration of the reunion of the rent sections of our dear land, all the bitterness gone and the ushering in of the glad outdoor months, it is the time of year when most marriages are imminent. That means, of course, the season for the most general and liberal purchase of all kinds of jewelry and ornaments. In this one respect it ought to compare well with the holiday season. In one respect it ought even be better—the gifts more costly ones.

But it is also the month of graduations, the time of year when every institution of learning for the young pours out its hosts; the schools for the colleges, the special institutions and the wider sphere of life; the more advanced ones for the busier walks of the world.

These latter also make occasion for the purchase of jewelry and kindred wares, secondary only to those made for matrimonial purposes, if in the aggregate they do not indeed equal or exceed the latter. At any rate, enormous quantities of the less costly grades of jewelry are bought at this time.

For scores of such graduates are to be found every year in every community throughout the entire land. Even the crossroads has its school. Nor are the presents of jewelry intended for the female graduates only. Undoubtedly you will find upon inquiry of the average man that it was upon his graduation from high school or some similar occasion that he received as a present his first watch, probably a silver timepiece or his first studs or sleeve buttons his links or his scarf pin. Then there are the countless other kinds, ranging from the jeweled stylographic or fountain pen, to all the utensils which may be used for smoking, no longer reprehensible for the young man, whatever it may have been or how ever regarded for the boy.

It is worth while, then, for the jewelry dealer who believes in and does use newspaper space to make a departure in it for and around Decoration Day. It ought not to be difficult for him to strike a chord to which his community will freely respond. The chief trouble with a great deal of this

occasional advertising is that there is often to be seen running through it an obvious straining after effect. The successful advertiser will be very careful not to let the impression rest upon the public that he is trying to be funny, nor that he is pedantic or bombastical.

In the attempt to get away from advertisements that would produce such an impression he might, however, fall into other tendencies equally to be avoided; he should strive not to be too solemn, and above all, he should not be so discursive—get so far away from his subject, from jewelry, that the reader would be apt to say, if indeed he would ever go into it so deeply as to analyze: "I wonder what in thunder the fellow is driving at? What in the world has all this got to do with jewelry?"

The advice which is always given, which has always been given since the modern era of advertising began, is: "Be natural." That is good advice; none better. But it is pretty hard to teach a person to be natural, especially when it is more than likely that just the individual whom you might deem to be incrustated in a layer of affectation deems himself thoroughly natural. The term is a relative one. The best and the safest advice which can be given, and which ought to give offense to none, should read: "Be natural, and if you cannot be natural, be as natural as you can." THE ONLOOKER.

## Souvenir Postal Cards as Advertising.

**W**HEN one contemplates the remarkable popularity of the souvenir postal card, it is not at all surprising that these pretty little devices have entered the realm of advertising. They are just now being resorted to quite liberally by business firms in many different lines as couriers of commerce. This is not only due to their great convenience and to their economy in reaching a list of patrons which is more or less scattered, but to the fact that they are more lasting than any other form of advertising, except the more expensive novelties.

A business card, representing a greater investment, may quickly be consigned to the waste basket, while a post card will be cherished for a long time and may form part of a collection, where it will have a permanent value as an advertisement.

There is such a variety of these cards on the market at the present time that it is a simple matter for a dealer with whom an order is placed to pick out a selection which may be particularly appropriate to any business.

A prominent dealer in stones, who makes a specialty of diamonds, instructed his rep-

resentatives abroad to gather up specimens of such cards as might be regarded of special interest to buyers and dealers in diamonds, with the result that he succeeded in getting together a collection which has considerable interest, illustrating almost every phase of the diamond's history, commencing with a number of views of the great establishment at Kimberley. In these are shown types of the Kaffirs who are largely employed about the mines, the means of inspection to prevent stealing of gems and a view of the interior of one of the safes of the De Beers Consolidated Mines, showing the greatest aggregation of diamonds to be found anywhere.

The thread is then carried to the famous diamond cutting establishments of Europe and the principal operations are shown on half a dozen cards. Another card shows the various ways of cutting shapes and styles of cuttings, while other cards contain full-sized reproductions of the world's most famous stones. The collection is completed with a view of the particular establishment of the firm referred to above. This collection of cards is an education as far as the diamond business is concerned and comprises a very substantial means of advertising.

The possibilities of the jewelry trade for an interesting postal card exposition are numerous. There are specimens of jewelry of historical value in all the great museums which could form the basis of such a series, the newest designs could be exploited in the same manner, or an interior view of the jeweler's store could be used.

The ingenious use of the postal card in this field is almost limitless and any dealer could likely work out some excellent ideas of his own.

## What Some Jewelers and Opticians Say.

**C**LOUDLESS days and our brilliant sunshine tend to bring out eye defects. People need glasses here who never wore them before. It is the inability of an imperfect eye to handle the intense light that causes eye-aches and pains. People often wear smoked glasses for relief when their real need is a pair of correcting lenses. Our expert examination is free and we will gladly tell you if you need glasses or not. R. Ashby, Colorado Springs, Colo.

Grandfather clocks and others. We want you to know that we're constantly adding new stock in this complete jewelry store. Just recently we received a number of handsome mahogany grandfather clocks in new designs, with beautiful chimes. Grandfather clocks, \$150, \$200, \$300, \$400; French clocks, \$25 and up; gilt clocks (American movements), \$16 up. Desk clocks, \$3 up; and, in fact, here is almost every sort of clock at prices to suit every one. W. A. Sturgeon & Co., Detroit, Mich.

A variety of patterns in fine baking dishes. No better silver plate ware is made, either in wearing qualities or beauty of design and finish. In Butler, satin or burnished silver. Separate porcelain inside pan. Engraved with old English text, the baking dish is a rich-looking table object, \$3.50 to \$10. The baking dish has a wide range of use in the serving of vegetables, stews, ragouts, puddings and desserts.—Hofman Jewelry Co., Columbus, O.



That this department shall prove mutually beneficial to our readers, it is desirable that the members of the trade generally communicate with THE JEWELERS' CIRCULAR-WEEKLY regarding any advantageous device or plan which they are utilizing in connection with their business.

## Decoration Day Window Displays.

Seasonable and Original Suggestions for the Window Trimmer.

DECORATION DAY comes at a most felicitous time. It stands practically at the very beginning of Summer. No holiday precedes it for some weeks. And the holiday that does precede it, Easter, is of so essentially different a character that the two have very little in common. Easter is most decidedly more of a religious character. And though there clusters around that day a secondary sense of joyousness, it is due more to the child-legends that have grown in its wake than to the meaning of the day. Nevertheless it is the latter that have tinged the window displays. These appeal rather to the child within us all than to our adult senses. Not so with Decoration Day. It carries for all of us, especially for those of us old enough to remember, a deeper, nearer, though not holier meaning. Yet withal it comes at so joyous a time that we cannot help hailing it in festal wise. The gray or the black which is festooned 'round the red, white and blue, does not give it a somber effect to our senses. It may make us thoughtful, but it does not make us grave.

Another reason which has added to the stability of Decoration Day in our business observance of it is that there is no holiday preceding it for three months—Washington's Birthday, on which the tradesman can make a decided display. For Easter is a movable feast. Therefore the tradesman loses a grand opportunity if he does not take advantage of it to the full.

The holiday which follows Decoration Day, our glorious Fourth of July, is five weeks away and almost in the heart of Summer. It is, too, of so entirely different a character that the two have very little in common. So that the window displays of Decoration Day can be made absolutely unique.

Herewith are a few suggestions for such window displays. These are all simple ones and made so with a view toward allowing even the dealer in the small country town to construct them himself. If he is at all handy they will require but little time for construction. The only tools which he will need are such as are to be found in every well-ordered household. The materials

likewise are simple and inexpensive; such as he will find at the nearest carpenter's and at his own dry goods store.

But there is one requirement which cannot be so easily supplied or obtained. Nevertheless we will assume that lay figures or dummies can easily be loaned for such occasions either as favors in the smaller communities from some of the neighboring dealers or for a small, merely nominal rental. Almost all of the clothing stores, no matter how small the town, have a few male dummies. The female lay figures are to be found just as surely in the dry goods stores.

The first display requires not even dummy figures. The main object of the display should be a cannon. A pair of rude cart-wheels can easily be secured, and the carriage can be constructed out of the most ordinary wood. Indeed, its main feature should be just a common soap box. As for the gun, any log cut and planed by the veriest apprentice will serve. All this should be painted, and if not desired more elaborately ordinary lampblack will excellently serve. The cannon should stand so that its mouth shall point toward the street into the very faces of those whom the display attracts. The log need not be scooped very deeply; indeed, merely sufficient to hold a nest; perhaps two' or three inches. Around the wheels and the rear of the carriage and, in fact, everywhere that they can be trailed, shall be creepers—Virginia wisteria or any kind that may be most easily obtained. Gracefully nestling within the next right in the mouth of the cannon two or three little stuffed birdlets shall be placed. In fact, if it be desired, in their stead bird's eggs will do just as well. But two or three full-grown stuffed birds of some well-known kind that are indigenous to our forests are essential. These can be placed in any way that the taste of the constructor of the display may suggest.

The floor of the window and the sides and the rear and the top shall be covered with bunting in our national colors, consisting of both stripes and stars, the stars, as would naturally suggest itself, predominating at the top.

On the floor, if desired, and, indeed, there is no good reason for not utilizing the otherwise unemployed space at hand, there can be quite a display of jewelry.

To complete this display an appropriate sentiment, preferably in verse, should be prominently shown in the rear, just over the body of the cannon. At this height it will only be slightly above the heads of the on-lookers, and consequently not possible to be overlooked. If nothing more appropriate can be found the beautiful words of Ten-nyson are not altogether out of place:

"Ring out old shapes of foul disease,  
Ring out the narrowing lust of gold;  
Ring out the thousand wars of old,  
Ring in the thousand years of peace."

Nor is there any need of lay figures in the following display as a second suggestion. This is to reproduce in heroic size the badge or the decoration of the order of the Grand Army of the Republic—a very familiar emblem to almost everybody. It is not necessary to go into a detailed description of how this is to be done; the mere suggestion ought to be sufficient. To make the eagle possible, for, of course, to carve it out or to have it carved out would be inexpedient, the eagle should be cut out of pasteboard and then covered with brown paper. The design is easily enough obtained, for every jewelry store carries a few at least of these decorations in its line of emblems and badges.

Let this be hung at the rear of the window and the rest of the space be treated as in the foregoing case, even down to the matter of the display of the jewelry.

And for a sentiment, the following is singularly appropriate:

"All nature's hue is sad to view  
E'er Spring asserts her sway,  
It bursts in blossoms, Red, White, Blue,  
On Decoration Day."

For a third window display could anything be more appropriate for the day and the occasion than the following, suggested, of course, by the immortal lines of Thomas Buchanan Read:

"The maid who binds her warrior's sash,  
With smile that well her pain dissembles,  
The while beneath her drooping lash  
One starry tear-drop hangs and trembles,  
Though heaven alone records the tear,  
And Fame shall never know her story,  
Her heart has shed a drop as dear  
As e'er bedewed the field of glory!"

It may seem strange that in the multiplicity of displays, symbolical and otherwise, which have been utilized, this has apparently been overlooked or neglected. In

## Storekeeping Department.

view of this it may seem somewhat bold to adopt it. Yet one great objection may have appeared on analysis is to have been the obstacle. A little further reasoning, however, would have brushed this aside, for seemingly complex as the picture appears and cumbersomely long as would have seemed the quotation, neither really stand in the way. In fact, the quotation, a most lovely word-picture, would have been in effect an added charm.

This aforesaid word-picture so vividly presents and suggests the display that little more description is needed. The figures that are required, but two, a man and a woman, can easily be arranged in suitable costumes, for the woman's consists but of the everyday home-wear of a lady in moderate circumstances. There need be no straining to have it fit the year 1861, for the words are suitable to all times as also all climes. The man's costume is a stock one, that of the "boy in blue," of which doubtless there are scores in every community.

The arrangement of the figures in the window should show the woman as half kneeling before him, arranging some detail of the uniform, while he looks down at her, his attitude conveying love for her, the uniform and accessories sufficiently portraying the other emotions he is intended to represent—pride in the responsibilities he is about assuming, love of country, etc. It will be seen that no reference is made to expression, for it would require an unusually fine set of figures to portray expressions—much finer than the crude ones likely to be obtainable.

As for accessories these, too, ought to be easily obtainable—a gun, a sword, a drum and whatever else may simply represent war and the camp. And a few objects representative of the house would be proper—a sewing machine, a rocking chair; or a table with a few sewing implements thereon, a work basket, etc., etc., not forgetting a vase of flowers, especially suitable to the occasion, and at a time when they should be easily obtainable. (As far as that is concerned, artificial flowers have arrived at such a remarkable degree of perfection and lend themselves so well to ornamentation that on the score of durability and toughness, as also that of price, they are preferable.) The arrangement of the accessories may well be left to individual taste.

The background and all else pertaining to the display may be much the same as that for the other displays suggested.

As for the quotation itself, this may either be cut out in gilt letters of an average size to vary from an inch to two inches, according to judgment and to ability to place them, or they may be stenciled or marked or engrossed, according to the ability of the maker of the display or the facilities he may have at hand. If the former method be employed, let them be tastefully pasted on a sheet of unbleached muslin or some other cheap material. Let the quotation be hung in the background, about at the height of the man's head. Care must be taken to give the onlooker an unimpeded and unbroken view of the entire

quotation, placing the author's name below at the right-hand side.

That suggests that the poem in its other two verses also gives two other splendid opportunities for displays kindred to this, "The Wife" and "The Mother." If a caption is wanted for any one of the three displays obtainable from the poem, what would be finer or more fitting than its title, "The Brave at Home."

The jewelry display in a window picture of this kind would naturally have to be subordinated, or might even have to be altogether omitted. At first blush the dealer might be disposed to reject the display altogether on this account. But let him give the subject a little more thought, and doubtless he will come to the broadminded conclusion that a display of this high character without the room or the fitness for a display of his wares might in the long run do him more good, even in a monetary way than would an inferior display with an ornate array of his wares. At any rate the matter is one for thought and even experiment. No one would be bold enough to propose this to be practised too frequently or freely. Thereby the whole end in view would surely be defeated.

But one beautiful and well carried out window display, by which is meant beautiful and well carried out in symbolism, in which the whole end and aim is the conveying of a lesson in patriotism, cannot fail to reflect credit upon the dealer making that display. Just by the omissions therein will his name and his fame be the better remembered. Is not the experiment one that is worthy of a trial?

THE ONLOOKER.

### A Biblical Business Card.

THE following were the rather unique contents of the back of a business card used some time ago by a Michigan jeweler:

#### IF YOU ARE DOWN WITH THE BLUES

read the 27th Psalm; if you feel lonesome and unprotected, read the 91st Psalm; if you are out of sorts, read the 12th Chapter of Hebrews; if people pelt you with hard words, read the 15th Chapter of John; if you don't know where to look for a month's rent, read the 37th Psalm; if there is a chilly sensation about the heart, read the 6th Chapter of Revelation and the 6th Chapter of Galatians, 7th and 9th verses; if you find yourself losing confidence in men, read the first Chapter of 1st Corinthians; if the stovepipe has fallen down and the cook has gone off in a fret, put up the pipe, wash your hands, read the 3d Chapter of James, and then regain your good humor by calling at

**C. S. RUTLEDGE,**  
323 STATE STREET,  
ST. JOSEPH, MICH.

to see the

**GOLD WATCHES,  
DIAMOND RINGS,  
PRETTY PINS**

and many other nice articles, low in price,  
for BIRTHDAY,  
WEDDING AND ANNIVERSARY GIFTS.

### Unique Display of Diamonds Worth \$200,000.

ONE of the most gorgeous and attractive displays of diamonds that Chicagoans have witnessed for a number of years, is the calla lily design recently displayed in the store of C. D. Peacock, State St. When it is known that the entire production includes \$200,000 worth of the choicest South African diamonds, the beauty of this valuable and artistic "set piece" will be apparent to all, as a mere glance at the photograph reproduced on the front cover page in this issue plainly shows.

Pedestrians wending their way along State St. have stopped and feasted their eyes upon the majestic "diamond lily," until the foot-walk in front of the Peacock establishment was blocked with people.

The entire design is composed of about 1,200 separate diamonds and represents calla lilies in full bloom and otherwise, to be exact, one in full bloom, one about to open, and two in bud. The stems of these are bound together by a large bow-knot. The entire surface is one of sparkling diamonds, crowded together so that the surface actually dazzles with a myriad lights, whose concentrated reflections and hues affect the eyes like electricity.

The lilies are 22 inches high by 13 inches across, and consist of 1,200 stones of different shapes, sizes and values. The stones vary from those of three carats to some of one-half carat, the larger stones predominating. In the heart of the full-blown lily are three elegant rubies of three carats each, which show up to considerable advantage among the mass of diamonds.

As regards color, all of the stones are exceedingly fine, none being of less quality than "white," while many of them are "blue." The stones are technically described as "Jaegers," and all come from the diamond mines of Kimberley, South Africa. The design was placed on exhibition for a week or so, and attracted more than average attention.

### Ideas and Schemes.

A CLEVER and very effective window advertising scheme was recently introduced at the store of S. D. Burrill, Rochester, N. Y. It consists of a covered disk pivoted in the center. On the under side of the disk are numerous small electric lights; on top of the disk and keeping it moving all the time are six little mice. The whole thing is enclosed in a glass case, in the corner of which hangs a string, which the mice climb down when ready for food.

An attractive advertisement has been sent out by the Trenner Optical Co., Denver, Colo. A large envelope has a string put under the flap and on the front is conspicuously printed "Pull the String and See." Inside the envelope is an illustrated folder containing information about eyes, glasses and optical goods in general.

C. E. P. Keim, Newport, Pa., has established the reputation of having as beautiful window displays as can be found in inland Pennsylvania, especially before any holiday, when the display is along the line of the holiday in its suggestions. He says these displays pay him handsomely.

What Tool is of More Importance to THE MAKERS OF FINE JEWELRY than

**A FIRST CLASS SAW ?**

**SHARP—TRUE—UNIFORM  
—PERFECTLY TEMPERED**



TRADE MARK  
**ONLY THE BEST ARE GOOD ENOUGH**  
MARK



Such is the **ZEUNER SAW.**

TRY THEM, for "Only the Best are Good Enough," and only the Best are Cheap. Trial orders promptly filled under guarantee of perfect satisfaction, which applies also to our "AMERICAN SWISS FILES."

**E. P. REICHELME & CO.,** 23 JOHN STREET, NEW YORK.

**THE REMINGTON RING EXPANDER.**

The most useful implement a jeweler can own.

PRICE \$7.00 NICKEL PLATED INCLUDING A STEP MANDREL AND EIGHT ROLLS

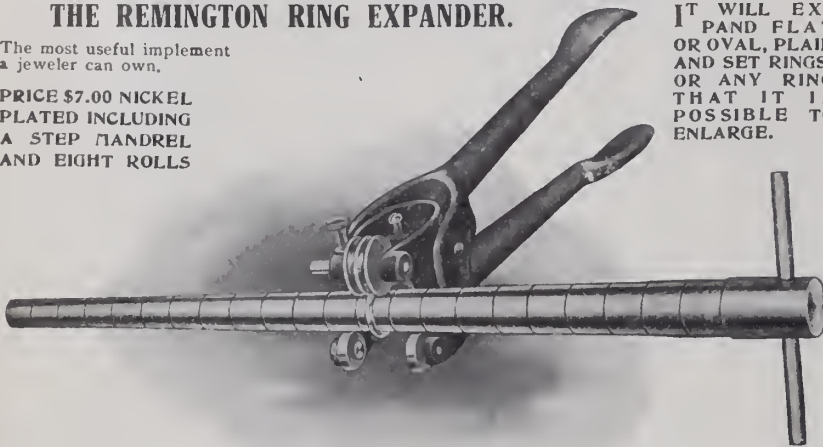

IT WILL EXPAND FLAT OR OVAL, PLAIN AND SET RINGS, OR ANY RING THAT IT IS POSSIBLE TO ENLARGE.

IF YOUR JOBBER CANNOT SUPPLY YOU WRITE TO US DIRECT.

**SPECIAL FEATURES OF THE REMINGTON RING EXPANDER.**

A MANDREL WITH STEPS SQUARED and 1/2 size variation is used to prevent tapering of the ring. THE FOUR SMALL ROLLS ON THE LOWER JAW OF THE TOOL (see cut) PREVENT FRICTION, and make it possible to use any amount of pressure WITHOUT ROUGHING THE MANDREL. THE PRESSURE IS CONTROLLED BY THE HAND and it is not necessary to use a vise or other implement when operating the REMINGTON.

Manufacturers of Patent Tools and Machinery.

**NOVELTY ENGINEERING ASSOCIATION, FITCHBURG, MASS.**

**OUR ELECTRO-PLATING SALTS**

when dissolved in water, make a plating solution at once ready for work and of always correct shades. Know that we are the originators and manufacturers of the Dark Green Gold Salts (Antique) and other Shades of Green.

Likewise the Rose and Orange Rose Gold Salts used for single and double gilding, and of a good many other shades now on the market.

Our Roman Gold Salts produce an almost bright deposit, requiring little or no scratch brushing.

French Grey, 14 or 18 Kt. gold, Old English gold, Silver Ebonizer, in fact any shade wanted, can be had of us. Write for circular.

Our Automatic-Electro Plating Machine specially designed for the small manufacturing and the retail Jeweler, will be of interest to them. Send for Pamphlet.

**U.S. ELECTRO-CHEMICAL CO.**  
H. Hirschbach, Prop., 80 Elm Street, New York



**GLARDONS' SWISS FILES**

are the **HIGHEST STANDARD** of Excellence.

We are Sole Agents for the United States and Canada.

**F. W. Gesswein Company,**

Established 1868. Incorporated 1896.  
WILLIAM DIXON, PRES.  
Dealers in Fine Tools and Supplies,  
39 John Street, New York.

**LEARN WATCHMAKING AT HOME**

by THE De SELMS CHART SYSTEM, copyrighted and patented. The most simple, practical and up to the minute method of learning.

Saves you time and money while learning and puts you in a position to more than double your income.

50 million timepieces to be repaired. Accurate time is a necessity in the business world. When time is money the watchmaker gets his share of profit. Positions for graduates. Booklet free. Write to-day.

**The De SELMS WATCH SCHOOL,**  
109 Perry Street, ATTICA, INDIANA.

**"Perfect Yourself"**

In ENGRAVING and EXPERT WATCH WORK. Take a Post-Graduate Course.

**RIES & ARMSTRONG, Macon, Ga.**

"PRACTICAL COURSE IN ADJUSTING."  
Price, \$2.50.

All Jobbers or Jewelers' Circular Publishing Co.

**HERPERS BROS.**  
MAKERS OF  
**SETTINGS**  
IN 10, 14 AND 18 KARAT GOLD AND IN PLATINUM.  
ALSO A COMPLETE LINE OF GALLERIES AND FINDINGS.

OFFICE AND FACTORY NEWARK, N. J., U. S. A. NEW YORK BRANCH 41-43 MAIDEN LANE

BRACELET SHELLS FIVE SIZES ROUND AND OVAL

SECTION

DAY CLASS | **ENGRAVING** | NIGHT CLASS

THE SCHOOL FOR THOSE WITH MODERATE MEANS  
**POMFRET-GOLDY SCHOOL OF JEWELRY ENGRAVING**  
SEND FOR PROSPECTUS 319 HEED BUILDING, PHILADELPHIA, PA.





[Answers are also solicited from our readers to the questions published on this page.]

**QUESTION No. 1559.—Judging Amount of Silver Deposited.**—*In making an electrodeposit of silver on articles, I find it difficult to judge the amount deposited, and would like to know of some way without the use of scales by which I can tell if the deposit is sufficient.* J. A. S.

**ANSWER:**—The simplest method is to take a piece of sheet metal, about 3 by 6 inches, which is not potashed or dipped, but simply covered slightly with emery. Hang this in with the articles to be plated. The silver will not lay close to the plate and can be peeled off. The deposit may be judged by the amount on this plate.

**QUESTION No. 1560.—Soft Soldering Fluid.**—*Do you know of a zinc that can be dissolved in alcohol to make a soft soldering fluid?* P. H.

**ANSWER:**—Chloride of zinc dissolved in alcohol will make a soldering fluid, but in soldering with this fluid the metals to be soldered must be scrupulously clean and the surfaces to be soldered must not be touched with the hand. A watery solution of sal-ammoniac will help the process, in the case of nonferrous metals.

**QUESTION No. 1561.—Ink for Celluloid.**—*Please tell me what kind of ink to use for writing on celluloid. The ordinary writing inks do not "take hard."*

B. W. M.

**ANSWER:**—Melt 30 grams of pulverized tannin in 100 grains of acetone (pyro-acetone spirit); then melt 20 grams of dry chloride of iron in an equal quantity of the above solution. By mixing thoroughly both solutions, the desired ink is obtained. It is well to remember that acetone is very inflammable.

**QUESTION No. 1562.—Mosaic Gold.**—*Kindly give me an alloy that closely resembles gold, and that is suitable to be gilded.* M. G.

**ANSWER:**—An alloy that is very beautiful in color, closely resembling gold and of very fine grain is made of copper, 100 parts; zinc, 50 parts. This composition is known as Mosaic gold, or chrysolin. It is also known as Hamilton's metal.

**QUESTION No. 1563.—White Metal for Patterns.**—*I would like a white metal alloy suitable for metal patterns; something that will not shrink very much.* W. M. P.

**ANSWER:**—A white metal mixture, suitable for patterns and non-shrinkable, may be made by using 23 lbs. of lead, 3¼ lbs. of antimony and 3¼ lbs. of bismuth. Or, if a cheaper alloy is desired, take 5 lbs. of zinc, ½ lb. of antimony and ½ lb. of tin.

**QUESTION No. 1564.—Brass Solder.**—*How can I make an easy flowing brass solder?* B. S.

**ANSWER:**—A very good brass solder is

made from copper, 51½ parts; zinc, 42½ parts; tin, 1½ parts and lead ½ part. A white brass solder is composed of 34 parts of copper and 66 parts zinc.

### The Enameling of Jewelry.

By CECIL H. SHERMAN.

(Copyright, 1906, by The Jewelers' Circular Publishing Co.)

(Continued from issue of May 2.)

#### PRECAUTIONS IN GRINDING.

**ONE** cannot take too many precautions in grinding. You can crush the enamel finer by placing the pestle on the big lumps and tapping gently with a hammer. When the bigger lumps are crushed, discard the hammer and crush by bearing your weight on the pestle. When fine enough start to grind (any druggist can show you how to do this). When you get the enamel to the consistency of granulated sugar, fill the mortar with water, stir the contents with the pestle, and when settled for about 10 seconds pour off the water. Fill it up again and repeat the operation until the water is no longer milky. Then remove to the agate mortar, if you have one; if not, continue to grind in the same mortar until the enamel is as fine and free from grit as pulverized sugar, or nearly so. Now carefully wash away all the milky water as before, and place in one of the covered ointment jars. This water is generally scooped from one jar to another with the spatula shaped end of the point. Fill the jar with water and cover.

The finer the enamel is ground the better it works, provided all of the milky substances are washed away. About one-half of the original quantity generally disappears in the grinding and washing.

A good way to tell when the enamel is ground fine enough is to take a little from the mortar with one of the points or needles (never use your fingers), place between thumb and fingers and thus determine if it feels gritty.

Grind only the colors that you have immediate use for. Always keep the enamel covered with water and the cover on the dish when not in use.

When the enamel is cleaned and ground the next thing to do is to fill in the little cavities in the article with ground enamel. Try to get a place at the bench in front of a window where the light is good, but be sure there is no dust, and as a precaution wipe off the bench with a wet cloth. Get out your needles and box of small pieces of blotter; then take the dishes of enamel you are going to use, stir the enamel well with one of the points (spatula end) and throw off all the water. Fill again and re-

peat. Keep a small bottle of filtered water on the bench for this purpose. Tilt up one end of the dish and place the cover under it.

If the pieces have joints or clasps large enough to grasp with the fingers, use them. If not, catch one of them in a pin vise. Do this without touching the face or side which is to be enameled with the fingers. Hold the piece directly in front of the bench so that the surface is a little bit above the level of the bench. Do this with your left hand and rest your left arm on the bench in order to steady it. Dip a small point of steel in the dish, pick up a small quantity of enamel and put it in the required space on the pieces.

There is a place in the dish when tilted, just below the level of the remaining water, where, if you insert the point, you will get about the desired amount. Fill the cavity by repeating the dipping, being careful to have an even coating and sure that the corners are as full as the center. Tap the piece gently with the point (to settle it) and proceed with the next color. It will take a lot of practice to charge an intricate design. If, for instance, you find that the colors run together, charge in what you can of it without getting in trouble and leave the "runny" ones until later.

If you use iron plates, always let them remain in the muffle until they are red-hot; then lay them on the firing table to cool. This precaution is taken because, if a drop of water gets on one of the plates, the scale will fly off in the fire and usually spoil the charged points. When the plates are cool take a couple of strips of sheet iron and bend them round—one, one-half an inch smaller than the plate, and the other enough smaller than the first, so that when the two are laid on the plate the pieces can be set on these rings. Have a few short pieces, a couple of inches long, bent so that one or two pieces could rest on them.

When you have charged the first piece set it on the plate propped up with the bent iron, so that the surface is level with the joint. Do not touch the plate, but grip the edge with tongs and insert in the red-hot muffle. Set it on the bottom of the muffle and watch it closely. When the enamel melts or becomes glossy, take it out (with the tongs, of course), and set it on the firing table. Leave it there until cool. Brush with a dry brush, fill in a second coating fire, then let it cool.

First, about the fire: If you have gas or coal oil, everything is easy. If coal or coke, it is well to build a fire the first thing in the morning or a couple of hours before you want to use the furnace. Start it as you would a stove and when the coal has caught fill it up and don't attempt to use it for firing until you can light a piece of paper by holding it in front of the muffle. In fact, any kind of a furnace should be so tested at first.

Enamels should all be tested before starting to finish a piece of work. They should flow at a low degree of heat, so low that the metal will not burn (warp). It should not be covered with a scum or become dull of lustre when boiled out in an acid pickle. Moreover, all the colors should flow with the same amount of heat.

(To be continued.)

**C. DORFLINGER & SONS,**

36 MURRAY STREET, NEW YORK.

*Works, White Mills, Wayne Co., Penna.*

Manufacturers of plain and cut Table Glassware of the highest quality.



**ENGLISH :: GLASS.**

Large Assortment of  
FANGY VASES,  
CENTRE PIEGES and  
ROCK CRYSTAL STEM WARE,

Particularly adapted for the  
Jewelry Trade.

Write for particulars.

Sole Agent for the Celebrated CAULDON CHINA.

**EDWARD BOOTE,**  
46 West Broadway :: New York.



**Hat Pin Holders**

New, Practical, Pretty,  
and Quick Sellers.

No. 823.  
Hat Pin Holder.  
Ladore.

WRITE FOR PRICES.

**Maple City Glass Co.,**  
CUT GLASS TABLEWARE,  
**Hawley, Pa.**

SALESROOMS:

- New York—H. B. Stites, 253 Broadway.
- Baltimore—Green & Thomas, 33 S. Charles St.
- Boston—Sweetser-Bennett Co., 101 Tremont St.
- Buffalo—J. R. Stadlinger, 685 Main St.
- Indianapolis—J. A. Dugan Co., 22 S. Capitol Ave.
- Duluth—Duluth Crockery Co., 6th Ave. and West St.
- Denver—Western Selling Co., 1617 Lawrence St.

**The Riviere Brass & Bronze Works**

cordially invite the Trade to inspect their new line of

**Electroliers, Chandeliers and  
Brass and Bronze Novelties**

now on exhibition in their new showrooms (recently enlarged) at

**328-330-332 Seventh Avenue**

(Between 28th & 29th Streets)

**NEW YORK CITY**

**Jewelers, Notice!**

WE want one first-class Jeweler in every city and town to handle our line of CUT GLASS (exclusively).

**NEWARK CUT GLASS CO.,**  
Newark, N. J.

**JACOT MUSIC BOX CO.,  
IMPORTERS.**

Stella and Ideal Music Boxes,  
39 UNION SQUARE, N. Y.

Established 1870.

Manufacturer of

**LOUIS W. HRABA, Fine Leather Goods,**

29 East 19th St., New York.

Exclusively for the Jewelry Trade.

**A. Nonnenmann & J. Aschenbrenner,**  
114-118 East 23d St., New York.

**Original Designers** for Platinum, Gold and Silver Jewelry. Artistic Designs for Silverware and Novelties furnished at shortest notice.

**CLOCKS, BRONZES, CUT GLASS and ART NOVELTIES.**

WHOLESALE DISTRIBUTORS **COMMUNITY SILVER** SEND FOR CATALOGUE

**H. BEALMEAR & CO., 234-236 Park Avenue, Baltimore, Md.**

# THE CONNOISSEUR

*Devoted to Art Pottery, China, Marbles, Bronzes, Cut and Decorated Glass Ware, Bric-à-Brac, Lamps, Art Metal Wares, Fancy Goods and Kindred Lines.*

## Use of Copper in Ancient Times.

THE range of metals and alloys at the disposition of the craftsman is really very wide, but he, nevertheless, Prof. Robert Austen says, restricts his efforts within narrow limits, and employs but few materials. The pure metals and fine wrought ironwork are seldom used, and have hardly any applications in art industries, except when in union with other metals. The two series of alloys which have prominence in the history of art metal work are those of copper and tin (the bronzes) and the copper-zinc series (the brasses). Next in importance should come the lead-tin alloys (the pewters). Of the alloys of the precious metals, the gold-copper, the gold-silver and the silver-copper are the most important.

Taking the bronzes first, the important question at once suggests itself whether copper was employed before the general adoption of the alloy of copper and tin in industrial art. Berthelot has given us the analysis of a little Chaldean statuette of a god, now in the Louvre, which is considered to date from 4000 B.C., and it proved to be of metallic copper. There is also an analysis by Berthelot of the scepter of King Pepi I. of the sixth Egyptian dynasty. This scepter, which is now in the British Museum, is believed to be 3,500 or 4,000 years old, and is of pure copper.

From the anthropological point of view copper plays an essentially different part in prehistoric culture now from what was assigned to it a short time ago. Whereas it had been assumed that copper periods existed in Europe only in a few localities, finds of it have recently increased to such an extent that the assumption of a special copper age, which was prior to the bronze age and contemporary with or near the stone age, seems to archæologists now inevitable. Many of these objects found in Schliemann's first prehistoric city, Thos, were of nearly pure copper. Other articles in the third city were of bronze.

Our knowledge as to the first appearance of bronze has recently received new evidence in a rod found by Dr. W. Flinders Petrie at Meydum, of the fourth Egyptian dynasty (about 3700 B. C.), which proves to be a bronze having about the ratio of nine parts of copper to one part of tin, characteristic of far later and even of modern bronzes. Two works in the South Kensington Museum, one Etruscan and the other Greek, afford clear evidence of the introduction of tin into the art of those nations in the fifth century before Christ. The fact that the presence of lead in bronze enabled it to be more easily fused and also to assume a beautiful, velvety-brown patina, was,

in the opinion of the expert, recognized far earlier than has been supposed.

The use of zinc is indicated in the descriptions in detail by Pny of the various shades of color presented by bronze. The use of brass, which was common enough in Roman times, does not seem to have prevailed in England until William Austen, in 1460, made of it the magnificent monument of Richard Beauchamp, Earl of Warwick. E. F.

## Tariff Decisions on Earthen Ware, Terra Cotta, Glass, Etc.

IN cases involving duties on decorated earthen ware and articles made of terra cotta and glass, decisions were announced last week by the Board of United States General Appraisers as follows:

*Terra Cotta Articles.*—Protest of Hauffing & Kleppner against the assessment of duty by the Collector at New York. G. A. 6229 (T. D. 26915) followed, relating to articles of terra cotta in the shape of pigs and heads on which grass seed is to be grown.

*Decorated Earthen Ware.*—Protest of R. F. Downing & Co. against the assessment of duty by the Collector at Boston. The importers contended that the merchandise was improperly classified as decorated earthen ware under Par. 95, Tariff Act of 1897. Protest overruled.

*Decorated Earthen Ware.*—Protest of J. C. Humes Crockery Co. against the assessment of duty by the Surveyor at Kansas City. Same as above.

*Chinese Terra Cotta Teapots.*—Protest of Marshall Field & Co. against the assessment of duty by the Collector at Chicago. The merchandise consisted of Chinese terra cotta teapots decorated with raised ornamentation, which were classified as articles composed of earthy or mineral substances, decorated, under Par. 97, Tariff Act of 1897. In default of satisfactory evidence in support of the various contentions of the importers, the Board affirmed the assessment.

*Glass Disks, Beaker Covers, Clock Glasses.*—Protest of E. H. Sargent & Co. against the assessment of duty by the Collector at Chicago. This protest related to convex disks of cylinder glass, which are five inches in diameter and have ground edges. They were classified under Par. 100, Tariff Act of 1897, relating to blown glass ware, etc., and were claimed by the importers to be dutiable under Par. 192 as parts of clocks. The Board found these articles to be known as watch crystals, but that, by reason of their size, they were not suitable for watch purposes, and by reason of their thinness were not suitable for clock glasses, and that they are used chiefly in chemical laboratories as covers for beakers. Protest overruled.

## Marie Antoinette's Earrings Sold at Auction in London.

ACCORDING to a special cable despatch from London, England, to the *New York Sun* recently, 149 lots of jewelry were sold for \$103,610 at Christie's on that date. Six of them were the property of the late Lady Currie. They brought \$24,350. The chief

items were a Latin cross pendant, composed of six large diamonds, which sold for \$7,500, and a diamond necklace, which was sold for \$5,500.

Plain, large pearl earrings, which once belonged to Marie Antoinette and subsequently were the property of two Duchesses and a Grand Duchess, went for \$2,750. The best remaining necklace, composed of 62 pearls with cluster diamond clasp, brought \$8,600.

## The Making of Porcelain.

MAXILE DOAT, of the famous Sèvres factory, has written a practical treatise on the making of porcelain, which the Ceramic Studio Publishing Co., Syracuse, has issued in an attractive volume entitled "Grand Feu Ceramics." This has been translated from the French by Samuel E. Robineau, with notes on the use of American clays by Professor Charles F. Binns. As M. Doat is a master workman, his instructions and observations are of value to those who make or decorate china, and we have a legion in this country that decorates it, any way. He gives directions as to choice of clays and mixtures, of coloring material, of casting, glazing, setting and the rest of it, warning the rash experimenter that "everything threatens the destruction of the works of daring ceramists, if they do not display in their fight against the fire a good deal of skill and thoughtful patience. But all these precautions will readily occur to the mind of a man who risks in the fire six months of artistic work and all the money accruing from former sales."

The book is sufficiently illustrated, not merely with plans of kilns and figures of saggars and other materials, but with examples of the great work of Copenhagen and Sèvres, the frontispiece representing one of M. Doat's plates in hard paste, pate sur pate, a head in cameo symbolizing the snow, while the brown that circles it is a result of chemical action in the furnace.

Among the accomplishments of the potters is a palace front in *gres*, decorated with the whole palette of *grand feu* colors, and measuring 38 feet by 29 feet. Much attention is given nowadays to decoration, which is often overdone and amateurish, but there is less attention than there should be to form and to solid color. Nothing surpasses in beauty the single color pieces of the Chinese, which are to be regarded almost as examples of a lost art; but the promptings offered in this volume may stimulate a new and needed interest in that branch of artistic manufacture.—*Brooklyn Eagle*.





# ART Leather Goods

We now have on exhibition in our New York Salesroom a choice collection of

**EUROPEAN NOVELTIES**

IMPORTATION ORDERS SOLICITED

**C. F. RUMPP & SONS**  
Philadelphia

New York Salesroom, 683 and 685 Broadway



## BLANCARD & CO.,

96 MAIDEN LANE,  
NEW YORK.

WELL MADE GOLD FINDINGS.



## FAIRCHILD & COMPANY

225 to 233 Fourth Ave.

NEW YORK CITY.

Manufacturers of GOLD PENS, PENCILS,  
PENHOLDERS, SEGAR CUTTERS, SPE-  
CIALTIES, PENCILS SET WITH JEWELS.

*Style, quality and workmanship acknowledged  
the very best.*



### To Jobbers Only—

When you think of Toilet Goods,  
please remember us. Our goods  
are high grade and can be retailed  
at popular prices.

*Special Terms on Early Business*

**Art Stamping & Mfg. Co.**

411 Commerce Street, PHILADELPHIA, PA.



### DATTELBAUM & FRIEDMAN,

Makers of Gold Rings of All Descriptions.

45 John Street, New York.

Our Trade-Mark "D. F." in all our Rings is the guarantee of quality.  
*Send for Catalogue.*

### JOHN S. STIVEN, Gold and Silver Chaser.

Room 219, Electrical Exchange Building,  
156 LIBERTY STREET NEW YORK.

### TRADE-MARKS

OF THE JEWELRY AND KINDRED TRADES.  
Over 4,000 Marks. Second Edition. Price, \$3.00.  
The Jewelers' Circular Pub. Co., 11 John St., N. Y.

## E. H. H. SMITH SILVER CO.

BRIDGEPORT, CONN.

Silversmiths' Building,  
CHICAGO, ILL.

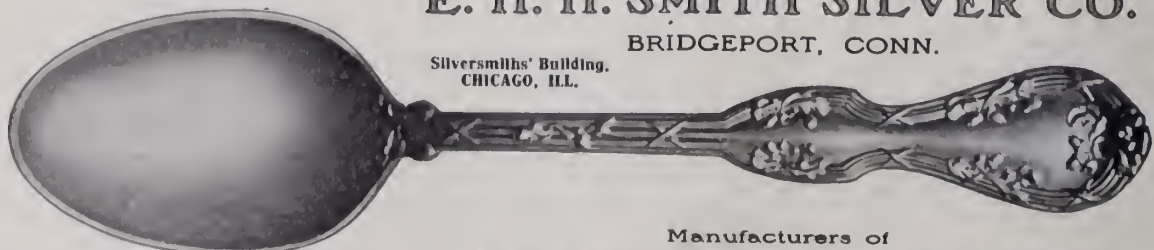

THE OAK.

Manufacturers of

**Sterling Effects in Plate**



**"RAMONA"** is the name of the latest pattern in cut glassware from the Libbey Glass Co.'s works. It is to be seen in the store of C. H. Taylor, the company's New York agent at Park Pl. and West Broadway. Wheat sheaves extend gracefully from the center of the bowl to the edge of the flare and between the sheaves are star effects and fine diamond cuttings. Facets are cut and polished quite as sharply as if the material were diamonds, not glass. The lower surface of this diamond cutting, when touched by the hand, feels as though it were a multitude of pin points, so sharply are the edges finished. This pattern is likely to prove one of the most popular of the many that are shown on Mr. Taylor's sample shelves. Besides the regular cut glass on exhibition, there is an extensive assortment of rock crystal patterns.

**ODD NOVELTIES IN FLEMISH EARTHENWARE** shown at the salesrooms of the Edwin A. Denham Co., 31 Barclay St., New York, comprises many specimens that appeal to those in search of art that is simple and graceful. Besides the staple products which the company sells, it is offering to the trade another class of ware made of finer earth, and with a superior glaze. These vases and bowls are fashioned in the conventional forms suggestive of utility. The colors are brown, blue and green with variations in shading, and it is noticed that no two objects come from the fire exactly alike in tint. An odd circumstance is that some of the vases, subjected to the same process as the others, have, instead of the smooth finish, a lusterless and uneven surface quite suggestive of antique effects. These vases are sold for just what they are and meet with considerable favor. Still another line comes in an evenly dull glaze which is preferred by a part of the trade. Quite an extensive selection of statuettes and busts, modeled in clay, are shown. The subjects are divided between representations of Flemish peasant life and classical reproductions.

**NEW LINES OF FINE LIMOGES CHINA.** Some very attractive lines of decorated china are being shown to the trade by Charles Streiff, 33 Park Pl., New York, who represents William Guerin & Co., Limoges. Buyers will admire the plates with border patterns in gold and rich shades of purple and green. A new underglaze in purple is one of the most pleasing of the color tones. In the encrusted gold work

laurel leaves and sprigs are used in one of the prettiest and most dainty designs, and there are various other vine effects. In Royal Sèvres blue there is a splendid assortment. A collection of footed cups, artistically decorated in gold and colors, will attract the eye. Quite a number of large Sèvres vases are shown, exceptionally fine works, modeled in the well known shapes and ornamented with original paintings signed by artists famed for this kind of work. A visit to Mr. Streiff's salesrooms is always enjoyed by the lover of beautiful ceramic ware and buyers will find this year's assortment more attractive than ever.

THE RAMBLER.

### Recent Reappraisements of Decorated China and Earthen Ware from France and England.

**REAPPRAISEMENTS** of decorated china and earthen ware were announced last week by the Board of United States General Appraisers, at New York, as follows:

Decorated china from Cheippe & Barbarin, Limoges, exported Jan. 27 and Feb. 24, 1906, entered at New York (File Nos. 39094/95); findings of Waite, G. A.: Table services, 100 pieces, Lionel comp., L., 54080/130, entered at 35.10, advanced to 37.80 francs per set; do., comp., H., entered at 31.55, advanced to 34.36 francs per set. Entered value is less 5 per cent. and 2 per cent., advanced value is net. Add case and packing.

Decorated china from Gustave Balleroy, Limoges, exported Sept. 2, 1905, entered at New York (File No. 37368); findings of Waite, G. A.: Services de table, 100 pieces, Lionel T., entered at 46.21, advanced to 46.437 francs per set; do., R., entered at 47.99, reappraised at 46.376 francs per set. Entered values are less discount of 5 per cent. and 2 per cent. Advanced values are net. Add cask.

Earthen ware from John Maddock & Sons, Burslem, exported March 24, 1906, entered at Baltimore (File No. 39552); findings of Hay, G. A.: R. V., white; Peerless, white; Old Savoy, white; Diana, white, unselected, and R. V., white Navarre, entered at discounts of 57½ per cent., 5 per cent. and 5 per cent.; ½ thick vitrified Mouquin Blue Empire thirds, and ½ thick vitrified A408 thirds, entered at discounts of 62½ per cent., 5 per cent. and 5 per cent. Add crates and straw. No advance.

Decorated earthen ware from Glaenger & Co., Paris, reported March 15, 1906, entered at New York (File No. 39292); findings of Hay, G. A.: Majolica plates, invoiced at 5 francs per dozen, Less 10 per cent., 10 per cent. and 5 per cent. Add 10 per cent. Add casks and packing. Importer adds on entry 19.60 francs. Advanced 10 per cent. less importer's addition.

### Right to the Letter.

**A NEW YORKER** was once referring to the stolidity and literal-mindedness of the British shopkeeper, when he was reminded of an amusing experience of a friend in London.

The American had been making several purchases in a jewelry establishment, among others a silver set, and finding that he had with him insufficient funds to defray the entire cost, he asked the clerk to send the set to his hotel, marked "C. O. D."

Due note was made by the clerk; but when the articles arrived at the hotel the purchaser was surprised to find no charges had been collected. Opening the package the American was dumfounded to discover that each piece of silver had been carefully engraved, in a beautiful monogram, "C. O. D."—*Success.*

### Reports on Pearl Fishing in Mexico and Australia.

**CONSUL KAISER** forwards from Mazatlan an article from a Mexican newspaper which says jewelers are learning the value of Mexican pearls, and this season is proving remunerative. The article continues:

"Adrian Cornejo, a prominent pearl fisher of lower California, says that the pearl fishers along the coast of the gulf are doing an excellent business this year. In this part of Mexico there is more variety in the color of the pearls found than in any other part of the world, and comprise black, gray, red, bluish-green and yellowish. Mexican pearls are fast gaining a good reputation in the world markets.

"There is now about as much prospecting for pearls in the Gulf of California as there is hunting for mines throughout the interior of Mexico, and the entire gulf coast is closely inspected by pearl fishers or prospectors. The best pearls are to be found in the bottom of the pearl beds. Among the most valuable pearls to be found in the Gulf of California are those of a reddish color. Those are discovered only occasionally. They have an exquisite luster, and many of them are large and of the most perfect shape."

### RESTRICTIONS ON PEARL FISHING BY AUSTRALIA.

The report on British New Guinea for the fiscal year 1905, just published by the Commonwealth of Australia, contains an amendment to the law relating to pearl shell and *bêche-de-mer* fisheries, under which no ship or boat is to be licensed unless owned by natural born British subjects, naturalized subjects, denizens of British New Guinea or of Australia, and bodies corporate established under the laws of some part of the British dominions. This is said to have been an act of retaliation in view of the German regulations regarding Samoa. The report deals with the natives who are at present in a state of transition. They are said to lead "a most immoral, lazy and sluggish life."

### Gold Used in the Manufacture of Jewelry by Various Countries.

**ACCORDING** to an exchange France heads the list as the country which uses up most gold in the making of jewelry. Her jewelers work up 36,000 pounds weight of gold every year—that is, about 130th of the whole amount produced. Great Britain accounts for an almost equal quantity, and the United States takes 32,000 pounds weight for similar objects, while German craftsmen for that country worked up 30,000 pounds of virgin gold during the past year.

Small as Switzerland is, she absorbed nearly 20,000 pounds weight of fine gold, while Italy and Russia between them took a similar amount. We can procure no accurate statistics from Turkey or India or China, but each of these countries uses a large quantity of gold for purposes of ornament.

The Estherville Jewelry & Music Co., Estherville, Ia., recently held a formal opening, with music and souvenirs.

*Mercantile Fountain Pen*

**The Best Self-Filling Attachment**

made and guaranteed by

**AIKIN, LAMBERT & CO.,** 19 Malden Lane, NEW YORK.

Retail Price:

\$3.00

\$3.50

\$4.50

Send for Price Lists and Discounts.

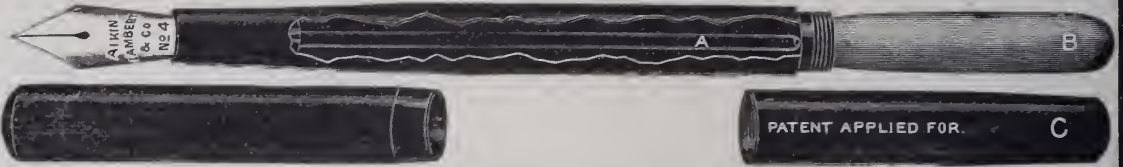

**Boston Jewelry Manufacturing Co.**

**The Mounting and Repairing House of New England.**

We eclipse all others in design, quality, promptness and finish of work.

A line of entirely new styles in mountings always on hand.

Jewelers' Building, BOSTON, MASS.

**The Premier Repairing House of New England**

JEWELERS, SILVERSMITHS, STONE, METAL, SEAL ENGRAVERS AND INCRUSTERS.

LAPIDARIES AND DEALERS IN PRECIOUS AND IMITATION STONES

**REPAIRING**

FANS AND OPERA GLASSES. INLAYING SILVER MONOGRAMS AND INSIGNIA IN PIPES. GOLD PLATING.

**H. E. ALSTERLUND & CO.,**



387 WASHINGTON ST. AND 12 BROMFIELD ST., BOSTON, MASS. All work positively Done in Our Own Factory. Write us for terms and information.

*The* **ST. JAMES**

Corner Walnut and Thirteenth Streets PHILADELPHIA, PA.

**The Ideal Hotel of Philadelphia**

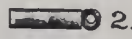
European Plan EUGENE G. MILLER, Mgr.

-  1. Snap complete.
-  2. Outside of Snap.
-  3. Inside of Snap.

**The E. P. H. Patent NON-PULL-OUT Neck Chain Snap**

*is a patented snap that insures the wearer against loss of*

**CHAIN or CHARM**

for it positively will not pull out

Made in 10 and 14 Karat Gold and in Gold Filled.

Can be had of the following Wholesale Selling Agents:

- Messrs. W. Green & Co., 81 Nassau St., New York.  
 M. Sickles & Sons, Philadelphia  
 E. A. Cowan & Co., Boston  
 E. & J. Swigart, Cincinnati  
 Swartchild & Co., Chicago  
 Nordman Brothers, San Francisco  
 Leonard Krower, New Orleans  
 Bauman-Massa Jewelry Co., St. Louis

**PRICES.**

- 14 Karat—Small, \$7 per doz. net  
 Large, \$7.50 per doz. net  
 10 Karat—Small, \$6 per doz. net  
 Large, \$6.50 per doz. net  
 Gold Filled—Small, \$2 per doz. net  
 Large, \$2.25 per doz. net

**HEINTZ BROTHERS.**



• We Make the Largest Line of Solid Gold Set Rings in America for the Retail Trade •

**DIAMOND POINT FOUNTAIN PENS**



No. 2WC \$7.50 per dozen. Guarantee in every box.

Largest Manufacturers of Popular Price Fountain Pens in the United States.

Send for Illustrated price list of 11 Kt Gold Fountain Pens.

Good case assortment 1 dozen pens, \$9.00.

DIAMOND POINT PEN CO.

100-102 Beekman Street, New York

# HOLTZER-CABOT JEWELERS' MOTORS

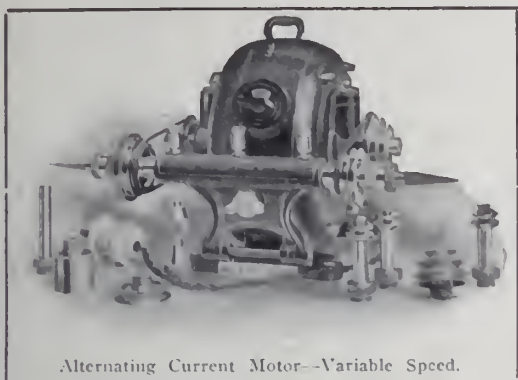

Alternating Current Motor—Variable Speed.

for *BUFFING* and *GRINDING* have had a four years' trial in practically all classes of work. Made for Alternating and Direct Current Circuits, in sizes—1/5 to 1 H. P.—to carry buffing and grinding wheels up to 10 inches diameter.

A full line of chucks for all requirements.

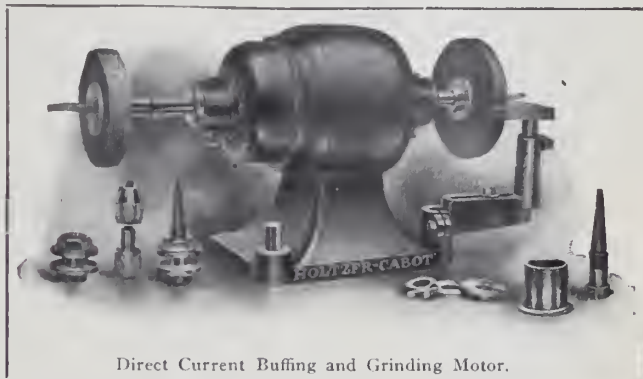

Direct Current Buffing and Grinding Motor.

All our motors are covered by a guarantee of one year.

Write and tell us what class of work you would like to do and we will send you our Form 409, "Special Announcement and Proposition to Jewelry People—

**A LATHE MOTOR ON TRIAL."**

**THE HOLTZER-CABOT ELECTRIC CO., Boston (Brookline), Mass.**

CHICAGO OFFICE, 395-7 Dearborn Street.

## CROUCH & FITZGERALD



**Jewelry Trunks and Cases**

177 Broadway,  
Bet. Cortlandt  
and Dey Sts.

688 Broadway,  
723 6th Ave.,  
New York.

## CRUCIBLES.

Jewelers' Supplies,  
Etc.

Established 1850.

**J. & H. BERGE,**  
95 John Street,  
NEW YORK.

## CASTINGS

Gold, Silver, Bronze, Brass,  
German-silver, Copper & Iron,  
Supply Jewelers, Silversmiths,  
Die-makers, Mould-makers, etc.

Unbreakable Bronze Forces. Hard Bronze Engraving  
Plates. Cast Iron Forces for making Steel Dies.

Chandelier, Undercut Work, Statuary.  
**AUGUST GRIFFOUL,** 313 HALSEY STREET,  
NEWARK, N. J.

# PATENTS

obtained on inventions and designs. Trade-  
marks, prints and labels registered.

**R. W. BISHOP,**  
ATTORNEY AT LAW,

908 G Street N.W., Washington, D. C.

Above Cut Shows Our  
**EXTENSION SPINNING LATHE.**

Swing of lathe 22 inches when closed, 44 inches when extended.  
Substantially built for heavy work.

Write for  
Catalogue  
**P. PRYIBIL,** 512-524 W. 41st St., New York.

**REMOVAL NOTICE**

We now occupy the new store of

The Lorsch Building, 35 Maiden Lane, N. Y.

**WOLFSHEIM & SACHS**

MAKERS OF

Fine Boxes, Trays and Novelties for Jewelers and Silversmiths

35 MAIDEN LANE, N. Y.

Telephone, 3518 John.

**WM. F. RENZIEHAUSEN CO.,  
GOLD and SILVER REFINERS**

Sweep Smelters, Assayers and Analytical Chemists

Rolling of FINE AND STERLING SILVER a Specialty.

Long Distance Telephone, 3759-R.

45-49 Oliver Street, NEWARK, N. J.

Frank Dederick.

Established 58 Years.

James E. Dederick.

**James H. Dederick's Sons,  
Assayers and Bullion Dealers.**

All qualities of Gold and Silver, in Plate, Square and Round Wire, Rolled to any gauge.

ALL QUALITIES OF GOLD AND SILVER SOLDER.

16 Maiden Lane, .. .. NEW YORK.

We buy Old Gold and Silver.

ROLLED GOLD PLATE

**SEAMLESS WIRE AND TUBING**

DUNBAR, LEACH, GARNER CO.,

MANUFACTURERS,

ATTLEBORO,

MASS.

MERIT:—

DISPATCH:—

Two of the many pertinent factors that make us excel.

**CONLEY & STRAIGHT,**

Gold and Silver Refiners,  
Assayers and Sweep Smelters,

236 EDDY STREET, - PROVIDENCE, R. I.

Dealers in Fine Gold,  
Silver and Copper.

All kinds of Gold  
and Silver Anodes.

**SIGNS**

WE have sent signs as far west as Salt Lake City and as far south as Porto Rico. The mails and the railroads make us next door neighbors.

**THE FORMAN CO.  
SIX LIBERTY PLACE  
NEAR MAIDEN LANE - NEW YORK.**

F. JEANDHEUR, Jr.

Rear 17 John St., N. Y. Third Floor.

Gold and Silver Plating

SPECIAL WORK AND COLORING  
IN ALL SHADES A SPECIALTY.

Established 1868.

Platina Plating.

JAMES J. DONNELLY,

Gold and Silver Electro Plater,  
Fire Gilder and Colorer,

41 and 43 Maiden Lane, New York.

Prompt Attention Given to Mail Orders.

**Horological Department,**

BRADLEY POLYTECHNIC INSTITUTE,

Formerly Parsons Horological Institute,  
PEORIA, ILLINOIS.

Largest and Best Watch School in America.

We teach Watch Work, Jewelry, Engraving, Clock Work, Optics. Tuition reasonable. Board and rooms near school at moderate rates. Send for Catalog of Information.



**WE BUY**

Old Gold and Silver Filings, Polishings, Sweeps, Hand Washings, etc. We will make accurate valuations and hold consignment subject to your acceptance. If valuation is not satisfactory, we reship to you at our expense.

**WE PAY FOR OLD GOLD:**

22 K. 88c. per dwt.	12 K. 48c. per dwt.
20 K. 80c. " "	10 K. 40c. " "
18 K. 72c. " "	8 K. 32c. " "
16 K. 64c. " "	6 K. 24c. " "
14 K. 56c. " "	4 K. 16c. " "

MARKET RATES FOR SILVER AND PLATINUM.

Try us and you will appreciate our Squareness, Promptness and Accuracy.

**T. B. HAGSTOZ, Ltd.,** Main Office, 709 Sansom St., Philadelphia, Pa.  
SMELTERS, ASSAYERS, REFINERS.

**WE SELL**

Gold, Silver and Platinum, various qualities, rolled flat or drawn to wire of any gage.

**PRICES OF ALLOYED GOLD:**

10 K. 48c. per dwt.	14 K. 64c. per dwt.
12 K. 56c. " "	16 K. 72c. " "
	18 K. 80c. per dwt.

Gold and Silver Solder, either from formulas furnished or our own. "T. B. H." Alloy, 25c. per oz. Guinea Gold, 75c. per lb. Shot Copper, 40c. per lb. We will send tables for alloying without charge. They save figuring.

**PLATINUM AMERICAN PLATINUM WORKS**  
NEW YORK OFFICE 41 Cortlandt Street  
**NEWARK, N. J.**





P 2796

# Fahys Permanent Case.



P 2377



P 2441

The best case for  
the best works.



P 1951

The best case for  
any works.



P 2806

JOSEPH FAHYS & CO.



P 2802

We Knock Off the  
Middleman's Profit  
on Diamonds.

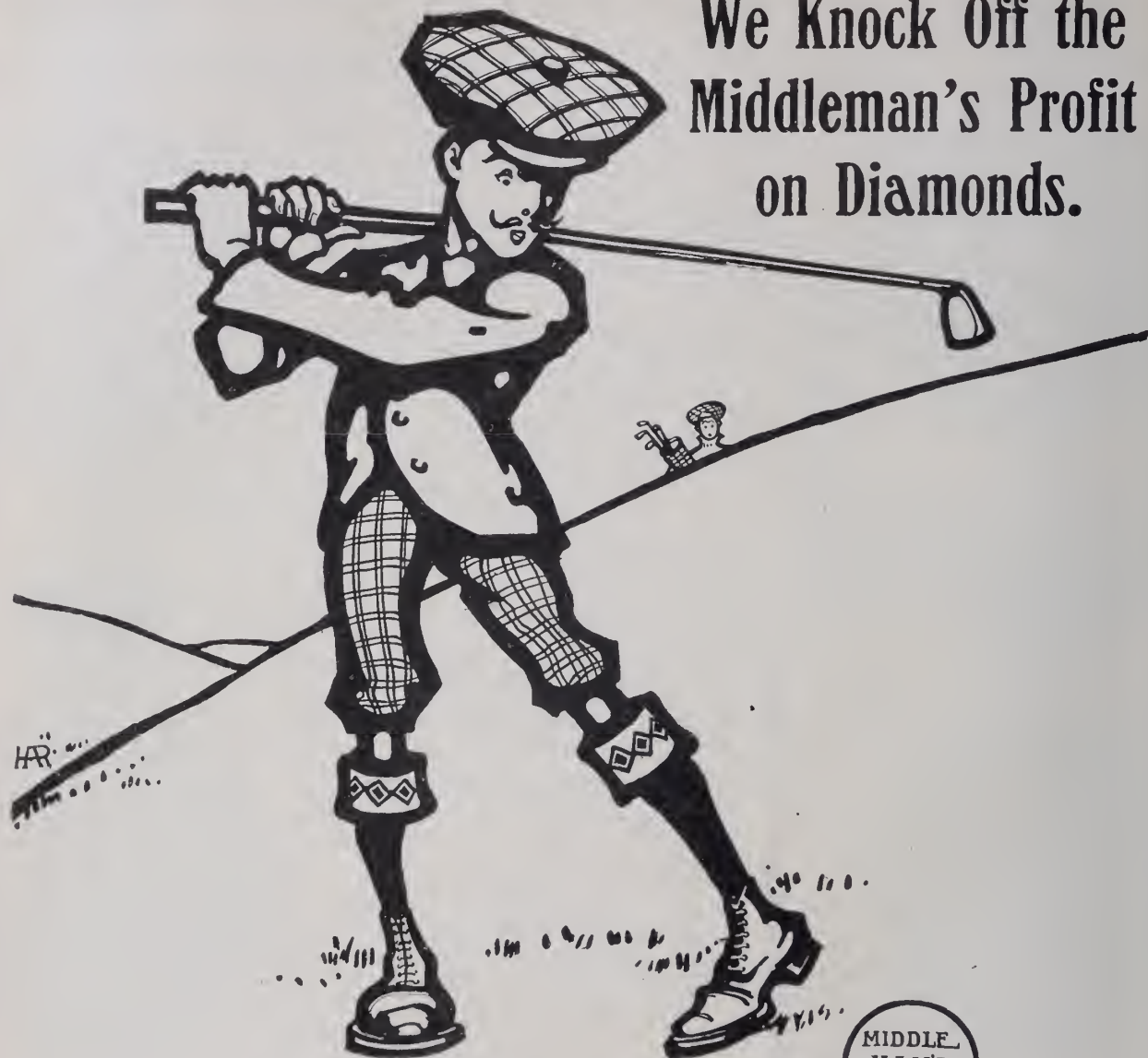

Fact I.—We cut our own diamonds in our own factory.

Fact II.—We employ no salesmen.

Fact III.—We sell direct to the retail dealer.

Either, then, we make a 3-fold profit or we sell for lower prices. An easy way to prove whether the former or latter is true, is to send to us for a selection package and compare our prices with others' the next time you want any diamonds.

Buy direct from the cutter and you'll never fozzle on a sale.



**J. R. WOOD & SONS,**

DIAMOND CUTTERS,

No. 2 Maiden Lane,

New York.



They will come to you for their wedding ring.  
Sell them the best wedding ring in the market.  
A ring you can unconditionally guarantee to be  
exactly what it is represented to be.  
A ring of our manufacture. With all its excel-  
lence it costs no more than inferior ones.

**J. R. WOOD & SONS,**  
RING MAKERS.

2 Maiden Lane,

New York.

# We Have Doubled our Line for the Fall Trade

in Vest Chains, Guard Chains, Fobs, Locketts, Grand Paris, etc., coupled with a large number of new ideas which we will not dwell upon at this time. When you see our line you will wonder at our new creations, and it will bother you to know how we can give you so much for the money. Don't mention it to anyone.

## Design, Workmanship, Quality and Durability

are the four factors  
which have made the

# BIGNEY CHAINS

the most popular in the  
market to-day. They  
are handled and worn  
by more people than  
any other make.

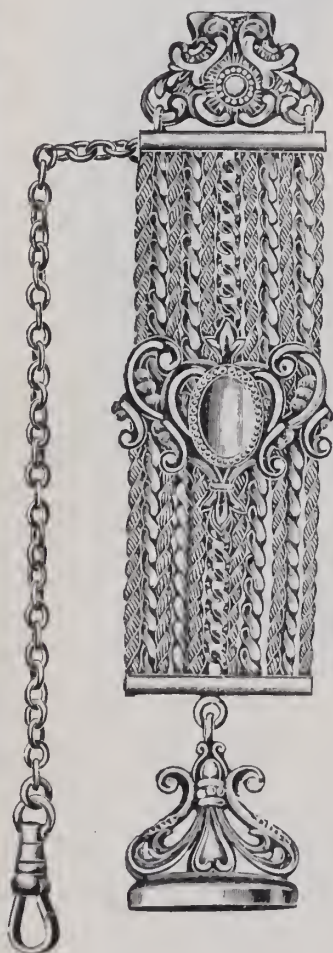

# S. O. Bigney & Co.

NEW YORK OFFICE,  
3 MAIDEN LANE.

FACTORY, Attleboro, Mass.

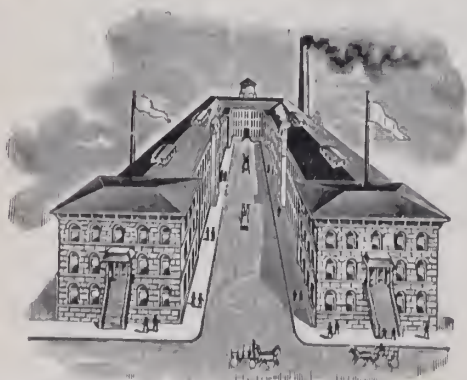

# Watch Case Makers, Remodelers and Repairers.

SPECIAL CASES  
MADE TO ORDER  
FOR ENGLISH, SWISS  
AND  
AMER. MOVEMENTS.

MELTING OLD GOLD  
CASES AND MAKING  
OVER INTO NEW  
CASES (USING SAME  
GOLD) A SPECIALTY.

ENGLISH CASES  
CHANGED TO FIT  
AMERICAN S. W.  
MOVEMENTS  
WITHOUT  
ALTERING OUTSIDE  
APPEARANCE.

KEY WIND CASES  
CHANGED TO STEM  
WIND.

HUNTING CASES  
CHANGED TO  
OPEN FACE.

OLD WATCH CASES  
REPAIRED AND  
RENEWED.

**Wendell & Co.,**  
**2**  
**WONDERFUL SHOPS:**  
103 & 105 William St.,  
NEW YORK.  
57 Washington St.,  
CHICAGO.



How an English Case Came to Us.



How it was Remodeled for Amer. S. W. Movement.

## New Claws on Diamond Rings.

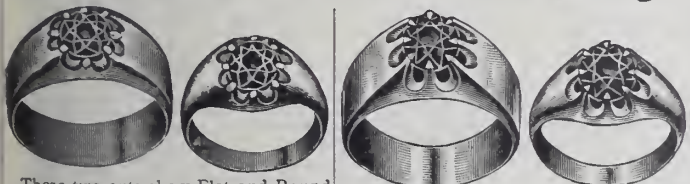

These two cuts show Flat and Round Belcher Rings as received, with claws badly worn off and too low to permit resetting stones again.

These cuts show the same rings with new high claws, stones securely reset, and entire rings refinished like new.

Price for six new claws, resetting stone and refinishing ring like new .....\$1.50 to \$3.00, list.  
Price for eight new claws, resetting stone and refinishing ring like new .....\$2.00 to \$4.00, list.

We retip or put new claws on diamond Tiffany, Belcher, Tooth and rings of every description, to cost from \$1.50 to \$4.00, list, according to the condition of ring and number of claws on setting.

**Wendell & Company,**  
103 and 105 William St., NEW YORK.      57 Washington St., CHICAGO.

For 22 years we have been doing  
**Gold and Silver Plating.**  
Sterling and Plated Ware Repairing for the Trade.  
Do we do yours?  
Our plating rooms are the best equipped in the country for job work.



How It Came In.



How It Went Out.

**WE REPAIR**  
any article in the silverware line; making new parts to match the old ones that have been melted or broken off, the same as new.

**WE REPLATE**  
any metal article in gold, silver, nickel, bronze, brass, oxidized silver, old bronze, statuary bronze, and all antique finishes.

**Wendell & Company,**  
Repairers and Special Manufacturers for the Retail Jewelry Trade  
**TWO WONDERFUL SHOPS:**  
103 and 105 William Street, NEW YORK.      57 Washington Street, CHICAGO.

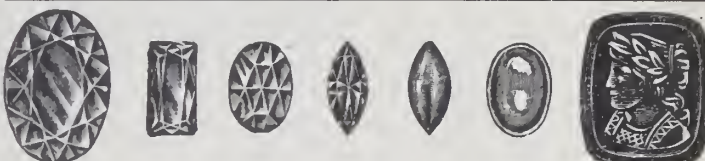

## Stone-Setting.

We carry a most complete stock of Precious and Semi-Precious Stones for special work and replacing lost sets. We import them direct from the cutters in Europe, and furnish them to the trade in single stones at dozen and gross prices.  
Have your stone-setting done in our shops and save from thirty-five to fifty per cent.  
We employ first class setters, and turn out work very promptly.  
No job too small to receive our careful attention.

**Gold Chains Refilled, Renewed and Repaired.**  
Old Chains made over into new patterns, using same gold.  
**GOOD WORK. LOW PRICES. PROMPT ATTENTION.**

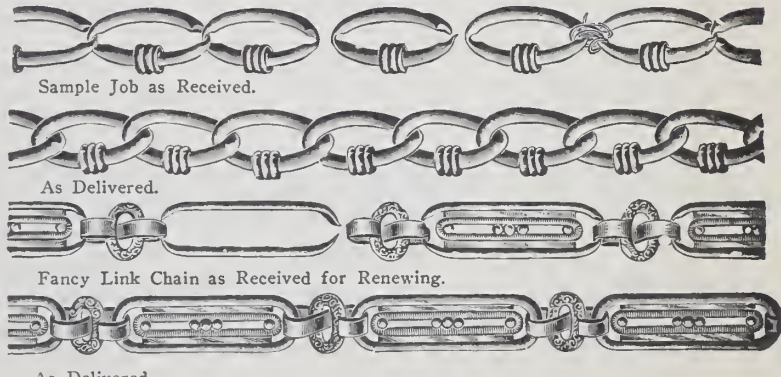

Sample Job as Received.

As Delivered.

Fancy Link Chain as Received for Renewing.

As Delivered.

**Wendell & Company,**  
The Special Manufacturers for the Retail Jewelry Trade.  
**TWO WONDERFUL SHOPS:**  
103 and 105 William Street, NEW YORK.      57 Washington Street, CHICAGO.

---

---

## A Watch Case That Will Answer.

---

**W**HAT VIRTUES do you look for in a 20-year Watch Case, what degree of wear, finish, beauty? Set your own standard, and don't be afraid of setting it too high. The

# WADSWORTH

(Warranted)

# TWENTY-YEAR

Watch Case can answer for itself, surpassing expectations, more than meeting every reasonable demand and requirement.

Popular because good; economical because reasonable in price but high in merit.

---

### *The* Wadsworth Watch Case Co.

CHICAGO  
Columbus Building

SAN FRANCISCO  
717 Market St.

NEW YORK  
49 Maiden Lane

FACTORY, DAYTON, KY.

---

---

---

---

## The Thinnest and Most Compact Models,

Handsome Designs, Perfect Workmanship  
and Reliable Quality.

# WADSWORTH

Gold and Gold Filled

# WATCH CASES

Represent the Highest Art in American  
Case-Making.

Ask your Jobber for them.

---

### *The* Wadsworth Watch Case Co.

CHICAGO  
Columbus Building

SAN FRANCISCO  
717 Market St.

NEW YORK  
49 Maiden Lane

FACTORY, DAYTON, KY.

---

---

# STERN BROS & CO



NOW READY.  
**An Entirely  
 New Line**

of Stone and Signet Rings in  
 original and exclusive designs.

**POPULAR PRICES.**



**Stern Bros. & Co.,**  
 33-43 Gold St., New York.

Manufacturers for the Jobbing Trade  
 Exclusively  
 at

- |            |                  |
|------------|------------------|
| Fobs       | Link Buttons     |
| Studs      | Rings            |
| Crosses    | Hat Pins         |
| Locketts   | Pendants         |
| Thimbles   | Baby Pins        |
| Bracelets  | Tie Clasps       |
| Scarf Pins | Screw Earrings   |
|            | Ring Mountings   |
|            | Bead Neck Chains |

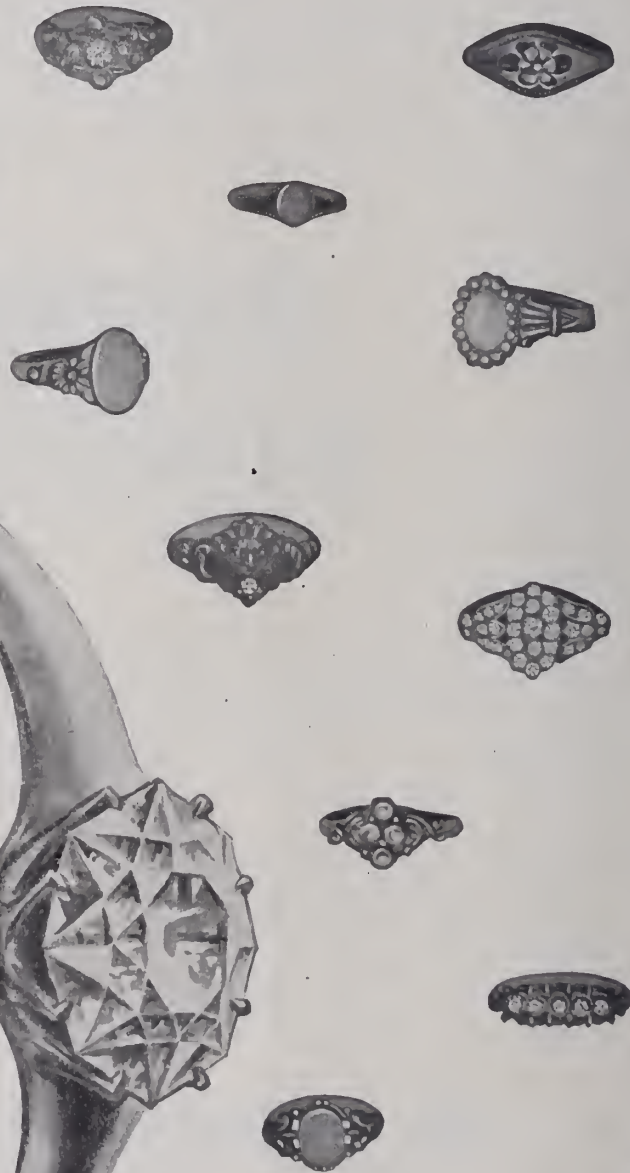

Salesrooms and Offices of Diamond Department, 68 Nassau Street, New York  
 Diamond Cutting Works, 142 West 14th Street, New York

**BRANCH OFFICES**

- |                    |     |                  |
|--------------------|-----|------------------|
| Chicago, Illinois  | - - | 103 State Street |
| London, England    | - - | 29 Ely Place     |
| Amsterdam, Holland | - - | 12 Tulp Straat   |





**A**MONG the various historical styles of decoration suitable for silverware, none has attained a more lasting popularity than that associated with the name of Louis XIV of France, le Grand Monarque. ¶ It is for this reason that the Whiting Company have decided to introduce a novel and original treatment of this favorite form of French Renaissance applied to a very complete line of Hollow Ware, characteristic examples of which will be here shown from time to time.



**WHITING MFG. CO., SILVERSMITHS**

Broadway and 19th Street, New York.

# Progression

This word signifies the course, and

# Success

indicates the goal attained by

## Dueber-Hampden Watches

**Pre-eminently and indisputably the  
Successful American Watches**

in all sizes and grades.

Requiring no assistance but their own inherent value to find a market, and depending on no combination to bolster up weakness and lend help to force sales, they should be valued accordingly by fair-minded, independent, self-respecting Americans.

## **The W. J. JOHNSTON COMPANY,**

Wholesale Agents of the Leading American Watch Companies,

**Fifth Avenue and Market Street, Pittsburgh, Pa.**

# Looking Forward

is ever necessary

## To the Successful Merchant.

**What you sell to-day is responsible  
for your future Reputation  
and Prosperity**

If poor judgment is used you are entitled to no more excuse than though you had deliberately sold what you knew to be inferior goods.

There is always "**THE BEST,**" and in watches that term stands out prominently for

# Illinois Watches and Hamilton Watches

**The W. J. JOHNSTON COMPANY,**

Wholesale Agents of the Leading American Watch Companies,

**Fifth Avenue and Market Street, Pittsburgh, Pa.**



### Mr. Coffee Machine—

Mr. Coffee-Pot, I must bid you adieu. I have gained such a prestige with the women of late that your presence disgusts me. Women of high standing have complimented me in the highest degree as an excellent coffee maker. I distill my coffee while you still stick to the old time methods of boiling coffee. Away! You are doomed.

I shall hereafter take up my abode in Jewelry Stores to demonstrate to the women my qualities, whence I will proceed to some private residence to make happy the hearts of the household.



### Mr. Coffee-Pot—

Mr. Coffee Machine, I realize the fact that my days are numbered. While I have rendered my services to the public for years and years, you have unquestionably superseded me in my efforts to master the art of good coffee making. I am firmly convinced that my last resting place will be in the depths of the ash-heap.

It is almost impossible for me to secure a position as I am not familiar with modern methods of coffee making. My mistress even rudely ejected me from the house yesterday and hinted strongly at securing your services. You look so nice in your silver-plate attire, most any Jeweler would employ you, and you are so friendly with the ladies, too. Good-by, for ever.

## S. STERNAU & CO.,

New York Salesrooms:  
PARK PLACE, cor. Broadway,  
Opposite Post Office.

MAKERS OF  
Chafing Dishes and Their Accessories,  
Trays, Fancy Kettles, Smoking Sets, Etc.

Office and Factory:  
195 PLYMOUTH ST.,  
BROOKLYN, N. Y.

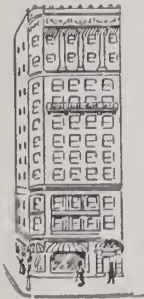

NEW YORK OFFICE  
820 FIFTH AVE. COR. 387 ST.  
IN THE "NEW WHOLESALE DISTRICT"

Our New Line for  
the Coming Season  
is NOW READY.

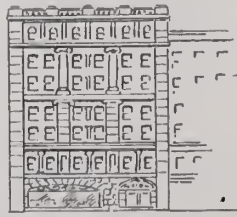

REMOVED FROM  
23 MAIDEN LANE.

# 2 Moves

## May 1, 1906.



NEWARK N. J.

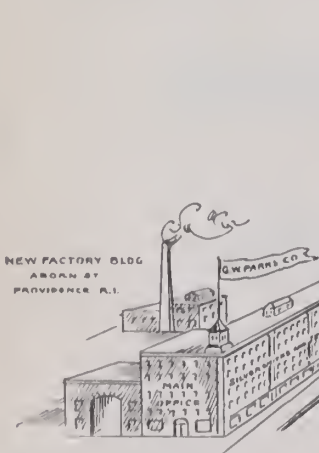

NEW FACTORY BLDG.  
ABORN ST.  
PROVIDENCE R. I.



TRADE MARK

This illustration shows our double move.  
MAIN OFFICE AND WORKS FROM NEWARK, N. J.,  
TO PROVIDENCE, R. I.  
NEW YORK OFFICE FROM MAIDEN LANE,  
To "The New Uptown Wholesale District"

# G. W. PARKS CO.

Makers of Sterling Silver Wares.  
PROVIDENCE, R. I.



GREAT MANY of the leading jewelers of America are pushing the sale of *ILLINOIS WATCHES* because of their superior quality.

If you are not entirely satisfied with the line of watches you have been selling, we would be glad to have you try a few of our manufacture.

We are sure you will find them satisfactory in every way and of greater value than comparative grades of other makes.

If your jobber does not carry them, write us for price list and discounts.

# Illinois Watch Company

## SPRINGFIELD.

Retail selling prices of  
Railroad grades established  
and maintained.

# THE Bracelet Hit OF THE Season.



THE illustrations, which are exact size, show two of the best selling Bracelets of a big bracelet season.

Made of Rolled Plate, Pierced, Engraved—a neat, strong joint and catch—with and without stones, from  $\frac{1}{2}$  to  $\frac{1}{4}$  inches wide.

Our line offers an unsurpassed range of styles.

ASK YOUR JOBBER—HE HAS THEM.

**WHITING & DAVIS, Plainville, Mass.**  
NEW YORK OFFICE, 7 MAIDEN LANE.

We Make

## BRACELETS

both in Joint and Nethersole—with and without stones.  
Call on us for the P. & B. Co. lines of

FOBS, LOCKETS,  
TIE CLASPS, BROOCHES,  
SCARF PINS,  
HAT PINS.



BABY PINS, BEAD NECKS,  
CUFF BUTTONS,  
CROSSES, BRACELETS,  
AND WAIST SETS.



Potter  
&  
Buffinton  
Co.,

Providence,  
R. I.

NEW YORK OFFICE,  
65 Nassau Street.

San Francisco Office,  
206 Kearny Street.



Our New  
ACME  
Joint.  
Pat. May 22 1906.

*"We never follow the Fashion, the Fashions Follow Us."*

MAURICE L. POWERS.



JOSH W. MAYER.

*Always in Red.*

## Brooches and Pendants.

ONE of the strongest features of our coming exhibition, to be held in our offices between August 13th and 18th, inclusive, will be the gorgeous stock of Brooches and Pendants. There is absolutely no limit to our productions. There will be a new era displayed in the designs of these ornaments. In our former exhibitions we have displayed certain periods, but we shall do our utmost to show a most exclusive line of the newer style Platinum work, such as has never been produced in our line of business.

If there is any part of a Jeweler's stock that does not seem to sell readily, there must be a reason for it. Perhaps it may be due to the fact that the styles are commonplace and not up-to-date. We respectfully extend to the Jewelers of this country an invitation to view some of our new and novel productions. It will be a means, no doubt, of infusing new life into Diamond mounted goods. Our designers know how to take advantage of all the little points that make the "Correct Thing" demanded by the season's fashion, and, besides, add that indefinable something which puts our productions in a class by themselves.

### **POWERS and MAYER,**

Makers of Diamond Mounted Goods THAT SELL.

258-260 Fifth Avenue,

NEW YORK.

We are always pleased to ship goods on memorandum when satisfactory references are given.

# BATES & BACON,

ATTLEBORO, MASS.

Makers of

HIGH GRADE CHAINS.

The BEST SAFETY FOB is one of our specialties; Gent's Vests, Dickens, Lorgnettes, Secret Locket Chains, Lockets, Chate-laines, and the unexcelled

## "Bates" Bracelet

"KANT-KUM-OFF"

We make these Bracelets in

### Seven Sizes.

Just on the market—A New Flat Seamless Wire Bracelet, made with the "WINNA" Joint and Catch. Patented.

Ask your jobbers for **OUR GOODS.**

New York Office, 9 Maiden Lane.  
Chicago Office, 103 State Street.

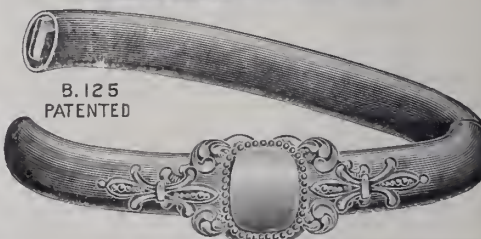
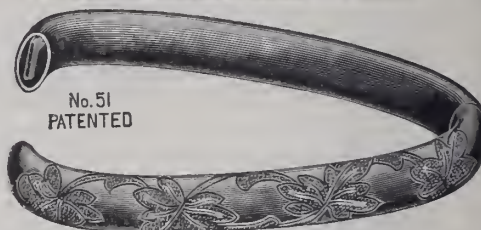
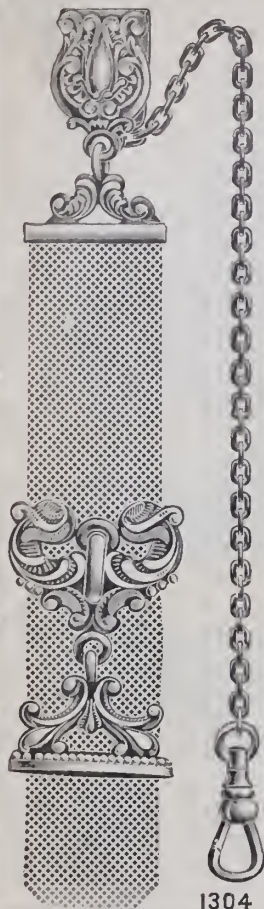

## Sample Assortments on Approval



**B1822**  
Gold-filled Netting. Signet and other designs.  
\$12.00 doz.



### Don't Miss This

Now is the time that you need a good assortment of bracelets in stock and **We Have the Goods** to supply your needs.

We will send a \$15 assortment of the latest designs in bracelets to you **on Approval**, and if they prove unsatisfactory on examination, you may return them at our expense.



**B1821**  
Gold-filled Netting. Signet and other designs.  
\$12.00 doz.

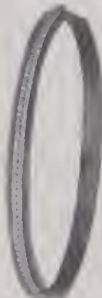

**B1823**  
\$2.00 doz.



Are You Buying **COMBS** Right?

DO YOU SELL AS MANY AS YOU OUGHT?

We will send you a \$25 assortment of combs in the latest designs and finish. This assortment will make an excellent display and will attract the attention of every one. We will send these combs **on Approval**, and if you are not satisfied with them on examination you may return all or a part of them at our expense.

It costs you nothing to see these goods, so why not write for an assortment to-day?

## C.H. Eden Company

Manufacturers of Combs, Hair Ornaments and Jewelry,  
ATTLEBORO, MASS.

New York Office, 699 BROADWAY.



**B1839**  
Brilliant Bracelets, set in stones of various colors.  
\$7.50 doz.



**NORMA**  
TRADE MARK

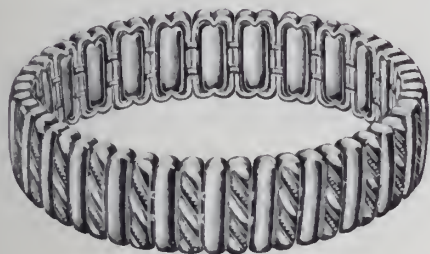

No. 253.



No. 265.



No. 254.



No. 271.

**NORMA**  
TRADE MARK

# The New NORMA

*Patented*  
*Adjustable Bracelets*



Examine our Popular Prices  
ranging from

**\$16.50 to \$36.00**  
*per dozen*

---

The illustrations represent a few of the many styles we make.

THE QUALITY OF ALL THESE  
GOODS IS FULLY GUARANTEED

Send for our new illustrated booklet of patterns and prices.

---

MADE ONLY BY

**The F. H. Sadler Co.**

80 County Street,  
ATTLEBORO, MASS.

Address all communications to Attleboro, Mass.

New York Office, - 180 Broadway.  
Room 43.

GOLD  
RINGS

BROOCHES AND MOUNTINGS

Also GOLD FILLED RINGS, including the popular THREE CROWN

Ostby & Barton Company respectfully announce to the jobbing trade that their fall line comprising many new and original designs is now ready.

OSTBY & BARTON COMPANY

New York, 13 Maiden Lane  
Chicago, 103 State Street

PROVIDENCE, R. I.

The "Bryant" Rings.

WE have made the **Bryant Rings** for 50 years, and know how to make first class goods. The stone setting—which every retailer knows is a very important part of the work—we give special attention to. The **Bryant Rings** will help your reputation as a first class Jeweler.



TRADE-MARK.

M. B. BRYANT & Co., No. 7 MAIDEN LANE,  
NEW YORK.



The Bowden Rings

ARE COMPLETE IN VARIETY, CORRECT IN  
QUALITY AND PERFECT IN FINISH. WE  
MAKE EVERY VARIETY OF FINGER RINGS.

J. B. BOWDEN & CO.,

1 Maiden Lane.

NEW YORK.

-  1. Snap complete.
-  2. Outside of Snap.
-  3. Inside of Snap.

**The E. P. H. Patent  
NON-PULL-OUT  
Neck Chain Snap**  
*is a patented snap that insures  
the wearer against loss of*  
**CHAIN or CHARM**  
for it positively will not pull out

Made in 10 and 14 Karat Gold and  
in Gold Filled.

Can be had of the following *Whole-  
sale Selling Agents:*

- Messrs. W. Green & Co.,  
81 Nassau St., New York.  
M. Sickles & Sons, Philadelphia  
E. A. Cowan & Co., Boston  
E. & J. Swigart, Cincinnati  
Swartchild & Co., Chicago  
Nordman Brothers, San Francisco  
Leonard Krower, New Orleans  
Bauman-Massa Jewelry Co.,  
St. Louis

**PRICES.**

- 14 Karat—Small, \$7 per doz. net  
Large, \$7.50 per doz. net
- 10 Karat—Small, \$6 per doz. net  
Large, \$6.50 per doz. net
- Gold Filled—Small, \$2 per doz. net  
Large, \$2.25 per doz. net

**SAML BUCKLEY & CO.**  
English Fancy Goods.



Carry in New York a full line of  
**ENGLISH PLATED WAITERS.**  
118-122 Holborn, E. C.,  
London, England.  
100 William St., New York.

# WORLD BRAND SILVER



**50%**

*More Silver than Standard Plate*

¶ The great variety of beautiful designs, the exquisite finish and the wonderful durability of our silver will appeal to every experienced dealer who looks over our line. ¶ Write for trade catalogues, with "costs you" prices. Factory shipment as low as \$10.

*"The best dealers handle it because  
the best people ask for it."*

**The American Silver Company**

BRISTOL, CONN.

46 West Broadway, New York.

Silversmiths' Building, Chicago, Ill.

**REMOVAL NOTICE**

We now occupy the new store of

**The Lorsch Building, 35 Maiden Lane, N. Y.**

**WOLFSHEIM & SACHS**

MAKERS OF

Fine Boxes, Trays and Novelties for Jewelers and Silversmiths

**35 MAIDEN LANE, N. Y.**

Telephone, 3518 John.

Factory, 10 Gold Street.

## Chains to Accompany Lorgnettes.



EXPERIENTIA  
DOCET

THE fitness of things is carefully regarded in the Chains we make to go with our Lorgnettes. Each has its appropriate Chain, one supplementing the other beautifully. Two sales instead of one, where shown.



EXPERIENTIA  
DOCET

PRICES: \$30.00 to \$300.00

**Durand & Company,**

49-51 Franklin Street,  
Newark, N. J.



TRADE **14** MARK

**OSMUN-PARKER MFG. CO.**

MAKERS OF

Fine Pearl and Diamond Goods

338 Mulberry Street, NEWARK, N. J.



Fancy Designs in  
*Jewelry* OF ALL KINDS.

Collarettes, Brooches,  
Scarf Pins, Buttons,  
Necklaces, Hatpins, Etc.

**A. J. Hedges & Co.,**

Makers of Exclusive Designs  
in 14K. Jewelry,



14 John Street, New York. TRADE-MARK

ESTABLISHED  
1871.

Factory and Office: Newark, N. J.

INCORPORATED  
1900.

# CARRINGTON & CO.,

*Patent Pocket Match Box*

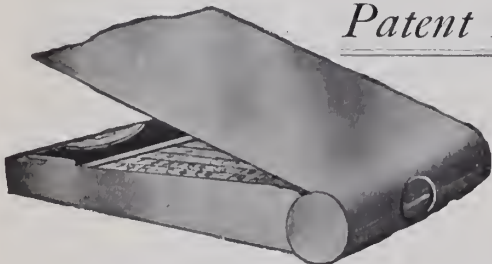

14K. ONLY IN STOCK.

Book Safety Matches with  
Steel Cigar Cutter.  
(Patented.)



Sales Agent:  
7 Maiden Lane,  
NEW YORK.



Adjustable  
Solid Gold

## Glove Garters

in Gold, Silver and Plated.  
THAT NEW THING.

OUR

Showings of Gold, Gold Filled  
and Silver Jewelry for Spring  
are complete in

- |             |                   |
|-------------|-------------------|
| Brooches    | Crosses           |
| Links       | Rosaries          |
| Scarf Pins  | Fobs              |
| Bracelets   | Combs             |
| Hat Pins    | Waist Sets        |
| Buckles     | Collar Supporters |
| Dog Collars | La Vallieres      |
- etc.

**Chas. L. Trout & Co.**

15 Maiden Lane, New York.

# HEINTZ BROTHERS.



• We Make the Largest Line of Solid Gold Set Rings in America for the Retail Trade •

TRADE-MARKS

OF THE JEWELRY AND KINDRED TRADES.  
Over 4,000 Marks. Second Edition. Price, \$3.00.  
The Jewelers' Circular Pub. Co., 11 John St., N. Y.



## New Comb Creations

**T**HE BEAUTIFUL is always combined with the New in our Comb creations.

Special attention is invited to the

ENGRAVED EFFECTS introduced this season. Impressively rich.

Where pearls are used, their Quality and Uniformity are worthy of note.

Stones in harmonious combinations add their brightness and dignity.

Designs are at once artistic and distinctive.

Combs have for many years been a leading specialty here.

## Day, Clark & Company

14 KARAT  
ONLY



23

Maiden Lane  
New York



## WHITESIDE & BLANK



COLLAR PIN NO. 7037  
HANDY PIN NO. 5012

Made in One Piece, 14 Karat Gold,  
with Pearl or Fancy Stone Center.  
Polished, Roman or Rose Finish.

NEWARK, N. J.,  
Lafayette and Liberty Streets.

NEW YORK,  
14 and 16 John Street.

ESTABLISHED 1841.

## Carter, Howe & Co.

TRADE MARK



MANUFACTURERS OF

## Gold Jewelry,

9, 11, 13 MAIDEN LANE, - NEW YORK.

FACTORY, NEWARK, N. J.

A. CARTER.

G. R. HOWE.

W. T. CARTER.

W. T. GOUGH.

## SCARF PINS

TRADE MARK



Established in New York 1837.

## Geo. O. Street & Sons.

24 JOHN ST., NEW YORK.  
103 STATE ST., CHICAGO.



Quality and  
Finish Consistent  
With Twenty  
Years' Experience

Original and  
Exclusive  
Designs



**MOORE & SON,**  
NEWARK, N. J.

ESTABLISHED 1886. INCORPORATED 1903.

**ALLSOPP & ALLSOPP'S**  
HIGH CLASS  
**BRACELETS**  
MOUNTED IN COMBINATIONS OF



Dia. and Pearl  
Dia. " Sapphire  
Dia. " Emer'lds  
Dia. " Baroques

Amethysts  
Topazes  
Peridots  
Aquamarines  
Etc.

18-20 COLUMBIA ST.  NEWARK, N. J.

"THE BRACELET HOUSE."  
**KENT & WOODLAND,**  
BRACELETS FOR EVERY WOMAN AND MISS.

16 John Street, New York.

San Francisco Office,  
Care JULIUS A. YOUNG.

"Nethersole Bangles,"  
Plain and with Stones.  
"Pinhole" Secret Snap,  
with and without pre-  
cious and semi-precious  
stones.



**SOLID GOLD CHAINS**

Gold Chains that don't have to first pay the heavy expenses of traveling salesmen, before a selling price is placed on them, are chains that to-day are interesting the careful and exacting buyer.

WE are the makers of just such

**SOLID GOLD CHAINS**

TRADE  MARK

Are YOU one of these careful and exacting buyers?  
For 56 years critical Jewelers have found our Chains ready sellers, very profitable to handle and most durable in service.  
We have no salesmen, and our prices are therefore very low. We will be pleased to send you a selection package.

1850 1906  
**ALOIS KOHN & CO.**  
Makers of  
**SOLID GOLD CHAINS**  
of every kind.  
16-18 Maiden Lane  
New York



**M. SCHIFF**  
Established 1876  
82-84 Nassau St., N. Y.  
Phone 801 John.

Manufacturer of fine  
Diamond Mountings, Locketts  
and Buttons. Patentee of

**THE NEW IMPROVED  
Ear Screw**

The only one on the market  
of its kind, absolutely secure.  
Special attention paid to all  
order work.

# MONOGRAMS.

In Gold, Silver and Plate.

A complete line of Two and Three-Letter Monograms always in stock.

SPECIAL DESIGNS TO ORDER.

Elegant  
Silk Ribbon  
and  
Leather Strap  
FOBS.

Always  
Acceptable as  
Gifts.

A Beautiful Solid  
14-K. Gold  
Monogram Fob  
with Ribbon and  
Swivel, complete,  
any three  
letters desired,  
for

**\$10.<sup>00</sup>**

Send for new  
Illustrated Catalogue,

showing the largest  
selection of stock  
Fob Monograms,  
from 50c. in Gold Plate  
upward.

Create a demand for  
these Fobs by display-  
ing a few samples in  
your window.

### WIDE STRAP FOB.

English Pig Skin, Tan or  
Black, Take your choice.

Monograms to order, two  
or more letters, same  
price.

Gold Plated...each \$4.50  
Gold Filled...each 7.50  
14-karat Gold, each 15.00

These prices are list  
and subject to discounts  
as shown in our new  
illustrated catalogue.

MONOGRAMS  
AND INITIALS FOR  
POCKET BOOKS,  
BAGS, ETC.

**OUR  
SPECIALTY :**

Send for Fob and Monogram Catalogue  
or other information to

**Thomas J. Dunn & Co.,**  
101 and 103 Chambers St.,  
Dept. J. NEW YORK CITY.

# Look for the Stamp

on back of



The Standard American Collar Button.

# Krementz Collar Buttons and Studs

## The Government Stamp

on every bar of gold issued by the U. S. Assay Office giving its Quality, Weight and Value, is known and accepted all over the world as absolutely correct.

## The Kremmentz Stamp

is universally recognized by dealers and wearers with the same confidence.



# KREMENTZ & CO.,

49 Chestnut Street,

Dept. A.

NEWARK, N. J.

Send for booklet "The Story of a Collar Button"—Free

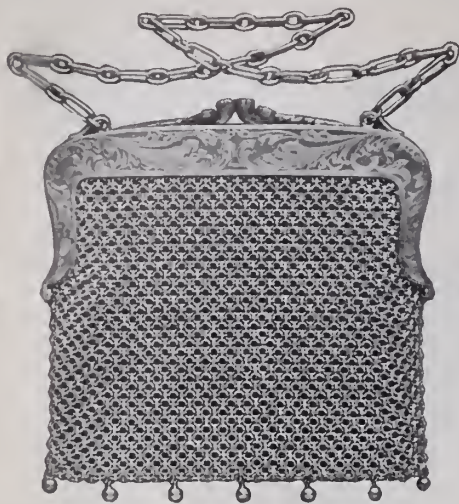

# S. Cottle Co.

are showing an entirely new and exclusive line of Gold and Silver BAGS and PURSES, also many lines of BRACELETS—all of superior workmanship and design.

31 East 17th Street,  
New York.

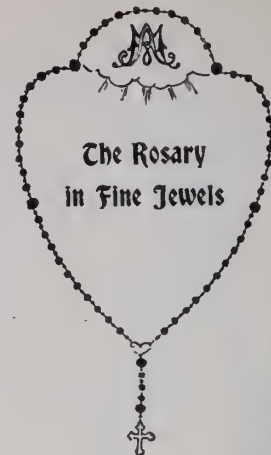

The Rosary  
in Fine Jewels

Fine Rosaries in pure and imitation stone. Mounted in solid gold and rolled gold-plate

ALL COLORS.

## Bridesmaids' and Ushers' Pins

We would suggest something with color. Brooches, Scarf Pins and Handy Pins with Amethysts, Topazes, Garnets, Peridots, Aquamarines, Jades and Baroque Pearls. We have a large variety of patterns at moderate prices.

REGARDING OUR FOBS WE HAVE NOTHING TO SAY—  
THEY SPEAK FOR THEMSELVES.

## SNOW & WESTCOTT,

Makers of Good Jewelry for Over Seventy Years,

21 MAIDEN LANE,

NEW YORK.



Our special illustrated catalogue will give interesting advice regarding prices and discounts.

MADE BY

## The W. J. Feeley Co.

Providence, Rhode Island,

Ecclesiastical Art Metal Workers.

Everything New Under the Sun  
IN MODERN JEWELRY  
OF EVERY DESCRIPTION

## Signet Rings

(OUR OWN MAKE)

A SPECIALTY.

We Solicit Memorandum Orders.

L. Witsenhausen

47-49 Maiden Lane,  
New York.

Manufacturers of MODERN JEWELRY  
Chicago, 405 Masonic Temple.  
(L. KATLINSKY.)

ADOLPH LUTHY.

PERCY W. HINE.

## LUTHY & HINE,

13 EAST 30TH STREET, - NEW YORK.

MANUFACTURERS OF

### Artistic Gold and Platinum Mounted Diamond Jewelry.

Odd and Exclusive Patterns in NECKLACES, BROOCHES, BRACELETS,  
RINGS, RIBBON COLLARETTES, Etc.

MOUNTED WITH AQUAMARINES, PERIDOTS, AMETHYSTS  
AND OTHER PRECIOUS STONES.

(DIAMOND MOUNTED COMBS A SPECIALTY.)

## DESIGNS For Silverware, Novelties and Jewelry . . . FINE ETCHING

All goods left with us for etching are covered by policies which fully insure our customers against loss by fire or theft.

CHARLES M. PRIOR (PHONE 1224 HARLEM) 1683 Madison Ave., New York





**W**E have sold quite a quantity of the new Howard Watches and have never had a complaint; they give the greatest satisfaction and are intended for, and will hold fine trade. We are prepared to fill orders on these speedily. You will enhance your reputation by carrying this excellent line of watches, which is being extensively advertised to the consumer. The Company will co-operate with you in pushing the sale of these goods—we will be pleased to furnish particulars.

**Henry Freund & Bro.**  
 "SELLERS OF SELLERS,"  
 71 Nassau St., New York.

Elk and F. O. Eagle Goods  
 a Specialty.

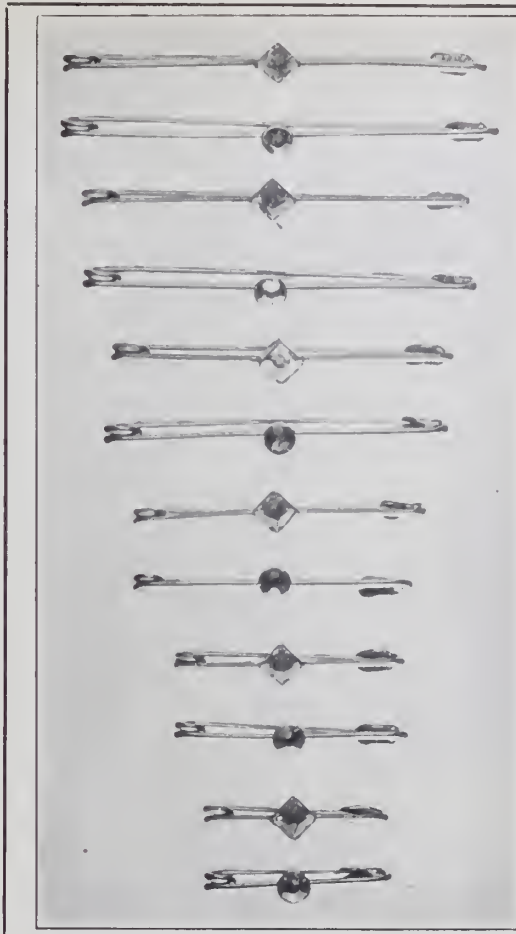

# All Smart Dressers

WEAR THE NEW SOLID GOLD SCARF AND HANDY PIN.

Made in sizes from 1 inch to 2 1/4 inches.

Mounted with Stone or perfectly plain. They are brisk sellers and profitable to handle. Write for prices.

**SCHULTZ, LEISS & CO.**

OFFICES:  
 14 John Street, New York. 103 State Street, Chicago.  
 FACTORY: Cor. McWhorter and Oliver Streets, Newark, N. J.



# Ross, Saltman & Anderson

MANUFACTURERS OF  
**Rings and Diamond Mountings**

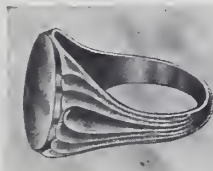

699



204

89 FULTON STREET,  
 NEW YORK

Jewelers will find it desirable and profitable to keep in touch with our new and artistic monthly productions. They represent that originality and perfection upon which we propose to establish a substantial reputation.

# THE MOUNTING THAT SELLS

Earscrews,  
Earrings,  
Studs,  
Scarf Pins,  
and Rings  
of every description.



Made in  
Platinum,  
18K.,  
14K.,  
all sizes.

It gives light and brilliancy to the stone.

Manufacturer of a general line of Platinum,  
18K. and 14K. Mountings.  
Prompt attention given to special order work.  
Estimates and designs submitted.  
Diamonds recut and repaired.

## JULIUS WODISKA,

40 JOHN STREET,

NEW YORK.

# Koshland & Italic Co.

702 Chestnut Street,

PHILADELPHIA, PA.

## FAHYS FILLED CASES.

We handle exclusively . . .

Fahys Permanent

Guaranteed Permanently.

Fahys Montauk

Guaranteed 20 years.

Brooklyn Bristol

Guaranteed 25 Years.

Brooklyn Windsor

Guaranteed 20 years.

SEND FOR SELECTION PACKAGE.

## Silver Deposit

Iridescent and  
Green Glass

ALSO IN

Crystal  
Glass

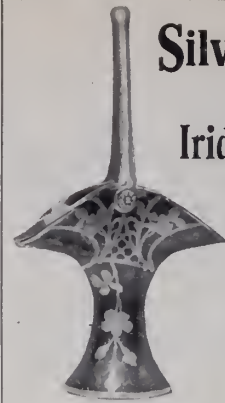

**B**ASKETS in all shapes.  
Great sellers for wed-  
dings, etc. Always appro-  
priate and acceptable gifts.

Only House to Decorate These in  
Silver. Phenomenal Sellers'.

Depasse Manufacturing Co.  
41-43 Maiden Lane, New York

## ELLIS & CO.,

10 Holborn Viaduct, - - - London  
Hall Street, - - - - - Birmingham

ENGLAND



Plated Goods on Copper with  
Sterling Silver Mounts, Rolled  
Plated Goods, Trays, Waiters, etc.

**CASSIUS W. SEYMOUR,**  
37-39 Malden Lane, New York.  
ALLOW ME TO CALL ON YOU IN THIS WAY



**Jewelers' Stationer and Printer**  
Jewelers' Cards,  
Tissue Paper,  
Tags,  
Blank Books, etc.  
**ROLL AND FLAT PAPERS.**

Estimates cheerfully  
given. Mail orders  
promptly attended to.  
Let us quote you our  
prices on manifold books  
and sealing wax.

1876 1906

# Hutchison & Huestis



## RING MAKERS



### JADE

is in vogue



### SEE OUR JADE RINGS

Jobbing Trade Only



FACTORY

PROVIDENCE, R. I.

185 EDDY STREET

NEW YORK  
3 Maiden Lane

CHICAGO  
Columbus Building  
HARRY H. MILLER

Design Illustrated

No. 7957

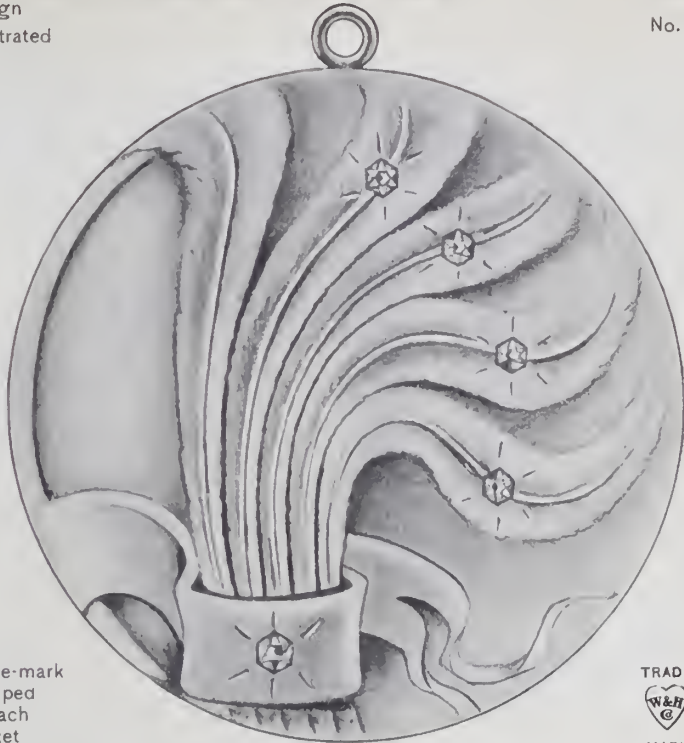

Trade-mark stamped in each Locket



Our **LOCKET** creations continue to be the standard for workmanship and design. Originality and quality have combined to render the excellence of W. & H. Locketts unsurpassed.

3 Maiden Lane **Wightman & Hough Co.** Providence, R. I.  
New York

## COMBS



OUR new line shows many designs, highly artistic and attractive, that will prove rapid sellers.

The highest class of workmanship is characteristic of all our lines.

- Combs Baby Pins
- Brooches Crosses
- Scarf Pins Waist Sets
- Bracelets Hat Pins
- Barrettes Collarettes
- Buttons Silver Novelties



MARK  
**ALWAYS ON THE GO**

LOOK FOR THE TRADE-MARK  
**MILLER, FULLER & WHITING,** MANUFACTURING JEWELERS  
N. Y. Office, 9-11 Maiden Lane NORTH ATTLEBORO, MASS.

## Roger Williams Silver Co.,

PROVIDENCE, R. I., AND NEW YORK, 860 BROADWAY.

### Sterling Only.

RICH DESIGNS :: :: :: Photos on Application.

# The Kenilworth Bracelet.

(Patented Jan. 2, 1906, No. 808,805.)  
No. 4086.

All of the foremost jobbing houses now carry a full line in stock, and you will miss an opportunity if you fail to see them. Ask your jobber to show you the full line.

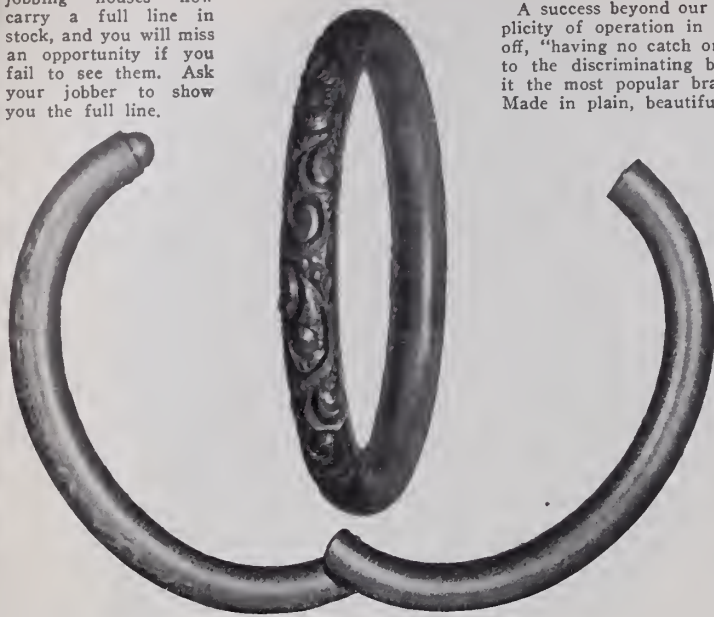

A success beyond our expectations. Its simplicity of operation in putting on or taking off, "having no catch or snap," commends it to the discriminating buyer, and has made it the most popular bracelet on the market. Made in plain, beautifully chased and stone set, plain polished, English and Roman finishes, and in gold-filled and sterling silver.

Manufactured by  
**Doran,  
Bagnall  
& Co.,**  
North Attleboro,  
Mass.  
194 BROADWAY,  
NEW YORK.  
67 WABASH AVE.  
CHICAGO.  
126 KEARNY ST.,  
SAN FRANCISCO.

EVERYTHING IN LOCKETS AND CHAINS.

THE BASSETT JEWELRY CO.,  
PROVIDENCE, R. I.

Our Salesmen have started out with their Complete Line of

## EMBLEM GOODS

for the Fall Trade.

Many new and original designs have been added and we know they will prove good sellers.

BE SURE AND LOOK 'EM OVER WHEN OUR SALESMAN CALLS.

## IRONS & RUSSELL,

MANUFACTURERS OF EMBLEMS,

NEW YORK OFFICE:  
11 MAIDEN LANE.

MAIN OFFICE and FACTORY:  
95 CHESTNUT ST., PROVIDENCE, R. I.



Ladies' Fancy Stone Rings  
and Stone Scarf Pins  
in 10K. that defy  
competition.

Our reputation for making the finest and most complete line of 10-K. gold band rings is still maintained—ask your jobber.

THE  
**EDWIN LOWE & CO., Inc.**

F. W. BODWELL, V.-Pres. and Gen. Mgr.,  
116 Chestnut St., PROVIDENCE, R. I.  
New York Representative, E. T. Wilson, 180 B'way.  
Western Representative, S. H. Brower.



## RINGS

While we do not make all the rings that are made, yet we make a large line of GENTS', LADIES', MISSES' and BABY RINGS that defy competition.

Request your jobber to show you our line of quick sellers.

**AMERICAN RING CO.,**

Makers of Gold Jewelry for the Jobbing Trade,  
94 Point Street, Providence, R. I.

## ORKIN BROS.

373 WASHINGTON ST.,

Jewelers' Bldg., BOSTON, MASS.

Manufacturers of diamond mountings, and repairers to the trade. Importers of precious, semi-precious and imitation stones.

A Full Line Always in Stock at Lowest Prices.

We aim to be the foremost jobbing house of Boston.

Send us your repairs, or write us for information.

## RINGS

**WM. LOEB & CO.**

101 Sabin St.,

Providence, R. I.

New York Office, 37 Maiden Lane.

**W**ait  
**A**nd See  
**I**n the "Celebrated Case"  
**T**his Season's New Goods  
**E**

**T**  
**H**  
**R**  
**E**  
**S**  
**H**  
**E**  
**R**  
**'**  
**S**  
**G**  
**O**  
**O**  
**D**  
**S**  
**S**  
**E**  
**L**  
**L**

**Waite-Thresher  
 Company**

61 PECK ST., PROVIDENCE, R. I.

7 Maiden Lane, NEW YORK. 1203 Heyworth Bldg. CHICAGO, ILL.

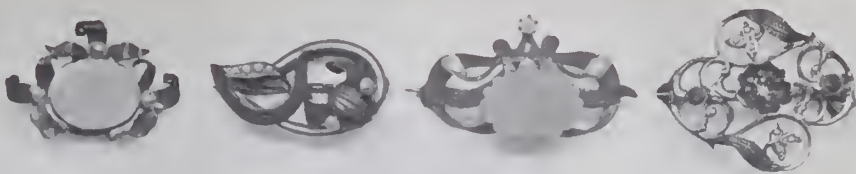

**BROOCHES**

WE have over four hundred styles of Gold Brooches set with all the popular stones in vogue; not at fancy prices, but at figures that cause them to sell.

We have Gold Barrettes in a variety of shapes and styles.

*Insist upon seeing the designs of Gold Jewelry made by the*

**E. L. SPENCER COMPANY,**

*Makers of Gold Jewelry for the Jobbing Trade.*

ORDERS PROVE OUR GOODS SELL. SAMPLES ONLY.

95 Chestnut Street, PROVIDENCE, R. I.

New York Office, 9-11-13 Maiden Lane.

ESTABLISHED 1861.

**R. BLACKINTON & CO.,**

3 MAIDEN LANE, NEW YORK.

FACTORY, NORTH ATTLEBORO, MASS.

**Manufacturing Jewelers and Silversmiths.**

TRADE  MARK.

Toilet and Manicure Articles, Flatware, Sterling and German Silver Wrist Bags, Gent's and Ladies' Card Cases, Vanity Boxes, Jewel Boxes, Match Safes, Picture Frames, Belt Buckles, Cigarette Cases, Penknives and up-to-date Novelties.

ROSWELL BLACKINTON ESTATE, W. B. BALLOU,  
 WALTER BALLOU, J. R. MORSS. R. BLACKINTON, Jr.

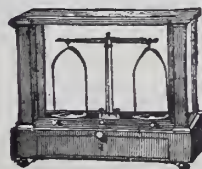

**HERMAN KOHLBUSCH, Sr.,**

ESTABLISHED 1859.

**Manufacturer of Fine Balances and Weights**  
 for every purpose where accuracy is required.

**Office and Salesroom, 194 BROADWAY, NEW YORK.**

Send for Price List.

Tel. 370 Cortlandt.



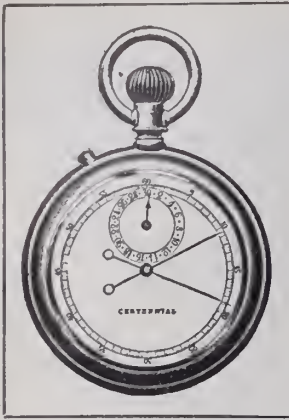

Timer is 1/8 Larger than cut

THE OLD RELIABLE  
**Centennial**

SPLIT SECOND TIMER

"None better made"

Now is the time to order TIMERS for the Spring and Summer trade—suitable for racing purposes or for mechanical uses.



Timer is 1/8 larger than cut

**CROSS & BEGUELIN, Manufacturers, New York.**

**The Comb House**

We manufacture a complete line of

**FINE MOUNTED COMBS**

in 14 K., 10 K., Sterling Gilt and Gold Filled.

Also all kinds of PLAIN, REAL and IMITATION TORTOISE SHELL COMBS.

**Wagner Manufacturing Co.**

41 Union Square,

**New York.**

Repair Work  
a Specialty.

Factory, Lorimer St. and  
Throop Ave., B'klyn, N. Y.



**To Jobbers Only—**

When you think of Toilet Goods, please remember us. Our goods are high grade and can be retailed at popular prices.

*Special Terms on Early Business*

**Art Stamping & Mfg. Co.**

411 Commerce Street, PHILADELPHIA, PA.

**FAIRCHILD & COMPANY**

225 to 233 Fourth Ave.

NEW YORK CITY.

Manufacturers of GOLD PENS, PENCILS, PENHOLDERS, SEGAR CUTTERS, SPECIALTIES, PENCILS SET WITH JEWELS.

*Style, quality and workmanship acknowledged the very best.*



**Trade-Marks** of the Jewelry and Kindred Trades.  
Second Edition. Price, \$3.00. The Jewelers' Circular Publishing Co., 11 John St., New York.

**E. H. H. SMITH SILVER CO.**

BRIDGEPORT, CONN.

Silversmiths' Building,  
CHICAGO, ILL.

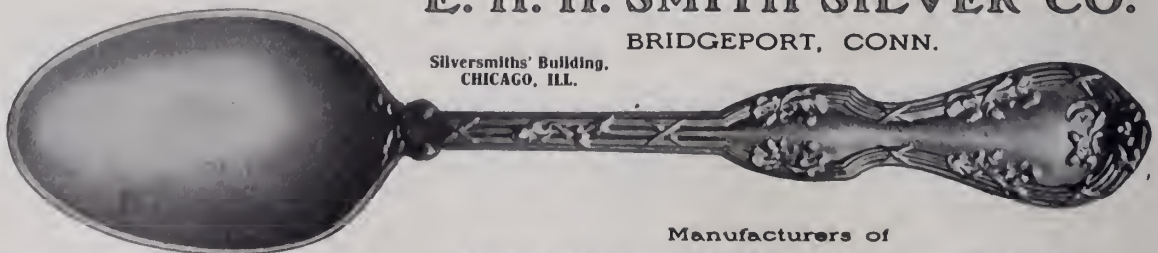

THE OAK.

Manufacturers of

**Sterling Effects in Plate**

# FANS FOR GRADUATION, WEDDINGS, CONFIRMATION.

HEADQUARTERS FOR THE MOST EXCLUSIVE LINE IN THIS COUNTRY.



Similar goods are not obtainable elsewhere.

They are of original design and my own creation.

## NECKLACES

IMITATION PEARL AND FANCY BEAD, IN ALL NEWEST SHADES AND EXQUISITE COLORINGS.

*Samples of Fans and Necklaces sent on request.*

LOUIS STEINER, Importer,  
520 and 522 BROADWAY, NEW YORK.

LADIES' COLLAR SUPPORTER.



## PATENT NOTICE

### LADIES' COLLAR SUPPORTERS

We hereby notify the trade that we have acquired the sole and exclusive rights for the United States of America in the Stevenson patent, No. 759,403, dated May 10, 1904, for Ladies' Collar Supporters—stationary and detachable.

We take this opportunity of warning the trade against buying collar supporters of any description that do not bear the above patent number.

The practical features of our collar supporters have won the approval of the women throughout America. This fact is emphasized by the enormous demand for collar supporters at this time. Dealers everywhere are enjoying a big trade on this item— and incidentally a handsome profit, too.

All pearl, 1½ and 1¾ inches in length, per dozen pairs, **\$2.00.**

Celluloid, with turquoise, amethyst and pearl knobs, per dozen pairs, **\$1.50.** We make numerous styles in gold plated and pearl, with plain and fancy knobs, stationary and adjustable, **\$2.00** per dozen pairs and up.

Write to-day for samples and be prepared to supply your customers.

Patented May 10, 1904. Patent No. 759,403.

THE HOME OF  
NEW IDEAS

**B**ASS IDEAS  
RING YOU CUSTOMERS  
BIG PROFITS, TOO.

## E. & J. BASS

Manufacturers

573-575 Broadway New York



**F. & B.**  
"ARMLET"  
Secret Joint  
Pat. ~~1873~~  
Size 2 3/8 in.

- |           |                           |                                      |
|-----------|---------------------------|--------------------------------------|
| 474       | 476                       | 477                                  |
| 474 POL.  | 476 Rose Gold Half Chased | 477 Rose Gold, Half Chased, 5 Stones |
| 475 ROM.  | 507 O. E. "               | 522 O. E. " 5 "                      |
| 506 O. E. | 530 Rose Gold Full "      | 546 Rose Gold " " 6 Brillants        |
|           | 538 O. E. "               |                                      |

Color of stones as ordered, Amethyst, Ruby, Sapphire, Olivene, Topaz, Aquamarine, Almondine, Turquoise and Rose Stones.  
Bracelets made with secret joint and push catch. High-grade Seamless Gold-filled Stock.  
Each bracelet in fine leatherette covered box.



**BRACELET 473 ROSE.**  
COLOR OF STONES AS ORDERED.

Amethyst, Ruby, Sapphire, Olivene, Topaz, Aquamarine and Turquoise.  
Two of the above Bracelets snapped together, makes a nice dog collar 14 in. long.

473



Locket  
2825  
Rose



Pin  
3632  
Rose and Green  
Brillants



Pin  
3647 Pearls  
3648 Brillants  
3649 Turquoise



Pin  
3629  
Baroque Pearls  
and Brillants



Locket  
2826  
Rose



Hair Barrette  
3660 Pearls  
3659 Brills.



Cuff Pin  
3624  
Roman



Cuff Pin  
3622  
Roman



Hair Barrette  
3652 Pearls  
3651 Brills.

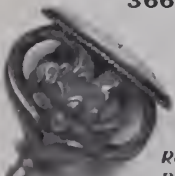

Hat Pin  
710  
Rose and Green  
Polish Signet

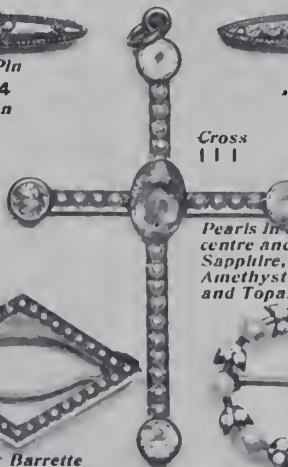

Cross  
III  
Pearls in bars,  
centre and ends.  
Sapphire,  
Amethyst  
and Topaz

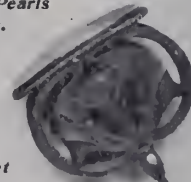

Hat Pin  
705  
Rose  
Polish Signet



Links  
751 Rose



Hair Barrette  
3658 Pearls  
3657 Brillants

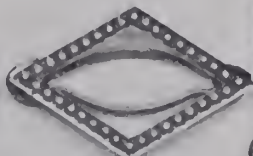

Pin  
3603 Baroque Pearls  
and Brillants



Links  
758 Green  
757 Rose

These are only a few examples of our new goods; see our complete lines.

**Theodore W. Foster & Bro. Co.**

MANUFACTURING JEWELERS AND SILVERSMITHS,

100 Richmond Street, Providence, R. I.

See our Lines  
of Goods for  
Articles suit-  
able for gifts.

A full line of  
PHOTO. FRAMES in  
both Sterling Silver  
and 14 K. Gold Filled.  
CROSSES, PEND-  
ANTS, NECK  
CHAINS, LOR-  
NETTE CHAINS  
LOCKETS, CHARMS  
VEST, DICKENS  
and FOB CHAINS  
BRACELETS, PINS  
BROOCHES, EAR-  
RINGS, LINK BUT-  
TONS, SCARF PINS  
HAT PINS, BAR-  
RETTE PINS  
WAIST SETS, HAI  
CHAIN MOUNT  
INGS, DOG COL  
LARS and BELT  
BUCKLES, RIBBON  
BOOK-MARKS and  
large variety of usefu

**Sterling**  
**Silver**  
**Novelties.**

MANICURE and  
TOILET SETS and  
pieces, also  
DESK SETS  
SEWING SETS  
TRAVELING SETS  
SHAVING SETS  
SMOKING SETS  
FLASKS and othe  
goods suitable fo  
gentlemen's use.

Do not fail to  
order a few o  
our new brace  
lets,

"The Armllet"



**Wedding Presents of the German Crown Prince and His Bride Recently Exhibited for Charity.**

IN the Museum of Industrial Art in Berlin the wedding presents received by the German Crown Prince and his bride were recently on exhibition for purposes of charity, and formed an object of the greatest interest to all visitors, recalling the wonders of the "Arabian Nights." The collection of treasures includes gifts from the sovereigns of all lands, and from the cities and provinces of the empire.

A large glass case holds the jewels, a glittering display of diadems, necklaces and pendants, gifts from relatives, from the Sultan of Turkey (shown in the center of the cut on this page), and from the Rus-

inscription, "Die treuen Ostpreussen, 6 Juni, 1906."

Very interesting is a cabinet containing replicas of the famous antique silver plate of Hildesheim, a gift from Hanover.

The court of the museum where the exhibition is held is tastefully decorated with Oriental carpets, flowers, etc. There is a great display of costly silver plate, pictures and the finest china, of furniture, and the most delicate point lace. Of the silver plate, the most remarkable is the table service given by 453 Prussian towns, and the splendid center-piece (illustrated in THE CIRCULAR-WEEKLY, last Fall, which came from the free city of Hamburg, and represents one of the peculiar boats which bring flowers, fruit and vegetables, every morning, to the community's citizens.

A splendid set of tea and coffee pots, in

**Second Quarterly Sale of Ivory at Antwerp, Belgium.**

ANTWERP, May 8.—The second quarterly public sale of ivory commenced on May 1 and finished on May 2. The following quantities passed under the hammer: 46,149½ kilos Congo (hard), 2,797½ kilos Congo (soft), 13,165 kilos Angola, 1,599 kilos Cameroon, 1,498½ kilos Senegal, 1,148½ kilos Ambrize, 233 kilos East African (hard), 711 kilos Egypt (hard), 1,711 kilos Egypt (soft), 143½ kilos Abyssinia (soft), 252 kilos cut pieces, 219 kilos mammoth teeth, 53½ kilos sundries, 54 kilos hippopotamus' teeth, a total of 69,735 kilos.

How this compares with former years may be seen from the fact that 97,267 kilos were sold in 1905, 98,046 kilos in 1904, 95,249 kilos in 1903, 84,964 kilos in 1902, 70,285 kilos in 1901, 94,190 kilos in 1900, 78,498 kilos in 1899, 58,334 kilos in 1898, 73,600 kilos in 1897, 66,553 kilos in 1896.

The bidding has been spirited and the 69,735 kilos offered found buyers at prices showing an advance of one to two francs per kilo for heavy and medium Congo and Angola teeth, and an advance of about one to one and a half francs for bangles, teeth for billiard balls and scivellous.

The advance in the price of soft ivory amounts to two to three francs for heavy and medium teeth and nearly five francs for teeth for billiard balls. The Senegal ivory profited by the same good demand for the other sorts.

The actual stock on hand amounts to 71,000 kilos, against 95,000 kilos in 1905, 96,500 kilos in 1904, 144,500 kilos in 1903, 129,000 kilos in 1902, 110,000 kilos in 1901, 105,200 kilos in 1900, 93,500 kilos in 1899, 58,000 kilos in 1898, 84,000 kilos in 1897, 107,000 kilos in 1896.

The next quarterly public sale will take place July 31.

The average price received during the last eight years, taking no account of the quality or the weight, is established as follows:

Year.	Per kilo. Francs.	Av. weight. Kilos.
1888.....	24.00	9 2-5
1889.....	28.25	12 1-2
1890.....	25.51	10 9-10
1891.....	20.05	9 1-5
1892.....	18.43	8 3-10
1893.....	16.00	8 1-5
1894.....	15.05	7 3-10
1895.....	16.40	8 4-5
1896.....	15.82	6 2-5
1897.....	16.95	9 3-5
1898.....	18.35	8
1899.....	19.85	7 3-5
1900.....	17.93	9
1901.....	19.41	8 3-8
1902.....	20.16	7 1-2
1903.....	19.15	8 2-5
1904.....	21.54	8 2-5
1905.....	23.54	8 2-5

The retail jewelry store of F. E. Brand, 219 S. Main St., Findlay, O., was entered by thieves a short time ago, and jewelry valued at several hundred dollars was stolen. The intruders gained entrance by using a pick axe and a chisel on a rear door, and then boring holes in the door near the lock to form a large hole, through which a hand was thrust and the door unlocked. A reward of \$100 has been offered by Mr. Brand for any information leading to the arrest and conviction of the guilty parties.



JEWELS AMONG WEDDING GIFTS TO GERMAN CROWN PRINCE AND PRINCESS.

sian Imperial family. Bracelets, brooches and rings show every possible kind of gem, in artistic setting. A tortoise shell casket containing two spoons and salt cellars was sent by the King of Siam, and two magnificent cloisonné vases by the Emperor of China.

King Edward of England presented costly gold flasks (shown in the large photo on the front cover, underneath the small plates); two beautifully executed fans were gifts of the Crown Prince and Princess of Sweden, and Duke Ernst Günther.

The possibilities of German industrial art are convincingly expressed by the gifts of the provinces and towns. Lack of space prevents notice of each example in detail, but as especially worthy of remark, mention should be made of the gold dessert service from the province of Pomerania, the silver center-piece, in the form of a ship, from the Hamburg-American steamship line, and the silver center-piece from the province of East Prussia. The group of elks in the latter was modeled by Professor Haverkamp, and the decorative part designed and executed by D. Vollgold u. Sohn, Berlin, in rich baroque style. It is more than three feet in length, and weighs 100 pounds. The arms of the Prince and Princess, and of the province, decorate the sides, and the center of the base bears the

antique Etruscan style, is the gift of the King of Italy, made by a Roman silversmith. A dainty tea set in enameled silver was sent by the German colony in Moscow. A wonderful mosaic picture is the present of the Pope, a string of costly pearls, that of the province of Brandenburg.

According to the *Saturday Evening Post*, a clerk in one of the leading Washington jewelry stores was showing his line of clocks to an Irishman who wanted to present one to his wife on the third anniversary of their marriage. The salesman had exhausted all of his stock except some cuckoo clocks on a shelf near by. The Celt asked to see them and the clerk took them down, thinking that at last he would make a sale. After telling Pat the price, the latter asked if they struck the hours. Instead of answering directly, the clerk wound the timepiece and set the hands at a few seconds to 12. As the little door opened Patrick's eyes bulged with interest, but when the chirping ended he plainly showed his disapproval. The man behind the counter said:

"Well, how do you like it?"

Pat thought a moment and then replied earnestly: "Faith an' it's all right, except on one point. It's trouble enough to remember when to wind it without havin' to think of fadin' the bird."

The Larter Shirt Stud

is the only stud that

can be used in any

style shirt, including

the coat shirt.

The variety of pat-

terns is almost unlim-

ited, the largest shirt

stud stock in America.

Larter & Sons

21 & 23 Maiden Lane

New York

## ELSIE BEE'S FASHIONS.

NOVELTIES SEEN IN A LADY'S RAMBLES AMONG THE JEWELERS.

A DIAMOND scarf pin has the head in the form of a circle of diamonds, with a pearl set free on the pin in the center of the circle, with space around it.

For cut flowers there is a magnificent tall cut glass vase of flaring shape on a richly decorated silver base.

Pear shaped diamonds fringe a costly necklace, in which a chain of large diamonds extend across the front.

Parasol handles and handles of the fashionable sun umbrellas take on some odd and interesting shapes in carved wood.

Some very rich silk and lace covered parasols have square cut club handles that fold, a convenience often to be desired in this important article.

A charming new bracelet displays an open design of fancy ovals formed of a narrow band of green tourmalines interwoven with a similar band of diamonds.

A diamond necklace of surpassing beauty is formed of diamond clusters of good sizes, each with a large central stone, from which depend large diamonds, with little space between them.

Sets composed of a handsome scarf pin, with sleeve links to match, come in little, silk lined cases and are most attractive. Oblong stones of green or ruby are shown framed in diamonds.

The long, rather heavy, handles of sun umbrellas show such designs as the entire figure of a mouse, a cat, and dogs of various breeds, and as large as can be conveniently utilized for the purpose, setting upright on the top of the handles.

Handsome lemonade pitchers of cut glass come in conjunction with silver, by way of embellishment, which also adds an appreciable air of richness and solidity. In some the entire top and handle are of silver, with cut glass bowl and base, or the bowl and handle and top may be of the glass on a silver stand.

Genuine ox-blood coral from Japan is shown in large graduated sizes of beads forming a necklet of great richness and depth of color, and supplying a unique effect in strings of beads. Rare rose pink coral and large beads of pink, shading from deep to light, are among ornaments for Summer wear with white costumes where a touch of color is desired.

Very handsome is a diamond pendant forming a brooch, with platinum chains depending, that are finished with diamond leaves instead of drop stones. From the stem of the maidenhair fern curved to a circle, broke in on one side, with the spreading leaves ornamenting the space from the upper end, and from the curved-in lower end, touching the leaves, the chains depend.

ELSIE BEE.

**Jewelry, Clocks, Watches, Silverware and Kindred Lines Exported from New York.**

WASHINGTON, D. C., May 16.—The following were the exports of jewelry, silverware and optical goods, clocks, watches and kindred lines from the Port of New York, for the week just ended:

- Adelaide: 2 packages optical goods, \$157; 575 packages clocks, \$10,716; 48 packages plated ware, \$3,217; 10 packages cutlery, \$1,451; 5 packages watches, \$540; 1 piece nickel, \$147.
- Bremen: 11 packages watches, \$3,450.
- Buenos Ayres: 1 package cutlery, \$279; 1 package watches, \$2,095.
- Calcutta: 72 packages clocks, \$1,935; 9 packages plated ware, \$937.
- Callao: 14 packages cutlery, \$1,344; 1 package watches, \$850; 2 packages jewelry, \$210.
- Cardenas: 7 packages cutlery, \$639.
- Chaux de Fonds: 2 packages watch cases, \$200.
- Frankfort: 4 packages optical goods, \$2,071; 4 packages cutlery, \$999.
- Genoa: 1 package jewelry, \$500; 2 packages jewelry, \$500.
- Hamburg: 5 packages optical goods, \$2,071; 4 packages cutlery, \$999.
- Havana: 1 package jewelry, \$1,268; 1 package optical goods, \$140; 27 packages clocks, \$429; 5 packages jewelry, \$892; 4 packages cutlery, \$378.
- Havre: 2 packages optical goods, \$510; 2 packages clocks, \$116; 3 packages jewelry, \$996; 2,417 pieces nickel, \$43,500; 24 packages clocks, \$1,209.
- Kingston: 6 packages watches, \$132.
- Liverpool: 3 packages silverware, \$664; 9 packages jewelers' ashes, \$7,000; 86 packages clocks, \$1,540; 2 packages watches, \$180; 3 packages thermometers, \$185; 21 packages clocks, \$251; 4 packages jewelry, \$1,025; 110 packages scopes and views, \$1,533.
- London: 1 package plated ware, \$500; 72 packages clocks, \$1,410; 12 packages optical goods, \$2,666; 3 packages cutlery, \$111; 18 packages watches, \$3,989; 1 package clocks, \$280; 145 packages clocks, \$1,235.
- Montevideo: 2 packages clocks, \$104.
- Naples: 2 packages jewelry, \$500.
- Para: 1 package optical goods, \$200; 10 packages clocks, \$130; 14 packages cutlery, \$637; 1 package jewelry, \$110.
- Penang: 2 packages plated ware, \$150.
- Progreso: 2 packages cutlery, \$114; 6 packages plated ware, \$336; 7 packages clocks, \$130.
- Rio de Janeiro: 1 package watches, \$160; 21 packages cutlery, \$1,639; 35 packages clocks, \$1,065; 4 packages plated ware, \$452; 2 packages optical goods, \$353.
- Rotterdam: 1 package watches, \$320.
- Savanilla: 1 package optical goods, \$139; 20 packages clocks, \$864.
- Southampton: 1 package watches, \$310; 12 packages optical goods, \$2,666.
- Tampico: 10 packages plated ware, \$595; 32 packages clocks, \$531.
- Temuco: 1 package jewelry, \$100.
- Valparaiso: 7 packages plated ware, \$417; 9 packages cutlery, \$746; 3 packages silverware, \$212; 1 package jewelry, \$968; 4 packages clocks, \$147.
- Vera Cruz: 11 packages plated ware, \$2,069; 120 packages clocks, \$1,808.
- Wellington: 20 packages clocks, \$175.

The following were the exports of the same products during the previous week from the Port of New York:

- Adelaide: 32 packages clocks, \$251; 1 package jewelry, \$257; 35 packages plated ware, \$1,605.
- Antwerp: 964 pieces nickel, 17,300; 1 package optical goods, \$249.
- Barbados: 13 packages clocks, \$210.
- Barcelona: 2 packages jewelry, \$294.
- Berlin: 22 packages clocks, \$1,083.
- Bombay: 76 packages clocks, \$1,001; 3 packages watches, \$543; 3 packages cutlery, \$148; 3 packages watches, \$650.
- Bremen: 3 packages plated ware, \$520; 2 packages watches, \$1,640.
- Buenos Ayres: 2 packages cutlery, \$193; 9 packages clocks, 125; 2 packages jewelry, \$597; 4 packages clocks, \$183; 1 package optical goods, \$1,112.
- Calcutta: 1 package watches, \$125.
- Christiana: 6 packages clocks, \$107.
- Colon: 2 packages watches, \$214.
- Copenhagen: 2 packages silverware, \$190.

- Dublin: 17 packages clocks, \$450; 1 package optical goods, \$249.
- Gibraltar: 7 packages clocks, \$160.
- Gothenberg: 7 packages clocks, \$290.
- Guayaquil: 1 package jewelry, \$250; 1 package jewelry, \$202.
- Hamburg: 4 packages watches, \$1,606; 1 package jewelry, \$500; 2 packages optical goods, \$666; 2 packages optical goods, \$334; 13 packages clocks, \$173; 4 packages scopes and views, \$125.
- Havana: 6 packages cutlery, \$405; 3 packages jewelry, \$712; 1 package optical goods, \$100; 6 packages plated ware, \$819; 131 packages clocks, \$1,357; 9 packages cutlery, \$195; 2 packages jewelry, \$229; 3 packages scopes and views, \$120.
- Liverpool: 1 package silverware, \$659; 91 packages clocks, \$1,404; 1 package silverware, \$641; 1 package jewelry, \$500.
- London: 49 packages clocks, \$1,489; 63 packages clocks, \$3,326; 41 packages watches, \$3,178; 8 packages scopes and views, \$1,482; 7 packages plated ware, \$351; 12 packages optical goods, \$5,461.
- Manila: 10 packages cutlery, \$256.
- Para: 1 package jewelry, \$250; 21 packages clocks, \$370; 8 packages cutlery, \$452; 1 package watches, \$116.
- Santos: 4 packages cutlery, \$358; 2 packages jewelry, \$786.
- Sckonoi: 2 packages clocks, \$122.
- Smyrna: 19 packages clocks, \$208.
- Tampico: 16 packages clocks, \$260.
- Valparaiso: 1 package jewelry, \$325.
- Vera Cruz: 61 packages clocks, \$990.

**List of Articles Recently Stolen from J. A. Bills & Son, Vinton, Ia.**

VINTON, Ia., May 16.—The following is a list of watches and the stock stolen recently from the store of J. A. Bills & Son, of this place. The thieves gained entrance by prying open a rear window:

**THE LOOT.**

- One Crown, 12 size, No. 1555011; 1 Crescent, 12 size, No. 1428719; 1 Crescent, 12 size, No. 1428744; 1 Boss, 12 size, No. 7466879; 1 Pilot, 16 size, No. 999697; 1 Crown, 16 size, No. 1462013; 1 Boss, 16 size, No. 7172871; 1 Crown, 16 size, No. 8028945; 1 Boss, 16 size, No. 7586608; 1 Boss, 18 size, No. 7423603; 1 Boss, 6 size, No. 7574519; 1 Boss, 6 size, No. 7406033; 1 Royal, 6 size, No. 3409101; 1 Boss, 6 size, No. 7246963; 1 Boss, 0 size, No. 7582736; 1 Boss, 0 size, No. 7582973; 1 Wadsworth, 12 size, O. F. Ladies' guard chains, 18-D. & C., mostly Simmons; 2-2 solid gold chains; 1-1 silver; 6 gents' gold filled fob chains; 2 ladies' gold filled fobs; 5 dozen Sadler G. F. set rings; 18 pony vest and Dickens chains; 6 second hand watches; 1 Carman bracelet; 1 Gillette safety razor; several old gold rings; 1 dozen Jackson pearl handle pens; several Aiken-Lambert black ebony handle pens, and 2 dozen gold toothpicks and pencils.

**Utica Optical Club Now Known as the Utica Optical Society.**

UTICA, N. Y., May 16.—The annual meeting of the Utica Optical Society was held at the Masonic Club, Masonic Temple, here, last evening. The attendance was large, several being present from out of town. The name of the organization was changed to Utica Optical Society, it having been known as a club previously.

The following officers were elected: President, Richard Perlen; vice-president, G. H. P. Stone, Ilion; secretary, C. T. Evans; treasurer, B. T. Clark; member of executive committee, A. M. Kenney; librarian, N. A. Burrill.

Following the business session, a banquet was enjoyed, served by the club steward. The society is in a flourishing condition.

R. S. Huston recently sold his business in West Branch, Ia.

G. W. Goldsberry has sold his business in Craig, Nebr., to Fritz & Bernstein.

**Virginia State Optical Association Starts a Jewelers' Section.**

RICHMOND, Va., May 16.—The annual meeting of the Virginia State Optical Association was held in the parlors of Murphy's Hotel here, May 10. The first session opened at 2.30 p. m., and after the routine business the election of officers was taken up. V. B. Gilbert was elected president; W. T. Blanton, Farmville, Va., vice-president; W. Wayt Royall, Martinsville, Va., secretary, and F. S. Bullington, Richmond, Va., treasurer. Dr. A. Weck, Norfolk, was elected chairman of the executive committee.

The meeting was well attended, and among the important transactions was the forming of a jewelers' section. It was decided that any jeweler or optician was eligible to this section upon payment of the initiation fee (\$1) and dues (\$1) for the current year, no examination being required. To be eligible to the physiological section an examination is required, with an additional fee of \$4 and dues of 50 cents. Certificates will be issued to members of either or of both sections.

Eight applications were received and passed on, and the new members attended the night meeting. The last meeting was held at 8.30, and after preliminary business the association was entertained by several good talks and papers from Drs. Hale and Weck and Mr. Thompson. At 10.30 the meeting adjourned to the dining-room, where an elaborate banquet was served.

The association will urge every jeweler and optician in the State to make application for membership at once. The next meeting will be held in Newport News, the scene of the coming Jamestown Exposition.

**Annual Meeting of the Granite State Optical Association.**

BOSTON, Mass., May 16.—The annual meeting of the Granite State Optical Association was held at the American House, this city, Monday. After a bountiful repast the meeting was called to order by President White at 8.30 p. m. Briggs Palmer, of this city, was the speaker of the evening. He gave a very instructive talk on "The True Optometrist's Profession."

This was followed by a discussion in which the following gentlemen took part: Mr. Brown, Manchester; Mr. Gordon, Hillsborough, and Mr. Martin, Nashua, N. H.

The following officers were elected for the coming year: President, W. E. Burpee, Manchester, N. H.; first vice-president, C. H. Sinclair, Concord, N. H.; second vice-president, F. C. Sanborn, Wilton, N. H.; treasurer, W. L. Fickett, Concord, N. H.; secretary, Joseph Geoffrion, Manchester, N. H.

Executive Committee—Chas. F. Hussey, Portsmouth, N. H.; Delmont E. Gordon, Hillsboro Bridge, N. H.; W. H. Mould, Freemont, N. H.; A. K. Forsaith, Manchester, N. H.; N. D. Sawyer, Laconia, N. H.

A vote of thanks was given to the retiring president for his efficient services, and he was elected an honorary member of the association. The association is in a very flourishing condition. The optical library is proving of great benefit to the members.

# HAYDEN W. WHEELER & Co.



## MOUNTED DIAMONDS



OUR stock of Mounted Diamonds contains the Latest and Newest Designs. Made from best Selected Material. Finest Hand Made Mountings. Quality, Style and Lowest Price consistent with this standard.

AMSTERDAM  
2 TULP STRAAT

BROOCHES, RINGS, SCARF PINS, BRACELETS, ETC.

LONDON  
50 HOLBORN VIADUCT

2 MAIDEN LANE, NEW YORK

TELEPHONE  
7365 CORTLANDT

ORDER

# DIAMONDS

ON MEMORANDUM FROM

## ALFRED H. SMITH & CO.

170 BROADWAY, NEW YORK.  
Corner Maiden Lane.

London.  
6 Holborn Viaduct.

Chicago,  
103 State Street.

## Oppenheimer Bros. & Veith, Cutters of Diamonds,

65 NASSAU ST. (PRESCOTT BUILDING), NEW YORK.

AMSTERDAM,  
2 Tulp Straat.

LONDON,  
40 Holborn Viaduct.

CUTTING WORKS,  
Cor. Union & Nevins Sts., Brooklyn.

## HENRY E. OPPENHEIMER & CO.,

51 Holborn Viaduct, London.  
50 Rue de Chatraudun, Paris.  
7 Place Loos, Antwerp.

Tel. 621 Cortlandt.

3 MAIDEN LANE, NEW YORK.

DIAMONDS, PEARLS AND PRECIOUS STONES.

MEMORANDUM ORDERS SOLICITED.

**Kassel Salzman, Who Gave Worthless Checks to New York Jewelers, Sent to Penitentiary on Another Charge.**

Kassel Salzman, who was arrested, several months ago, on a charge made by a clothing firm who had dealings with a number of jewelry houses, was last week found guilty of grand larceny, second degree, and sent to the penitentiary for 12 months. Although Salzman was not tried on any charges preferred by jewelers, evidence in relation to his dealings with them was put in the possession of the District Attorney's office.

Among the jewelry houses with which Salzman had dealings was Aisenstein & Woronock, 22 Eldridge St. Mr. Woronock, after Salzman's arrest, called at the Tombs and identified him as a man who had been busy on the East Side buying jewelry and other merchandise and tendering payments with checks, some of which were not of any value. Believing that the trade should be warned of operations of this kind, Mr. Woronock made a collection of these worthless checks and turned them over to the District Attorney.

Mr. Woronock says that the man claimed to be connected with a house at Kingston, N. Y., the name of Salz & Co. being given. The subsequent transactions are detailed by the jeweler. Salzman made one or two purchases of jewelry from Mr. Woronock, paying in cash and good checks. Then the man bought some more jewelry, paying with a check, which was afterward refused at the bank. Salzman also returned a portion of the jewelry and obtained the cash value before Mr. Woronock had heard from the bank as to this worthless check. These purchases were all for less than \$50.

One day, just before the check came back from the bank, the man picked out a bill for \$175 and called for the jewelry after banking hours, presenting a check in payment. To this Mr. Woronock objected and did not allow the jewelry to leave the store. The man gave his address as 282 Broome St., but when Mr. Woronock went there he was unable to find Salzman.

Among others who turned over dishonored checks, said to have been accepted from Salzman, were Korones Bros., 32 Maiden Lane; L. Kroll, 36 Eldridge St., and several merchants in other lines of trade.

Salzman last year sued a man for \$10,000 for slander. Another case was brought by Salzman against a merchant who sold the former stock and afterward seized it on the ground that there had been no payment. While the latter case was being tried in court Salzman was arrested and, instead of being plaintiff, he became defendant in the proceeding which has now resulted in his sentence to the penitentiary.

**Death of Solomon Spring.**

BRISTOL, Conn., May 17.—Solomon Spring, for many years a well-known clock-maker of this place, died yesterday at his home on Divinity St., after a brief illness. The deceased was born in Granby, Jan. 29, 1826, and was the son of Thomas Spring. He learned the business of clockmaking with Burnham Terry, in Terryville, and

moved later to Bristol, where he spent the rest of his years.

Mr. Spring started in business on his own account in 1864, when he bought out the Birge factory on Riverside Ave. He established a factory in Forestville in 1867. His business prospered at that place, but his building was finally destroyed by fire. It was rebuilt and again burned in 1873. In 1885 his business was merged with the E. N. Welch Mfg. Co., and continued under that name until the Welch concern went out of business. Mr. Spring retired from active business about 12 years ago.

The deceased was twice married, his first wife being Marcia Cornell, of Waterbury, by whom he had two daughters, who are still living. His first wife died in 1883, and his second wife, Catherine Gillette, survives him.

**Patent Commissioner's Decision as to Trade-Mark on Watch Cases.**

WASHINGTON, D. C., May 16.—The Commissioner of Patents of the United States Patent Office has declared an interference between the application for the registration of trade-marks filed by the Philadelphia Watch Case Co., the Deuber Watch Case Mfg. Co., the Keystone Watch Co. and Byron L. Strasburger & Co., involving the right to the use by the respective companies of the words "silveroid," "Silverine," "silverod" and "silverex" as trade-marks to be used on watch cases. The Philadelphia Watch Case Co. and the Keystone Watch Case Co. moved to dissolve the interference upon the ground that no interference in fact existed between these various words. The Examiner of Interferences and also the Commissioner of Patents denied the motion and held that interference in fact existed.

The meaning of this decision is that the words "silveroid," "silverod" and "silverex," as employed by the Philadelphia Watch Case Co., the Keystone Watch Case Co. and Byron Strasburger & Co., are, in the commissioner's opinion, similar in sound and appearance, and are therefore not entitled to registration following the prior registration of the Deuber Watch Case Mfg. Co. of the word "silverine" for use on the same class of goods.

The Commissioner also held that in view of the fact that the other companies named were not able to allege a date of adoption and use of their respective marks prior to the date of registration by the Deuber concern; that they had not overcome a *prima facie* case, made out by the latter company, and had no standing before the office.

The Philadelphia Watch Case Co. is involved in an interference before the United States Patent Office with the Hampden Watch Co., involving the right of the latter company to use the word "Diadem" and a representation of a trade-mark for use on watch movements. The Philadelphia Watch Case Co. claims the use of the word "Crown" and the representation of a crown as a trade-mark for use on watch movements, watch cases and watch parts. Testimony is now being taken and a decision is expected in the Fall.

N. H. Barber & Co., Fullerton, Nebr., will shortly add a line of drugs to their jewelry stock.

**Clocks and Watches Imported by Chile from Europe and the United States.**

WASHINGTON, D. C., May 19.—The trade promotion bureau of the Federal Government is advised that clocks are imported into Chile to the extent of about \$30,000 per annum, Germany furnishing about three-fifths and the United States one-third. Cheap American alarm clocks seem to be in particular demand, and there is evidence that our sales of other grades are increasing as well.

The imports of watches are about three times as large as of clocks. Gold and silver watches are credited chiefly to France, but it is probable that many of them are of Swiss origin. Switzerland stands second, selling about half as many as France, while the share of the United States is small—10 per cent. of the total. In watches of "other metals," however, the United States leads with 42 per cent. of the total of \$32,000 worth in 1904. France and Switzerland together send about the same amount as the United States. The strength of the United States, therefore, seems to lie in the demand for the more inexpensive grades of both clocks and watches, good movements in cheap cases, and a larger trade could probably be done by catering to this demand.

The duty on clocks varies from 25 to 35 per cent.; on watches, 15 per cent. on a valuation which for gold watches varies from \$12.60 to \$18 each, for silver watches from \$3.25 to \$7.20, and for those of "other metals" from \$1.08 to \$1.32.

**Importations at the Port of New York.**

Weeks Ended May 19, 1905, and May 18, 1906.		
China, Glass and Earthen Ware:	1905.	1906.
China .....	\$42,621	\$65,301
Earthen ware .....	13,223	13,021
Glass ware .....	25,871	25,100
Optical glass .....	4,479	69
Instruments:		
Musical .....	16,824	11,750
Optical .....	10,551	9,100
Philosophical .....	4,415	497
Jewelry, etc.:		
Jewelry .....	7,483	6,004
Precious stones .....	581,442	1,006,875
Watches .....	29,147	29,428
Metals, etc.:		
Bronzes .....	965	6,330
Cutlery .....	18,845	54,046
Dutch metal .....	1,187	2,406
Platina .....	56,189	101,985
Plated ware .....	.....	.....
Silverware .....	139	169
Miscellaneous:		
Alabaster ornaments .....	36	.....
Amber .....	3,156	285
Beads .....	3,762	2,709
Clocks .....	5,879	5,441
Fans .....	4,277	7,842
Fancy goods .....	5,733	11,482
Ivory .....	24,085	3,330
Ivory, manufactures of....	82	96
Marble, manufactures of...	46,736	15,135
Statuary .....	6,447	4,036

The regulations of the Treasury Department of Feb. 11, 1901, establishing a rate for the allowance of drawback on watchmen's clocks, manufactured by the Newman Clock Co., of Chicago, from imported materials, have been extended, in so far as applicable, to cover the exportation of similar clocks manufactured by the same firm with the use of imported movements, metal cases and register keys in combination with domestic dials, hands, glass, chains, weights and iron boxes and other parts, in accordance with its filed statement.

**AMETHYST**

In Siberian, Brazilian and D'Auvergne qualities, in all shapes and sizes. Golden and Madeira topaz. Half, round and bouton pearls. Reconstructed rubies, opals, garnets, and doublets in the fancy colors and fancy shapes—uniform grades, especially selected for the American Market.

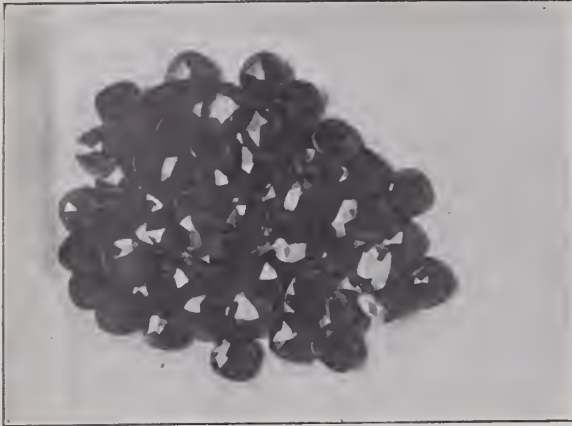

***I. Heller & Son***

Importers of Precious and Imitation Stones.

New York, 51 Maiden Lane  
Paris, 5 Cite Trevisé

Providence, 212 Union Street  
Idar, 14 Hauptstrasse

TELEPHONE 219 JOHN.

GEORGE H. HODENPYL.

WALTER N. WALKER.

**DIAMONDS**

AND

DIAMOND JEWELRY

**HODENPYL & WALKER**

Unique  
and

Staple Patterns

**170 Broadway, New York**

Corner of Maiden Lane

TELEPHONE, 1898 CORTLAND

Repairing and Recutting

Diamonds

a Specialty

<p>OUR <b>40th</b> YEAR</p> <p>IN BUSINESS</p> <p>1866-1906</p>	<p><b>DIAMONDS</b> LOOSE AND MOUNTED</p> <p><b>CASES and MOVEMENTS</b> ALL MAKES AND GRADES</p> <p><b>JEWELRY</b> GOLD AND PLATED</p> <p>ORDERS SOLICITED FROM RESPONSIBLE JEWELERS.      GOODS SENT ON SELECTION.</p> <p>All our goods are either direct importations, our own manufacture or bought for cash, enabling us to offer special inducements in prices and terms.</p>	<p><b>12 MAIDEN LANE,</b> (ONE FLIGHT UP)</p> <p>P. O. Box, 1625, <b>NEW YORK.</b></p>
<p>EST. 1866.</p> <p><i>Lissauer &amp; Company</i></p> <p>Importers.</p> <p>2 TULPSTRAAT, AMSTERDAM.</p>		



**AQUAMARINES**

ALL SIZES  
and SHAPES

Stones from One-Quarter of a Carat to Sixty Carats Each. Selection Papers Sent on Request

**MARTIN LOW & TAUSSIG,**

51 Maiden Lane, New York.  
Telephone, 2817-John.

139 Mathewson St., Providence, R. I.  
Telephone, 3037-Union.

**MEYEROWITZ BROS.,**

IMPORTERS OF **DIAMONDS,**

37-39 MAIDEN LANE,  
NEW YORK CITY

A Complete Line of Precious, Semi-Precious and Imitation Stones. Mail orders promptly attended to.

**United States Court Hears Argument on Injunction Asked by Geo. H. Robinson Against Gorham Mfg. Co.**

PROVIDENCE, R. I., May 17.—A hearing was given yesterday before Judge Brown in the United States Circuit Court on the bill of complaint brought by George H. Robinson against Edward Holbrook, the president and treasurer of the Gorham Mfg. Co., and others. The action was begun, as previously reported, for the purpose of prohibiting the transfer of Gorham stock for stock in the Silversmiths' Co., of New York, and to prevent the other changes agreed upon at the recent meeting of stockholders. The plaintiff was represented by Samuel Untermeyer, of New York, and Walter B. Vincent, of this city; the defendants by Comstock & Canning, of this city, and Olney & Comstock, of New York.

An affidavit by Mr. Robinson was read at the opening of the hearing. In substance Mr. Robinson charges that the plan adopted by the stockholders is for the purpose of enabling Mr. Holbrook to obtain absolute control of the business of the Gorham Mfg. Co. He said that, under the present capitalization, it would cost Mr. Holbrook nearly \$1,000,000 to obtain this control, by buying stock—if any were for sale. Under the plan adopted at the meeting Mr. Holbrook, it was said, could get control by exchanging the portion of the common stock of the Gorham Co. which he owns or controls for Silversmiths' stock and buying an additional amount of the Silversmiths' stock at a cost of less than \$211,000.

The following figures are set forth by Mr. Robinson in his argument. "As he [Mr. Holbrook] owns and controls over 38 per cent. of the common and preferred stock of the Gorham Co., he would be entitled to purchase 38 per cent. of the issue of \$1,750,000 of the Silversmiths' stock; but in order that he might acquire a majority of the \$7,000,000 stock of the Silversmiths' Co. to be issued, it would be necessary that he should exercise this right of purchase only with respect to 13 per cent. of the \$1,750,000 issue. Thirteen per cent. amounts to \$227,500, which, added to \$3,289,400, which he would acquire in exchange, would aggregate \$3,516,900, which is more than a majority of the total issue of \$7,000,000.

The affidavit intimated that the plan as proposed is unfavorable to the holders of preferred Gorham stock, and on this ground Mr. Robinson partly based his objections. It was also claimed that there had not been sufficient notice to stockholders of the meeting when the vote was taken on the proposed changes.

All the charges were contravened in affidavits read by R. H. Comstock, in behalf of the defendants. The affidavit of Herbert J. Wells, a director of the Gorham Mfg. Co., said that there had been no agreement to elect any director or officer of that corporation to a position as an officer of the Silversmiths' Co. An affidavit by John F. P. Lawton, the secretary of the Gorham Mfg. Co., disclosed that at the meeting of the company, when the new plans were adopted, 35,787 shares of stock were represented, of which 32,265 shares

voted in favor of the merger, 3,251 against, and that 271 shares were not voted on.

An affidavit by Edward Holbrook showed that he is a resident of New York; that he has been treasurer of the Gorham Mfg. Co. since 1877; that the company, which began in a small way, had become a large and prosperous concern owning several subsidiary concerns. It was declared that these are conducted as separate concerns, the capital and credit of the Gorham Mfg. Co. being used for the purpose; that a plan was conceived whereby the Gorham Mfg. Co. might be relieved of the burden by means of the organization of the Silversmiths' Co.; that there had been no agreement whereby any of the officers of the Gorham Co. were to become officers or directors of the Silversmiths' Co.

It was conceded by Mr. Untermeyer after hearing the affidavits that the court had no jurisdiction as far as Mr. Holbrook is concerned, as he is a resident of New York, Mr. Robinson also being a resident of that city, and there being no diverse citizenship. By consent of counsel the bill was dismissed as far as it relates to Mr. Holbrook, and the hearing proceeded as against the Gorham Mfg. Co.

Both sides then said that they would like to submit briefs as to the law relating to the power of the Board of Directors of the Gorham Co. to increase the stock of the Silversmiths' Co. Mr. Untermeyer also said that he would cite authorities on the question of the right of a company to sell out to its own subsidiary company, and the court ordered all authorities to be filed not later than Saturday.

The question arose as to whether or not those who had made subscriptions to the new company and were to pay for them June 1 would not be embarrassed by the delay. The court said that a decision on this matter could be speedily reached after the briefs had been filed. The court further said that the standing of the complaint would be the same as previous to the hearing, and the session was adjourned.

Briefs were filed by the several attorneys on Saturday. The position of the Gorham management, as indicated by the argument, is that the charges are in the line of business progress; are especially designed with a view to preserving the individual character of each of the affiliated companies; and in no respect involve unfairness toward any interest. A gentleman familiar with this side of the case said:

"As published in THE CIRCULAR-WEEKLY of May 2, the call for the special meeting, when action was taken on this matter, distinctly stated what general power was sought from the stockholders. At the meeting the matter was laid before the entire body of stockholders there assembled, representing between 35,000 and 36,000 shares out of a total of 50,000 of the stock of the company, and the resolution was voted unanimously, with the exception of Mr. Robinson's stock, and a small amount of stock held by one of the Providence brokers, who responded 'Not voting.'

"This meeting was comprised of holders of both preferred and common stock, and there was no criticism on the part of any of the preferred stockholders that the plan

was unjust to them, nor is any such claim made now. If there were a substantial basis for the claim that this plan was unjust to those stockholders, it is rather singular that out of some 300 or more stockholders, not one joins in this attack upon the plan. So far as can be learned in Providence, the unanimous sentiment of the stockholders, both preferred and common, with the exception of this one protestant, is in favor of the plan."

**Stockholders of American Waltham Watch Co. Unanimously Ratify Sale to Waltham Watch Co.**

Stockholders of the American Waltham Watch Co. have received in the last week a circular notifying them of the sale to the Waltham Watch Co., under the terms of the proposal published in THE CIRCULAR-WEEKLY of May 2. At the special meeting held May 15 in Waltham the vote was taken and was unanimous. The property of the old company passes to the Waltham Watch Co. in exchange for 40,000 shares of preferred and 70,000 shares of common capital stock of the new corporation, which assumes all liabilities. The directors of the American Waltham Watch Co. were authorized to distribute these shares in the proportion of one share of preferred and 1 3/4 shares of the common stock of the new for every share of the old stock.

The annual statement of the American Waltham Watch Co., as of March 31, 1906, compares as follows:

	ASSETS.		
	1906.	1905.	1904.
Real estate.....	\$921,005	\$925,193	\$900,556
Machinery .....	2,286,734	2,143,597	2,042,607
Merchandise .....	846,899	756,043	466,522
English and Canadian cases.....	36,553	47,681	55,906
Supplies .....	1,097,479	1,029,324	964,748
Watches in process.....	1,446,980	1,334,180	1,244,628
Patent rights.....	167,832	180,124	185,266
Due from agents and in office.....	80,539	145,363	280,349
Accounts receivable .....	28,229	16,000	16,154
Cash .....	210,927	277,051	383,517
Value of insurance policies.....	29,375	29,375	.....
Miscellaneous .....	6,049	8,049	24,022
Total .....	\$7,158,607	\$6,891,988	\$6,544,258
	LIABILITIES.		
Capital stock.....	\$4,000,000	\$4,000,000	\$4,000,000
Accounts payable.....	77,056	41,846	41,407
Surplus .....	3,081,553	2,850,142	2,502,851
Total .....	\$7,158,607	\$6,891,988	\$6,544,258

On Jan. 1, 1903, the surplus was \$2,071,716; on Jan. 1, 1902, it was \$1,608,588; on Jan. 1, 1901, \$1,117,575, and on Jan. 1, 1900, \$626,563.

The American Loan & Trust Co. of Boston will be the transfer agent, and it will receive the American Waltham Watch Co.'s stock until Sept. 1. Certificates of the Waltham Watch Co.'s stock will be returned as soon as the exchange is effected. No certificates for fractional shares will be issued, but the American Loan & Trust Co. will buy and sell such fractional shares at the market rates for private account.

Edward Grubers, Detroit, Mich., was fatally shot about a week ago while teaching his fiancee, Miss L. Hall, to shoot a revolver. Mr. Gruber was well known in that city.

# Chester Billings & Son

1840 Successors to Kandel, Barmore & Billings 1906

Importers of Diamonds  
Other Precious Stones, and  
Pearls, Diamond Jewelry

1840, Kandel & Barmore; 1866, Kandel, Barmore & Co.; 1880, Kandel, Barmore & Billings; 1897, Chester Billings & Son

New York, 58 Nassau Street, 29 Maiden Lane  
London: 22 Holborn Viaduct, E. C. Paris: 53 Rue de Chateaudun  
Amsterdam: 2 Tulp Straat



Three-Quarter Size

## New Pierced Nethersole Bangles

14 karat, Size 7 1-2 inches. Suitable for wearing over the new long gloves

### COOPER & FORMAN

Office and Factory, 3 Maiden Lane, N. Y.

Makers of Diamond Jewelry

Festoon Necklaces  
Locketts  
Cuff Buttons

Brooch Pins  
Scarf Pins  
Bracelets

## REMOVAL NOTICE!

### THE LYONS GEM CO.,

Have Removed to

35 Maiden Lane, New York.

A FULL AND COMPLETE LINE OF PRECIOUS,  
SEMI-PRECIOUS AND IMITATION  
STONES ALWAYS IN STOCK.

Our Specialty is Scientific Rubies.

Local and out of town jobs promptly attended to at reasonable prices. Send us your mountings to be set with matched stones. A trial order will convince you that our prices are right, and our goods select.

## GARREAU & GRISER

68 & 70 Nassau St., New York.

LAPIDARIES. PRECIOUS STONES.  
GEMS in Unique Cuttings.

### THE MUELLER LAPIDARY CO.,

248 Halsey Street, Newark, N. J.

#### CUTTERS

Precious and Semi-Precious Stones.

Trade-Marks of the Jewelry and Kindred Trades.  
Second Edition. Price, \$3.00. The Jewelers' Circular Publishing Co., 11 John St., New York.

## COOPER'S SUN RAY DIAMOND

HAS 100 per cent. more brilliancy than any other style of cutting.

We Challenge the World.

Send your old mine and yellow diamonds to be recut; if the effect is not 100 per cent. better, NO CHARGE.

### COOPER DIAMOND

Cutting and Polishing Industry of America

49 MAIDEN LANE, NEW YORK.

Factories, 8th Ave. & 18th St., Brooklyn.



TRADE-MARK.

## AZTEC TURQUOISES

Mines: MINERAL PARK, ARIZONA.



TRADE-MARK.

Of true CERULEAN BLUE, the rarest and most fashionable shade. Turquoises bearing Company's trade-mark are GUARANTEED. A new Turquoise will be given without question to replace any that discolors. The leading Jewelers of the World sell AZTEC TURQUOISES.

### THE AZTEC TURQUOISE COMPANY,

12-16 JOHN STREET, NEW YORK.

THE BOSTON DIAMOND HOUSE

## JOHN B. HUMPHREY CO.

387 Washington St., Boston, Mass.

We are receiving Monthly Shipments of Diamonds from our Brazilian Mines, which are on exhibition at our Boston Office.

Cutters of  
DIAMONDS

Cutters of  
DIAMONDS



### Death of Louis J. Lamb.

ATTLEBORO, Mass., May 21—Louis J. Lamb, one of the best known and most respected men in the jewelry trade of this section, died Sunday afternoon at the home of Dr. Bailey in Philadelphia. He went to that city to be under the personal care of the physician and was being treated for Bright's disease. The cause of his death was cerebral hemorrhage. J. L. Sweet, of the R. F. Simmons Co., Mr. Lamb's lifelong friend, has gone to Philadelphia to accompany the body home.

Mr. Lamb was born in 1852 at Charlestown, Mass., but the greater part of his life had been spent in Attleboro. He was the son of Norval B. Lamb, a member of one of the oldest families in this section. Mr. Lamb has always been a prominent jeweler, having been connected with three firms. He



THE LATE LOUIS J. LAMB.

started with W. H. Wilmarth & Co. on County St., which concern manufactured coffin trimmings and fancy metallic ware. Soon after he bought out the Granville W. Smith Co., but continued to make the same articles. Later this firm was changed to C. H. Allen & Co., and the line of goods it manufactured also changed. Twice this last named concern has moved into larger quarters. Mr. Lamb's brother, William H. Lamb, is also connected with him in the firm.

During his life Mr. Lamb held many public offices of trust in Attleboro. For many years he had been one of the Board of Sinking Fund Commissioners. He was a member of the School Committee for several years, and for 20 years was a trustee of the Public Library, being one of the prime movers in the effort to erect the new Public Library building. He was also a director of the Attleboro Savings Bank at North Attleboro, and had been connected directly and indirectly with many of the real estate transactions in this town. His advice was constantly sought on all subjects by many of the leading business men, and when given was usually followed, especially on financial schemes. For many years he was superintendent of the Murray Universalist Sunday School, and was also one of the founders of the church.

Mr. Lamb leaves a wife, Mrs. Elizabeth Becket Lamb, and three sons, Roland Manchester Lamb, Dr. Arthur Becket Lamb, of Harvard University, and Leonard Illman Lamb.

### Wisconsin Retail Jewelers Meet at Milwaukee and Form a State Association.

MILWAUKEE, Wis., May 16.—The meeting held Monday in this city to form the Wisconsin Retail Jewelers' Association proved a success in every way, and the organization has now been launched with the names of over 100 members on the charter roll. The objects of the association are many, but essentially it is to protect the members from abuses which have grown up in the trade; to watch carefully the movements that may conflict with the best interests of the craft, and to aid jewelers by preparing methods by which honest dealers may be commended and dishonest goods be condemned.

The meeting, which was held in the rooms of the Merchants and Manufacturers' Association, was enthusiastic from the beginning. The constitution and by-laws of the organization were adopted, and officers elected to serve until the first annual convention, which will be held in this city, June 27 and 28. The officers elected are: President, A. J. Stoessel, Milwaukee; vice-president, Gustave Keller, Appleton; secretary, F. O. Thomson, Milwaukee; treasurer, John P. Hess, Fond du Lac. Directors—George Durner, William Upmeyer and Henry Stecher, Milwaukee, and F. H. Coburn, East Troy. Hereafter the convention will be held annually in June.

Among the many jewelers present were a number from this city, and a good representation from smaller cities and towns of the State.

W. H. Upmeyer acted as temporary chairman and F. R. Wilde temporary secretary of the organization. One of the active workers of the movement was F. O. Thomson.

### Death of Abraham Bitner.

LANCASTER, May 21.—Abraham Bitner, 71 years of age, a man long prominent in Lancaster's business life, died, Sunday, from paralysis. Mr. Bitner was best known through his connection with the watch factory now called the Hamilton Watch Co.'s factory.

The original company, which erected for its factory what is now the main building of the Hamilton concern's plant, was in financial straits when Mr. Bitner and a few Lancaster financiers formed the Lancaster Watch Co. in 1887 and bought out the other company. For a while the new organization prospered, but persistence in clinging to certain patents favored by Mr. Bitner eventually brought disaster upon the company, and it, too, like its predecessor, was only saved from worse disaster by reorganization, the Hamilton Watch Co. succeeding the Lancaster concern. Mr. Bitner's experience cost him dearly, for he sunk all he was worth, \$60,000, and his brother, Charles A. Bitner, lost even more, while a number of other Lancaster business men suffered severely. The factory only scored success under its present management.

### Assets and Liabilities of Schickerling Bros. & Co. as Shown by Bankruptcy Schedules.

Schedules in bankruptcy were filed Thursday in the United States District Court at New York by Conrad L. Schickerling, in behalf of the corporation of Schickerling Bros. & Co., manufacturers at 28 E. 22d St., New York. Leonard Bronner signed the schedules as Mr. Schickerling's attorney. The total liabilities were placed at \$290,133.12, of which \$55,799.69 is on notes and bills, for which others are responsible. Included in the total is also \$35,210 classed as contingent indebtedness. The secured debts amount to \$94,922 and the unsecured to \$193,952.

The assets are nominally valued at \$91,498.92. This amount includes the face value of insurance policies amounting to \$53,500. The debts due on open accounts amount to \$16,842. The value of the stock in trade is placed at \$20,000. The cash on hand is \$156.

Among the creditors holding securities are: State Bank, \$19,004; H. C. Hardy, \$19,588; James Talcott, \$41,376; David Mayer, \$7,663; L. Heller & Son, \$2,207; L. Tannenbaum & Co., \$3,450; S. W. Wollstein, \$211, and the Commission Merchants' Association, \$120. The value placed on the securities by Mr. Schickerling equals or exceeds that of these debts in all cases except that of Mr. Hardy, who holds notes to the amount of \$13,645. Mr. Talcott has notes of Edelhoff Bros. & Co., now in the hands of a receiver, to the extent of \$37,500. He also holds a transfer of accounts making his total nominal security \$67,161. The jewelry and accounts transferred to the State Bank as security are valued at \$40,000. Mr. Mayer's security, comprising jewelry and the surplus in the State Bank, is valued at \$23,000. Customers' notes are given as the security held by L. Heller & Son and L. Tannenbaum & Co. The Commission Merchants' Association is said to have jewelry and accounts to the amount of \$2,000.

Following is a list of unsecured creditors: Eichberg & Co., \$3,196; Oppenheim & Strauss, \$3,149; John Tichenor & Co., \$878; Malliet & Maxwell, \$2,283; Frederick Wacker, \$346; Ernst Veeck, \$1,004; Eberhard Heller, \$2,676; Eimer & Amend, \$195; Arthur Marson, \$411; Chapelle & Shaubacher, \$142; Azure Mining Co., \$180; R. A. Breidenbach, \$570; Goodfriend Bros., \$804; Mrs. E. O. Schroeder (money loaned and open account), \$29,044; Conrad Schickerling, care L. Bronner (money loaned and merchandise open accounts and creditor holds notes), \$53,881; Hergers Bros., \$179; John Roth, \$162; New York Edison Co., \$135; Gans & Iselin, \$150; Dennison Mfg. Co., \$219; William Reiman, \$377; Stern & Rushmore, \$125; Guy Whitthouse, \$216; Schwartz & Co., \$251; Bradstreet Co., \$100; Herring-Hall-Marvin Safe Co., \$200; T. M. Schroeder, \$1,935.

Fred. J. Loos, Mauch Chunk, Pa., has sold out.

Ernest J. Leben, Americus, Ga., recently offered his creditors a composition at 25 cents on the dollar. Mr. Leben was formerly in business at Jennings, La., and in the fall of 1904 opened at 408 Jackson St., in Americus.

**W<sup>M</sup> S. HEDGES & CO.,**

IMPORTERS AND CUTTERS OF

**DIAMONDS.**

Precious Stones and Pearls.

**170 Broadway, Corner Maiden Lane, New York.**

27 Holborn Viaduct, London.

**Saunders, Meurer & Co.** Cutters and Importers of**DIAMONDS** AND OTHER  
PRECIOUS STONES

FINE PEARLS A SPECIALTY.

65 Nassau St., cor. John St., Prescott Building,  
Telephone, 1613 Cortland, NEW YORK.**Chas. L. Power & Co.,** Cutters and Importers,**DIAMONDS**

AND OTHER PRECIOUS STONES,

170 Broadway, corner Maiden Lane, NEW YORK.

27 Holborn Viaduct, London.

**GOODFRIEND BROS.,**

IMPORTERS AND CUTTERS OF PRECIOUS AND IMITATION STONES.

Pearls

Rubies

Sapphires

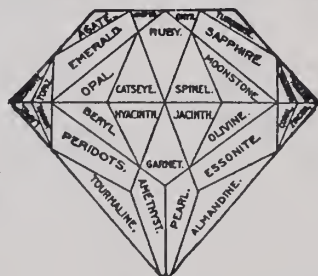

Tourmalines

Gem Corals

Opals

Emeralds

COPYRIGHT, 1895, BY GOODFRIEND BROS.

256 Westminister St., Providence, R. I.  
10 Rue Cadet, Paris.Tel. No.  
662 Cortl't.

9-11-13 Maiden Lane, New York.

**CORAL****BORRELLI & VITELLI,**  
CORAL MANUFACTURING COMPANY,All kinds of Coral—DROPS, BUTTONS, LENTILLES.  
CORAL NECKLACES, Graduated and Uniform.

PINK AND WHITE CORAL A SPECIALTY.

GOLD MEDAL, ST. LOUIS, 1904.  
GRAND PRIX, LIEGE, 1905.

3 Via Amedeo, Torre del Greco, Italy. 32 Rue d'Hauteville, Paris, France.

401 Broadway, New York.

Telephone, 5412 Franklin.

CORAL

CORAL

**Mr. Retailer:**

The Jobbers  
are taxing  
us to our  
utmost capacity  
with orders  
for the best  
line of  
Gold Watch  
Cases we ever  
created.

You will be  
pleased with  
their selections,  
we assure you.

**"WATCH OUT"****SOLIDARITY**  
**Watch Case Co.**

Established 1885.

3 Maiden Lane, New York.

GENERAL SELLING AGENTS

JOHN W. SHERWOOD  
FRANK E. HARMER

## San Francisco Jewelers Making Great Progress.

### Retail Jewelers Anxiously Watching the Development of a New Retail Jewelry District—An Association Formed to Help the Unemployed.

SAN FRANCISCO, Cal., May 16.—Most of the wholesale dealers are now fairly well settled as far as immediate business is concerned. Those firms which intend to locate in the Jewelers' and Silversmiths' building, at 717 Market St., are preparing to move within a few days, although it looks as though there may be some delay in a few cases. One or two wholesale houses will remain in Oakland for several months to come, while others are already preparing to handle incoming stock from their temporary offices in this city.

This week the main interest centers in the future of the retail trade. Aside from Shreve & Co., none of the big retail houses has announced definite intentions for the future. Most of the larger concerns intend to resume business, but they are not disposed to rush matters in the selection of either temporary or permanent stores. They do not anticipate any great amount of retail jewelry business here for some time to come, and they prefer to await the developments of a permanent retail district in the city before they sign leases.

A number of stores have located along Fillmore St., where a lively trade in cutlery, plated ware, etc., has sprung up. Several pawnbrokers have also opened in the city, and these are doing some business in jewelry, watches, spectacles, etc.

SAN FRANCISCO, Cal., May 16.—The wholesale and retail jewelers and silversmiths of this city held a meeting at 1551 Devisadero St. this week to lay plans for the relief of their former employes. It is estimated that 3,000 jewelers, who were working in this city at the time, have been thrown out of employment without the same prospect for a resumption of work that those in other trades enjoy. The problem of aiding these, which early attracted the attention of the members of the New York Jewelers Board of Trade, is now to be taken up by the local people, who will add their portion to the generous contribution from New York.

At the meeting an organization was effected under the name of the Jewelers' Relief Association, and the following officers were elected: Kenneth Melrose, of the W. K. Vanderslice Co., president; Col. A. Andrews, vice-president; R. F. Allen, of the Morgan & Allen Co., secretary, and Leon Carrau, of Carrau & Green, treasurer. The executive committee consists of A. Hirschman, Bruce Bonny, of Shreve & Co.; John A. Hammersmith, of Hammersmith & Field; B. Schaezlein, of Schaezlein & Burridge; H. H. Adams, Kenneth Melrose, Col. A. Andrews, R. F. Allen and Leon Carrau.

All former employes who may be in need have been asked to report to the association through its secretary, R. F. Allen, 1867 Post St.

The following letter has been received from the officers of the Jewelers' Relief Association of San Francisco, organized to help those formerly connected with the jewelry trade of San Francisco, who may be in need of assistance, and to receive and dis-

burse funds kindly donated for their relief:

1867 Post St.,

SAN FRANCISCO, Cal., May 16, 1906.

Editor of THE JEWELERS' CIRCULAR—WEEKLY:

The prominent wholesale, retail and manufacturing jewelry concerns of San Francisco have organized the Jewelers' Relief Association of San Francisco, for the purpose of extending assistance to those formerly connected with the jewelry trade who have been left in actual want by the great calamity which has recently visited us.

We understand that the various jewelers' organizations, including both the jewelers' boards of trade located in the various cities, and the organizations of both office and shop employes, have been soliciting contributions for the relief of those in their lines in this city who are at present in need of such assistance. This organization has been formed partly for the purpose of receiving such funds and arranging for their proper distribution.

You can help us materially by giving prominence in your publication to the organization of this association and by bringing it in touch with all of those in the trade, including trade organizations.

There are from 2,000 to 3,000 men formerly connected with the jewelry trade in various capacities in this city, who will probably not be able to find employment for some time to come. They will need assistance perhaps worse than any other class of men, but at the same time they should be helped in a systematic and proper manner.

We will keep you advised in regard to the work of the association, and, thanking you for the assistance we know you will be glad to render, we remain, Yours truly,

KENNETH MELROSE, President.  
R. F. ALLEN, Secretary.

The Jewelers Board of Trade, New York, received on Monday a circular sent out from San Francisco under date of May 16, announcing the recent formation of the Jewelers' Relief Association, as published in another column. A member of the committee appointed by the Jewelers Board of Trade to receive subscriptions for the San Francisco Relief Fund, said yesterday:

"We were advised directly after we heard of the disaster that the jewelers in San Francisco organized such an association as they have formed. We wrote to Bruce Bonney, of Shreve & Co., and to A. W. Huggins, making such a suggestion. We did not, however, learn that anything had been done toward forming the association until May 16. We sent on that day \$1,500 to the order of Shreve & Co., to be applied for uses of the association. If we had been informed earlier as to the formation of the organization we might have sent it a larger proportion of our fund, but before we heard of what had been done we sent \$25,000 to the general fund represented by ex-Mayor Phelan. Of this amount \$15,000 was forwarded May 1 and \$10,000 May 8. In addition we sent \$600 in cash and a quantity of tools and materials to the jewelers of Santa Rosa. There is now in our fund about \$5,000."

In a letter received by THE CIRCULAR—WEEKLY from Bruce Bonney, of Shreve & Co., writing under date of May 14, he says: "Conditions in all ways are greatly improved in San Francisco, as you must know, and have in no particular been as bad or become as serious as apprehended immediately after the fire. As is usually the case, the reports about shooting and lawlessness of all kinds were greatly exaggerated; also as to the number of lives lost. There has been no epidemic of smallpox or other dis-

eases. There is some apprehension of epidemic with bad water as the cause, because of the breaking of water mains, but the supply is rapidly being improved, and if people will observe the simple rule of boiling the water they can escape all danger.

"We notice a statement in a letter published in your issue of May 2 to the effect that it was supposed that the loss by fire of Shreve & Co. would be from \$300,000 to \$400,000. We do not estimate it as high as this, but cannot state an exact figure, as our store vaults were opened on the 12th inst. and we are now making inventory of their contents. It is our impression that over and above insurance our actual property loss will not reach \$50,000.

"Our store was completely burned out, but the building was left in sound condition, and can be completely restored within a year, requiring (so we are assured by the builders) not six months of actual work for its restoration.

"Our new factory was completely destroyed. We have not at this date opened our factory vaults, but have reason to believe that they are intact. We have a small temporary jewelry factory in operation; also working room for all of our watch repairers, and have commenced the construction of a temporary factory building of timber and corrugated iron, and shall operate this until our permanent factory is restored. We have opened a temporary salesroom in the unburned residence district which we shall maintain until our store at Post St. and Grant Ave. is restored."

MR. FEINTUCH OFFERS SOME CORRECTIONS AS TO STATEMENTS IN A LETTER PUBLISHED MAY 2.

THE CIRCULAR—WEEKLY is in receipt of the following letter from M. Feintuch, 1723 Post St., San Francisco, which is self-explanatory:

SAN FRANCISCO, May 16, 1906.

Editor of THE JEWELERS' CIRCULAR—WEEKLY:

Owing to the very heavy accumulation of second class matter—caused by desire on the part of the postal authorities here to deliver the serious mass of first class matter that gathered itself during the few days subsequent to our great disaster—your issue of May 2 was only delivered to-day. I simply offer this as an apology on the part of many of our citizens for not previously taking umbrage over the contents of a letter printed on page 41 of the above issue, emanating from one of the residents of this city who fled out of town and who wrote his presumed facts from a distance of 40 miles.

As showing some little authority for this reply, I would simply state that I was closely identified with the Citizens' Committee during the dark days that followed our great catastrophe, and while only an humble one of many, still followed the work faithfully and steadily until matters were finally and gradually placed in the hands of the military authorities, where they are now being properly cared for and the citizens relieved to a great extent of its duties.

During the three weeks in which the citizens and military had complete control over the affairs of the city, bringing immediate order out of chaos, nothing transpired of any nature whatsoever of which the authorities in charge were not immediately aware. I can therefore assert upon authority that statements in the letter you publish were written in the excitement of the moment and that the author did not have a single rumor verified. Had he done so, he certainly would not have made the statements he did, though it is just possible that his letter, being purely a personal one and not intended originally for publication, he did not give it the care which a communication of the latter variety properly requires. It would seem, however, that it should have received a censure of some kind at your hands before allowing it to be widely circulated, as was done through the medium of your publication. If you will be good

ADDISON W. WOODHULL, President.  
FRANK K. HUFF, Vice-President.

GILBERT T. WOODHULL, Treasurer.  
WILLIAM J. McQUILLIN, Secretary.

# MOUNT & WOODHULL,

IMPORTERS OF

**DIAMONDS,  
OTHER PRECIOUS STONES,  
PEARLS, ETC.**

MAKERS OF

**FINE  
DIAMOND  
JEWELRY.**

26 Maiden Lane,  
(Southwest Corner Nassau Street)

**NEW YORK.**

**PARIS ADDRESS:**  
5 SQUARE DE L'OPERA.

**BAGG, PERINE & CO.,**  
RARE SPECIMENS OF  
DIAMONDS AND OTHER  
PRECIOUS STONES,  
21 & 23 MAIDEN LANE, NEW YORK.  
Tel. No. 6226 Cortlandt.

**EMERALDS,  
DIAMONDS  
AND  
PEARLS.**

**RUBIES AND  
SAPPHIRES.**

**CABLE ADDRESS:**  
**MILBAGG.**

**Pearl Necklaces  
and Collarettes.**

**Mounted  
Diamond  
Jewelry**  
of every  
description.



*Ludwig Nissen*  
*Emil Knopf*  
*John W. Ruefer*  
*Frank L. Wood*

Large  
assortment  
of all kinds of  
very fine, fancy  
and rare gems,  
including Pearls,  
Diamonds, Rubies,  
Emeralds and Sapphires.

182 & 184 BROADWAY  
NEW YORK

**Particularly Fancy  
Colored and Fancy  
Shaped Diamonds.**

enough to follow the communication referred to, I will point out some of its inaccuracies.

There never was even a rumor that smallpox had broken out, and this is based on the fact that no one ever heard of the disease. Not a single case of this kind has been reported, and it may be accepted as a positive fact that no matter how lax the health officers were obliged to be for a day or two (and even this is not so), the merest rumor of a disease so dread as smallpox would have received instant attention and arrest. It is nothing short of calumny to allow a statement of this kind to go unrefuted when it is absolutely untrue.

He also states that "every day there are dozens of men shot for different causes," etc., etc. This is nothing short of an untruth. I am not attacking the writer for his statement, but why in heaven's name did he not at least attempt to verify such a rumor, if such a rumor reached him. In all the time during which the city was under military and civic control—during all those dark days and nights, nights when we were not even allowed to light a candle after dark—when people left their homes on the latch to wander at random to the parks and hills for protection and there sleep upon the grass, we had but two cases of shooting. Just two, that's all.

Both these cases received immediate investigation, the offenders arrested and are now undergoing proper trial by the proper authorities. The soldiers who committed the deeds acted under orders from their superior officers, and in these two individual cases let no one pass judgment until the facts are properly presented to the courts.

The statement about the riotous acts of the soldiers is without the slightest foundation. No one was shot down nor was it left to the soldier's judgment as to the general right to shoot on sight. I question if the world has ever before seen such an illustration of order and system as was brought about in this city within two hours of a great calamity. The city was in absolute control right from the commencement of the great fire, and it remained so and has remained so up to the present moment. No one questions the ability of the authorities to continue that condition.

As to the statement that "anyone caught charging more than regular prices for goods their stock is taken away"—this is about the only true statement in the letter. That was true—absolutely so—and it shows the quick and commendable spirit of the men in charge. The people were protected in this way. No one's stock was confiscated except by the authorities, and then proper receipts were given and claims requested to be filed against the city. Every legitimate claim will be paid and cheerfully. A proper committee was appointed to prevent overcharging of food supplies. "The people must be protected," said the able men on that committee, and anyone who overcharges must turn over his stock to the city to be paid for at proper prices." And the people were protected. One or two confiscations and the battle was won. No one attempted to overcharge after that.

Within 24 hours after the shock, and while the fire was still raging, every saloon and groggery left standing was drained of its liquor and the stuff poured into the gutters. Every grocery that liquor was found in was served in the same way. Notice was served upon each place of this kind not to open again until further orders, and this was later supplemented by removing all liquor licenses and positively and legally preventing the places to reopen until further orders. These "further orders" have not been given yet, and they will not be for a little while, and then in a very restricted manner. We haven't had a drunk on the streets since the fire began. This is not mere braggadocio, it's a solemn fact, and all this in a wild western town.

I do not care to particularize the many statements made about individual instances of shooting. They are one and all not true, and that is as mild as I care to write about them. There is one statement, however, against which I protest vigorously. It is the prediction that "the worst is yet to come when disease commences to take the population off, that they will die by the thousands, and it does not appear that there is any way to stop it." By what right does this writer assume such a fact. It is absolutely wrong to make such a statement. Disease did not and cannot arise in this city—no matter from what source or cause. The fact remains (and this is the best evidence) that we have had no diseases and that the health of the city was never better than through all this period of darkness and sorrow. Statistics are here for that, and that is proof enough. With all the temporary shelter to thousands of people, temporarily without a roof for people to sleep under,

sleeping and housing themselves in parks and in open lots, with all the discomfort and unsanitary conditions that this means, with the consumption of canned food as the only means perhaps of satisfying hunger, and with a hundred other drawbacks, no one has heard of sickness, and the typhoid fever hospitals so quickly erected are, and have been, without a single patient. Do you want any better evidence than this as to the incorrectness of the statements to which I refer?

San Francisco is destined to be bigger, better and more beautiful than ever. I can't resist using the "three Bs" to describe my opinion no matter how inelegant the expression.

There are still a few big buildings left. They are not all "burned out," and instead of there being "not much" of the residence portion of the city left, let me assure you a great big portion of it is still standing. There never were "thousands going hungry," for people were immediately cared for, thanks to the great big bully heart of the American nation and to the excellent care with which matters were handled here by men who stood by their guns and were not frightened off by a little shake and a big blaze. Yours very truly,  
W. FEINTUCH.

**Foreman in Tiffany & Co.'s Factory Pleads Guilty to Three Charges of Grand Larceny.**

Guilty, was the plea entered Monday by John D. Brosseau, foreman in Tiffany & Co.'s factory, who stole from his employers for several years past by padding the pay rolls. The plea was entered to three indictments, charging him with grand larceny, before Judge Foster of the Court of General Sessions, New York. Ralph M. Hyde, the company's superintendent, said that the concern was not desirous of pressing for a sentence to imprisonment. The Judge announced that the sentence will be delivered on Saturday. The maximum term is 15 years' imprisonment.

An account of Brosseau's arrest was published in THE CIRCULAR-WEEKLY of May 9. It has been said that in each of the last two years he took about \$5,000. His method, as already explained, was to draw upon the cashier for larger sums than he actually paid to the men entrusted to his charge and to pocket the difference.

When Brosseau was first arraigned he declared that he had not gambled nor spent the money in dissipation. He intimated that sickness and other troubles of the members of his family had been responsible for his expending large amounts in excess of his income. In the last week one of the papers has published an article charging that he had really lost large sums of money in a gambling house near his home.

**Thief Who Stole Lancaster, Pa., Manufacturer's Satchel of Jewelry Pleads Guilty to Larceny.**

LANCASTER, Pa., May 21.—William Fraker, a railroad engineer, pleaded guilty in court at Carlisle last week to the charge of stealing a case containing jewelry valued at \$3,500 from L. C. Reisner, a manufacturing jeweler of this town, several weeks ago. At the time of the theft Fraker and Reisner were riding together on a railroad car to Chambersburg, and occupied the same seat. At Oakville Fraker left the car, carrying along Mr. Reisner's satchel.

Some of the plunder was secreted by the thief in a cross-tie pile, where it was almost immediately found, and the rest was thrown away by the thief. Fraker was arrested on the night of the robbery, and the next day the case and jewelry, worth \$1,850, were recovered near Shippensburg.

**News Gleanings.**

Sears & Neds, Three Oaks, Mich., have been succeeded by Z. T. Sears.

W. G. Sheppard has moved his stock from Cambridge to Indianola, Nebr.

Mrs. L. M. Kaelin, Nelsonville, O., has completely remodeled her store.

S. E. Williams, Rome, N. Y., is enjoying a two weeks' fishing trip in the Adirondacks.

Joseph Kern, Wilmington, Del., has just added a large new safe to his office equipments.

The stock of the late Geo. W. Sayer, Spencer, Mass., was disposed of at auction about a week ago.

H. Amundson, formerly of Chicago, has taken a position with Chas. F. Halbkat, Watertown, S. Dak.

T. K. Smith has sold his store building at Albia, Ia., and moved his jewelry stock to his store in Oskaloosa, Ia.

Extensive improvements have just been made in the store of J. Frank Allee, Dover, Del. New show cases have been installed.

Chas. Wendell, of Jules Wendell & Son, Oswego, N. Y., left last Thursday for an outing and fishing trip in the Adirondacks.

The medals for the Oklahoma Intercollegiate meet in Oklahoma City, Okla., were recently displayed in the show windows of Boasen Bros.

J. Gomph, Utica, N. Y., is enjoying a two weeks' recreation and fishing trip with a party of friends at Pine Lake, in the Adirondacks.

M. O. Bowser, a retail jeweler, of Ames, Ia., recently recovered in a pawnshop in Des Moines, Ia., a ring which had been stolen from his store some time ago.

Chas. H. Robie, for a number of years in the jewelry business at Olean, N. Y., and since leaving there in Austin, Pa., is now located at Williamson, N. Y., where he began business over 20 years ago.

The old wooden building, formerly occupied by the jewelry store of Mrs. M. Yaeke, at 104 Columbia St., Utica, N. Y., has been torn down and will be replaced by a four-story, up-to-date brick structure.

Plans are now being made for the erection of a new building at the corner of Granby St. and City Hall Ave., Norfolk, Va., by the Paul-Gale-Greenwood Co. The building, it is reported, will cost about \$30,000.

Peter Mathews and John Pegrollaz were tried recently in the Circuit Court of Anderson, Ind., on a charge of attempting to murder and rob Justin Lemon, an aged Swiss watchmaker and pawnbroker, of Alexandria, Ind.

The drug and jewelry store of Mr. Smith, Meeker, Okla., was entered recently by thieves, who stole \$300 worth of miscellaneous jewelry. The burglars are believed to have gone south on the Santa Fé train and to be hiding in Shawnee.

The old clock in St. Michael's Church, Charleston, S. C., has been running very irregularly of late, and notwithstanding the numerous times it has been repaired many citizens believe that a new set of works will have to be installed before the timepiece will keep accurate time.

Joshua D. Howell, for a number of years located at Livonia Station, N. Y., has sold

his business to Floyd J. Wemett and removed to Hanford, Cal. The sale was occasioned by Mr. Howell's health, which has not been the best for a year or more. Mr. Wemett has been in Mr. Howell's employ for the past six years and is well known in Livonia Station.

H. A. Barret, of the Columbian Bifocal Optical Co., Denver, Colo., was in St. Louis, Mo., on a business trip, last week.

Archie Tegtmeyer, 344 Grove St., Milwaukee, Wis., has taken a 10 years' lease of the building at the northwest corner of Grove St. and National Ave. Mr. Tegtmeyer will remodel the first floor, which will be used by him as a jewelry store. The improvements are expected to be completed by the end of July. The new quarters will give the jeweler additional facilities in the way of a larger amount of floor space and more spacious show windows.

The Alabama Optical Society held its first annual meeting in the Cable Music Hall, Birmingham, Ala., yesterday. There was a morning, an afternoon and an evening session. Among the speakers were Dr. S. W. Lane, Kansas City, Mo., president of the South Western Optical College; H. J. Cook, president of the Tennessee Optical Society; C. E. Folsom, of the Georgia Optical Society; M. B. Clason, Columbus, Ga.; William E. Huston, secretary American Association of Opticians.

**Newark.**

Sylvester G. Van Wart, Englewood, will occupy quarters in the Humphrey building after it is remodeled.

A new clock with striking attachment is to be installed in the tower of the Municipal Building, Main Ave. and Prospect St., Passaic, N. J., as the gift of County Clerk John J. Slater. The presentation is to take place in the near future with appropriate ceremonies.

In the window of J. Wiss & Sons is a quantity of jewelry, watches and novelties scorched and melted into quaint shapes. The collection came from the ruins of the Cam building, 171 Market St., San Francisco, and was sent here by George Allsopp, who is now in the western city in the interest of Newark jewelers. The articles were in one of the safes in a burned building. The works of several watches melted inside the cases.

Strobell & Crane are to have a new factory at E. Kinney and Orchard Sts. Work on the building began this week. The structure will be of brick, four stories high, with basement, and will cover a plot 35 by 125 feet, with a wing 20 by 60 feet. The building, which will cost \$35,000, will be equipped with a power plant and freight elevator. Frederick Fatzler will do the masonry work; the Russell-Robinson Co., the carpentering; Jacob Rau, Jr., the plumbing.

**Market Price of Silver Bars.**

The following are the quotations of silver bars in London and New York, as reported by Zimmermann & Forshay:

	New York.	London.
May 15.....	\$.66 1/2	30 11-16d.
" 16.....	.66 5/8	30 3-4d.
" 17.....	.66 7/8	30 7-8d.
" 18.....	.67 1/4	31 1-16d.
" 19.....	.67 3/4	31 1-4d.
" 21.....	.67 3/4	31 1-4d.

# EICHBERG & CO.,

IMPORTERS AND CUTTERS OF

## DIAMONDS,

65 NASSAU STREET, (Prescott Building.) NEW YORK.

# STERN BROS. & CO.,

IMPORTERS AND CUTTERS OF

## DIAMONDS,

CUTTING WORKS:  
138-142 West 14th St., N.Y.

CHICAGO, LONDON,  
103 State Street. 29 Ely Place.

68 Nassau St.,  
NEW YORK.

WITH the growing scarcity of fine Sapphires and the increased demand, the upward tendency of prices will continue, emphasizing the necessity of constant watchfulness, accurate knowledge of values, and quick action to secure advantageous bargains, and also demonstrating the necessity of a "GEMFINDER" on the spot to care for the interests of American buyers.

FREDERICK A. JEANNE,  
"Gemfinder."

5, Square de l'Opéra, PARIS, FRANCE.

London: Chancery Lane Safe Deposits. New York: Malden Lane Safe Deposit Co.

**A. ROSEMAN, 9-11-13 Maiden Lane, New York**

IMPORTER OF

# DIAMONDS

Maker of Diamond Jewelry



TRADE-MARK.

Established 1872

HEADQUARTERS FOR

# AMERICAN WATCHES

IMPORTERS

## DIAMONDS

CUTTERS

# Jacob Strauss & Sons

14 MAIDEN LANE

NEW YORK

**LEO GOLDSMITH, IMPORTER OF DIAMONDS**

TELEPHONE: 4115 CORTLAND.

and Precious Stones. Headquarters for Reconstructed Rubies and Sapphires. All sizes and forms.

9-13 MAIDEN LANE,

NEW YORK.

## Has One of Our 8 Salesmen Called On You?

They are showing the most attractive lines of American Watches, Diamonds and Jewelry that are being shown this season.

"We cover the country."

From our  
New York Office:  
H. OLLENDORFF  
M. OLLENDORFF  
H. GOLDSTEIN

From our  
Pittsburg Office:  
W. S. BICKART  
J. S. BICKART  
W. E. PARISH  
S. A. REUTER

Special Southern Representative:  
O. J. SOMERS

Should your wants necessitate an immediate delivery before our representative's arrival, either our New York or Pittsburg office will give your order by mail PROMPT and CAREFUL attention.

## I. Ollendorff Co.

JOBBERS IN

Watches, Diamonds and Jewelry

PITTSBURG, PA.:

Cor. Liberty Ave. & 6th St.

NEW YORK:

54 Maiden Lane

ESTABLISHED 1868.

## HENRY C. HASKELL



DESIGNER

AND

MAKER

Correspondence invited for Special Articles of every description, gold or silver, from exclusive designs.

15 West 27th Street, New York

## The Diamond Markets.

ANTWERP, May 12.—Contrary to expectations, sales have not been particularly brisk during the past fortnight. Several large buyers were announced to be here the beginning of May, but some have not come, and those who did have not purchased very large lots. This is due partly to the fact that they have not been able to get the goods that they required, and also to the high prices at which stones are held.

Rough goods are higher and scarcer than ever, and the prices, it is believed, will remain very firm, especially for *Mêlée*. The demand for roses and "six faces" is quiet at present. A number of lots of very good roses have been sold at from 140 to 150 francs per carat.

The following were among the buyers registered at the Diamond Club: Messrs. Rappoport, Villet, Heschelton, Mund, Goroolinsky, Langbank, M. Slabotzky, Arm. Levy, M. De Vries, Garabadian, all of Paris; Messrs. Lunzer, Gallop, Twi, Tufeld, Broekhuyzen, London; Messrs. Abend, Nix, Erder, Berlin; Mr. Grossbardt, Warsaw; Messrs. Hekster, Asscher, Amsterdam; Mr. Mallak, Salonique; Jacob Strauss, New York; Mr. Myers, Boston; Mr. Lagswir, Moscow; Mr. Bellak, Vienna; Mr. Van Gulk, Goch; Messrs. Monossohn, Alexandroff, St. Petersburg.

AMSTERDAM, May 10.—Business in the diamond trade here continues quiet. Small goods find buyers, but large brilliants are for the present somewhat neglected. Several foreign buyers are expected to arrive this month, and it is hoped that sales will then pick up.

The following are among those who have been here during the past few days: Representatives of Stern Bros. & Co., New York; Fox Bros. & Co., Cincinnati; Kohn & Saul, Antwerp; J. B. Kaufmann, London; Mr. Oppenheim, Frankfurt-on-Main, and Messrs. Prager, A. & E. Worms, and Lambert Frères, Paris.

A general meeting of the shareholders of the "Diamantslypery Maatschappy" took place at the end of April. The report of S. Lehman, the manager, was to the effect that conditions during the year surpassed all previous years. The dividend declared in 1905 was 24 florins, as against 13.20 in 1904. New rooms were rented, in order to establish a sawing shop and a model cutting shop of 23 mills.

Amsterdam, it is expected, will be among the cities to feel the consequences of the San Francisco disaster, as several large houses in this city regularly bought from the diamond cutters here, and of course this trade is not expected to be resumed for some time.

PARIS, May 11.—The general condition of business is now somewhat better among jewelers, though they, as well as others, were affected by the labor agitation which began May 1. The partial end of the strike in the jewelry trade has helped matters to some extent.

At present there is a good demand for fine *mêlée* of about 225 francs per carat and the market shows a better tendency as far as four-grain stones are concerned. Trade in rubies is very quiet now, but small

pearls are in demand. This city did a fair business in pearls and colored stones with San Francisco, and the disaster there will undoubtedly be felt to some extent.

A new firm was recently established here under the style of L. Bloch & J. Levy, with offices at 38 Rue de Chateaudun. Among the failures recently were those of E. Pittet & Co., 8 Rue de Chateaudun, and H. Aboaf, 31 Rue de Maubeuge.

## Buffalo, N. Y.

Carl Seifert, Lockport, N. Y., retailer, called on Buffalo jewelers on Wednesday.

Charles F. Smith, credit man with King & Eisele, was in New York City for a long stay on business and pleasure. He came home yesterday.

The bankrupt stock of Philip Fischer, which has been on sale for several weeks in an unoccupied storeroom in Main St., is about closed out.

Charles F. Damm is now firmly established in his new Main St. store. He completed removal from his old Washington St. quarters early last week.

The Dennison Tag Co., dealing in jewelers' findings in Ellicott Sq for a number of years, has moved into new and more commodious quarters at 627 Main St.

Webb C. Ball, of Cleveland, O., was in Buffalo early last week. Mr. Ball was accompanied by his wife, and made a careful inspection of T. & E. Dickinson & Co.'s store at 472 Main St., and declared it to be one of the most attractive he had ever seen.

E. V. Syrcher, with Best & Co., 11 E. Genesee St., for 20 years a prominent worker in the Buffalo Y. M. C. A., has been selected by the trustees of the Lafayette Presbyterian Church to organize baseball and other athletic clubs and manage them for the Summer.

Frank Hammond, 54 Seneca St., is making extensive alterations in his store. He is putting in new and more modern front doors and show windows, and the entire establishment is being redecorated and painted. Mr. Hammond came home from watch inspection on the Boston and Maine Railroad, last week.

## Taunton, Mass.

The Poole Silver Co. has gone on its Summer working schedule. The employes will work five days a week, and enjoy a Saturday holiday.

William F. Bodfish and Frank Bauers, of this town, were arrested in Brockton, Mass., last week, charged with being itinerant vendors. The allegation was that they brought jewelry into the city to dispose of at auction. Bodfish was fined \$25, and Bauers was discharged, it appearing that he had been merely retained as auctioneer.

Edward Haase, Fairhaven, N. J., a retail jewelry dealer, is now in custody here, awaiting the attention of the court for various allegations connected with some optical deals of a few months ago. It is claimed that he toured this part of Massachusetts as an optician and received money for eye treatment and for the furnishing of optical supplies to patrons, the latter claiming to find afterward that they had not secured what they supposed they were getting. He was arrested in this State some weeks ago

and escaped from the officer in whose charge he traveled. Last week a Taunton detective watched for him at his home in Fairhaven, N. J., and caught him, lodging him in the jail at Freehold, N. J. Securing extradition papers, he went to the jail, only to see Haase disappearing up the road in a cloud of dust in an auto. Habeas corpus papers had been taken out and the man was on his way to a justice at Atlantic Highlands for a hearing. The detective in another auto beat him to the home of the justice and took him again in custody.

## New Stores and Enterprises.

R. D. Strain recently opened a store in Oberlin, Kans.

Arvid Greenland is a new jeweler at 45 Railroad Ave., White Plains, N. Y.

D. S. C. Brimer, Sanborn, N. Dak., will shortly begin business in Page, N. Dak.

It is reported that T. J. O'Connell, formerly of San Francisco, Cal., will soon open a jewelry store at Hancock, N. Y.

Marshall O. Rose, Pendleton, Ore., has purchased the building next to the post-office in Ione, Ore., and is putting in a stock of jewelry.

The Lycoming Jewelry Co. recently opened a new store at 13 W. Market Sq., Williamsport, Pa. Chas. Zuc is the owner of the business.

Ludwig Dlouhy and John Kiley, Rochester, Minn., will engage in the retail jewelry business as partners in Winnebago, Minn., in the near future.

J. E. Whitten has returned to Ensley, Ala., his former residence, where he will engage in the retail jewelry business. He will have quarters on Ave. E.

Steven N. Massey will shortly begin business on his own account at 126 W. 3d St., Chester, Pa. Mr. Massey was formerly employed by the Cross Optical & Jewelry Co.

F. X. Newberger on June 1 will engage in the jewelry and watch repairing business in Spokane, Wash. Mr. Newberger was formerly watchmaker for the Bohm-Allen Jewelry Co., Denver, Colo.

Mr. Johannsen opened a new store at 550 Main St., Dubuque, Ia., about a week ago. Mr. Johannsen signalized the opening of his new establishment by giving every visitor an attractive glass candy dish.

O. E. Rudolph, who for the past four years had been in the employ of J. H. G. Durant, New Haven, Conn., has opened a watch repairing shop at 441 State St., New Haven.

The Perry-Aldrich Co. was recently organized in Kittery, Me., to manufacture watches, with a capital stock of \$15,000. The officers are: President, Horace Mitchell, Kittery; treasurer, S. J. Morrison, Portsmouth, N. H.

The American Jewelry Co., Brooklyn, N. Y., has been incorporated with the Secretary of State, with a capital of \$25,000, and the following as directors: Edward H. Pfeiffer, Albert Levy and Howard O. Paterson, of Brooklyn.

David Eaffy & Co. have opened a new store in the Colonial Arcade, Cleveland, O. Mr. Eaffy has been with Burt Ramsey & Co., Cleveland, O., as watchmaker for the past eight years. F. B. Lewis is the other member of the firm. They have a very pretty little store and one that will attract attention.

SEND TO US ANY QUANTITY OF

# AMERICAN PEARLS

WE BUY FOR CASH.

Send by registered mail or express; we will make an offer by return mail. We will also buy any quantity of

**BAROQUE PEARLS (SLUGS).**

**BUNDE & UPMAYER CO.,**

Mack Block,

MILWAUKEE, WIS.



**The Demand for String Pearls is Enormous**

**FASHION DICTATES PEARLS**

Our stock is the largest and most complete in America of the finest Fish-Skin Pearls. Prices range from

**30c. to \$25.00 per String**

Selection packages sent on request.

**CHOPARD FRÈRES**

MAKERS OF ART JEWELRY NOVELTIES.

49 Maiden Lane

NEW YORK

FACTORY: 35 Rue Des Trois Bornes, PARIS, FRANCE.

**FINE AMETHYSTS  
AND AQUAMARINES**

We are prepared to furnish you with a selection at once, and solicit your order on memorandum.

**UNIQUE STONES are our SPECIALTY.**

Send for our new booklet containing a list of over 100 precious stones, their distinguishing features and colors, also articles on "THE INFLUENCE OF GEMS ON CERTAIN DAYS" and "THE SIGNIFICANCE OF GEMS," a handy book of reference that will assist you in selling.

**The PASSMORE GEM CO., 373 Washington St., Boston, Mass.**



## North Attleboro.

William F. Maintien returned Wednesday from the west.

Fred E. Sturdy has been at the Rainbow Lake in Maine for the past week on a fishing trip.

The firms located in the Totten building on East St. were obliged to suspend work Saturday because of an accident to the engine pump.

Mrs. Emma Frances Heffron, widow of Frederick D. Heffron, was quietly married on Thursday evening to Edward J. Sullivan, American Consul to Trepizond, Turkey.

The employes of Riley & French have organized an athletic association. Howard Grant has been chosen president; John Murphy, secretary and treasurer, and Edward Collins, vice-president. The association will hold a field day on Saturday at Foxboro.

James R. Bugbee, an old time jeweler, died last Wednesday at the mature age of 89. He formerly was employed by the Whiting Mfg. Co., F. M. Whiting & Co. and C. E. Smith & Co. His brother founded the firm of Bugbee & Niles. A son, George C. Bugbee, the proprietor of a hub-cutting and diesinking establishment, survives.

The tremendous business that the local jewelers have done during the past two years has made the scarcity of tenements oppressive in North Attleboro and Plainville. Not a single house is vacant in either town and hundreds who are employed here are obliged against their will to reside in Attleboro, Pawtucket or Providence. This lack of dwellings has had some effect on manufacturers securing help and now there is a concerted effort being made to remedy matters. A real estate company will be organized this week, with a capital of \$25,000. Maintien Bros. & Elliott, William F. Maintien, Scofield, Melcher & Scofield, John L. Thompson, A. E. Coddington, Alpin Chisholm, George K. Webster and James D. Lincoln are among those who have subscribed to the stock. The company is not formed as a money making scheme, but for the benefit of the working people, and the rental price on the houses constructed will be as low as possible and yet give the investor a fair rate of interest.

## Providence.

The compromise offer made by Gustavus H. Emerson, of this city, and accepted by his creditors, has been confirmed by Judge Brown, of the United States Circuit Court. He offered 20 per cent. cash and 5 per cent. notes. Funds of \$1,285 have been deposited to cover the payments.

The various shops are being represented on the diamond this year by teams, but there is no jewelers' league such as there was a few years ago and no indications that one will be formed, though there are a vast number of "fans" among the jewelers who would be glad to see the old movement revived.

The outing held a week ago Saturday by the employes of Ford & Carpenter, was a most enjoyable event, and the employes deeply appreciated the firm's generosity in allowing the whole day for the visit to

Emery Park. In the report of the affair last week the name of Martin, Copeland & Co. was inadvertently used instead of Ford & Carpenter.

Buyers in town last week included the following: Adolph Ritter and M. L. Kahn, Philadelphia; S. Meyer, Los Angeles; David Stone, Chicago; I. N. Hahn, St. Louis; B. J. Hirsch, San Francisco; W. A. Kaufmann, Chicago; E. M. and L. Stern, Philadelphia; I. D. Waxman, Chicago; Harry Morris, Chicago; S. Schweizer, Philadelphia; F. M. Solomon, Chicago; H. W. Arnstine, B. V. Arnstine, Cleveland; Joseph Cooper, Baltimore; Alfred Eaves, Montreal; Oscar Kind and L. Block, Philadelphia.

## Lancaster, Pa.

T. Wilson Dubbs spent a few days last week in New York.

Alfred W. Moyer, of the Non-Retailing Co., visited New York last week.

Two gold watches were stolen, last week, from a show case at Harry Sobel's store.

The father of Henry T. Kiehl, head salesman for Louis Weber & Son, died last week.

Paul Browngaert, a San Francisco watchmaker, reached Lancaster, last Wednesday, penniless, and was assisted in getting on to New York, his destination.

Among the few jewelers visiting here last week were H. L. Oberlin, Oberlin Bros., Columbia; W. J. Frazer, Lincoln; David Frymier, Groff's Store; S. H. Miller, Mt. Joy; G. R. Peterman, Scranton.

Children playing with matches started a blaze, a few days ago, in the handsome Foltz building, on E. Chestnut St., in which are located the Ezra F. Bowman Technical School and Ezra F. Bowman's Sons. An early discovery of the fire saved the building from destruction.

At a meeting held May 16 by the Non-Retailing Co. the following board of directors was elected: A. F. Hostetter, John W. Eshleman, S. O. Frantz, Milo B. Herr, Dr. H. E. Bowman, M. F. Neidman, Willis B. Musser, H. H. Shomo and E. E. Bruen. The board will organize before the month ends. A regular annual dividend of 6 per cent. was declared and an extra dividend of 4 per cent.

When Ray Portner, 12 years old, was arrested for complicity in several thefts, last week, it was learned that he had stolen a couple of watches, one of them a gold time-piece, which he attempted to sell to John J. Bowman, of Ezra F. Bowman's Sons. He pretended his father had sent him with the watch, but Mr. Bowman was suspicious and told him he would keep the property until his father called. He did not return, and the police were notified and took charge of the watches.

The Sweningsen Co. will, after June 1, be the firm style of the business hitherto conducted under the name of A. Sweningsen, Moorhead, Minn. The concern will do a wholesale and retail jewelry and optical business. An up-to-date lens grinding plant was recently installed in the establishment, and it is the firm's intention to make a feature of the grinding of lenses, for which work it now has every facility.

## Attleboro.

A piece of hot metal falling from a window set fire to an awning at the factory of the D. E. Makepeace Co. last week, but the flames were quickly extinguished by employes.

William C. Tappan, of the D. F. Briggs Co., last week, left for Windham Hill, Me., for rest and recuperation. He has his string of race horses there and an excellent practice track.

The night watchman in the factory of the Frank Mossberg Co. last week discovered a brisk blaze on the second floor, the cause of which has not been ascertained. He succeeded in extinguishing it with hand chemical extinguishers. It is thought to have started among some rubbish on the premises.

Wednesday, June 8, has been chosen as the date for the wedding of Clerk of Court Edwin F. Thayer, of Attleboro, to Miss Mabel Ingraham Cobb. The groom-elect is son of Oscar S. Thayer, some years ago a jewelry manufacturer in New York, and the bride-elect is ward of the late Henry Wexel, of H. Wexel & Co., Attleboro.

The James E. Blake Co.'s factory had a distinguished visitor last week in the person of John Herrshoff, the blind yacht builder of Bristol, R. I., designer and builder of international cup defenders. With his wife he was shown over the plant by J. E. Blake. His fingers, made facile by practice in his years of blindness, enabled him to grasp the designs and appreciate their beauty by touch.

Attleboro jewelry manufacturers have seen the press reports of a conference held a few days ago by a large group of jewelry jobbers representing California, Chicago and San Francisco, to take steps to prevent the eastern manufacturers from selling direct to the retail trade in their territory. They have no information beyond these press reports, and some have asked their Chicago representatives to inquire into the matter further.

The Attleboro manufacturing jewelers last week received their periodical bulletin from the Massachusetts Bureau of Statistics of Labor, "tipping" them on foreign trade opportunities. The only one of the 56 opportunities described which related exclusively to the jewelry business was this: "Catalogues of watches, jewelry, fancy goods and photographers' supplies are wanted by Senor J. M. Quevedo, Babahoyo, Province of Los Rios, Ecuador."

A little caution saved Frank W. Weaver, of F. W. Weaver & Co., from losing \$2 on a cheap swindle last week. A man entered his office to solicit advertising for an official programme of a Baptist church benefit entertainment. Mr. Weaver's questions were answered evasively, arousing his suspicion. He had taken out \$2 and given an order for a small advertisement, but decided to ask a Baptist employe about the affair. He left the office a moment for that purpose, and the solicitor fled. He had showed Mr. Weaver memoranda indicating that a number of jewelry manufacturers and others had advertised. The police, who were quickly informed, learned that the use of these names was a fraud, as they had not been visited.

**From MINES to MARKET  
SELECTED ROUGH  
SCIENTIFIC CUTTING  
SALABLE SHAPES.**

**SPECIALTIES**

MONTANA SAPPHIRES, KUNZITES, BLUE BERYLS,  
AQUAMARINES, TOURMALINES, PINK TOPAZ,  
FINE OPALS, OPAL MATRIX, PEARLS, FANCY GEMS.

**IN SHORT**

**Every Precious Stone But The Diamond.**

**AMERICAN GEM & PEARL CO.**

14-16 Church Street  
**NEW YORK**

LONDON, 16 Holborn Viaduct  
PARIS, 39 Rue de Chateaudun

**GUESSING HAS CEASED TO BE A VIRTUE.**

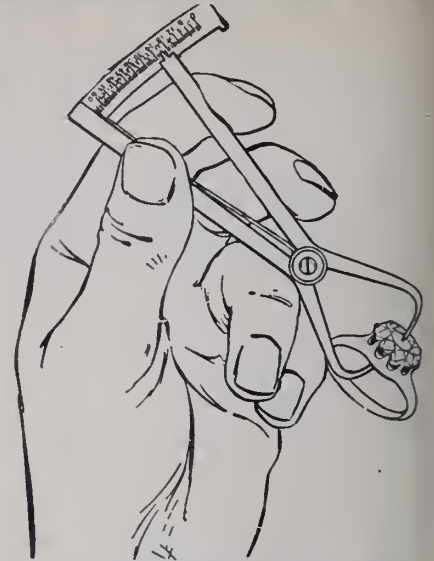

**THE MOE DIAMOND WEIGHT GAUGE**  
is the only correct system for determining the weight of mounted diamonds.  
INDORSED BY THE LEADING JEWELERS.  
Those who are not familiar with the device, kindly send for descriptive booklet.

**Charles Moe, Inventor, 80 Adams St.,  
CHICAGO, U. S. A.**

Price for Instrument and Book, **\$3.75** prepaid.  
May also order from the following agents:  
D. C. PERCIVAL & CO., Boston; CROSS & BEGUELIN and R. L. & M. FRIEDLANDER, New York; M. SICKLES & SONS, Philadelphia; NORDMAN BROS., San Francisco; E. & J. SWIGART, Cincinnati; LEONARD KROWER, New Orleans.  
BACKES & STRAUSS, Sole Agents for Europe and India, London, E. C., 14-17 Holborn Viaduct.

**SOHN and HYMAN**  
IMPORTERS OF PRECIOUS AND IMITATION STONES  
Crystals Engraved and Painted from Photo. Crests and Coats of Arms Engraved. Stone Seal Engravers and Incrusters. Lapidary Work a Specialty.  
**JOBGING STONES A SPECIALTY**  
47 and 49 Maiden Lane, **NEW YORK**

**JACOB BASCHKOPF,**  
**DIAMONDSETTER,**  
LETTER AND MONOGRAM  
**ENGRAVER,**  
9-13 MAIDEN LANE,  
**NEW YORK.**  
Room 701  
Jewelers' Bldg.

**TRADE-MARKS** OF THE JEWELRY AND-KINDRED TRADES.  
Over 4,000 Marks. Second Edition. Price, \$3.00.  
The Jewelers' Circular Pub. Co., 11 John St., N. Y.

**Trade-Marks** of the Jewelry and Kindred Trades.  
Second Edition. Price, \$3.00. The Jewelers' Circular Publishing Co., 11 John St., New York.

**QUALITY COUNTS**

The Increasing Sale of **TAVANNES WATCHES**

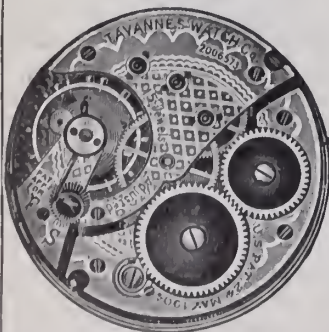

Proves their worth as timekeepers

**FULLY GUARANTEED**  
For sale through the jobbing trade



**TAVANNES WATCH CO.,**  
2 & 4 Maiden Lane, **New York.**

## Philadelphia.

### TRADE CONDITIONS.

The settlement of the threatened coal strike has already made a perceptible improvement in the trade in this city and nearby towns. Up-State retailers are buying freely of local wholesalers and are among the regular visitors to the trade. A prominent jobber said that if the strike had occurred business in the coal regions would have been practically stopped and that there would have been serious trouble. He says that a number of retailers in mining towns had declared their intention to suspend business entirely in such an event and to have removed to other sections.

L. Spocrhase, 4078 Lancaster Ave., is reported to have sailed for Europe on a pleasure trip.

J. Warner Hutchins and family will open their cottage in Chelsea for the Summer next week.

Clement Weaver, of the Bailey, Banks & Biddle Co., sailed on the *St. Paul* for Europe last week.

L. P. White, 7th and Chestnut Sts., has completely recovered from his recent illness, and resumed his business activity.

Abe Sickles, of M. Sickles & Sons, is expected back from Europe next week. He is reported to have sailed for New York.

E. S. Gehman, Bally, Pa., accompanied by Mrs. Gehman, spent last week visiting relatives and friends in this city and Wilmington.

Thomas Moore, for many years with H. O. Hurlburt & Sons, but who recently retired, has taken a cottage at Atlantic City for the Summer.

I. Bedichimer & Co., 1022 Chestnut St., was awarded the contract last week for medals to be furnished to the Patriotic Order Sons of America.

William Latham, watchmaker, resigned his position, last week, with H. N. Allebach, 120 N. 7th St., to go with M. Sickles & Sons in their material department.

George S. Rublack, a jobbing jeweler, 4246 Westminster Ave., was married last week to Miss Irene Bechtel. Many members of the trade attended the ceremony.

J. E. Caldwell & Co. was given the contract last week for the prize cups and medals to be awarded at the invitation golf tournament of the Huntingdon Valley Country Club.

The firm known as "Marceau," trading in cheap jewelry and imitation diamonds at 928 Chestnut St., finally went out of business in this city, last week, after a career of two years.

J. B. Bechtel, of J. B. Bechtel & Co., is this week down east buying stock. William E. Ross, of the same firm, is traveling in New York, and Andrew Little has departed for a southern trip.

Samuel Mellin, 1903 South St., has put a handsome new bulk window entirely of glass in his store, which has now been made one of the most elaborate jewelry stores in that section of the city.

A. L. Smith will remove from 1711 South St. to his new store on Baltimore Ave., West Philadelphia, June 15, by which time the fixtures will have been completed and extensive alterations made.

Watchmakers in this city learned with regret last week of the death of Fritz Englehart, watchmaker for Julius Kling, 501 Girard Ave. Mr. Englehart was widely known throughout this city's trade. He was

an old-time jobbing jeweler and badge maker.

D. Atlas, of Atlas & Fisher, 7th and Sansom Sts., has returned from a trip to Boston and New York. Mr. Atlas will soon start on a European trip of five or six weeks, sailing for Antwerp about June 9.

The employes of H. O. Hurlburt & Sons have organized a baseball team, which proposes to play games during the Summer with the teams of other wholesale houses in the trade. The project has the indorsement generally of employers in the wholesale district.

Louis Markert, a hotel proprietor, 8th and Sansom Sts., took a party of jewelers from the wholesale district to his country place at Doylestown for an outing last week. In the party were Emil Bracher, Charles Gabler, Thomas Moore, Charles Norman, Emil Zothe and Jules Graff.

Out-of-town retailers visiting the trade in this city during the week included: Joseph Gerz, Minersville, Pa.; H. S. Kratz, Souder-ton, Pa.; George Bowen, Bridgeton, N. J.; D. H. Krause, North Wales, Pa.; William Rudisill, of Rudisill Bros., Altoona, Pa.; M. R. Lummis, Salem, N. J.; A. M. Yeakel, Perkasio, and M. K. Laudenslager, Souder-ton.

William Ungerer, a retired retail jeweler, who for years was engaged in business on Germantown Ave. until he gave it up two years ago, died last week of Bright's disease at his home on N. Broad St., in Branchtown. He was formerly well known in this city, and enjoyed the confidence and respect of all those in the wholesale jewelry trade with whom he had dealt.

## Pittsburg.

J. Loughrey Roberts, of the J. M. Roberts & Sons Co., who has been seriously ill, left, last week, for Atlantic City, in the hope of improving his health.

Jacob Bobbs, Mount Pleasant, Pa., formerly in business at Scottdale, may lose his eyesight. He was in Pittsburg last week consulting physicians, who gave him little encouragement. Mr. Bobbs is a watchmaker and is well known in this city.

The board of trustees of the Carnegie hero fund met last week and awarded a number of silver and bronze medals. The makers of medals have an excellent opportunity to do business with the hero commission, which has headquarters in the Carnegie building, this city.

Pittsburg storekeepers are preparing to observe the Summer closing hour and, beginning June 15, the jewelry stores will close at 5 p. m., except Saturdays, when a number will close at 1 p. m. Many have considered the advisability of closing at 5 o'clock all the year round.

The annual convale of the Knights Templars of Pennsylvania is being held in Pittsburg this week, the big parade taking place yesterday. A number of the jewelry stores were handsomely decorated in honor of the event and a large number of out of town jewelers, members of the fraternity, were among the visitors.

The trade extension excursion of the Merchants and Manufacturers' Association to northeast Ohio will be made beginning June 5, when the principal cities and towns

will be covered. About 100 houses will be represented on the tour, including some of the wholesale jewelry establishments. The party will travel by special train.

H. S. Johnston, Apollo, Pa., who more than a month ago started for San Francisco, only got as far as Illinois with his family, when his children became ill and he was compelled to abandon his trip. At last accounts he was still in Illinois. But for his children's illness he would have been in the Golden Gate city at the time of the earthquake.

Among the out of town buyers in Pittsburg last week were the following: L. L. Swan, New Castle; J. F. Zugschwert, Carnegie; B. E. Brown, St. Marys; J. Linnenbrink, Rochester; J. F. Murphy, Dawson; R. W. Brady, Washington; C. A. Hines, Vandergrift; Abe Teplitz, McKeesport; Mr. Brown, Monessen; Mr. Fisher, Greensburg; Henry A. Reineman, McKeesport; Mr. Kennerdell, Tarentum; R. H. Wolf, Smith-ton; J. Wolf, Monessen; W. B. Kegg, Glassport; A. C. Hoehl, Pitcairn.

Some complaint is being made by local jewelers against the express companies for the careless manner in which goods are handled. The Geo. B. Barrett Co. last week shipped a diamond sunburst to New York and the consignee wrote that it had been delivered by a boy who was employed by the Adams Express Co., who, when told to take the package upstairs where the receiver would sign for it, retorted that such action was only a formality. The sunburst, fortunately, fell into the proper hands.

The John M. Roberts & Son Co. has released its present quarters in Market St. for a period of five years at an advance in rent of almost 50 per cent. It had been reported some time ago that the entire block was to be sold. J. R. Reed & Co.'s store and J. C. Grogan & Co. are located on either side of the Roberts house. Mr. Roberts' action in re-leasing, precludes any possibility of selling the block, at least for some time to come. This is one of the busiest sections in the city and the jewelry stores in this block are among the best in Pittsburg.

## Rochester.

Henry Solonsky, of this city, has had his name legally changed to Henry Sloan.

Two actions in replevin against Max Weisbuch and Philip Levenson were commenced Thursday in the Municipal Court here as a result of the arrest of Mrs. Margaret Green on a charge by Nolan & McLaughlin, instalment jewelers, that she had stolen jewelry valued at several hundred dollars. Mrs. Green is now in jail, and it is claimed that she disposed of the stolen jewelry to the defendants in the replevin suit. The defendants claim that Mrs. Green was an authorized agent of the plaintiffs and that they had made partial payment for the jewelry sold by her to them, which the firm is now seeking to recover. The articles include three gold chains, four diamond rings, a gold watch, a gold cross, a filled watch, including in all about \$235.

David Shannon, of Shannon Bros., Altoona, Pa., sustained a fracture of the left leg about a week ago, in a runaway accident. He was taken to his home at 100 Washington Ave.

WATCHESDIAMONDS**AT WHOLESALE ONLY**

**W**E DO NOT *RETAIL*, which means that we protect the *Retail Trade* by *Positively Refusing* to sell any goods other than at *Wholesale*. Any *Jobber* who *Retails* becomes a competitor of the *Retailer*.

*Are you buying your Watches, Diamonds, Jewelry, Cut Glass and Silverware from a competitor of yourself? We are not your competitor and we solicit your trade.*

**D. C. PERCIVAL & CO., Inc.,**  
373 WASHINGTON ST., BOSTON, MASS.

IMPORTERS OF DIAMONDS.

Manufacturers and Jobbers only of Watches, Jewelry, Silverware,  
Cut Glass and a complete material department.

JEWELRYCUT GLASSSILVERWARE

Supremacy  
of the  
"Egyptian"  
Pearls.

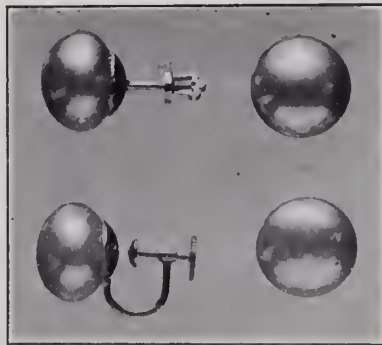

Ear Drops,  
Scarf Pins,  
Rings,  
Studs, etc.

**T**HE IRIDESCENCE, perfection of color, and natural weight of "EGYPTIAN" Pearls render them superior to all other artificial pearls. The illustration shows some of our Ear Drops, with attachments for either pierced or unpierced ears. Pearls are shaped round for mounting in point settings, and flat top or button shape for invisible cup settings. The mountings are in 10 and 14 karat gold.

**GEORGE H. CAHOONE COMPANY,**

Makers of Artistic Jewelry,

PROVIDENCE—7 Beverly Street.

NEW YORK—9 Maiden Lane.

**Boston Jewelry  
Manufacturing Co.****The Mounting and  
Repairing House  
of New England.**

We eclipse all others in design, quality, promptness and finish of work.

A line of entirely new styles in mountings always on hand.

**Jewelers' Building,  
BOSTON, MASS.**

**Jewelers Having Tortoise  
Shell Goods**

that have become dull or broken, can have them repaired, repolished and made as bright as new, at a small expense, by sending them to the manufacturer.

**POTTER SHELL WORKS, Providence, R. I.**

## Connecticut.

L. A. Martinez, Ansonia, has opened a branch of his repairing business in Seymour.

A new elevator is being installed in the factory of the Wm. L. Gilbert Clock Co., Winsted.

R. M. Mansfield, Wallingford, who has been confined to his home for several days, is rapidly improving.

Factory "H," International Silver Co., Meriden, is now being operated four nights a week until 8 o'clock.

Nathan Farrell and Miss M. Burte, both in the employ of the New England Watch Co., Waterbury, were recently united in marriage.

H. H. Swartfinger, Rockville, was a visitor to Boston, Mass., last week, where he attended the convention of the New England Association of Opticians.

The senior class of the Norwich Academy, Norwich, is making arrangements to present a clock to the school. The timepiece will be placed in the lower hall.

Harry Hartwell, Watertown, is the owner of an old timepiece with wooden works. The frame is believed to have been made about the year 1830, at Bristol, by P. Barnes & Co.

W. E. Sessions, of the Sessions Foundry Co., Bristol, attended the banquet of the National Manufacturers' Association, at the Waldorf-Astoria, in New York, last Wednesday.

The Bradley & Hubbard Mfg. Co. is rebuilding the portion of its factory which was recently damaged by fire. The building is 40 by 160 feet, and will be raised an additional story. A new roof will also be put on.

The officials of the New Haven Clock Co., New Haven, filled the places of the adjusters who discontinued work last week because their request for an increase in wages was refused by transferring men from other departments.

Samuel Dodd, Meriden, together with a party of friends and ex-Governor Chamberlain, left Tuesday, of last week, for the annual pilgrimage to the Metabetchuan Club, in Kiskisino, Quebec. George H. Wilcox is steward of the club.

Dr. Robinson, a surgeon of Stamford, is the owner of a clock which has ticked continually for five years without ever running down, until it was stopped on the day of the seismic disturbances in San Francisco. The physician believes the earthquake was the cause of the sudden stoppage.

Daniel M. Davis, who for over a quarter of a century had been associated with the Waterbury Brass Co., Waterbury, where for several years he had been engaged as paymaster, died Wednesday afternoon in the Waterbury Hospital, aged 51 years. Mr. Davis is survived by a widow, one daughter and two sons.

Geo. M. Curtis, treasurer of the International Silver Co., is president of the general committee for Meriden's big centennial celebration, to be held next month. Other members of the committee are: Geo. F. Monroe, president of the C. F. Monroe Co.; C. P. Bradley, director of the Bradley & Hubbard Mfg. Co. C. F. Monroe is chairman of the Manufacturing Exhibit's Committee, and Geo. M. Curtis is chairman of

the Committee on Historical Addresses and Events.

Julian R. Holley, vice-president and general manager of the Bristol Brass Co., Bristol, was surprised Wednesday night by a delegation of eight of the prominent employes of the company, who called at his home on Bellevue Ave. and presented to him a handsome loving cup. The delegation was headed by Assistant Treasurer Samuel B. Harper, who, after Mr. Holley had been greeted by the members of the party, proceeded to present, in a brief speech, the handsome tribute from the employes of the company to their chief.

## New Orleans, La.

Gabe Hausmann will leave, early in July, for New York. He will make the trip by steamer, and while in the north will combine business and pleasure.

T. Hausmann & Sons' factory made the badges for the Lake Charles Bankers' Convention, and also the badges for the United Commercial Travelers' Association, which is holding a convention in Vicksburg, Miss.

Simon Levy, formerly well known in the local trade as an associate of his father, who dealt in diamonds, watches and jewelry and who later made quite a reputation for himself as a detective, was, a few days ago, dismissed from the force for having failed to make a gambling raid.

Paul Pilat, a local jeweler, who for the past 20 years was a resident of this city, died recently at his residence, 1019 Dauphine St. Mr. Pilat came to this city from Austin as a boy, and at an early age established a jewelry business. The deceased was 31 years of age, and is survived by his parents.

## Boston.

J. Newman has moved his jewelry store from 754 Washington St. to 304 Bowdoin St., Dorchester district.

The American Watch Co. Band will give concerts every Saturday night from June 2 until Sept. 1, both inclusive, at Riverside, Mass., on the Charles River, and every Sunday afternoon from June 3 to Sept. 2, both inclusive, on Fox Island in Waltham, Mass. These concerts are part of the entertainments planned in connection with canoeing on the Charles River, this Summer.

The following jewelers and opticians were in Boston during the week: Mr. McLoughlin, of the Watch & Jewelry Co., Yarmouth, N. S.; A. C. Lord, Tilton, N. H.; C. P. Forbes, Greenfield; H. S. Hewitt, Brockton; E. A. Hewitt, Bridgewater; F. R. Vaughan, of Vaughan & Burnett, Brattleboro, Vt.; J. R. Philbrick, Skowhegan, Me.; the junior member of W. F. Parker & Son, Fair Haven, Vt.

At a special meeting of the Rochester Optical Society, recently, Dr. R. R. Williams delivered the last of a series of lectures on the anatomy of the nervous system. After the lecture the society presented the Doctor with a very fine Bausch & Lomb microscope, as an acknowledgment of the society's appreciation of his efforts.

## Canada Notes.

C. K. Hamilton, Qu'Appelle, Sask., is dead.

C. O. Demareuz, Fernie, B. C., has discontinued business.

D. Myles, Haileyburg, Ont., has taken a partner, and the style of the firm is now D. Myles & Co.

Mrs. Sarah A. Wallace, London, Ont., has sold her jewelry business to W. Y. Young, of that city.

J. A. McEwen and C. Maynard, of the staff of Ryrie Bros. Ltd., Toronto, Ont., have returned from a purchasing trip to Europe.

Harris Michalson, of the firm of I. L. Michalson & Sons, Ltd., Montreal, Can., sailed for Europe, May 19, on his semi-annual business trip.

Mr. Chillias, Jr., son of George Chillias, representative of the Gorham Mfg. Co., Montreal, will cover the ground from Toronto westward to British Columbia for the company.

Out-of-town buyers calling on the Toronto, Ont., trade last week, included: Alexander Moffatt, Brantford, Ont.; A. Gibson, Peterboro, Ont., and D. Taylor, Owen Sound, Ont.

A daring jewelry robbery was perpetrated in daylight at the store of Henry Birks & Sons, 350 Main St., Winnipeg, Man., on the afternoon of Monday, May 14, by a man who smashed the window with a brick and seized a tray of diamond rings. He had skeleton keys in his possession with which he locked the store doors, preventing any immediate pursuit by the staff. He then dashed through the Bank of Montreal, next door, fastening the doors behind him, and so eluded capture. In his haste to escape, however, he dropped 15 out of the 18 rings which the tray contained, which were recovered. The three with which he got away are valued at \$1,250.

Thomas R. Binkley, of Klein & Binkley, Hamilton, Ont., has identified Frank Kelly and Mary Hennessey, now under arrest at Binghamton, N. Y., on a charge of diamond stealing as the couple who stole a \$250 diamond ring from his store in February last. He went to Binghamton for the purpose, and had no difficulty in picking them out from among the 50 prisoners confined in the jail there. An effort will be made to secure the extradition of the prisoners to Canada. There are numerous other charges against them in the United States. As it is said that they have frequently been arrested, but have always escaped by jumping their bail, the Binghamton police are inclined to allow their extradition.

The death is reported of Henry J. Collier, Shreve, O.

In the show window of John F. Giering, Mazareth, Pa., was recently displayed the silver trophy which will be awarded as a prize on the day of the Firemen's parade, at that place.

Adolph Roth, a watchmaker and jeweler, employed at Geo. E. Wilkins' store, Syracuse, N. Y., went to Binghamton last week to look at Mary Hennessey and Frank Kelley, under arrest there, to see if he could identify them as participants in the robbery of \$500 worth of jewelry from Mr. Wilkins' store a month ago.

# GORHAM SILVER POLISH

## THE SAFEST AND THE BEST

¶ Every Jeweler finds himself constantly appealed to by his customers for advice as to the best manner in which they may keep their household silver-ware in good order.

¶ The well-informed Jeweler has but one recommendation to make—the use, namely, of Gorham Silver Polish, which many years of sedulous experiment have succeeded in making the best and safest preparation in the world for the purpose indicated.

¶ The Gorham Mfg. Co., therefore, take the opportunity of reminding the trade in general that Gorham Silver Polish is supplied by them in the form of convenient cakes only.

¶ At the same time for those who desire it, the familiar Gorham Silver Powder is still supplied.

¶ The use of either of these preparations cannot be too highly recommended.

## GORHAM M'F'G CO.



CHICAGO,  
137 Wabash Ave.

Silversmiths and Goldsmiths

Fifth Avenue and 36th Street, New York.

BRANCHES:

NEW YORK,  
23 Maiden Lane.

SAN FRANCISCO,  
120 Sutter St.



LONDON,  
Ely Place.

WORKS: Providence and New York.

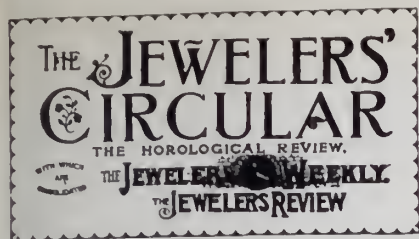

PUBLISHED EVERY WEDNESDAY BY  
**THE JEWELERS' CIRCULAR PUB'G CO.**  
 11 JOHN ST. COR. BROADWAY, NEW YORK.  
 TELEPHONE: 1148 CORTLANDT.  
 CABLE ADDRESS: JEWELAR NEW YORK

VOL. LII. MAY 23, 1906. No. 16.

Subscription in U. S., Canada and Mexico, \$2.00  
 Other Countries in Postal Union, . . . \$5.00  
 Single Copies, . . . . .10  
 Remit by check or money order. Remittances in money are at sender's risk.

Notices of changes in standing advertisements must be received one week in advance; new matter can be received up to Monday.

No attention paid to communications unless accompanied by full name and address of the writer. This is asked not necessarily for publication, but as an evidence of good faith.

**Index to Special Articles.**

	Page.
Wedding Presents of the German Crown Prince and His Bride Exhibited for Charity. Illustrated on the front cover, text on page	33
Second Quarterly Sale of Ivory at Antwerp...	33
Elsie Bee's Fashions.....	34
Jewelry, Clocks, Watches, etc., Exported from New York .....	35
Watches and Jewelry Stolen from J. A. Bills.	35
Utica Optical Society's Annual Meeting.....	35
Virginia Optical Association Starts a Jewelers' Section .....	35
Annual Meeting Granite State Optical Association .....	35
Kasel Salzman Sent to the Penitentiary.....	37
Death of Solomon Spring.....	37
Patent Commissioner's Decision as to Trade-Mark on Watch Cases .....	37
Clocks and Watches Imported by Chile.....	37
Imports of Jewelry, etc., at New York.....	37
Robinson's Suit vs. Gorham Mfg. Co. Argued in United States Circuit Court.....	39
Stockholders of American Waltham Watch Co. Ratify Transfer to Waltham Watch Co.....	39
Death of Louis J. Lamb.....	41
Wisconsin Retailers from State Association...	41
Death of Abraham Bitner.....	41
Schedules of Schickerling Bros. & Co.....	41
San Francisco Jewelers Making Progress—Association Formed to Help Unemployed....	43, 44
Foreman of Tiffany & Co. Guilty of Larceny..	45
Thief Who Robbed L. C. Reisner Pleads Guilty .....	45
The Diamond Markets .....	47
American Horological Hears Interesting Lecture .....	63
Patent Department .....	72
Buyers' Information Bureau.....	75
The Big Clocks That Give Time to New Yorkers in Manhattan, Brooklyn and the Bronx—Brooklyn's Conspicuous Clocks...	77
Do Heart Throbs Affect Rate of a Watch?...	83
Two New Regulating Machines.....	85
Competition Between American and German Clocks and Watches in Peru.....	85
Full Report of the 12th Annual Convention of the New England Association of Opticians, Held at Boston, May 15-16.....	90, 93
The Modus Operandi in Eyesight Testing....	93
A New Bifocal Lens Grinder.....	93
The Handsome Store of Gillespie Bros., Pittsburgh, Pa. ....	96
Coloring Incandescent Globes.....	97
Novel "Wink" Light Effects.....	97
What Some Jewelers Say.....	97
A Hint from Subscriber on Alloying Gold....	99
The Enameling of Jewelry—(Continued)....	99
Porcelain Room in a Spanish Palace.....	101
Reappraisements of Decorated China, etc....	101
Auction Room Prices for Old China and Glass.	101

ONE of the most important optical conventions that has ever been held in this country was that of the New England Association of Opticians, last week, of which a full report will be found in the Optical Department of this issue. Not only in the importance of the matters discussed and the number of interesting papers read does this convention establish a new record in the optical trade, but in the question of attendance alone, and the number and completeness of the exhibits, it far surpassed all other similar gatherings, even those of the American Association of Opticians, which is a national body with members from all sections of the country. This convention will undoubtedly spur those in charge of the next annual gathering of the American Association of Opticians, which takes place in Rochester, Aug. 3 and 4, to renewed effort, and therefore its good effect upon the optical trade will continue long after the association becomes but a memory to the many who attended.

**British Watch Industry Suffers from American Competition.**

THE recent prominence given to the American watch industry, which has brought to light the figures showing its great development in recent years, caused more than ordinary interest to be attached to the information sent by Consul General Wynne, at London, Eng., to the Department of Commerce and Labor, concerning the great decline in the manufacture of watches in Great Britain. Mr Wynne sends a clipping from the *London Daily Telegraph* on the subject, which says, in part, as follows:

Among English industries which have suffered severely from foreign competition that of watch-making occupies a prominent place. The cheap trade, of which Clerkenwell used to be the flourishing headquarters, has practically gone. It has been captured outright by the enterprising foreigner, and though Clerkenwell road and its purlieus are still the great market center for everything connected with clocks and watches, scarcely a single watch factory survives there. We give some remarkable figures bearing on the influx of foreign watches:

**OFFICIAL RETURNS SHOWING THE NUMBER OF WATCHES MADE AT HOME AND ABROAD IN THE LAST FOUR DECADES.**

Year.	Continental.	American.	English.
1862.....	2,500,000	50,000	164,000
1872.....	3,000,000	400,000	145,000
1882.....	3,500,000	1,250,000	227,000
1892.....	4,500,000	2,250,000	204,000
1902.....	6,000,000	2,750,000	226,000

In 1904 more than 1,500,000 watches were imported into the United Kingdom from foreign countries, representing the sum of £838,000. This means an average of more than 10 shillings for each watch, and considering the flood of common watches of foreign origin that can be bought for much less than that sum, it is evident that a large proportion of those imported cannot be classed as inferior goods. Switzerland led with 1,100,000 watches; Germany was the next, with 213,000; France was third, with 80,000, and America fourth, with 64,000. Besides this, almost as many clocks as watches entered our ports; Germany in this instance leading the way with 1,000,000, and the United States being second with 250,000.

The effect of the better American watch on the English market has been to make people disinclined to pay more than \$20 or \$30 for a watch for everyday use.

In this connection the recent remarks credited to T. P. Hewitt, managing director of the Lancashire Watch Co., appear significant. In an article in the *Magazine of Commerce* Mr. Hewitt recently drew attention to the great advantages derived by the watch industry in the United States from its

Tariff Law and declared that the watch trade of Great Britain was being gradually transferred to this country. Forty years ago the best known devices in the modern watch were invented by English makers, and at that time, as noted above, but 50,000 watches were made in the United States and 164,000 in Great Britain. In the course of the 40 years the whole situation is reversed, and the American watch is rapidly superseding the English, and, to a great extent, the Swiss of certain lines.

Mr. Hewitt attributes the decay of the watchmaking industry in England to what he calls the "obsolescent assay laws" of Great Britain, and the strict enforcement of them, as well as of tariff conditions. He seems to feel that the English makers, with the open door policy, are at the mercy of the American manufacturers, as they cannot retaliate in the tariff fight.

Whatever be the reason, whether tariff conditions or assay laws, there is no doubt that the progress to the American watch industry and the decline in the English has been one of such steady and increasing development as to cause much concern to our friends across the water, and there is little doubt if the Jewelry Trades Gold Stamping Bill becomes a law, as now seems extremely likely, that our watch cases, as well as jewelry, will obtain a standing among Europeans that they have not at the present time, and that this will surely aid greatly in the development of the trade in complete watches, which may give our British friends even more cause for worry than they have at present.

**Bill Passes the Senate.**

**National Gold and Silver Stamping Law Needs Only the President's Approval.**

As THE CIRCULAR-WEEKLY goes to press word comes from Washington to the effect that the Jewelry Trades' Gold and Silver Stamping Bill, introduced by Congressman Vreeland, has passed the Senate of the United States, and now simply awaits the signature of President Roosevelt before becoming a law. Although no details have as yet been received, it appears that the bill has been approved in the form which it was recommended by the Interstate Commerce Committee of the Senate, which leaves the act practically as it was introduced by Mr. Vreeland with the exception of a reduction in the penalty to three months' imprisonment, or \$500 fine; and an extension of the time in which the bill is to go into effect to one year after its passage.

The progress that this measure has made and the rapidity with which it was considered and acted upon by both the House of Representatives and the Senate is most unusual, and shows that the merits of the measure and the absolute necessity of its adoption for the protection of the jewelry trade and public at large was universally recognized by our legislators of the National Congress.

The whole history of the bill speaks well for the standard of commercial morality of the jewelry trade, and shows that in a fight such as this for honest business methods, our national legislators are willing to cooperate and give every aid to a movement of this kind inaugurated by business men.

# FIRST HANDS



## CROSS & BEGUELIN

Importers and Cutters of Diamonds and Precious Stones

43 Rue de Meslay, PARIS

Telephone, 2188 Corilandt

17 Maiden Lane, NEW YORK

### ARCH CROWN MOUNTINGS IMPROVE DIAMONDS



NOTE CONCAVE TIP

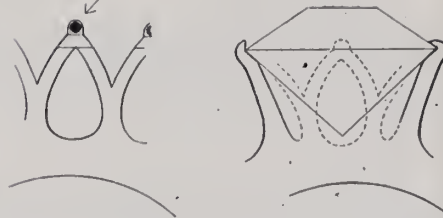

### COMPLETED BEARING ARCH CROWN MOUNTINGS INSURE PERFECT SETTING

All Arch Crown Mountings are now furnished with Complete Bearings, the success of which was instantaneous; unsolicited testimonials coming to us daily attesting to its worth. This important improvement in diamond mountings has overcome many vexations owing to inferior stone setting. A perfect result is certain, since bearings and tips are fully prepared in advance and a close contact with the stone must follow.

Samples cheerfully sent on approval, a trial invariably proves convincing.

#### ARCH CROWN MFG. CO. 26 CAMP ST. NEWARK, N. J.

Cross & Beguelin, New York.  
Kossmith Marx Jewelry Co., New York.  
Schrader Wittstein Co., Chicago.

Eisenstadt Mfg. Co., St. Louis.  
M. Schussler & Co., San Francisco.  
Leonard Krower, New Orleans.

Jos. Notermann & Co., Cincinnati.

### Last Week's New York Arrivals.

THE CIRCULAR-WEEKLY each day posts in its office a Bulletin of the latest buyers visiting New York, which every member of the trade is cordially invited to copy.

- ALBANY, N. Y., M. R. Eliassof (Eliassof Bros. & Co.), Normandie.
- ALTOONA, PA., L. Lippman, Normandie.
- BALTIMORE, MD., W. W. Frederick (Stewart & Co.), Navarre.
- BOSTON, MASS., J. B. Humphrey (J. B. Humphrey Co.), Astor.
- CARBONDALE, PA., F. E. Burr (W. Burr's Son), Gerard.
- CHATTANOOGA, TENN., W. F. Fischer (W. F. Fischer & Bro.), Imperial.
- CHICAGO, M. M. Joseph, Grand.  
R. A. Kittle, Holland.
- CINCINNATI, O., I. N. Fox (Fox Bros. & Co.), Imperial.  
A. Jacobs (D. Jacobs & Co.), Grand.  
J. D. Jacobs (D. Jacobs & Co.), Grand.
- CLEVELAND, O., L. M. Sigler (Sigler Bros. & Co.), Astor House.
- DALLAS, TEX., B. Linz (Jos. Linz & Bros.), Breslin.
- DAYTON, O., W. P. Kiser, Imperial.
- ELIZABETH CITY, N. C., B. R. Bright (Kight & Bright), Astor.
- GRAND RAPIDS, MICH., P. J. Koke, Breslin.
- HARRISBURG, PA., W. M. Worcester (Dives, Pomeroy & Stewart), 2 Walker St.
- KANSAS CITY, MO., N. R. Fuller (Edwards & Sloane Jewelry Co.), Breslin.
- LANCASTER, PA., T. W. Dubbs, Herald Sq.
- LONDON, ONT., F. T. Trebilcock, York.
- MT. CLEMENS, MICH., G. Chambers (Chambers & Stewart Co.), Grand.  
R. J. Chambers (Chambers & Stewart Co.), Grand.
- NORWICH, CONN., F. J. Stanley (Porteous & Mitchell), New Amsterdam.
- PITTSBURG, PA., C. F. Braxmier (Sebneider & Braxmier), Imperial.
- PROVIDENCE, R. I., A. J. Ferguson (Callender, McAuslan & Troup Co.), Herald Sq.
- RICHFIELD SPRINGS, N. Y., C. E. Caney, Earlington.
- RICHMOND, IND., B. C. Bartel (A. H. Bartel Co.), Woodstock.
- SAN FRANCISCO, CAL., H. Jehlinger (The Emporium), Grenoble.
- SCRANTON, PA., S. V. E. Bippus (J. Long's Sons), Woodstock.  
A. B. Cohen, Broadway Central.
- SPRINGFIELD, MASS., H. B. Davison (H. J. Davison's Son), Astor.
- TROY, N. Y., A. S. Osborn (W. H. Frear & Co.), York.
- UNION CITY, IND., A. Reitnour (I. N. Reitnour), Herald Sq.
- WASHINGTON, D. C., H. C. Karr (Jacob Karr's Sons), St. Denis.
- WILKES-BARRE, PA., W. F. Newberry (F. M. Kirby Co.), Imperial.

### Jewelers Gold Bars Withdrawn and Exchanged at New York.

Week Ended May 19, 1906.

The U. S. Assay Office reports:  
Gold bars exchanged for gold coin....\$413,494.92  
Gold bars paid depositors..... 94,837.75

Total .....	\$508,332.67
Of this the gold bars exchanged for gold coin are reported as follows:	
May 14.....	\$61,887.81
" 15.....	51,259.81
" 16.....	57,320.17
" 17.....	148,819.21
" 18.....	56,346.98
" 19.....	37,860.04
Total .....	\$413,494.92



## New York Notes.

D. & A. Brinker, jobbers, have opened an office in the Myers Building, 49 Maiden Lane.

W. L. Bunnell last week filed a judgment for \$906 against the American Watchman's Time Detector Co.

F. P. Abbott, of Porcelaines G D A, who has been in Europe for several weeks, is expected back next month.

Having been burned out at 1612 Madison Ave., Samuel Lubow has opened convenient quarters next door at 1610.

J. B. Hudson, of J. B. Hudson & Son, Minneapolis, Minn., has been calling on the trade in New York in the last week.

A judgment for \$30 was filed last week against the American Watchmen's Time Detector Co. and in favor of G. W. Varian.

A. Ludwig and E. Ludwig, of A Ludwig & Son, 75 Nassau St., sailed Saturday on the *Graf Waldersee*, to be gone three months on a pleasure and business trip.

R. Reinhart, 47 Maiden Lane, returned last week on the *Kaiser Wilhelm II.* from an extensive trip to Egypt and the Continent.

Emil Lewy, of Lewy & Cohen, importers at 530 Broadway, will sail Saturday on the *Finland*, intending to make a trip to Paris, Berlin and other Continental cities in search of novelties.

Diamonds and tobacco are a combination that are not to be carried much longer by Durlach Bros., 171 Front St., as they now announce that they will soon retire from the gem business.

A twelve-story office and loft building costing about \$350,000 is to be built on the northwest corner of John and Dutch Sts., on a plot 75 x 113 feet now occupied by four five-story buildings.

In order to move the old clock from the tower of the stone church on Prince St. in Flushing, L. I., the local board last week voted \$200. A more prominent location for the clock is to be obtained.

Staiger & Sons last week sent out an announcement of the opening of their new offices in the Minden building, Broadway and Myrtle Ave., Brooklyn, where they will engage in the importation of diamonds and the manufacture of jewelry.

An indictment was returned, last Thursday, by the Grand Jury against August Haack, accused of grabbing a diamond valued at \$150 in the store of Abraham Koppel, 766 Third Ave., and running away with it, as related in last week's issue.

Charles L. Power, diamond merchant of 170 Broadway, accompanied by his wife, sailed for the European diamond markets on the *Columbia* last Saturday. Mr. Power will combine sight-seeing with business, and expects to return within a few weeks.

Pins for the 1906 class at the Jamaica State Normal School will be furnished by M. H. Woodhull, Patchogue, N. Y. There are 180 members in the class, and the order will amount to \$500. The pins are to be made of 14-karat gold with enamel, and set with pearls.

An announcement was some time ago placed in several papers in which C. N. Grierson, Tacoma, Wash., said that he had discovered diamonds in New Mexico, and he invited correspondence. A letter sent

to the address by a New York man was recently returned unclaimed.

In the window of Wm. Barthman, 170 Broadway, is displayed a collection of rough diamonds, varying in weight from three to 58 carats. "My latest importation from the De Beers mines at Kimberley," is Mr. Barthman's description of the precious stones, the value of which is placed at \$100,000.

Notice was received last Friday by the Jewelers Board of Trade that the Walker Jewelry Co., Bainbridge, Ga., is in the hands of a receiver. Bryant N. Walker carries on the business under the company style. He began at Bainbridge in January of last year and was formerly in business at Dublin, Ga.

Another hearing in the bankruptcy case brought against Edwin C. Heathcote, 13 Maiden Lane, will take place Thursday at 2 o'clock before Referee William Allen, at 67 Wall St. At the same time John J. Hayden, 258 Broadway, the trustee in bankruptcy, will open bids for the sale of the stock and fixtures.

Louis Mann, of Louis Mann & Co., formerly jewelry manufacturers at 51 Maiden Lane, recently called on a number of creditors and obtained settlement of their claims on a basis of 10 per cent. In the bankruptcy proceedings brought against the company, the court denied Mr. Mann's petition for a discharge from his debts.

The Hansen-Pollis Co., whose New York office is in the Flat Iron building, was incorporated last Friday under the laws of Rhode Island with \$50,000 authorized capital stock. The company, which has its factory at 100 Stewart St., Providence, R. I., will continue with increased facilities to manufacture artistic lines of jewelry and novelties.

The Lebolt baseball team played the Alexander team on May 13 for a good dinner, and the jewelers beat the shoemakers by a score of 14 to 8. The game was played on the ball grounds at College Point, and was well contested. The Lebolt team is open for engagements with any team in the jewelry business. For dates, address C. F. Barnes, at Lebolt & Co.'s store, 54 West 23d St.

At a hearing given last week by Mayor McClellan on the bill requiring auctioneers to pay an annual license of \$250, quite a number of men in the business appeared in opposition. It was argued that of the 500 auctioneers in the city, many would be unable to pay the fee. C. A. Nutting, a jewelry auctioneer, favored the bill on the ground that there are too many men in the business, and that the fee would reduce the number.

Testimony will be heard in Abraham Goldberg's bankruptcy case before Referee Wm. Allen, 67 Wall St., Thursday afternoon. A motion was made some time ago to require Goldberg, who was formerly in business on Ridge St., to turn over property to the value of \$10,000 or the equivalent in cash to the trustee in bankruptcy. This motion, made by Mervyn McKenzie, of Hastings & Gleason, in behalf of the trustee, has been opposed by Leonard Bronner as attorney for Goldberg.

All that the assets of Jacob Richter, who was formerly in business as the Richter Watch & Jewelry Co., 444 Third Ave.,

have thus far yielded to the trustee in bankruptcy, John J. Hayden, is the sum of \$48. A quantity of watches and jewelry left for repairs with Mr. Richter are to be sold at 12 o'clock Thursday by Trustee Hayden, but even with this addition it is not expected that there will be sufficient money to meet the legal expenses. Mr. Richter's schedules show that he had liabilities of \$7,647; the nominal value of his assets was \$1,840.

Litigation over a piece of real estate, the title of which is vested in Sigmund Weitzenblum, formerly of 90 Nassau St., has followed upon the bankruptcy proceedings in which he is involved. An action to foreclose a mortgage on the real estate, which is located at Castleton, S. I., was begun in April of this year by Philip Sugarman. The plaintiff names as defendant besides Mr. Weitzenblum, his wife; also the Royal Bank of New York, which has a second mortgage on the property; the Solidarity Watch Case Co., a creditor, and Alphonse Kahn, the trustee in bankruptcy of the Weitzenblum estate. Mr. Sugarman, the plaintiff, is an officer of the Royal Bank. The complaint was served by his attorney, H. S. Murphy. The mortgage was executed on Nov. 2, 1903, and calls for payment of \$3,000 to the trustees named in the will of John Henry Clief. The trustees subsequently assigned the mortgage to the plaintiff. The answer served last week in behalf of Mr. Weitzenblum by his attorney, George Malraison, sets forth that the bond and mortgage were invalidated by a usurious agreement. It is said that in 1903 Mr. Weitzenblum, desiring to pay off an old mortgage on the property, and also to raise money for use in his jewelry business, called on the Van Clief trustees to get a loan on a new mortgage. He says that besides agreeing to pay six per cent. interest he gave to the trustees \$555.85 bonus so that he actually only received \$2,444.15. Hastings & Gleason, as attorneys for the trustee in bankruptcy, have acquiesced in the defense.

Subscriptions to the Saturday and Sunday Association of New York, from the jewelry and silver trades, have recently been collected by Leopold Stern, of Stern Bros. & Co., 68 Nassau St., as follows: Stern Bros. & Co., \$50; Keller & Untermeyer Mfg. Co., \$50; L. & M. Kahn & Co., \$50; J. R. Wood & Sons, \$50; Oppenheimer Bros. & Veith, \$50; Albert Lorsch & Co., \$50; Bruhl Bros. & Henius Co., \$50; Eichberg & Co., \$25; Joseph Frankel's Sons, \$25; Arnstein Bros. & Co., \$25; Chester Billings & Son, \$25; Sussfeld, Lorsch & Co., \$25; S. L. Van Wezel, \$25; Van Antwerpen, Vanden Bosh & Co., \$25; Kastenhuber & Lehrfeld, \$25; Hayden W. Wheeler & Co., \$10; Alfred H. Smith & Co., \$10; Zimmern, Rees & Co., \$10; Jung, Staiger & Klitz, \$10; Charles F. Wood & Co., \$10; Joseph H. Fink & Co., \$10; Jacobson Bros., \$10; Leopold Rosenberger, \$10; H. Z. & H. Oppenheimer, \$10; Freudenheim Bros. & Levy, \$10; William I. Rosenfeld, \$10; J. B. Bowden & Co., \$10; Wm. S. Hedges & Co., \$10; A. Roseman, \$10; Shiman Bros. & Co., \$10; Jonas Koch, \$10; Carter, Howe & Co., \$10; Julius King Optical Co., \$10; Ingomar Goldsmith & Co., \$10; Goodfriend Bros., \$10; David Kaiser

IN THE HEART OF THE JEWELRY DISTRICT.

# Guardian Trust Company,

170 BROADWAY, COR. MAIDEN LANE, NEW YORK.

Capital and Surplus - Over \$1,000,000

Equitable rates of interest allowed on surplus funds.

Collections on out-of-town items handled on reciprocal basis.

FRANK W. WOOLWORTH, President.	LUDWIG NISSEN.
GEORGE W. FAIRCHILD, Vice-President.	LATHROP C. HAYNES, Secretary.
CHARLES L. ROBINSON, Vice-President.	ALFRED M. BARRETT, Asst. Sec'y.
	Prominent Jewelers } Among our Directors } A. K. SLOAN. LEOPOLD STERN.

# THE ORIENTAL BANK.

ESTABLISHED 1853.

182 and 184 Broadway, <sup>Corner</sup> JOHN STREET, NEW YORK.

Capital, - - - \$750,000.00.

Surplus and Profits, 1,100,000.00.

**ACCOUNTS FROM THE JEWELRY TRADE ARE SOLICITED.**

R. W. JONES, Jr., President.	LUDWIG NISSEN,	} Vice-Presidents.
NELSON G. AYRES, First Vice-President.	ERSKINE HEWITT,	
GEO. W. ADAMS, Cashier	CHARLES J. DAY.	
R. B. ESTERBROOK, Assistant Cashier.		

# The Market and Fulton National Bank of New York.

ORGANIZED 1852.

81-83 FULTON STREET.

Capital, \$1,000,000.

Surplus, \$1,335,000.

ALEXANDER GILBERT, President.  
R. A. PARKER - - Vice-President.  
T. J. STEVENS, - - - Cashier.  
JOHN H. CARR, - Asst. Cashier.

**Invites the Accounts of Jewelers.**  
Will extend every facility that good banking will justify.

**SAFE DEPOSIT VAULTS.**

# The Chatham National Bank

Broadway and John Street, New York

H. P. DOREMUS, Cashier	GEORGE M. HARD, President	W. H. STRAWN, Ass't Cashier
------------------------	---------------------------	-----------------------------

# THE STATE BANK

376-378 GRAND STREET, NEW YORK

Capital and Earned Surplus, over \$1,100,000. Deposits over Fourteen Millions.

Offers a favorable market for short and long time jewelry and diamond paper

# *The Mercantile National Bank of the City of New York*

*Cordially invites Accounts  
from Good Merchants  
in the Jewelry Trade.*

**CONDENIENT LOCATION,  
AMPLE CAPITAL,  
LARGE SURPLUS,  
LONG EXPERIENCE.**

**FREDERICK B. SCHENCK, President.**

**MILES M. O'BRIEN,** }  
**WILLIAM H. TAYLOR,** } *Vice Presidents.*

**JAMES U. LOTT, Cashier,**  
**EMIL KLEIN, Asst. Cashier,**  
**ALFRED W. DAY, Asst. Cashier.**

<b>Capital,</b>	.	.	.	<b>\$3,000,000</b>
<b>Surplus,</b>	.	.	.	<b>\$3,000,000</b>

**Broadway, Corner of Dey Street,  
New York.**

# Forceful Facts

Concentration of purchases has ever been regarded as a fundamental principle of sound business. The retail jeweler who spreads his purchases loses every advantage to be gained by concentrating his purchases on a few reputable lines. Small purchases from many lines can never benefit the buyer as large purchases from a few lines.

Particularly is this true in buying chains, and the retail jeweler who confines his purchases to Blackinton chains derives numerous advantages thereby. First and foremost he gets chains that are safe to sell: chains that have earned the distinction of "Old Reliable" because they have always lived up to the guarantee that goes with them.

All Blackinton Vest, Dickens, Waldemar, Pony and Neglige chains are now shipped with an aluminum coupon tag attached to the swivel, and the retail jeweler who buys them can have the tags redeemed in Globe Filled W. & S. B.  $\frac{1}{2}$  chains as follows: 100 tags—three chains free—75 tags—two chains—40 tags one chain, making a decided advantage to be gained by buying Blackinton chains.

Retail jewelers who use large quantities of chains have a chance to win either an Automobile, a Runabout, a Motorcycle, or a Watch Lathe: all of which we are to give away in January, 1907. Look for the Coupon Tag.

## W. & S. BLACKINTON CO.

NEW YORK:  
14 MAIDEN LANE

FACTORY:  
NORTH ATTLEBORO, MASS.



**BLACKINTON**

## New York Notes.

(Continued from page 57.)

& Co., \$5; Adolph Goldsmith & Son, \$5; Henry Froehlich & Co., \$5; Eliassof Bros. & Co., \$5; Jacob Strauss & Son, \$10; Smith & North, \$5; Heyman & Kramer, \$5; Graff, Washbourne & Dunn, \$20; Ad. Schwob, \$5; Aikin, Lambert & Co., Inc., \$5; Marchand Freres, \$10; N. H. White & Co., \$10; H. Nordlinger's Sons, \$5; L. Heller & Son, \$10; S. C. Powell & Co., \$5; Bodenheimer & Jaskow, \$5; Cross & Begnelin, \$5; Byron L. Strasburger & Co., \$5; Ludeke & Heiser, \$5; A. K. Sloan, \$5. Total, \$885.

E. Arnstein, of E. Arnstein Bros. & Co., 65 Nassau St., sailed yesterday for Europe on the *Kaiser Wilhelm II*.

Meyer Goodfriend, of Goodfriend Bros., accompanied by his niece, Miss Cora Goodfriend, will sail to-day on the *Oceanic*.

Adolph Schweiger, Selma, Ala., is in New York calling on the trade. He was accompanied to the city by his wife, who is now making her first visit to New York. They will remain several weeks.

Frank A. Chace, Chicago salesman of the C. M. Robbins Co., Attleboro, arrived in New York several days ago to claim the body of his brother, Edmund C. Chace, who was drowned in the Harlem River.

Contracts are being awarded for the remodeling of the upper part of the Hotel Cambridge property at 33d St. and Fifth Ave. The lease of the property for 63 years from 1901 is held by the Gorham Mfg. Co.

E. A. Khouri & Co. was incorporated last week to deal in art antiques with an authorized capital of \$500. The incorporators are: E. A. Khouri, New York; N. H. Kibany, Brooklyn, and H. DeLancey Rapsion, Germantown, Pa.

Miss Ada Wodiska, daughter of Julius Wodiska, 40 John St., has announced her engagement to Isidor Dilloff. A reception will be tendered next Sunday, from 3 to 6 P. M., at the residence of Miss Wodiska's parents, 206 W. 112th St.

A young woman giving her name as Blanche Golden was arrested last Saturday on the charge of stealing from the jewelry and other departments in Sixth Ave. stores. She was held by Magistrate Whitman in the Jefferson Market Court in \$500 bail.

The many friends of Max Bauman, formerly road representative for A. R. Katz & Laudan Co. and also for E. & J. Bass, will be pleased to hear that he is now manufacturing diamond and gold jewelry as senior member of the firm of M. Bauman & Co., 87 Nassau St.

The trade in New York has been requested by Armer & Weinschenk, San Francisco, to send at once duplicate invoices of all merchandise purchased by them since Jan. 1, in order to assist in adjusting the insurance on their fire losses. The new address is 3370 Clay St.

Isaac Greece, an instalment dealer of 128 Essex St., last Sunday, caused the arrest of Ludwig Jarofsy on the charge of stealing two rings and three chains. The arrest was made just after Jarofsy was married and while the wedding celebration was in progress in New Stanton Hall, 180 Stanton St.

Friends obtained the prisoner's release by furnishing \$1,000 bail.

Carl H. Weidemann, of Borrelli & Vitelli, 101 Broadway, will sail Saturday on the *New York* for Europe, and at Paris he will join G. B. Vitelli, who went over several weeks ago. Mr. Weidemann will remain abroad about two months, giving a considerable part of his time to inspecting the offerings in art novelties in Paris and other cities.

Maurice J. Schless, who has been in business under his own name at 1 Maiden Lane, last week formed a partnership with Albert Brod, who was formerly a member of Marx & Brod, and also of Jonas & Brod. The new firm will occupy the quarters at 1 Maiden Lane under the style of Schless, Brod & Co. and will manufacture diamond jewelry.

Frederick P. Moody was arraigned last Thursday in the Court of General Sessions on the charge of grand larceny in obtaining a quantity of diamonds from a Maiden Lane firm by representing that he was employed by another house. His trial was postponed until next week. Moody is the young man who was accused of bigamy and who tried, several weeks ago, to commit suicide.

A pedestrian looking through the show window of the Victor N. Nunes Co., 14 E. 42d St., about 10 o'clock one night last week saw a youth emerge into the optical store through a grating in the floor, and make his way toward the office safe. The policeman on the beat was notified and arrested the youth, who gave his name as James Malloy, 18 years old, of 301 W. 45th St. When asked his occupation he replied, "A burglar, sir," and insisted that he had no other calling.

Word has been received by Joseph Fahys & Co. that the watch cases left in the safes in their San Francisco branch during the fire have not been damaged except by discoloring and possibly some rusting of hinges. Most of them will require nothing more than slight polishing to restore to their former condition. The total loss will, therefore, be small. The entire stock will be brought to this city for repolishing. A quantity of cases, which went through the fire, was received by the company last week from A. I. Hall & Son for repolishing.

Among the resolutions adopted at the annual convention held last week by the National Association of Manufacturers was a declaration in favor of increased reciprocity, especially with Germany and Canada. S. O. Bigney, of S. O. Bigney & Co., Attleboro, Mass., one of the members of the committee, did not sign the report. The convention closed with a dinner given at the Waldorf-Astoria, Wednesday evening, at which Ludwig Nissen, of Ludwig Nissen & Co., New York, was the toastmaster, filling the position with dignity and grace. Secretary Taft of the War Department was the principal speaker of the evening.

W. S. Fulton, the San Francisco representative of the Roy Watch Case Co., is to be married in that city to-day, according to a letter which was received from him by the company's president, Albert L. Stearns. After the ceremony Mr. and Mrs. Fulton are to come on to New York, and will remain here until the requirements

of business call for Mr. Fulton's return to the western city. Mr. Stearns received last week the entire quantity of watch cases valued at upward of \$12,000, which Mr. Fulton buried after the earthquake, as mentioned in THE CIRCULAR-WEEKLY, May 2. The watch cases were not damaged except for some slight discoloration, which will be readily removed by polishing.

Members of the 24-Karat Club held a largely attended meeting Monday afternoon in the Astor House. A resolution was adopted to donate \$100 from the treasury for the relief of jewelry workmen in San Francisco, and the amount will be turned over for that purpose to the Jewelers' Board of Trade. It was decided to give the fifth annual outing Saturday, Sept. 8, and the following committee was appointed to make arrangements: J. B. Wood, E. R. Crippen, Alfred Krower, J. R. Gleason and Percy Savory. While no place was selected, there was favorable talk of "Port au Peck," Pleasant Bay, N. J. As usual, there will be a clambake, followed by athletic contests, and an attractive program will be prepared.

Charges made against B. Konigsberg, 616 Second Ave., accused of buying stolen property, were, last week, dismissed by Judge Wahle in the Tombs Police Court. The detectives who made the arrest had no evidence against him. The jewelry which they seized in his store was returned to him, having been identified by his customers as articles left by them for repairs. This is the case in which some of the daily papers published highly colored reports, saying that jewelry to the value of \$100,000, stolen by Joseph Meastki, the so-called Masonic burglar, had been found by detectives in the jewelry store. Mr. Konigsberg, as told in THE CIRCULAR-WEEKLY of last week, estimated the value of all the articles seized at \$18. He said that no reason has been given to him to account for the suspicions of the detectives.

W. W. Randall, whose business at 209 Greenwich St. was closed out early in the Fall of 1904, as a result of bankruptcy proceedings, recently discontinued the office which he had since opened at 20 Maiden Lane. Judge Thomas, of the United States District Court, some time ago granted an order directing the bankrupt to pay \$600 to the trustee for the benefit of creditors. This order was obtained by Mervyn McKenzie, of Hastings & Gleason, as attorney for the trustee, after a legal battle in which much evidence was taken before a referee. It was charged that just before the failure Randall went to Niagara Falls and secreted a considerable quantity of jewelry. The court did not decide in the trustee's favor for the full amount which it was claimed that Randall had secreted, but declared that as to the jewelry valued at \$600 there was no doubt of his responsibility. The order of the Court directing Randall to return this jewelry has not been obeyed, and a further order was granted several days ago, directing him to show cause why he should not be punished for contempt.

C. E. Hiett, formerly of Charter Oak, Ia., had arranged to engage in business in Moorehead, Minn., but the building which he was about to occupy was destroyed by fire.

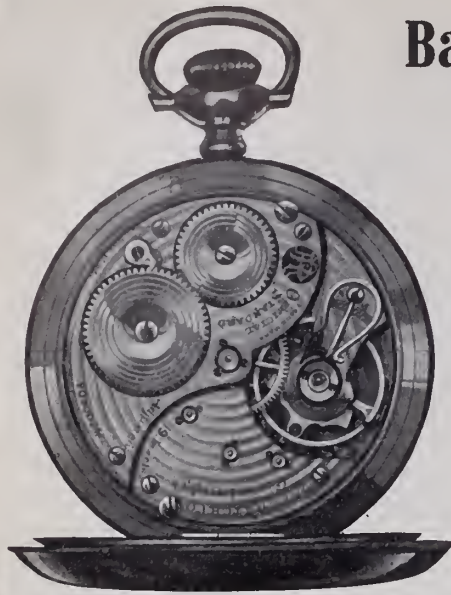

## Ball's Official Standard R.R. Watches

WHAT WOULD YOU GIVE FOR A LIFELONG CUSTOMER?

Try this plan.

Sell your next watch customer a "Ball."

Its reliable performance will convince him you are a dealer to be depended on—he'll keep coming back for other things.

The watch will win you his business and friendship for always.

*Write for booklet, and watch this space.*

We want to add a lot of new friends to the Ball family of railroad watch dealers.

### THE WEBB C. BALL WATCH CO.

CLEVELAND  
Ball Building

CHICAGO  
804-6-8 Railway Exchange

ESTABLISHED 1854.

INCORPORATED 1893

JUERGENS & ANDERSEN Co.,  
DIAMONDS,  
MAKERS OF FINE JEWELRY,  
92 TO 98 STATE STREET,  
CHICAGO.

23-25 Looijersgracht Amsterdam, Holland.

# THE HERMAN KECK MFG. CO.

## CUTTERS OF

# DIAMONDS.

### FOR SALE.

A complete diamond cutting outfit of twenty benches, *European make*, consisting of sawing machines, rounding machines, laps, tongues, dops, scouring stands, etc., all in first class condition. Will sell cheap, if sold in bulk at once, as we have replaced them with American tools.

MANUFACTURING JEWELERS, SILVERSMITHS.

Recutting and Repairing of Diamonds.

17-19-21-23 West Fourth St.,  
CINCINNATI, O.

## RUDOLPH NOEL & CO.

IMPORTERS OF

Diamonds, Pearls, Rubies, Emeralds, Sapphires, Opals, Olivines,  
Cat's-Eyes, Rose Diamonds and Reconstructed Rubies

2 Tulp Straat, AMSTERDAM

Phone 1902 John

37-39 Malden Lane, NEW YORK



# WESTERN DEPARTMENT

Western Office:  
204 COLUMBUS MEMORIAL BUILDING,  
CHICAGO.

Telephone:  
4079 CENTRAL,  
CHICAGO.

VOL. LII.

CHICAGO, WEDNESDAY, MAY 23, 1906.

No. 16.

## Chicago Notes.

G. E. Lofgren, Mediapolis, Ia., was a Chicago visitor last week.

Robert Nichols, Kenosha, Wis., visited Chicago jobbers last week.

Theodore Leaf, De Kalb, Ill., was in Chicago buying stock last week.

S. Lazarus, of S. Lazarus & Co., Masonic Temple, has returned from a trip to New York.

Joseph H. Ehrlick, traveler for Goldman Bros., has left the road and is now covering the city trade for the same firm.

Louis Miller, Laramie, Wyo., who passed some time in Chicago last week, has returned home, but promised to come back here in two weeks on another business trip.

The breaking of the main machinery shaft at the plant of the Illinois Watch Case Co., Elgin, recently caused the factory to close down for repairs for a few days.

Miss Susan Jones, the oldest woman employe in the service of the Elgin National Watch Co.'s factory at Elgin, fell while at the home of her brother, recently, breaking her hip. Miss Jones was removed to St. Joseph's Hospital, where it was discovered that the injury may result in her being permanently crippled. Miss Jones has been employed in the watch factory for about 40 years, in train room.

The confession of a thief is reported to have vindicated Policeman Oscar Benson, who, after being charged, last August, with larceny by Mathias Mamer, shot and killed his accuser and then committed suicide. Mamer, who owned a jewelry repair shop, accused Benson of stealing three watches from his store, and declared the patrolman had been seen taking them. Wednesday James Hanratty confessed to the police that he stole the three timepieces.

John G. Neumeister, formerly head of the Roberts Mfg. Jewelry Co., 126 State St., which went out of business last month, has come out as a candidate for Mayor of the city. "Nix for the Lid" is the slogan Mr. Neumeister will adopt, and he expects to be swept into office by a clamorous throng of Chicago voters. Mr. Neumeister has lived in Chicago 50 years and says that he believes he knows what Chicago wants in the way of an administration. He will not

make formal announcement of his candidacy for some months, and declares he will abide by the result of the election next Spring, without making any contest should any other candidate win.

Julius Kahn, president of the defunct Cash Buyers' Union, First National Co-operative Society, \$300,000 of whose assets were ordered sold recently, has been indicted by the United States Grand Jury on charges of using the mails to defraud. The indictment against Mr. Kahn alleges that he misrepresented the extent of his business and made other false claims in obtaining subscriptions to stock. He gave \$5,000 bond to insure his appearance at the next term of court.

"San Francisco may have been wiped off the map by the earthquake and fire, but the disaster did not kill the indomitable spirit of her jewelry merchants," declared A. P. Matthews, Chicago manager of the Roseville Pottery Co., to THE CIRCULAR-WEEKLY correspondent, last week. "Already we have received many inquiries from merchants who lost all in the fire and earthquake, about goods, and we are planning to send men to the stricken city with samples in a few weeks. Some of the California firms have sent their buyers east and they are now ordering goods to replace the stocks destroyed. We have received one or two letters asking how much time would be given on goods purchased, but the majority of those who ask prices are seeking no greater inducements or longer time than is usually allowed. One thing about these western dealers is the fact that they are buying even better goods than they handled before the earthquake there. Every one is an optimist."

## American Horological Society Hears Interesting Lecture.

CHICAGO, May 17.—The American Horological Society held its regular monthly meeting last evening at the Shiller Hall on Randolph St. The meeting was well attended, the occasion being the lecture on "Horology," by C. J. Higginbotham, superintendent of the South Bend watch factory.

Mr. Higginbotham reviewed the history of time measuring instruments from the earliest dawn of civilization to the present time, bringing out many interesting

points in their evolution from primitive contrivances to the present complicated and delicately adjusted watch, not generally known to watchmakers. He stated that the all around watchmaker had wholly disappeared in the personnel of the modern watch factory, the work being wholly done by specialists.

Incidentally the lecturer referred to magnetism in watches and stated that, in his opinion no watch was probably entirely free from the influence of this force. He gave some special tests to ascertain the presence of magnetism in watches and exhibited a peculiar delicate magnetic needle of his own invention for that purpose.

## Minneapolis and St. Paul.

S. B. Millard, optician, Minneapolis, recently made a brief visit to his old home at Litchfield, Minn.

W. M. Stone, Minneapolis, has improved the appearance of his advertising sign, consisting of a large dummy watch, in front of his store.

Among the out of town jewelers in the Twin Cities, last week, were G. Dillon, Manly, Ia.; L. T. Dillon, Litchfield, Minn.; J. C. Gerde, Paynesville, Minn.

Charles Fales, formerly of Fort Pierre, S. Dak., is at present taking a course in watchmaking in Minneapolis. He expects to engage in business in Fort Pierre.

E. F. English, for a number of years watchmaker for the Minneapolis Jewelry Mfg. Co., has resigned to take a similar position with W. M. Stone, Minneapolis.

The Minneapolis Jewelry Mfg. Co. is about to remove from the second floor of the Andrus block, 510 Nicollet Ave., to new quarters in the new Security Bank building at 4th St. and Second Ave. South, just being completed.

Health Commissioner Ohage, St. Paul, has agreed to pay the stockholders of the Anchor Silver Plate Co. \$2,500 for all interest in four lots on the West Side levee at the entrance to the public baths and the tract will be used for park purposes. This was agreed to at a recent meeting of the Committee on Streets of the Board of Aldermen. Dr. Ohage said the money would be paid in two instalments, half this year and half next, from the public baths fund.

# To the Jobbing Trade.

**Mark  
THIS  
Well** X

for it is certainly to your advantage to know that our variety of diamond jewelry and mountings is the largest that any manufacturing jeweler ever displayed, and that our prices are right.

**Diamond Bunch Rings  
Diamond Brooches and  
All other Diamond Goods**

**Sold on a Loose Diamond Basis.  
Mountings at our regular prices.**



## Omaha.

Albert Edholm spent a few days of last week fishing at Blue Lake, Ia.

Gene Carbray, of the Rochester Optical Co., was in this city visiting friends last week.

Charles Dixon and wife, North Platte, Nebr., were among the visitors in this city, recently.

George W. Ryan and wife arrived in New York from Europe, last week, and are expected home shortly.

T. M. Heard, Los Angeles, Cal., patentee of the Heard Patent Eyeglass, was a visitor in the city, last week.

Sol Bergman, of the Sol Bergman Jewelry Co., has returned from a business trip through the western part of the State.

E. J. Anderson has sold his interest in the jewelry business to his partner, N. P. Frandsen. Mr. Frandsen will continue the business as heretofore.

J. L. Jacobson, manufacturing jeweler and treasurer of the Zion Lutheran Church, has taken out a permit to erect at the corner of 36th St. and Lafayette Ave. a \$12,000 church building.

Fred Brodegaard & Co. supplied the handsome chest of silver to the Milwaukee Railroad employes, to be given as a wedding present to the superintendent of the Iowa division at Dubuque, Ia.

The following out of town jewelers were in this city, last week, replenishing their stocks. John Crabill, Plattsmouth; S. H. Avey, Auburn; C. F. Collins, Bennett; C. F. Steiner, Madison, and Chas. Reed, Woodbine, Ia.

The trade here has been notified that a diamond ring, valued at \$350, which was being raffled by the Elks at their clubrooms, for the benefit of "Spud" Farrish, at one time a resident of this city and an Elk, was stolen from the secretary's desk on Tuesday night, last week. It was evident the culprit was familiar with the location of the ring. So far no arrests have been made.

Mae Thomas, a stranger to the police, Friday afternoon, May 11, at the jewelry store of T. L. Combs & Co., 1520 Douglas St., was caught in the act of swallowing a diamond weighing two and one-sixth carats and worth \$350. She was arrested by Detectives Maloney and Dunning and charged at the city jail with grand larceny. The woman pleaded not guilty. During the afternoon a report was sent to the Police Headquarters that a woman had acted in a suspicious manner while posing as a prospective customer at the jewelry store of N. P. Frandsen, 109 S. 16th St. At the Frandsen store she was stopped on her way out and a diamond ring was found in her handkerchief. She was so profuse in her apologies, however, that she was allowed to go, but as a matter of precaution the police were notified and given a description of the woman. Detectives Maloney and Dunning were placed on the case and in due time located the woman at the Combs store. The accused is a Spanish-American and of rather dashing appearance. Later in the day the detectives arrested J. T. Hayes, who is believed to be a companion of the Thomas woman. The case has been the subject of much newspaper notoriety.



## Kansas City.

D. S. Kavanaugh and Wm. J. Schmidt, both of Tipton, Mo., enrolled, last week, at the Southwestern Optical College.

Frank W. Swearingen, Topeka, Kans., called on the local trade, last week, having come down to the city in his automobile.

George Edwards, of the Edwards & Sloane Jewelry Co., left last week for New York, to join Noble Fuller on his buying trip. They will return together about June 1.

D. B. Ward has obtained a location for his wholesale jewelry stock in the suite of rooms formerly occupied by the Dorst Co., in the Gumber building, corner of 8th and Walnut Sts.

Leo H. Ludwig, of the Edwards & Sloane Jewelry Co., and C. B. Norton, of the C. B. Norton Jewelry Co., have just returned with the Commercial Club from a trade extension trip through Kansas and Colorado.

A. E. Howell, who came from Salida, Colo., to this city to take a course at the Kansas City Polytechnic Institute, has finished and gone to Excelsior Springs, Mo., where he has taken charge of a jewelry store.

The death is reported of W. C. Schwaible, Falls City, Nebr., formerly a student at the Kansas City Polytechnic Institute. The deceased had intended to come back and continue his studies. He was formerly with the jewelry firm of Davis & Owens, Falls City.

C. E. Dickinson, Garden City, Kans., was in this city, last week, purchasing new fixtures. He says he is going to have one of the handsomest stores in western Kansas. His city is enjoying a boom, on account of a new beet sugar factory which is being built there.

The following out of town jewelers called on the jobbers during the past week: Walter Spurling, Seneca, Kans.; John Tucker, Tucker Jewelry Co., Higginsville, Mo.; C. E. Dickinson, Garden City, Kans.; Leslie Hutton, Lebo, Kans.; S. F. Ricker, Emporia, Kans.; G. B. Douglas, Pleasant Hill, Mo.; Leslie White, Lees Summit, Mo.; Walter Starke, Junction City, Kans.; C. B. Libby, Weir, Kans.; S. H. Ledden, Sedan, Kans.

Tovie Brenner, a pawnbroker at 117½ E. 5th St., was fined \$50 and costs in Police Court, recently, on a charge of disturbing the peace and resisting an officer. The complaint was made by G. W. Johnson, a laborer living at 627 Broadway, who says that Brenner cursed him and assaulted him because he refused to make a purchase. Detectives Huntsman, Brannon, Oldham and Kinney testified to Brenner's system of doing business by bullying those who refused his wares and said that only a month ago a farmer living at Independence was subjected to the same treatment that Johnson was the victim of yesterday. When Brenner was taken to the station yesterday afternoon he objected to being searched at the desk and it took three men to accomplish the task.

Word comes from Oklahoma, Okla., that the opticians of the two territories had a very successful meeting there last Monday, and organized a creditable territorial association. The following attended the meet-

ing: J. C. Eisfelder, Chickasha, Ind. T.; J. Watkins, Okmulgee, Ind. T.; A. Y. Boswell, Tulsa, Ind. T.; H. E. Rakeman, Sapulpa, Ind. T.; Mr. Burrows, Jennings, Okla.; R. C. Everts, Weatherford, Okla.; Geo. L. Marquis, Pond Creek, Okla.; J. F. Lloyd, Pond Creek, Okla.; Warner & Co., Mangum, Okla.; W. C. Wolfe, Chandler, Okla.; E. R. Derby, Okarche, Okla.; A. C. Lamb, Perry, Okla.; W. A. Wright, Shawnee, Okla.; N. O. Barnhill, El Reno, Okla.; E. W. Eisfelder, Lamont, Okla.; W. K. Grady, Stillwater, Okla.; C. A. Ball, Hennessey, Okla.

## St. Louis

James J. Burke, president of the Brooks Jewelry & Optical Co., was in Chicago on business, last week.

P. T. Whelan, of the Whelan Ahle-Hutchinson Jewelry Co., has returned from a business trip to New York.

E. C. Weidlich, of William Weidlich & Bro., was in Buffalo, Detroit and Cleveland last week, on his way home from the east.

Ben Linz, of Joseph Linz & Bros., Dallas, Tex., accompanied by Mrs. Linz, was in St. Louis, last week, on their way to New York.

Charles S. Ahle, of the Whelan-Ahle-Hutchinson Jewelry Co., has returned from a successful hunting trip to Blue Springs Lodge, near Bourbon, Mo.

Miss Eva Pecaout, entry clerk for the L. Bauman Jewelry Co., is confined to her home on account of an accident. She fell and injured her right arm.

E. G. McDill, Sparta, Ill.; A. A. Hainer, Jr., De Soto, Mo.; J. A. Allison, Rolla, Mo., and William R. Davis, Springfield, Mo., were among the out-of-town jewelers here last week.

Among the representatives who called on the trade, last week, were: Frank T. Barton, of George N. Steere & Co., Pawtucket, R. I., and S. C. Powell, of S. C. Powell & Co., New York.

H. C. Edwards has resigned from the traveling staff of the L. Bauman Jewelry Co. on account of sickness. He is at present in this city. His territory was in Missouri and Kansas.

A jolly party, composed of employes of the Mermod, Jaccard & King Jewelry Co., spent the latter part of the week on a brief fishing trip in Beaver Dam Lake, Ill. In the party were the following: W. Lanman, Charles Marshall, A. O. Grimes, Lee Schum, Pullman, E. Eckerman, E. Dorn, W. L. Ely and Charles Buettner.

On the first anniversary of the death of Samuel Eisenstadt, late president of the Eisenstadt Mfg. Co., Friday, the employes of that company placed hundreds of roses and lilies on the grave of their late chief. When Morris Eisenstadt and other members of the family visited the grave they found the flowers there to their great surprise. It was a touching tribute to the memory of the dead jeweler.

A number of prominent jewelers will be present at the conclave of the Knights Templar of Missouri, which convenes at Joplin, Mo., this week. Among those who will be in attendance are: Herman Mauch, president of the Retail Jewelers' Association of Missouri; George Hess, of Hess &

Cullbertson; Louis Kurtzeborn, of A. Kurtzeborn & Sons; Martin Hacker and F. W. Drost, of the F. W. Drost Jewelry Co.

Paul Flucks, 616 4th St., was recently fleeced out of a pair of diamond earrings, valued at \$230, by a stranger. Mr. Flucks is said to have sold the earrings to the stranger for \$230. When the stranger counted the money the jeweler is satisfied it amounted to \$230. Mr. Flukes counted the sum again after the stranger departed, and there was only \$30. The police were notified, but no arrests have been made so far.

The Mermod, Jaccard & King Co-operative Association will give a picnic, Saturday, June 30, at Ramona Park, in St. Louis County. The members of the association have invited the women employes, the cash boys and others who are not eligible for membership in the association. President Estes has appointed a committee composed of the following to look after the arrangements of the affair: J. C. O'Brien, chairman; W. A. Boehm, B. P. Logan, E. C. Eisman and E. W. Bornmueller.

## Denver

J. B. Johnson, Walsenburg, Colo., made a flying trip to this city, last week, on business.

Geo. Smith, formerly with the Boyd Park Jewelry Co., has taken a position with Joseph I. Schwartz.

E. C. Loper, Fort Morgan, Colo., was a recent visitor in this city, where he called on the wholesale dealers.

Edward Lehman, of the Edward Lehman Jewelry Co., has returned from a pleasure trip through Colorado and Utah.

W. W. Hamilton, of W. W. Hamilton & Co., has gone, with his family, to Los Angeles and the surrounding country, to spend a three weeks' vacation.

George S. Adams, formerly located in Rawlins, Wyo., was in Denver, recently, on his way to Santa Rosa, Cal., where he intends to engage in business.

F. X. Newberger, watchmaker, employed by the Bohm-Allen Jewelry Co., will move to Spokane, Wash., June 1, to engage in the jewelry and watch repairing business.

## Pacific Coast Notes.

Emil Pfund, Aberdeen, Wash., is preparing to put in a gallery on three sides of his jewelry store, which will be finished with mirrors and polished wood.

J. B. Weirick, who opened a store, three months ago, in the Colonial building, Spokane, Wash., reports that a \$200 diamond ring was recently stolen from his show window. The ring was taken while Mr. Weirick was at dinner. It contained two stones, each weighing about three-fourths of a carat.

Max Kuner, a watchmaker and jeweler, Seattle, Wash., reports that a man named Lloyd, aged 50 years, who worked for him up to April 30, has been missing since that time from his home and place of employment. Lloyd had one week's wages due him, which he did not draw, and when he did not appear at the store, May 1, Mr. Kuner reported the matter to the police.



The AMERICA Alarm is a trade-waker for dull stores—a special price on such a necessary article is a good advertisement that pays its own way.

The Western Clock Mfg. Co.  
LA SALLE, ILL.

ROBERT DULK,  
DESIGNER,

Etching in Gold and Silver,

Telephone, 3960 Chelsea.

No. 70 5th Avenue,

NEW YORK

### Cincinnati.

Joseph Mehmert recently returned from the west and is now in Michigan.

Jerome Thoma, of Thoma Bros., left last week on a three weeks' eastern trip.

Frank Nunn, formerly with Joseph Plaut, is now with the Oskamp Jewelry Co.

J. B. Osthoff, with Joseph Noterman & Co., will visit the trade in northern Ohio this week.

August Newstedt, of Lindenberg, Strauss & Co., left last week for Atlantic City and New York.

P. H. Savory, New York representative of the Wadsworth Watch Case Co., was in this city last week.

Julius D. and Arthur C. Jacobs, of D. Jacobs & Co., started, Saturday, for the east on a purchasing trip.

N. B. Barton, Sr., of the Ostby & Barton Co., was here last week paying his annual visit to the local trade.

James C. Haslam, of the John Holland Gold Pen Co., is making an extended western trip as far as San Francisco.

At the annual election of officers of the Cincinnati Club, A. G. Schwab, of A. G. Schwab & Bro., was chosen president.

The wife of Jacob Lewis received serious injuries last week as a result of a fall from a step ladder at her home at 12th and Vine Sts.

Herman Uhrig, manager for Charles Uhrig, Gallipolis, O., was here, last week, buying fixtures for the former's new store at that place.

Charles Becker, local manager for the Philadelphia Watch Case Co., is on a business tour through the south and will visit New Orleans.

Herman Keck, of the Herman Keck Mfg. Co., left here Thursday for New York, from which port he sailed yesterday on the *Kaiser Wilhelm II.* for Europe.

Joseph Hornback has wound up his material and supply business and hereafter will be a road representative for Albert Bros. He will make his first trip June 1 and visit Ohio, Michigan and Indiana.

J. F. Carr, who purchased the Harris Jewelry Store, Portsmouth, O., last Fall, has notified his friends here that he has completely remodeled the interior of the establishment and improved the exterior by adding new show windows. He has now one of the handsomest stores in southern Ohio.

Out of town dealers purchasing stock in this city last week, included N. H. Jepson, Washington, Ind.; John Selbert, Frankfort, Ky.; Lee Baldwin, of Baldwin Bros., Winchester, Ky.; Mr. Kaiser, N. Kaiser & Co., Atlanta, Ga.; Alvis Carr, La Follette, Tenn.; L. C. Diefenbaugh, Lewisburg, O.; C. Sieglitz, Vevay, Ind.; Aaron McConnell,

Mt. Olivet, Ky.; J. F. Katenbrink, Bear Branch, Ind.; Ashton & Baker, Middletown, O.; L. P. Brockman, Augusta, Ky.; H. E. Battelle, Mason, O.; J. H. Drake, Lebanon, O.

William Fink notified THE CIRCULAR-WEEKLY last week that in the item which appeared in the issue of May 16, telling of the robbery of his jewelry store at 1424 Main St. by a negro, a slight error appeared, inasmuch as it was stated that he had recovered some of the stolen property. Mr. Fink said that he has not identified nor recovered anything up to the present time. Four years ago he had a similar experience with a thief, and the man was indicted by the Grand Jury, but escaped by giving straw bail. At that time, as well as at present, though he recovered none of his property, the newspapers published many articles to the effect that the stolen goods had all been returned.

### Indianapolis.

J. H. Reed, who is visiting along the Pacific coast, will return home about June 1.

E. S. Fishback, representing the Hamilton Watch Co., was greeting friends in this city last week.

Augustus P. Craft, of the A. P. Craft Co., has returned from a business trip through the northern part of the State.

A graphic description of the business career of Julius C. Walk, of Julius C. Walk & Son, of this city, accompanied by a half-tone portrait of Mr. Walk, appeared in a recent issue of a local daily, which included an interesting history of the jeweler's start in life.

Out of town jewelers who visited the local jobbers and manufacturers, last week, included: H. Wheeler, Dana; J. A. Pickett, New Castle; C. E. Hodgen and Ross J. Haseltine, Kokomo; J. F. Harding, Brownsburg; H. A. Pauley, Bloomington; Mr. Barnes, of Barnes & Foster, Spencer; B. Maier, Edinburg; Aaron Pursel, Noblesville; D. S. Whittaker, Lebanon, and Mr. Raber, of Clarke & Raber, Anderson.

The attention of the police has been called to a check that was cashed by Arthur Rose, of the Cullen Jewelry & Optical Co., in the Traction Terminal building. The check, which called for \$9, was presented in payment for a ring by a man who gave his name as A. Fernback. The name signed to the check was A. Heller. Rose gave the man \$7 in change. At the American National Bank the check was pronounced worthless. Fernback was a young Jew, who spoke broken English. He was slightly marked, as if by smallpox.

John R. Rakestraw, Lima, O., has retired from business.

**JOS. NOTERMAN & CO.**  
**DIAMONDS**

IMPORTERS AND CUTTERS

Recutting and Repairing odd shaped and chipped stones a specialty. Manufacturers of Mountings and Fine Jewelry. Special Designs Furnished.

CINCINNATI, OHIO.

## San Francisco.

S. B. Ross has opened offices in the Hotel Metropole, Oakland, where he is preparing to buy diamonds and other precious stones.

A. I. Hall & Son moved, May 20, from their temporary quarters in Oakland to the Jewelers' and Silversmiths' building on Market St. here.

The Portland Jewelry Co., formerly located at 25 Stockton St., announces that both its stock and its pledges passed through the fire uninjured.

Shreve & Co., now located at 2129 Jackson St., and at 1103 Broadway, Oakland, last week got their temporary factory in this city in working order.

Nordman Bros., who will shortly be located in the Jewelers' and Silversmiths' building, are now making deliveries from their temporary offices, at 2505 Clay St.

The Fleissner-Marshall Co., formerly at 14 Geary St., opened its large safe last week, only to find that the contents were practically ruined. The salvage from the safe was segregated from the ash and other waste by means of a coarse sieve.

Hammersmith & Field, formerly in business at 36 Kearny St., were among the last of the larger jewelers to open their safe. They had some difficulty in locating it. The hope is expressed that the contents will be found in better shape than has been the case with the majority of the jewelers' safes opened thus far.

A man, giving his name as George White, was recently arrested in Oakland, Cal., with a large quantity of loot from some San Francisco jewelry store in his possession. He had on his person 45 watch charms, four revolvers, \$125 in quarters, some melted coin and other property. He was returned to this city, where he is held on a charge of grand larceny.

A mass of gold and silver, valued at \$3,500, containing gold and silver articles melted by the fire in the store of Tai Sing, a Chinese merchant at Washington and Dupont Sts., which had disappeared from the ruins, has been recovered by the police. The loot was found hidden in the ruins at Broadway and Stockton St. The mass was three feet long and 18 inches wide, by six inches thick.

There has been some shifting about among the proposed occupants of the Jewelers' and Silversmiths' building. Nordman Bros., the material men, and the Morgan & Allen Co. will share the second floor, while Henry Abrams, who was to have been on that floor, will be located on the fifth floor.

The Gorham Mfg. Co., formerly represented in San Francisco by Phelps & Adams, at 120 Sutter St., has now opened offices on its own account at 1103 Broadway. The company has its men on the road, and has been for some days supplying the immediate wants of the trade from stock. Arrangements were made last week for additional space at the same location.

Manager Melrose, of the W. K. Vanderlice Co., formerly in the retail business at 136 Sutter St., is not very enthusiastic as to the immediate prospects of the retail trade in San Francisco, and it is doubtful if this house will resume business before permanent quarters can be had. One of the company's safes was warped open by the intense heat, and the contents were ruined.

The Bohm-Bristol Co., formerly at 104 Geary St., which now has temporary offices in the Union Savings Bank building, on Broadway, Oakland, is engaged in getting the salvage out of the ruins of its store. It is believed that about \$7,000 worth of stock can be recovered. The company's loss was heavy, but the officials announce that it was well insured and will resume business. They are not prepared at present to say when or where, as both place and time will depend entirely upon developments in the city. Henry Bohm, of the company, who came on from Denver after the fire, will probably go east to arrange for new stock as soon as he gets insurance and other matters settled.

## Cleveland.

E. C. Crater, New Comerstown, who filed a petition in bankruptcy some time ago, has filed an application for discharge. The hearing is set for June 30.

Burglars entered the store of Frank Brand, Findlay, a few days ago, and succeeded in getting away with about \$600 worth of diamonds and other jewelry.

E. J. G. Galley, formerly of Galley & Co., and F. M. Gear, have formed a partnership under the name of Gear & Galley Co., to deal exclusively in watches. They will be located in the Cuyahoga building.

The firm of Ginsburg & Tronstein, manufacturing jewelers, has been dissolved, Samuel Tronstein purchasing the interest of his partner. He will continue the business in the old location, 143 Euclid Ave.

Herbert W. Burdick, of the Bowler & Burdick Co., and G. L. Sigler, of the Sigler Bros. Co., have returned from a trip through northwestern Ohio, northeastern Indiana and southern Michigan with the wholesale board of the Chamber of Commerce. This is the 16th trip made by that organization to visit their customers, and the merchants stopped at a greater number of towns this time than on any of the others. They express themselves as well pleased with the trip.

J. H. Danforth, of the Cowell & Hubbard Co., has been re-elected president of the retail board of the Chamber of Commerce, as well as a member of the executive committee. In his address at the annual meeting, Mr. Danforth emphasized the fact that the organization as a branch of the Chamber of Commerce is able to do as much good as two independent organizations. The matters of greatest importance the past year, perhaps, were the excursions to Boston and Lorain, O., and the inauguration of an Exposition week before the Winter holidays. The board was also instrumental in securing the passage of an ordinance allowing retail merchants to use certain space on the sidewalks for outside show cases.

The production in gold of the Zimmerman elk head by the Gustave Fox Co., Cincinnati, has been the subject of comment in that city, where the piece is not only admired but considered one of the finest and most exact copies of the artist's masterpiece that has been made.

## Pacific Coast Notes.

Alexander Marks, Lawrence, Kans., recently made a business trip to Albuquerque, N. Mex.

The store at Washington and Center Sts., Phoenix, Ariz., will soon be occupied by N. Friedman.

J. Rufener, San Pedro, Cal., has moved into new quarters in the Wells-Fargo building at that place.

E. T. McCarthy, a traveling representative, of Bradford, Pa., has been visiting the trade at Santa Fe, N. Mex.

The Buhrmeister building, at Suisun, Cal., has been remodeled for W. F. Wooster. Mr. Wooster will move into the new place next week.

Mr. Casanova, who conducted a jewelry store in San Francisco before the earthquake and fire, has rented quarters in the Hess building at Petaluma, Cal., where he will soon open a store.

H. W. Schueler, Fortuna, Cal., has remodeled his store. His establishment now has two stories. The middle partition has been removed and a gallery built in the rear end, thus enlarging the store room.

Jewelers from the outside towns in California which were affected by the earthquake report that trade has, in general, shown no falling off that can be traced to the earthquake. F. R. Stearns, San Jose, states that trade in that city has shown a distinct improvement in the repairing line since the earthquake. Sales have been about normal, showing a slight increase over the same weeks of last year.

## Toledo, O.

Henry Eells, a local watch repairer, is expecting to shortly improve some of his real estate holdings by the erection of one or more modern residences.

W. H. Broer, 427 Summit St., has added a new department to his store, and hereafter will carry hand painted china from the studios of local and foreign artists.

J. J. Freeman & Co., 313 Summit St., will shortly celebrate their 30th anniversary. Aside from being one of the oldest firms in Toledo, the concern is one of the oldest in the Ohio jewelry trade.

There is some probability that J. Prochaska, who conducts a large jewelry store at 109 Summit St., will be forced to seek new and larger quarters. The property at this address has just been sold.

The jewelry department of W. L. Milner & Co. has the contract to furnish this season's trophies for the Inverness Golf Club, of Toledo. The trophies are nearly two-score in number and include many loving cups, tankards and the like. The number of trophies to be awarded this season will be nearly twice as large as the number awarded a year ago.

F. F. Wallert, Shenandoah, Ia., has succeeded to the business of C. Van Der Elsen, Centerville, Ia.

The meeting which was called for July 3 for the purpose of organizing a State association of jewelers in North Carolina has been postponed until Tuesday, July 10, on account of the State Democratic Convention, which is to be held in Greensboro, July 3.

## A CONFIDENTIAL CHAT.

The average jeweler, a man of experience, has sufficient sound judgment to listen to reason. He is eager to learn facts that will benefit his business and further his sales. Well made jewelry in up-to-date styles is the argument we offer. It is the positive side of an argument that has no negative. It is the article that the dealer is safe in handling and ours are the goods that will attract the prospective purchaser. Our



No. 800.



No. 805.

Buttons,  
Brooches,  
Lockets,  
Bracelets,

Match Boxes,  
Pen Knives,  
Cigar Cutters,  
Fobs,

Bead Necks,  
Heart Charms,  
Scarf Pins,  
Tie Clasps, etc.

are distinctively our own patterns and we furnish them either mounted or unmounted in

**10K. THAT IS 10K.**

**ROBT. LEVY,** Manufacturing Jeweler,  
Green & Columbia Sts., Newark, N. J.



No. 806.



No. 801.

## Bigalke & Eckert Co.

— IMPORTERS OF —  
**WATCHES**

No. 1 MAIDEN LANE,

NEW YORK

Plain Watches in all Styles, Grades and Prices.

Single and Split Second Timers in Nickel and Gun Metal Cases.

Chronographs, Split Seconds, Repeaters. Fancy Decorated Watches for Ladies.

Finest and Most Extensive Assortment of Flat and Ultra Flat Watches.

Sole Agents for **Haas, Neveur & Cie.** Fine Geneva Watches

INDEX TO ADVERTISEMENTS.

Alkin, Lambert & Co.	22	Freund, Henry, & Bro.	25	Ohan, G.	84
Allsopp & Allsopp	22	Friedlander, R., L. & M.	Outside back cover	Ollendorf, L. Co.	46
Alvin Mfg. Co.	Inside front cover	Garraud & Griser	40	Oppenheimer Bros. & Velth	36
American Cuckoo Clock Co.	88	Gesswein, F. W., Co.	98	Oppenheimer, H. E., & Co.	36
American Gem & Pearl Co.	50	Goldsmith, Leo.	46	Oriental Bank	58
American Watch Co.	104	Goodfriend Bros.	42	Orkin Bros.	28
American Platinum Works	28	Gorham Mfg. Co.	54	Osmun-Parker Mfg. Co.	20
American Ring Co.	19	Greer Mfg. Co.	89	Ostby & Barton Co.	18
American Silver Co.	76	Griffoul August	104	Page-Davis Co.	89
American Waltham Watch Co.	56	Guardian Trust Co.	58	Pairpoint Corporation	102
Arch Crown Mfg. Co.	Outside back cover	Hagstoz, T. B., Ltd.	104	Parks, G. W., Co.	12
Arnstein Bros. & Co.	39	Harris & Harrington	Outside back cover	Passmore Gem Co.	48
Art Stamping & Mfg. Co.	Outside back cover	Haskell, Henry C.	46	Patek, Philippe & Co.	86
Austin, John, & Son.	40	Hedges, A. J., & Co.	20	Percival, D. C., & Co.	52
Aztec Turquoise Co.	44	Hedges, Wm. S., & Co.	42	Philadelphia Watch Case Co.	81
Bagg, Perline & Co.	62	Helntz Bros.	20	Potter & Buffinton Co.	14
Bali, Webb C., Watch Co.	59	Heller, L., & Son	58	Potter Shell Works	52
Baschkopf, Jacob	31	Hepers Bros.	98	Power, Chas. L., & Co.	42
Bass, E. & J.	28	Hirsch & Hyman	Outside back cover	Powers & Mayer	15
Bassett Jewelry Co.	16	Hodenpyl & Walker	38	Prior, Charles M.	24
Bates & Bacon	100	Hotel St. James	103	Prybill, P.	104
Bealmeier, H., & Co.	98	Howard, E., Clock Co.	89	Rachne, Jules	89
Berge, J. & H.	68	Hraba, Louis W.	100	Reichhelm, E. P., & Co.	98
Bignike & Eckert Co.	4	Humphrey, John B.	40	Renzehausen, W. F., Co.	104
Bigney, S. O., & Co.	40	Hutchison & Huestis	27	Revel, A. H., & Co.	Outside back cover
Bilings, Cuesier, & Son	103	Illinois Watch Co.	13	Ries & Armstrong	98
Bishop, R. W.	29	Irons & Russell	28	Riviere Brass & Bronze Works	100
Blackinton, R., & Co.	60	Jacob Ansk Box Co.	100	Robert, Edmond E.	84
Blackinton, W. & S., Co.	103	Jeantheur, F., Jr.	98	Rockford Watch Co.	89
Blancard & Co.	100	Jeanne, Frederick A.	46	Roger Williams Silver Co.	27
Boote, Edward	42	Jewelers' Clr. Pub. Co.	Inside back cover	Roseman, A.	46
Borrrell & Vitell	52	Johnston, W. J., Co.	10, 11	Ross, Saltman & Anderson	25
Boston Jewelry Co.	18	Juergens & Andersen Co.	62	Roy Watch Case Co.	87
Bowden, J. B., & Co.	54	Juergensen, Jules	86	Rudolph & Snedeker	86
Bradley Polytechnic Institute	69	Kahn, L. & M., & Co.	Outside back cover	Rump, C. F., & Sons.	102
Brower, Marilee	Outside back cover	Kassel, Abe	25	Sadler, F. H., Co.	17
Bruhl Bros. & Henius Po.	18	Keck, Herman, Mfg. Co.	62	Saunders, Meurer & Co.	42
Bryant, M. B., & Co.	19	Kent & Woodland	22	Schiff, M.	22
Buckley, Sam'l, & Co.	48	Ketcham & McDougall	103	Schultz, Leiss & Co.	25
Bunde & Upmeyer Co.	52	Keystone Watch Case Co.	80	Sessions Clock Co.	88
Chahone, C. H., Co.	20	Klipper Bros.	84	Seymour, Cassius W.	26
Charrington & Co.	21	Kohlbusch, Herman, Sr.	29	Shiman Bros. & Co.	64
Chatham National Bank	58	Kohn, Alois, & Co.	22	Smith, Alfred H., & Co.	36
Chopard Freres.	48	Koshland & Hulle Co.	26	Smith, E. H. H., Silver Co.	30
Conley & Straight	104	Krementz & Co.	23	Snow & Westcott	24
Cooper Diamond Co.	40	Langendorf Watch Co.	56	Sohn & Hyman	50
Cooper & Forman	40	Larier & Sons	34	Solidarity Watch Case Co.	42
Cottle, S., Co.	24	Lees & Sanders	104	Spencer, E. L. Co.	29
Crohn, M.	100	Lehmann Bros.	69	State Bank	58
Cross & Reguelin	30, 56	Lelong, L., & Bro.	Outside back cover	Steiner, Louis	31
Crouch & Fitzgerald	103	Levy, Robt.	68	Stern Bros. & Co.	46
Culman, C.	98	Lewy & Cohen	89	Sternau, S., & Co.	12
Dally, C. M.	98	Lissauer & Co.	38	Stiven, John S.	103
Day, Clark & Co.	21	Loeb, Wm., & Co.	28	Strauss, Ignaz, & Co.	Outside back cover
DePASSE Mfg. Co.	26	Lorsche, Albert, & Co.	Outside back cover	Strauss, Jacob, & Sons.	46
De Selms Watch School	103	Low, Martin, & Tansig.	38	Street, Geo. O., & Sons.	21
Diamond Point Pen Co.	102	Lowe, Edwin, & Co., Inc.	28	Tavannes Watch Co.	50
Didisheim, Hipp, & Bro.	86	Luthy & Hlne	24	Thomas, Seth, Clock Co.	87
Donnelly, J. J.	98	Lyons Gem Co.	40	Trenton Watch Co.	87
Doran, Bagnall & Co.	28	Maeber & Reiss	103	Trout, Charles L., & Co.	20
Dorflinger, C., & Sons	100	Maple City Glass Co.	100	Wadsworth Watch Case Co.	6, 7
Dulk, Robt.	66	Market & Fulton National Bank	58	Wagner Mfg. Co.	30
Dunbar, Leach, Garner Co.	104	Mathey Bros., Mathez & Co.	98	Waite-Thresher Co.	29
Dunn, Thomas J., & Co.	23	Mercantile National Bank	59	Washburn, C. Irving	102
Durand & Co.	20	Meyerowitz Bros.	38	Wells, Chester H.	98
Eden, C. H., Co.	16	Miller, Fuller & Whiting	27	Wendell & Co.	5
Eichberg & Co.	46	Moe, Chas.	50	Western Clock Mfg. Co.	66
Edgin National Watch Co.	78	Moore & Sons	22	Wheeler, Hayden W., & Co.	36
Eliassof Bros. & Co.	103	Mount & Woodhull	44	White, Wm. A., & Sons.	71
Ellis & Co.	26	Mueller Lapidary Co.	40	Whiteside & Blank	21
E. P. H. Chain Catch	19	Myers, S. F., Co.	103	Whiting & Davis	14
Fahys, Joseph, & Co.	1	Newark Cut Glass Co.	100	Whiting Mfg. Co.	9
Fairchild & Co.	30	New England Watch Co.	82	Wightman & Hough Co.	27
Favre-Jacot, Georges, & Co.	84	Newmann, Robert	69	Witsenhausen, L.	24
Feeley, W. J., Co.	24	New York Telephone Co.	89	Wittnauer, A., Co.	86
Forman Co.	103	Nissen, Ludwig, & Co.	44	Wodiska, Julius	26
Forsinger, J. W.	88	Noel, Rudolph, & Co.	62	Wolfsheim & Sachs.	19
Foster, Theodore W., & Bro. Co.	32	Nonnenmann, A., & J. Aschenbrenner	103	Wood, C. F., & Co.	Outside back cover
Four-Track News	103	Noterman, Jos., & Co.	66	Wood, J. R., & Sons.	2, 3

**A GUN METAL MANUFACTURER**

desires to establish connections with a first-rate house engaged in the bijouterie and steelware industries.

After so doing he would submit personally, the method employed. The metal manufactured by this method is guaranteed to surpass all others in durability and depth of color. Best in Germany. Apply to

**Box No. 6349,**

**JEWELERS' CIRCULAR-WEEKLY,**  
11 John Street, New York.

**Encyclopedia-Dictionary**

and reference hand-book of the Ophthalmic Sciences

Price, \$2.50.

The Jewelers' Circular Pub. Co., 11 John St., N. Y.

**LEIMAN'S NEW SAND BLAST.**

SIMPLE. EFFECTIVE. ECONOMICAL.

**NEW FEATURES**—Let us tell you about them.

**RESULTS**—Let us show you samples of work done.

**Improved High Pressure Blower**

NOISELESS. INEXPENSIVE.

Delivers Greater Volume at Higher Pressure Than Any Other Made.

**LEIMAN BROS.,**

Jewelers', Silversmiths' and Metal Workers' Machinery,  
Tools and WORK BENCHES,

141 Centre Street, NEW YORK.

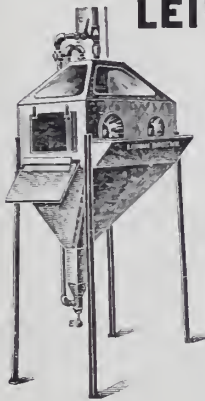

PATENTED.



PATENTED.

**AMERICAN PEARLS**

*From Ten to Ten Thousand Dollars Each.*

**MAURICE BROWER, 16 John St., New York.**

## Special Notices.

Payable invariably in advance.

Rates 75c. per insertion for notices not exceeding 25 words; additional words, 2c. each.

SITUATIONS WANTED, 1c. a word each insertion; minimum charge, 25c.

Heavy type, 5c. a word; minimum charge, \$1.25. Display cards, \$2.00 per inch.

In all cases, if answers are to be forwarded, 10c. extra to cover postage must be enclosed.

*All answers to advertisements addressed care The Jewelers' Circular-Weekly, should be sent to the New York Office, unless the Chicago Office is specifically mentioned.*

## Situations Wanted.

SITUATION WANTED by watchmaker, engraver and salesman; 10 years' experience. Geo. N. Wood, Decatur, Ill.

WATCHMAKER, engraver and jeweler of ability is open for engagement. Address "C., 6331," care Jewelers' Circular-Weekly.

YOUNG MAN (23) wishes position on the road or in wholesale house; reference furnished. "O., 6310," care Jewelers' Circular-Weekly.

YOUNG MAN (22) wishes position as salesman or to work inside in wholesale house. "Wholesale, 6203," care Jewelers' Circular-Weekly.

FIRST CLASS WATCHMAKER, also fair engraver, desires position in west; best references. Address L. W. Crahan, Butte, Mont.

BOOKKEEPER, 10 years' experience; six years in jewelry line; age 33; moderate salary; references. "U., 6317," care Jewelers' Circular-Weekly.

ALL AROUND ASSISTANT; first class repairer; good engraver; can do plain watch and jewelry repairing; good salesman. Address 714 Court St., Burlington, Ia.

MODELER on ornamental sterling or white metal; figure work a specialty; want steady position. Address "Moderate Wages, 6364," care Jewelers' Circular-Weekly.

ENGRAVER and first class clock repairer; can do plain watch and jewelry repairing; good salesman and window dresser. Address "C. C.," Box 313, Pensacola, Fla.

SALESMAN, five years' experience, selling department and jewelry stores in middle west, is open for a similar position. "A. B. R., 6312," care Jewelers' Circular-Weekly.

YOUNG LADY, four years' experience, thoroughly conversant with every branch of the jewelry business, desires position. "F., 6018," care Jewelers' Circular-Weekly.

SALESMAN (20) with established trade in New York, Pennsylvania and Ohio, desires position with manufacturer or jobber. "N., 6319," care Jewelers' Circular-Weekly.

FOREMAN, experienced and thoroughly acquainted with all the details of a ring factory; best references. Address "E. G., 6375," care Jewelers' Circular-Weekly.

YOUNG MAN; watchmaker, engraver and jeweler, desires position by June 1, 1906; Philadelphia or nearby city preferred. Address "W., 6343," care Jewelers' Circular-Weekly.

YOUNG MAN wants to connect with a house where he can learn the business as a salesman; can furnish best reference. "Box 6315," care Jewelers' Circular-Weekly.

WANTED, A POSITION as engraver, bookkeeper, cashier and saleslady; good references; terms reasonable. Address "Enquirer, 6877," care Jewelers' Circular-Weekly.

WATCHMAKER, 20 years' experience, with first class references, desires position with high class jeweler; competent in waiting on trade. "F. F., 6370," care Jewelers' Circular-Weekly.

WATCHMAKER, engraver, fine workman; very good salesman; 17 years' experience; age 32, A1 references; wants position with good house. "S., 6265," care Jewelers' Circular-Weekly.

WATCHMAKER, thorough, practical, rapid and experienced, contemplates making change; offers considered from first class houses; state salary. J. H. Coon, 1000 Main St., Bridgeport, Conn.

FIRST CLASS manufacturing jeweler of business ability, wants position as foreman of jewelry factory; 14 years' experience at bench; references. Address "Ability, 5465," care Jewelers' Circular-Weekly.

JEWELRY SALESMAN, with well established trade in Pennsylvania, New York, Ohio and West Virginia, is open for engagement with manufacturers or jobbers. "L., 6369," care Jewelers' Circular-Weekly.

FIRST CLASS watchmaker wants permanent position; competent to take full charge; large experience on fine and complicated work; fine tools; best of references. Address "Time, 6290," care Jewelers' Circular-Weekly.

POSITION WANTED by a young lady as first class letter and monogram engraver; willing to act as saleslady; would prefer to work in Albany, Troy, Utica or nearby; best reference. Address "L., 6324," care Jewelers' Circular-Weekly.

WANTED, to sell goods on the road for a first class house; 15 years' experience, handling high grade jewelry, but no road experience; make me an offer, either salary or commission, and I will do the rest. Address "Offer, 6360," care Jewelers' Circular-Weekly.

POSITION as watchmaker, engraver and optician; I am an expert watchmaker; first class optician and fair engraver; age 30; 15 years' experience; best reference; please state salary you wish to pay and full particulars in first letter. "Y., 6361," care Jewelers' Circular-Weekly.

POSITION AS WATCHMAKER, jeweler and plain engraver; A1, steady, reliable and experienced; able to take entire charge; good salesman; first class references; steady position preferred; salary, \$18 to \$20 per week. Address "Experience, 6373," care Jewelers' Circular-Weekly.

YOUNG MAN (German), age 23; speaks good English; wishes position as traveling salesman on the road or to work inside for a wholesale jewelry house; two years' experience at traveling; will give security and reference. Address Jack Udelsohn, care M. F. Tepfer, 19 W. 31st St., New York.

A FIRST CLASS watchmaker and salesman, competent refractonist and frame fitter, desires to make a change; American; age 35; only first class houses in New York or vicinity considered; those who would appreciate the services of a man of ability address. "Successful, 6377," care Jewelers' Circular-Weekly.

BY YOUNG MAN (29); position as traveling salesman, for established wholesale house; A1 salesman; salary or commission; references or satisfactory bond given. "E. S. 6329," care Jewelers' Circular-Weekly.

TO WHOM IT MAY CONCERN; any manufacturer or jobber desiring the services, as traveling salesman, of a man 37 years old, 18 years' experience in large retail jewelry stores, temperate, good appearance, fine address, will do well to communicate with one who desires only first class position, where ability and energy count; New York City and southern references; southern territory preferred. "Ability," care S. A. Seipel, 1353 Carrie Ave., Columbus, O.

## Side Lines Wanted.

SALESMAN, traveling over seven central States, wishes line; 10-karat gold line preferred; to use as main or side line; only reliable houses reply. "Central, 6345," care Jewelers' Circular-Weekly.

WANTED, by experienced traveling salesman, on commission, a line either of jewelry, combs, silver, watches, or some line for jewelers in west and northwest States. "Commission, 6230," care Jewelers' Circular-Weekly.

WANTED, a staple line of jewelry, by salesman covering Southern territory. "J. 6314," care Jewelers' Circular-Weekly.

## Help Wanted.

WANTED, a first class manufacturing jeweler. Address Box 107, El Paso, Tex.

JEWELRY AND ENGRAVER; easy work and good salary. Ries & Armstrong, Macon, Ga.

WANTED, a watchmaker to go into Michigan. Apply H. F. Hahn & Co., 156 Wabash Ave., Chicago, Ill.

WANTED, pearl broker; reliable and quick seller; address with references. "Import, 6350," care Jewelers' Circular-Weekly.

WATCHMAKER; young, single; mail us three years' good references; state wages. Greenleaf & Crosby Co., Jacksonville, Fla.

WANTED, a good engraver and jobbing jeweler; permanent position to the right man; references required. T. Kircher, Davenport, Ia.

AT ONCE, a good engraver, clock and jewelry repairer; steady position to a good man. Address "J., 6367," care Jewelers' Circular-Weekly.

WANTED, manufacturing jeweler and jobber; must be good engraver; only steady, sober man need apply. C. A. Tucker, 1123 O St., Lincoln, Nebr.

RING SALESMAN; an A1 ring salesman, with well established retail jewelry trade. Address "Manufacturer, 6302," care Jewelers' Circular-Weekly.

WANTED, good watchmaker, engraver, jeweler and stone setter; optician preferred; salary, \$25 per week to begin with. J. Lowinsohn, Birmingham, Ala.

WANTED, experienced jewelry salesman for jobbing trade; eastern territory; references required. Address "Z., 6334," care Jewelers' Circular-Weekly.

WANTED, AT ONCE, a first class watchmaker and engraver; good wages and permanent position; give reference and sample engraving. L. Daiches, Laredo, Tex.

WANTED, an A1 traveling salesman; territory, Pennsylvania to Missouri; well established territory; commission or salary. Fred Kaufman, 565 Broadway, New York.

WANTED, a fine engraver and good optician; permanent position; send sample of engraving and reference; salary \$25 per week. Edwards & LeBron, Chattanooga, Tenn.

WANTED, WATCHMAKER, jeweler and engraver; competent man; reference required. state salary and send sample of engraving when writing. A. Seidensticker, Hamilton, O.

WANTED, WATCHMAKER, young man or old man, for repairing; about 10 watches per week; no tools needed; fan in the shop; state price wanted. F. C. Rivoire, Napoleonville, La.

YOUNG LADY in factory office of jewelry concern; well recommended; thorough and experienced; state experience and expectations. "K B., 6351," care Jewelers' Circular-Weekly.

WANTED workman, watchmaker, jeweler, etc. state kinds of work you do well; state age, references and wages expected. A. C. Grau Sharpshurg, Pa., Pittsburg Postal Service.

WANTED, first class watchmaker, engraver and jeweler; capable of taking charge of repair department; references. Gorham Book and Mus Co., Jewelers and Stationers, Fayetteville, N. C.

WANTED, good watchmaker; must be capable to do ordinary engraving and wait on trade; permanent position to right man. Address I Krauss, 305 North Washington St., Indianapolis Ind.

WANTED, good engraver to assist on watch young man, 21 or over; one who does not use tobacco preferred; store closed at six o'clock four nights a week. R. E. Brigham, Oneont N. Y.

WANTED, first class traveling jewelry salesman for Missouri and Kansas, principally; must be experienced and well recommended; address own handwriting. L. Bauman Jewelry Co., Louis, Mo.

MAN, to edge, grind, focus and fit frame watch, clock or jewelry repairer preferred; beautiful, healthy town near New York; send references and all particulars in first letter. Address "C., 6359," care Jewelers' Circular-Weekly.

**HELP WANTED.—Continued.**

**WANTED** by jewelry and watch house, salesman for middle west. Address, "A. G., 6180," care Jewelers' Circular-Weekly.

**WANTED** a first class watch salesman with an established trade; good salary to the right man. Address, Rockford Watch Co., Rockford, Ill.

**WANTED, AT ONCE,** a competent watchmaker, plain engraver and jewelry repairer; permanent position; salary, \$20 week; chance of advancement; references and sample of engraving in first letter; apply at once. A. Rabinowitz, Stamford, Conn.

**SIDE LINE** for experienced salesman, calling on best jewelry trade in New York, Pennsylvania and East; well known; popular 10-K. and 14-K. jewelry line, with big inducements; address with full particulars. "N., 6282," care Jewelers' Circular-Weekly.

**WANTED,** a first class watchmaker, engraver and jeweler; surroundings pleasant; position permanent; one capable of taking charge of repair department; splendid opening for good man; state age, experience, etc. H. B. Dodge, 42 Market St., Lynn, Mass.

**MANUFACTURER** of high grade line of silver novelties desires services of a first class salesman for territory west of Buffalo and the southwest, on commission, give full particulars and references in first letter. Address "Novelties, 6336," care Jewelers' Circular-Weekly.

**WANTED AT ONCE,** an experienced practical optician and salesman; good salary and permanent position. Albert Pfeifer & Bro., Little Rock, Ark.

**FIRST CLASS WATCHMAKER,** competent to take charge of watch repair department and know how to handle customers; best store in large city in western New York; wages, \$20 up; answer, giving experience, references and send photo. Address "R., 6371," care Jewelers' Circular-Weekly.

**WANTED,** traveling salesman with established trade in Missouri, Iowa, Nebraska, etc., to take line of sterling silver in connection with non-conflicting line; none but first class men who can furnish the best of references desired. Address "Manufacturer, 6362," care Jewelers' Circular-Weekly.

**WATCHES;** a stock clerk in watch department of wholesale house; good opportunity; must understand the business thoroughly and have experience in the same line; all communications strictly confidential; address, stating age, where formerly employed and salary desired. "Watches, 6316," care Jewelers' Circular-Weekly.

**WANTED,** strictly first class combination man (watchmaker, jeweler and engraver); must be sober and well recommended; good salary and permanent position to good man; must be a willing worker, rapid and very thorough; state salary expected and send sample engraving first letter. Thos. Van Auker & Co., 516 Pearl St., Beaumont, Tex.

**THIRTY-FIVE (\$35) DOLLARS** per week for a capable, experienced manufacturing jeweler and engraver; one who can do stone setting and enameling. "Capable, 6338," care Jewelers' Circular-Weekly.

**RING SALESMAN;** an experienced ring salesman having an established trade with best retail jewelry stores; state experience; only high class men with ability considered. Address, "Manufacturer," P. O. Box 881, New York.

**WANTED WATCHMAKER;** Abraham & Straus, Brooklyn, can place in a permanent position at liberal salary a competent man who thoroughly understands watch repairing in all its details. Apply to Superintendent.

**ANNOUNCEMENT;** on or before June 1, we will make room for a limited number of young beginners, to learn and perfect themselves in the art of practical watch repairing; we train them quicker and with closer attention than the crowded horological schools. For terms or other information apply direct or by letter to Maebert & Reiss, practical and theoretical watchmakers, 71-73 Nassau St., cor. John St., New York.

**Business Opportunities.**

**JEWELERS** and watchmakers to learn engraving and optics; private school in New York City; terms reasonable. "Private, 6318," care Jewelers' Circular-Weekly.

**OPTICAL** and jewelry business for sale, in dairy section of Central Minnesota; splendid opportunity for competent optometrist. "Minn, 6335," care Jewelers' Circular-Weekly.

**FOR SALE,** jewelry store, established 26 years, with or without stock, or will rent store by buying fixtures at low price. For further particulars, M. Hodges, 2168 Third Ave., New York.

**FOR SALE,** well equipped manufacturing jewelry shop, in rapidly growing western city of 40,000; good machinery; old established place; no competition. Address "F. G., 6347," care Jewelers' Circular-Weekly.

**PARTNER WANTED,** man about 30, who is well acquainted with the jewelry trade and can invest about \$5,000 in an old established manufacturing jewelry concern of A1 reputation. Address "Maiden Lane, 6228," care Jewelers' Circular-Weekly.

**\$7,000** will purchase an interest in a retail jewelry business; established, well and favorably known; located in one of the most prosperous cities of 200,000 inhabitants in the United States. Address "Rare Opportunity, 6341," care Jewelers' Circular-Weekly.

**CASH PAID** for entire jewelry stores and stocks; send us your surplus stock, and we will send you a check by return mail; if our offer is unsatisfactory we return your goods; we act quickly and strictly confidential. Jos. Brown & Co., Fifth Ave. and Madison St., Chicago, Ill.

**FOR SALE,** first class factory, for manufacture of rings; valuable good will and large line of customers free; full line or part of samples below cost; office fixtures, traveling outfits, safes and all machinery and tools at very low figure. Address "Mark, 6255," care Jewelers' Circular-Weekly.

**DO YOU WISH TO RETIRE?** We buy jewelry stores to any amount; also entire stocks of jewelry, diamonds, watches, silverware, fixtures, etc.; we are known all over the United States to pay highest spot cash; notify us, we will call on you at once; all business transacted we handle strictly confidential. Address Brooklyn Purchasing Syndicate, 608 Broadway, Brooklyn, N. Y., or Tel. 2328, Williamsburg.

**For Sale.**

**AUTOMOBILE FOR SALE;** 16 horse power; in first class condition; will hold five people; will take diamonds in exchange. L. Simon, 525 Fulton St., Brooklyn, N. Y.

**FOR SALE,** at 50 cents on the dollar, 135 purple lined trays. Address Albert Pfeifer & Bro., Little Rock, Ark.

**FOR SALE;** first class ring factory; in perfect running order; electric motor and all machinery as a whole or in parts; will sell cheap to save rent. Address "Electric, 6254," care Jewelers' Circular-Weekly.

**FOR SALE,** a job lot of diamond jewelry bought at bankrupt sale, consisting of cluster brooches, scarfpins and rings; sent on memo. bill to well rated jewelers; prices will surprise you; get my advice, where to buy or sell; it costs you nothing. Dan I. Murray, Broker, 3 Maiden Lane, New York.

**Wanted to Purchase.**

**CASH** for any size Elgin, Waltham, Seth Thomas, glass, brass and tin movement boxes, any kind, glass front and back shipping cases; Howard, Waltham, silk-lined mahogany boxes; write with description of what you have. Chas. Walls, 63 Morris St., Springfield, Mass.

**To Let.**

**DESK ROOM** or part of office to let. 3 Maiden Lane, Room 53, New York.

**PART OF OFFICE** to let, for engraver or watchmaker. S. Hess, 65 Nassau St., New York.

**TO RENT;** very desirable office; third floor; north light; Broadway front. Apply to David C. Townsend & Co., 170 Broadway, New York.

**TO LET,** part of an exceptionally desirable office, with fine north light; opportunity for precious stone business or manufacturing agent. Room 48, Lorsch Bldg., 37 Maiden Lane, New York.

**PART OF OFFICE** to lease; good light; suitable for watchmaker, diamond broker or dealer in precious stones; desk, chairs and shelf furnished. Address "Cockcroft Building, 6248," care Jewelers' Circular-Weekly.

**PART** of large, light office for jewelry or kindred trade. Louis Stern & Co., Lorsch Bldg., 37 Maiden Lane, New York.

**WILL RENT** to desirable party, desk room with office privileges, in light attractive office; manufacturer's representative or diamond dealer preferred. "Maiden Lane, 6368," care Jewelers' Circular-Weekly.

**Miscellaneous.**

**SOMETHING** entirely new in the line of window decoration; send five two-cent stamps for sample and postage. Address The Window Exhibitor Co., 74 Cortlandt St., New York.

**Desirable Factory Space,**  
17 John Street, New York.

Very reasonable. Power furnished. Apply to

**WM. A. WHITE & SONS,**  
62 Cedar Street, N. Y.

**TO LET.**

**Three Desirable Light Lofts**  
At 31 MAIDEN LANE, N. Y.,

One door from Nassau St. Prominent location, center of jewelry district. Address F. J. Whiton, 130 Broadway, New York; or, your own broker.

**Summer Residence for Rent**

during July and August, at Montclair, N. J.; beautifully situated; contains 11 rooms and 2 bathrooms; handsomely furnished; also use of team of fine horses, 3 carriages, coachman, etc.; unusual opportunity for desirable party. Address "Montclair, 6366," care Jewelers' Circular-Weekly.

**An Indispensable Book**  
**FOR MANUFACTURERS, JOBBERS**  
**AND RETAILERS ALIKE IS**  
**TRADE-MARKS**  
OF THE  
**JEWELRY and KINDRED TRADES,**  
**PRICE \$3.00.**

**PUBLISHED BY**  
**THE JEWELERS' CIRCULAR PUB. CO.,**  
11 John St., Cor. Broadway, New York.

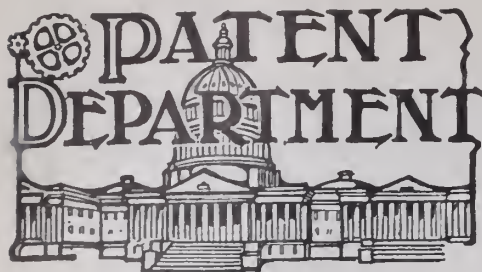

[IN WHICH IS CONTAINED A LIST OF THE LATEST PATENTS GRANTED BY THE UNITED STATES AND GREAT BRITAIN, THE UNITED STATES PATENTS THAT HAVE EXPIRED AND THE REGISTERED TRADE-MARKS.]

UNITED STATES PATENTS.

ISSUE OF MAY 15, 1906.

**820,494. EYEGGLASS-MOUNTING.** CHARLES A. HOFFMAN, Minneapolis, Minn. Filed Nov. 14, 1904. Serial No. 232,576.

In an eyeglass-mounting, a bridge and nose-guards formed from a single piece of metal, the middle portion of which is curved to form the



bridge and provided with forwardly-extending end loops, the ends of said loops being inwardly turned and extended rearwardly substantially parallel with one another to form the guards and finger-pieces projecting forwardly from said ends.

**820,532. BUTTON.** IRVING M. SYLVESTER, Providence, R. I., assignor to Parks Bros. & Rogers, Providence, R. I. Filed Jan. 17, 1906. Serial No. 296,459.

In a button of the type set forth, the combination with a base, of a bar provided with a



knurled upper end, a sleeve frictionally mounted upon the knurled end of the bar, and a hollow button-head provided with an opening in its lower wall, into which said sleeve is received and forced as a driving fit.

**820,533. COMB AND COMB-CLEANER COMBINED.** CLARENCE W. TAYLOR, Oak Park, Ill. Filed Aug. 19, 1905. Serial No. 274,948.

The combination with a comb having a depression in one surface near each end thereof, of a cleaner the major portion of its length embracing only one side of the comb and having projections

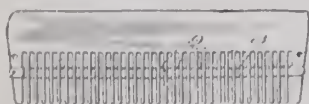

disposed between the teeth of the comb, the end portions of said cleaner being suitably formed to bear only upon the opposite side of the comb and removably engage said depression to secure the cleaner to the comb.

**820,534. COMB AND COMB-CLEANER COMBINED.** CLARENCE W. TAYLOR, Oak Park, Ill. Filed Nov. 8, 1905. Serial No. 286,350.

The combination with a comb having a depression in one lateral surface near each end thereof, of a cleaner comprising a side-embracing member



the major portion of its length embracing only one side of the comb and a perforated member adapted to receive the teeth of the comb, said cleaner having its entire end portions 11 formed to pass between the end and first tooth of the

comb, and the end portions 12 formed to bear only upon the opposite side of the comb and having beads 13 for spring engagement with said depressions to removably secure the cleaner to the comb.

**820,621. MIRROR.** CARL BOMEISLER, New York. Filed Feb. 27, 1905. Serial No. 247,422.

A holder for mirrors and similar articles comprising a frame adapted to hold a mirror and a

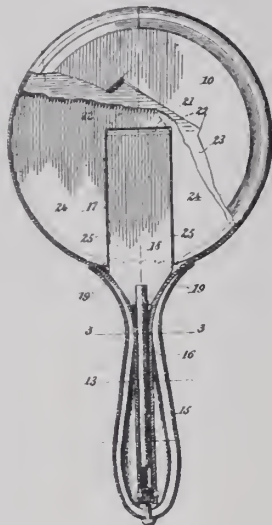

back, a handle for said frame, and a reinforcement secured to said handle having its free end extending into said frame and bearing against the opposing surfaces of said mirror and back.

**820,625. HAIR-PIN.** JUNSON COOK, Philadelphia, Pa. Filed June 19, 1905. Serial No. 265,897.

A hair-pin comprising a relatively short loop-shaped shank having a lateral projection at its top, a pair of relatively long and straight tines, and a pair of V-shaped projections connecting



the said shank with the said tines, said projections being arranged opposite each other in the same plane and having a narrow space between their apices, and the lower parts of the said projections being straight and arranged at an acute angle with each other.

**820,645. BRACELET.** ROY W. INMAN, Attleboro, Mass., assignor to John T. Inman, Attleboro, Mass. Filed May 24, 1905. Serial No. 262,010.

A bracelet having overlapping ends connected by

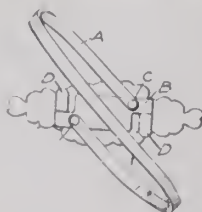

a link hinged thereto, and means for holding each overlapping end portion in engagement with both ends of said link.

**820,669. CLOCK.** WILSON E. PORTER, New Haven, Conn., assignor to the New Haven Clock Co., New Haven, Conn. Filed Sept. 11, 1905. Serial No. 277,917.

In a clock-movement, the combination with front, rear and intermediate movement-plates, of

a center arbor journaled at its front end in the said front movement-plate, a mainspring-arbor arranged concentrically with the said center arbor and having its rear end journaled in the said rear movement-plate and its forward end formed with a trunnion journaled in the said in-

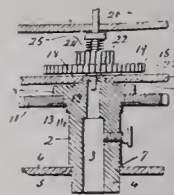

intermediate movement-plate, the said trunnion being formed with a bearing-opening for the reception of the rear end of the said center arbor which is thus journaled directly in the said main spring arbor which has a longitudinal passage to the center arbor for setting the hands and which is adapted to be rotated for winding the main spring.

**820,682. BUTTON OR STUD.** IRVING M. SYLVESTER, Providence, R. I., assignor to Park Bros. & Rogers, Providence, R. I. Filed June 12, 1905. Serial No. 264,843.

A stud comprising a head, a tubular L-shaped stem and shoe formed integral with one another and secured to said head, said stem being forme



with an opening c<sup>1</sup>, adjacent its juncture with the shoe, a locking-bar slidably mounted in the shoe, said locking-bar having a pointed end projecting beyond the end of the shoe and having its other end projecting through opening c<sup>1</sup>, said bar having a longitudinal flattened surface formed with notches, a plunger slidably mounted in the stem and having its end shaped to engage in said notches of the bar, and a coil-spring secured on the end of the plunger and engaging said head.

**820,683. STUD OR BUTTON.** IRVING M. SYLVESTER, Providence, R. I., assignor to Park Bros. & Rogers, Providence, R. I. Filed June 12, 1905. Serial No. 264,844.

In a pipe-stem stud, a head, a hollow L-shaped shank forming a tubular stem and shoe, a locking-bar formed with annular grooves extendi



in said shoe, said shoe being formed with a pair of longitudinal parallel closely-associated slits intermediate its length, which slits extend to and adjacent the ends of said shoe, the material between said slits forming a snap supported by each of its ends from said shoe, said snap having a length to engage in said grooves of the locking bar.

**820,729. COLLAR OR CUFF BUTTON.** DANNE PAMP, Philadelphia, Pa. Filed July 21, 1905. Serial No. 266,250.

In a button of the character described, a body portion, a shank extending from said body portion, a spring-eye formed in the outer end



the shank, the walls of said spring-eye adapted to spring away from one another, a head, tongue formed with the head, said tongue being enlarged at its outer end so as to spread, the walls of the eye where it passes through the tongue being formed narrow behind the outer end so that it will fit within the eye with spreading the walls thereof.

**820,777. CIGAR AND CIGARETTE HOLDER.** GEORGE GRICE and CHARLES J. BARROW, Birmingham, England. Filed Dec. 18, 1905. Serial No. 292,373.

A cigar or cigarette holder comprising a hole



body, a tube located centrally thereof, and means



consisting of a perforated cap for securing the tube to the holder.

**820,794. BARREL CLICK-SPRING FOR TIME-PIECES.** JOSEPH KLEIN, Peru, Ill., assignor to the Western Clock Mfg. Co., La Salle, Ill. Filed Aug. 19, 1905. Serial No. 274,940. In a click-spring for timepieces, a movement-plate; two winding barrels journaled in said plate;

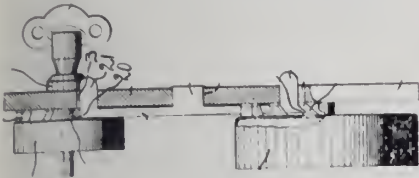

a metal strip fastened to said plate by means of its central side projection; two side projections from said strip, each passing through an aperture in said plate and two end projections each of which engages the teeth of one of the barrels.

**820,860. COMBINED MATCH AND CIGARETTE BOX.** LOUIS DE GOLL, Baltimore, Md. Filed May 22, 1905. Serial No. 261,641. A box provided with a partition dividing it into two chambers, one for the reception of matches, and the other for the reception of cigarettes, a



cover pivoted near one end to said box, said cover being provided over the match-holding chamber with a delivery-hole and an inclined trough leading to said hole, and resilient means for holding the cover closed.

**820,894. TIME CHECK OR RECORDER.** LESLIE M. SOBER and ELMER E. BROWN, Oklahoma, Okla.; said Brown assignor to James L. McCune, Oklahoma, Okla. Filed June 12, 1905. Serial No. 264,855.

In a time-check and recording mechanism, a casing having a desk portion, a series of dating-wheels, clock mechanism for setting said wheels, said desk portion of the casing including a removable top having an aperture and a transparent portion, a plate held under said top aperture, means

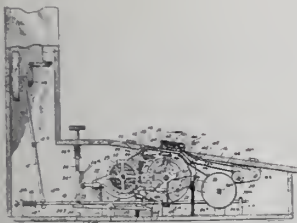

for moving a record-receiving strip over said plate and said wheels, a supplemental segmental wheel having peripheral characters, a carbon-ribbon held over said paper in line with all of said wheels, means for setting said supplemental wheel to bring a predetermined portion of its circumference in line with said plate, means co-operating with supplemental-wheel-setting means, for pressing the ribbon and the record-receiving strip against the several wheels, and means, co-operating with said supplemental-wheel-setting means and said pressing means, for moving said strip with the record from under the top aperture and under the transparent portion of the top.

**820,897. COFFEE AND TEA POT.** JOSEPH W.

WHITAKER, Noble, Ill. Filed July 17, 1905. Serial No. 270,022.

A coffee or tea pot consisting of a body portion having its wall slightly tapered toward its bottom, a cover, and a close-fitting open-bottom removable cylindrical collecting-holder having a strainer-top, a central bracing-handle extending through said top and holder, and bracing-arms connecting the

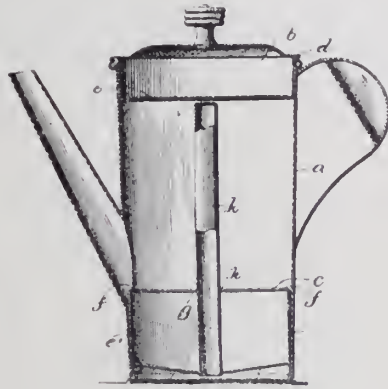

handle and the peripheral walls of the holder at the bottom of the holder.

**820,916. SPEED-INDICATOR FOR VEHICLES, ETC.** CHARLES COULERU-MEURI, Chaux-de-Fonds, Switzerland, assignor to Flory, Reimpach & Co., Colchester, Eng. Filed Oct. 6, 1904. Serial No. 227,421.

A speed-indicator for vehicles adapted to be operated during a definite period of time and proportional to the average speed of the vehicle for that time, means adapted to be connected to a

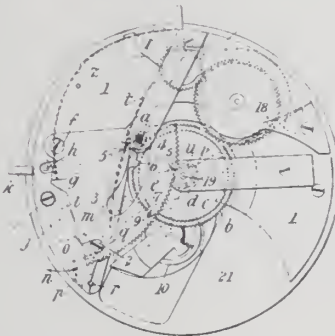

wheel of the vehicle for actuating the indicator mechanism, and index-finger, a sector for returning said index-finger to zero, locking devices for the index-finger and indicator mechanism, means for releasing said locking devices, and a spring-actuated lever adapted to again bring said locking devices into engagement after a definite period of time.

DESIGNS.

**38,010. BADGE.** PAUL GIBSON BLANFORD, Portsmouth, Va. Filed April 4, 1906. Serial No.



309,944. Term of patent 3 1/2 years. **38,011. CLOCK-FRAME.** STANLEY M. LAWSON,

Cincinnati, O. Filed March 28, 1906. Serial



No. 308,624. Term of patent 3 1/2 years.

**38,012. GLASS VESSEL.** JOHN OWENS, Wheeling, W. Va., assignor to the Imperial Glass



Co., Bellaire, O. Filed April 7, 1896. Serial No. 310,581. Term of patent 3 1/2 years.

UNITED STATES TRADE-MARKS.

[The following trade-marks have been adjudged entitled to registration under the Act of Feb. 20, 1905, and are published by the Patent Office in compliance with Sec. 6, of said act, which provides: "Any person who believes he would be damaged by the registration of a mark may oppose the same by filing notice of opposition, stating the grounds therefor, in the Patent Office, within 30 days after the publication of the mark sought to be registered, which said notice of opposition shall be verified by the person filing the same before one of the officers mentioned in Sec. 2, of this act. If no notice of opposition is filed within said time the Commissioner shall issue a certificate of registration therefor, as hereinafter provided for."]

PUBLISHED MAY 15, 1906

SER. No. **4,407. GOLD AND SILVER FLAT WARE, HOLLOW WARE AND TABLE WARE.** WILLIAM LINKER, Philadelphia, Pa. Filed May 5, 1905.



The conventional representation of a fleur-de-lis. SER. No. **12,024. HAT-PINS, COMBS AND HAIR-PINS OF GOLD.** KREMENTZ & Co., Newark, N. J. Filed Aug. 26, 1905.



A figure having substantially the parts of an anchor—a shank, a stock, and two arms curled oppositely to each other.

SER. No. **15,169. METAL WARE FOR TABLE USE COMPOSED IN WHOLE OR IN PART OF GOLD OR SILVER OR BOTH OF SUCH METALS.** TIFFANY & Co., New York. Filed Dec. 4, 1905. Used 10 years.

TIFFANY & Co

The word, character and abbreviation, TIFFANY & Co.

SER. No. **15,508. HAIR-PINS AND ORNAMENTAL COMBS.** WILLIAM D. EARL, Leominster, Mass. Filed Dec. 19, 1905.



The word "OSOSMOOTH."

SER. No. **15,536. CILMINS, NECKLACES AND**

FOBS. KREMENTZ & Co., Newark, N. J. Filed Dec. 20, 1905.



A figure, having substantially the parts of an anchor, a shank, a stock, and two arms curled oppositely to each other.

SER. NO. 18,314. WATCHES AND PARTS THEREOF. DUBOIS WATCH CASE CO., New York. Filed March 28, 1906.



A floral design, each flower being represented in the shape of the letter D.

SER. NO. 18,580. CARVING-KNIVES. LANDERS, FRARY & CLARK, New Britain, Conn. Filed April 6, 1906. Used 10 years.



The representation of a simitar of an extremely-curved form, together with a representation of a star in the space between the two ends of the curved simitar. In connection therewith the word DAMASCUS is placed on the blade and the letters L. F. & C. in the space inclosed by simitar and star.

TRADE-MARKS REGISTERED MAY 15, 1906.

62,061. SILVER-POLISH IN LIQUID. POWDER OR PASTE FORM. GORHAM MFG. CO., Providence, R. I.

The words "GORHAM SILVER POLISH." Used 10 years.

Filed Nov. 15, 1905. Serial No. 14,666. Published March 20, 1906.

62,095. POLISHING AND CLEANSING PREPARATIONS. LOUIS HAUCK, New York.

The word "ULAKA." Filed Dec. 5, 1905. Serial No 15,223 Published March 20, 1906.

62,719. PORCELAIN WARE OF ALL KINDS. ADOLF HAMANN, Dresden, Germany.

The representation of an electoral hat, accompanied by and arranged over the word "DRESDEN." Filed July 25, 1905. Serial No. 10,775. Published March 20, 1906.

62,721. SILVER-PLATED HOLLOW WARE, FLAT WARE AND TABLE WARE. HILBARD, SPENCER, BARTLETT & Co., Chicago.

The word "REV-O-NOC" and the letters, character and abbreviation "H. S. B. & Co." Filed Oct. 13, 1905. Serial No. 13,581. Published March 20, 1906.

62,724. SILVER-PLATED HOLLOW WARE, FLAT WARE AND TABLE WARE. HILBARD, SPENCER, BARTLETT & Co., Chicago.

The coined word "HIBSPBAR." Filed Oct. 21, 1905. Serial No. 13,812. Published March 20, 1906.

62,749. CLOCKS. YEAR CLOCK CO., Mohnt Vernon, N. Y.

The capital letter "Y" flanked on its respective sides by the words "New" and "York" and having above the same the words and abbreviation "YEAR-CLOCK Co."

Filed Sept. 2, 1905. Serial No. 12,164. Published March 20, 1906.

62,752. POCKET KNIVES. GRAEF & SCHMIDT, New York.

The representation of a spider's web with a spider thereupon.

Filed Aug. 16, 1905. Serial No. 11,691. Published March 20, 1906.

62,757. SILVER PLATED HOLLOW WARE. INTERNATIONAL SILVER CO., Meriden, Conn.

The words "AMERICAN SILVER PLATE Co." disposed around a circle inclosing the word "QUADRUPLE." Used 10 years.

Filed Nov. 10, 1905. Serial No. 11,477. Published March 20, 1906.

62,824. RINGS. WARREN & WILLIAMS, Providence, R. I.

The monogram "W W" and the character "&" arranged just above the center of the monogram.

Filed Feb. 17, 1906. Serial No. 17,138. Published March 20, 1906.

BRITISH PATENTS.

(ABRIDGMENTS OF SPECIFICATIONS, 1905, FROM THE Illustrated Official Journal.)

ISSUE OF MAY 2, 1906.

37. INDICATING RULING PLANETS. W. H. LEWIS, Manchester, N. H., U. S. Jan. 2.

A planetary hour dial, indicating also times of sunrise and sunset, is constructed as shown, with planetary signs arranged in circles on a rotatable disk D and ring F. Tables B are placed outside the hour dial showing on it the times of sunrise and sunset for a particular latitude, and the disk D which is adapted to show planetary hours also

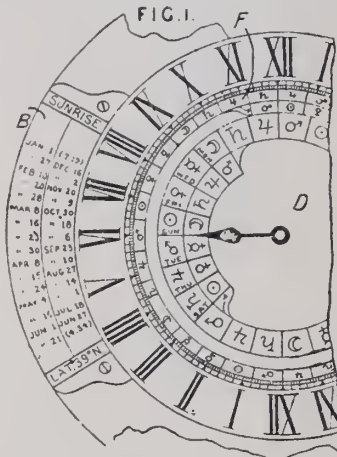

hears the names of the days of the week. The ring F is divided into spaces corresponding to four-minute intervals, and is for indicating the sub-planetary influences. The device is shown set for any Sunday near March 23 or Oct. 6, Jupiter being the ruling planet shown by the disk, while the ring shows subplanetary influences for various four-minute intervals. A 12-hour dial may be used instead of the 24-hour dial shown.

52. INDICATORS, STATION, ETC. R. ORNSTEIN, Berlin, and P. DORFF, Schlachtensee, near Berlin. Jan. 2. No patent granted (sealing fee not paid.)

A station indicator for cars, etc., comprises a dial, provided with hour divisions and displaying the names of stations on the route and any other desired information, and a hand driven by clockwork in such a way that in pointing to the time it

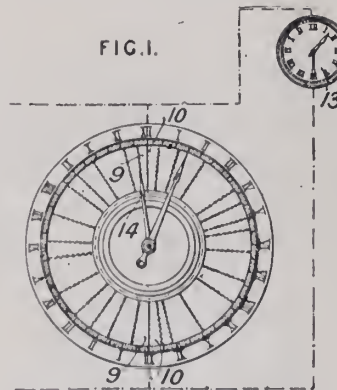

also indicates the locality of the car. A series of such indicators may be controlled electrically from a standard clock 13. The names of the stations may be placed upon two removable parts, 9, 10, which may be of distinctive colors, or one may be phosphorescent for use at night. A second index-hand 11, which may be set independently of the first hand, serves to indicate whether, and how much, the car is before or behind time.

122. SAFEGUARDING PURSES, ETC. J. C. B. TOWNSEND, Folkestone, Jan. 3.

A purse, pouch, handbag, or the like A, Figs. 1 and 2, is attached to wearing apparel by means of the safety-pin e, with the spring portion e' on the purse, etc., frame and its point engaging within the inturred portion f' of the catch I. The purse, etc., is concealed by a rosette, flowers, etc., sup-

ported on the shield or plaque a, flexibly attached by spring arms b terminating in hooks c engaging sockets d, or by springs g. Fig. 3, connected to

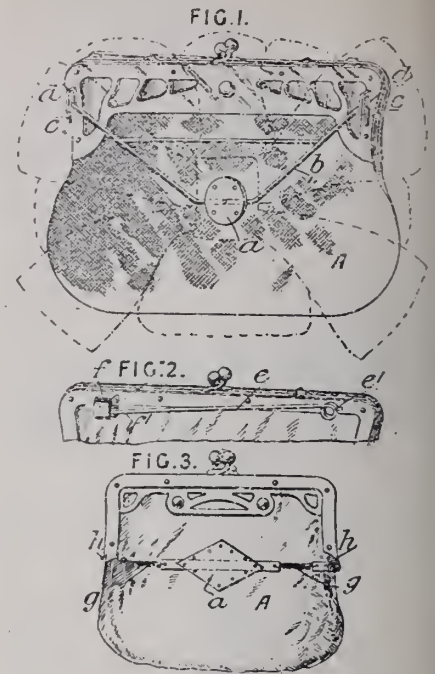

pieces h mounted on the hinge-pins of the purse, etc., frame. With this latter form, the safety-pin may be mounted on a bar joining these pieces h at the back.

193. WATCH, ETC., PROTECTORS. M. GORDON, South Wimbledon, Surrey, Jan. 4.

A protector for pendent watches, etc., consists of a bar A, to which a safety-pin B is hinged, and from the center of which a number of bars F, D, E, radiate, these bars being bent forward at their ends to form claws. One or more claws J with ring, safety-pin, etc., K, are provided as a further protection. Three arms may be employed, two of

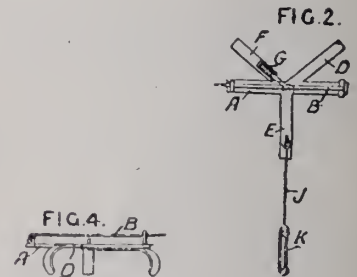

which D, E may be fixed and the third F pivoted and adjustable in length, a spring G controlling the motion of its end. Alternately, the third arm may be fixed in length but pivoted eccentrically to a central enlargement. In another form, all three arms are fixed, two being formed by the safety-pin bar, and the third projecting vertically downwards. Or two fixed arms only may be used, sloping downwards from the center of the safety-pin bar.

214. SCARF-PIN GUARDS. W. H. WHEATLEY, London, W. C.—(C. Nobs, Newark, N. J., U. S.) Jan. 4.

Pins, Scarf, Brooches, Jewelry Fastenings.—A guard for a scarf or brooch pin consists of two metal fingers 1, Figs. 1 and 2, passing through apertures in a spring 8, and encircling a pivot 6.

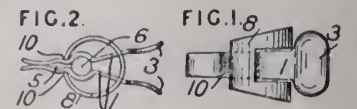

The scarf or brooch pin is gripped in the space 5 enclosed by the indented portions, and the device is actuated by pressing the ends of the parts 3 between the fingers of the wearer. The ends 10

of the spring press against the fingers 1, and retain the pin in position.

**249. EYEGLASSES.** M. WEISSMANN, London, E. C. Jan. 5.

The collets *c*, between which the spring *b* is placed, are secured by pressing the lips *d* into nicks

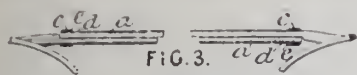

FIG. 3.

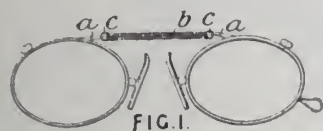

FIG. 1.

on notches *e* on the sliding bars *a*, and the ends of the spring are passed into the collets or into depressions in the bars.

**318. DRESS PINS.** C. MANCHESTER, Nottingham, Jan. 6.

Pins, dress and like, are made with two straight or corrugated prongs *A*<sup>1</sup> and an ornamental head *B*.

[Reference has been directed under Patents Act,

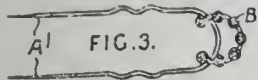

FIG. 3.

1902, to Specifications No. 13,395, A.D. 1895; No. 15,929, A.D. 1895, and No. 3623, A.D. 1900.]

**319. TELESCOPES AND RANGE-FINDERS.** F. W. ALLEN, Leicester, Jan. 6.

To enable a range-keeping telescope, particularly of the kind described in Specification No. 17,209, A.D. 1902, to be used also as a sighting-telescope for heavy ordnance, the magnify-power is changed quickly by a removable system of lenses. Fig. 3 shows a removable system of lenses 16, 17, 18, similar to an opera-glass system, arranged between an eye-piece of the Ramsden type 5, 6, and an erecting eye-piece 9, 10. The convex lenses 5, 6, are mounted in a tube 8 and the focus of the system coincides with that of the object glass 7. The

FIG. 2.

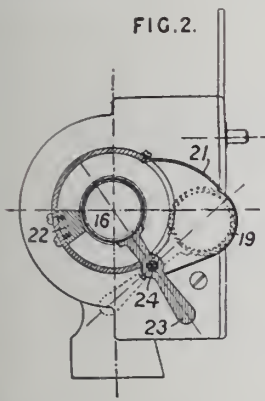
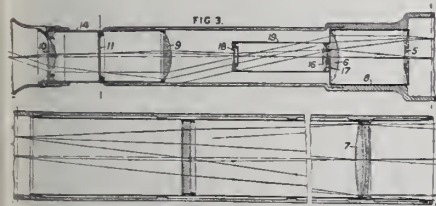

FIG. 3.



convex lenses 9, 10, are mounted in a tube 14 and have a common focus at which is arranged a piece of plane glass 11, with a vertical wire or line and a horizontal arrow head to facilitate sighting. The lenses 16, 17, 18 are shown mounted in a thin metal tube 19 which may be moved out of action into a light-proof casing 21, Fig. 2, by a handle 23 pivoted at 24. When brought into operation, the correct position of these lenses is determined by a stop 22 secured to the telescope casing by screws.

Complete specifications accepted April 25, 1906. 1905.

**328. PURSE.** SKINNER.

**16,610. MATCH BOX.** YARDLEY.

**19,131. TIME-RECORDER.** PLASSCHAERT.

**22,209. PIN.** JEE.

**25,599. BUCKLE.** WALL.

1906.

**3,499. STUD.** GUBBINS.

**3,656. PENHOLDER.** THOMSEN.

**5,442. HAIR CURLER.** HOLSTE.

**5,949. BROOCH-PIN.** EDMOND.

Applications filed April 17 to April 21, 1906.

**9,448. NECKTIE FASTENING.** MARTHA LAMING, London.

**9,447. SHIELD FOR HAT-PIN POINTS.** PHILIP MAHONEY and S. G. HUNT, Bishops-ton, Bristol. Complete specification.

**9,484. HAIR-PIN.** H. W. GITTINS, London.

**9,216. SPOUT FOR TEA OR COFFEE POTS.** L. C. HOWLDFN and GEORGE WILSON, Shar-row, Sheffield.

**9,249. COLLAR SUPPORT.** L. F. BRENNER, London.

**9,263. SUSPENDERS.** C. W. THOMPSON, London.

**9,303. HAIR-PIN.** W. C. J. SCHLIE, Glasgow.

**9,353 and 9,354. VEIL HOLDERS.** WILLIAM ZIESENIS, London. Complete specifications.

**9,356. DIAL.** EMILE LAINE, London. Complete specification.

**9,427. CLOCKS AND WATCHES.** JOSEPH EISENMANN and A. H. SANDER, Finsbury, London.

**UNITED STATES PATENTS THAT HAVE EXPIRED.**

[Reported especially for THE JEWELERS' CIRCULAR-WEEKLY by R. W. Bishop, Patent Attorney, Washington, D. C.]

Issued May 14, 1889.

**403,100. ELECTRIC ALARM-CLOCK.** T. H. GRADY, New York.

**403,112. RING.** FREDERICK KAFFEMAN, New York.

**403,190. PENHOLDER.** A. S. HUBBELL, Nor-wich, Conn.

**403,211. MAGNETIC SHIELD FOR WATCHES.** H. P. PRATT, Chicago.

**403,220. BELT-SUPPORTER.** LOUIS SANDERS, Brooklyn, N. Y., assignor to Eliza Sanders, same place.

**403,225. FOUNTAIN-PEN.** L. A. SHATTUCK, Bloomsburg, Pa.

**403,230. SUSPENDERS.** E. B. STIMPSON, Brooklyn, N. Y.

**403,263. BUCKLE.** AUGUST GOERTZ, Newark, N. J.

**403,274. ALARM-CLOCK.** A. M. LANE, Meriden, Conn.

**403,275. STRIKING MECHANISM.** A. M. LANE, Meriden, Conn.

**403,280. CUFF-RETAINER.** J. M. MARCH, Phoenixville, Pa.

**403,286. CALL-BELL.** E. H. PECK, Meriden, Conn., assignor to the Meriden Bronze Co., same place.

**403,338. DIAL.** AUGUST FISCHER, White Hall, Ill., assignor of one-half to J. F. Potts, same place.

**403,469. BUCKLE.** J. H. HARRELL, Washington, D. C.

**403,477. BUTTON.** R. H. LEWIS, Providence R. I., assignor to Albert Eddy, same place.

**30,754. HOOK-PIN.** J. A. PRIEST, Utica, N. Y.

**30,755. NECKTIE-HOLDER.** MARGARET CUN-NINGHAM, Philadelphia, Pa.

**30,777. SUPPORTING-BASE.** W. W. GALLI-MORE, Trenton, N. J., assignor to the Amer-ican Lamp and Brass Co., same place.

Designs issued Nov. 11, 1902, for 3 1/2 years.

**36,135. STATUETTE.** L. V. ARONSON, Newark, N. J.

**36,137. BRUSH-BACK.** W. F. MARSHALL, North Attleboro, Mass, assignor to the J. E. Blake Co., of Rhode Island.

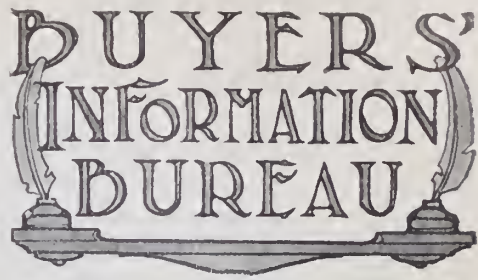

Questions as to the makers of certain lines of goods, where to buy certain lines, where certain kinds of work are done, the owners of certain trade-marks and other matters relating to the buying branch of a jewelry business will be cheerfully answered under this department. All queries are also answered promptly by mail.

AKRON, O., April 24, 1906.

Editor of THE JEWELERS' CIRCULAR-WEEKLY: Who makes the Patrician pattern in sterling silverware? F. L. & C. Co.

ANSWER:—Jos. Seymour Mfg. Co., Syracuse, N. Y.

HAMILTON, O., April 30, 1906.

Editor of THE JEWELERS' CIRCULAR-WEEKLY: Where can I secure the marble statuette of "Powers's Greek Slave?"

ANSWER:—Ferdinand Bing & Co.'s Successors, 10 Washington Place, New York.

CHILLICOTHE, O., April 8, 1906.

Editor of THE JEWELERS' CIRCULAR-WEEKLY: Can you inform us where we can get a figure such as described on page 98 of your issue of April 4, "The Little Man in the Window?"

O. J. F. ANSWER:—National Cash Register Co., Dayton, O.

TACOMA, Wash., April 14, 1906.

Editor of THE JEWELERS' CIRCULAR-WEEKLY: Can you tell me who is the agent for the Nardin watches? A. M.

ANSWER:—R. Newburgh, 12 John St., New York.

LITTLE FALLS, April 14, 1906.

Editor of THE JEWELERS' CIRCULAR-WEEKLY: Will you kindly give us the name of the firm who makes the Lafayette pattern in silver spoons? G. A. O. S.

ANSWER:—The Roger Williams Silver Co., Providence, R. I., make a sterling pattern of that name, and the Benedict Mfg. Co., East Syracuse, N. Y., make one in plated ware.

CHICAGO, April 16, 1906.

Editor of THE JEWELERS' CIRCULAR-WEEKLY: Please inform us who is the importer of a square eight-day watch. B. & Co.

ANSWER:—Klipper Bros., 59 Maiden Lane, New York.

ST. AUGUSTINE, Fla., April 20, 1906.

Editor of THE JEWELERS' CIRCULAR-WEEKLY: Can you tell us the address of the firm manufacturing birth-flower baby pins? I. J. F. K. C.

ANSWER:—Henry Freund & Bro., 9 Maiden Lane, New York.

IOWA CITY, Ia., April 23, 1906.

Editor of THE JEWELERS' CIRCULAR-WEEKLY: Can you tell me where I can buy Sheffield plate and who is the jobber in this country? S. T. M.

ANSWER:—Samuel Buckley & Co., 100 William St., New York.

NEW YORK, May 10, 1906.

Editor of THE JEWELERS' CIRCULAR-WEEKLY: Who manufactures rolled gold Perex convex spectacles? S. H. & Co.

ANSWER:—Spencer Optical Co., 12 Maiden Lane, New York.

# WALTHAM WATCHES

---

We beg to announce the issuing of the following described 16 size movements:

## 16 SIZE, $\frac{3}{4}$ PLATE, S. W. MOVEMENTS

LEVER SETTING

OPEN FACE .

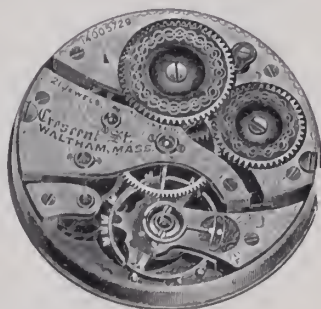

Crescent St., Nickel;

21 Fine Ruby Jewels; Raised Gold Settings; Jewel Pin Set without Shellac; Double Roller Escapement; Steel Escape Wheel; Exposed Sapphire Pallets; Compensating Balance, Adjusted to Temperature, Isochronism and Five Positions; Patent Breguet Hairspring, Hardened and Tempered in Form; Patent Micrometric Regulator; Tempered Steel Safety Barrel; Exposed Winding Wheels; Double Sunk Dial.

---

**AMERICAN WALTHAM WATCH CO.,**  
**WALTHAM. MASS.**

# THE HOROLOGICAL REVIEW.



## How Father Knickerbocker Marks *the* Hours

Prominent Clocks That Give the Time to New Yorkers in Manhattan, Brooklyn and the Bronx.

(Continued from issue of May 16.)

### BROOKLYN'S CONSPICUOUS CLOCKS.

THE center of activity of New York's Borough of Brooklyn is considered by most of its citizens to be found in close proximity to its City Hall. Certain it is that the site of City Hall Square is a focus for the largest aggregation of large time dials within a prescribed space, so far as that borough is concerned.

Compared with the clock tower gracing Manhattan Borough's City Hall, Brooklyn's City Hall clock tower is of both more pretentious style and of larger proportions. From the illustration on this page it will be seen that the design is one that never fails to command respect.

The clock, whose works are of the self-winding variety, has four dials of ground glass, having a diameter of five feet four inches. By an automatic device the lamps which illuminate the dials at night are lit at sunset and the same mechanism extinguishes them at sunrise.

The mechanism which controls the hands is a clock tower movement having for its motive power an electric motor, moving the hands forward every half minute. The necessity for weights and ponderous apparatus is, by this contrivance, entirely obviated, and the risk of breakdown is reduced to a minimum by this simplification of machinery.

The action for this movement is controlled by a self-winding regulator located in the upper hall immediately under the tower. This regulator has an electric contact constructed to close each half minute, thereby starting the above-mentioned clock tower movement. By connection with the time service it receives an hourly correction, whereby the public is afforded exact United States Observatory time. The entire system being automatic, it requires attention but once a year for oiling and cleaning of the several parts.

Surrounding the City Hall clock are a number of dials. That in the Garfield building, from its lofty elevation, proves of considerable value to the traveler on the ele-

vated railroad trains. A very much consulted outdoor timepiece is the big dial in the corner of the building of the Brooklyn *Citizen*, boldly showing the flight of time to the many thousands of passengers passing this intricate junction of so many surface car lines.

A few steps further up Fulton St. bring the pedestrian to the Straus clock,

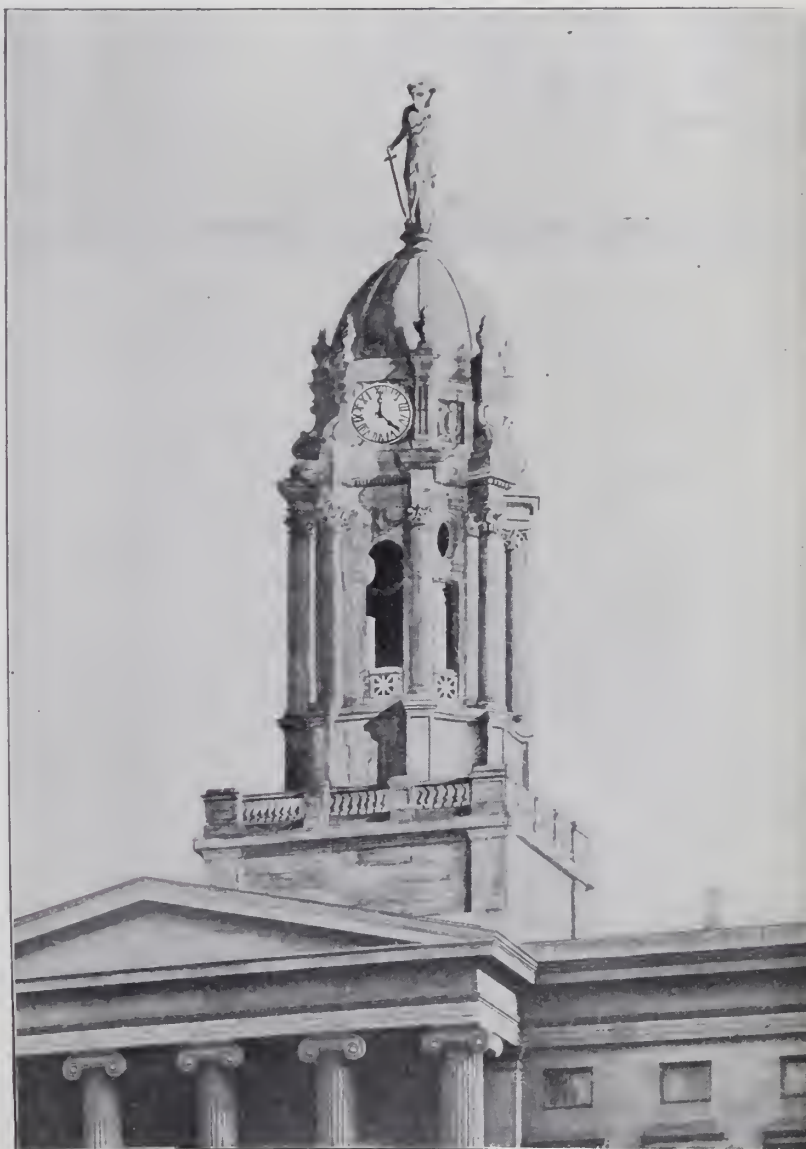

HANDSOME CLOCK TOWER ON TOP OF BROOKLYN CITY HALL.

# Wise Dealers Set Store by the ELGIN



The wide-awake dealer knows the value of a good stock of Elgin Watches. He knows that they are a good criterion by which to have the public judge his store.

He knows that Elgin customers are satisfied customers, and that satisfied customers are the very foundation of successful business. The

## ELGIN WATCH

is the World's Standard Timekeeper

See Jobbers' List for prices or write the Company.

Every dealer is invited to send for the Elgin Art Booklet, "Timemakers and Timekeepers," illustrating the history and development of the watch.

**ELGIN NATIONAL WATCH COMPANY,**

Factories, Elgin, Ill., U. S. A.  
General Offices, 131 Wabash Ave., Chicago.

New York Office, 11 John Street.  
San Francisco Office, 206 Kearny St.

one of Brooklyn's most familiar landmarks, whose four dials are eagerly scanned by the many passing up and down this busy thoroughfare.

On the sidewalks of Montague St. are several sidewalk clocks, all within a stone's throw of City Hall Square. They are the useful advertising features of thriving trust



CLOCK ON THE GARFIELD BUILDING.

companies and real estate agents, with which this section abounds.

Continuing along Fulton St., one comes across the handsome clock in the ornate entrance portico of the big department store



THE STRAU'S FOUR-DIAL STREET CLOCK.

of Abraham & Straus, and at 525 Fulton St., Jeweler L. Simon's clock dial apprises passersby of the time from his store front.

Coming to the junction of De Kalb Ave. and Fulton St., Browning, King & Co.'s clock, set over the show window on the second floor, holds a prominent location, facing the large, triangular open space.

In front of Wm. Wise's Son's store, Ful-

ton St. and Flatbush Ave., stood a clock that in the course of years had made its presence familiar to shoppers in that section. Civilization's progress, in the form

This brings one within sight of the monumental proportions of Brooklyn's highest clock tower, known as the "Smith, Gray Tower." With its 285 feet of elevation, the 15-foot dial of the clock commands a view of the entire vast "City of Churches." The movement that controls the giant hands (the minute hand measures seven feet and the hour hand six feet), is the largest built. Its pendulum is over 14 feet long, with a two-second oscillation. At a distance of no less than three miles the outline of the clock dial is visible with the naked eye, though a glass is necessary to read the time at such a far-off point. The weight controlling this leviathan's works is 450 pounds. Its dial is automatically lighted at sundown by electricity, and is extinguished at sunrise by the same device. The "Smith, Gray Tower clock" has been a Brooklyn landmark since 1898, when the E. Howard Clock Co. installed the gigantic time-keeping mechanism in its lofty location.

On Ryerson St., in that seat of practical learning, the Pratt Institute, is a self-winding mechanism that controls the hands rotating in the dial that looks out onto the public library of that institution. The usefulness of that timepiece is uncontested, instilling, as it does, punctuality (since its installation in 1892), in the adolescent minds of the students who enter the portals of that institution to gain a practical insight into the wage-earning needs in their future careers.

Wandering further into the center of the rapidly growing city, one arrives at the imposing edifice of the Long Island Storage Warehouse. Perched high on the top of this new mammoth structure is a 76-foot bronze tower of refined architectural lines, the apex of which is 186 feet above the sidewalk. Standing on the corner of Nosstrand and Gates Aves., the 66-inch dial of the clock within the tower commands a very extended view of the neighborhood.

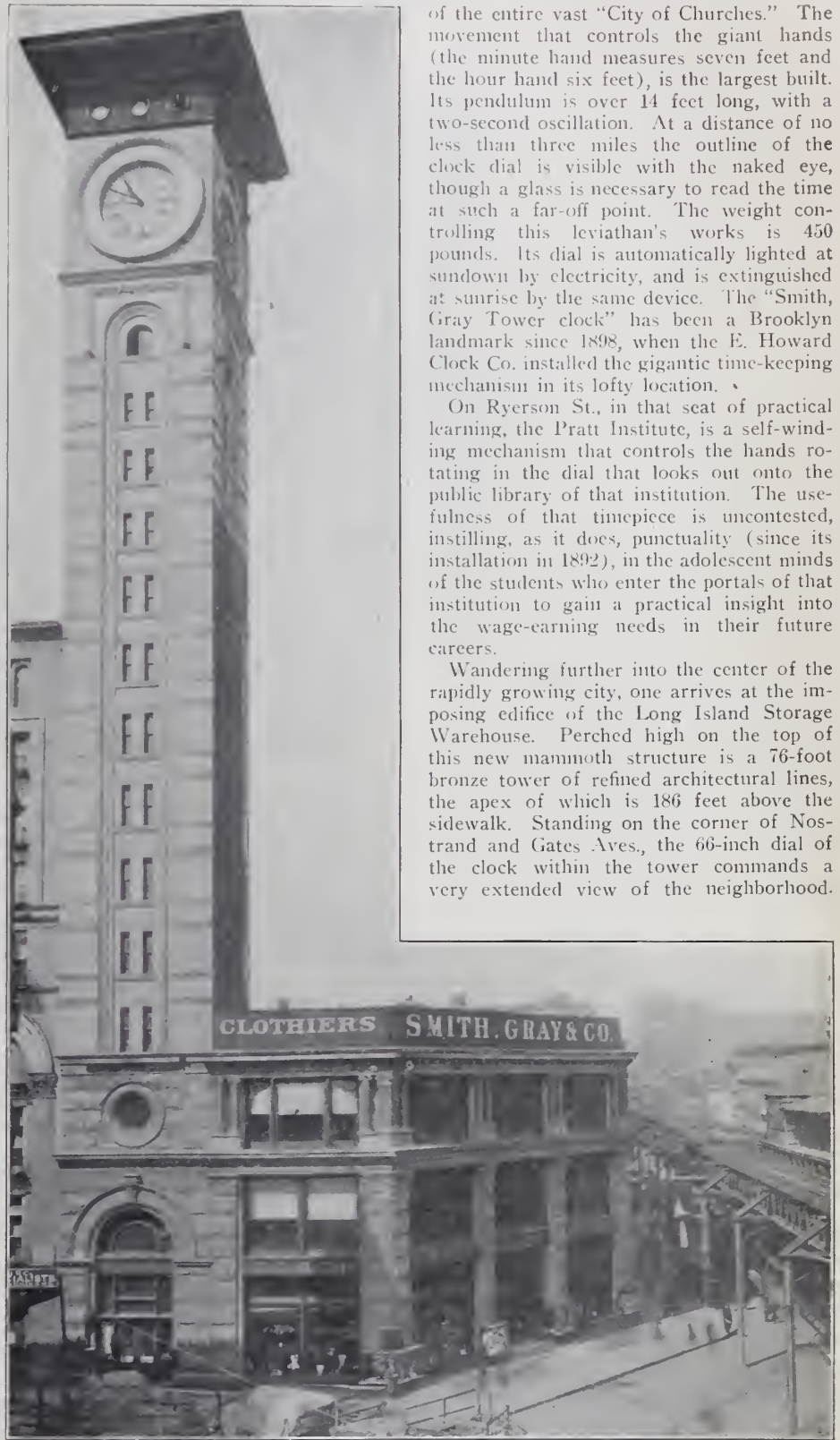

THE GREAT SMITH, GRAY CLOCK TOWER, 285 FEET HIGH, AT FLATBUSH AVE. AND FULTON ST.

of ripping up the street for construction of the rapid transit subway, enforced its banishment, but its career of usefulness will be renewed by its resurrection in the near future.

This 20th century timepiece started on the first of last January and represents the development of horological science in several respects. The mechanism, which is self-winding, is controlled by a master clock



{ Actual size  
of new folder }

There is Satisfaction in Seeing  
what is Being Purchased. The

## Jas. BOSS WATCH CASE

is truly a visible investment.  
Visible to you as a dealer.  
Visible to your customers.

**A NEW FOLDER IS READY—showing the remarkably strong construction and proportion of gold used in BOSS cases. Furnished to all dealers upon request. Dealer's card printed on them without cost. Write for quantity. Address**

DESK C, ADVERTISING DEPT.

## The Keystone Watch Case Co.

PHILADELPHIA

New York  
Chicago

Cincinnati  
San Francisco





## SCREW CASES IN 16 and 18 SIZE

WITH DUST PROOF NUTS

are well worthy of your careful consideration. The CROWN line comprises many new creations in attractive designs, that are sure to merit the approval of fastidious buyers. Quality remains the same. See your jobber.

---

**Philadelphia Watch Case Company,**  
RIVERSIDE, NEW JERSEY

# Let us be Partners

We are advertising the New England Watch to one third of the population of the United States. Next Fall this advertising is going to create a public awakening; is going to cumulatively force business for the Fall and Christmas season, and now, Mr. Jeweler, we want you for a full partner.

Thousands of convinced people are already writing us asking where they can buy the New England Watches. We don't sell to consumers and so we want you to make these sales. We want to refer these inquiries to you, and you get the profits—you make just so many new customers.

We are in earnest about this partnership plan. Your interests are our interests and we are going to work with you and for you. We are sending out men to find out just how we can help the jewelers. We are going to carry out an extensive plan of co-operation with you.

How can we assist you? What can we do to make our partnership more profitable? Write us your suggestions and get the details of our plan.

The New England Watch occupies a field all its own, Mr. Jeweler. It is built distinctly for the general public and advertising is going to make—is making—it the favorite watch of the Great American People.

A letter asking us for our plans will be a letter written in the interest of increased business. Better write it NOW.

## Special Offer To the Jewelry Trade

Commencing May 1, 1906, we withdrew from our price lists enameled watches heretofore shown in lists and catalogues under series "S" (ELF) styles. To clear our stock of enamels in the 10 ligne series "S" (ELF) watches, we offer a rearrangement of this style by substituting our new 4-jewel "SS" movement in place of the 12-jewel "S" movement previously used in this watch. This new movement is a superior time-keeper, and it is fully guaranteed. We have a limited stock of the following colors, but guarantee no patterns:

Red, Blue, Green, Electric Blue, Mauve, Turquoise, Pearl, Violet, Black, Miscellaneous.

These cases and colorings are the same as formerly, and all with swivel pendants.

We reduce prices as follows:

Series SS (ELF) Enamel Watches, each, \$7.00.

Series SS (ELF) Enamel Watch, with Fleur-de-lis Brooch, enameled, and box, \$8.00.

No quantity guaranteed, but will be sold at these prices until stock is exhausted.

Can be obtained at Factory, Offices or Distributing Agents.

## The Cowboy



The very latest in a strong, finely finished watch.

Open face, nickel silver, screw case. Stem wind and set. Six-jeweled movement.

Flat parallel crystals; 10-karat gold filled crystal ring, and gold filled crown.

In every way a desirable time-piece, durable and stylish.

Trade Price,  
**\$3.00**

Retail Price,  
**\$5.00**

Address DEPARTMENT OF PUBLICITY,

# NEW ENGLAND WATCH CO.,

WATERBURY, CONN.

in the office on the ground floor, which controls five other clocks throughout the building and is itself synchronized from the Washington Meridian Observatory. A novel feature in this time-scoring mechanism is the device by which, by true Washington connection, 250 incandescent bulbs decorating the main architectural lines of the tower are lighted at 8.55 p. m. and extinguished at the second of 9 p. m. Although the illumin-



CLOCK ON THE PRATT INSTITUTE.

ated dials afford a nightly sight of the hours to the population in this section of town, this five-minute-lasting flash and glare of light carries at curfew hour an extension of its radius of usefulness. Already this new timepiece acts as the standardizer of



WM. WISE & SON'S STREET CLOCK.

time for many thousands of Brooklynites. Extending one's search in the direction of the Williamsburg section of Brooklyn Borough brings into sight the tower clock in the big Batterman department store. This useful timepiece has for a long range of years been consulted by a busy throng of pedestrians, for it is in the very center of

Williamsburg's shopping district, corner of Broadway and Flushing Ave.

One of Brooklyn's prominent thrift-preaching institutions is the Kings County Savings Bank, on Broadway and Bedford Ave. From its useful clock dial's hands



CLOCK ON LONG ISLAND STORAGE WAREHOUSE.

the flight of time and the necessary precautions to prevent impecunious age from overcoming us in its unceasing progress are eloquently spoken to the passer by.

In the massive brick tower of the Tompkins Ave. Congregational Church, on the corner of McDonough St. and Tompkins Ave., is a large clock, much consulted.

Protecting the cranium of so many of Uncle Sam's citizens from Old Sol's too genial shafts, Jack Frost's chilling embraces and the saturating sieges of Jupiter Plu-



BATTERMAN CLOCK AT BROADWAY, FLUSHING AND GRAHAM AVES.

vius, the Knox hat factory, situated in St. Mark's Ave., at Grand Ave., can be considered as rendering in its output a beneficent work. And when the hundreds of factory girls and boys teem into or out from the big building, the large clock in the tower is the "cynosure of all eyes."

Ever seeking for outdoor dials, the wanderer reaches Brooklyn's populous, silent suburb that grows proportionately with Greater New York's increment—Greenwood Cemetery, over whose beautiful entrance the "last" dial ticks forth a requiem for the dead.

(To be continued.)

Do Heart Throbs Affect Rate of a Watch?

DOES your watch persist in going wrong—either too fast or too slow? If so, look out. There is something the matter with the watch, or the watchmaker who tries to keep it in order for you, or with yourself.

Nobody would ever think that something the matter with him would cause something



KINGS COUNTY SAVINGS BANK'S CLOCK.

to be the matter with the watch, but a watchmaker is the cause of much uneasiness in an East End family, in Pittsburg, Pa., and all because he insists he does his best with a certain watch, and that the reason it does not keep good time is because the man who carries it must have an irregular heart beat.

It came about in this wise: The head of the family had a gold watch that cost him \$200 10 years ago. He has carried it ever



CLOCK AT TOP OF KNOX FACTORY.

since, but a year ago it began to act queerly. For some days it lost time, and then it began to gain time; again it would gain time mysteriously and then strangely lose a minute or two a day. It had been to the watch repairer's three times in 12 months, and was still acting irregularly a week ago, when the man's wife took it to



# ZENITH

## MOVEMENTS

Give the

**RIGHT TIME  
EVERY TIME  
For a LIFE TIME**

**Grand Prize, Paris Exposition, 1900**

Made in O size, 12 size, 16 size, all grades  
Hunting or Open Face, Pendant Set

INTRODUCED FOR THE FIRST TIME IN AMERICA, THOUGH ONE OF THE BEST KNOWN WATCHES IN EUROPE FOR GENERATIONS

Manufactured by

**GEORGES FAVRE-JACOT & CO., Locle, Switzerland**

HIPP. DIDISHEIM & BRO., Sole Agents, 49 MAIDEN LANE, NEW YORK.  
COLUMBUS BUILDING, CHICAGO.

# Vacheron & Constantin,

GENEVA.



SWITZERLAND.

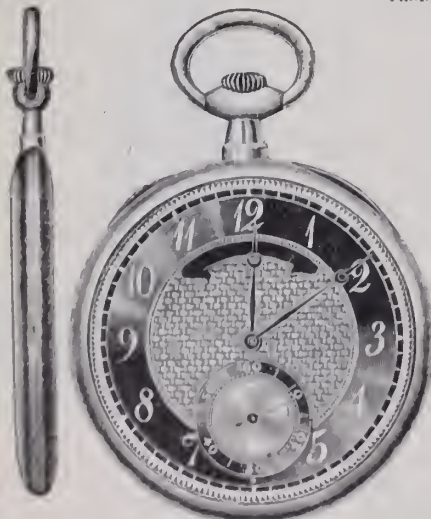

MAKERS OF EVERY VARIETY OF

High-Class  
Adjusted Watches,  
Complicated Watches,  
Extra Flat and  
Ultra Flat Watches,  
Enameled, Carved and  
Jeweled Watches.

**EDMOND E. ROBERT, SOLE AGENT,**

3 MAIDEN LANE,

NEW YORK.

## Mother of Pearl Clock.

SPECIALTY:  
**PEARL WATCHES**  
Ladies' and Gentlemen's

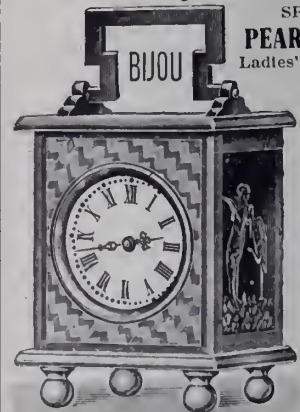

Nurses' Watches, Repeaters and Chronographs.

Extra flat watches in Gold, Silver, Gold Filled and Gun Metal.

Enameled Watches

of all kinds

Write us immediately for information if interested in the new season's offerings.

Exact Size—Cylinder and Lever Movement.

**KLIPPER BROS.,**

59 Maiden Lane, NEW YORK.

## Horological Department

**BRADLEY POLYTECHNIC INSTITUTE,**  
Formerly Parsons Horological Institute,  
PEORIA, ILLINOIS.

Largest and Best Watch School in America

We teach Watch Work, Jewelry, Engraving, Clock Work Optics. Tuition reasonable. Board and rooms in school at moderate rates. Send for Catalog of Information

## Expert WATCH and Chronometer REPAIRING FOR THE TRADE.

When others fail you we guarantee satisfaction. A trial will convince. Prices very reasonable. List will be sent on request.

**G. OHAN, 37-39 Malden Lane, Lorsch Bldg., Room 27. NEW YORK.**

the watchmaker for further treatment. "I think I know what is the matter with this watch," said the craftsman. "I don't believe that your husband's heart beats regularly. Now, don't get alarmed. It is not necessarily disease. He may be just one of those men who can't have a watch that keeps good time simply because of their irregular heart beats.

"You see, a watch has a regular, rhythmic movement," said the watchmaker. "It is carried close to the human heart, which ought to have a regular, rhythmic movement, too. Now, while the watch is beating away the heart is beating also. If its pulsations occur regularly, punctuating the rhythm of the watch at specific intervals, the rhythm of the watch movement is undisturbed, but let the heart pulsations occur irregularly, now pulsating with the tick of



CLOCK AT ENTRANCE TO GREENWOOD CEMETERY. (See text on page 83.)

the watch, again stopping discordantly, in between the ticks, the watch is bound to be affected. Leave this watch here and let your husband carry your watch, which we know keeps regular time. Let him wear it a month and see if I am not right."

So the woman handed her husband her watch to note the result. She wanted him to consult a specialist immediately upon her return from the watchmaker, but he compromised by agreeing to try the test suggested by the watchmaker.—*New York Telegram*.

In the advertisement of Hipp. Didisheim & Bro., last week, it was incorrectly stated that their Locust movements were supplied in 30-year filled cases; this should have been 20-year filled cases. These movements are extra thin model, seven-jewel, lever, pendant set and thoroughly guaranteed by the maker.

Fuller & Scribner have been succeeded in business in Spokane, Wash., by B. G. Fuller.

R. Leighton, Hneoye Falls, N. Y., has moved to a new store, where he has much better light and accommodations.

Two New Regulating Machines.

TWO new regulating machines, which have just made their appearance, are described in the *Deutsche Uhrmacher Zeitung*. The little apparatus shown in Fig. 1 was recently put on the market by Koch & Co., of Elberfeld, and is protected by German Patent No. 236341. It is provided with a standard balance, making 18,000 oscillations in an hour, placed in a compass-shaped frame, c, and made to start oscillating by turning the entire apparatus. In the center of the glass cover

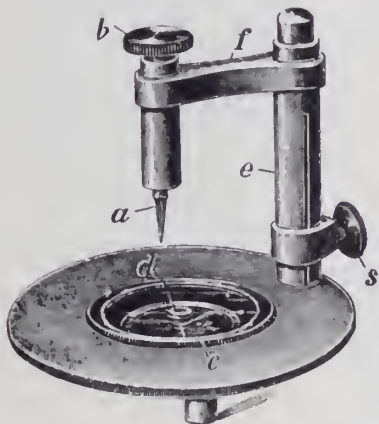

FIG. 1.

of the balance is a metal cavity, d, in which turns the lower pivot of the balance which is to be regulated. On the side of the plate is a vertical support, e, turning on its axis, and which can be fixed in any position by means of an attachment screw, s.

A pair of tweezers, a, is fixed in the cross arm, f, of this support; it is opened by pressing the button, b, and is intended to



FIG. 2.

grip the end of the balance spring which is to be counted.

The method of using this contrivance is probably known to every reader. The outer end of the spring is fixed in the tweezers, a, and set so far sidewise that the lower balance pivot stands concentrically in the cavity, d; then by giving the whole apparatus a turn, both balances are made to start oscillating simultaneously and in the same direction. After a few seconds it will be possible to see whether the balance to be regulated loses or gains as compared with the standard balance. The balance spring is then gripped shorter or longer, as the case may be, and the test repeated until both balances oscillate for a whole minute absolutely in unison.

A much simpler contrivance is the regulating machine shown in Fig. 2. It scarcely deserves to be called a machine; "comparing balance" would perhaps be a more applicable term. The entire apparatus consists merely of a kind of compass, within which is placed, instead of a magnetic

needle, a balance calculated to make exactly 18,000 oscillations in an hour. The balance spring which is to be counted is gripped in the tweezers. The operator holds the latter in his hand and causes the balance to oscillate upon the glass cover of the standard balance case.

This apparatus is made by Henri Picard & Frere, Chaux-de-Fonds. It is patented in Switzerland, No. 12,780.

Competition in Peru Between Clocks and Watches of Germany and those of the United States.

IN the course of a special report on Peru's commercial progress, submitted by Special Agent Hutchinson, to the Department of Commerce and Labor, Mr. Hutchinson says:

In previous reports attention has been called to the success of German competition in clocks and watches in South America. In Peru conditions are different and American sales far exceed German. The imports of clocks and watches to Peru were (values in thousands of United States dollars):

From—	Per annum.	
	1895-1899.	1900-1904.
United States:		
Clocks .....	2.8	4.5
Watches .....	15	19.7
Total .....	17.8	24.2
Germany:		
Clocks .....	*1.7	4.8
Watches .....	*.2	1
Total .....	*1.9	5.8

\*Three years 1897-1899.

These figures and many others which might be given, all serve to illustrate the strength of the United States in Peruvian trade. The obstacles which stand in the way of still more remarkable development are relatively slight. As already indicated, they have to do chiefly with details of packing, shipment, styles, etc., and might be overcome if our exporters would give close heed to instructions and requests which are constantly being sent them by Peruvian importers. These importers, especially the few larger ones who handle the bulk of foreign purchases, are experienced men, and when they give directions as to such minutiae as the above they have reasons for them which perhaps are not appreciated by the American shipper or manufacturer.

Horological Notes.

"I THOUGHT the clocks were queer enough at Naples," said the traveled man, "where you start for Rome at 13 o'clock in the afternoon and get there at five minutes past 23 o'clock at night, but this is what I overheard on a Broadway car the other day:

"'What time is it?' asked one woman of the other; 'can you see the clock from here?'

"'Yes,' said the other, craning her neck to look at a tall clock that stood on the sidewalk, it is 25 minutes after N.'"—*New York Sun*.

Frederick A. Allen, New Bedford, Mass., is the inventor of a watch and chronometer regulator which is said to possess many novel features. Steps have been taken to have the invention patented in this country.

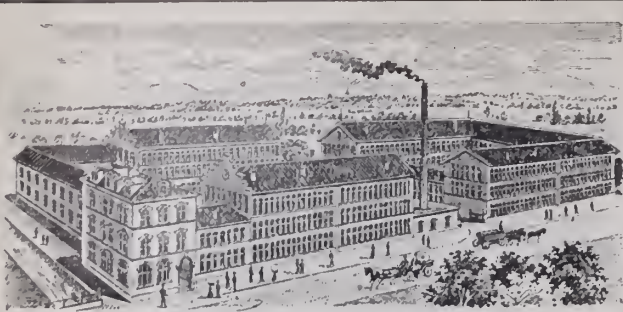

This illustration shows our main factory exactly as it exists, where 3,000 complete watches are made daily.

# LANGENDORF WATCH CO.

CHAUX-DE-FONDS, SWITZERLAND.

It will be of great interest to every jeweler to learn that we are devoting our full attention to this market. The existing conditions in the watch trade have convinced us that there is a long felt want for moderate priced, but accurate Swiss Watches.

We wish to call your attention to our LONVILLE MOVEMENT. It has a lever escapement and is being made in Os, 12s and 16s, fitting perfectly all American cases. This movement is salable and profitable. Our Watches and Movements will be introduced in this market bearing the following names:

- |          |          |
|----------|----------|
| SOLDALE  | HIGHMERE |
| BONDALE  | LONVILLE |
| CLAREFAX | NAMTOC   |
| PEARLHAM | LADY MAY |

SOLE AGENTS FOR UNITED STATES.

**BYRON L. STRASBURGER & CO.,**  
17 Maiden Lane, New York, N. Y.

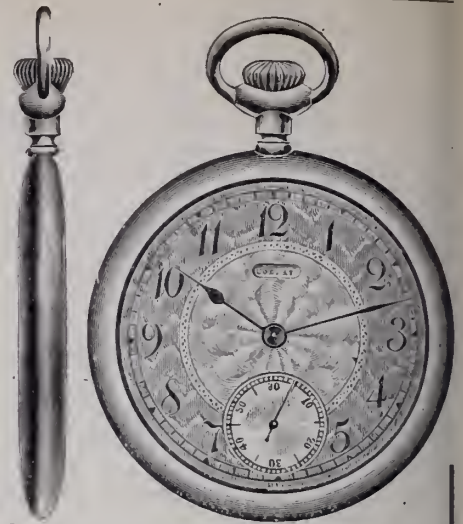

Actual Size.

# LOCUST

Extra Thin Model,

SEVEN JEWEL,  
LEVER,  
PENDANT SET,

CASED IN

## Fahys Bassine 20 Year Filled

Screw Back and Bezel,  
also in  
Silver, Gun Metal  
and  
Solid Nickel Case.

BEST VALUE EVER OFFERED.

**TRY THEM.**

WE GUARANTEE EVERY  
LOCUST WATCH.

All Parts Interchangeable.  
Finished Material Always on Hand.

IF YOUR JOBBER CANNOT  
SUPPLY YOU,  
WRITE US.

**Hipp. Didisheim & Bro.,**

49 Maiden Lane,  
New York.

Chicago Office, - Columbus Bldg.

## 46 out of 99 PRIZES

were awarded to

# PATEK, PHILIPPE & CO.

in the Timing Contest of the Astronomical Observatory in Geneva, for the year 1905, comprising: The only First Unique Prize for Best Average Running; 2 First Prizes out of 3; 5 Second Prizes out of 10; 8 Third Prizes out of 18; 9 Fourth Prizes out of 24; 10 Honorable Mentions out of 23; 11 Simple Mentions out of 21. 11 Manufacturers participated.

68 NASSAU ST., NEW YORK.

GENEVA, SWITZERLAND.

## AUDEMARS, PIGUET & CO.,

BRASSUS and GENEVA.

Manufacturers of Superior

# Plain and Complicated Watches.

Represented by

## A. WITTNAUER CO.,

9-11-13 Maiden Lane,

NEW YORK.

## JULES JÜRGENSEN Watches and Chronometers

PARIS — "THE GRAND PRIX" — 1900

SOLE

RUDOLPH & SNEDEKER,  
65 Nassau St., New York

AGENTS

IF IT'S A

**ROY**

TRADE MARK  
IT'S STANDARD



O Size Bassine Engraved Cases, made from assayed Gold, quality as stamped.

**ROY WATCH CASE COMPANY,**

21-23 Maiden Lane,  
NEW YORK.

SAN FRANCISCO.  
LONDON, ENG.



For *BEAUTY* of DESIGN, *PERFECTION* of FINISH and *RELIABILITY* Combined with *Moderate Price*

**TRENTON WATCHES ARE UNEQUALLED**



No. 140. Bridge Model, 16 Size, 15 Jewel, Hunting and Open-Face, Pendant Setting.

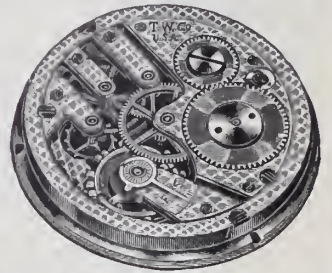

No. 320. Bridge Model, 12 Size, 7 Jewel, Hunting and Open-Face, Pendant setting.



No. 100. Bridge Model, O Size, 7 Jewel, Hunting and Open-Face, Pendant Setting.

A NEAT SIGN  
OR ADVERTISING  
BOOKLET FOR  
THE ASKING

JOBBER SELL  
TRENTONS.

PRICE LIST ON  
APPLICATION.

Manufactured and Guaranteed by  
**Trenton Watch Co., - Trenton, New Jersey.**

**SETH THOMAS CLOCK COMPANY.**

Established 1813.

**VISTA.**

Burnished Gold  
and Bronze  
Finish, with Gold  
Panel. Height,  
12 $\frac{3}{4}$  inches.



8 Day,  
Half Hour  
Strike, Cathedral  
Bell. 4 $\frac{1}{2}$ -inch  
Porcelain Dial.

List, \$15.00.

**SETH THOMAS CLOCK COMPANY,**

51 Maiden Lane, New York.

70 Wabash Avenue, Chicago.

# STEADY DEMAND FOR WATCHES.

**W**HILE THE DEMAND for most articles fluctuates more or less with varying seasons, the WATCH suffers less from these changes than other products. This is because it is less an article of luxury than of utility; it may be classified among the "necessities." Time is observed in Summer as in Winter; in social engagements as in business; by the tourist as by the stay-at-home.

Whatever the season or the object, these Offices are fountainheads for the supply of Watch demands.

## J. W. FORSINGER,

LEADING AMERICAN WATCHES AND MOVEMENTS

CHICAGO  
103 STATE ST.

NEW YORK  
2 MAIDEN LANE



### THIS IS HOW IT HAPPENED.

Some few years ago we determined that first of all we were going to make the best Cuckoo Clocks that brains and skilled craftsmanship could put together; then we were going to sell them for as little as we could.

The expected happened. Quality won out as it always does. We have a country-wide reputation for making the best Cuckoo Clocks that have ever been produced, and with that reputation has come the largest Cuckoo Clock business in the world.

*Better write for our new Catalogue.*

**AMERICAN CUCKOO-CLOCK COMPANY**  
Cuckoo Clocks and other Unusual Clocks  
**STATION S. PHILADELPHIA**

### Practical Course in Adjusting

By THEO. GRIBI.

PRICE, \$2.50.

250 pages, including 18 diagram plates; Fine Paper; Large Type; Clear Illustrations; Systematically Arranged; Solid Binding.

THE JEWELERS' CIRCULAR PUB. CO.  
Publishers,  
11 John St., cor. Broadway, New York.

## Sessions Clocks

Superior finish. Reasonable prices.

Have you seen our  
**New and Exclusive Designs**  
in Mantel and Hanging Clocks?

Write for Catalog and supplement.

### The Sessions Clock Co.

Main Office and Factories,  
**Forestville, Connecticut, U. S. A.**  
New York Salesrooms,  
**37 Maiden Lane.**

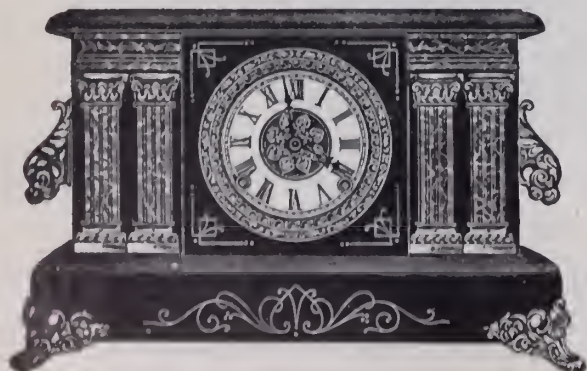



# Two Telephone Systems

in Greater New York would mean for Business Men

Two Books to Consult  
Two Bells to Answer  
Two Bills to Pay

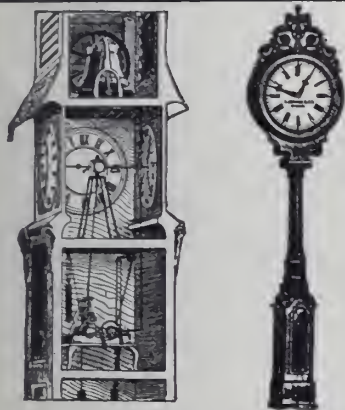

MAKERS OF

## Tower and Street Clocks

For particulars write us, mentioning The Jewelers' Circular-Weekly  
E. HOWARD CLOCK CO.,  
EST. 1842. BOSTON, MASS., U. S. A.



# FANS

Fan Season is here, and we are prepared for it with the choicest line that has ever been imported from Paris. These dainty creations are appropriate for Graduation, Confirmation, Weddings, and in fact for any occasion where taste and exclusiveness are requisite.

SEND FOR A SELECTION, MENTIONING PRICE

## LEWY & COHEN

530 BROADWAY, NEW YORK

Importers of Fans, Brooches, Mounted Side and Back Combs, French Bead Necklaces in mother-of-pearl effects, and THE "MEDICI CHAIN," a new French creation in fan chains.

# The Lady Racine



Positively the BEST chatelaine watch in the market.

Machine Made

10, 11, 12 and 13 Line; Cylinders and Levers; cased in Nickel, Gun Metal, Silver and Gold.

Material on Hand.

Write for prices.

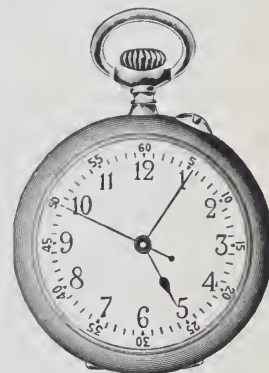

Lady Racine Nurse Watch.

**JULES RACINE & CO.,**  
103 STATE ST., CHICAGO. SOLE AGENTS 37 MAIDEN LANE NEW YORK.

For Sale by all Jobbers

## FISHING MADE EASY

By Using The Greer Pat. Lever Hooks.

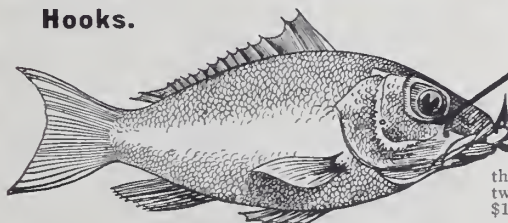

### THE BEST FISH HOOK ON EARTH

for Sea, Lake and River Fishing. No losing bait, nor coming home without your largest fish. No breaking loose or tearing out. No one can afford to fish without one. No springs to get out of order. It is simple and strong, being a lever, the harder a fish pulls the stronger it will hold him. It is easily adjusted to all kinds of fishing by sliding the little clamp on the rod. We claim for the lever hook that a fish does not have to be hooked on the bait hook to get him, if he pulls on the bait the larger hook will spear him. Made in two sizes only, 1-0 and 3-0. Price: 1-0, 10c. each; \$1.00 doz. 3-0, 15c. each, \$1.50 doz.

Mention THE JEWELERS' CIRCULAR-WEEKLY.

Manufactured by GREER MANUFACTURING CO., Atlanta, Ga.

## LEARN JEWELERS ENGRAVING

"The Engraving School that Graduates Experts."

A fascinating, high-salaried and easily learned trade, taught thoroughly and practically by correspondence. Your instructor is the foremost authority and master workman in the world. We will teach the beginner better engraving by correspondence than he can gain in years of rigid apprenticeship. We will improve the skill of any engraver one hundred per cent. and make him master of the trade. The demand for competent engravers far exceeds the supply.

Send for handsome, illustrated prospectus.  
PAGE-DAVIS COMPANY,  
Suite 10, 90 Wabash Avenue, CHICAGO.

# Rockford Watches Speak for Themselves.

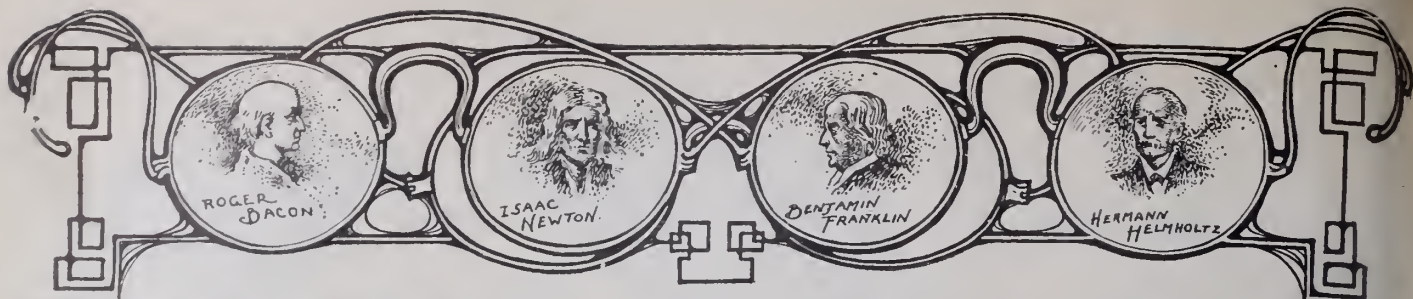

# OPTICAL DEPARTMENT

**Twelfth Annual Convention of the  
New England Association of Opticians**  
The Largest Optical Meeting Ever Held in the United States

BOSTON, Mass., May 17.—The 12th annual convention of the New England Association of Opticians was held on Tuesday and yesterday, May 15 and 16, at the New American House, this city. It was the largest optical meeting ever held in the United States, either local, State or national. Over 375 persons had registered by Tuesday afternoon, and with Wednesday's registration the attendance exceeded 400.

President Albert A. Carter called the business session to order at 1.30 p. m. Tuesday. The minutes of previous meetings were

treasurer, W. P. Bullard, and secretary, George A. Barron, all of Boston.

Executive Committee—Howard C. Doane and F. P. Simmons, Boston; S. C. Hewitt,

many members and guests, at its 12th annual convention.

"In reviewing the past I am intensely gratified to note that the progress is so far-reaching. The association started with 11 members and now has 132.

"The scientific and educational achievements of the past few years are so marked as to have raised the optometrical standard to a higher plane than was dreamed of a few years ago. Each successive meeting has shown an increase in interest.

"Yet, with all these gratifying results to our credit, we must still remember that there is yet much to be accomplished.

"Three important matters should be given our attention, namely: (1) Introduction and adoption of a proper code of ethics; (2)



W. I. THOMAS, FIRST VICE-PRESIDENT



ALBERT A. CARTER, PRESIDENT.



R. WIGHT, SECOND VICE-PRESIDENT.

read and adopted. Ballots for the annual election were ordered closed after all were given due notice of the nominations. Gasper H. Whitehouse was elected to associate membership in the society. Congratulations in the forms of telegrams and letters were received from the Optical Society of the City of New York, the Optical Society of the State of New York, Rhode Island Optometrical Society, and Southern Tier Optical Society.

The election of officers for 1906-1907 resulted as follows: President, Albert A. Carter; first vice president, William L. Thomas; second vice president, R. Wight;

Salem: W. R. Donovan and W. W. Slade, Boston.

Trustees of Funds—Briggs S. Palmer, A. G. Barber, G. H. Newall, C. N. Quinby, all of this city.

Membership Committee—C. S. Hart, Lynn, Mass.; F. M. Drisko, Dorechester, Mass.; F. A. Barber, Boston, Mass.; N. J. Atherton, Boston, Mass.; W. A. Smith, Melrose, Mass.

Representative to the annual convention of the American Association of Opticians at Rochester, Albert A. Carter, Boston; alternate, Briggs S. Palmer, Boston.

The secretary's report was then called for, which showed that there were now 83 active members, 15 associate members and four honorary members.

President Carter then addressed the meeting along the following lines:

"The New England Association of Opticians extends a most cordial welcome to its

stamping out of all unscrupulous advertising, and (3) creating means for increasing membership.

"The code of ethics adopted by the Rochester Optical Society is acceptable, when in is laid down clearly rules governing the 'Duties of Members,' 'Duties to Patient,' 'Duties to Physicians,' 'Duties to the Public,' and 'Titles.'

"The adoption of this or a similar code would not be one-sided, but would help each optometrist by securing him fair treatment in return from both the public and fellow optometrists.

"I protest most unconditionally again

### Optical Department.

much of the advertising that is done by a certain class of opticians, not, happily, members of this or other recognized associations, wherein claims are made that are false.

"For instance, I have made a composite 'ad.' from half a dozen 'ads.' found in various newspapers.

Special offer for 30 days only!  
I will sell 2,000 pairs of \$3.50 gold glasses for \$1,000.

If you are troubled with headache, poor vision, nervousness, dizziness, epilepsy, female troubles, piles, neuralgia, indigestion or other functional diseases, call at once and be examined without charge. I can give you relief.

I never fail.  
"Such 'ads.'" I reiterate, ought to be stopped, when made by other than physi-



GEORGE A. BARRON, SECRETARY.

icians. There is abundance of good material that can be used to far better advantage than this. Tell the truth.

"As to membership, I am often asked:

"Of what benefit will membership be to me?" My reply is that it brings you in touch with the best men in your States, for, while some good men are not members, most are. The educational advantages are many and unquestionably of a high order; and your interests are guarded at all times vigilantly.

"United we can put into practice a code of ethics, we can ask justly and forcibly for legislative recognition, we can elevate the general and individual standard, and we can air our views openly and help each other to an unlimited extent. My hobby is obtaining new members and, with an earnest plea to all to forward this work, I close."

George A. Barron started a spirited discussion by asking "Who or What Are We?"

"Are we refractionist, consulting optician, optometrist, eyesight specialist or Oph. D.?" Opinion varied. Mr. Martin, New York, favored eyesight specialist; Mr. Davis, Rhode Island, and Mr. Hart, Massachusetts, optometrist, and T. Cowan, England, optologist.

The business session adjourned and Mr.

A. Martin, of New York, delivered an address on "The Modus Operandi in Eyesight Testing," which will be found in full on page 93 in this issue.

#### THE BANQUET.

In a banquet hall, which was exquisitely decorated, 240 members and guests of the New England Association of Opticians were royally feasted as guests of the Globe Optical Co. and the Boston Optical Co. The arrangement of the tables produced a horseshoe effect, and at the head table sat President A. A. Carter, Mr. and Mrs. W. J. Benn, E. Le Roy Ryer, Miss Harriet B. Whittemore, R. M. Lockwood, Rev. G. W. Benn, Miss E. V. Neely, F. A. Stevens, Mr. and Mrs. Frederick Boger, William Moore, A. G. Barber, Mr. and Mrs. G. A. Barron.

Besides these there were 14 tables, each seating 16 persons. The menu was as follows:

- |                                    |                    |
|------------------------------------|--------------------|
| Cream of Asparagus.                | Consomme Julienne. |
| Olives.                            | Radishes.          |
| Baked Cusk in Cream.               |                    |
| Bebe Potatoes.                     |                    |
| Roast Chicken, Giblet Sauce.       |                    |
| Delmonico Potatoes.                | String Beans.      |
| Maraschino Punch.                  |                    |
| Rissole of Sweetbread, Neapolitan. |                    |
| Sweet Corn Fritters, Maple Syrup.  |                    |
| Queen Pudding.                     |                    |
| Harlequin Ice Cream.               | Assorted Cakes.    |
| Coffee.                            |                    |

President Carter expressed his appreciation of the Globe and Boston Optical Cos.' hospitality and took that opportunity of thanking the Stevens Co. for the entertainment it afforded Wednesday evening, in the form of a Hippodrome party.

Thanks were offered to W. J. Benn and R. C. Thompson for the excellent manner in which they had arranged the convention. A rising vote of thanks was extended to Messrs. Barber, Hardenbergh and Stevens, in response to a motion made by Mr. Palmer, seconded by Mr. Barron, to present the companies represented by the above named gentlemen with duly engrossed resolutions expressing the society's appreciation of their kindness. A. G. Barber and F. A. Stevens responded.

R. M. Lockwood was next introduced. He congratulated the society upon its complete and unqualified success.

The next speaker was W. J. Benn, who complimented the association, and stated that this was the largest meeting ever held in the United States and that he expected to see 500 at the next annual convention. He felt proud to be a member of the New England Association, because it has been the leader, with but few exceptions, in all important advances. If the Boston College of Optometry was not a success it was merely because the movement was five or 10 years ahead of the times. But a college will come of it yet.

W. Moore, of the Bausch & Lomb Optical Co., followed Mr. Benn. He said in part that Boston inspired men with the determination to advance and fulfil their destinies. From the "Hub" men went all over the world and now form the lifeblood of the great and growing west.

E. Le Roy Ryer was next introduced as ex-president of the Optical Society of the City of New York. As delegate of that society he presented its compliments to the New England Association and went on to say that what the Pilgrim Fathers were to

this great and honored nation, the New England optometrists are to the profession of optometry—the pioneers, the leaders. New Yorkers are as proud of New York as Bostonians are of Boston, but without in any sense lowering his regard for New York, he felt that Boston has now captured honorably all the laurels, but was glad they were in such safe and trustworthy hands.

M. J. Davis, president of the Rhode Island Society, when called upon to speak, wished to discover how the New England Association drew out such an attendance, promising to keep quiet if that were told him.

Rupert C. Thompson was called upon and said that since he had had "convention" for three months, he couldn't say much, except to express his thanks for the unlimited support he had received from the various firms and members of committees.

Dr. A. C. Campbell was then introduced



THE OFFICIAL CONVENTION BADGE.  
(Presented by the American Optical Co.)

and lectured most interestingly on "The Health Ray Lenses." The lecture will be given in full in a future issue of THE CIRCULAR-WEEKLY. This ended Tuesday's session.

#### WEDNESDAY'S SESSION.

The important features of Wednesday's session were: Lecture by F. P. Simmons, "Is the Time Ripe for a Recognized College of Optometry." This dealt with one of the most important considerations of the day and is full of vital interest to all optometrists. A lecture by Briggs S. Palmer, "Systematizing an Optical Business," was a practical, useful address, and was delivered in Mr. Palmer's usual forceful manner.

On Wednesday evening the members and guests attended the performance at the Hippodrome as guests of Stevens & Co. This formed a crowning touch to the most successful convention ever held in the history of optometrical organization.

#### THE EXHIBITS.

Without question, this exhibition of optometrical instruments and appurtenances surpassed anything ever seen. The hall was 80 feet by 30 feet in size, and decorated artistically with the official colors, red and white. The booths were not like those usually found, of a mixed character, but all were made uniform by order of the convention committee. Thus the general effect was grand.

## Optical Department.

### GLOBE OPTICAL CO.'S DISPLAY.

This occupied one-quarter of the entire space and consisted of three sections, viz., a reception room, a refracting room and a workshop. The reception room was richly carpeted and furnished handsomely in old mission and pinks. A complete optical library was also herein installed. A stenographer, furnished by the Globe Optical Co., was at the disposal of the members, and from here were distributed the souvenirs, which comprised a metallic screw driver, a sample of grinding wheel in the form of a knife sharpener, and a celluloid frame measure and axis finder.

The refracting room contained a fully equipped dark room, test cases, prescription filing cabinets, optometers, Geneva combined instrument, De Zeng luminous retinoscope, ophthalmoscope, and ophthalmometroscope, and one of the neatest forms of adjusting tables on the market, whose top is glass, through which you can look down into drawers and, upon seeing the pincer you wish to use, pull the drawer out and pick up the pincer.

The workshop contained edging machines, automatic and regular; lens drills of various forms, and lens cutters, all in actual operation and under the charge of an able demonstrator. The complete exhibit was in care of R. W. Thompson, G. B. Nagel, W. W. Slade, William Bowser and L. E. White.

### DE ZENG EXHIBIT.

Henry L. De Zeng was in charge personally and created great interest by his exhibition of his new transilluminator, an instrument that can be placed on the cheek and illuminate the eye so that one can see inside of the eye through the pupil; putting it in one's mouth, one can also see the fundus reflex. The penetrating power of this light is remarkable and the instrument is not any larger than an ordinary pencil. Mr. De Zeng also demonstrated his luminous retinoscope, ophthalmoscope and ophthalmometroscope.

### EXHIBIT OF STEVENS & CO., PROVIDENCE, R. I.

The "S. Q." individuality characterized this display. A beautiful show case was shown, with a view of giving suggestions regarding window displays. This was accompanied by an instrument that turned out 148 finished screws a minute, and a complete line of Stevens gold-filled goods. The souvenir was a package of screws and a tap. Represented by F. A. Stevens.

### EXHIBIT OF E. KIRSTEIN SONS CO., ROCHESTER, N. Y.

A new line of the well-known Shure-on mountings was shown under the supervision of H. E. Kirstein and Ben H. Hillsbury.

### EXHIBIT OF BOSTON OPTICAL CO.

Here were displayed lens cabinets, prescription filing cabinets, lens centering instrument, pliers, chains, cases, tools, auto goggles and a new form of invisible bifocal and a new mounting called the "Truepoise," that has, it is claimed, many superior advantages. Represented by F. R. Hardenbergh and Edward Leonard.

### EXHIBIT OF F. A. HARDY & CO., CHICAGO,

The Hardy and Chamber Inskip models

of ophthalmometers, a mechanical testing cabinet, and a Ryer astigmometer, were demonstrated by their representative, who also demonstrated for the first time an instrument, not yet on the market, called the oculametroscope, combining subjective and objective tests in a compact form.

### EXHIBIT OF BAY STATE OPTICAL CO.

S. J. Clulee graciously explained the merits of his company's frames; he also exhibited special guards and screws, and about 100 patterns of eyeglass chains.

### EXHIBIT OF FOX OPTICAL CO.

John Currin demonstrated the value of the Fox screw lock and tubular spring, as well as the advantages of the six styles of Lasso guards and the Fox lock-joint temple, an ingenious device to keep the temple from working loose.

### EXHIBIT OF THE STANDARD OPTICAL CO.

The new toric, called the "Hercules" machine, demonstrated by C. E. Quimby, attracted much attention. It grinds with ease a 15.00 D. toric curve on a 6.00 D. base. It is not yet marketed. Lens drills, edging machines, lens cutters, automatic rimless edge grinders, opticians' workbench, were also in operation and the standard lens marking, centering and testing instrument and the improved standard prisoptometer were displayed.

### EXHIBIT OF THE W. GREEN ELECTRIC CO.

Here A. B. Davies demonstrated a full line of motors used in optical workshops.

### EXHIBIT OF W. F. CUSHMAN.

Wm. F. Cushman had charge of Dr. Agnew's German eye water display, as well as that of the Moore non-leakable fountain pen.

### EXHIBIT OF A. D. BLOCK.

Mr. Block himself demonstrated his "Roosevelt Temple," a temple that can be slipped on and off a pair of skeleton eyeglasses at will, turning them into spectacles when desired.

### EXHIBIT OF RANDALL-FAICHNEY CO.

A full line of high grade clinical thermometers were displayed by this concern.

### EXHIBIT OF THE HUB OPTICAL CASE CO.

Almost 100 styles of eyeglass and spectacle cases were on exhibition at this booth.

### EXHIBIT OF THE R. F. SIMMONS CO.

An artistic display of eyeglass chains was seen at this booth. This firm makes thousands of styles of locket, chains, bracelets, etc., and about 400 styles of eyeglass chains.

### EXHIBIT OF PAUL MFG. CO.

L. C. Paul exhibited a metal polish and the Egyptian deodorizer and germ killer. He kept the atmosphere of the hall pure and sweet.

### EXHIBIT OF NATIONAL CASH REGISTER CO.

The click of cash machines could be heard at all times as the representative displayed the advantages of his machine.

## THE REGISTER.

The official list of those present follows:

### REGISTRATION LIST OF NEW ENGLAND ASSOCIATION OF OPTICIANS.

W. J. Benn, Philadelphia, Pa.; Geo. A. Barron, Boston, Mass.; R. M. Lockwood and E. LeRoy Ryer, New York; V. W. Hills, Norway, Me.; W. W. Slade, F. M. Drisko, R. C. Thompson, A. A. Carter, A. E. Covelle, L. E. White, W. E. Munday, H. F. Bower, all of Boston, Mass.; Frederick Boger, New York; H. E. Kirstein, Rochester, N. Y.; E. R. Miner, Providence, R. I.; E. C. Bernheim, Newark, N. J.; M. A. Frohock, Attleboro, Mass.; H. L. DeZeng, Philadelphia, Pa.; A. B.

Dane, New York; E. A. Patterson, Meriden, Conn.; W. R. Donovan and Geo. B. Nagel, Boston, Mass.; S. J. Clula, Attleboro, Mass.; J. Currin, Philadelphia, Pa.; L. C. Paul, Boston, Mass.; Geo. E. Seabury, Clinton, Mass.; J. Geffron, Manchester, N. H.; W. L. Waldert, Rochester, N. Y.; J. H. Collins, Nashua, N. H.; H. P. Warren, New York; A. C. Lord, Tilton, N. H.; E. W. Barrett, Canaan, Me.; W. H. H. Knox, Augusta, Me.; G. E. Chase, Bangor, Me.; L. W. Hammett, Boston, Mass.; M. De Wolf, New York; William Zoerb, Dedham, Mass.; T. Cowan, Manchester, Eng.; J. R. Philbrick, Skowhegan, Me.; C. J. Collins, Boston, Mass.; T. A. Dolan, Portland, Me.; G. H. Quaid, Boston, Mass.; Mr. and Mrs. F. N. LaBelle, Lowell, Mass.; Justus M. Stalin, New York; W. F. Cushman, Boston, Mass.; C. F. Thomas, Attleboro, Mass.; E. R. Post, Westfield, Mass.; A. A. Day, Brockton, Mass.; C. Dolan, Philadelphia, Pa.; Max Jacobs, Hudson, Mass.; T. W. Spencer, Boston, Mass.; G. H. Brown, Manchester, N. H.; F. W. Woolway, Newton, Mass.; Ben Hillsbury, Rochester, N. Y.; C. L. Bugbee, Newport, Vt.; W. E. Burpee, Manchester, N. H.; William L. Thomas, Boston, Mass.; F. F. Stearns, Keene, N. H.; H. L. Houghton, Boston, Mass.; F. N. Gassett, Taunton, Mass.; H. J. Mason, Newton, Mass.; N. D. Sawyer, Laconia; J. B. Hambley, Newton; A. C. Campbell, Topeka, Kans.; Herbert L. Chase, Boston; A. D. Block, Elizabeth, N. J.; W. H. Safford, Jr., Newburyport; A. H. Abbott, Lowell; C. S. Cobb, Mansfield; W. J. Robinson, Malden; H. I. Cowen, Boston; F. A. Elmar, Hudson; A. Martin and Mrs. Martin, Philadelphia; B. S. Palmer and Mrs. Palmer, Boston; M. J. Davis and Mrs. Davis, Woonsocket, R. I.; Mrs. A. D. Sanborn, Boston; B. A. Reed, Salem; Miss F. Gassett, Boston; L. V. Somes, Portland, Me.; L. W. Bugbee, Tilton, N. H.; J. H. Newbegin, Hyde Park; R. T. Little, Manchester, N. H.; Thomas Madden, Leominster; H. E. Murdock, Portland; L. J. Emery, Boston; J. E. Whitney, Andover; J. W. Beverley, Boston; H. M. Kidley, Worcester; C. L. Holmes, Providence; H. F. Jordan and A. B. Jordan, Brattleboro; Ada L. Kimball, Newburyport; H. J. Cartier, Arctic, R. I.; E. A. Wales, Attleboro; R. A. Jilson, Nashua, N. H.; C. S. Hart, Lynn; E. E. Powers, Webster; W. C. Berry, Boston; A. W. England, Providence; J. G. Olin, Lynn; F. C. Sanborn, Wilton, N. H.; M. Lowe, Dorchester; A. J. Morrison and J. F. Dodge, Providence; S. A. Dodge, Pawtucket; H. W. Thompson, Putnam, Conn.; C. A. Nelson, Worcester; W. W. Marsh, Chelsea; N. C. Stiles, Providence; F. C. Woodbury, Pittsfield, N. H.; P. H. Horne, Stoneham; H. C. Doane and L. A. Webster, Boston; A. F. Grow, Hardwick, Vt.; Frederick Campbell, Worcester; C. S. Hart, Boston; R. E. Windsor, Lynn; R. J. Kittredge, Waltham; H. E. Pitcher, Boston; H. D. Ebert, Hubbardston; S. G. Learned and J. A. Bigelow, Boston; S. Lustig, Dorchester; Mr. and Mrs. J. J. Cluin, Lowell; A. E. Smith, Franklin; Arthur Graves, Lynn; F. W. Martin, Nashua, N. H.; W. E. Wells, Providence; C. W. Clough, Pawtucket; W. P. Myers, Worcester; F. W. Putnam, Newport; H. G. Chase, Lowell; E. R. Blethen, Foxcroft, Me.; C. A. Flagg, Turners Falls; Mr. and Mrs. W. Robbins, Skowhegan, Me.; C. W. Parker, Fair Haven, Vt.; F. A. Stevens, Providence; H. Sellman, Woonsocket; W. L. Bemis, Brockton; C. T. Saul and Dr. Poole, Boston; H. W. Cunningham, Providence; C. H. Chase, Lowell; F. R. Hardenburgh, Boston; F. B. Fogg, Hampton Falls, N. H.; Arthur A. Rubin, Boston; S. W. Baker, Rockland, Mass.; H. J. Covelle, Bangor, Me.; H. E. French, Hudson, Mass.; E. S. Eastman, Swampscott; E. H. Cox, New York; L. S. Gregory, Derby, Conn.; F. J. Landry, Pawtucket; A. J. Landry, Boston; F. R. Vaughan, Brattleboro; W. A. De Verre, Jamaica Plain, Mass.; E. A. Flyc, Gloucester, Mass.; F. L. Sullivan, Boston; C. Jenkins, Weymouth; F. E. Bronson, Boston; R. H. Woodrow and Wm. McWhood, New York; A. E. Sargent, Boston; W. W. Newcomb, Fitchburg; Mrs. Frederick Boger, New York; A. E. Lee, Holyoke; G. H. Bellows, Stoneham; H. G. Brooks, Roxbury; T. P. Rowe, Boston; Geo. A. Merrell, Lynn; L. Earnshaw, Boston; E. A. Gage, Haverhill; Chas. M. Whitney, Boston; J. H. Whippich, Provincetown, Mass.; E. McDonald and H. Burke, Providence; E. C. Brown, Boston; L. E. Gordon, Boston; Louis Braum, Providence; Wm. V. Moore, Rochester; J. W. Nickels, Springfield; A. E. Smith, Boston; H. M. Farrington and J. P. Farrington, Kingston; J. C. Hardy, Boston; Mrs. W. J. Benn, Philadelphia; Mrs. E. L. Caswell, Lowell; Mrs. F. Sidelinger, Boston; J. R. Dean, Malden; J. A. Caswell, Lowell; H. W. Green, Boston; John H. Starbuck, Pittsfield; Ralph H. Wight, E. A.

## Optical Department.

Holmes and V. V. Elswick, Boston; W. H. Wyman, Chelsea, A. A. Hart, Marlboro; J. C. Ohlund, J. F. Kelley and W. Abbott, Boston; J. W. Wentworth, Somerville; E. P. Leonard, Boston; W. G. Taylor, Derby, Conn.; Hugo Beil, Lawrence, D. W. MacNiven, A. Jansson, E. F. Robinson, Jr., W. R. Merchant, C. A. L. Langton, L. F. La Pointe, John Blake and H. E. Hornbeck, Boston; H. W. Jones, Waterville; E. R. Cushing, Rockland, Mass.; Carl Ross, Boston; G. N. Fish, Medford; G. W. Mansfield, F. A. Barber, C. H. Abbott, W. N. McMahon, E. P. Jewett, G. E. LaCroix and W. H. Daniels, Boston; P. F. Haskell, M.D., Melrose; H. J. Bodwell, Lynn; H. Edmonds, H. R. Van Winkle and Fannie Bassett, Boston; Mrs. P. F. Haskell, Melrose; T. J. LeMay, Manchester, N. H.; W. D. Ward, Hyde Park; C. M. Cox and Frank Hayden, Boston; W. H. Heath, South Braintree; Dr. T. J. Deacon, Boston; J. B. Howard, Ware; W. R. Upson, Waterbury, Conn.; Mrs. W. Zoerb, Dedham; S. S. Lightbody, P. Pond and R. H. Houghton, Boston; H. P. N. Dahl, Maynard; James Gallagher, Boston; H. M. Swartfiguer, Rockville, Conn.; M. J. Atherton and H. D. Morse, Boston; F. H. Truc, Everett; R. G. Marshall, Waltham; A. S. Bass, Boston; L. N. Vaughan, Newport, R. I.; L. C. Johnson, Worcester; J. H. Blanchard, Everett; L. R. Guild, Boston; E. C. Robes, W. Medford; E. G. Worthley and Mrs. E. G. Worthley, Amesbury; A. W. Slade, Boston; Mrs. L. P. Bodwell, Lynn; J. Fmanuels and G. B. Caldwell, Boston; E. W. Menayer, Melrose; C. E. O. Wilson, West Somerville; A. G. Barber, Boston; E. H. Hubbard, M.D., Gilsun, N. H.; E. D. Corbin, North Brookfield; M. B. Turner, H. C. Keene, L. H. Rogers and H. A. Rice, Boston; L. A. Wiley, Lynn; A. Mode and A. B. Mass, Boston; A. E. Blanchard, Providence; H. H. Carter, Malden; J. Garmonney, Quincy; W. T. Almy, New Bedford; C. B. Holt, Portland; J. M. Hare, J. O. Maghlay, H. S. Wall, H. N. DeMent and C. W. Smith, Boston; A. V. Bowker, M.D., Athol; Alice N. Roy, G. O. Burgess and G. M. Thomas, Boston; F. B. Richers, S. C. Hewitt and A. F. Hall, Salem; James Neil, Waltham; F. E. Chandler, M.D., and F. W. Stone, Boston; F. Perry, Wakefield; Eben Hardy, Boston; E. S. Hathaway, Lynn; H. E. Spear, F. P. Simmons, E. M. Beyer and W. J. La Plante, Boston; L. E. Cale, Natick; W. F. Pinkham, Boston; D. E. Gordon, Hillsboro, N. H.; H. L. Klein, Boston; E. A. Davis, Wilmington, Del.; W. C. Wilkins, Waltham; F. H. Willard, South Acton; A. J. Fairhan, Chicago; A. C. Macuen, Bristol, N. H.; J. Todd, Hartford, Conn.; L. C. Morton, Providence, A. C. Tucker, Whitman; M. A. Klein, Boston; T. E. Hill, Peekskill, N. Y.; E. W. Gooding, Plymouth, Mass.; G. C. MacKenzie, Waltham; F. L. Parkhurst, Fitchburg; C. F. Pettingill, Quincy; E. Stackpole, Walden; C. P. Benn and A. G. Stone, Boston; J. F. Summer, Dedham; E. M. Parks, Boston; Frank A. Webb, Beverly; L. W. Hunt, Boston; L. M. Brands, North Adams; W. P. Bullard, Boston; F. S. Hall and N. C. Rublee, Fitchburg; A. A. Klein, M.D., Boston; F. E. Brown, Swampscott; Wm. Matthews, Providence; F. A. Wald, Southbridge; H. W. Dexter, Springfield, Vt.; R. M. Cook, Marblehead; Frank Littlestein, New Haven; L. M. Potter, Boston; E. S. Albee, Wolfboro, N. H.; A. E. McMaster, Boston; F. M. Marchea, Cambridge; Joseph E. Hart, Lynn; M. S. Drisko, Mrs. W. W. Slade, Mary E. Slade, L. H. Underwood and Thos. B. Frost, Boston; S. Scantlebury, Springfield; A. G. MacKenzie, Boston; G. F. Wilson, Lawrence; H. W. Robinson and Dr. J. E. Littlefield, Boston; F. H. Bassett, Waterbury, Conn.; Fred W. Derby, M.D., Arlington; O. F. Taylor, Lawrence; John J. Pope, Worcester. C. H. Wilcox, Milford; Mrs. B. A. Reed, Salem; A. B. Saul, R. W. Scribner and Mrs. F. P. Simmons, Waltham; E. S. Dearing, Boston; S. J. Gilbey, Everett; W. B. Chiddock, Waltham; A. S. Kelley and F. H. Clements, Boston; R. H. Taylor, Montreal; A. B. Smith, Haverhill; W. M. Snell, Melrose; J. A. Rice, Cambridge; W. L. Freeman, Boston; W. S. Chaffee, Cambridge; W. E. Whitcomb and G. M. Lord, Boston; H. G. Wright and R. Webb, Salem; A. H. Carpenter, C. N. Brown, C. E. Tilton, Mrs. S. Chiles, C. B. Clancey, W. B. Green, F. L. Smith and G. F. McKenzie, Boston; W. S. Gulline, Lowell; F. L. Sumner, Dedham; Jas. S. McEvoy and W. G. Wilkins, Boston; C. D. Tucker, Medford; A. E. Cary, South Boston; H. S. Stone and F. O. Compton, Boston; W. Bergman, Lynn; G. P. Caldwell, Waltham; L. G. Clarke, Worcester; J. Lustig, Boston; F. Keenan, Providence; Mrs. W. C. Berry,

Charlestown; Miss E. Brunton, Jamaica Plain; Geo. A. Gray, Beverly; J. R. Cummings, Malden; C. H. Buckman, Roxbury; W. H. Kiddle, Rutland, Vt.; J. Carter, Boston; H. L. Bates, Portsmouth; W. S. Brown, Manchester, N. H.; W. E. Rose, Taunton, Mass.; J. E. McKeon, Medford; Frederick Hamilton, Providence; C. C. Winchester, Boston; B. C. Read, Holyoke; A. W. Brown, Boston; L. L. Dawson, Malden; A. Caswell, Lowell; C. L. Tower, Boston; H. W. White, New York; J. H. Howes, Chelsea; J. R. Kingston, C. O. Childs and F. E. Welch, Boston; F. A. Murray, Waltham; C. F. Harbach, D. H. Eachern, Henry Lustig, Martin Lustig, Otto H. Woll, W. L. Wood, Miss B. Crowe, A. S. Tucker, Chas. Berglund, E. D. Jerome, Chas. F. MacDonald and Parker Redler, Boston; Thomas N. Glover, Providence; I. H. Tarbox, Pawtucket; Charles Goodwin, Providence; Alden Vaughan, Pawtucket; B. M. Kattelle, Boston; A. J. Bowers, Worcester; A. Maude Wallburg and L. P. Harrington, Boston; J. M. Webster, Milwaukee; James L. Williamson and John Williamson, Boston.

### The Modus Operandi in Eyesight Testing.

(Address by A. MARTIN before the 12th annual convention of the New England Association of Opticians, in Boston, Mass., May 16.)

WHEN I was asked to address you, I consented, with some reluctance, remembering my visit to Boston a year ago. I came here to the convention and went home a sadder, but a very much wiser, man. I had found that I knew very little when I got here, and I went away believing that I knew a great deal more, so I was glad when I got home that I had come to Boston. I find the New England Association of Opticians a body of men of whom it is well to be proud. I confess that there were many things that I learned when I was here a year ago. In deciding on a subject, I thought the subject of "Eyesight Testing" would be the most interesting to men who earned their bread and butter in this way.

In order that a man be a successful trout fisher, first, he must have the equipment, and, second, the "know-how." Now, you and I have heard about the fellow who will go down to the stream with a rod which he cuts from a tree and a safety pin at the end of the rod, and he will catch more fish in an hour that we would catch in a day. Now I do not think we believe in that; so it is with the optometrist. We must first have the equipment, and, second, we must have the "know-how." I have often said that if the Angel Gabriel should come down from heaven and test eyes and not have ordinary tact and business ability, he would not be successful in business. It is not always the man who can do the most thorough work who succeeds, but the man who impresses his customer with his knowledge of the business and inspires confidence, so that a patient will do just what he wants him to.

I have divided my subject into three parts: First, the constructive; second, the objective; third, the subjective. To return to the fishing trip: We start out with equipment, which is the constructive end of it. We are thoroughly equipped with the latest and best appliances for testing eyes. Without such an equipment, a man is severely handicapped.

The second is the objective view of the matter, and that is the patient, or the trout, which you are going to catch. If you want to be a successful trout fisher, you will always keep yourself out of the way. I remember very well when I first began to

catch trout. I went up the stream—rather, I went down the stream—and a man came along, and he said, "Do you know what you are doing?" I said, "I am catching trout." He said, "You are beginning at the wrong end. You must go up stream and keep out of sight, so that the trout will not see you." So it is with eyesight testing. If you want to do good testing, keep yourself out of sight. Do not think what a great man you are—in other words, "the only pebble on the beach." That is the objective end of it.

Subjectively, it depends on us. We have our trout. How are we going to land it? Almost any man can catch a trout, but the difficulty is in landing it. How are you going to land your customer? Let us see how we proceed, making this as simple as possible. The patient comes into the office and wants to have his eyes examined. Get your patient in a chair and sit down professionally beside him, in order to have a short talk. Ask what the trouble seems to have been; ask whether glasses have ever been worn before or not, and, if possible, get your patient to understand how you are going to proceed. If possible, let it be known in some tactful way whether you are going to charge for examination or not.

Some men believe no charge should be made for the examination. I believe differently. I believe it is best to raise our profession to the highest plane. Take a man who consumes three-quarters of an hour of his time in examining a case and makes no charge for it. I would like to know how he is going to make up for it, unless he is going to bunco his customer into buying a pair of glasses. I think the finest thing is to find a man or a woman who does not need glasses. It is the best advertisement I know of when I have a man or woman sitting in my chair and I can say, "There is nothing the matter with your eyes. There is no error of refraction. There is something else the trouble with you." You are paid for your examination and the customers go out and are going to be an advertisement for you for years to come; whereas, if you had sold them a pair of glasses for, say, \$3, \$4 or \$5, that they did not need, they know you have fooled them and they will do you harm.

When you find a customer that does not need glasses, glory in it, for you have found the best advertisement possible. The trouble with most men is that when you hold one dollar before their eyes, they miss the \$20 beyond. Now, you try to inspire confidence in yourself by this constructive examination. It is not always wise to say, "We charge so and so for this examination." I never say this, but I bring the patient into such a position that he will ask me, "Now, what do you ask for this examination?" I have inspired his confidence, and I then go on. Now, that you have inspired their confidence, you go on and try to find out something about their trouble—whether they have worn glasses or not, etc., and then you proceed.

We continue the examination. I prefer to do this in a darkened room; some prefer to have them sit in a room and draw the curtains. The first thing we do, we take the ophthalmoscope and we examine the fundus. After we examine the fundus, we

## Optical Department.

next examine the cornea, the crystalline lens and the iris. This takes but a few minutes for an expert with the ophthalmoscope, and there is no reason why every man could not be an expert with the ophthalmoscope by putting in a few hours a day. In this way he will soon be able to know almost at a glance whether disease exists. This examination is extremely important, but I would advise every man to have the patient look at a lighted globe. There may be iritis, and it is not wise to expose the eye at first to too strong a light.

You will leave yourself open to a case of law if there should be any trouble because of this. There was a gentleman in this State, only a few years ago, who, because he took a patient into a darkened room and threw the light into his eyes, was involved in a law case. It came out afterward that some oculist had sent the man to the optician, because he knew he would be taken into the darkened room and the eyes would be examined in this way.

The next thing we should do is to examine the refractive media. I prefer to do this with what I call the skiascope—with the regular skiascope—because you have the mirror in your hand. I have used the regular skiascope and the De Zeng retinoscope. Now, with the skiascope, which I referred to, I have the revolving disk, holding plus and minus lenses, ranging from 0.50 to 4.00. This does away with the trial case entirely. I put the round disk in front of the patient's face and I swing it around until I get just what lens I want, marked with red and white letters. Now I have the refraction; I mark it down. Then I estimate the astigmatic condition with the ophthalmometer. Some do not place much confidence in the ophthalmometer. For my part, I have used it many years, and I do not care to give it up. It is not an absolute instrument for measuring astigmatism of all kinds. You will find many cases of lenticular astigmatism which the ophthalmometer does not show at all. In many cases of corneal astigmatism the ophthalmometer will give the refraction by ignoring spasms of accommodation.

Now, having found by the use of the ophthalmometer that there is a certain amount of astigmatism, we find the axis, and I examine the patient. It all depends on me. I have gone so far; I have certain information. I know whether there is myopia, or hyperopia, or astigmatism, or hyperopia and astigmatism, or myopia and astigmatism. I go into my room, and if I find no shadow "against," there is no myopia. I may find a shadow "against"; if so, it indicates myopia, or there may be a spasm; but when I find the shadow "with" me, I know there is hyperopia. If I find 1.50, I know there is 1.50 there, and if I find two, three or four, I know it is there. Now, this is the information the retinoscope gives you.

For the subjective test, I look on paper, and I find 1.00 D. of hyperopia. I put on plus 3.50 to start, and if it is accepted I keep plus it on. This is my method. I bring out all the plus I can by the fogging system. I think the fogging system is excel-

lent, and it is one that I have used for a long time. There are three ways of making this examination. The first way, plus spheres with plus cylinders; second, plus spheres, with minus cylinders, to correct astigmatism. Third way, the one not used much, but which I like best. This is one of the finest tests which has ever been used—minus spheres, with plus or minus cylinders. I have been told in years gone by, "Do not touch minus spheres. Keep away from them. Do not correct with minus sphericals if you can possibly avoid them." First, is the old time plus spheres, with plus cylinders. I must confess that I could never examine a case that way. I do not see how any one can. Perhaps it can be used successfully by a medical optician, or an oculist. I feel certain that both these men will soon become obsolete.

A man who does his own work; a man who puts his life into his work; a man who has been given brains by the Almighty, why should he not do this work as well as a medical optician, or a dentist, who studies the nerves of the head and throat, so that he may know where the teeth are affected. The day will come when we will be compelled to take an examination which will raise us to a higher plane, and elevate the standard of optics. First, is the old way, plus spheres, with plus cylinders. Second, plus spheres, with minus cylinders. The fogging system is an excellent system for compound astigmatism. The old way is to bring up the nearest ray of light with a weak plus sphere. Now, the plus and minus way to correct is to bring up the hindermost rays with a strong minus sphere and bring up the foremost rays with a strong plus cylinder.

The third one, I feel sure, will come in favor before long. Suppose you go into your dark room and find the patient needs plus 2.00 cylinder, axis 90, and you find that the ophthalmometer indicates this also. You come to the subjective test and you place in your trial frame plus 2.00 cylinder, axis 90. You have a young person to examine. Put on all the minus spherical he can stand. If he will stand 1.00, 1.50 or 2.00, pile it on. Try it. You have then stimulated the ciliary muscles. You have not relaxed them. You have stimulated the ciliary muscles until you can do no more, and you hold it fast with your minus spherical. Holding it fast, you proceed to find out how much astigmatism there is there. You begin to reduce by using minus cylinders, reducing and reducing until you can get the best results and get your patient to see. You now have a minus 2.00, which you have been compelled to accept. You have the astigmatism corrected and the ciliary muscles are in a stimulated condition. Pile on all the plus you can, and if that is not satisfactory, try the minus. This method has not been long in vogue, and it is not original. I do not claim it at all, for it is not mine; but I know this, that those who are using it, and who have used it, have derived great benefit from it.

After testing each eye separately, try them alternately, and add or reduce until both eyes see equally; try to add plus. Then test right; then test left; then you find both eyes something like 20/20. How am I going to know that all rays that pass

into the eye are seen? It may be that one is only 20/20 and the other 20/30. I proceed now with the patient to put on a plus in one eye until I throw clear vision into the other, until I have reduced it to 1/2 D. Then I know I have reached the result where both eyes are seeing exactly the same. Now, having found in each eye a strong plus lens, I begin increasing the plus on young people—the strongest they can stand. If you meet a nervous little woman, who has been sick weeks or months, you must consider your patient. If they have not worn glasses before, you can put on an extra plus. If you do not know what torture it is to wear an extra plus lens, try it some day. Now, let us pass on. The accommodation of the eye can be gauged very well by an ideal rule which Donders gives us:

Years.	
10.....	14.00 D.
20.....	10.00 D.
30.....	7.00 D.
40.....	4.50 D.
50.....	2.50 D.
60.....	1.00 D.

After having found out the accommodation of the eyes, you will proceed now to test the muscles. As I come to this, I come with fear and trembling. One famous oculist has said: "If we live 100 years or more, we will not know all there is to know about muscle imbalance." There are many tests for muscle imbalance, and I am sure most of you are interested in some of them. There is the Maddox rod, the double prism, the candle or electric globe. Any one of these is good. Take the candle, for instance. Take the right eye. Placing the prism over the right eye, with base down, the eye inclines inward, the light will move in an opposite direction. If the light inclines outward, the light will move inward.

I make this statement in spite of what has been written in a book by a famous western writer. "What is called esophoria is really exophoria, and when they say it turns down, it really turns outward." I could not understand how any one could come to write anything like this, in the face of anything that could be so easily explained. How can I prove that light moves in opposite directions? Take the eye and push it in toward the nose, so that the image you see moves in opposite direction. Lights always move in an opposite direction from the eye. When the eye moves inward, esophoria; outward, exophoria.

Now, to know how and when to correct muscle imbalance. If we find a case of refraction where we think that is the cause of it, I think we would be very foolish to correct it. We should allow the patient to go on for a little while and we would find that the muscle imbalance would disappear. It is best not to correct muscle imbalance at first, unless there is permanent trouble. If there is, it should be given muscular exercises. We can sometimes help this by using prisms. These make the muscles more elastic, and stronger by exercising. We must, of course, consider the patient and consider whether the patient can stand a prism or not. In dealing with prisms we are dealing with edged tools. I knew a man once out west who said the prisms would cure consumption. He took the position that the eyes are always extending out when a man is dead, and he said

## Optical Department.

we must use prisms to keep them straight. A friend of mine said, "I am through with prisms until I can know where they can be used." There are some persons in this room, I am sure, who use muscle exercise, but, of course, it is the same old case of putting strong prisms, base out, in for a little while every day and bringing the weakened muscles out.

Now, as to when an oculist should be consulted. In a year I have sent dozens to an oculist to be operated on. I say to a patient, "I can use prisms." Can you help it? We give correction with a prism, which will relieve the trouble for the time being, but there is no other way than an operation that I know of. Now, there is a most important point in dealing with muscle imbalance: First, when there is exophoria with hyperopia, it should not be fully corrected. When there is marked exophoria with myopia, glasses should be worn constantly. When there is esophoria with myopia, work should be given up. I have these rules typewritten, so that my assistant can see them constantly, so that he will make no mistake in knowing what to do.

Many children who squint—whose eyes turn out—have hyperopia. What are you going to do? Correct hyperopia. I know a worthy man who came from New England. I remember him saying once that he did not believe in a man examining children's eyes with an ophthalmoscope. I believe any man who understands the ophthalmoscope can examine a child's eyes. Shall we give glasses to a child of two and a half or three years of age? Just as soon as the child knows enough to keep glasses on, put them on, if error exists.

Take, for instance, a squinting eye. There is a vision of 20/60, and the vision of the fixing eye is 20/20—the focusing eye, I call it. Pile on plus until it only sees 20/60. Give them glasses to wear a few days, and if they cannot stand them, give them weaker and weaker, and in a few days I am told the squinting will be less and less. I prefer starting at the lower end and coming up higher and higher. I am quoting from an excellent authority in this country, who has tried this with excellent results, using plus spheres, with distance correction and using both spheres together.

Now we come to the reading point. This is very important. We add about 1.00 D. for every five years above 40. For 50 add plus 2.00 to correction for distance, and direct patient to read paper at the ordinary reading distance. They will be inclined to hold it nearer. It should be held about 16 inches away, with ordinary type, until it gets better. You will find in some cases that one eye will accept more plus than the other. Then I go back to the first finding. I balance it up and come back to the reading test. This is very important. Direct them to hold the paper closer until you see how far or how near they can see best. It all depends on what a person does. A man comes in, he is a mechanic; another comes in, he is a lecturer. You must give them glasses. The next step, find out whether they have worn glasses before or not. There are so many opticians who want to see the

glasses when they first come in. This is not a square deal. You are going by another man's work. Fancy a physician coming to you and saying, "What kind of medicine did the other man give you? Let me see the prescription." He does not care for this. He makes his own diagnosis. Now, after you have diagnosed, you want to see those glasses. If those glasses are right what are you going to do, as I have found to be the case sometimes. A friend of mine says to me, "I make the sale. Those are old ones, anyway." I said I would not. Stand up for what is right! Cheat the devil, anyway! Cheat him!

A little while ago a lady came to me. Her glasses were absolutely correct. I told her I could not improve on them. I said, "I do not see why it is you came to me." "I was recommended to you," she said. I do not know who made the glasses. Yesterday a man came in to see me, and I saw that his glasses were wrong. He was about to tell me who made them. I told him I did not care to know. That is one point. Your patient sees you are not trying to run down the glasses.

A while ago a lady came to see me. The trouble was the optician had given her minus lenses instead of plus. A while ago a lady came to me and said a certain party was a fakir. She told me her story, and she said, when I did not say anything, "Have you nothing to say?" I said, "No. I am too busy. I have not time to criticize any of my competitors." I made my sale. I got the case and the patient is entirely satisfied.

Make a note of every case. Make a note on your prescription blank, of what they are wearing. You are now ready for the sale. We will assume a person has come in to buy glasses. Now, the fitting of the frame is a most important matter. In the fitting of the frame, as you all know, you must first take the P. D., and the size of lenses needed. I am not speaking on fitting to-day, so I will make my remarks short on that point, but this is most important. Have the frames so they will fit just right.

We come again to the sale. I think it is most important, where a sale has been made, to have a deposit on the sale, if lenses have been made specially. This is a rule we have made for years, and I think it is most important. Have a charge for examination and, if possible, get a deposit for your work. No man can afford to give away half an hour of his time, and then say, "There is no charge." What would you think of a physician, after he had examined your lungs for half an hour or so, and you asked the charge, to have him say, "Oh, never mind—nothing." I think you would go to another man. When people get good service they are willing to pay for it.

I sat here in this room last year and heard the discussion about examinations, and I hope there will be something done this year. There never was a time, gentlemen, when I advertised "No charge for examination." I walked down street to-day with a man and saw a sign, "Eyes Examined Free." That is something which makes me blush with shame. It is beneath this profession. What man is giving three-quarters of an hour of his time to examine

eyes free? He does not mean to do it, however. He means to bunco that customer. Let each one learn a lesson from these methods. We have raised our business up to a higher plane than it was 10 or 20 years ago. What was optometry 10 years ago? Then we had men at the corner of the street, with a little push cart, selling glasses for 10 to 20 cents a pair. Now, we can get \$10 and \$20 a pair. To-day we are giving good service and we are getting paid for it.

### A New Bifocal Lens Grinder.

**A**N apparatus has been devised for grinding a solid bifocal lens. The finished lens has the advantage of having the lower part of the "down curve" variety. Heretofore the dividing line of a solid bifocal curved upward, making the upper section of the lens smaller than the lower. This, in turn, limited considerably either the upper or lower field. The inventors claim also, that hitherto no solid bifocal lenses were produced out of single pieces of glass, having two distinctly different foci, without a ridge, and yet optically correct. That is, it was impossible to produce a lens in which the optical centers of the two foci could be at any required distance from each other, or from the geometrical centers, and still have the spherical surfaces true and free from rings and tool marks. By ridge is meant a difference in level at the place where the curvatures of the two foci meet.

The amount of the curvature produced has heretofore depended on the form of the grinding tools, which are generally larger than the lenses operated upon, are solid and have a continuous curved grinding surface. The new tools are such as to be entirely independent of the continuous curve of the grinding surface.

The amount of curvature depends upon the relative surface velocity of the tools and the lenses carried by the holders, and the direction in which they are respectively rotated, any alteration in the ratio and the direction resulting in an alteration in the degree of curvature of the lens. The machine grinds the two curvatures of the solid bifocal lens at once.

### Optical Notes and Briefs.

A. J. Gray, of the Failing Optical Co., Buffalo, N. Y., is making elaborate improvements in his residence.

Dr. Niles B. Cook, Niagara St., Buffalo, N. Y., delivered a lecture before the Buffalo Optical Society at the May meeting on the subject, "Some Diseases Opticians Can Recognize."

S. L. Weaver, traveling representative of the Fox Optical Co., Philadelphia, Pa., spent Friday and Saturday of last week in Buffalo, N. Y. He reports splendid increase in the optical trade in his territory.

Certificates of membership in the Buffalo (N. Y.) Optical Society, beautifully embossed, have been given to E. V. Syrcher, Buffalo; W. M. Gale, North Collins; C. F. Cushing, Niagara Falls; J. P. Simcox, Buffalo; C. H. Gros, Cuba, and L. W. Aldridge and Floyd L. Akin, Buffalo. The certificates are presented to those members of the society who pay their dues in advance.



That this department shall prove mutually beneficial to our readers, it is desirable that the members of the trade generally communicate with THE JEWELERS' CIRCULAR-WEEKLY regarding any advantageous device or plan which they are utilizing in connection with their business.

**A Representative Retail Jewelry Establishment of Pittsburg, Pa.**

**I**N Pittsburg, Pa., Gillespie Bros. have demonstrated what can be done in the way of erecting attractive second story retail establishments. High rents have forced many dealers to the upper floors of

of the principal business streets of the city. Running through the center of the store are three square columns, which have been made splendid use of. Around these have been built mahogany show cases of neat design, in which are displayed attractive articles of jewelry. They add materially to the store's attractiveness.

of the three columns are also placed show cases of modern design.

The interior is so arranged as to call forth much admiration. The floors are covered with linoleum of a hardwood pattern, the imitation being such as to deceive almost any one at first glance. There are at least a dozen second story jewelry stores in Pitt-



INTERIOR VIEW OF THE RETAIL JEWELRY STORE OF GILLESPIE BROS., PITTSBURG, PA.

buildings. Gillespie Bros., 10 years ago, opened a retail second-story store in the Park building, and have been so successful that recently they acquired just double the room formerly occupied, and without doubt have at present one of the most attractive establishments in that city.

The present store room, which is square, is 52 by 40 feet, and faces Fifth Ave., one

As one enters the establishment the eye immediately catches a glimpse of a handsome display of cut glass on a table supplied with mirrors, the background also being set with mirrors. This table is about 25 feet long and is exceedingly attractive. The show cases, which are of mahogany finish, are lighted by electricity. These occupy the four sides of the store. Around the outside

burg. In fact, second story stores are proving immensely popular in that city.

The death is reported of Peter E. Osterholm, Essex, Ia.

Wm. E. Trein, Ashton, Ill., recently purchased an interest in a store in Dixon. He will close out his stock at Ashton and move shortly to the new territory.



**Storekeeping Department.**

**Coloring Incandescent Globes.**

NEW YORK, May 16, 1906.

Editor THE JEWELERS' CIRCULAR—WEEKLY:

In a recent issue of THE CIRCULAR—WEEKLY were given instructions for producing color effects in electric incandescent bulbs. Mention was made of using dissolved shellac for outdoor use. For such purpose, or where the frosted bulb (from use of alum solution) is objectionable, a clear glass effect is obtained, as stated, by aniline dyes, in shellac. But most aniline, or coal-tar dyes, are not soluble in alcohol, and are, therefore, useless for coloring a shellac solution.

The ambitious bulb manipulator must, therefore, be sure, in purchasing his dyestuff for this purpose, to especially demand that the color be "spirit soluble." But again many of those, if not most, who dispense coal-tar dyes are not aware which one will dissolve in alcohol, and which will not. So, perhaps, further assistance will be rendered by enumerating a few that are spirit soluble. And as the over 600 different coal-tar dyes have several names for one and the same chemical preparation, according to the maker, a further hindrance may occur in getting your color dealer to determine which dyestuff you require. In order to make this clear the number of the Schultz and Julius tabulation is also appended to the following list, so that any color dealer who knows exactly what colors he has in stock can know whether he can supply you.

**S. & J. NITRO COLORS.**

No. 8. Martin's yellow or naphthol yellow (the ammonium salt is spirit soluble but the sodium and the calcium salts are not).

**AZO COLOR.**

- No. 31. Wool yellow, or patent fustine.
  - No. 33. Alizarine yellow, G. G.
  - No. 48. Palatine scarlet.
  - No. 62. Fast red, B. T. (slightly soluble in alcohol).
  - No. 64. Scarlet crystals, 6 R.
  - No. 66. Palatine red (blue red solution).
- TRI-PHENYL METHANES.**
- No. 285. Malachite green.
  - No. 286. Brilliant green.
  - No. 298. Victoria blue.
  - No. 300. Fuchsin (red solution).
  - No. 303. Methyl violet, B.
  - No. 313. Alpine blue.
  - No. 335. Aurine, or rosolic acid (golden yellow).
  - No. 344. Eosine (red, with green fluorescence).
  - No. 355. Phlorescine (bluish red solution).

Perhaps it would be well to add the remark that, while the tri-phenyl methane colors are very brilliant and attractive, they have mostly, if not all, the reputation of rot being fast to light; that is to say, they fade in a bright light. Hence this latter list may not be of lasting value for incandescent bulb purposes. C. W. C.

S. Jacobs & Co., Minneapolis, had an Easter window attraction which called forth a great deal of comment and attention. It consisted of a number of young chickens which had been dyed different colors, so that they looked as though they were hatched from Easter eggs. They were very much alive and eagerly eating grain which was scattered around for them.

**Novel "Wink" Light Effects.**

THAT latest of incandescent bulb lighting effects known as the "wink" light, which periodically extinguishes itself automatically, should be possible of many very startling and artistic methods of manipulation.

As a suggestion the following color scheme should be highly effective:

Having a series of colors, say, red, blue and yellow bulbs, alternately placed around the framework of the window, they could be so arranged as to have but one color alight at one time. The reds could be switched by themselves, the blues by themselves, and so on. By having only the reds alight at one time and the blues flashing out as the reds are extinguished, and the yellow bulbs becoming incandescent when the blue bulbs fade out, beautiful effects would be accomplished. By this means an artistic chromatic spectacle that was so startlingly used on the fountains in recent industrial exposition grounds would be duplicated in show window displays.

By arranging the flashes so that, before the reds are extinguished, the blue lights flash up, a lovely blend into violet rays would be brought about. Or on similar plan the blue and the yellow would blend into a green, to give place to yellow when the blue becomes extinguished.

The effects of gradual blending from primary to secondary and even tertiary colors allow a wide range of chromatic possibilities. Of course, care must be taken to avoid the effect of bringing together complementary colors, unless a white light be desired at intervals. Perhaps, for the use of those not well versed in the science of colors it would be useful here to give a table of the complementary colors of the principal divisions of the spectrum:

- Red..... Bluish green.
- Orange..... Deep blue.
- Yellow..... Ultramarine blue.
- Greenish yellow..... Violet.
- Green..... Reddish violet.

Of course, these are but suggestions opening up numerous other color combinations and fantastic effects that can be wrought by aid of "wink" lights.

**Philosophy of Hans the Advertising Expert.**

**D**OND blame der newspaper auf your adferdisement dond bull, auf you dond know how to write a bulling adfertisement.

\* \* \*

Honesty vas der best policy game, esbpecially auf you vas an adferdiser, und dond oexpect to make a woluntary pankrubtey of your peeziness.

\* \* \*

"It is not der hen dot cackles most dot lays down der most eggs," also likewise, it is not der adferdisement dot haf der most words inside dot sell der most goots yet, esbpecially if der words are cackle words.

\* \* \*

A beird in der cage is weart fnifsig cent more as two on der ving. Likewise also an adferdisement in a goot paper is weart ein tausend vot you dink py your head insite, but neffer py your adferdising agent oxecoot an order for.



Catch phrases, descriptions and arguments which retail jewelers and opticians have used in their newspaper advertisements.

**W**ITH the tide means smooth sailing all ways. Same in business. Keep what the public wants; go after it with an ax, if necessary, but get it! Then the public, when wanting jewelry, will sail in and sail out with your goods, especially if your prices are right, "with the tide" and in the same boat, both storekeeper and customer. C. C. Miller, Massillon, O.

Jewelry.—Delicate and new designs in rich ornamental jewelry that will please customers for fine goods. Diamonds and other precious stones in beautiful combinations. Our stock always comprises the best quality and designs that are produced. Rowe Bros., Chicago.

Diamonds are just as good an investment as improved real estate, even better; because they will never depreciate in value, and are less trouble to keep. You are mistaken if you think buying diamonds is an extravagance intended for the rich alone. A person in moderate circumstances could find no better investment. A point to be well considered, however, is how you buy the diamond. Don't buy cheap diamonds and don't pay too much for good diamonds. Buy them right. Our immense stock and good reputation as reliable merchants are open for your investigation. Come and make a paying investment to-day. Albert Pfeifer & Bro., Little Rock, Ark.

Expert watch repairing, expert jewelry repairing, expert engraving—our watch and jewelry repairing and engraving courts investigation. Take them up one at a time, be as critical as you like, so long as you are just. We are experts on repairing watches and the only expert engravers in Massillon. Get on our satisfied list. All work guaranteed. Hutchinson & Myers, Massillon, O.

Concerning your eyes. A part of this store's good service is devoted to keeping Portland eyes right. It is a service conducted on the highest plane of excellence. A graduate optician who has been here for years is at your command always. Your eyes will be subjected to a careful and complete examination without charge. If they are all right and simply tired, we will tell you so. If they need corrective glasses, we will tell you so; and, if you wish it, will make glasses properly and for less expense than reliable glasses usually cost. Be sure your eyes are right. It is a duty you owe to yourself. The L. C. Henrichsen Co., Portland, Ore.

John Schroeder, Iona, Minn., is opening a new store in Graceville, Minn.

What Tool is of More Importance to THE MAKERS OF FINE JEWELRY than

# A FIRST CLASS SAW ?

**SHARP—TRUE—UNIFORM**  
**—PERFECTLY TEMPERED**

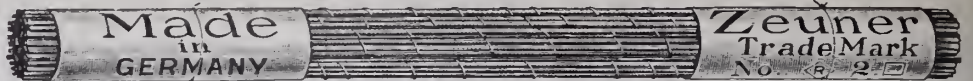

TRADE  
**ONLY THE BEST**  
ARE  
GOOD ENOUGH  
MARK



Such is the **ZEUNER SAW.**

**TRY THEM**, for "Only the Best are Good Enough," and only the Best are Cheap. Trial orders promptly filled under guarantee of perfect satisfaction, which applies also to our "AMERICAN SWISS FILES."

**E. P. REICHELHM & CO.,** 23 JOHN STREET, NEW YORK.

**HERPERS BROS.,**  
MAKERS OF  
**SETTINGS**  
IN 10, 14 AND 18 KARAT GOLD AND IN PLATINUM.  
ALSO A COMPLETE LINE OF GALLERIES AND FINDINGS.

BRACELET SHELLS  
FIVE SIZES  
ROUND AND OVAL

SECTION

OFFICE AND FACTORY NEWARK, N. J. U. S. A. NEW YORK BRANCH 41-43 MAIDEN LANE

## GLARDONS' SWISS FILES

are the **HIGHEST STANDARD** of Excellence.

We are Sole Agents for the United States and Canada.

### F. W. Gesswein Company,

Established 1868. Incorporated 1896.  
WILLIAM DIXON, PRES.  
Dealers In Fine Tools and Supplies,  
39 John Street, New York.

## CULMAN BALANCE CHUCK

For Refinishing Balance Pivots, without removing the Hair-spring or Roller, and protecting them while the pivots are being polished. **ONCE TRIED, ALWAYS USED. FREE ON 10 DAYS' TRIAL.**

OVER 1000 SOLD THE FIRST YEAR. PRICE, \$3.50.

**C. CULMAN, 316 N. Sixth Street, ST. LOUIS, MO.**

## Automatic Bright Annealing Furnace

Bates & Peard Patent, Birmingham, Eng.

For Manufacturing Jewelers and Silversmiths and Watch Case Makers.  
Free from Oxides or Scale.

Illustrated Catalogue by  
**C. M. DALLY, Agent, 29 Broadway, N. Y.**

Mention this paper.

These well-known Razors, the quality of which is warranted, possess this great advantage, that they may be used for ten years before they require actual sharpening. Before using them it is necessary to rub them on good leather strop. Le Coultre's Stropps (to be had with the Razors) should be used in preference to others.

THIS CUT IS TWO-THIRDS OF REGULAR SIZE.

**LE COULTRE**

"SPECIAL."—Single Razors for Jewelers' Travelers at trade price.

## MATHEY BROS., MATHEZ & CO.

Send for Price-list. Sole Agents, 21 & 23 MAIDEN LANE, N. Y.

## CRUCIBLES.

Jewelers' Supplies, Etc.

Established 1850.  
**J. & H. BERGE,**  
95 John Street, NEW YORK.

**JAMES J. DONNELLY,**  
Gold and Silver Electro Plater,  
Fire Gilder and Colorer,  
41 and 43 Maiden Lane, New York.  
Prompt Attention Given to Mail Orders.

**F. JEANDHEUR, Jr.**  
Rear 17 John St., N. Y. Third Floor.  
Gold and Silver Plating  
SPECIAL WORK AND COLORING  
IN ALL SHADES A SPECIALTY.  
Established 1868. **Platina Plating.**

**Try Wells' Perfect Ring Adjusters**

1 doz. asst. sizes 10k gold filled (gold on front twice as thick as on back), \$2.00.  
1 doz. asst. sizes solid 10k gold, \$3.75.  
1 doz. asst. sizes metal, 50c. Ask your jobber for them, or I will send, prepaid, at once (only on receipt of price), two samples—one small and one medium large gold filled and one metal adjuster for 50c. Address

**CHESTER H. WELLS, Jeweler Meshoppen, Pa.**

## "Perfect Yourself"

In ENGRAVING and EXPERT WATCH WORK.  
Take a Post-Graduate Course.  
**RIES & ARMSTRONG, Macon, Ga.**

"PRACTICAL COURSE IN ADJUSTING."  
Price, \$2.50.  
All Jobbers or Jewelers' Circular Publishing Co



[Answers are also solicited from our readers to the questions published on this page.]

**QUESTION No. 1565.—Polish for Metals.**  
—Kindly give me a few recipes for metal polishes. T. W.

**ANSWER:**—One is: Carbonate of magnesia, 5 lbs.; elutriated colcothar, 6 ozs., 7 drms. Another is: Carbonate of magnesia, 5 lbs.; calcium carbonate, 5 lbs.; ferric oxide, 8<sup>3</sup>/<sub>4</sub> lbs. Mix thoroughly.

**QUESTION No. 1566.—Silvering Wood and Metals.**—How can I silver wood and metals without the use of the electric current? S. W. M.

**ANSWER:**—The following preparation is excellent for the silvering of wood or metal, and can be painted on the objects to be treated. Melt 24 grammes of pure tin in an iron ladle, and add the same quantity of bismuth. Stir with an iron wire until all is melted. Take from the fire, add 24 grammes of mercury, mix thoroughly and pour the mixture on a stone for cooling. When used, dilute with the white of egg, gilders' vermilion, or alcohol, to which a little gum arabic has been added. After applying, burnish the object.

**QUESTION No. 1567.—German Brown Color on Copper.**—During a recent visit to Germany I noticed many pieces of copper articles, especially lamps and novelties, that were finished in a beautiful brown color. How is this produced? A. G. B.

**ANSWER:**—Der Metalarbeiter gives a very good method for finishing copper articles, as follows: The metal is first made perfectly clean and a paste composed of 1 to 3 parts of English red and 1 part of graphite, thoroughly mixed with spirits diluted with one-half water, is applied with a soft brush, or a mixture of 2 parts of verdigris, 2 parts of cinabar, 5 parts of salammoniac and 5 parts of alum, finely powdered, ground with spirits of water, and with a little blue vitriol may be used. The metallic object is then heated very hot in an oven, and kept at a high temperature for several hours. After this the dry coating is brushed with soft brushes. The whole process is repeated several times, until the desired brown color is obtained. Finally, a mixture of equal parts of wax and turpentine is applied with a soft brush or with a wad of cotton.

**A Hint from a Subscriber.**

ELMIRA, N. Y., May 16, 1906.

**Editor THE JEWELERS' CIRCULAR—WEEKLY:**  
In your workshop notes and queries, in the issue of THE CIRCULAR—WEEKLY of April 25, I note your answer to R. F., on alloying gold, which is very good. As this question seems to puzzle a great many, I submit a simple calculation, that was taught me in my apprenticeship days, whereby any quantity of gold can be alloyed to any

quality desired. The method is as follows. Multiply weight of gold by quality. Divide by karat to be made, then subtract original weight of gold from amount and you have the quantity of alloy to be added. Example:—Suppose you have 25 dwts. of 18 karat gold and you desire to alloy to 14 karat.

Weight of gold.....	25
Quality of gold.....	18
-----	-----
	200
	25
-----	-----
Quality to be made, 14	450 32
	42 25 original weight.
-----	-----
	30 7
	28
-----	-----
	2

So you have 7 dwt. 2 grains of alloy to be added. A. R. S.

**The Enameling of Jewelry.**

By CECIL H. SHERMAN.

(Copyright, 1906, by The Jewelers' Circular Publishing Co.)

(Continued from issue of May 16.)

**M**OST enamel manufacturers and dealers in enamel have an assortment of colors that meet this requirement. It is well to send to two or three of these dealers for samples and pick out, say, two colors from each, grind them and charge a thin layer of each on a piece of metal (properly cleaned). Mark the ground color and place on the metal, so that you can remember which is which, and then hold this metal with a pair of soldering tweezers over the blue flame of a bunsen burner with the enamel side up. You can thus watch the enamel melt or "run." If you will take the first color that glosses over or "runs" as a standard, and try all of the others, picking out those that run at the same degree of heat, you will be pretty safe to order correctly.

After an article has been given two coatings of enamel, the next process is called stoning, or filing. Take a pine stick, about eight inches long, one-quarter of an inch thick and one inch wide. Cut notches or dents on the flat side, so that the article to be stoned will rest flat on the wood, enamel side up, and one edge will be about one-eighth of an inch from the end. Then cut the sides so that the same amount of wood projects beyond the article, and shape the other end so that you can grip it in the hand firmly.

With your medium and fine emery or carborundum files and a bowl of clean water, seat yourself at the bench in a good light; place the bowl under the bench, peg in the tray (which all jewelers' benches have), place the enameled piece in the

notches, grip the stick with the left hand so you can use the thumb to hold the piece flush with the stick if necessary, and then file off the surplus enamel, resting the stick on the bench peg. Use the coarser emery file, dipping it in the bowl of water every few seconds.

In filing a flat article, use the stone the same as a file. If "domed," be sure to follow the shape, and if an irregular surface it will be necessary to use the corner in a scraping manner. When the line or letters begin to show up light, change to a finer file, and be sure not to take off any more enamel than is necessary to bring up the lines or edges; when the edges are nearly "up," use your scraper. It takes some time before one can determine when all the lines are up, when the pieces are wet. If you have filed until you are satisfied, and you find that the surface (when wiped dry) is not dull all over, but has glossy spots on it, the coats of enamel were not changed evenly. The beginner can, without much difficulty, stone shallow spots, which can be determined by their lighter shade (when the stoned pieces are wet).

Take the stoned piece, wash with wet brush and clean water; then have the rubber developing tray half full of equal parts of hydrofluoric acid and water. Dip the washed pieces in this solution by means of tweezers or by stringing them on a wire for a fraction of a second; then rinse in clean water and dry with a clean cloth, one that is free from pit holes. Set on the rings, one of the plates and place them in the front of the muffle furnace, turning the plates around until all the steam has disappeared. Then place them in the back of the muffle and turn every few seconds until a smooth gloss appears upon them. The first gloss is a wrinkly effect, which soon becomes smooth. If the pieces be left in too long, the colors fade or the joints and catches come off or rot.

This operation is the test for the respective fusibility of enamels. If they all fuse at different heats, that is, if one runs smooth before another, there is trouble, unless the extra amount of heat which it takes to run them does not change the color or cause the softer colors to look as though they had sunk below the edges.

The next thing to do after "firing" the filed pieces smooth is to let them cool and place in the pickle pan. Cover with sulphuric pickle (not too strong) and boil them out. Rinse in clean water. For some purposes that ends the enameler's work. The edges are buffed bright and colored or plated, as the jeweler sees fit.

The electroplater or colorer often causes lots of trouble with enamel work. When a job is finished and given to the colorer it often comes from him with the enamel all chipped out and will have to be done over. This usually happens on some article that you are in a hurry for, and may occur two or three times on the same piece. The most successful colorer of enameled articles known to the writer was a man who derived his electric current from batteries.

(To be continued.)

About \$100 worth of watches were recently stolen from the second hand store of August Reiss, Eau Clair, Wis.

**C. DORFLINGER & SONS,**

36 MURRAY STREET, NEW YORK.

*Works, White Mills, Wayne Co., Penna.*Manufacturers of plain  
and cut Table Glassware  
of the highest quality.**ENGLISH :: GLASS.**

Large Assortment of  
FANCY VASES,  
GENTRE PIEGES and  
ROCK CRYSTAL STEM WARE,

Particularly adapted for the  
Jewelry Trade.

Write for particulars.

Sole Agent for the Celebrated CAULDON CHINA.

**EDWARD BOOTE,**  
46 West Broadway :: New York:

**Hat Pin Holders**

New, Practical, Pretty,  
and Quick Sellers.

No. 823.  
Hat Pin Holder.  
Ladore.

WRITE FOR PRICES.

**Maple City Glass Co.,**  
CUT GLASS TABLEWARE,  
**Hawley, Pa.**

SALESROOMS:

New York—H. B. Stites, 253 Broadway.  
Baltimore—Green & Thomas, 33 S. Charles St.  
Boston—Sweetser-Bennett Co., 101 Tremont St.  
Buffalo—J. R. Stadlinger, 685 Main St.  
Indianapolis—J. A. Dugan Co., 22 S. Capitol Ave.  
Duluth—Duluth Crockery Co., 6th Ave. and West St.  
Denver—Western Selling Co., 1617 Lawrence St.

**Jewelers, Notice!**

WE want one first-class Jeweler in every city and town to handle our line of CUT GLASS (exclusively).

**NEWARK CUT GLASS CO.,**  
Newark, N. J.

**THE CROHN PATENT SAFETY GUARD.**



For Scarf Pins adjustable one invented. Price, \$1.50 per doz. For sale by all wholesale jewelers and material houses. Sample by mail, 25c; in 10k. gold, \$1.00; 14k., \$1.25. M. CROHN, Maker and Inventor, 48 and 50 Malden Lane, N. Y.

Studs and Lace practical and only

**The Riviere Brass & Bronze Works**

cordially invite the Trade to inspect their new line of

**Electroliers, Chandeliers and Brass and Bronze Novelties**

now on exhibition in their new showrooms (recently enlarged) at

**328-330-332 Seventh Avenue**

(Between 28th & 29th Streets)

**NEW YORK CITY**

Established 1870.

Manufacturer of

**LOUIS W. HRABA,**  **Fine Leather Goods,**

29 East 19th St., New York.

Exclusively for the Jewelry Trade.

**JACOT MUSIC BOX CO.,**  
IMPORTERS.

Stella and Ideal Music Boxes,

39 UNION SQUARE, N. Y.

**CLOCKS, BRONZES, CUT GLASS and ART NOVELTIES.**

WHOLESALE DISTRIBUTORS **COMMUNITY SILVER** SEND FOR CATALOGUE

**H. BEALMEAR & CO.,** 234-236 Park Avenue, Baltimore, Md.

# THE CONNOISSEUR

*Devoted to Art Pottery, China, Marbles, Bronzes, Cut and Decorated Glass Ware, Bric-à-Brac, Lamps, Art Metal Wares, Fancy Goods and Kindred Lines.*



## A Porcelain Room in a Spanish Palace.

ANYTHING Spanish has a topical interest just now, and it is worth while to note that two of the palaces which King Alfonso will shortly share with his fair English bride possess "porcelain rooms." This form of decoration was employed by King Charles III. in the latter half of the 18th century. E. Dillon, in his valuable book on "Porcelain," says:

"The porcelain fever that raged at times in the rest of Europe seems to have left Spain untouched until the advent of the half-French half-Italian King in 1759. Charles III. . . . was an enthusiastic potter, and his first care, even before leaving Naples, was to see to the transshipping to Spain of practically the whole of the staff, to say nothing of the molds and other appliances in use at the Capo di Monte factory.

Nineteen modelers and 14 painters sailed for Alicante in a vessel specially chartered for this purpose. Among these Italian emigrants two names are worthy of mention—Buonicelli . . . and Gricci, the designer of the famous porcelain chamber at Aranjuez.

"The new factory, known as 'La China,' was erected in the garden of the Buen Retiro, a palace in the suburbs of Madrid. Here for the next 30 years; that is, until the death of Charles III., in 1788, supported by a large yearly grant, and surrounded by the strictest secrecy, was made the porcelain destined for the decoration of the royal palaces and for presentation to other courts. Only in the time of Joseph, Napoleon's brother, and of Ferdinand VII. was the ware from the royal works allowed to come into the market, and this was during a period of decline.

"The Buen Retiro gardens were the scene of desperate fighting between the English and the French in the year 1812, during which the porcelain works were completely destroyed. We hear, at the commencement, of quarrels between the Spanish and Italian workmen, and of breakdowns in the kilns. But Charles and his director, Buonicelli, must soon have surmounted the preliminary difficulties, for, during the years 1763 and 1765 (as we learn from an inscription on one of the slabs) Giuseppe Gricci was occupied in decorating the porcelain chamber, the famous 'Gabineto' of the palace at Aranjuez, which surpassed in magnificence the earlier room of the same description at Portici.

"The large plaques which surround this chamber are decorated with groups of Japanese figures in high relief, carefully modeled and painted. Between these plaques rise tall looking glasses brought from the

king's new glass works at La Granja, and the porcelain frames of these mirrors are elaborately decorated with fruits and flowers. There is another of these porcelain cabinets in the Royal Palace at Madrid;



PORTION OF PORCELAIN PANEL AT MADRID.

at this place the plaques are ornamented with children in high relief."

It is a panel in the decoration of the latter room which is the subject of our illustration.—*Pottery Gazette.*

## Reappraisements of Decorated China and Glassware.

REAPPRAISEMENTS of decorated China and glass ware have been announced in the last week by the Board of United States General Appraisers, New York, as follows:

Decorated glass ware from Hermann Holzner, Karlsbad, exported Feb. 17, 1906, entered at New York (File No. 39230); findings of Sharretts G. A.: 12 porter service, No. 6, walzen and rococo decor.; entered at 120, advanced to 160 crowns for 12 sets; 12 Bordeaux, entered at 110, advanced to 150 crowns for all; 12 champagne flach; entered

at 110, advanced to 150 crowns for all; 12 sherry, entered at 65, advanced to 95 crowns for all. And similar goods. Add packing.

Decorated china from Balleroy, Mandavy & De Mavaleix, and Gustave Balleroy, Limoges, exported Dec. 31, 1904, to Nov. 25, 1905, entered at New York and Baltimore (File Nos. 36128-29, 36568, 36753, 36800, 37277, 37360, 27369-70, 37552, 37796 and 34445); findings of Board No. 2: Prices as published in reappraisement No. 6049, Feb. 13, 1906. Reappraised value affirmed.

Blown glass ware from Anton Kopp's Son, Janstein, exported Dec. 20, 1905, entered at New York (File No. 38532); findings of Sharretts, G. A.: Entered at sample discount of 25 per cent. and discount of 5 per cent. Add case. Packing included. Advanced by disallowance of deduction of sample discount.

Opal glass ware from Robert Kuppert, Saron, exported Dec. 6, 1905, entered at New York (File No. 39662); findings of Sharretts, G. A.: Advanced by addition of packing charges.

Opal glass ware from Gebr. Hoffen, Bernsdorf, exported Feb. 28, 1906, entered at Boston (File No. 39664); findings of Sharretts, G. A.: 10-in. Welsbach domes, entered at 1.45, advanced to 1.60 marks per dozen. Add cases and packing. Discount 2 per cent.

## Auction Room Prices for Old China Glass, Etc., in England.

IN a recent sale at Halesworth a Lowestoft fluted cup and saucer, and another cup and saucer with bouquet of flowers, sold at 75s., and two Liverpool jugs made 36s. and 22s., while two Leeds teapots fetched 44s. and 28s. An embossed jug with silver luster edge realized 30s., a pair of silver lustre goblets and an ewer 50s., and a brown teapot, sugar basin, and cream ewer 42s.

The groups and figures in Walton, Salopian, and Staffordshire ware were a feature of the collection, but several of the most valuable were damaged. A pair (cows and calves) sold at 32s., and three pairs of spotted deer at 32s., 24s. and 18s.; a fine pair (cow and bull) made 5 guineas. Two—emblematical of Air and Fire—realized 54s., and a pair of musicians 52s. A watch case group in a garland of foliage realized 65s., three other groups 75s., 70s. and 75s., and a fine centerpiece, with two detached groups of sheep and lambs, 95s. A group of the four seasons sold for 50s., two figures of harlequins 50s., and a pair of Rockingham groups (Pointers), 52s. Twelve antique glasses, with intaglio stems, made 75s., and a pair of diamond-cut candlesticks, 48s.

Some pieces of old porcelain came up for sale at Christie's on March 16. In eggshell were a pair of oviform vases, 7¼ in. high, Yung-Chin period, 880 guineas; a bottle, 8 in. high, of the same period, enameled with rocks, peonies, and sparrows, 390 guineas; eight saucer-plates, 6¼ in. diameter, 425 guineas. A pair of old Chinese figures of boys, 11½ in. high, Ming Dynasty, fetched 650 guineas.—*Pottery Gazette.*



# ART Leather Goods

We now have on exhibition in our New York Salesroom a choice collection of  
**EUROPEAN NOVELTIES**

IMPORTATION ORDERS SOLICITED

**C. F. RUMPP & SONS**  
Philadelphia

New York Salesroom, 683 and 685 Broadway



No. 3399. Loving Cup. Height, 10 inches.

## The Pairpoint Corporation.

Send for Catalogue showing our complete line of

### Prize Cups and Trophies.

BRANCHES:

38 Murray Street, New York City  
36 St. Antoine Street, Montreal, P. Q.  
717 Market Street, San Francisco, Cal.

FACTORY: NEW BEDFORD, MASS.

## THE WASHBURN SECURITY Automatic Holders

for all sizes of scarf-pin wire. Guaranteed.

**MAGIC NUT**  
for ear studs, scarf pins, etc.



**EAR WIRES**  
for unpierced ears.



**SAFETY CATCH**  
For brooches, etc.  
Can be applied to any work where pin tongues are used.



Open. Closed. Open. Closed.  
Descriptive Circular on Application.

Pearl drilling and Adjusting a specialty.  
Special Order Work and Repairing.

C. IRVING WASHBURN, 12-16 John St., N. Y.

## DIAMOND POINT FOUNTAIN PENS



No. 2WC \$7.50 per dozen. Guarantee in every box.

Largest Manufacturers of Popular Price Fountain Pens in the United States.

Send for Illustrated price list of 14-Kt. Gold Fountain Pens. Good case assortment 1 dozen pens, \$9.00.

DIAMOND POINT PEN CO.

100-102 Beckman Street, New York

*Mercantile Fountain Pen*

## The Best Self-Filling Attachment

made and guaranteed by

**AIKIN, LAMBERT & CO.,** 19 Malden Lane, NEW YORK.

Retail Price:

**\$3.00**  
**\$3.50**  
**\$4.50**

Send for Price Lists and Discounts.





**THE TRADE**

desirous of keeping in touch with modern, profit-producing methods, should always consult the 500 pages of

**OUR BIG CATALOGUE,**

with its 30,000 illustrations and long list prices. We send this splendid book free on request.

**S. F. Myers & Co.**

Headquarters for Duober-Hampden Watches.  
WHOLESALE JEWELERS

The New 47C-49 Maiden Lane  
S. F. Myers Bldg. New York.



**It's the Little Things that count.**

The dainty little things that appeal at once to the casual observer. If it's useful, as well as ornamental, so much the better. Here is a LITTLE THING, so very useful and so pretty in design and finish, that you have but to show one to make a sale, and it yields a BIG PROFIT. It is called

**The Automatic Eye-Glass Holder**

Can be used as well for a Pencil Holder. It is made in Enamel, Gold, Silver and Rolled Plate, in a variety of artistic designs. We fully guarantee every Holder. We mean it, and will replace any Holder that fails to satisfy. Samples sent upon request. Send for catalogue.



Est. 1832. **Ketcham & McDougall, Manufacturers,**  
37-39 MAIDEN LANE, NEW YORK.  
ALSO MAKERS OF THE LEADING LINE OF TIMBLES.

**The ST. JAMES**

Corner Walnut and Thirteenth Streets  
PHILADELPHIA, PA.

**The Ideal Hotel of Philadelphia**  
European Plan EUGENE G. MILLER, Mgr.

**LEARN WATCHMAKING AT HOME**

by THE DE SELMS CHART SYSTEM, copyrighted and patented. The most simple, practical and up to the minute method of learning.

Saves you time and money while learning and puts you in a position to more than double your income.

80 million timepieces to be repaired. Accurate time is a necessity in the business world. When time is money the watchmaker gets his share of profit. Positions for graduates. Booklet free. Write to-day.

**The De SELMS WATCH SCHOOL,**

109 Perry Street, ATTICA, INDIANA.

**CROUCH & FITZGERALD**



**Jewelry Trunks and Cases**

177 Broadway,  
Bet. Cortlandt  
and Dey Sts.

688 Broadway,  
723 6th Ave.,  
New York.

**CRANBERRY LAKE  
REGION OF THE  
ADIRONDACK  
MOUNTAINS**

a section full of large fish is described in New York Central Lines Four-Track Series No. 32, which contains a beautiful map of this region printed in four colors. Copy will be sent free, postpaid, on receipt of a two-cent stamp by George H. Daniels, Manager, General Advertising Department, Room 61-A, Grand Central Station, New York.

THE



TAKE YOU TO THIS REGION FROM EVERY DIRECTION

C. F. DALY  
Passenger Traffic Mgr.  
NEW YORK

W. J. LYNCH  
Passenger Traffic Mgr.  
CHICAGO

**SIGNS**

OF all materials, engraved brass, sawed metal letters, carved wood, glass, etc. Electric signs for day or night.

"No trouble to ship out of town."

**THE FORMAN CO.**  
SIX LIBERTY PLACE  
NEAR MAIDEN LANE - NEW YORK.

**MAEBERT & REISS**  
WATCHMAKERS TO THE TRADE  
Wheel Cutters and Adjusters

Accurate Work—Low Prices—Quick Returns.  
We receive parcels by mail or express from all over the United States.

71 and 73 NASSAU ST., Corner John,  
(The New "Cockcroft" Bldg.) NEW YORK.

**PATENTS**

obtained on inventions and designs. Trade-marks, prints and labels registered.

**R. W. BISHOP,**  
ATTORNEY AT LAW,

908 G Street N.W., Washington, D. C.

**A. Nonnenmann & J. Aschenbrenner,**  
114-118 East 23d St., New York.

**Original Designers** for Platinum, Gold and Silver Jewelry. Artistic Designs for Silverware and Novelties furnished at shortest notice.

**JOHN S. STIVEN,**  
Gold and Silver Chaser.

Room 219, Electrical Exchange Building,  
156 LIBERTY STREET. NEW YORK.

**BLANCARD & CO.,**

96 MAIDEN LANE,  
NEW YORK.

WELL MADE GOLD FINDINGS.

**Eliassof Bros. & Co.**

IMPORTERS AND JOBBERS OF

**DIAMONDS  
WATCHES  
JEWELRY**

9-11-13 MAIDEN LANE,  
NEW YORK.  
100 STATE STREET,  
ALBANY, N.Y.



A LARGE ASSORTMENT OF DIAMOND MOUNTED JEWELRY CARRIED IN STOCK.

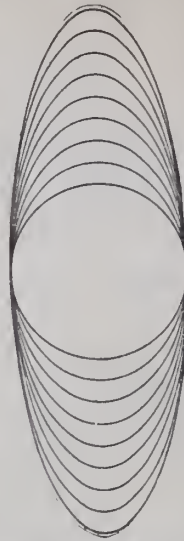
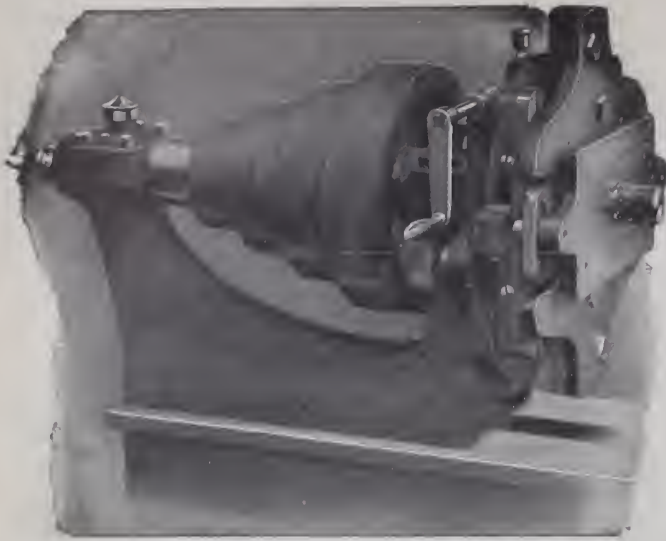

## Our Oval Spinning and Turning Lathe.

Our cuts show headstock of Lathe and variety of elliptics produced on same, retaining minor axis.

Write for our Catalogue of Spinning Lathes.

**P. PRYIBIL,**  
520 W. 41st Street, New York

**WM. F. RENZIEHAUSEN CO.,**  
**GOLD and SILVER REFINERS**  
Sweep Smelters, Assayers and Analytical Chemists  
Rolling of FINE AND STERLING SILVER a Specialty.  
Long Distance Telephone, 3759-R. 45-49 Oliver Street, NEWARK, N. J.

**MERIT:—**  
**DISPATCH:—**  
Two of the many pertinent factors that make us excel.  
**CONLEY & STRAIGHT,**  
Gold and Silver Refiners,  
Assayers and Sweep Smelters,  
236 EDDY STREET, - PROVIDENCE, R. I.  
Dealers in Fine Gold, Silver and Copper. All kinds of Gold and Silver Anodes.

**ROLLED GOLD PLATE**  
**SEAMLESS WIRE AND TUBING**  
**DUNBAR, LEACH, GARNER CO.,**  
MANUFACTURERS,  
ATTLEBORO, MASS.

**CASTINGS** Gold, Silver, Bronze, Brass, German-silver, Copper & Iron, Supply Jewelers, Silversmiths, Die-makers, Mould-makers, etc.  
L. D. Tel. 2072 L.  
Unbreakable Bronze Forces. Hard Bronze Engraving Plates. Cast Iron Forces for making Steel Dies. Chandelier, Undercut Work, Statuary.  
**AUGUST GRIFFOUL,** 313 HALSEY STREET, NEWARK, N. J.

**THREE WEEKS' DELAY! YES, BUT MUCH HIGHER RETURNS!**  
**ESTABLISHED IN 1870. LEES & SANDERS BIRMINGHAM, ENGLAND.**  
WE CAN SEND YOU NAMES ON YOUR SIDE WE ARE NOT MERELY COLLECTORS BUT THE ACTUAL SWEEP SMELTERS WHO HAVE TRIED US AND ARE SATISFIED

**HONEST AND PROMPT RETURNS FOR YOUR OLD GOLD, SILVER, FILINGS, SWEEPINGS & C.**

**WE BUY**  
Old Gold and Silver Filings, Polishings, Sweeps, Hand Washings, etc. We will make accurate valuations and hold consignment subject to your acceptance. If valuation is not satisfactory, we reship to you at our expense.  
**WE PAY FOR OLD GOLD:**  
22 K. 88c. per dwt. 12 K. 48c. per dwt.  
20 K. 80c. " " 10 K. 40c. " "  
18 K. 72c. " " 8 K. 32c. " "  
16 K. 64c. " " 6 K. 24c. " "  
14 K. 56c. " " 4 K. 16c. " "  
**MARKET RATES FOR SILVER AND PLATINUM.**  
Try us and you will appreciate our Squareness, Promptness and Accuracy.  
**T. B. HAGSTOZ, Ltd.,** Main Office, 709 Sansom St., Philadelphia, Pa. SMELTERS, ASSAYERS, REFINERS.

**WE SELL**  
Gold, Silver and Platinum, various qualities, rolled flat or drawn to wire of any gage.  
**PRICES OF ALLOYED GOLD:**  
10 K. 48c. per dwt. 14 K. 64c. per dwt.  
12 K. 56c. " " 16 K. 72c. " "  
18 K. 80c. per dwt.  
Gold and Silver Solder, either from formulas furnished or our own, "T. B. H." Alloy, 25c. per oz. Guinea Gold, 75c. per lb. Shot Copper, 40c. per lb. We will send tables for alloying without charge. They save figuring.

**PLATINUM AMERICAN PLATINUM WORKS**  
NEW YORK OFFICE 41 Cortlandt Street NEWARK, N. J.





P 2757



P 2758



P 2755

# Fahys Permanent Gold Filled Cases

A few patterns representing a magnificent line.

You better see the full line, both plain and engraved, open face and hunting—in all sizes.

These patterns ensure quick sales and are a guarantee against old stock.



P 2801



P 2805

JOSEPH FAHYS & CO.



P 2719



P 2796



P 2725

## We Knock Off the Middleman's Profit on Diamonds.

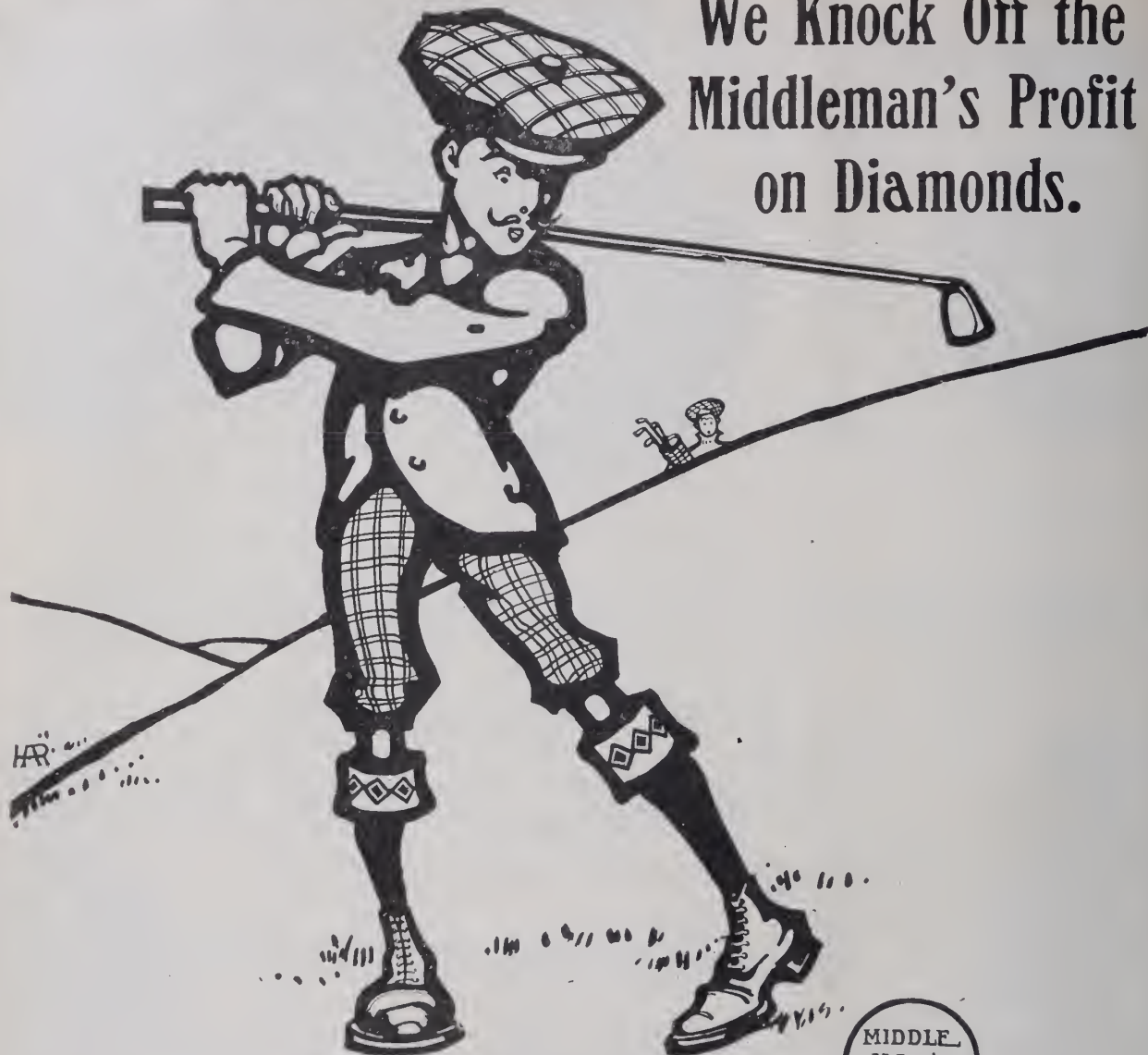

Fact I.—We cut our own diamonds in our own factory

Fact II.—We employ no salesmen.

Fact III.—We sell direct to the retail dealer.

Either, then, we make a 3-fold profit or we sell for lower prices. An easy way to prove whether the former or latter is true, is to send to us for a selection package and compare our prices with others' the next time you want any diamonds.

Buy direct from the cutter and you'll never fizzle on a sale.



# J. R. WOOD & SONS,

DIAMOND CUTTERS,

No. 2 Maiden Lane,

New York.



They will come to you for their wedding ring.  
Sell them the best wedding ring in the market.  
A ring you can unconditionally guarantee to be  
exactly what it is represented to be.  
A ring of our manufacture. With all its excel-  
lence it costs no more than inferior ones.

# J. R. WOOD & SONS,

RING MAKERS,

2 Maiden Lane,

New York.

# We Have Doubled our Line for the Fall Trade

in Vest Chains, Guard Chains, Fobs, Locketts, Grand Paris, etc., coupled with a large number of new ideas which we will not dwell upon at this time. When you see our line you will wonder at our new creations, and it will bother you to know how we can give you so much for the money. Don't mention it to anyone.

## Design, Workmanship, Quality and Durability

are the four factors which have made the

# BIGNEY CHAINS

the most popular in the market to-day. They are handled and worn by more people than any other make.

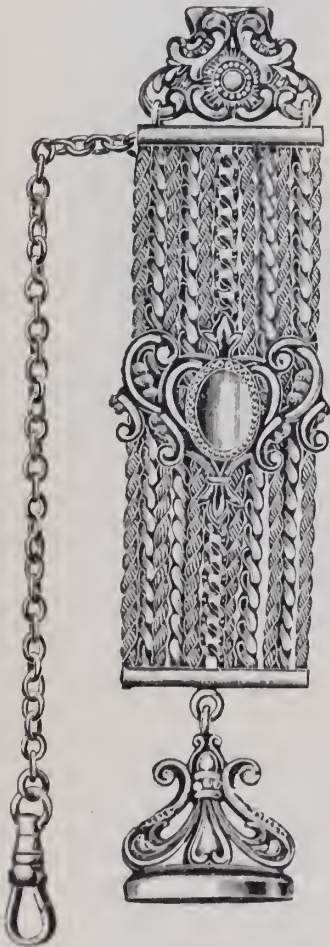

# S. O. Bigney & Co.

NEW YORK OFFICE,  
3 MAIDEN LANE.

FACTORY, Attleboro, Mass.

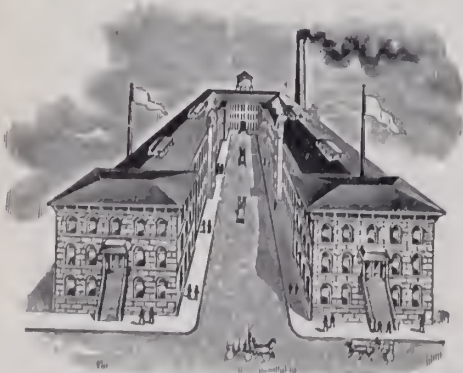



No. 301.



No. 302



No. 305.



No. 303.



No. 300.



No. 3.



No. 18.



No. 11.



No. 14.



No. 18.



No. 317.



No. 306.



No. 196.



No. 307.



No. 318.



No. 209.



No. 322.



No. 208.

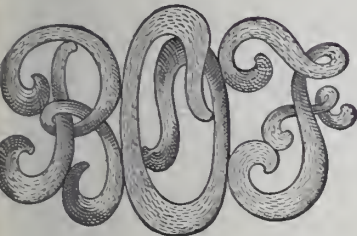

No. 316.



No. 321.



No. 320.

# Wendell & Company

MAKE

## GOLD MONOGRAM CHARMS, FOBS, SLIDES, BROOCHES AND RINGS.

SILVER MONOGRAMS for BROOCHES, BELT ORNAMENTS and CLASPS; also for LEATHER BAGS, PORTFOLIOS, MUSIC ROLLS AND ALL KINDS OF EBONY, IVORY AND TORTOISE SHELL GOODS.

ALL ORDERS PROMPTLY EXECUTED.

403 and 105 WILLIAM STREET  
NEW YORK

2 FACTORIES:

57 WASHINGTON STREET  
CHICAGO

## WADSWORTH PERMANENT

THE WORD "PERMANENT" naturally carries weight. Purchasers want *lasting quality*. This is as true of filled cases as of solid—maximum of wear is the final test.

### "WORTHY OF ITS NAME."

The above phrase is linked with the WADSWORTH "PERMANENT" WATCH CASE. To Durability is added Style; and to both, Inexpensiveness. Jewelers endorse these claims.

## *The* Wadsworth Watch Case Co.

CHICAGO  
Columbus Building

SAN FRANCISCO  
717 Market St.

NEW YORK  
49 Maiden Lane

FACTORY, DAYTON, KY.

---

The Case that has won the Permanent Friendship  
of all who have Made its Acquaintance.



Your Jobber can Introduce You.

## The Wadsworth Watch Case Co.

CHICAGO  
Columbus Building

SAN FRANCISCO  
717 Market St.

NEW YORK  
49 Maiden Lane

FACTORY, DAYTON, KY.

# JUNE

—a gift month

**H**AVE you considered how well Simmons Chains and Fobs fit June's gift occasions?



For wedding favors—the fobs for best man or ushers, the lorgnette chains for bridesmaids.

For commencement gifts.

For birthday remembrances.

Will it not be worth while to feature and push the Simmons line this coming month?

If you haven't an ample assortment of patterns to meet all demands of taste or price, your jobber will promptly supply any that your stock may lack.

---

---

**R. F. SIMMONS COMPANY**  
Main Office and Works, Attleboro, Mass.

SALESROOMS, 913 MAIDEN LANE, NEW YORK, 42 MADISON STREET (HEYWORTH BUILDING), CHICAGO



# Forceful Facts

Concentration of purchases has ever been regarded as a fundamental principle of sound business. The retail jeweler who spreads his purchases loses every advantage to be gained by concentrating his purchases on a few reputable lines. Small purchases from many lines can never benefit the buyer as large purchases from a few lines.

Particularly is this true in buying chains, and the retail jeweler who confines his purchases to Blackinton chains derives numerous advantages thereby. First and foremost he gets chains that are safe to sell: chains that have earned the distinction of "Old Reliable" because they have always lived up to the guarantee that goes with them.

All Blackinton Vest, Dickens, Waldemar, Pony and Negligee chains are now shipped with an aluminum coupon tag attached to the swivel, and the retail jewelers who buy them can have the tags redeemed in Globe Filled W. & S. B.  $\frac{1}{8}$  chains as follows: 100 tags—three chains free—75 tags—two chains—40 tags one chain, making a decided advantage to be gained by buying Blackinton chains.

Retail jewelers who use large quantities of chains have a chance to win either an Automobile, a Runabout, a Motorcycle, or a Watch Lathe, all of which we are to give away in January, 1907. Look for the Coupon Tag.

## W. & S. BLACKINTON CO.

NEW YORK:  
14 MAIDEN LANE

FACTORY:  
NORTH ATTLEBORO, MASS.



BLACKINTON



# Is There a Watch Trust ?

Is a Live Topic at the Present Time in Congress.

## **This Question Will be Fully and Ablly Elucidated**

and every jeweler is urged to keep posted on this subject, as it will be not only instructive, but profitable to know of abuses that are of vital interest to all who sell Watches.

Why should the retail jeweler have to pay more for Watches than do department stores and mail order houses and scheme trades? is an old question.

**And now comes another question of discrimination that is worthy of long discussion in the Congress of the United States.**

The essence of the question is:

**Why can American Watches be bought in other Countries for little more than half of what Americans at home have to pay for them ?**

All who have the interest of the Watch business at heart can have copies of the speeches on this subject sent on application.

## **The W. J. JOHNSTON COMPANY,**

Wholesale Agents for the Leading American Watch Companies,

**Fifth Avenue and Market Street, Pittsburgh, Pa.**

# **The W. J. JOHNSTON COMPANY,**

Wholesale Agents for the Leading American Watch Companies,

**Fifth Avenue and Market Street, Pittsburgh, Pa.**

We present a list of Watch Companies that we are Wholesale Agents for, each and all of whom are **Free, Independent** and **Self-respecting**, who manage and mind their own business, and depend only on the merits of their goods to make sales for them.

Not one of these Companies is a member of any Watch Trust or allied to any Watch Combination, and in no manner requires Alliances to help, or force, the sale of its products.

## **The Dueber-Hampden Watch Co.**

**Illinois Watch Co.      Hamilton Watch Co.**  
**Trenton Watch Co.    Seth Thomas Watch Co.**  
**New England Watch Co.**  
**Jos. Fahys & Co.    Wadsworth Watch Case Co.**  
**Dueber Watch Case Co.**

The products of these Companies are made for The American Market and they recognize the right of Americans to get as much for their dollar as do the people of other countries.



# The Realization of Perfect Coffee

is attained through the process of *distillation* in the STERNAU COFFEE MACHINE, which is the only proper way to make coffee, as it extracts *only* the good of the coffee bean. ¶ The Sternau Coffee Machine is so constructed that every part may be easily handled and thoroughly cleaned. ¶ Progressive jewelers are adding to the sale of their other goods by introducing our specialties. ¶ The Sternau Coffee Machine brings new customers to you. ¶ Write us for information about our specialties that have stood the test as profitable and ready sellers for many dealers. ¶ The Sternau Coffee Machine is made in copper, nickel plate and silver plate.

## S. STERNAU & CO.,

New York Salesrooms:  
PARK PLACE, cor. Broadway,  
Opposite Post Office.

MAKERS OF  
Chafing Dishes and Their Accessories,  
Trays, Fancy Kettles, Smoking Sets, Etc.

Office and Factory:  
195 PLYMOUTH ST.,  
BROOKLYN, N. Y.

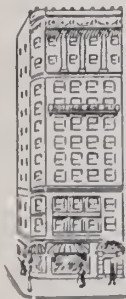

Our New Line for the Coming Season is NOW READY.



NEW YORK OFFICE  
820 FIFTH AVE. COR. 327 ST.  
IN THE "NEW WHOLESALE DISTRICT"

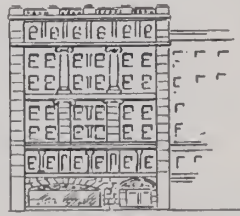

REMOVED FROM  
23 MAIDEN LANE.

# 2 Moves

## May 1, 1906.



NEWARK N. J.



TRADE MARK

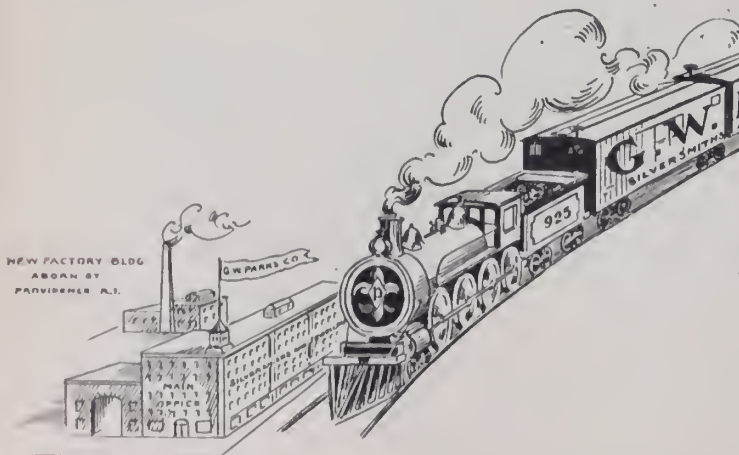

NEW FACTORY BLDG.  
BORN BY  
PROVIDENCE R. I.

This illustration shows our double move.  
MAIN OFFICE AND WORKS FROM NEWARK, N. J.,  
TO PROVIDENCE, R. I.  
NEW YORK OFFICE FROM MAIDEN LANE,  
To "The New Uptown Wholesale District"

# G. W. PARKS CO.

Makers of Sterling Silver Wares.  
PROVIDENCE, R. I.



GREAT MANY of the leading jewelers of America are pushing the sale of *ILLINOIS WATCHES* because of their superior quality.

If you are not entirely satisfied with the line of watches you have been selling, we would be glad to have you try a few of our manufacture.

We are sure you will find them satisfactory in every way and of greater value than comparative grades of other makes.

If your jobber does not carry them, write us for price list and discounts.

# Illinois Watch Company

## SPRINGFIELD.

Retail selling prices of  
Railroad grades established  
and maintained.

We Make

**BRACELETS**

both in Joint and Nethersole — with and without stones.  
Call on us for the P. & B. Co. lines of

FOBS, LOCKETS,  
TIE CLASPS, BROOCHES,  
SCARF PINS,  
HAT PINS.



BABY PINS, BEAD NECKS,  
CUFF BUTTONS,  
CROSSES, BRACELETS,  
AND WAIST SETS.



Potter  
&  
Buffinton  
Co.,

Providence,  
R. I.

NEW YORK OFFICE,  
65 Nassau Street.

San Francisco Office,  
206 Kearny Street.



Our New  
ACME  
Joint.  
Pat. May 22 1906.



## THE Bracelet Hit OF THE Season.

THE illustrations, which are exact size,  
show two of the best selling Brace-  
lets of a big bracelet season.

Made of Rolled Plate, Pierced, Engraved  
—a neat, strong joint and catch—with  
and without stones, from  $\frac{1}{2}$  to  $1\frac{1}{4}$  inches  
wide.

Our line offers an unsurpassed range  
of styles.

ASK YOUR JOBBER—HE HAS THEM.

**WHITING & DAVIS, Plainville, Mass.**  
NEW YORK OFFICE, 7 MAIDEN LANE.

*"We never follow the Fashion, the Fashions Follow Us."*

MAURICE L. POWERS.



*Always in Red.*

JOSH W. MAYER.

## Fashions.

**F**ASHION is never stationary—never of one mind for two Seasons. Her mission this Fall is to modify fads. Fashion is cleverly expressed in our new productions. Each piece of our goods has behind it the guarantee of a responsible maker, and back of that thirteen years of successful effort to realize an ideal by means of the best brains, the best finished mountings, the best material and best style American genius commands.

The question may be asked, what may be produced by simple means? The possibility of creating a certain distinction in one's own line of exquisite jewelry is given broad field for expression in our goods for the coming exhibition.

Simplicity in its refined phases shows its surpassing form in every possible piece of Diamond Jewelry in this conception. We point particularly to our exhibit of Platinum effects bearing that distinctive HALL MARK of Powers and Mayer.

In reference to our coming exhibition, to be held in our offices between August 13th and 18th, inclusive, we desire to state that the features advertised in the former issues of this weekly will, no doubt, create a new impression among the jewelers visiting this display of what can be accomplished in our line.

Once a visit always a visit.

### POWERS and MAYER,

Makers of Diamond Mounted Jewelry THAT SELLS.

258-260 Fifth Avenue,

NEW YORK.

We are always pleased to ship goods on memorandum when satisfactory references are given.

# BATES & BACON,

ATTLEBORO, MASS.

Makers of

HIGH GRADE CHAINS.

The BEST SAFETY FOB is one of our specialties; Gent's Vests, Dickens, Lorgnettes, Secret Locket Chains, Lockets, Chate-laines, and the unexcelled

## "Bates" Bracelet

"KANT-KUM-OFF"

We make these Bracelets in

### Seven Sizes.

Just on the market—A New Flat Seamless Wire Bracelet, made with the "WINNA" Joint and Catch. Patented.

Ask your jobbers for OUR GOODS.

New York Office, 9 Maiden Lane.  
Chicago Office, 103 State Street.



No. 32  
PATENTED



No. 51  
PATENTED



B. 125  
PATENTED

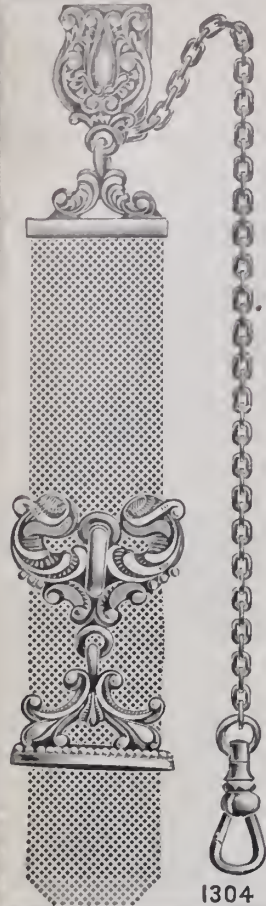

1304

GOLD

# RINGS

BROOCHES AND MOUNTINGS

Also GOLD FILLED RINGS, including the popular THREE CROWN

Ostby & Barton Company respectfully announce to the jobbing trade that their fall line comprising many new and original designs is now ready.

## OSTBY & BARTON COMPANY

New York, 13 Maiden Lane  
Chicago, 103 State Street

PROVIDENCE, R. I.





**S**ILVERWARE destined for the general service and adornment of the table should, in order to be wholly satisfying, possess not only a markedly decorative effect, but an opulent dignity and a well defined individuality of design.

¶ It is the belief of the Whiting Company that in their new Louis Quatorze pattern, which has been applied to every article suitable for table use, these essentials of success are very prominently displayed.

¶ With the confidence born of this belief, therefore, they beg to call attention to their novel and original treatment of one of the most popular, as it is one of the most effective, of historical styles.



**WHITING MFG. CO., SILVERSMITHS**  
Broadway and 19th Street, New York.

# The Allsopp Rings

THE UP-TO-DATE LINE OF  
**SIGNET AND SET RINGS**



In twenty years we have built up a business second to none in Rings exclusively. ALLSOPP QUALITY, DESIGN and WORKMANSHIP appeal to the most fastidious. It will pay you to examine a selection package.

**A ★**  
TRADE-MARK.

**ALLSOPP BROS.,** ALLSOPP BUILDING. Newark, N. J.



## BRACELETS

Carved,

Engraved,

Plain or

Mounted.

**C. P. GOLDSMITH & CO.,**  
33-43 Gold Street,  
NEW YORK.

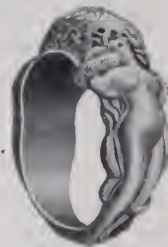

Everything New Under the Sun  
IN MODERN JEWELRY  
OF EVERY DESCRIPTION

## Signet Rings

(OUR OWN MAKE)

A SPECIALTY.

We Solicit Memorandum Orders.

**L. Witsenhausen**

47-49 Maiden Lane,  
New York.

Manufacturers MODERN JEWELRY  
of Chicago, 405 Masonic Temple.  
(L. KATLINSKY.)



"GRIP"  
The King of all card games, price 25c, sample pack 16c., two 30c., eight \$1.00. Sent prepaid at once (only on receipt of price). See last week's issue of Circular for prices of my Ring Adjusters which every jeweler should have in stock. Order 1 doz. asst. Enclose the amount. Mention order No. J and I will forward a sample pack of Grip extra. Order them to-day.

CHESTER H. WELLS, Jeweler, Meshoppen, Pa.

# The Bowden Rings

ARE COMPLETE IN VARIETY, CORRECT IN QUALITY AND PERFECT IN FINISH. WE MAKE EVERY VARIETY OF FINGER RINGS.

**J. B. BOWDEN & CO.,**

1 Maiden Lane.

NEW YORK.



**Q**UITE frequently you get a call for a cheap, good watch. Here is where the Betsy Ross comes in; a seven jewel, nickel, pendant set movement, in 20 year case, both case and movement guaranteed by the Keystone Watch Case Co. Sold at a very inviting price. Not listed. You can make a good profit and sell a satisfactory article. Put some in your stock and you will be more than pleased with the result. We have disposed of a good many and had lots of re-orders.

**Henry Freund & Bro.**

"SELLERS OF SELLERS,"

71 Nassau St., New York.

Elk and F. O. Eagle Goods a Specialty.

# Look for the Stamp

on back of



The Standard American Collar Button.

## Krementz Collar Buttons and Studs

### The Government Stamp

on every bar of gold issued by the U. S. Assay Office giving its Quality, Weight and Value, is known and accepted all over the world as absolutely correct.

### The Kremmentz Stamp

is universally recognized by dealers and wearers with the same confidence.



**KREMENTZ & CO.,**

49 Chestnut Street,

Dept. A.

NEWARK, N. J.

Send for booklet "The Story of a Collar Button"—Free



No. 1545.

# Finest Workmanship, Choicest Designs

ON OUR

Locket, Buttons, Brooches,  
Bracelets, Match Boxes,  
Penknives, Cigar Cutters,  
Bead Necks, Heart Charms,  
Scarf Pins, Tie Clasps, Fobs,  
ETC., ETC.,



No. 1549.

Mounted  
or  
Unmounted.

Write for  
Selection  
Package.

Give Us Material To Talk About.

That Is Why We Advertise

**10K. THAT IS 10K.**



No. 1548.

# ROBT. LEVY,

Manufacturing Jeweler,

Green and Columbia Streets, NEWARK, N. J.



No. 1547.

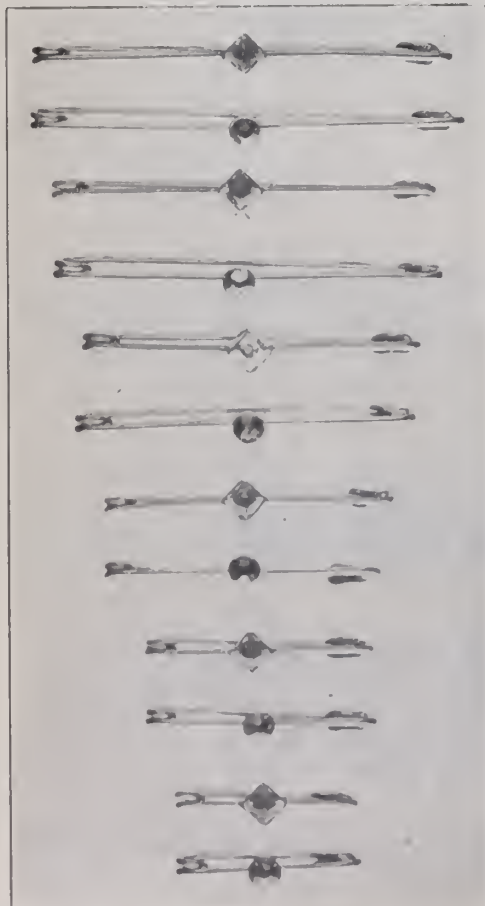

## All Smart Dressers

WEAR THE NEW SOLID  
GOLD SCARF AND  
HANDY PIN.

Made in sizes from  
1 inch to 2 1/4 inches.

Mounted with Stone or per-  
fectly plain.

They are brisk sellers and  
profitable to handle.

Write for prices.

**SCHULTZ, LEISS & CO.**

OFFICES:

14 John Street, New York. 103 State Street, Chicago.

FACTORY: Cor. McWhorter and Oliver  
Streets, Newark, N. J.

## THE WASHBURN

**SECURITY** **MAGIC NUT**  
Automatic Holders for car studs, scarf pins,  
for all sizes of scarf-pin wire. Guaranteed. etc.



**EAR WIRES**  
for unpierced ears.



**SAFETY CATCH**  
For brooches, etc.  
Can be applied to any  
work where pin tongues are  
used.



Open.



Closed.



Open.



Closed.

Descriptive Circular on Application.

Pearl drilling and Adjusting a specialty.  
Special Order Work and Repairing.

C. IRVING WASHBURN, 12-16 John St., N. Y.

## Expert WATCH and Chronometer REPAIRING FOR THE TRADE.

When others fail you we guarantee satisfaction.  
A trial will convince. Prices very reasonable.  
List will be sent on request.

**G. OHAN, 37-39 Malden Lane,**  
Lorsch Bldg., Room 27. **NEW YORK.**

## JOHN S. STIVEN, Gold and Silver Chaser.

Room 219, Electrical Exchange Building,  
**136 LIBERTY STREET. NEW YORK.**

# ZIMMERMAN'S ELK MASTERPIECE.

Ever on the alert to improve our already most popular line of Elk emblems, we have added what we consider the most wonderful reproduction of an Elk head in gold ever attempted. This is known as the Zimmerman Masterpiece of an Elk.



This Elk head is an exact reproduction in gold of Zimmerman's masterpiece, "The Elk," which is world famous, having received prizes at every exhibition where shown. Every line in the painting has been faithfully reproduced by us in the emblem.

We are making this head in two sizes (medium and small), in both gold and silver, and in various finishes, also combining it with the dial, with and without diamonds and other precious stones. If your jobber does not handle our line, send for a selection package. Our Phenomenal success has inspired many imitations. There is but one line of FOX Emblems, and all goods of our make are stamped with this trade-mark:  A quantity or low price may sell the first bill, but quality as well is required to get succeeding orders. Our goods are of the highest standard of quality.

## THE GUSTAVE FOX CO.,

14-16 East Fourth Street, Cincinnati, Ohio.

Branches in Antwerp and Oakland, Calif. (Temporarily).

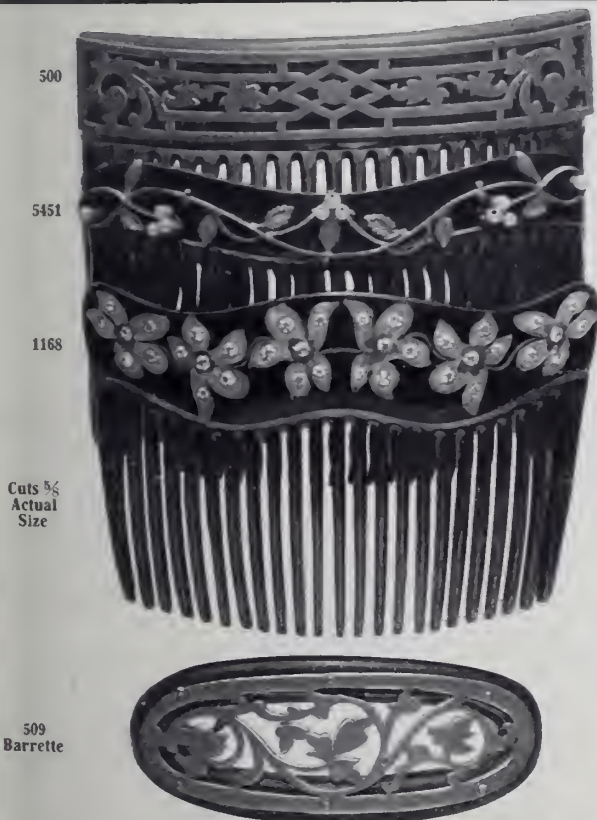

# Tortone Combs

Jewelry stores everywhere are having a big run on **TORTONE SHELL COMBS**. Each mail is bringing scores of orders—better add yours to the incoming volume.

**TORTONE SHELL COMBS** are the only logical substitute for tortoise shell, and besides they wear better. They offer the widest choice—artistic and exclusive designs, rich and novel effects unmatched elsewhere. We make the largest shell line shown in America.

You can make a handsome profit selling **TORTONE SHELL GOODS** and still be giving your trade astonishing values. We'd like to submit samples on their merits. If they are not satisfactory return them. Terms—2 per cent., 10 days; 30 days extra.

Write to-day.

500.—Hand carved 14-K. gold plated band, bright polish, per dozen, **\$8.50.**

5451.—Rose-gold finish, spray mounting, set with 11 pearls, per dozen, **\$9.00**  
—side combs to match, per dozen pairs, **\$16.50.**

1168.—Hand painted violets, inlaid with 36 brilliant rhinestones, per dozen, **\$15.00**  
—side combs to match, per dozen pairs, **\$24.00.**

509.—Hand carved 14-K. gold plated polished barrette, per dozen, **\$7.50.**

**E. & J. BASS,**

MAKERS OF TORTONE HAIR ORNAMENTS,  
573-575 Broadway, New York.

# Grace of the Lorgnette Chain.



EXPERIENTIA  
DOCET

IF WATCH AND CHAIN belong together, even more do Chain and Lorgnette. The latter are made for one another, being really a unit—component parts of one design. Fifty years of pre-eminence in these lines. Lorgnette Chains from

\$30.00 to \$300.00.



EXPERIENTIA  
DOCET

**Durand & Company,**

49-51 Franklin Street,  
Newark, N. J.

## A COMPLETE LINE

of some of our handy pins. Made in all colors, sizes and finishes.

**A. J. HEDGES & CO.,**

Makers of Exclusive Designs in 14K. Jewelry,  
14 JOHN STREET, NEW YORK



TRADE-MARK

## SOLID GOLD CHAINS

Gold Chains that don't have to first pay the heavy expenses of traveling salesmen, before a selling price is placed on them, are chains that to-day are interesting the careful and exacting buyer.

WE are the makers of just such

## SOLID GOLD CHAINS

TRADE MARK



Are YOU one of these careful and exacting buyers?

For 56 years critical Jewelers have found our Chains ready sellers, very profitable to handle and most durable in service.

We have no salesmen, and our prices are therefore very low. We will be pleased to send you a selection package.

1850 1906

**ALOIS KOHN & CO.**

Makers of  
**SOLID GOLD CHAINS**  
of every kind.

16-18 Maiden Lane  
New York

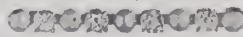

TRADE MARK

## OSMUN-PARKER MFG. CO.

MAKERS OF

Fine Pearl and Diamond Goods

338 Mulberry Street, NEWARK, N. J.

ESTABLISHED  
1871.

Factory and Office: Newark, N. J.

INCORPORATED  
1900.

# CARRINGTON & CO.,

## Patent Pocket Match Box

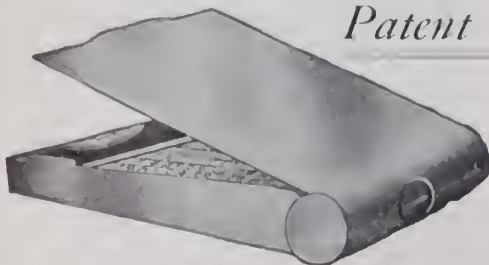

Book Safety Matches with  
Steel Cigar Cutter.  
(Patented.)

Sales Agent:

7 Maiden Lane,  
NEW YORK.



14K. ONLY IN STOCK.



## M. SCHIFF

Established 1876

82-84 Nassau St., N. Y.

'Phone 801 John.

Manufacturer of fine  
Diamond Mountings, Lockets  
and Buttons. Patentee of

THE NEW IMPROVED

## Ear Screw

The only one on the market  
of its kind, absolutely secure  
Special attention paid to all  
order work.



## Fancy Bead Necklaces

**A** CERTAIN DELICACY in their decorative effects has won for our Fancy Bead Necklaces established place and merited appreciation.

On no goods does the dainty Vermicilli Decoration appear to better advantage—a specialty with us.

Plain Graduated Necklaces. Also Fancy Graduated. Alternated Beads, Plain and Vermicilli; also the latter in straight sizes.

The arrangement, color and finish of these goods give them distinction.

## Day, Clark & Company

14 KARAT ONLY

23

Maiden Lane  
New York



## WHITESIDE & BLANK



COLLAR PIN NO. 7037  
HANDY PIN NO. 5012

*Made in One Piece, 14 Karat Gold,  
with Pearl or Fancy Stone Center.  
Polished, Roman or Rose Finish.*

NEWARK, N. J.,  
Lafayette and Liberty Streets.

NEW YORK,  
14 and 16 John Street.

ESTABLISHED 1841.

## Carter, Howe & Co.

TRADE



MARK

MANUFACTURERS OF

## Gold Jewelry,

9, 11, 13 MAIDEN LANE, - NEW YORK.

FACTORY, NEWARK, N. J.

A. CARTER.

G. R. HOWE.

W. T. CARTER.

W. T. GOUGH.

## SCARF PINS

TRADE  MARK

Established in New York 1837.

## Geo. O. Street & Sons.

24 JOHN ST., NEW YORK.  
103 STATE ST., CHICAGO.



Quality and  
Finish Consistent  
With Twenty  
Years' Experience

✦

Original and  
Exclusive  
Designs



MOORE & SON,

NEWARK, N. J

ESTABLISHED  
1886.

INCORPORATED  
1903.



Adjustable  
Solid Gold

## Glove Garters

in Gold, Silver and Plated.  
**THAT NEW THING.**  
**OUR**

Showings of Gold, Gold Filled and Silver Jewelry for Spring are complete in

Brooches	Crosses
Links	Rosaries
Scarf Pins	Fobs
Bracelets	Combs
Hat Pins	Waist Sets
Buckles	Collar Supporters
Dog Collars	La Vallieres
	etc.

Chas. L. Trout & Co.

15 Maiden Lane, New York.

# ALLSOPP & ALLSOPP'S

HIGH CLASS  
**BRACELETS**

MOUNTED IN COMBINATIONS OF

Dia. and Pearl  
Dia. " Sapphire  
Dia. " Emer'lds  
Dia. " Baroques

Amethysts  
Topazes  
Peridots  
Aquamarines  
Etc.



18-20 COLUMBIA ST.



NEWARK, N. J.

"THE BRACELET HOUSE."

## KENT & WOODLAND,

BRACELETS FOR EVERY WOMAN AND MISS.

16 John Street, New York.

"Nethersole Bangles,"  
Plain and with Stones.

---

San Francisco Office,  
Care JULIUS A. YOUNG.

"Pinhole" Secret Snap,  
with and without pre-  
cious and semi-precious  
stones.

## Silver Deposit

Iridescent and  
Green Glass

ALSO IN

## Crystal Glass



**BASKETS** in all shapes.  
Great sellers for wed-  
dings, etc. Always appro-  
priate and acceptable gifts.

Only House to Decorate These in  
Silver. Phenomenal Sellers.

Depasse Manufacturing Co.  
41-43 Maiden Lane, New York

THE CROWN PATENT SAFETY GUARD.



For Scarf Pins  
The most  
adjustable one invented. Price, \$1.50 per doz. For sale  
by all wholesale jewelers and material houses. Sample  
by mail, 25c; in 10k. gold, \$1.00; 14k., \$1.25. M. CROWN,  
Maker and Inventor, 48 and 50 Maiden Lane, N. Y.

Studs and Lace  
practical and only



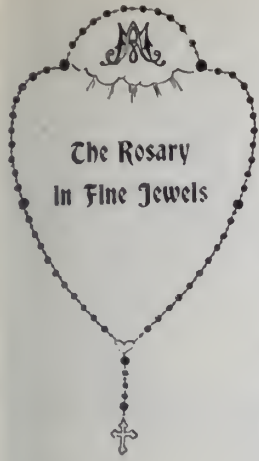

The Rosary  
In Fine Jewels

Fine Rosaries in pure and imitation stone. Mounted in solid gold and rolled gold-plate

ALL COLORS.

Our special illustrated catalogue will give interesting advice regarding prices and discounts.



MADE BY

The **W. J. Feeley Co.**

Providence, Rhode Island,  
Ecclesiastical Art Metal Workers.

**SAM'L BUCKLEY & CO.**  
English Fancy Goods.



Carry in New York a full line of  
**ENGLISH PLATED WAITERS.**

118-122 Holborn, E. C.,  
London, England.

100 William St., New York.

## Bridesmaids' and Ushers' Pins

We would suggest something with color. Brooches, Scarf Pins and Handy Pins with Amethysts, Topazes, Garnets, Peridots, Aquamarines, Jades and Baroque Pearls. We have a large variety of patterns at moderate prices.

REGARDING OUR FOBS WE HAVE NOTHING TO SAY—  
THEY SPEAK FOR THEMSELVES.

**S N O W & W E S T C O T T,**

Makers of Good Jewelry for Over Seventy Years,

21 MAIDEN LANE,

NEW YORK.



## S. Cottle Co.

are showing an entirely new and exclusive line of Gold and Silver BAGS and PURSES, also many lines of BRACELETS—all of superior workmanship and design.

31 East 17th Street,  
New York.

ADOLPH LUTHY.

**LUTHY & HINE,**

PERCY W. HINE.

13 EAST 30TH STREET, - NEW YORK.

MANUFACTURERS OF

**Artistic Gold and Platinum  
Mounted Diamond Jewelry.**

Odd and Exclusive Patterns in NECKLACES, BROOCHES, BRACELETS,  
RINGS, RIBBON COLLARETTES, Etc.

MOUNTED WITH AQUAMARINES, PERIDOTS, AMETHYSTS  
AND OTHER PRECIOUS STONES.

(DIAMOND MOUNTED COMBS A SPECIALTY.)

## Ribbons

in stock and special designs **MADE to ORDER**, in large or small quantities, to use with medals and for club purposes. Correspondence invited.

JOSEPH LOTH & CO., Manufacturers, 65 Greene Street, New York.

# THE MOUNTING THAT SELLS

Earscrews,  
Earrings,  
Studs,  
Scarf Pins,  
and Rings  
of every description.



Made in  
Platinum,  
18K.,  
14K.,  
all sizes.

It gives light and brilliancy to the stone.

Manufacturer of a general line of Platinum,  
18K. and 14K. Mountings.  
Prompt attention given to special order work.  
Estimates and designs submitted.  
Diamonds recut and repaired.

## JULIUS WODISKA,

40 JOHN STREET,

NEW YORK.

# Koshland & Italic Co.

702 Chestnut Street,

PHILADELPHIA, PA.

¶ You must be satisfied  
with everything you  
buy of us.

¶ If you are not, let us  
know and you soon will  
be.

Diamonds, Watches and Jewelry

# MONOGRAMS.

In Gold, Silver and Plate.

A complete line of Two  
and Three-Letter Mono-  
grams always in stock.

SPECIAL DESIGNS TO  
ORDER.

Elegant  
Silk Ribbon  
and  
Leather Strap  
FOBS.

Always  
Acceptable as  
Gifts.

A Beautiful Solid  
14-K. Gold  
Monogram Fob  
with Ribbon and  
Swivel, complete,  
any three  
letters desired,  
for  
**\$10.00**

Send for new  
Illustrated Catalogue,

showing the largest  
selection of stock  
Fob Monograms,  
from 50c. in Gold Plate  
upward.

Create a demand for  
these Fobs by display-  
ing a few samples in  
your window.



1260.

WIDE STRAP FOB.  
English Pig Skin, Tan or  
Black, Take your choice.  
Monograms to order, two  
or more letters, same  
price.

**OUR  
SPECIALTY:**

Gold Plated... each \$4.50  
Gold Filled... each 7.50  
14-karat Gold, each 15.00  
MONOGRAMS  
AND INITIALS FOR  
POCKET BOOKS,  
BAGS, ETC.

Send for Fob and Monogram Catalogue  
or other information to

**Thomas J. Dunn & Co.,**  
101 and 103 Chambers St.,  
Dept. J. NEW YORK CITY.



Timer is 1/8 Larger than cut

THE OLD RELIABLE  
**Centennial**

SPLIT SECOND TIMER

*"None better made"*

Now is the time to order TIMERS for the Spring and Summer trade—suitable for racing purposes or for mechanical uses.

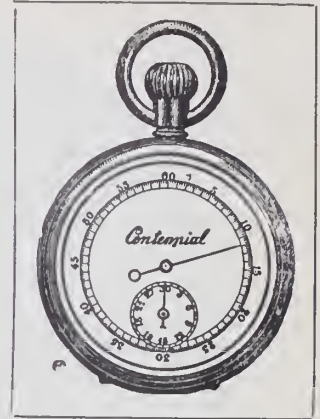

Timer is 1/8 larger than cut

**CROSS & BEGUELIN,** Manufacturers, **New York.**



**To Jobbers Only—**

When you think of Toilet Goods, please remember us. Our goods are high grade and can be retailed at popular prices.

*Special Terms on Early Business*

**Art Stamping & Mfg. Co.**

411 Commerce Street, PHILADELPHIA, PA.



**FANS**

Fan Season is here, and we are prepared for it with the choicest line that has ever been imported from Paris. These dainty creations are appropriate for Graduation, Confirmation, Weddings, and in fact for any occasion where taste and exclusiveness are requisite.

SEND FOR A SELECTION, MENTIONING PRICE

**LEWY & COHEN**  
530 BROADWAY, NEW YORK

Importers of Fans, Brooches, Mounted Side and Back Combs, French Bead Necklaces in mother-of-pearl effects, and THE "MEDICI CHAIN," a new French creation in fan chains.

**RINGS**

**WM. LOEB & CO.**

101 Sabin St.,

Providence, R. I.

New York Office, 37 Maiden Lane.

**REMOVAL NOTICE**

We now occupy the new store of

**The Lorsch Building, 35 Maiden Lane, N. Y.**

**WOLFSHEIM & SACHS**

MAKERS OF

**Fine Boxes, Trays and Novelties for Jewelers and Silversmiths**

**35 MAIDEN LANE, N. Y.**

Telephone, 3518 John.

Factory, 10 Gold Street.

**Trade-Marks** of the Jewelry and Kindred Trades.  
Second Edition. Price, \$3.00. The Jewelers' Circular Publishing Co., 11 John St., New York.

Design  
Illustrated

No. 7957

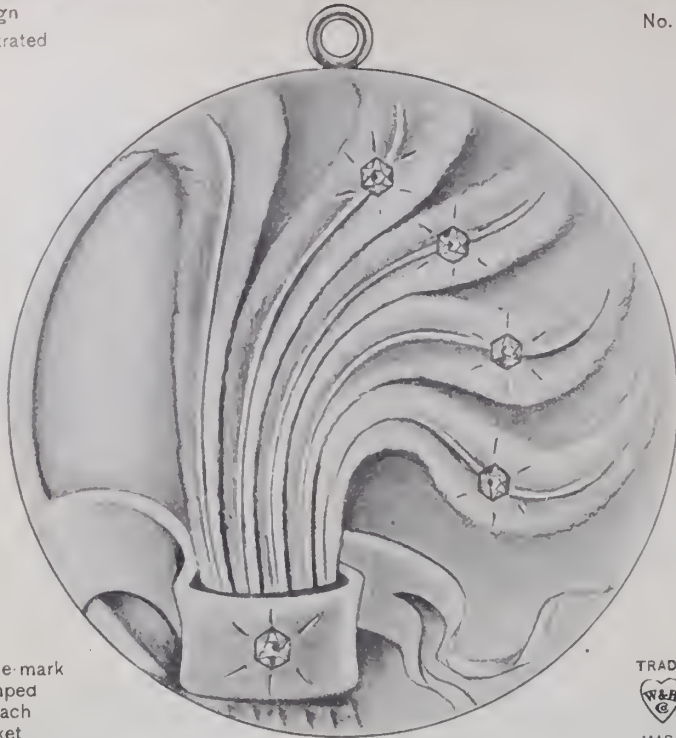

Trade-mark  
stamped  
in each  
Locket



Our **LOCKET** creations continue to be the standard for workmanship and design. Originality and quality have combined to render the excellence of W. & H. Locketts unsurpassed.

3 Maiden Lane  
New York **Wightman & Hough Co.** Providence, R. I.

## Boston Jewelry Manufacturing Co.

### The Mounting and Repairing House of New England.

We eclipse all others in design, quality, promptness and finish of work.

A line of entirely new styles in mountings always on hand.

**Jewelers' Building,  
BOSTON, MASS.**



14K. Gold on Sterling Silver.

In looking over your jobber's line, it is more than possible that you will be shown attractive brooches, scarf pins, hair ornaments, etc., of plain design and rhinestone set. **Don't purchase until you have seen our goods and prices.** Our 14K Gold on Sterling Silver, creations, as shown in this season's styles, defy competition. Ask your jobber to show you these goods. You'll miss an opportunity if you don't.

**The MACKEY JEWELRY CO.,**  
235 EDDY STREET, PROVIDENCE, R. I.

## BARRETTES

If one will pause for a moment to consider Quality, Price and Design, the conclusion is always the same, we have the Premier Line. This applies to Barrettes, and the A.O.T.G. Lines of



- |            |                  |
|------------|------------------|
| Combs      | Baby Pins        |
| Brooches   | Crosses          |
| Scarf Pins | Waist Sets       |
| Bracelets  | Hat Pins         |
| Barrettes  | Collarettos      |
| Buttons    | Silver Novelties |

ALWAYS  
ON  
THE  
GO.

**MILLER, FULLER & WHITING,**  
MANUFACTURING JEWELERS,  
N.Y. Office, 9-11 Maiden Lane. N. ATTLEBORO, MASS.

LOOK FOR THE TRADE-MARK



**Ladies' Fancy Stone Rings  
and Stone Scarf Pins  
in 10K. that defy  
competition.**

Our reputation for making the finest and most complete line of 10-K. gold band rings is still maintained—ask your jobber.

THE  
**EDWIN LOWE & CO., Inc.**  
F. W. BODWELL, V.-Pres. and Gen. Mgr.,  
116 Chestnut St., PROVIDENCE, R. I.  
New York Representative, E. T. Wilson, 180 B'way.  
Western Representative, S. H. Brower.

## OUR Silver GOODS

Jewelry and Novelties are Original, Artistic and Sellers. Our name stands for the best of everything in our line at our prices.

**THE W. H. SAART CO., Attleboro, Mass.**  
OFFICES: 713 Market St., San Francisco.  
103 State St., Chicago. 204 St. James St., Montreal.  
49 Maiden Lane, New York.



Tilet Goods  
Wrist Bags  
Buckles  
Bracelets  
Hat Pins, etc.

**W**ait

**A**nd See

**I**n the "Celebrated Case"

**T**his Season's New Goods.

**E**very one a Seller

**T  
H  
R  
E  
S  
H  
E  
R  
'  
S  
  
G  
O  
O  
D  
S  
  
S  
E  
L  
L**

**Waite-Thresher  
Company**

61 PECK ST., PROVIDENCE, R. I.

7 Maiden Lane,  
NEW YORK.

1203 Heyworth Bldg.  
CHICAGO, ILL.

1876

1906

# Hutchison & Huestis RING MAKERS

FACTORY, - - - PROVIDENCE, R. I.

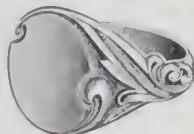

*Jade is in vogue  
See our Jade Rings*

JOBGING TRADE ONLY

NEW YORK,  
3 Maiden Lane.

CHICAGO,  
Columbus Bldg.  
Harry H. Miller.

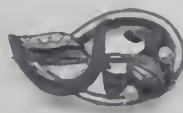

## BROOCHES

WE have over four hundred styles of Gold Brooches set with all the popular stones in vogue; not at fancy prices, but at figures that cause them to sell.

We have Gold Barrettes in a variety of shapes and styles.

*Insist upon seeing the designs  
of Gold Jewelry made by the*

**E. L. SPENCER COMPANY,**

*Makers of Gold Jewelry for the Jobbing Trade.*

ORDERS PROVE OUR GOODS SELL.

95 Chestnut Street,

PROVIDENCE, R. I.

New York Office, 9-11-13 Maiden Lane.

SAMPLES ONLY.

ESTABLISHED 1861.

**R. BLACKINTON & CO.,**3 MAIDEN LANE, NEW YORK.  
FACTORY, NORTH ATTLEBORO, MASS.**Manufacturing Jewelers and Silversmiths.**TRADE  MARK.

Toilet and Manicure Articles, Flatware, Sterling and German Silver Wrist Bags, Gent's and Ladies' Card Cases, Vanity Boxes, Jewel Boxes, Match Safes, Picture Frames, Belt Buckles, Cigarette Cases, Penknives and up-to-date Novelties.

ROSWELL BLACKINTON ESTATE, W. B. BALLOU,  
WALTER BALLOU, J. R. MORSS. R. BLACKINTON, Jr.

EVERYTHING IN LOCKETS AND CHAINS.

THE BASSETT JEWELRY CO.,  
PROVIDENCE, R. I.

Established 1855.

**ADAMS & SINGLETON,**



Successors to BROOKS &amp; PIKE,

Manufacturers of

**Fine Diamond Mountings.**

Special Attention Given to Order Work.

364 Washington Street, Boston, Mass.

- 
1. Snap complete.
- 
- 
2. Outside of Snap.
- 
- 
3. Inside of Snap.

**The E. P. H. Patent  
NON-PULL-OUT  
Neck Chain Snap***is a patented snap that insures  
the wearer against loss of***CHAIN or CHARM**  
for it positively will not pull outMade in 10 and 14 Karat Gold and  
in Gold Filled.*Can be had of the following Whole-  
sale Selling Agents:*Messrs. W. Green & Co.,  
81 Nassau St., New York.  
M. Sickles & Sons, Philadelphia  
E. A. Cowan & Co., Boston  
E. & J. Swigart, Cincinnati  
Swartchild & Co., Chicago  
Nordman Brothers, San Francisco  
Leonard Krower, New Orleans  
Bauman-Massa Jewelry Co.,  
St. Louis**PRICES.**14 Karat—Small, \$7 per doz. net  
Large, \$7.50 per doz. net  
10 Karat—Small, \$6 per doz. net  
Large, \$6.50 per doz. net  
Gold Filled—Small, \$2 per doz. net  
Large, \$2.25 per doz. net**The Premier Repairing  
House of New England**JEWELERS, SILVERSMITHS,  
STONE, METAL, SEAL ENGRAVERS  
AND INCRUSTERS.LAPIDARIES AND DEALERS IN  
PRECIOUS AND IMITATION STONES**REPAIRING**FANS AND OPERA GLASSES.  
INLAYING SILVER MONOGRAMS AND  
INSIGNIA IN PIPES.  
GOLD PLATING.**H. E. ALSTERLUND & CO.,**387 WASHINGTON ST.  
AND 12 BROMFIELD ST.,  
BOSTON, MASS.  
*All work positively Done in Our Own Factory.* *Write us for terms and information.***The ST. JAMES**Corner Walnut and Thirteenth Streets  
PHILADELPHIA, PA.**The Ideal Hotel of Philadelphia**  
European Plan EUGENE G. MILLER, Mgr.

# TALK

of the right kind  
**HELPS ANY BUSINESS**



## REIS' Advertising Tape

talks right to the point. **Common Twine** costs money and brings no returns—**Reis' Advertising Tape** costs a little more but brings trade to your store. No novelty at many times the cost can show the same results.

In Colors and Widths to Suit.  
Write for Samples and Prices.

### G. REIS & BRO..



640 Broadway, New York.

**Trade-Marks** of the Jewelry and Kindred Trades.  
Second Edition. Price, \$3.00. The Jewelers' Circular Publishing Co., 11 John St., New York.

Supremacy  
of the  
"Egyptian"  
Pearls.

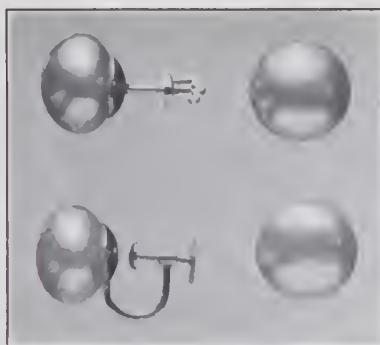

Ear Drops,  
Scarf Pins,  
Rings,  
Studs, etc.

THE IRIDESCENCE, perfection of color, and natural weight of "EGYPTIAN" Pearls render them superior to all other artificial pearls. The illustration shows some of our Ear Drops, with attachments for either pierced or unpierced ears. Pearls are shaped round for mounting in point settings, and flat top or button shape for invisible cup settings. The mountings are in 10 and 14 karat gold.

### GEORGE H. CAHOONE COMPANY,

Makers of Artistic Jewelry.

PROVIDENCE—7 Beverly Street.

NEW YORK—9 Maiden Lane.

## Roger Williams Silver Co.,

PROVIDENCE, R. I., AND NEW YORK, 860 BROADWAY.

### Sterling Only.

*RICH DESIGNS :: :: :: Photos on Application.*

**WM. SMITH & CO.,** Office, 9-13 Maiden Lane, N. Y. **Manufactory, 61 Peck St., Providence, R. I.**

Established 1854.

Manufacturers of

## GOLD AND SILVER CHAINS,

Gold, Silver and Plated Chain Trimmings,

Also GOLD AND SILVER KEY CHAINS AND BRACELETS.

## E. H. H. SMITH SILVER CO.

BRIDGEPORT, CONN.

Silversmiths' Building,  
CHICAGO, ILL.

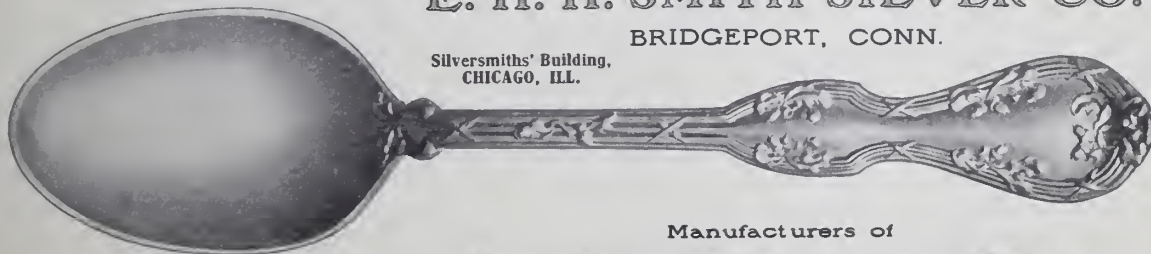

THE OAK.

Manufacturers of

### Sterling Effects in Plate



REGISTERED

# The "ARMLET"



F. & B.  
"ARMLET"  
Secret Joint  
Pat. 1,000,000  
Size 2 3/8 in.

- |           |                           |                                      |
|-----------|---------------------------|--------------------------------------|
| 474       | 476                       | 477                                  |
| 474 POL.  | 476 Rose Gold Half Chased | 477 Rose Gold, Half Chased, 5 Stones |
| 475 ROM.  | 507 O. E.                 | 522 O. E.                            |
| 506 O. E. | 530 Rose Gold Full        | 546 Rose Gold " " 6 Brillants        |
|           | 538 O. E.                 |                                      |

Color of stones as ordered, Amethyst, Ruby, Sapphire, Olivene, Topaz, Aquamarine, Almondine, Turquoise and Rose Stones.

Bracelets made with secret joint and push catch. High-grade Seamless Gold-filled Stock. Each bracelet in fine leatherette covered box.

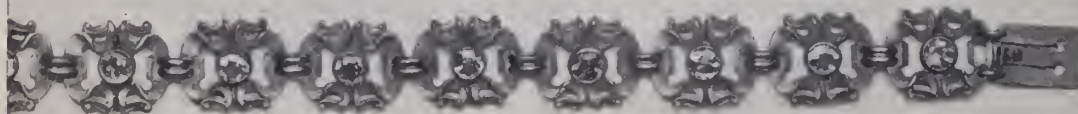

### BRACELET 473 ROSE.

COLOR OF STONES AS ORDERED.

Amethyst, Ruby, Sapphire, Olivene, Topaz, Aquamarine and Turquoise.

Two of the above Bracelets snapped together, makes a nice dog collar 14 in. long.



Locket  
2825  
Rose



Pin  
3632  
Rose and Green  
Brillants



Pin  
3647 Pearls  
3648 Brillants  
3649 Turquoise



Pin  
3629  
Baroque Pearls  
and Brillants



Locket  
2826  
Rose

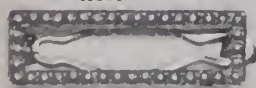

Hair Barrette  
3660 Pearls  
3659 Brills



Cuff Pin  
3624  
Roman



Cuff Pin  
3622  
Roman



Hair Barrette  
3652 Pearls  
3651 Brills



Hat Pin  
710  
Rose and Green  
Polish Signet

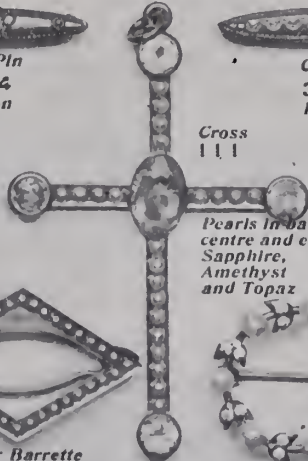

Cross  
111  
Pearls in Bars,  
centre and ends.  
Sapphire,  
Amethyst  
and Topaz

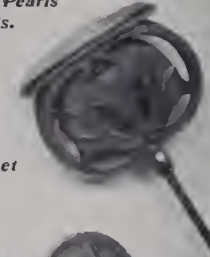

Hat Pin  
705  
Rose  
Polish Signet



Links  
751 Rose

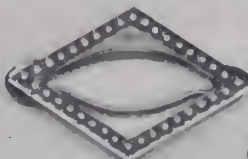

Hair Barrette  
3658 Pearls  
3657 Brillants

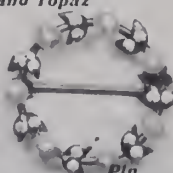

Pin  
3603 Baroque Pearls  
and Brillants

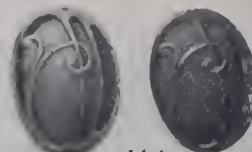

Links  
758 Green  
757 Rose

These are only a few examples of our new goods; see our complete lines.

## Theodore W. Foster & Bro. Co.

MANUFACTURING JEWELERS AND SILVERSMITHS,

100 Richmond Street, Providence, R. I.

Established 18

See our Lists  
of Goods  
Articles suitable for gifts

A full line  
PHOTO. FRAMES  
both Sterling Silver  
and 14 K. Gold Filled  
CROSSES, PENDANTS,  
NECKLACES, NECK  
CHAINS, Locketts,  
GNETTE CHAINS,  
LOCKETS, CHAIN  
VEST, DICKIE  
and FOB CHAINS,  
BRACELETS, FINGER  
BROOCHES, EARRINGS,  
RINGS, LINK CHAINS,  
TONS, SCARF PINS,  
HAT PINS, DRESS  
RETTE PINS,  
WAIST SETS, FINGER  
CHAIN MOUNTAINS,  
INGS, DOG COLLARS  
and BUCKLES, RIBBON  
BOOK-MARKS and  
large variety of

Sterling

Silver

Novelties

MANICURE TOILET SETS  
pieces, also  
DESK SETS  
SEWING SETS  
TRAVELING SETS  
SHAVING SETS  
SMOKING SETS  
FLASKS and  
goods suitable for  
gentlemen's use.

Do not fail to  
order a few of  
our new bracelets,  
lets,

"The Armlt"



**Gifts of Silverware by Citizens of Montreal to Ex-Mayor Laporte.**

A SHORT time ago, in the Montreal (Can.) Board of Trade Hall, the gift of the citizens was presented to Hormidas Laporte, in recognition of his inestimable services as Alderman and Mayor of Montreal. The gift was a handsome and most elaborate cabinet of solid silver, comprising a complete tea service with tray, and a full service of solid silver knives, forks, spoons and serving pieces. It is a fine testimonial to the ability and progress of Canadian manufacture. Henry Birks & Sons produced the gift in its entirety, including the cabinet, which is massive, the size being 22 inches wide, 29 inches long and 23 inches deep. It is made of genuine Spanish mahogany, highly polished, with solid brass trimmings, including a plate bearing the recipient's name.

The silver tea service is displayed upon

**One of the Many Ways in Which Bogus Antiques Were Distributed.**

By G. E. FARR.

A VERY common forgery in England is the engraving of old crests and inscriptions on bogus antique plate. One dealer in Dublin, some years ago, was very great at this (as well as other kinds of forgeries) and had brought it down to a fine art.

His *modus operandi* was to attend the important auction sales, especially that of a nobleman or well known connoisseur, and purchase at the sale porcelain, pottery, furniture, silver, jewelry, etc. He had plenty of capital, and if things went cheap he was a very heavy purchaser and took good care that his name was heard in the auction room and was mentioned in the local press afterward. If things went for high prices he still bought for the advertisement and to get hold of some of the pieces for future

some paper, in which case he would be sure to have the illustration at hand. The greater portion, however, was new goods, principally modern "antiques," especially in the furniture, prints, china and silver.

He would buy immense quantities of old spoons and forks and engrave the crests of the various noblemen whose names he was using on them (engraving in England is very cheap, and he could readily get the crest engraved for three to four shillings per dozen), and sell them as if they came from the sale of that nobleman's effects.

This dealer was a magnificent salesman, and had kissed the Blarney stone. I can see him in my mind's eye walking up and down the salesroom, cracking a joke here and making a witty remark there, with his mind always fixed on the main chance. One favorite remark of his was, when prices were not coming up to the usual standard:

"Well, ladies and gentlemen, this is slaughter. However, the goods have to be sold—it is compulsory. What the vendor will say when he hears the prices the goods have fetched I do not know. However, ladies and gentlemen, that is your gain and his loss. Here, ladies, is a George II. chased hot water jug going for 10s. per oz. less than one-third its value. (and one London dealer made hundreds of them out of tankards and sold them for 8s. 6d. per oz.). I have just read in your local paper that a George II. hot water jug, the same shape as this, fetched 30s. per oz." (The notices, which were perfectly correct, he put in the press in the form of reading matter himself).

Such was his persuasive ability that I have personally seen the article run up to well over 20s. per oz. and the buyers go away thoroughly pleased with the "treasure" he had secured. I know of one instance in which a lady bought a "Cromwellian" cream jug for £15 (a piece of plate very dear at £2), and which, when shown to me, I readily recognized as a small gill mug often used as a spirit measure, and of George II. period, the hallmarks being indistinct; the maker's name being distinguishable was that of a man whose mark was not registered till 1727. On the lady taking it back to the dealer, such was his persuasive ability that she actually came back to me and told me that I did not know what I was talking about—that it was just trade jealousy that made me call her lovely old "Cromwellian" cream jug a forgery. It was no use pointing out to her that cream jugs of that description were not in use in Cromwell's time. She had been fully convinced that I was doing it out of jealousy, Mr. ——— was such a gentleman (?) that any argument on my part was useless.

This man carried on a very lucrative business for many years and must have got rid of tons of bogus antiques. So gullible is the general public that they would go to his sales and readily give 10s. to 12s. an oz. for spoons and forks that could be bought of any ordinary dealer for half the price, simply because they had the crest of a nobleman engraved on them (at a cost of less than \$1 per doz.), and out of which the purchasers could weave a nice little romance to their immediate friends.

People have come to me with pierced salt cellars which they had bought for 12s. to



CHEST SHOWING SILVER SERVICE PRESENTED TO MONTREAL'S EX-MAYOR.

opening the lid. This is composed of hot water kettle, coffee pot, teapot, cream jug and sugar bowl, all in Duchess of York design, with massive hand-engraved tray to match. The tray bears the following inscription: "Presented to Hormidas Laporte, Esq., by citizens of Montreal, in token of their appreciation of the valuable service rendered by him as Alderman and Mayor of the city of Montreal, and in grateful recognition of the reforms accomplished through his work and influence. Elected Alderman of the City of Montreal, Feb. 10, 1897; appointed Chairman of the Water Committee in 1899, and of the Finance Committee in 1900; elected Mayor, Feb. 1, 1904, retiring Feb. 1, 1906." The Duchess of York design is most elaborately hand-chased, and is an exact reproduction of the tea service presented to the Duchess of York upon the occasion of her marriage.

Under the tea service are the three drawers containing the complete service of solid silver spoons, knives and serving pieces, etc. in New Queen's design. Besides the elaborate decoration of these designs, each article is engraved with the letter L in old English.

The gift as a whole is a most choice and worthy one, and bears with it the good wishes of the citizens of Montreal to one who is held in their highest esteem.

use. He advertised pretty extensively and would buy, privately, either a single piece of furniture, china, silver, etc., or buy up a whole collection *en bloc*. He visited various towns, such as Manchester, Bradford, Leeds and other large manufacturing towns, where there were plenty of rich manufacturers and tradesmen with money to spend and with wives anxious to secure anything that was antique, whether a piece of mahogany furniture of the Chippendale or Sheraton period, or an old oak chest, with an inscription on it which proved it to be 300 or 400 years old, or a piece of antique silver, with a Dutch inscription and hallmark (made in Birmingham). He would advertise his sales as, "A valuable collection of antique furniture, pictures, china, silver and bric-à-brac formed by a well known connoisseur and containing examples from the collections of the Earl of Kars, Viscount Kilmorton, Canon Eccles, Northampton Castle, G. F. Cole, F.S.A.," etc., and from other sources (the greater portion being from other sources), etc., etc., using the names of well known noblemen or collectors whose effects had been sold. These sales had a few authentic pieces in them, which were rarely sold unless they fetched a high figure, but were used as decoys at his different sales, being well known, probably at some time having been illustrated in

The Larter Shirt Stud

is the only stud that

can be used in any

style shirt, including

the coat shirt.

The variety of pat-

terns is almost unlim-

ited, the largest shirt

stud stock in America.

Larter & Sons

21 & 23 Maiden Lane

New York

15s. per oz., for which, had they been genuine, any dealer would have gladly given 20s. per oz. When the forgery had been pointed out to them and their common sense appealed to they have generally seen how utterly ridiculous it has been of them to expect that all the dealers were asleep and none of the fraternity about when the "bargains" were being sold.

It is a very good plan for any ordinary man who is in the habit of straying into salesrooms on visits to England, to act with great caution and to be very careful what he buys, especially when he glances around the salesroom and notices that dealers "are conspicuous by their absence." If he pauses to think, he will become assured there is a reason for it, and may rely on it there is something wrong, for, as sure as the night follows the day, if the sale is genuine "the trade" will be represented.

#### The Morosini Cup For Speedway Trotters.

THE cup to be presented by Miss G. P. Morosini to the New York Road Drivers' Association for the horse winning the greatest number of heats in the Speedway brushes is one of the handsomest trophies thus far offered for this purpose. A cup given last year by Miss Morosini was illustrated in THE CIRCULAR-WEEKLY, May 10, 1905.

The new prize is in the form of a large silver vase of Roman type, with two handles and cover, the shape having been suggested by some of the beautiful antiques in the Boscoreale collection. The top is surmounted by a model of a spirited horse, which also serves as a handle to the cover. Conventional palm leaves, symbolizing success are worked in high relief on the handle where it joins the body of the cup. The trophy is illustrated on the front cover of this issue.

On the front of the vase appears the inscription, "The Morosini Cup, Presented by Miss G. P. Morosini to the New York Road Drivers' Association for Horse Winning Greatest Number of Heats, Speedway Brushes, 1906."

In its entirety the trophy, which measure 19 inches in height, 11 $\frac{3}{8}$  inches in diameter and contains about 180 ounces of sterling silver, is fitted in a handsome oak chest. It was recently completed by Tiffany & Co. New York.

To the other services which it is rendering its members and the business community, the Merchants' Association of New York has recently added a most convenient pocket guide of New York, comprising 21 pages, cut in a convenient size and neat bound. The information contained in the volume is most comprehensive, including just the things that strangers want to know and that even old New Yorkers have occasion to ask about every now and then. The topics include hotels, railroads, ferrie steamships, public buildings of all kind, hack rates, distances, and numerous other divisions and subdivisions. Several excellent maps add to the value of the publication. The book will be distributed free to visiting merchants, at the office of the Association, and to members, while a nominal charge will be made to those wishing large quantities for distribution to customers.

**Additional Census Statistics as to Jewelry Trade in Providence, Pawtucket, Indiana and Missouri.**

The Department of Commerce and Labor of the Federal Census Bureau issued last week a new set of reports containing much interesting data about the jewelry and kindred industries of Rhode Island, and several western States. The reports are boiled down to tables, which give at a glance the number of concerns engaged, and figures which show their size, capital, output and so forth. The figures follow:

**STATISTICS OF PROVIDENCE, R. I.**

	Jewelry.	Silverware.
Number of concerns.....	193	10
Capital .....	\$11,111,233	\$8,582,149
Land .....	\$98,600	\$182,519
Buildings .....	\$327,325	\$1,540,222
Machinery and tools.....	\$1,962,754	\$1,292,004
Cash and sundries.....	\$8,722,554	\$5,567,744
Number of proprietors.....	229	9
Number of salaried officials.....	790	139
Their salaries .....	\$906,249	\$171,368
Number wage earners.....	6,391	1,920
Their wages .....	\$3,339,374	\$1,349,688
Men over 16 employed.....	4,090	1,707
Their wages .....	\$2,600,600	\$1,357,357
Women over 16 employed.....	2,218	196
Their wages .....	\$723,171	\$79,844
Children under 16.....	83	27
Their wages .....	\$15,603	\$2,487
Rent of works.....	\$1,136,356	\$379,822
Taxes .....	\$16,383	\$11,967
Rent of offices.....	\$871,595	\$358,781
Contract work .....	\$87,197	\$440
Cost of principal materials.....	\$6,547,896	\$2,388,454
Fuel and rent of power.....	\$77,723	\$34,907
Value of products.....	\$14,317,050	\$5,323,264

**STATISTICS OF PAWTUCKET, R. I.**

	Jewelry manufacture.
Number of establishments.....	4
Capital .....	\$88,000
Machinery and tools.....	\$25,590
Cash and sundries.....	\$62,500
Number of proprietors.....	4
Number of salaried officials.....	9
Their salaries .....	\$12,320
Number of wage earners.....	83
Their salaries .....	\$12,320
Number of wage earners.....	83
Their wages .....	\$25,900
Men over 16 employed.....	50
Their wages .....	\$15,980
Women over 16 employed.....	32
Their wages .....	\$9,720
Children under 16 employed.....	1
That child's wages.....	\$200
Rent of works .....	\$4,946
Taxes .....	\$9
Rent of offices.....	\$1,325
Cost of principal materials used.....	\$31,266
Rent of power.....	\$699
Value of product.....	\$114,706

**STATISTICS OF STATE OF INDIANA.**

	Jewelry manufacture.
Number of establishments.....	5
Capital .....	\$29,059
Machinery and tools.....	\$7,300
Cash and sundries.....	\$21,759
Number of proprietors.....	6
Salaried officials .....	5
Their salaries .....	\$6,380
Wage earners .....	36
Their wages .....	\$22,809
Men over 16 employed.....	284
Their wages .....	\$157,217
Children under 16 employed.....	5
Their wages .....	\$750
Rent of works .....	\$950
Taxes .....	\$1,488
Rent of offices.....	\$21,696
Contract work .....	\$18,185
Cost of principal materials used.....	\$425,671
Fuel and rent of power.....	\$37,277
Value of product .....	\$721,439

**STATISTICS OF THE STATE OF MISSOURI.**

	Jewelry manufacture.
Number of establishments .....	17
Capital .....	\$135,851
Machinery and tools.....	\$43,783
Cash and sundries.....	\$92,068

Number of proprietors.....	20
Salaried officials .....	36
Their salaries .....	\$23,280
Wage earners .....	252
Their wages .....	\$201,457
Men over 16 employed.....	216
Their wages .....	\$189,294
Women over 16 employed.....	30
Their wages .....	\$11,195
Children under 16 employed.....	6
Their wages .....	\$968
Rent of Works.....	\$18,704
Taxes .....	\$1,571
Rent of offices.....	\$13,172
Cost of principal materials used.....	\$232,429
Fuel and rent of power.....	\$2,418
Value of product .....	\$589,036

**STATISTICS OF THE STATE OF COLORADO.**

	Jewelry manufacture.
Number of establishments.....	8
Capital .....	\$98,043
Machinery and tools.....	\$13,967
Cash and sundries.....	\$84,067
Number of proprietors.....	8
Number of salaried officials.....	8
Their salaries .....	\$11,258
Wage earners .....	39
Their wages .....	\$38,969
Rent of works.....	\$6,178
Taxes .....	\$641
Rent of offices.....	\$6,618
Contract work .....	\$764
Cost of principal materials used.....	\$30,653
Fuel and rent of power.....	\$940
Value of product .....	\$114,099

**Jewelry, Clocks, Watches, Silverware and Kindred Lines Exported from New York.**

WASHINGTON, D. C., May 23.—The following were the exports of jewelry, silverware and optical goods, clocks, watches and kindred lines from the Port of New York for the week just ended:

- Adelaide: 35 packages plated ware, \$1,651; 22 packages clocks, \$348.
- Bombay: 1 package optical goods, \$1,070.
- Bremen: 1 package plated ware, \$350; 3 packages jewelry, \$778; 1 package watches, \$117.
- Buenos Ayres: 45 packages plated ware, \$5,429; 40 packages clocks, \$1,037; 15 packages plated ware, \$1,726; 1 package optical goods, \$530; 24 packages clocks, \$378.
- Calcutta: 35 packages clocks, \$728; 41 packages clocks, \$678.
- Capetown: 50 packages clocks, \$1,277; 3 packages plated ware, \$655; 1 package optical goods, \$325.
- Corinto: 5 packages clocks, \$113.
- Genoa: 2 packages jewelry, \$585; 1 package engravers' machinery, \$134.
- Glasgow: 68 packages clocks, \$578.
- Gottenburg: 5 packages clocks, \$110.
- Guayaquil: 1 package watches, \$229.
- Hamburg: 2 packages clocks, \$145; 3 packages optical goods, \$617.
- Havana: 1 package optical goods, \$1,128; 1 package jewelry, \$228; 4 packages optical goods, \$237; 6 packages jewelry, \$2,408; 8 packages clocks, \$165.
- Havre: 2 packages jewelry, \$590.
- Hobart: 7 packages plated ware, \$415; 23 packages clocks, \$132.
- Iqueque: 1 package watches, \$500.
- Las Pamas: 8 packages clocks, \$126.
- Limón: 12 packages clocks, \$212.
- Liverpool: 27 packages clocks, \$471; 3 packages watches, \$550; 3 packages thermometers, \$135; 3 packages clocks, \$196; 1 package jewelry, \$1,000; 1 package silverware, \$423.
- London: 13 packages clocks, \$2,028; 1 package optical goods, \$345; 2 packages plated ware, \$175; 4 packages engravers' material, \$299; 6 packages jewelry, \$610; 3 packages scopes and views, \$680; 41 packages watches, \$6,297; 4 packages clocks, \$608; 10 packages optical goods, \$3,007.
- Melbourne: 55 packages clocks, \$527.
- Montevideo: 11 packages clocks, \$135; 8 packages clocks, \$262; 13 packages plated ware, \$1,501.
- Panama: 3 packages plated ware, \$264.
- Rotterdam: 1 package watches, \$320.
- Sheffield: 1 package jewelers' sweepings, \$880.
- Southampton: 1 package watches, \$330.
- St. John: 2 packages plated ware, \$102; 15 packages clocks, \$202.
- Tampico: 13 packages plated ware, \$850.

**Ornamented Imitations of Rock Crystal Held to be Dutiable at 45 Per Cent.**

Imitation rock crystal intaglios, ornamented by paintings, are dutiable at 45 per cent. as manufactures of paste, under a decision announced last week by the Board of United States General Appraisers, New York, overruling a protest by Nordlinger & Manluck against an assessment of duty by the Collector at Providence, R. I. In the same decision a protest by the firm against an assessment of duty on multi-colored stones, under one inch in dimensions, was sustained.

In the accompanying opinion General Appraiser Sharretts says:

There is no dispute relative to the facts in this case, and we find on the official samples, without the introduction of evidence, that the merchandise consists of:

1. Imitations of precious stones composed of paste, not exceeding one inch in dimensions and made to resemble rock crystal molded or pressed into the form of intaglios, the indentation on the under surface thereof representing a cat's head, the latter subsequent to molding having been ornamented by hand painting. The completed articles imitate hand-painted rock-crystal intaglios, which by decision of the Circuit Court of Appeals, second circuit, in United States v. Benedict (T. D. 27032) are dutiable at 10 per cent. ad valorem under Par. 435 of the present Tariff Act.

2. Imitations of precious stones composed of paste, not exceeding one inch in dimensions, known as multicolored stones and identical with those covered by G. A. 6155 (T. D. 26723).

The importers contend that the assessment of duty by the Collector on all of said merchandise at the rate of 45 per cent. ad valorem, under the provision of Par. 112 for manufactures of paste, is erroneous, claiming it is properly dutiable at 20 per cent. ad valorem, as imitations of precious stones, under Par. 435, Tariff Act of 1897.

On the authority of G. A. 6155 (*supra*), we sustain the protest so far as it relates to the goods included in our second finding.

Regarding the imitations of hand-painted rock-crystal intaglios, we are of opinion they are excluded from classification under Par. 435 by terms. It is true that this Board has uniformly held that the decoration or ornamentation referred to in the paragraph named imports, a superadded process. Adhering to the correctness of this ruling, we find in the present case that the imitation intaglios became imitations of precious stones when they were removed from the mold or press, and that the subsequent painting applied to them was decorative in character; hence they are clearly imitations of precious stones ornamented or decorated.

It is contended by the importers that the painting applied to the intaglios is part of the process of making the imitation precious stones or, to quote from Judge Wheeler's opinion with regard to incrustated stones in United States v. Downing (T. D. 26076), "they are not engraved or painted or otherwise ornamented or decorated than in constituting the imitation which they simply are." Conceding this to be correct with regard to several descriptions of imitations of precious stones assembled in the form of a cluster and not painted or engraved or otherwise ornamented or decorated, it does not follow that every form of imitations of precious stones is included in Par. 435. On the contrary, only such are included as have not been ornamented or decorated.

Imitation cameos and intaglios, if molded or pressed only, would not be ornamented or decorated, but similar stones made cameo or intaglio by engraving would be; so the intaglios in dispute, if imported unpainted, would fall within the enumeration of Par. 435, but when ornamented by painting they are by terms excluded therefrom.

In accordance with these views we overrule the protest and affirm the Collector's decision relative to the goods covered by our first finding.

The new factory of the Silver Plate Co. has been started at Pacousett, near Portland, Conn.

The C. F. Monroe Co., Meriden, Conn., will have an elaborate display at Hanover during the Centennial.

# HAYDEN W. WHEELER & Co.



## MOUNTED DIAMONDS



OUR stock of Mounted Diamonds contains the Latest and Newest Designs. Made from best Selected Material. Finest Hand Made Mountings. Quality, Style and Lowest Price consistent with this standard.

AMSTERDAM  
2 TULP STRAAT

BROOCHES, RINGS, SCARF PINS, BRACELETS, ETC.

LONDON  
50 HOLBORN VIADUCT

2 MAIDEN LANE, NEW YORK

TELEPHONE  
7365 CORTLANDT

ORDER

# DIAMONDS

ON MEMORANDUM FROM

## ALFRED H. SMITH & CO.

170 BROADWAY, NEW YORK.  
Corner Maiden Lane.

London.  
6 Holborn Viaduct.

Chicago,  
103 State Street.

## Oppenheimer Bros. & Veith, Cutters of Diamonds,

65 NASSAU ST. (PRESCOTT BUILDING), NEW YORK.

AMSTERDAM,  
2 Tulp Straat.

LONDON,  
40 Holborn Viaduct.

CUTTING WORKS,  
Cor. Union & Nevins Sts., Brooklyn.

## HENRY E. OPPENHEIMER & CO.,

51 Holborn Viaduct, London.  
50 Rue de Chateaudun, Paris.  
7 Place Loos, Antwerp.

Tel. 621 Cortlandt.

3 MAIDEN LANE, NEW YORK.

DIAMONDS, PEARLS AND PRECIOUS STONES.

MEMORANDUM ORDERS SOLICITED.

## London Letter.

### British Watch Manufacturers and Dealers Form Guild to Stop Serious Price Cutting—Legislation for Opticians.

LONDON, May 20.—At the British Horological Institute, May 7, a meeting of watchmakers, watch factors, assistants and journeymen was held under the presidency of R. W. Cole. The meeting was not under the ægis of the Horological Institute, but had been convened by Bahne Bonnicksen (the inventor of the Karrusel movement) in order to bring the watch trade of Great Britain together to effect by means of organization certain necessary reforms.

The British watch trade has been in rather an unfortunate position for some time past, and the state of affairs has been such that even the factors of foreign watches have found cutting prices somewhat too much for them. I have known cases in which watches have been factored at a profit of 1d. or 1½d. per watch. I have also known cases in which British watches have been manufactured and sold at a loss. That is the point of view which must appeal to the actual British manufacturer and the factor whether dealing in British, American or Swiss made watches. So far as the shopkeeper is concerned the cutting in the price of repairs has been lamentable. You will see in almost any British city or town a notice in watchmakers' windows to the effect that they will clean your watch for 1s. or 1s. 6d. or even set a mainspring for 1s. So far as the men are concerned their wages are pitifully low, and I know of one instance where an old-time Clerkenwell watchmaker, with a good reputation, is now actually sweeping the roads in that district and receiving 6s. a week, more than he was able to earn as a watchmaker or repairer. No wonder then, that the Hall of the British Horological Institute was filled to overcrowding, and that those present agreed to form a Guild which will compromise all members from the bottom to the top of the trade. I noticed a large number of representatives of our most important British manufacturing houses, also representatives of the leading foreign houses doing business here, and if matters are carried on as enthusiastically as they were discussed and dealt with at the meeting, the British Watchmakers' Guild will become an important organization. Briefly, the objects of the Watchmakers' Guild are: To endeavour to stop the cutting of prices in both the sale and repair of watches, to encourage technical education and the apprenticeship system, also to establish a system of marking watches which have been made by members of the Guild. These are the salient points, but there are a number of others which will be dealt with when the Constitution is drawn up and the rules formulated. Among those present at the meeting were delegates from the Sheffield, Manchester and other local associations, but the National Association of Goldsmiths was not represented.

#### LEGISLATION FOR OPTICIANS.

The attempts which have been made to obtain Parliamentary recognition of sight-testing opticians are not likely to be very successful, largely due to the fact that one society out of about a dozen representing

the British optical industry has refused to work in harmony. On behalf of the General Board of Opticians the Worshipful Company of Spectacle Makers has introduced a bill into the House of Lords, rather a round about way of going to work, and has drawn fairly considerable discussion. The General Board of Opticians has made an appeal to the opticians of Great Britain, but up to date of writing the response has been fairly small. In my opinion there is little likelihood of the sight-testing opticians' position being placed upon a legal basis for some time.

ST. GEORGE.

### Jewelry, Clocks, Watches and Plated Ware Shipped to Alaska, Hawaii, Porto Rico and the Philippines.

WASHINGTON, D. C., May 23.—Details of the commerce of the United States with its non-contiguous territories during certain periods in clocks, watches, jewelry, etc., have just been compiled as follows:

ALASKA.—Clocks to the value of \$3,900 were shipped to Alaska during the nine months ending March, 1906, as against \$3,208 shipped during the same period of 1905. During these same periods the watch shipments were \$1,306 and \$541, respectively. During March last \$6,045 worth of jewelry was shipped to Alaska, the value in March a year ago being \$1,021. During the nine months' period these shipments increased from \$25,054 in 1905 to \$50,051 in 1906, while the shipments of plated ware increased from \$3,673 to \$6,350.

HAWAII.—Clocks to the value of \$881 were shipped to Hawaii in March, 1905, increasing to \$2,315 in March last, while the nine months' shipments increased from \$6,305 in 1905 to \$9,802 in 1906. Watch shipments declined from \$157 in March a year ago to \$5 in March last, but increased from \$1,305 to \$2,196 during the nine months' period. A decided falling off in the shipments of jewelry is noted. The value in March, 1905, was \$16,460, decreasing to \$1,026 in March last, while the shipments during the nine months' period fell from \$124,984 in 1905 to \$81,571 in 1906. Plated ware shipments likewise fell from \$4,162 in March, 1905, to \$478 in March last, and from \$48,358 to \$24,439 during the nine months' period.

PORTO RICO.—During the nine months of 1905 there were \$1,970 worth of clocks shipped to Porto Rico, increasing to \$4,156 during the same period of 1906, while watch shipments increased from \$2,071 to \$2,629 during the same period. Jewelry shipments also increased from \$7,135 to \$12,559 during the same period and plated ware from \$4,838 to \$7,163.

PHILIPPINE ISLANDS.—The Philippine Islands bought \$1,777 worth of clocks from the United States during the nine months of 1905, the purchases increasing to \$2,970 during the same period of 1906. Watch purchases, however, declined from \$1,734 to \$924 during the same periods. Shipments of jewelry to the Philippines increased from \$1,557 to \$2,146 and plated ware from \$877 to \$4,328 during the same periods.

Harry R. Greyer, Muncie, Ind., is offering his creditors 20 cents on the dollar.

### Recent Customs Decisions on Jewelry, Gems and Kindred Lines.

Decisions by the Board of United States General Appraisers, New York, in cases involving duties on jewelry and kindred lines, have been announced in the last week as follows:

STRUNG BEADS.—Henry E. Frankenberg Co. v. United States. United States Supreme Court, April 30, 1906. No. 698. On petition for writ of certiorari to the Circuit Court of Appeals, second circuit. Petition granted. For decisions below see T. D. 27,188 (C. C. A.), T. D. 26,455 (C. C.), and G. A. 5,878 (T. D. 25,891). The importers contend that beads when strung temporarily are dutiable under Par. 408, Tariff Act of 1897, as "beads \* \* \* not threaded or strung."

PARTS OF JEWELRY—SNAPS.—Protest of Manhattan Chain Co. against the assessment of duty by the Collector at New York. On the authority of G. A. 6,330 (T. D. 27,255), certain snaps, which were classed as parts of jewelry, were held dutiable as manufactures of metal under Par. 193, Tariff Act 1897.

IMITATION PEARLS.—Protest of R. A. Breidenbach against the assessment of duty by the Collector at New York. The Board sustained the importer's contention that imitation pearls are dutiable as imitation precious stones under Par. 435, Tariff Act of 1897.

TOY BRACELETS AND CHAINS.—Protest of J. & H. Rosenberg against the assessment of duty by the Collector of Customs at the Port of New York. Certain bracelets and chains were held dutiable as toys under Par. 418, Tariff Act of 1897, as claimed by the importers. G. A. 6,297 (T. D. 27,156) and Abstract 10,046 (T. D. 27,114) followed.

IMITATION PEARLS.—Protest of H. F. Barrows & Co. against the assessment of duty by the Collector of Customs at New York. G. A. 6,088 (T. D. 26,554) followed, relating to imitation pearls.

IMITATION PRECIOUS STONES—HALF PEARLS.—Protests, etc., of R. A. Breidenbach against the assessment of duty by the Collector of Customs at New York. Protests sustained on the authority of G. A. 6,289 (T. D. 27,112), G. A. 6,088 (T. D. 26,554), G. A. 5,914 (T. D. 26,113), and T. D. 27,193, relating to imitation precious stones, imitation pearls, incrustated stones, and half pearls.

MILLINERY ORNAMENTS.—Protest of Viet, Son & Co. against the assessment of duty by the Collector of Customs at New York. G. A. 6,130 (T. D. 26,653) followed, relating to millinery ornaments.

IMITATION PEARLS—HALF PEARLS—IMITATION PRECIOUS STONES—KEYSTONES.—Protests of Albert Lorsch & Co. against the assessment of duty by the Collector of Customs at New York. G. A. 6,088 (T. D. 26,554), G. A. 6,236 (T. D. 26,922), G. A. 6,167 (T. D. 26,770), G. A. 6,155 (T. D. 26,723), G. A. 5,915 (T. D. 26,014), G. A. 5,914 (T. D. 26,013), G. A. 6,053 (T. D. 26,388), G. A. 6,097 (T. D. 26,586), and United States vs. Downing (T. D. 27,193 and T. D. 27,250) followed, relating to imitation pearls, imitation precious stones, incrustated stones, keystone, precious stones in the form of beads, and half pearls.

**AMETHYST**

In Siberian, Brazilian and D'Auvergne qualities, in all shapes and sizes. Golden and Madeira topaz. Half, round and bouton pearls. Reconstructed rubies, opals, garnets, and doublets in the fancy colors and fancy shapes—uniform grades, especially selected for the American Market.

*L. Heller & Son*

Importers of Precious and Imitation Stones.

New York, 51 Maiden Lane  
Paris, 5 Cite Trevisé

Providence, 212 Union Street  
Idar, 14 Hauptstrasse

TELEPHONE 219 JOHN.



GEORGE H. HODENPYL.

WALTER N. WALKER.

**DIAMONDS**

AND

DIAMOND JEWELRY

**HODENPYL & WALKER**

Unique  
and  
Staple Patterns

**170 Broadway, New York**  
Corner of Maiden Lane  
**TELEPHONE, 1898 CORTLAND**

Repairing and Recutting  
Diamonds  
a Specialty

<p>OUR <b>40th</b> YEAR</p> <p>IN BUSINESS</p> <p>1866=1906</p>	<p><b>DIAMONDS</b> LOOSE AND MOUNTED</p>	<p><b>CASES and MOVEMENTS</b> ALL MAKES AND GRADES</p>	<p><b>JEWELRY</b> GOLD AND PLATED</p>
<p>ORDERS SOLICITED FROM RESPONSIBLE JEWELERS.      GOODS SENT ON SELECTION.</p> <p>All our goods are either direct importations, our own manufacture or bought for cash, enabling us to offer special inducements in prices and terms.</p>			
		<p>EST. 1866.</p> <p><i>Lissauer &amp; Company</i></p> <p>Importers.</p> <p>2 TULPSTRAAT, AMSTERDAM.</p>	<p>12 MAIDEN LANE, (ONE FLIGHT UP)</p> <p>P. O. Box, 1625, <b>NEW YORK.</b></p>

<p><b>AQUAMARINES</b></p>	<p><b>ALL SIZES</b> and <b>SHAPES</b></p>
<p>Stones from One-Quarter of a Carat to Sixty Carats Each. Selection Papers Sent on Request</p>	
<p><b>MARTIN LOW &amp; TAUSSIG,</b></p>	
<p>51 Maiden Lane, New York. Telephone, 2817-John.</p>	<p>139 Mathewson St., Providence, R. I. Telephone, 3037-Union.</p>

**MEYEROWITZ BROS.,**

IMPORTERS OF **DIAMONDS,** 37-39 MAIDEN LANE, NEW YORK CITY

A Complete Line of Precious, Semi-Precious and Imitation Stones. Mail orders promptly attended to.

**Last Honors Paid to the Late Louis J. Lamb, at Attleboro.**

ATTLEBORO, Mass., May 25.—Attleboro closed her shops and stores and stilled the busy hum of trade Wednesday last in order to do honor to Louis J. Lamb, late head of C. H. Alden & Co. Mr. Lamb was one of Attleboro's staunchest citizens, of unusually high ideals and standards of life, able and progressive in business, charitable to a degree only appreciated by a few close friends, and modest in the extreme. Though repeatedly urged to accept legislative honors he refrained, preferring the activities of his business and his many personal lines of work. He served with unostentatious but effective interest on the town's school board and sinking fund commission.

The funeral services were held in Murray Universalist Church, of which Mr. Lamb was one of the most loyal supporters, and was attended by scores of the principal manufacturers and business men, besides others friends innumerable. Rev. Hendrick Fossemma, Rev. Thomas W. Illman and Rev. J. Harry Holden officiated. C. H. Alden & Co., the New England Jewelers' and Silversmiths' Association, and many business associates and friends sent flowers. The eulogy spoken by Rev. Mr. Illman was an uncommonly able and true tribute to the man. Since his departure the banks with which he was connected have adopted appropriate resolutions, and other bodies have shown their grief at losing so strong a supporter.

Mr. Lamb was for 22 years with W. H. Wilmarth & Co., now the W. H. Wilmarth Co., rising from a subordinate office position to the management. He then bought out Granville W. Smith, a competitor, but after a short time sold the plant to his own former employers, and with William H. Lamb and Charles H. Allen started C. H. Allen & Co. For some 10 years this has been one of the most prosperous and growing firms in the town. Mr. Lamb had unique executive ability, was ingenious and inventive, but above all scrupulously upright in every dealing.

**Call Issued for Retail Jewelers to Organize in Twenty-Six States July 10.**

From present indications it would appear that the meeting to be held at Rochester, N. Y., Aug. 3, 4, for the purpose of forming a National Association of Retail Jewelers will be attended not only by delegates from the many organizations in the jewelry trade now in existence and recently formed, but also by delegates from a large number of States which at present have no association, but in which an organization will be formed before the convention. According to word received from Chicago last week, as a result of a systematic organization now on foot, meetings will be held in about 25 or 26 States on July 10 for the purpose of forming organizations of retail jewelers who will send delegates to the national convention and make this, the new organization to be formed in the Fall, truly representative of the entire jewelry trade.

According to the present plan the States in which organizations will be formed in July and the cities in which the meetings will be held are as follows: Arkansas, Little

Rock; California, Oakland; Colorado, Denver; Connecticut, Hartford; Georgia, Atlanta; Idaho, Boise City; Indian Territory, Chickasha; Kentucky, Louisville; Louisiana, New Orleans; Maine, Portland; Maryland, Baltimore; Mississippi, Meridian; New Hampshire, Concord; New Jersey, Trenton; New York, Albany; North Carolina, Greensboro; Ohio, Columbus; Oklahoma, El Reno; Oregon, Portland; Pennsylvania, Pittsburg; Rhode Island, Providence; South Carolina, Charleston; Tennessee, Nashville; Texas, Dallas; West Virginia, Parkersburg, and Washington, Seattle

**Government Brings Suit to Forfeit Jewelry and Watches Alleged to Have Been Smuggled Over Mexican Border.**

SAN ANTONIO, Tex., May 23.—An action *in rem* has been commenced in behalf of the United States to declare forfeit, for non-payment of duty, on a quantity of watches, gems and jewelry, which were recently seized from Louis Leschenger, of Houston, by Customs Collector R. M. Dean. The suit, which was begun in the United States Court by the Federal District Attorney, Henry Terrell, was simply against the gems, but Leschenger, who was represented by Judge Winchester Kelso as attorney, will put in a claim and a hard legal fight is expected.

Leschenger was recently indicted by the Federal Grand Jury on the charge of smuggling the gems in question. The value of the article is stated by the customs authorities as being \$19,057.50. Leschenger has been held in \$2,500 bail. He claims that he is not guilty of any intent to defraud the Government and will fight the criminal as well as the civil proceedings to the last ditch.

**Imports at the Port of New York.**

Weeks Ended May 26, 1905, and May 25, 1906.		
	1905.	1906.
China, Glass and Earthen Ware:		
China .....	\$56,628	\$69,191
Earthen ware .....	13,977	11,217
Glass ware .....	37,477	33,811
Optical glass .....	337	3,618
Instruments:		
Musical .....	7,068	18,059
Optical .....	11,512	20,717
Philosophical .....	191	2,878
Jewelry, etc.:		
Jewelry .....	7,047	8,913
Precious stones .....	706,203	1,040,807
Watches .....	34,227	44,396
Metals, etc.:		
Bronzes .....	995	369
Cutlery .....	26,932	26,124
Dutch metal .....	235	3,412
Platina .....	23,580	79,800
Silverware .....	4,801	954
Miscellaneous:		
Alabaster ornaments .....		164
Amber .....	10,376	11,436
Beads .....	2,143	8,140
Clocks .....	3,604	5,916
Fans .....	2,003	6,753
Fancy goods .....	5,856	9,093
Ivory .....	54,142	117,895
Ivory, manufactures of.....	811	503
Marble, manufactures of...	9,159	13,776
Statuary .....		7,027

The retail jewelry store of Julius Anderson, Mora, Minn., was broken into Tuesday night, of last week, by thieves who made off with several watches and a large amount of miscellaneous jewelry. The theft is believed to have been committed by professional thieves. Burglar insurance covers the loss.

**Otto H. Fasoldt, Albany, N. Y., Files Voluntary Petition in Bankruptcy.**

UTICA, May 24.—Otto H. Fasoldt, a jeweler and watchmaker at 32 N. Pearl St., Albany, and residing at Slingerlands, today filed a petition in voluntary bankruptcy in the United States District Court this city and after the adjudication the petition will be referred to Referee Lansing at Albany, who will call the meeting of creditors for the election of a trustee to wind up Mr. Fasoldt's affairs.

Fasoldt's creditors are all unsecured and their claims amount to \$6,285.40. The schedule discloses nominal assets valued at \$1,759.64, including \$700 in stock, \$75 in machinery, tools, etc., \$1,052.64 in debts due and \$7 on deposit in banks.

The creditors are: A. Lorsch & Co., \$733; Arnstein Bros. & Co., \$742; W. I. Rosenfeld, \$273; Seth Thomas Clock Co., \$358; Rosenzweig Bros., \$1,381; A. Wittnauer Co., \$628; L. W. Rubenstein, \$63; Self Winding Clock Co., \$67; Bawo & Dotter, \$95; M. Shepard & Co., \$17; W. Grant Co., \$95; D. Ullmann & Co., \$270; M. Schless, \$199; Haldiman & Co., \$37; J. Wodiska, \$49; I. Ollendorf, \$48; S. Brenauer & Sons, \$9; American Cuckoo Clock Co., \$31; Rockford Watch Co., \$15; Waltham Horological School, \$24; Municipal Gas Co., \$19; C. F. Weber Mfg. Co., \$9; F. Ridgway, \$9; Von Huesen, Charles Co., \$6; Roof, Horton Co., \$19; W. C. Penfold & Co., \$385; D. C. Percival & Co., \$126; Rogers, Lunt & Bowlen Co., \$137; Heintz Bros., \$386; M. Levitz, \$80; Times Union Co., \$20.

Many of the larger creditors hold notes given by Fasoldt and suits have been brought in the state courts to recover on those given to W. I. Rosenfeld, New York. This forced Fasoldt to file a petition in bankruptcy.

Mr. Fasoldt started in business in Albany in 1878 at 83 N. Pearl St., in 1893 he moved to 99 N. Pearl St. and subsequently to 32 N. Pearl St. He has been inspector for the New York Central and Hudson Railroad, and has always been prominent in business circles, and has borne an excellent reputation in the trade. Mr. Fasoldt formed a partnership with E. P. Bevilard, who was formerly in business in Utica, only a few weeks ago, the firm now being known as O. H. Fasoldt & Co.

**Bids to Supply Clocks for United States Public Buildings.**

WASHINGTON, D. C., May 21.—Bids were opened at the Treasury Department to-day for furnishing United States public buildings east of the Rocky Mountains with clocks during the fiscal year ending June 30, 1907. The bidders were as follows:

Chelsea Clock Co., Boston, Mass., pendulum clocks, \$16 each; spring clocks, \$20.

Seth Thomas Clock Co., New York, pendulum clocks, \$10.10.

American Clock Co., electric clocks, \$19.25 each.

R. H. Macy & Co., New York, pendulum clocks, \$11.10; spring clocks, \$10.72; electric clocks, \$21.60.

John B. Ball, Joplin, Mo., has admitted a partner, and the firm style is now Ball & Putnam.

# Chester Billings & Son

1840

Successors to

Kandel, Barmore &amp; Billings

1906

Importers of Diamonds  
Other Precious Stones, and  
Pearls, Diamond Jewelry

1840, Kandel & Barmore; 1866, Kandel, Barmore & Co.; 1880, Kandel, Barmore & Billings; 1897, Chester Billings & Son

New York, 58 Nassau Street, 29 Maiden Lane  
London: 22 Holborn Viaduct, E. C. Paris: 53 Rue de Chateaudun  
Amsterdam: 2 Tulp Straat



Manufacturer of  
Diamond Mountings and  
Diamond Set Jewelry  
Importer of  
Diamonds and Precious Stones

**A. S. Hirshberg,**  
373 Washington Street, Boston, Mass.

Cable Addresses: { Ashir, Boston.  
Hochschüler, Antwerp.

## REMOVAL NOTICE!

### THE LYONS GEM CO.,

Have Removed to

### 35 Maiden Lane, New York.

A FULL AND COMPLETE LINE OF PRECIOUS,  
SEMI-PRECIOUS AND IMITATION  
STONES ALWAYS IN STOCK.

Our Specialty is Scientific Rubies.

Local and out of town jobs promptly  
attended to at reasonable prices.  
Send us your mountings to be set  
with matched stones. A trial order  
will convince you that our prices  
are right, and our goods select.

## COOPER'S

### SUN RAY DIAMOND

HAS 100 per cent. more brilliancy  
than any other style of cutting.

*We Challenge the World.*

Send your old mine and yellow  
diamonds to be recut; if the effect  
is not 100 per cent. better, NO  
CHARGE.

### COOPER DIAMOND

Cutting and Polishing Industry of America

49 MAIDEN LANE, NEW YORK.

Factorles, 8th Ave. & 18th St., Brooklyn.



TRADE-MARK.

## AZTEC TURQUOISES

Mines: MINERAL PARK, ARIZONA.



TRADE-MARK.

Of true CERULEAN BLUE, the rarest and most fashionable shade. Turquoises bearing Company's trade-mark are GUARANTEED. A new Turquoise will be given without question to replace any that discolors. The leading Jewelers of the World sell AZTEC TURQUOISES.

### THE AZTEC TURQUOISE COMPANY,

12-16 JOHN STREET, NEW YORK.

THE BOSTON DIAMOND HOUSE

### JOHN B. HUMPHREY CO.

387 Washington St., Boston, Mass.

We are receiving Monthly Shipments of Diamonds from our Brazilian Mines, which are on exhibition at our Boston Office.

Cutters of  
DIAMONDS

Cutters of  
DIAMONDS

## GARREAU & GRISER

68 & 70 Nassau St., New York.

LAPIDARIES. PRECIOUS STONES  
GEMS in Unique Cuttings.

### THE MUELLER LAPIDARY CO.,

248 Halsey Street, Newark, N. J.

### CUTTERS

Precious and Semi-Precious Stones.

### JACOB BASCHKOPF, DIAMOND SETTER,

LETTER AND MONOGRAM

### ENGRAVER,

9-13 MAIDEN LANE,

NEW YORK.

Room 701  
Jewelers' Bldg.

### ROBERT DULK, DESIGNER,

Etching in Gold and Silver,

Telephone, 3960 Chelsea.

No. 70 5th Avenue, NEW YORK

### Trade-Marks

of the Jewelry and Kindred Trades.  
Second Edition. Price, \$3.00. The Jewelers' Circular Publishing Co., 11 John St., New York.



## Reconstructed Ruby Decision.

### Time for Government to Appeal Has Expired—Gem Importer Gives Interesting Points as to Manufacture of These Stones.

The time in which the Government could appeal from the decision recently announced by the United States Board of General Appraisers in the reconstructed ruby case, as it was called, has expired, so that the ruling is now accepted. Accordingly, the duty on rubies made by any artificial process is now definitely fixed at 10 per cent., the same as the duty on natural rubies advanced in condition. The case came in the form of an appeal by Albert Lorsch & Co. against an assessment of 20 per cent. by the Collector of the Port, who classified the articles as non-enumerated manufactures. Gen. George W. Mindil, the precious stone examiner at New York, who testified for the government at the trial, did not recommend an appeal.

The decision does not mean that the Government could not prove a distinction between natural and other kinds of rubies. A gentleman who is familiar with the reasons actuating the General Appraisers, said: "The Board, under the law and decisions, could not make any other classification than the one announced. The rubies, made by an artificial process, could be classed under Section 6 of the tariff law of 1897 as non-enumerated manufactured articles were it not for the decision of the courts bearing on Section 7, the similitude clause. Under these decisions before an article can be classified as non-enumerated manufacture, an effort must first be made to classify it with one of the enumerated articles by resemblance in material, quality, texture, or the use to which it may be applied.

"In the case of artificially made rubies there can be no question as to the close resemblance in all these respects, although a resemblance in one or more would be sufficient for the purpose.

"Reconstructed rubies have the same chemical constituents as the natural rubies. The texture and quality deceive all except experts. As to the uses you may say that they are identical. So while people in the trade and the buying public may make whatever distinction they please between a stone formed by nature and one put together by man, yet under the law as it stands, there is nothing else that the Board can do except to classify for all customs purposes artificial rubies with those that are made by nature."

People in the trade exhibit interest in the question discussed incidentally at the hearings, as to how reconstructed rubies are made. It will be recalled that Gen. Mindil and other experts said that there is no such thing as reconstructed rubies, in the sense in which those articles have commonly been described. Up to that time it had generally been accepted that reconstructed rubies were made by fusing smaller rubies or ruby dust. Gen. Mindil said that in order to fuse the rubies the extreme heat required would destroy the red color, so that the product would be worthless. The opinions of the well-known writers on precious stones were cited in support of the

position taken by this gem expert.

This incredulity as to the supposed process of making reconstructed rubies was at variance with views expressed in technical papers, read from time to time in Paris, the readers apparently having no doubt that the articles were made by fusing smaller gems. The New York importers, when questioned, said that they had understood the method of fusing natural rubies to be followed in making the reconstructed article, but admitted that they had never seen the process. One of the writers, whose opinion was cited at the hearing, admitted in his book that a number of years ago a new kind of artificial ruby had made its appearance in the market, and that some mystery existed as to the method of its production.

L. Tannenbaum, of L. Tannenbaum & Co., New York, who has paid some attention to the subject, although not dealing in reconstructed rubies, said to a representative of this paper several days ago, that beyond any question rubies can and are made by the process of reconstruction. He has seen the process conducted, he said, and is absolutely sure of the fact that the reconstructed rubies are made of smaller rubies fused together. He said that at Paris the trade knows all the facts, and no doubt exists on the subject in that city where reconstructed rubies are made in large quantities.

Mr. Tannenbaum added that the smaller rubies when melted lose their red color just as the expert testified, but he said the other material is added which restores the original color. He said that stones have been made by the process in this country.

Another man said that if coloring material is added, such as chromium, then the reconstructed rubies are on a somewhat different plan than if they were made only by massing smaller rubies. He said that they would come in competition in trade, not with natural rubies, but with the scientific rubies, made by the well-known chemical process.

### United States Court Restrains Transfer of Gorham Mfg. Co.'s Stock Until Suit by Geo. H. Robinson Is Decided.

Stockholders of the Gorham Mfg. Co. received this week copies of a circular letter sent out by the company's attorneys, Comstock & Canning, and dated at Providence, R. I., saying:

"We are instructed by the president of the Gorham Mfg. Co. to inform you that in the bill in equity brought against this company in the Circuit Court of the United States, District of Rhode Island, there has been entered a preliminary decree restraining this company, until the final hearing of the cause or further order of the court, from further action in the matter of the Silversmiths' Co.

"Under these circumstances the stockholders are not required to subscribe for the stock and make payments, in accordance with the vote of the Board of Directors and the circulars recently sent. Subscriptions already received will be held in abeyance.

"If the plan is to be carried out you will

be advised and ample time will be given for subscription and payments therefor."

PROVIDENCE, R. I., May 24.—In the case of George H. Robinson against the Gorham Mfg. Co., and others, Judge Brown, of the United States Circuit Court, last evening granted a preliminary injunction which temporarily prohibits the defendants from carrying into effect the resolutions which were adopted at a recent meeting of the Gorham Mfg. Co.'s stockholders, and which provides for certain issues and transfers of stock.

The Judge accompanied his decision by an opinion. The court did not base its action upon the objections raised by the plaintiff to the regularity of the meeting at which the resolutions were adopted. The Judge indicated that there is no question of fraudulent intention and that there is no uncertainty as to the majority of shareholders preferring the plan for which they voted. The Judge gives force as to the issue as to whether or not the shareholders, under their charter, have the power to carry out the proposed plan. Pending the final decision of this question, Judge Brown held that a temporary injunction is for the real interest of both parties. The Judge said in part:

"In deciding upon this petition, I do not proceed upon the ground that a fraudulent intention is exhibited in any of the acts of the defendants. Apparently it was not regarded by a majority of the shareholders of the Gorham Mfg. Co. as undesirable that Mr. Holbrook should have a large or controlling voice in the Silversmiths' Co. But whether or not this plan is preferred by a majority of the shareholders is not the question. Giving due consideration to the fact that a majority of shareholders may regard this action as for their pecuniary advantage, and to the rule that all problems of business judgment are to be determined by a majority vote, yet it must be remembered that the majority are limited in their powers by the charter, and that this cannot be overridden, however profitable it might be for a majority to carry out what they apparently, in good faith, regard as a sound business proposition.

"In view of the importance of the questions which have been presented, I am of the opinion that the complainant presents a proper case for a preliminary injunction. Having regard to the interests of a majority of the shareholders, it seems to me highly undesirable that this plan should proceed—that the Silversmiths' Co. should put forth the new issue of shares, and the exchange of Gorham Co. shares be made and the assets of the Gorham Co. transferred to the Silversmiths' Co., while this bill is pending. Should an injunction be refused at this time, and the complainant's bill subsequently be sustained, the injury to the complainant from a failure to grant temporary relief would be great, and perhaps irreparable, and the injury to the defendants, which would result from undoing what had been done, would doubtless be great. The best interests of all parties will be subserved by granting this preliminary injunction. Having in mind the statements of complainant's counsel as to his willingness to proceed speedily to a hearing on the merits, I think that, if the defendants desire, a shorter time than that allowed by the rules should be fixed for the taking of testimony, in order that the case may be finally determined on full hearing as speedily as possible.

D. S. Thompson, formerly of Livermore Falls, Me., is now at Lewiston, Me.

O. A. Hensel, 2804 North Ave., Milwaukee, Wis., writes the CIRCULAR WEEKLY that there is a good opening in that locality for a wide awake jeweler to open a store as it is the growing part of Milwaukee, having a large number of factories, some of which employ as many as 400 people. Mr. Hensel will supply further information to anyone interested in this subject.

**WM S. HEDGES & CO.,**

IMPORTERS AND CUTTERS OF

**DIAMONDS.**

Precious Stones and Pearls.

**170 Broadway, Corner Maiden Lane, New York.**

27 Holborn Viaduct, London.

**Saunders, Meurer & Co.** Cutters and Importers of**DIAMONDS** AND OTHER  
PRECIOUS STONES

FINE PEARLS A SPECIALTY.

65 Nassau St., cor. John St., Prescott Building,  
Telephone, 1613 Cortland, **NEW YORK.****Chas. L. Power & Co.,** Cutters and Importers,**DIAMONDS**

AND OTHER PRECIOUS STONES,

**170 Broadway, corner Maiden Lane, NEW YORK.**

27 Holborn Viaduct, London.

**GOODFRIEND BROS.,**

IMPORTERS AND CUTTERS OF PRECIOUS AND IMITATION STONES.

Pearls

Rubies

Sapphires

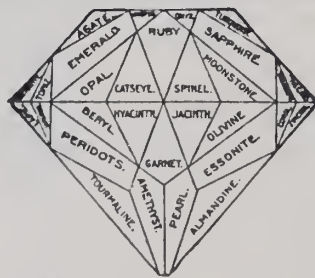

Tourmalines

Gem Corals

Opals

Emeralds

COPYRIGHT, 1895, BY GOODFRIEND BROS.

25<sup>a</sup> Westminster St., Providence, R. I.  
10 Rue Cadet, Paris.Tel. No.  
662 Cortl't.

9-11-13 Maiden Lane, New York.

**CORAL****BORRELLI & VITELLI,**  
CORAL MANUFACTURING COMPANY,All kinds of Coral—DROPS, BUTTONS, LENTILLES.  
CORAL NECKLACES, Graduated and Uniform.

PINK AND WHITE CORAL A SPECIALTY.

GOLD MEDAL, ST. LOUIS, 1904.

GRAND PRIX, LIEGE, 1905.

3 Via Amedeo, Torre del Greco, Italy.

32 Rue d'Hauteville, Paris, France.

401 Broadway, New York.

Telephone, 5412 Franklin.

CORAL

CORAL

**Mr. Retailer:**

The Jobbers  
are taxing  
us to our  
utmost capacity  
with orders  
for the best  
line of  
Gold Watch  
Cases we ever  
created.

You will be  
pleased with  
their selections,  
we assure you.

**“WATCH OUT”****SOLIDARITY****Watch Case Co.**

Established 1885.

3 Maiden Lane, New York.

GENERAL SELLING AGENTS

JOHN W. SHERWOOD

FRANK E. HARMER

### Alabama Optical Society Holds Its First Annual Meeting in Birmingham.

BIRMINGHAM, Ala., May 28.—Alabama opticians are very much pleased with the result of the first annual meeting of the Alabama Optical Society held in Cable Hall here last week and the organization of a State body to look after the interests of the eye specialist. Hardwick Ruth, of C. L. Ruth & Co., Montgomery, told a CIRCULAR-WEEKLY reporter that he regarded the movement that will give the best of results to the opticians of the State. It is expected that the session of the legislature which convenes next January will undertake to pass certain bills that will be detrimental to the profession and a committee of opticians will be formed to combat this.

The meeting was opened by W. E. Houston, secretary of the A. A. O., and J. H. Fowler, with F. W. Bromberg, of this city, acting as secretary. The following programme was carried out: "Your Neighbors of the North," H. J. Cook, Knoxville, Tenn., president of the Tennessee Association; "Optics, North and South," J. H. Tinder, Birmingham; "A Few Remarks," C. E. Folsom, Atlanta, Ga., president of the Georgia Optical Society; "Color Vision," M. B. Clason, Columbus, Ga.

The following questions were discussed: "Shall we Charge an Examination Fee?" "Shall we have a Minimum Price List?" O. H. Gerry, of Memphis, talked of "Instruments," and S. W. Lane, Kansas City, Mo., gave an interesting blackboard talk. Mr. Houston talked of organized effort.

After choosing Selma as the next place of meeting, the society elected the following officers: President, E. H. Hobbs, Selma; first vice-president, W. C. Abbott, Birmingham; second vice-president, C. F. Cross, Gadsden; secretary, J. H. Tinder, Birmingham; treasurer, M. T. Doering, Anniston.

Executive Committee: H. Ruth, Montgomery; F. W. Bromberg, Birmingham; A. N. Maumenee, Mobile; E. J. Schweizer, Selma.

Examining Board: Andrew Brown, Florence; W. E. Butt, Childersburg; J. W. Langley, Sylacauga.

### Mississippi Opticians Organize and Form the Mississippi Optical Society.

JACKSON, Miss., May 28.—With opticians present from every part of the State, the Mississippi Optical Society was last week organized at a meeting held at the Edwards House here. Officers were elected and a constitution adopted. The purpose of the society is to elevate the status of the opticians of the State by promoting higher education and a more thorough work among those who are members.

The organization of the State society was started by W. E. Huston, secretary of the American Association of Opticians, after earnest preliminary discussions and a very entertaining talk by Dr. L. W. Lane, of Kansas City. The following officers were elected:

E. R. von Seutter, Jackson, president; Theo. A. Mauch, Yazoo City, first vice-president; J. D. Crane, Gulfport, second vice-president; Albert A. Orr, Vicksburg, secretary; E. V. Waite, Corinth, treasurer.

J. B. Ellis, T. P. Martin, M. E. Fritz and

A. L. Parker were elected an Executive Committee. The Examination Committee is composed of the following: T. W. Queen, L. L. Guess and H. Watkinson.

### Arkansas Optical Society Organized in Little Rock, Ark.

LITTLE ROCK, Ark., May 23.—The Arkansas Optical Society was organized at the meeting of state opticians at the Capital Hotel Saturday afternoon. About 30 opticians from different parts of the State attended the meeting, and became charter members. Letters were read from several others, indicating their intention to join the society, and it is expected there will be a membership of more than 100 before the next annual session of the society.

The meeting was held under the auspices of the American Association of Opticians. William E. Huston, Kansas City, secretary of the association, was present and spoke on the good to be derived from organized effort. An address delivered by Dr. S. W. Lane, of Kansas City, president of the Southwestern Optical College, was one of the principal features of the meeting after the permanent organization was effected.

William E. Huston was elected temporary chairman when the session was called to order. Dr. W. F. Bailey was chosen as temporary secretary. W. B. DeShazo, formerly of Little Rock, now of Rogers, who was responsible for the organization of the society, spoke concerning the merits of such an organization. He declared the opticians of the State should be protected by State law just as other professions are, and this, he said, could not be done without organized effort.

Following his address a committee on organization was chosen consisting of W. B. DeShazo, Carl Shibly and Dr. W. F. Bailey. A committee on officers for the new organization was chosen, consisting of W. L. Foutch, C. A. Faulkner, R. E. Mosby and E. J. Bush.

At the afternoon session these two committees reported, and a constitution and by-laws were adopted. The following officers were elected:

President, T. J. Ellis, Jonesboro; first vice-president, Charles S. Stiff, Little Rock; second vice-president, Carl Shibly, Van Buren; secretary, W. B. DeShazo, Rogers; treasurer, Albert Pfeifer, Little Rock; Executive Committee, Charles Mosby, W. L. Foutch, Ira Westback, Jesse Zimmerman; Examining Board, Dr. W. F. Bailey, Little Rock; Simpson Johnson, Eureka Springs, and E. J. Bush, Benton; Reception Committee, W. B. DeShazo, Rogers; Charles S. Stiff, Little Rock; J. T. Ellis, Jonesboro; Messrs. Spott and Jefferson, Little Rock, and Dr. W. F. Bailey, Little Rock.

Those present at the meeting included:

W. L. Foutch, Gurdon; W. B. DeShazo, Rogers; J. C. Faulkner, Russellville; R. E. Mosby, Jonesboro; T. J. Ellis, Jonesboro; Carl Shibly, Van Buren; J. G. Dickson, Little Rock; Dr. W. F. Bailey, Little Rock; C. H. Gerry, Memphis, Tenn.; Dr. S. W. Lane, Kansas City; I. A. Wright, Little Rock; H. H. Stover, California; W. E. Huston, Kansas City; C. J. Bush, Benton; W. J. Martin, Van Buren; I. I. Borodoff, Texarkana; Curt H. Carmichael, Booneville; C. R. Senteer, Jackson; John C. Eberhardt, Dayton; F. Baker, Little Rock; Spratt & Daniel, Monticello; J. W. Oglesby, Gravette; Charles Mosby, Batesville; Val Taylor, Beebe; E. Y. Stinson, Benton; G. W. Keenan,

Springdale; J. M. Powell, Morrilton; T. G. Stickell, England; W. C. Bell, Ozark; H. T. McKinley, Little Rock.

### New Stores and Enterprises.

C. O. Varnson has opened a store at Hamley, Sask., Can.

H. C. King has just commenced business in Grenfell, Sask., Can.

W. S. Flory recently began business at 17 W. Main St., Dallastown, Pa.

Chas. Carr has started in the retail jewelry business in Flandreau, S. Dak.

Wm. L. Calkins is a new jeweler and optician at 509 Grand Ave., Waukesha, Wis.

The Henkers, Baker Jewelry Co. is the name of a new concern in Vincennes, Ind.

J. Riley Kyle will shortly engage in the watch and jewelry repairing business in Osborne, Pa.

G. T. Sullivan has opened a watch and jewelry repairing shop on Central Ave., Fitzgerald, Ga.

M. J. Nelson, formerly with S. Perlman, Washburn, Wis., has rented quarters at that place, where he will shortly engage in business on his own account.

Walter Longemate will, about June 9, open a retail jewelry store at 139 W. Water St., Elmira, N. Y. Mr. Longemate has been in the employ of the La France Jewelry Co., that place, for the past 12 years.

The Eastern Optical Co. is the name of a new concern recently incorporated in Massachusetts with a capital stock of \$25,000. The officers are: President, N. C. Phinney, Boston; treasurer, G. H. Quaid, Wakefield, Mass.

The J. J. Boyd Optical Co. has been incorporated in York, Pa., with a capital stock of \$10,000. The incorporators were: J. J. Boyd, W. H. Boyd and Theo. Gerrish. The concern will manufacture eyeglasses, lenses and other optical goods.

The H. C. Hart Mfg. Co. has filed a certificate of incorporation with the State secretary in Connecticut to make plated ware, etc. The capital stock is \$25,000, all paid in. The incorporators were: W. O. E. M. and H. C. Hart, all of Unionville, Conn.

The City Jewelry Store is the name of a concern which is about to be incorporated in Camilla, Ga., by C. L. Taylor, John C. Wilson, F. S. Perry, J. B. Lewis and E. E. Cox. The capital stock will be \$2,000, divided into shares of \$50 each. The firm will do a retail jewelry business.

The Dennison Drug Co. has succeeded L. J. Riesland & Co., Milaca, Minn.

The handsomely furnished new store of Andrew H. Frandsen, Monmouth, Ill., was formally opened to the public last Saturday.

Geo. H. Pease recently purchased the stock of W. S. Johnson, Baxter, Ia. Mr. Pease was formerly in the employ of Mr. Johnson.

The American Optical Co., of Southbridge, Mass., and London, Eng., last week, through Treasurer Channing M. Wells, filed with the Secretary of the Commonwealth of Massachusetts its annual corporation statement. The figures show: Real estate, \$280,900; machinery, \$162,000; cash and debts receivable, \$752,820; manufactures and merchandise, \$612,485; capital stock, \$60,000; accounts payable, \$6,767; profit and loss, \$1,742,438.

ADDISON W. WOODHULL, President.  
FRANK K. HUFF, Vice-President.

GILBERT T. WOODHULL, Treasurer.  
WILLIAM J. McQUILLIN, Secretary.

## MOUNT & WOODHULL,

IMPORTERS OF

**DIAMONDS,  
OTHER PRECIOUS STONES,  
PEARLS, ETC.**

MAKERS OF

**FINE  
DIAMOND  
JEWELRY.**

26 Maiden Lane,

(Southwest Corner Nassau Street)

**NEW YORK.**

**PARIS ADDRESS:  
5 SQUARE DE L'OPERA.**

**BAGG, PERINE & CO.,**  
RARE SPECIMENS OF  
DIAMONDS AND OTHER  
PRECIOUS STONES,  
21 & 23 MAIDEN LANE, NEW YORK.  
Tel. No. 6228 Cortlandt.

**EMERALDS,  
DIAMONDS  
AND  
PEARLS.**

**RUBIES AND  
SAPPHIRES.**

**CABLE ADDRESS:  
MILBAGG.**

**M**Y interest is with the buyer. Why? He pays me 2 per cent. for my services. The seller's interest is with me. Why? He is not compelled to divide his profits with me and can afford to make the closest prices to my clients, thus reaching the best American trade on conditions that cannot fail to gain their preference.

The buyer's interest is also with me. Why? By not exacting the usual commission I make it to the seller's interest to favor my clients. Nothing is added to the price. I am content with what the buyer pays me. The buyer's advantage under such circumstances is equally as evident as the seller's. I invite investigation of that point.

**FREDERICK A. JEANNE,**  
"Gemfinder,"

5, Square de l'Opéra, PARIS, FRANCE.

London: Chancery Lane Safe Deposits.

New York: Maiden Lane Safe Deposit Co.

## Crossman Company

There is nothing that appeals more to a June bride for her bridesmaid's gifts than the dainty and inexpensive Necklaces and Pendants that we make.

3 Maiden Lane, - New York.

## Newark.

Two peddlers who were selling worthless jewelry at Rutherford, N. J., and otherwise misconducting themselves were, last week, sent to the Hackensack jail for 15 days by Recorder Yates. The prisoners, who said that their home was in New York, gave their names as Frank Davis and John O'Neill.

Thomas J. Bradley, formerly in business at 372 Broad St., who went into bankruptcy more than a year ago, and whose troubles in the courts have been reported from time to time, last week appeared before the referee in bankruptcy. Mr. Bradley refused to answer any questions that would throw light on his conduct of the business, basing his refusal on the ground that information thus solicited might be used in prosecuting him on the indictment which has been found by the Federal Grand Jury. The examination was postponed indefinitely. Bradley will be tried soon. It is expected, on the indictment charging him with concealing assets from creditors.

Reeves & Browne, manufacturers at 4 Walnut St., last Saturday, caused the arrest of Howard K. McKenzie, 29 years old, living at 220 St. Mark's Pl., Brooklyn, who had been employed by the firm as a salesman. He is charged with appropriating to his own use samples to the value of \$2,150. Mr. McKenzie was taken to the First Precinct Police Court, where he was held in \$1,000 bail for the action of the Grand Jury and he afterward furnished the bond. He entered the firm's employ Jan. 1. The members of the firm were recently informed that he had pawned in New York and other cities pieces of diamond jewelry that had been entrusted to him. They notified him to report at the office. It is said that, his suspicions being aroused, he redeemed some of the articles that had been pledged, and he brought with him, when he reported, jewelry to the value of \$1,200. The property still missing, according to statement furnished by the firm, include 20 diamond brooches, 19 diamond scar pins, 12 pairs of diamond sleeve buttons, four diamond fob chains, four diamond rings, seven diamond bracelets, 15 diamond lockets and one diamond boa clasp.

James F. Malone, a well-known resident of New Haven, Conn., where for some time he was in the employ of the Harvey & Lewis Optical Co., died, May 26, at his home, that place, of apoplexy. He was at one time editor of the *New Haven News*.

There was a well-attended meeting of the Louisiana Optical Association in New Orleans, La., May 19, and the following were elected members of the board of directors: S. P. Schuessler, Baton Rouge; James P. Williams, New Orleans; Lou Frigerio, New Orleans; Jacques Beek, New Orleans; Edw. Clandel, New Orleans; N. Bellamore, New Orleans; L. Burkett, Abbeville, La.; Edw. Bohne, Covington, La. There was a later meeting of the board of directors and the following officers were elected: S. P. Schuessler, president; James P. Williams, first vice-president; Lou Frigerio, second vice-president; Jacques Beek, secretary; Edw. Clandel, treasurer; N. Bellamore, auditor.

## Connecticut.

Chas. H. Seyfried, New London, is closing out his optical stock, and will leave for New York, June 1.

In Stamford the retail jewelry stores now close on Tuesday, Thursday and Friday evenings at seven o'clock.

Thomas Niland, of the J. J. Niland Cut Glass Co., South Meriden, has returned from a business trip to New York in the interest of the concern.

The Sessions Clock Co., Forestville, began its summer schedule May 19. The shops will be closed every Saturday afternoon during the Summer.

The New England Watch Co., Waterbury, will close its plant every Saturday afternoon during the Summer season and at 3:30 P. M., during the other working days.

Chas. G. Drechsler, formerly with the Bradley & Hubbard Mfg. Co., Meriden, died about a week ago, in the Meriden Hospital, aged 55 years. Death was caused by cancer.

Watch repairers in Bridgeport declare that the week ending May 23 was one of the busiest which they have experienced in several years, owing, they say, to the recent explosion which deranged numerous watches.

Thus far no clue has been obtained to the thief who robbed Barney Steinfeld, 504 Sixth Ave., New York, of \$3,000 worth of watches and diamonds in New Haven. The loot includes four watches, three diamond horseshoe pins and 10 diamond rings.

The New Haven Clock Co. is among other concerns which recently began to operate their factories according to the Summer schedule. This plant will be closed Saturday afternoons in accordance with the concern's annual custom.

John Mitchell, formerly assistant foreman in the tool room of the Waterbury Clock Co., Waterbury, was recently presented by several of his fellow employes with a purse of gold on the occasion of his resignation to accept a position out of town.

Hilding Stromberg, in the employ of Landers, Frary & Clark, New Britain, was caught in a belt while at work on Monday morning, of last week, and drawn around the shafting, his left arm being torn off at the elbow. He was taken to the New Britain general hospital in a critical condition.

J. J. Niland Cut Glass Co., manufacturers of cut glass, South Meriden, last week gave an exhibition of glass cutting in one of the large general stores, in New Haven. A number of glass cutters were at work showing the various processes through which the blank must pass before it is a finished product.

The Waterbury Clock Co., Waterbury, has been made the defendant in a suit for \$1,200 for damages brought against it by Jos. Marchitto who claims to have lost a finger on a power press which was not properly cared for. Among the witnesses for the plaintiff is Supt. W. J. Larkin, of the concern.

Willard A. Blakeslee, for several years in the employ of the Waterbury Clock Co., Waterbury, died recently at his home on S. Main St., Thomaston, after a prolonged

illness of cancer of the liver. The deceased was 46 years of age and at one time worked in the marine department of the Seth Thomas Clock Co.

## Lancaster, Pa.

William Smith, engraver, late with the H. M. Musser Silver Plate Co., has entered the employ of Ezra F. Bowman's Sons.

The baseball team of the Hamilton Watch Co.'s factory will open their season on Memorial Day with a game with the Athletic team.

Among the jewelers visiting this city lately were J. A. Kirk, Quarryville; S. H. Miller, Mt. Joy; August Carmany, Coatesville; C. E. Hinkle, Ephrata.

M. Berman, Altoona, Pa., jeweler, was in Lancaster last week, having come to place his brother in the Ezra F. Bowman Technical School as a student.

H. E. Randall, late of New York, has taken a place with S. Kurtz Zook as optician and watchmaker, succeeding James A. Currie, who intends locating at Sheridan or New Castle, Pa.

The theft of two gold watches about two weeks ago from Harry Sobel's jewelry store, has been traced to a 12-year-old boy, Roy Portner, who confessed to the theft of one of them. He will be tried before the Juvenile Court.

Last week a San Francisco jewelry firm returned to the Hamilton Watch Co. a number of watches which had passed through the great fire, in a safe. The cases of all were crusted with black oxide, but two of the timepieces were in good running order.

As more of the jewelry stolen from L. C. Reisner, while on a railroad train between Harrisburg and Chambersburg, has been returned, sentence has been suspended for the present on William Fraker, a railroad engineer, who pleaded guilty in the court at Carlisle recently to the theft. Of the \$3,500 worth of jewelry stolen, over \$2,000 worth has now been recovered.

The funeral of Abraham Bitner, through whose effort the old Lancaster Watch Co. came into existence, and of which he was the manager for some years, took place Wednesday and was largely attended. Among those present were 20 of his old employes, who are now with the Hamilton Watch Co., which succeeded the Lancaster concern.

## Cleveland.

L. M. Sigler, of the Sigler Bros. Co., sailed for Europe a few days ago and will be in the diamond market for some time.

Capt. R. E. Burdick, of the Bowler & Burdick Co., will sail for Europe early in July to purchase diamonds for next season.

E. B. O. Smith and wife, Lancaster, O., were in this city, last week, on their honeymoon trip. While here Mr. Smith called on some of the wholesale houses.

W. B. Blood, Chicago, Michigan representative of the Scribner & Loehr Co., was at the house, last week, as was Mr. Knight, who has another portion of the same State.

Among the merchants visiting in the city within the last week were the following: H. H. Brainard, Medina, O.; Frank Dyer, Caro, Mich.; W. W. Wells, Lodi, O.;

George High and Mrs. High, Medina; Harry Downs, Bellevue; John McClintock, Chagrin Falls; Mrs. A. R. Kimpton, Oberlin; E. E. Critz, of the Critz-Hascrodt Co., Elyria; Albert Zang, of J. A. Zang & Sons, Alliance; and F. N. Prevey, of F. N. Prevey & Co., Akron.

## Buffalo, N. Y.

Best & Co., 11 E. Genesee St., have completed the decoration of the front of their jewelry store.

Meyer Brown, 136 Seneca St., has completed alterations to his store and added a large new safe.

John Magner, former manager of the optical department of the Progressive Co., was in Utica Wednesday of last week to attend the funeral of his nephew, who died suddenly.

Jirch Kinney, 92 Seneca St., has reached the age of 70 years, and is anxious for a business partner. Mr. Kinney, who lives in East Aurora, established his jewelry store in Buffalo 35 years ago.

The Grant St. jewelry stock of W. Z. Jarden, bankrupt, recently purchased by Buehl Bros., as an investment, is still locked up in the establishment. Buehl Bros., who also purchased the Philip Fischer bankrupt stock, now on sale at 390 Main St., will dispose of the Jarden stock in a similar manner.

The retail jewelers of E. Genesee St. are liberally signing an agreement for the closing of their stores in July and August at 6 o'clock every evening of the week. For years the jewelers in this thoroughfare have kept their stores open evenings the year round till 9 o'clock. The agreement also stipulates that the stores shall be closed Saturday afternoons in the months mentioned.

Buffalo jewelry merchants are very indignant by reason of a raid upon them by court officers with subpoenas summoning them to serve as jurors in civil and criminal cases. In one or two instances the merchants have been subpoenaed without notice, and ordered to lock up their stores in order to accompany the officers to the City Hall, they being alone in their stores at the time the service was made. The complaining jewelers declare there are enough men available as jurors without the officers dragging them out of their places of business.

Walter Harrington, under indictment here for robbing the store of Paul Foerster, 134 Seneca St., will not be brought to trial until the arrest of Eugene Dobel is made, if this is possible. A warrant was issued last week for Lobel, charging him with complicity in the theft of \$3,000 worth of diamonds from Mr. Foerster's establishment. Recently Lobel was arrested in Memphis, Tenn. He was released and left Memphis before the Buffalo authorities could get papers for his arrest there. Mrs. Foerster was told by Buffalo physicians that unless she went into the country for a rest she could not expect to live more than two months. She promptly took the advice of the physicians. Mrs. Foerster's health has failed rapidly since a tray of diamonds was stolen from her in her husband's store. She has brooded constantly over the loss of the jewels, and the fact that they were stolen while she was exhibiting them.

# EICHBERG & CO.,

IMPORTERS AND CUTTERS OF

## DIAMONDS,

65 NASSAU STREET,

(Prescott Building.)

NEW YORK.

# STERN BROS. & CO.,

IMPORTERS AND CUTTERS OF

## DIAMONDS,

CUTTING WORKS:  
138-142 West 14th St., N. Y.

CHICAGO, LONDON,  
103 State Street. 29 Ely Place.

68 Nassau St.,

NEW YORK.

## A. ROSEMAN, 9-11-13 Maiden Lane, New York

IMPORTER OF

# DIAMONDS

Maker of Diamond Jewelry



Established 1872

HEADQUARTERS FOR

# AMERICAN WATCHES

IMPORTERS

## DIAMONDS

CUTTERS

# Jacob Strauss & Sons

14 MAIDEN LANE

NEW YORK

## LEO GOLDSMITH, IMPORTER OF DIAMONDS

TELEPHONE: 4115 CORTLAND.

and Precious Stones. Headquarters for Recon-  
structed Rubies and Sapphires. All sizes and forms.

9-13 MAIDEN LANE,

NEW YORK.

## SOHN and HYMAN

IMPORTERS OF PRECIOUS AND IMITATION STONES

Crystals Engraved and Painted from Photo. Crests and Coats of Arms Engraved. Stone  
Seal Engravers and Incrusters. Lapidary Work a Specialty.

JOBING STONES A SPECIALTY

47 and 49 Maiden Lane,

NEW YORK

# AMERICAN PEARLS

From Ten to Ten Thousand Dollars Each

MAURICE BROWER, 16 John St., New York.

## TRADE-MARKS

OF THE JEWELRY AND KINDRED TRADES.  
Over 4,000 Marks. Second Edition. Price, \$3.00.  
The Jewelers' Circular Pub. Co., 11 John St., N. Y.

## Boston.

F. A. Colburn, Cambridge, has been spending a week at his Summer cottage at Lake Sunapee, N. H.

Samuel Mendlesohn, dealer in watches and jewelry, has moved from room 800 Jewelers' building, to rooms 713 and 714 Washington building.

D. C. Percival, of D. C. Percival & Co. has gone to Maine on a fishing trip. His son, Lawrence F. Percival, and his bride have returned from their European wedding trip.

T. S. Reynolds, the London, Eng., manufacturer of barometers and thermometer was in Boston recently, renewing his acquaintance with his customers. This was his first visit to the city of Boston in many years.

The many friends of John B. McKinley, with Nelson H. Brown, 90 Frank St., will be grieved to hear of the death of his daughter, Julia, who died May 21, of acute indigestion, after a sickness of a few hours. She was 18 years of age.

The following jewelers were in Boston during the week: G. V. Turgeon, Lewiston, Me.; F. Ricard, Lowell; Starr Hewitt, Salem; Mr. Pratt, with Har Raynes, Lowell; J. H. Jacques, Haverhill; S. K. Gurney, of Gurney Bros. Co.; Breton; Robert A. Lohnes, Worcester; Thomas Margetts, Hingham; E. E. Coddington, Norfolk.

Mrs. May Mott Smith Cunningham, San Francisco, Cal., is exhibiting a fine collection of hand-wrought jewelry at Arlington St., in this city. The designs are original with her and are artistic, though they are on a rather big scale, and some of them are almost barbaric in their magnificence. Precious stones are employed as the central motifs and the surrounding designs harmonize so that each gem has the most becoming setting. Mrs. Cunningham's studio was burned during the recent San Francisco disaster and shows several designs which were taken from the safe after the fire, and which are curiously discolored, showing the peculiar action of heat on metals and gems.

The Medal Comb Co., Templeton, Mass., was incorporated under the laws of Massachusetts. It has a capital of \$10,000, the par value of the stock being \$100 per share. Its charter authorizes it to buy land, build a factory, manufacture and deal in combs, brushes, hair pins, buttons, buckles, fan articles, and novelties of horn, bone, celluloid, amber, or other substances; purchase patents. No share of stock is to be sold until it is offered to the stockholders. The incorporators were: President and treasurer, Frank L. Hopkins, Templeton; clerk, Edward W. Walsh, Templeton, and Joseph P. Camery, Templeton. These three are the directors of the company.

The Enterprise Cut Glass Co. has awarded the contract for the erection of a large factory in Elmira Heights, Elmira, N. Y. The building will be situated at the corner of 8th St. and College Ave. The concern is now located in Honesdale, Pa., but will move to the new territory as soon as the factory is completed.

# Our Traveling Representatives



E. A. Woodmancy, representing Potter & Button Co., Providence, R. I., was in Toronto, Ont., last week.

The following salesmen were in Boston, Mass., during the week: J. Williams, Fera & Kadison; Mr. Sherwood, Solidarity Watch Case Co.; John W. Reddall; L. Henry Jurgens, Snow & Westcott; J. H. Hardin, F. A. Hardy & Co.

Among the travelers on the Pacific Slope, recently, were: F. R. Sheridan, Arnold & Steere, who visited the trade in San Francisco and Oakland, Cal., last week, and Fred Carpenter, W. & S. Blackinton Co., who was in Oakland last week.

Among the traveling representatives to visit Buffalo, N. Y., last week, were: Leo Goldsmith; Chas. F. Swazy, Champenois & Co.; C. B. Bartlett, Whiting Mfg. Co.; E. Huston, Mandeville, Carrow & Crane; John C. Hull; Mr. Gregory, Strobell & Crane; Walter S. Noon, Cory Bros. Co.; Chas. S. Untermeyer, Chas. Keller & Co.; Mr. Barnum, Shafer & Douglas; J. B. MacDonalld, Wolcott Mfg. Co.; E. J. Rider, Walter E. Hayward.

The following traveling representatives visited the trade in Lancaster, Pa., last week: D. Fox, Lyons Gem Co.; Walter H. Young, Simpson, Hall, Miller & Co.; S. K. Jones; Harold G. Tinecker, Bride & Tinecker; H. B. Bliss, Gorham Mfg. Co.; A. E. Silberman, Leon Hirsch; Henry Greenthal, Albert Lorsch & Co.; William G. McIlwain, A. R. Justis Co.; E. P. Ledos, Ledos Mfg. Co.; Frank Byrnes, H. D. Merritt Co.; Mr. Creamer, J. T. Mauran & Co.; Frank Sohmer, Arnold & Steere.

Among commercial travelers in Columbus, O., during the past week, were: A. J. Augustin, Dennison Mfg. Co.; M. W. Porter, J. M. Fisher & Co.; P. H. Winterberg, Sprochnle & Co.; J. R. Kraus, Zach. A. Oppenheimer; R. B. Renick, Geo. Borgfeldt & Co.; F. C. Allen, Sansbury & Nellis; Fred T. Barry, S. O. Bigney & Co.; Mr. Guggenheim, Ingomar Goldsmith & Co.; G. W. Bleeker, Martin, Copeland & Co.; H. C. Bliss, Bliss Bros. Co.; D. Skutch, New Haven Clock Co.; Helmer Thompson, F. H. Noble & Co.

Among the traveling representatives who, recently, visited the trade in Detroit, Mich., were: George S. Melville, F. B. Rogers Silver Co.; H. W. Valentini, Alvin Mfg. Co.; H. C. Barnum, Shafer & Douglas; Mr. Macpherson, C. Ray Randall & Co.; F. C. Allen, Sansbury & Nellis; J. C. Bigalke, Bigalke & Eckert Co.; R. P. Caughlin, C. G. Alford & Co.; Jack Thompson, J. B. Bowden & Co.; Mr. Wile, Buffalo Jewelry Case Co.; J. B. Read, Shepard Mfg. Co.; G. W. Bleeker, Martin, Copeland & Co.; Mr. Hayes, Ehrlich & Sinnock; J. E. Simonson, Ludwig Nissen & Co.; A. J. Parker, Osmun-Parker Mfg. Co.; W. H. Osborne, R. Wallace & Sons Mfg. Co.

The following traveling salesmen called on the trade in St. Louis, Mo., last week: C. B. Bartlett, Whiting Mfg. Co.; John J. Moffitt, Battin & Co.; Samuel Jacobson, Jacobson Bros.; F. R. Horton, Carter, Howe & Co.; J. P. Wayton, Lebkuecher & Co.; George W. Beardsley, Allsopp & Allsopp; S. W. Abbey, E. Ira Richards & Co.; S. H. Brower, Edwin Lowe & Co.; J. B. Freeman, Freeman, Daughaday & Co.; Hubert Sombrom, Hipp, Didisheim & Bro.; Emil Pick, Hammel, Riglander & Co.; Joseph S. Frank, Sussfeld, Lorsch & Co.; Joseph Rifkin, L. Heller & Son; H. C. Rowbotham, Schrader-Wittstein Co.; C. T. E. Smith, Reed & Barton; Milton S. Rodenberg.

The following traveling representatives called on the trade in Kansas City, Mo., during the past week: Geo. W. Beardsley, Allsopp & Allsopp; I. H. Blatt, W. G. Pollack & Co.; F. R. Horton, Carter, Howe & Co.; W. B. Howe, Bradley & Hubbard Mfg. Co.; Jul. F. Schuman, Jr., William Kinschke Co.; E. C. Holbrook; Mr. Sherman, estate of O. M. Draper; James O. Otis, Harvey & Otis; S. H. Brower, Edwin Lowe & Co.; E. J. Walther, D. F. Briggs Co.; L. W. Arnold, Western Clock Mfg. Co.; Mr. Boss, Standard Button Co.; J. Rothschild, Kaffeman, Rothschild, & Co.; Walter R. Shute, Kohn & Co.; Mr. Vaslett, Fletcher-Burrows Co.; Mr. Finberg, Finberg Mfg.

Co.; Wm. Matschke, A. Joralemon & Son; Jos. S. Frank, Sussfeld, Lorsch & Co.; Emil Pick, Hammel, Riglander & Co.; G. W. Cureton, Henry G. Lefort.

Traveling representatives who called on the Cincinnati, O., trade, the past week, included: B. Eichberg, Eichberg & Co.; Morris Baer, Attleboro Mfg. Co.; Bernard Simms, Simms & Co.; Mr. White, Esser & Co.; Mr. Newberger, R. Blackinton & Co.; J. Palmer, H. A. Kirby Co.; G. Rodenberg, Rodenberg Mfg. Co.; Mr. Mayor, William H. Luther & Son; Charles Lyons, Torrey Jewelry Co.; Mr. Oakley, Thornton Bros.; Mr. Fry, Fry Bros.; F. R. Truett, W. H. Saart Co.; Mr. Parks, C. H. Cooke Co.; J. Cobb, F. M. & J. L. Cobb; Mr. Valentine, Taunton Pearl Works; Frank L. Carpenter, Dominick & Hoff; Charles F. Sexton, William L. Sexton & Co.; R. H. Brown, Barden & Hull; C. B. Bartlett, Whiting Mfg. Co.; Mr. Bishop, Bergfels & Co.; H. Somborn, Hipp, Diddisheim & Co.; Mr. Hodgson, White & Co.; F. W. Pearce, Bay State Optical Co.; Mr. Levy, Byron L. Strasburger & Co.; Maxy L. Potter, J. L. Fisher Co.; Arthur Bradshaw, International Silver Co.; W. S. Sparrow, Stern Bros. Co.; Emil Herbeck, Herbeck, Deiner Co.; H. C. Wilson, Crescent Watch Case Co.; F. E. Buffum, Bristol Mfg. Co.; T. C. Keys, L. E. Waterman Co.; C. B. Bartlett, F. W. Weaver & Co.; W. W. Evans, T. G. Hawkes & Co.; Mr. Fox, Fox & Co.

Traveling representatives who called on the trade in Omaha, Nebr., last week, were: C. C. Achorn, Colonial Silver Co.; C. H. Davison, Coding & Heilborn Co.; L. W. Arnold, Western Clock Mfg. Co.; Mr. Remington, Carter, Quynstrom & Remington; J. Rothschild, Kaffeman, Rothschild & Co.; F. L. Pettee, Waterbury Clock Co.; William T. Smith, International Silver Co.; Fred J. Foster, Unger Bros.; Richard Merker, Bates Bros. Co.; Mr. Noble, Sturtevant, Whiting & Bigelow; George E. White, White & Roundsville; George L. Paine, Geo. L. Paine & Co.; Helmer Thompson, F. H. Noble & Co.; G. Fred Perry, F. H. Sadler Co.; Mr. Wilkins, Ostby & Barton Co.; Arthur H. Moore, Moore & Son; H. A. Scofield, Scofield, Melcher & Scofield; H. E. Cobb, Daggett & Clap Co.; E. J. Walther, D. F. Briggs Co.; Ernest Block, Louis Stern & Co.; W. D. Sinnock, Ehrlich & Sinnock; Ira C. Jones, Chas. L. Trout & Co.; Chas. E. Lachner, Hayes Bros. Co.; John A. Lassau, Martin, Copeland & Co.; C. F. Hartshorn, Krcwenz & Co.; De Lancy Stone, Shafer & Douglas; R. L. Robinson, Dennison Mfg. Co.; E. C. Holbrooke, Ferdinand Bing & Co.; Ralph C. Dick, St. Louis Clock and Silverware Co.; Chas. E. Howe, E. L. Logee & Co.

The following traveling representatives visited the trade at Pittsburg, Pa., last week: F. C. Allen, Sansbury & Nellis; D. Skutch, New Haven Clock Co.; R. C. Read, H. F. Barrows Co.; Frank S. Ottley, Riker Bros.; Wallace E. Welch, Hoyt, Obrig & Geiger Co.; E. A. Reed, Reed & Barton; Frank W. Cullom, Sulzberger Bros.; E. R. Barnett, Waite, Mathewson & Co.; Maurice Kohn, Silbermann, Kohn & Wallenstein; Mr. Fisher, Furbish, Swift & Fisher; Wm. Matschke, A. Joralemon & Son; Charles L. Drown, Ostby & Barton Co.; E. J. Walther, D. F. Briggs Co.; E. M. Bliss, Bliss Bros. & Co.; Mr. Strandberg, Sykes & Strandberg; Donald Le Stage, H. D. Merritt Co.; Mr. Bleeker, Wm. S. Hedges & Co.; M. V. Decker, Plainville Stock Co.; I. W. Lederer, S. & B. Lederer Co.; H. B. Bliss, Gorham Mfg. Co.; G. W. Bleeker, Martin, Copeland & Co.; O. P. Bliss, Wm. C. Greene Co.; W. R. Eliot, Meriden Cut Glass Co.; J. M. Morrow, American Watch Case Co.; Mr. Finberg, Finberg Mfg. Co.; Mr. Somes, Bates & Bacon; Wm. Rosenberger, A. Wallach & Co.; George H. Remington, Maintien Bros. & Elliott; Louis A. Blackinton, W. & S. Blackinton Co.; Mr. Bishop, Bergfels & Co.; J. Ira Lester, Milton L. Ernst; A. W. Levy, Byron L. Strasburger & Co.; Fred T. Barry, S. O. Bigney & Co.; C. L. Cabot, Bishop Co.; C. B. Bartlett, Whiting Mfg. Co.; B. A. Noble, Sturtevant, Whiting & Bigelow; John D. Dalzell, J. D. Dalzell & Co.

The losses by fire at the Bradley & Hubbard Mfg. Co.'s factory, Meriden, Conn., were recently adjusted. Chief Lucas recorded the loss on the building at \$2,000 and that on the contents about \$11,000. It was generally believed that the total loss would be almost \$20,000. An inventory of the stock, however, revealed that much of the finished stock escaped serious damage.

## New Orleans, La.

Louis Moss, a Carondelet St. jeweler and diamond setter, who was arrested for stealing a quantity of jewelry from William Frantz & Co., 142 Carondelet St., pleaded guilty to larceny before Judge Chretien, in Section B, of the Criminal District Court, a few days ago. The plea is a compromise one, and under the law Moss will escape the penitentiary, but be compelled to serve the term in the parish prison. The first charge against the diamond setter was embezzlement, but Mr. Frantz, not wishing to be severe on the man, agreed to have him plead guilty of the lesser offense. Moss did job work for Mr. Frantz and other jewelers, and several weeks ago he created something of a sensation by declaring that two masked men had come into his place while he was working at night, and at the point of a pistol robbed him of a lot of valuable property. The property stolen belonged principally to Mr. Frantz and the remainder to private customers. The detectives went to work on the case and recovered most of Mr. Frantz's jewelry in pawnshops, where it had been pledged by Moss.

The battleship *Louisiana* has been completed and the Progressive Union intends to raise \$10,000 with which to purchase a magnificent silver service for the great floating fortress. The old plan of making the gift a \$2,500 set has been abandoned, and on the new proposition Governor Blanchard and Mayor Behrman are expected to play their parts. The committee, of which Andrew Blakely is chairman, had a meeting Saturday and reached the decision to ask Mayor Behrman to take full charge and boom the proposition to its utmost. Governor Blanchard is enthusiastic over the project and thinks that the Pelican State should do full honor to its splendid namesake. A committee will be appointed in each parish to solicit funds, and each parish committee will have power to appoint a sub-committee to work in the towns and villages. When Assistant Secretary of the Navy Newberry was in New Orleans a short time ago he informed the committee that the *Louisiana* would be sent here to receive the service any time during the Fall that the citizens desired, and it is probable that the committee will select either October or November for the visit.

The Mutual Aid Association of the silver workers employed by the Towle Mfg. Co., Newburyport, Conn., held its first annual assembly in the City Hall of that town May 21, and the affair was voted a great success by all who participated and attended. The Towle Mfg. Co.'s orchestra rendered a number of selections and the programme of the evening included a number of original musical compositions composed and performed by members of the association. There were also humorous sketches, fencing bouts, athletic exhibitions, a minstrel sketch and a farce, after which refreshments were served and dancing was indulged in until the small hours of the morning. The affair was in charge of the executive committee, of which C. N. Saford is chairman, and C. E. Groaton, secretary and treasurer.

# DIAMONDS

Complete Stock—Right Prices

'NOUGH SAID

WM. I. ROSENFELD

19 Maiden Lane

NEW YORK



## FESTOON NECKLACES

The increasing demand for high grade Festoon Necklaces has compelled us to make up a larger and more varied line of them than ever before, set in combination with Diamonds, Baroque Pearls, Aquamarine, Topaz, Peridots, Amethysts, Turquoise, fancy Sapphires, etc., etc.

CUFF BUTTONS      LOCKETS  
BROOCH PINS      SCARF PINS  
BRACELETS

**COOPER & FORMAN** OFFICE AND FACTORY  
3 MAIDEN LANE, NEW YORK  
MAKERS OF DIAMOND JEWELRY

## ORNAMENTAL HAT PIN HOLDERS

A Useful and Artistic Conceit in  
SILVER DEPOSIT ON GLASS

that contributes greatly to  
the appearance of any dresser

MADE IN A VARIETY OF HIGHLY ARTISTIC DESIGNS

Splendid sellers during the vacation period



**LACKNER & OHL**

50 Columbia Street

NEWARK, N. J.

Occasionally you need one of those so-called "old mine" square stones and you do not know where to find it. Call or write to

**CHAS. S. CROSSMAN & CO.**

3 MAIDEN LANE, NEW YORK,

where you will always find some in stock.

Diamonds, Pearls and Antique Jewelry  
bought for CASH.

Appraisals Made.

Estates a Specialty.

N. B. Our Baroque Pearl Jewelry business has been  
incorporated as the Crossman Company.



THE TRADE

desirous of keeping in touch with modern, profit-producing methods, should always consult the 500 pages of

OUR BIG CATALOGUE,

with its 30,000 illustrations and long list prices. We send this splendid book free on request.

*S. F. Myers & Co.*

Headquarters for Dueber-Hampden Watches.

WHOLESALE JEWELERS

The New S. F. Myers Bldg. 476-49 Maiden Lane New York.

Guinand's Reliable Split Timers and  
Split Chronograph Watches.

Nickel, Gun Metal, Silver and Gold Filled Cases.

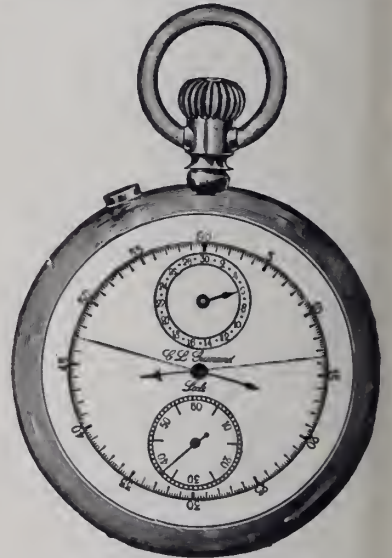

**JULES RACINE & CO.**  
EXCLUSIVE IMPORTERS.

Chicago Office, New York Office,  
103 State Street. 37 Maiden Lane

For Sale By All Jobbers.

*Practical Course  
in Adjusting*

By THEO. GRIBI.  
PRICE, \$2.50.

250 pages, including 18 diagram plates; Fine Paper; Large Type; Clear Illustrations; Systematically Arranged; Solid Binding.

THE JEWELERS' CIRCULAR PUBLISHERS,

11 John St., cor. Broadway, New York.



## Philadelphia.

Ferdinand Levy, 929 Chestnut St., has returned from an extended southern trip.

Homer Vernon, watchmaker, has resigned his position with Strawbridge & Clothier.

T. C. Kremer, Phoenixville, spent a few days last week attending the conclave of the Knights Templars at Royers Ford, Pa.

H. Garfinkel is closing out the business conducted by him in the Mint Arcade building and proposes shortly to vacate the store.

Gustave Lauz, Norristown, returned last week from a week's pleasure trip traveling through historic battlefields of the Civil War.

J. E. Caldwell & Co. have designed and made the prizes for the American Rowing Association's Regatta on the Schuylkill River.

The retail store of Roland Oliver, Beverly, N. J., was entered by thieves last week and a considerable quantity of jewelry was stolen.

W. B. Hens, 717 Sanson St., enameler, has removed with his family to Wildwood, N. J., for the Summer, where he has taken house.

William Liener has completed the installation of new fixtures in his new store 2236 N. Front St., and held his formal opening last week.

George Schaffner, who recently sold his jewelry store at 210 Woodward Ave., has gone into the brokerage and loan business in the Loyal Guard building.

Ben Meisner and David King, baker and lothier, respectively, succeed S. H. Ives and H. T. Phillips in the loan business at 4 Monroe Ave. S. Schwab is manager.

Bailey, Banks & Biddle Co. was awarded the contract, last week, for the prizes and trophies for the Spring and Summer golf tournaments of the Wilmington Country Club.

J. E. Caldwell & Co. are making a display of prizes and trophies together with the Bailey, Banks & Biddle Co. for the fashionable Horse Show at St. Martin's Green.

A. R. Justice Co. was awarded the contract last week for the prizes to be awarded at the tennis tournament to be held by the Philadelphia Morning Paper Carriers' Association.

The Eye Fix Remedy Co., of this city, was on hand at the annual convention of the Ohio Optical Association, which met at Columbus, May 28-29. The concern presented a handsome badge to each member.

Patrick Haggerty, watchmaker, recently with S. J. Lyons, 2258 N. Front St., this city, last week bought out the retail store in Mauch Chunk, conducted by Fred. Loos. The latter had been formerly with John MacPherson and had conducted the business only a short time. Mr. Haggerty is widely known in this city's trade.

About 80 wholesale and manufacturing jewelers and opticians of this city have organized a society for the purpose of making Detroit known as a center for their business. They will co-operate with the Board of Commerce. The officers are: President, Frank Kennedy, of the Kennedy Optical Co.; vice-president, R. E. Rogers, of Kunz & Rogers; secretary, Charles Ber-

key; treasurer, Alfred E. Patterson. A name will be adopted and directors chosen at another meeting to be held June 1.

Miss M. Rubenstone, a niece of Jacob Rubenstone, with whom she was associated for about five years, has started in business for herself at 711 Sanson St., as a manufacturing jeweler and diamond setter, with repairing for the trade as her specialty. Miss Rubenstone is the only woman conducting a like business on her own account in this city, but since she has acquired a thorough familiarity and wide experience from her long association with her uncle, who is now in the jobbing business at 127 S. 7th St., a prosperous career is predicted for her.

David Baghivo, the Italian jeweler at 1454 S. 11th St., who claimed that a colored man named William Peterson attempted to rob him last week while pretending to make a purchase, failed to make out a prima facie case at the magistrate's hearing Friday and the prisoner was promptly discharged from custody. Baghivo, who said he was sure that Peterson meant to rob him, fired at the latter with a revolver. The shots attracted a policeman's attention and Peterson was arrested. The prisoner argued that the jeweler persisted in quarrelling with him over the price of an article, and after an argument he left the store only to be shot after and arrested.

The carefulness of Benjamin E. Sattler, who is connected with the jewelry and pawnshop of M. & S. Fridenberg, 37 W. 11th St., was responsible last week for the arrest of a man and a woman who were accused of attempting to dispose of a watch which had previously been reported to the police as a part of a quantity of stolen jewelry. The watch was offered to Sattler by James J. Miller, and the clerk noticing the initials "J. E. D." on the back remembered that such a watch had been described as part of the loot stolen from the house of Mrs. E. Ferris. Sattler questioned Miller, who said he had been given it to pawn by the girl who was outside. He then went out called the girl in and notified the police, who later arrested the pair. The girl gave her name as Grace Dean, and corroborated the story of the man, that he was a stranger to her and had simply granted her request to pledge the watch. After some questioning the girl told the detectives where she lived, and at her home they found a clock and several other pieces of jewelry. Although the police found Miller to be comparatively innocent in the action, he was held as a witness and he, the girl and a man said to be the girl's husband, who was later arrested, were all held in \$600 bail.

H. Brouse recently moved into his newly furnished store at 168 Sparks St., Ottawa, Ont., Can.

The following recently passed the examination of the Board of Regents of the Illinois State Optical Society, and are now members of that society: Oliver Savill, Canton, Ill.; Geo. W. McFatrieh, M.D., secretary of the Northern Illinois College of Ophthalmology and Otology; Max Goldberg, Chicago; W. A. Foley, Chicago Heights; S. A. Carpenter, Harvey, Ill., and Victor H. Sponberg, Chicago. The Board will meet shortly.

## Canada Notes.

### TRADE CONDITIONS.

Retail trade is beginning to feel the stimulus of warm weather and the approaching hymeneal season, and Toronto merchants are doing a good business. Manufacturers are very busy and some establishments are working day and night to overtake orders. Reports from the west and British Columbia are encouraging, dealers being disposed to order freely.

S. C. Wallace, London, Ont., has sold out to W. G. Young.

Lorren Bricker, Preston, Ont., has assigned to H. C. Edgar.

Alfred Marentelle, Belle River, Ont., is moving to Tecumseh, Ont.

H. J. Vinclette has sold out his jewelry business at Magratti, Alba.

Chas. Clarkson, Cypress River, Man., has assigned to D. C. Clarke.

E. L. Weiss' jewelry store, Bancroft, Ont., was destroyed by fire recently.

The assets of W. C. Balcom, Hantsport, N. S., have been sold to A. S. Fillmore.

D. Myles, Haileyburg, Ont., has admitted a partner, and the style is now Myles & Co.

The Western Jewelry & Novelty Co., London, Ont., has been succeeded by W. J. Wray & Co.

Ewart Bros., Rossland and Nelson, have dissolved, each continuing separately, one at Rossland and the other at Nelson.

John L. Laves, Montreal, will be married June 27 at St. Luke's Church, Montreal, to Miss Florence Ogden, of the same place.

R. J. Abbs, traveling representative of the Goldsmiths Stock Co., Toronto, Ont., returned last week from a successful trip of three months to the west and British Columbia.

G. B. Kelsey, representing the Goldsmiths Stock Co., Toronto, Ont., on the eastern route, has returned from a visit to the Maritime Provinces and reports business brisk.

The Barbon-Parker Mfg. Co., incorporated under the laws of Iowa to manufacture and deal in jewelry, etc., has been licensed to do business in Canada with a capital not exceeding \$45,000.

Ambrose Kent & Sons, Ltd., Toronto, Ont., have been given the order for the recognition button of the recently established secret order, the "Sons of Rest," whose headquarters are in Toronto.

Andrew Mackenzie, formerly in the employ of the American Waltham Watch Co., Montreal, but more recently commercial traveler for the Smith Paterson Co., died recently at the Royal Victoria Hospital, Montreal, as the result of a fall.

William Bramley, Montreal, has suffered heavy bereavement in the loss of his mother, Mrs. John Bramley. The deceased was a resident of Montreal for over half a century, and was the widow of the late John Bramley, who was an officer in the Grenadier Guards and came to Canada with the regiment.

R. L. Lighfoot & Co., Bolivar, Tenn., have assigned.

E. Claudel has succeeded to the optical business of E. & L. Claudel, New Orleans, La.

H. A. Forbes & Co., formerly of San Francisco, Cal., are now located at Canton, O.

SEND TO US ANY QUANTITY OF

# AMERICAN PEARLS

WE BUY FOR CASH.

Send by registered mail or express; we will make an offer by return mail. We will also buy any quantity of

## BAROQUE PEARLS (SLUGS).

### BUNDE & UPMAYER CO.,

Mack Block,

MILWAUKEE, WIS.



## The Demand for String Pearls is Enormous

### FASHION DICTATES PEARLS

Our stock is the largest and most complete in America of the finest Fish-Skin Pearls. Prices range from

**30c. to \$25.00 per String**

Selection packages sent on request.

## CHOPARD FRÈRES

MAKERS OF ART JEWELRY NOVELTIES.

49 Maiden Lane

NEW YORK

FACTORY: 35 Rue Des Trois Bornes, PARIS, FRANCE.



**HERMAN KOHLBUSCH, Sr.,**

ESTABLISHED 1859.

Manufacturer of Fine Balances and Weights for every purpose where accuracy is required.

Office and Salesroom, 194 BROADWAY, NEW YORK. Send for Price List.



**"PRACTICAL COURSE IN ADJUSTING."**

PRICE \$2.50.

ALL JOBBERS OR

JEWELERS' CIRCULAR PUBLISHING CO.

**Eliassof Bros. & Co.**

IMPORTERS AND JOBBERS OF

**DIAMONDS WATCHES JEWELRY**

9-11-13 MAIDENLANE, NEW YORK.

100 STATE STREET, ALBANY, N.Y.



A LARGE ASSORTMENT OF DIAMOND MOUNTED JEWELRY CARRIED IN STOCK.

## Pittsburg.

J. J. Lowenstein is manager for the Griffin Jewelry Co., successors to Herman L. Joseph, 260 Fifth Ave.

Charles O'Brien & Co. last week sold to a customer a diamond jeweled gold hand bag for \$1,000. It was a special order.

F. P. Roberts & Sons expect to move into their new store next week, although the building is not yet finished. The fixtures are being installed as rapidly as possible.

A. A. and P. C. Gillespie are now uncles, a sister, Mrs. John Foley, having presented her husband with a daughter, the first child born to any of the Gillespie girls.

Homor J. Lindsay, of the Carnegie Steel Co., is now one of the partners of Charles O'Brien, of Chas. O'Brien & Co. Mr. Lindsay is a member of the staff of Gov. Samuel W. Pennypacker, of Pennsylvania.

Mr. and Mrs. E. H. Kennerdell, of Tarentum and H. H. Weylman, of Kittanning, Pa., were in Pittsburg last week. Messrs. Kennerdell and Weylman are members of the Knights Templar and attended the ball of that lodge at Duquesne Gardens.

H. S. Johnston, Apollo, and family, who some time ago started for San Francisco, but were compelled to leave the train in Illinois on account of several of their children becoming ill, have continued their journey to the coast, but will not go to San Francisco for the present.

The Merchants and Manufacturers Association gave a "Greater Pittsburg Social dinner" at the Annex Hotel last week, the function being attended by some of the local jewelers. On the tour of the association of northwestern Ohio, which begins June 4, Sam F. Sipe will be among the merchants who will accompany the party. Heeren Bros. & Co. will also be represented and possibly the Geo. B. Barrett Co.

The jewelers in the Park building last week petitioned the city authorities to put a stop to the playing of a phonograph in a "nickelodeon" in Fifth Ave., opposite the Park building, which disturbed business, and the police authorities complied with the request; the amusement place is now closed. This city is overrun with these nuisances, especially Fifth Ave., where numerous jewelry stores are located, and they are regarded as a detriment to business.

The Knights Templar conclave resulted in bringing to Pittsburg a large number of out-of-town merchants, and local jewelers decorated their places beautifully for the occasion. Goddard, Hill & Co. was finely decorated with silk flags, while the stores of the John M. Roberts & Son Co., E. P. Roberts & Sons, W. W. Wattles & Sons, West, White & Christy, and numerous other establishments, made lavish displays. Among the out-of-town people in the city were the following: F. W. Koehler, Sharon; John I. Stadtmiller, Indiana; W. H. Bowser, Freeport; T. H. McNary, Washington; Robert W. Brady, Washington; F. B. Theakston, Brownsville; Wm. Hunt, Uniontown; R. V. Marshall, Freeport; H. C. Morrison, wife and daughter, Mt. Pleasant; Mr. and Mrs. E. Priese, Homestead; Walter McKean, Charleroi; John Kennedy, Waynesburg; Harry F.

Frampton, Brownsville; William Hanna, New Castle; Harvey Fritz, Oil City, and Mr. Price, of Price & Landas, Titusville. Most of these dealers bought bills of goods.

## Rochester.

The last of the season's regular meetings of the Rochester Credit Men's Association was held last Thursday evening in the Chamber of Commerce parlors and was largely attended. The programme included a short business session, at which the following delegates were selected to attend the national convention of credit men to be held in Baltimore June 13, 11-15: Philip Present, Daniel B. Murphy, C. S. Bradt, I. A. Wile, J. H. Lempert and Edward Weter. James P. B. Duffy delivered an address on "Credit."

Over 5,000 persons attended the meeting held recently in the City Hall in the interest of the Saturday half-holiday question. The local jewelers are the leading spirits in the movement to close at noon on Saturday during June, July and August, and the other merchants are rallying to their support in large numbers. Among the vice-presidents at the meeting were the following jewelers and opticians: Geo. R. Bauseh, S. D. Burritt, W. W. Bissell, James J. Ernisse, L. Ettinheimer, W. R. Gormly, J. H. Humburch, Henry Oemisch, E. J. Scheer, Rudolph Schmidt, C. E. Sunderlin, J. R. White and C. F. Wolters. A committee was appointed to visit the different stores in the interest of the movement, and on the first day of visiting secured the signatures of 94 firms. It is said that with probably one or two exceptions every jewelry store in the city is willing to close at 1 o'clock Saturday afternoon during the three months stated above.

## North Attleboro.

John E. Tweedy was chosen vice president of the Town Improvement Society last Tuesday.

Frank Kennedy, eastern representative of Payne & Baker Mfg. Co., made a brief visit to the factory last week.

The H. F. Barrows Co., through its treasurer, Harry F. Barrows, has filed its annual corporation report. The figures are: Real estate, \$5,000; machinery, \$29,400; cash and debts receivable, \$128,850; merchandise, \$46,575; capital stock, \$175,000; profit and loss, \$34,925.

Woodbury Melcher and William F. Main-tien have been chosen treasurer and secretary respectively of the Plainville Real Estate Co., which intends to remedy the inconvenience that the jewelers of North Attleboro and Plainville have experienced through lack of dwelling houses for factory employees.

Andrew Wilson, Winfield, Kans., has been confined to his home during the past week by a serious illness.

S. S. Brenner, Portland, Ind., who was recently accused of selling liquor without a license or prescription, on Tuesday of last week, was tried in the Circuit Court and acquitted.

## Attleboro.

An addition is being made to the factory of Freeman, Daugherty & Co., Chertley.

Stephen A. Snow has returned to the home office of Reed & Barton, Taunton silversmiths, after a tour over the New England circuit.

Charles E. Bliss, who recently retired from the Bliss Bros. Co., has announced his candidacy for the next election to the lower branch of the Legislature.

James E. Blake, of the James E. Blake Co., has received an invitation to the launching, Tuesday, at Bristol, R. I., of a yacht to compete for King Edward's cup.

Reginald D. Fogg, salesman for the Watson & Newell Co., who, on his last trip to New York, in the Winter, caught spotted fever, continues critically ill. He has long periods of unconsciousness and is almost helpless. The case attracts wide attention, and much sympathy is expressed for the sufferer.

A long-standing dispute has been settled between the town and the Jas. E. Blake Co. The town in some highway work recently built a high masonry wall by mistake several feet upon the company's land, just where it blocked a move to erect a new factory soon to go up. After legal proceedings had been instituted the town saw its error and has arranged to make amends.

The Attleboro Co-operative Bank last week elected to office as directors Hon. Sidney O. Bigney, of S. O. Bigney & Co.; Fred L. Torrey, David E. Makepeace, of the D. E. Makepeace Co.; Thomas S. Carpenter, of the Horton-Angell Co.; Frank H. Sadler, of F. H. Sadler Co.; Charles P. Keeler, of McRae & Keeler, and Edward A. Sweeney, of the W. H. Wilmarth Co.

Frank A. Chace, Chicago representative of the C. M. Robbins Co., returned to Attleboro, last week, to attend the funeral of his brother, Edmund C. Chace, who was drowned in the Harlem River, New York. The deceased was a Newark (N. J.) working jeweler. F. A. Chace left early this week for a month's trip on the eastern circuit, and will then resume charge at Chicago.

S. O. Bigney & Co., last week, accepted plans for a new three-story factory to stand on the corner of Wall and County Sts. It will be shaped like the letter L. The long section will run parallel to the present Bigney shop, and the short section, at right angles in the rear, will join the rear of the Bigney plant. The front of the present Bigney plant will then be built out toward the front of the new section, so that a rectangular court will be formed inside. The new structure will be 85 feet along County St., 200 feet on Wall St., of wood, and three stories high. Applications are reported already in hand from Providence jewelry concerns desiring quarters. On the present Bigney shop an extension has been completed to give added room to one tenant, the Electric Chain Co., and another L for S. O. Bigney & Co. to use as a plating room.

Rose & Evans, Telluride, Colo., who recently formed a partnership, have dissolved. The business will be continued as hitherto by Charles E. Rose.

# DOMESTIC versus FOREIGN CUTTING

## IMPORTANT TO MANUFACTURERS

FROM  
M-M  
S-F-S

TO  
M  
M  
A  
R  
K  
E  
T

American and Egyptian Peridots and other Precious Stones are being cut by us to Special Shapes and Sizes.

They are much superior to imported goods in cut and accuracy of size.

Manufacturers should bear in mind that there is no waste where every stone is a gem.

We carry every Precious Stone but the Diamond.

## AMERICAN GEM AND PEARL CO.

14 & 16 CHURCH ST., NEW YORK.

LONDON—16 Holborn Viaduct

PARIS—39 Rue de Chateaudun

# The Comb House

We manufacture a complete line of

## FINE MOUNTED COMBS

in 14 K., 10 K., Sterling Gilt and Gold Filled.

Also all kinds of PLAIN, REAL and IMITATION TORTOISE SHELL COMBS.

## Wagner Manufacturing Co.

41 Union Square,

New York. Factory, Lorimer St. and Throop Ave., B'klyn, N. Y.

Repair Work a Specialty.



## DATTELBAUM & FRIEDMAN,

Makers of Gold Rings of All Descriptions.

45 John Street, New York.

Our Trade-Mark "D. F." in all our Rings is the guarantee of quality. Send for Catalogue.

# "Practical Course in Adjusting."

Price \$2.50.

ALL JOBBERS, OR JEWELERS' CIRCULAR PUBLISHING CO.

## Diamond Mining in South Africa.

THE report of the Premier Diamond Mining Co. for 1905 showed 1,388,071 loads handled, giving 845,652 carats, or an average per load of 0.609. The average value per carat was 23s. 6.29d., though no doubt if the Cullinan diamond realized a price per carat commensurate with its size, this figure would be largely increased. The cost per load was 3s. 3.418d.

The market for Premier stones improved during the year. At all recent meetings of diamond companies it seems to be agreed that the price of diamonds has improved. The improved demand, however, seems only to be for larger stones, as it was stated at a recent meeting of the Pieser Diamond Co. that "of late there had been a great fall in the price of inferior diamonds, the price having gone down to 2s. and 2s. 6d. per carat." In the case of the Premier Co. 85 per cent. of the value is obtained from stones averaging £3 a carat, and 15 per cent. from stones averaging 9s.

In the working of the mine, it appears that the labor supply has been short of requirements. An attempt is to be made to overcome this difficulty by the use of steam shovels and machine drills, which, it is hoped, will also reduce the losses by theft. It has been found that the grease tables, even after second treatment, fail to extract all the stones.

Attempts have been made to curtail the power of the company as a competitor in the diamond market, not only by the original diamond law under which the State takes 60 per cent. of the profits, but also by exercising a direct control upon its expenditure.—*Engineering and Mining Journal.*

## King Alfonso to Give Princess Ena a Diamond Studded Crown.

A SPECIAL cable dispatch to the New York *Sun* from Madrid, May 15, stated that King Alfonso's wedding gift to Princess Ena consists of jewels valued at half a million dollars. They comprise a golden crown studded with diamonds, a diamond diadem, a diamond necklace, a pearl necklace, a golden bracelet studded with diamonds, brooches and earrings.

## Death of James D. Lincoln.

NORTH ATTLEBORO, Mass., May 28.—James Danielson Lincoln, one of the pioneer jewelry manufacturers of Plainville, died suddenly Saturday from diabetes at Pasadena, Cal. He is survived by a stepson, Woodbury Melcher, of this town. Mr. Lincoln's property, it is said, will be left to his stepson.

According to an often-expressed wish of Mr. Lincoln, the body will be cremated and the ashes be interred by the side of his wife at Laconia, N. H. In 1903 Mr. Lincoln presented a memorial library to his native town of Erimfield.

Mr. Melcher has left for California to take charge of the remains.

The store of L. F. Monillesseaux, Mahanoy City, Pa., was closed last week by the sheriff.

**News Gleanings.**

S. Bernstein has moved from Omaha, Nebr., to Memphis, Tenn.  
 H. Engels has purchased the store of J. H. LeRoy, Fairbury, Nebr.  
 The store of W. R. H. Wells, Abbeville, Ala., was recently destroyed by fire.  
 I. A. Pinto, West End, Duluth, Minn., has returned from a short visit to Maryland.

B. W. Carter recently reopened his watch and jewelry repairing shop in Butler, Ga.  
 The dissolution is reported of the jewelry firm of McKinney & Rhea, McKinney, Tex.  
 Frank G. Stedman has put in new fixtures in his jewelry store in New Windsor, Colo.  
 Ernest Homer, Dayton, Ia., is seeking a location at which to engage in the jewelry business.

Mr. Vincent is making extensive improvements in his retail jewelry store at Long Beach, Wash.  
 H. E. Childs, Clyde, N. Y., has remodelled the interior of his store and put in new show and wall cases.  
 A. F. Cummings, Holyoke, Mass., has moved from 121 Lyman St., into larger quarters at 166 High St.  
 R. A. Heggie, Ithaca, N. Y., is in New York attending the session of the Court of Deliberation of the Scottish Rite, at the Masonic Temple.

W. W. Howe, a retail jeweler of Clearfield, Pa., is a partner in the firm which is establishing a pleasure resort in the vicinity of that town.  
 Mr. Tice, of Tice & Benson, Auburn, N. Y., who was recently successfully operated upon for appendicitis, is now able to attend to business again.  
 Geo. E. Holmes, for some years in the jewelry business at Clifton Springs, N. Y., and later at Lock Haven, Pa., is now practicing as optician at Newark, N. Y.  
 Thomas F. J. Murphy, Callicoon Depot, N. Y., has filed a petition in bankruptcy. His liabilities are \$12,000; assets, \$6,700. Wm. A. Law has been appointed receiver for the concern.

The annual convention of the newly formed Wisconsin Retail Jewelers' Association, will be held June 27-28, in Milwaukee, Wis., with headquarters in the Hotel Blatz.  
 The Burke & Sweeney sapphire mines, near Yogo, Mont., have been sold to the American Sapphire Co., a New York corporation which will operate and develop them.  
 Frederick Boenstadt, Cheyenne, Wyo., was robbed recently of about \$200 worth of jewelry. Two men were subsequently taken into custody, but no booty was found on them.  
 The \$5,000 silver service for the battleship *Washington*, to be presented by the State of Washington, will be ordered at once through Schacht & Riorden, Spokane, Wash.

Archie Tegtmeyer, Milwaukee, Wis., recently filed a bond amounting to \$5,000, guaranteeing costs in a suit brought in the Circuit Court of the State against him by his landlord, who, it is alleged, is trying to have Mr. Tegtmeyer vacate the store at Grove St. and National Ave.  
 Welsh & Bro. Co., Baltimore, Md., have

moved from 323 N. Charles St. to the Professional building, 330 N. Charles St. The new quarters are 100 feet long and 20 feet wide, the interior furnishings being exceptionally attractive. There are also two large show windows, one on Charles St. and the other on Mulberry St.

On Wednesday, May 16, an electric car with an unusually long pole passed through the village of Watkins, N. Y. This pushed the live trolley wire against a telephone wire, and 368 telephones in the village were burned out. Among them was that in the jewelry store of A. A. Cowing, where a fire was started and light damage done.

An unknown man recently stole a candelabra from a wall case in the store of W. A. Kirkham, Leavenworth, Kans., and after taking it, returned for another article, when he was pounced upon by one of the clerks, but managed to escape. A waiter, who gave his name as Ross, was subsequently arrested and accused of the crime.

Powell Penn was recently sentenced to six months imprisonment in jail in Danville, Va., on a charge of larceny preferred against him by W. P. Grishaw, a local jeweler. Several watches found in the possession of the negro had been identified by Mr. Grishaw as his property. The negro, in his defense, claimed to have secured the timepieces from another colored man.

The Elgin Jewelry Co., Elgin, Ill., is the plaintiff in a suit to recover \$200 and interest from A. Bolinski, Mahanoy Plane, Pa. The concern claims to have billed goods amounting to \$200 to the defendant, and alleges that the latter agreed to pay \$50 on each of four payments. The defendant avers that the concern did not live up to its representations, and that he did not make a contract for the goods.

Thieves who recently broke into the store of O. E. Graves, Cementon, Pa., stole about \$200 worth of general merchandise, including a large amount of jewelry. A burglar alarm failed to operate, leaving the intruders free to plunder without being discovered. After leaving the store of Mr. Graves, the thieves went to the establishment of Geo. T. Rockel, where they made an unsuccessful attempt to enter. The burglar alarm here sounded and frightened away the thieves before they gained access to the stock.

**Jewelers' Gold Bars Withdrawn and Exchanged at New York.**

*Week Ended May 26, 1906.*  
 The U. S. Assay Office reports:  
 Gold bars exchanged for gold coin...\$394,611.93  
 Gold bars paid depositors..... 61,556.72

Total .....	\$456,168.65
Of this the gold bars exchanged for gold coin are reported as follows:	
May 21.....	\$25,622.04
" 22.....	102,957.37
" 23.....	55,527.34
" 24.....	137,809.14
" 25.....	62,294.16
" 26.....	10,401.88
Total .....	\$394,611.93

Chas. M. Levy, 90 William St., New York, is making a number of intricate tools of modern construction for the manufacture of a new line of signet rings and lockets, which will continue to be his specialty. The new tools and new machinery will save much labor and time in manufacturing it is promised.

**Optical Notes and Briefs.**

(Also see page 92.)

W. A. Stevens, of the Bay State Optical Co., Chicago, was a visitor in Omaha, Nebr., during the past week.

J. C. Grasborg, formerly of South Omaha, Nebr., has taken a position in the optical department of Hayden Bros.' store, Omaha, Nebr.

Hirsch & Kaiser, formerly on Kearny St., San Francisco, Cal., but now located temporarily at 1757 Fillmore St., have their factory under way, and as they saved all their prescriptions, they are already attending to their customers.

The Berteling Optical Co., of which Harry Nordman is manager, has opened at 2505 Clay St., near Fillmore St., San Francisco, Cal. Mr. Nordman reports that he saved all his records and has some stock on hand with which to begin business.

Henry Kahn & Co., proprietors of the Ocularium, now located at 2253 Fillmore St., San Francisco, Cal., reports that all their books and records were burned and they are now asking their clients to call to have their glasses recorded.

J. R. Jenkel, optician, formerly located at 817 Market St., San Francisco, Cal., has selected a location for temporary purposes on Van Ness Ave. This firm has cast its lot with a number of retailers in various lines, who have agreed to group themselves together in temporary locations along Van Ness Ave.

The Erker Bros'. Optical Co., St. Louis, Mo., has secured a 99-year lease of the property at 705 Washington Ave. It is expected that the concern will move from the present location, 608 Olive St., at the expiration of the present lease. The property on Washington Ave. has a frontage of 22 feet six inches and a depth of 150 feet.

Miss E. L. E. Waltz has been placed in charge of the J. N. Adam Co. optical department in its department store at Buffalo, N. Y. For two years Miss Waltz had charge of the optical work in the Buffalo store of Philip Fischer, who recently went into bankruptcy. She succeeds Dr. Bemis, recently resigned, and she is the only practicing woman optician in the city of Buffalo.

The California Optical Co., San Francisco, Cal., whose handsome four-story factory and store at 205 Kearny St. was one of the finest in the west before its destruction on the night of April 18, has resumed business in fairly commodious quarters on Fillmore St. Here suitable dark rooms have been fitted up and the sales room is being put in shape. Factory and stock rooms have been secured in the rear and the first wheels in the new factory began to turn May 14. This company saved all its prescriptions and will be in shape for active business in a very few days. The company is prepared to stay in its present quarters for two years, but will move down town, running the present place as a branch, when the time seems ripe. Manager Fennimore, of the company, states that a lens drill and a lens cutter were the only machines saved. These had been discarded and were stored away in a place where they escaped the fiercest of the fire as well as falling walls and beams.

The stock of S. H. Abbott, McKinney, Tex., was slightly damaged by water and smoke during a recent fire at that place.

# GORHAM POLISH

¶ The Gorham Mfg. Co. take this opportunity of impressing upon the retail Jewelry Trade the advantages arising from an ample provision of Gorham Silver Polish and Powder.

¶ The prepossessing form of the packages in which these preparations are put up serves in itself to render them an attractive feature of the silverware counter, suggesting to customers the expediency of availing themselves of the most highly approved means of keeping their household silver in immaculate condition.

## GORHAM M'F'G CO.



CHICAGO,  
137 Wabash Ave.

Silversmiths and Goldsmiths

Fifth Avenue and 36th Street, New York.

BRANCHES:

NEW YORK,  
23 Maiden Lane.

SAN FRANCISCO,  
120 Sutter St.



LONDON,  
Ely Place.

WORKS: Providence and New York.

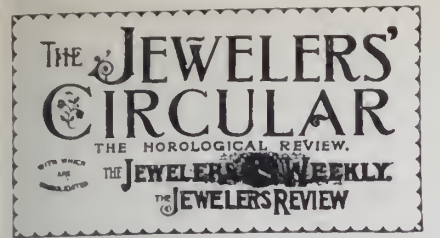

PUBLISHED EVERY WEDNESDAY BY  
**THE JEWELERS' CIRCULAR PUB'G CO.,**  
 11 JOHN ST. COR. BROADWAY, NEW YORK.  
 TELEPHONE: 1146 CORTLANDT. CABLE ADDRESS: JEWELAR NEW YORK.

VOL. III. MAY 30, 1906. No. 17

Subscription in U. S., Canada and Mexico, \$2.00  
 Other Countries in Postal Union, \$5.00  
 Single Copies, .10

Remit by check or money order. Remittances in money are at sender's risk.

Notices of changes in standing advertisements must be received one week in advance; new matter can be received up to Monday.

No attention paid to communications unless accompanied by full name and address of the writer. This is asked not necessarily for publication, but as an evidence of good faith.

**Index to Special Articles.**

Cup Presented by Miss Morosini. Illustrated on front cover; text on page.....	34
Gift of Silverware to Montreal's ex-Mayor...	35
One Way Bogus Antiques Were Distributed...	33
Additional Census Statistics as to Jewelry Trade in Rhode Island.....	35
Exports of Jewelry, Clocks, etc., from New York.....	35
Ornamented Imitations of Rock Crystal Durable at 45 Per Cent.....	37
London Letter.....	37
Jewelry and Kindred Lines Shipped to American Possessions.....	37
Recent Customs Decisions on Jewelry, Gems, etc.....	37
Last Honors Paid to Louis J. Lamb.....	39
Call Issued for Retail Jewelers to Organize in 26 States.....	39
Suit to Forfeit Jewelry Alleged to Have Been Smuggled.....	39
Imports at New York.....	39
O. H. Fasoldt Files Bankruptcy Petition.....	39
Bids to Supply Clocks for United States Public Buildings.....	39
Decision on Reconstructed Rubies Will Not Be Appealed From.....	41
Injunction Issued in Suit of Robinson vs. Gorham Mfg. Co.....	41
Alabama Optical Society Hold First Annual Meeting.....	43
Missouri Opticians Organize State Society.....	43
Arkansas Optical Society Organized at Little Rock.....	43
Patent Department.....	73
The Making of Clock Cords.....	76
Some Experiments Recently Made With a Seconds Pendulum.....	79
Another Historical Clock.....	79
Is the Time Ripe for a Recognized College of Optometry?.....	85
The Health Ray Lenses.....	89
A Group of Opticians and Their Friends Who Attended the 12th Annual Convention of the New England Association of Opticians.....	89
Another Advocate of an American Academy of Optometry.....	90
Some Attractive Exhibits Seen at the Convention of the New England Association of Opticians.....	91
A Technical Window Display.....	94
Cheerfulness in Business.....	95
A New Filtering Apparatus.....	97
A New Solder.....	97
An Exhibit of Pottery, Glass, Silver, Pewter, etc., of the Georgian Era.....	99
Customs Decision on Statory, Glass Ware, Earthen Ware and Kindred Lines.....	99
Recent Tariff Changes by Foreign Countries.....	101
Arabia's ancient Turquoise Mines.....	101
Mining for Rubies in Burmah.....	101

**Continued Increase in Precious Stone Importations.** THE figures given out as to the importations at the port of New York of precious stones and pearls indicate that the total for the fiscal year ending June 30, 1906, will be greater than for any preceding fiscal year since the records of the port have been kept. The total for the year ending June 30, 1905, was \$33,223,164.59, the greatest up to that time. For 10 months of the current fiscal year ending April 30 the total is \$32,308,239.51. The figures of May and June, when added, will certainly send this year's aggregate above last year. May and June in last year were months of heavy importation, the total of the two months being upward of \$6,000,000. As the May figures, which will be made public this week exceed those of last year and those of June cannot fall much below those of the corresponding month of 1905, this year will go far ahead of its predecessor.

The last calendar year exceeded the records of the last fiscal year, the total for the 12 months ended Dec. 31 last year being \$37,146,337.35. It is not impossible, judging from the figures on hand, that the fiscal year now drawing to its close, may in turn exceed the calendar year which has the record so far.

The preponderance in the gains in the last calendar year was in cut stones and pearls, which are classified together, and the gain in these classes has continued. The importation of cut stones and pearls in the 10 months ending with April amounted to \$23,589,763.03. This was greater than the total for the last fiscal year (\$22,942,522.36.)

In the present fiscal year the totals for every month up to this time, with the exception of November and January, has exceeded the totals for the corresponding months in the preceding fiscal year.

Present indications are that the total importation of rough stones, which are mostly diamonds, will not differ greatly in value from that of the last fiscal year, when the figures stood \$10,280,642.23. In the last calendar year the importation of rough stones amounted to \$10,146,451.04.

The following table shows the importations for each of the 10 months of the current fiscal year:

Month.	Cut stones and pearls.	Uncut stones.	Total.
1905.			
July.....	\$3,149,735	\$843,096	\$3,992,831
August.....	1,815,718	460,154	2,275,873
September.....	2,240,987	1,009,892	3,250,879
October.....	2,409,144	1,100,245	3,509,390
November.....	1,695,378	771,714	2,467,093
December.....	2,846,373	787,005	3,633,379
1906.			
January.....	2,023,269	683,727	2,706,997
February.....	1,999,475	1,067,569	3,067,036
March.....	2,726,970	1,062,854	3,789,825
April.....	2,682,707	932,224	3,614,932
Total, 10 mths.	\$23,589,763	\$8,718,476	\$32,308,239

**National Stamping Bill's Great Progress.** THE news published in the last issue of THE CIRCULAR—WEEKLY to the effect that the Senate of the United States had just passed the Jewelry Trade's Gold and Silver Stamping law introduced by Congressman Vreeland caused deep satisfaction to manufacturing, jobbing and retail members of the trade throughout the country, who have earnestly and ardently favored the measure since the time that the

bill was outlined by this journal. The news which was received just as THE CIRCULAR—WEEKLY went to press, was unexpected, as even the most ardent and enthusiastic supporters of the measure did not believe that it could attain the approval of the upper house of Congress so quickly, but its passage shows not only that the Senators of many States had heard from their constituents on the subject, but also that a measure such as this, which seeks only to protect the trade and public from dishonesty and works no injury to the legitimate manufacturer, is properly deemed important enough for our highest legislative body to give it consideration at the first opportune moment—which was directly after the Rate Bill had been passed.

Fortunately for the jewelry trade the Senators from three States with great jewelry manufacturing centers—Rhode Island, Massachusetts and New Jersey, had been well informed by their constituents in the silver and gold trades and saw to it that the other Senators were made aware of the importance of the legislation proposed, and the great victory of the bill in the Senate is due almost as much to the work of Senators Aldrich, Crane and Kane as was the victory in the House due to the whole-hearted and strenuous work of Congressman Vreeland.

A gratifying feature of the action of Congress on the bill so far lies in the fact that the measure as passed by the House was practically the same, in all details, as it was when introduced after being approved by the retail trade and the joint committee of the manufacturers of New England, New York and New Jersey. Outside of a few changes in phraseology which strengthened the text of the bill, the only amendments made by the Senate were those which decreased the penalty for a violation of the act from a fine of \$1,000 and six months' imprisonment to a fine of \$500 and three months' imprisonment, and extended the time in which the act shall take effect from six months to one year after the date of its passage. Although many members of the trade would like to see the bill go into effect in exactly the form in which it passed the House, it is safe to say that few supporters of the measure can be found who would not rather have the House concur in the Senate amendments than run the risk of delay in having the bill go into effect.

While the position of the President on the measure has never been officially stated, there seems to be little doubt in the jewelry trade and among the bill's supporters in Congress that an act such as this, which simply promotes honesty and protects the public, will surely get his approval.

The William A. Rogers (Ltd.) management has refused to recognize the silver-workers' union which has been formed in Oneida, N. Y., and Thursday practically all the company's employes quit work. The trouble started about three weeks ago, when some of the union men left their benches. The company induced some of the employes to return to work, but it is claimed the most prominent union men were given notice to quit. Since then the relations between the company and the employes have been strained, and Thursday all the help, numbering about 100, left the shop, and the plant was shut down.

# FIRST HANDS



## CROSS & BEGUELIN

Importers and Cutters of Diamonds and Precious Stones

43 Rue de Meslay, PARIS

Telephone,  
2188 Cortlandt

17 Maiden Lane, NEW YORK

Why not set  
your diamonds  
in the mounting  
that displays  
them best?

Send for samples.

Arch Crown Mfg. Co 26 Camp Street  
Newark, N. J.

### Last Week's New York Arrivals

THE CIRCULAR-WEEKLY each day posts in its office a Bulletin of the latest buyers visiting New York, which every member of the trade is cordially invited to copy.

- ANNISTON, ALA., A. C. Thomas, St. Denis.  
AUGUSTA, GA., L. J. Schaul, Marlboro.  
BOSTON, MASS., C. A. Gilchrist (C. A. Gilchrist & Co.), Murray Hill.  
BRIDGEPORT, CONN., F. E. Blake (Smith, Murray & Co.), Murray Hill.  
J. C. Mizer (Howland Dry Goods Co.), 7 Spring St.  
CHICAGO, J. Floersheim (J. Floersheim Co. Woodstock).  
R. N. Kettle, Prince George.  
Miss A. Muleahey (Boston Store), Wellington.  
DETROIT, MICH., W. A. Sturgeon (W. A. Sturgeon & Co.), Holland.  
FORT PLAIN, N. Y., A. Dunn (A. Dunn Sons), Astor House.  
A. G. Dunn (A. Dunn & Sons), Astor House.  
LYNCHBURG, PA., E. W. Buckingham (Buckingham & Flippin), Grand Union.  
MERIDEN, CONN., J. J. Kelleen (A. S. Thomas Normandie).  
NEW HAVEN, CONN., Miss Pettee (Howe Stetson Co.), 75 Spring St.  
SAN FRANCISCO, CAL., I. S. Jehlinger (The Emporium), Grenoble.  
SYRACUSE, N. Y., J. B. Murphy (Dey Bros. Co.), Victoria.  
TOLEDO, O., Miss M. L. James (Lion Dry Goods Co.), 214 Church St.  
TROY, N. Y., J. W. Podmore, Astor House.  
WAUKESHA, WIS., E. R. Estberg (Estberg Sons), Imperial.  
WHITE RIVER JUNCTION, VT., C. C. Bogle (Bogle Bros.), Broadway Central.

### Columbus, O.

J. C. Goodman, of Goodman Bros., left Saturday for a week's outing at Atlantic City.

Mr. Burt, of E. Burt & Son, Cardington, O.; B. F. Sikes, Galena, and Paul Johnson, of the Peerless Optical Co., Chicago were visitors here last week.

Milton Daniels, who for years has occupied a room in the Bornheim building Cleveland Ave. and Long St., has removed into a new building on the opposite side of Long St.

B. H. Davidson, Waverly, and R. Davidson, Murray, have purchased the store J. H. O'Daniel, on the viaduct. M. O'Daniel says he will probably go to San Francisco. The firm name will be Davidson Bros.

J. L. Sievert, who in October launched "The Sievert Jewelry & Optical Co.," 11 S. High St., has gone out of business and is now in Chicago. His optical business he sold to Miss Helene Campbell, who will conduct it for the present under the name "The Sievert Optical Co."

The Hofman Jewelry Co. received a telegram Thursday from R. N. Whitford, general manager, saying he had procured for the firm a rich gem claim near San Diego, Cal. Mr. Hofman became interested in the semi-precious stones while visiting in California, and sent for Mr. Whitford for consultation.

J. F. Bruns, Greenville, S. C., last week had on display in his show window the medals supplied by him to be awarded prizes to local students during commencement week.



## New York Notes.

The offices of Herpers Bros., 41 Maiden Lane, have been enlarged and the firm now offers increased facilities to visitors from out-of-town.

Jacob Strauss, of Jacob Strauss & Sons, 4 Maiden Lane, returned on the 15th inst., on the *Kaiser Wilhelm II.* from a purchasing trip in Europe.

J. H. Venon, importer of china, 43 W. 4th St., will sail for Europe to-morrow on *La Provence*, to visit the china factories of France, Russia and Sweden.

Joseph G. Brenaner, formerly of Poughkeepsie, and more recently with Leboldt & Co., recently assumed the position of manager of the Norman Selby Co., 1503 Broadway.

Next Tuesday at 11.30 A. M., creditors of Schaeferling Bros. & Co., formerly Manufacturers at 28 E. 22nd St., will hold their first meeting in the office of Referee F. K. Pendleton, 25 Broad St.

The building formerly occupied by Tiffany & Co., at Union Sq. and 15th St., which is being remodeled for wholesale commercial purposes, was, last week, leased for 10 years, at an aggregate rental of \$300,000.

A certificate incorporating M. Tecla & Co., of Croton-on-Hudson, was filed last week. The company conducts a store at 29 Broadway. The capital is \$40,000, and the directors are: Charles Etlinger, Cleveland; F. J. Goldsoll, A. M. Lynch, New York.

Siegel, Rothschild & Co., 418 Baltimore St., Baltimore, have recently engaged Mrs. E. Lipmanson, formerly with James Stokely & Co., Philadelphia, who will represent them in eastern Ohio, Illinois and Michigan. S. Solomon will represent the Baltimore house in Texas, Louisiana and Oklahoma. D. A. Weinberg, of the same company, will sail for Europe on the *Barbarosa* about June 16.

June 18 to 21 are the days on which the National Association of Stationers and Manufacturers will hold their convention in New York. The Hotel Astor has been designated as the headquarters. Committees have been for some time making arrangements for the entertainment of visitors. There will be an evening at the Hippodrome, trips to Coney Island and up the Hudson and a banquet.

Cards have been sent out to the trade announcing that the business heretofore conducted under the style of Wm. B. Kerr & Co., Inc., will be continued by the re-organized company of the Wm. B. Kerr Co., with a general office and factory at 144 Orange St., Newark, N. J., and sales office at 320 5th Ave., New York. The company's distinctive line of silverware will be produced as heretofore.

Two young brothers, giving their names as Jack and George Hayes, who were arrested at 18 W. 22nd St., on suspicion of stealing a quantity of silverware with which they had been calling on the pawnshops, claimed that the articles had been bought by them from the Reed & Barton Co. Nothing was known as to the youths at the company's store in this city. The brothers were detained, pending an investigation.

Members in the trade are invited by J. H. Buck, the curator of metal work at the

Metropolitan Museum of Art to consult him at any time in relation to art topics associated with his work. He remains at the museum during full business hours every day and says that he is always glad to see those in the trade who are in need of his services. Mr. Buck's services have been loaned for three days from June 1 to 3 to the Boston Museum of Art.

Fifty cents was the amount realized on the few dilapidated watches and articles of jewelry left for repair with the Richter Watch & Jewelry Co., formerly of 444 Third Ave., at the sale conducted last Thursday by John J. Hayden, Trustee in Bankruptcy, at his office, 258 Broadway. This makes \$48.50 which has come into the Trustee's hand to meet the total liability of \$7,647. The case is one of those on which even the lawyers do not get their fees and the creditors get nothing.

In the Children's Court, last Wednesday, Jacob Meyrowitz, an office boy, was convicted of stabbing Miss Bella Hecht, the stenographer, in the office of Meyrowitz Bros., 37 Maiden Lane, where both were employed. The stabbing was to cover up a number of petty thefts, as his confession published in the last issue of the CIRCULAR WEEKLY explained. A suggestion has been made to the Federal authorities to deport young Meyrowitz to Russia, whence he came a year ago, and this suggestion may be followed.

A certificate was filed at Albany last Saturday incorporating the business of Chester Billings & Son, diamond importers. The new corporation, which will continue under the old name, will take over both the wholesale business at 58 Nassau St. and the retail store at 353 Fifth Ave., which have heretofore been conducted by the firm. There is no change in financial interest as practically all the stock will be held by the three directors, H. B. Billings and A. H. Kirkpatrick, both of New York, who have heretofore been active in the business, and by P. S. Ross, Newark, N. J., who continues his financial interest. The amount of capital stock has been placed at \$600,000.

On a motion that Abraham Goldberg, formerly of 132 Ridge St., be required to turn over property to the value of \$10,000 to his trustee in bankruptcy, testimony was heard last Thursday before Referee Wm. Allen. The bankrupt was questioned in relation to his transfer of a parcel of Brooklyn real estate to his brother-in-law on the occasion of the latter's marriage, some time before the failure. Efforts were made by Mervyn MacKenzie, of Hastings & Gleason, representing the trustees, to show that this transfer was not completed until a period just before the failure and was, therefore, contrary to the statute. Leonard Bronner, appearing for the bankrupt, denied that anything has been done that was illegal or improper. The case was adjourned to Friday of this week.

Stern Bros. & Co., finding that the facilities of their jewelry factory, 33 Gold St., New York, are inadequate for the growing business, recently leased the top floor of 82 Fulton St., forming an "L" with one of the floors of the present factory. A door was cut through so that the new quarters are conveniently joined to the existing works. New machinery is now being installed and in a few days will be in opera-

tion. The additional room comprises 5,000 square feet, giving the company a third more space than it now has. The company has been obliged to keep its factory in operation overtime, and even this did not have the desired effect. The Fulton St. addition to the three floors already occupied on Gold St. will enable the company to increase the output to the degree desired.

Ten handsome pieces of coral brought from various parts of the world were recently donated to the Museum of Natural History, of New York, by Borrelli & Vitelli, 401 Broadway. These specimens supplement the collection which the museum had on hand. With the additions, the exhibit at the museum is now regarded as quite comprehensive. Following is a list of the pieces donated by Borelli & Vitelli, showing the color and origin of each: one piece, white, from Mediterranean, coast of Africa; white, from Japan, near Kobe; ox blood, from Japan, near Tokio, Sagami Sea; pink, from Sardinia Island; pink, from Sicacca, Sicilian Sea; rose color, Spanish, Canary Islands; rose color, Messina, Sicilian Sea; rose color, Spanish coast, Mediterranean; rose color, Fagnana, Sicilian Sea; rose color, Seilla, Calabrian Sea.

Testimony was heard last Thursday in the bankruptcy case of Edwin C. Heathcote, formerly of 13 Maiden Lane. Mervyn MacKenzie, of Hastings & Gleason, appeared for the trustee in bankruptcy. Mr. Heathcote and his wife were closely questioned in relation to the loss of the books and stock valued at \$10,000 in a Brooklyn Bridge car, an occurrence which had been given by the jeweler as the cause of his failure. The particulars, as reported at the time by Mr. Heathcote, were published in THE CIRCULAR WEEKLY of Feb. 21 and 28. On the stand Mr. Heathcote went over the details substantially as told before. He said that when he released his grasp on the heavy package of books and jewelry he had the impression that his wife was taking hold. He said that he was the last person going out by the middle door of the car, while his wife was the last person going out of the door at one end. Neither of them saw the package leave the car, or saw anybody take it. Mr. Heathcote explained about the disturbance in the car and his anxiety to protect his wife from harm, leading him to release the package in shielding her. The examination was adjourned until next Tuesday. Mr. Heathcote's stock and fixtures were sold at auction last Thursday, just before the hearing in his case, by John J. Hayden, the trustee. Six or eight bidders were present at the trustee's office, 258 Broadway. The property went to the highest bidder, Frank Walker, representing the Brooklyn Purchasing Syndicate, for \$1,247.

William F. Boettcher, manager of the jewelry store at 85 Myrtle Ave., Brooklyn, last week filed a petition in bankruptcy in the United States District Court in that borough for the purpose of obtaining a release from liabilities incurred upward of 15 years ago. At that time, finding himself unable to meet his obligations, he gave a chattel mortgage to his father, the late Fred Boettcher. A number of creditors took

IN THE HEART OF THE JEWELRY DISTRICT.

# Guardian Trust Company,

170 BROADWAY, COR. MAIDEN LANE, NEW YORK.

Capital and Surplus - Over \$1,000,000

Equitable rates of interest allowed on surplus funds.

Collections on out-of-town items handled on reciprocal basis.

FRANK W. WOOLWORTH, President.  
 GEORGE W. FAIRCHILD, Vice-President.  
 CHARLES L. ROBINSON, Vice-President.

LATHROP C. HAYNES, Secretary.  
 ALFRED M. BARRETT, Asst. Sec'y.

Prominent Jewelers  
 Among our Directors } LUDWIG NISSEN.  
 A. K. SLOAN.  
 LEOPOLD STERN.

# THE ORIENTAL BANK.

ESTABLISHED 1853.

182 and 184 Broadway, <sup>Corner</sup> JOHN STREET, NEW YORK.

Capital, - - - \$750,000.00.

Surplus and Profits, 1,100,000.00.

**ACCOUNTS FROM THE JEWELRY TRADE ARE SOLICITED.**

R. W. JONES, Jr., President.  
 NELSON G. AYRES, First Vice-President.  
 GEO. W. ADAMS, Cashier

LUDWIG NISSEN,  
 ERSKINE HEWITT, } Vice-Presidents.  
 CHARLES J. DAY, }

R. B. ESTERBROOK, Assistant Cashier.

# The Market and Fulton National Bank of New York.

ORGANIZED 1852.

31-83 FULTON STREET.

Capital, \$1,000,000.

Surplus, \$1,335,000.

ALEXANDER GILBERT, President.  
 R. A. PARKER - - Vice-President.  
 T. J. STEVENS, - - - Cashier.  
 JOHN H. CARR, - Asst. Cashier.

**Invites the Accounts of Jewelers.**

Will extend every facility that good banking will justify.

**SAFE DEPOSIT VAULTS.**

# The Chatham National Bank

Broadway and John Street, New York

H. P. DOREMUS, Cashier

GEORGE M. HARD, President

W. H. STRAWN, Ass't Cashier

# THE STATE BANK

376-378 GRAND STREET, NEW YORK

Capital and Earned Surplus, over \$1,100,000. Deposits over Fourteen Million.

Offers a favorable market for short and long time jewelry and diamond paper

# *The Mercantile National Bank of the City of New York*

*Cordially invites Accounts  
from Good Merchants  
in the Jewelry Trade.*

**CONVENIENT LOCATION,  
AMPLE CAPITAL,  
LARGE SURPLUS,  
LONG EXPERIENCE.**

**FREDERICK B. SCHENCK, President.**

**MILES M. O'BRIEN, }  
WILLIAM H. TAYLOR, } Vice  
  } Presidents.**

**JAMES U. LOTT, Cashier,  
EMIL KLEIN, Asst. Cashier,  
ALFRED W. DAY, Asst. Cashier.**

<b>Capital,</b>	.	.	.	<b>\$3,000,000</b>
<b>Surplus,</b>	.	.	.	<b>\$3,000,000</b>

**Broadway, Corner of Dey Street,  
New York.**

## You Know How San Francisco Looks To-day

as well as how it appeared just before the earthquake and fire, but have you seen a picture of San Francisco fifty-nine years ago—1847—the year that it first became known as “San Francisco,” when there were “some 500 inhabitants—450 probably Americans, and 300 of these Mormons”?

The right to reproduce the picture taken at that time was secured a few days before the earthquake, from the owner in San Francisco, and, together with other interesting material, appears in the June issue of *The Silver Standard*, which is now published.

Those of the trade who have not seen a copy will receive one upon writing the publishers.

### **MERIDEN BRITANNIA CO.**

(International Silver Co., Successor)

**MERIDEN, CONN.**

Makers of

“1847 ROGERS BROS.” FLATWARE

**New York Notes.**

(Continued from page 57.)

gments against him. The business has been conducted under William F. Fletcher's management, and he files the present petition in order to get the old judgments off the record. The list of creditors included Sig Hirschberg, A. A. Webster, J. B. Bowen & Co., Arthur Selwin. The total of the liabilities was \$2,753.

Hochberger last week moved his office from 37 Maiden Lane to the Myers building, room 609, 47 Maiden Lane.

Willard H. Wheeler and Newton H. Rogers, of Hayden W. Wheeler & Co., sailed Saturday on the *Campania*.

Newton Leviason, the president of the Cottle Co., 31 E. 17th St., is now in New York looking over new designs in jewelry, and will return about June 15.

Damage caused May 23 by a small fire in the building occupied by F. L. Peixotto, 1 William St., has been repaired and work in his jewelry factory resumed this week.

The American Jewelry Co., Brooklyn, with an authorized capital stock of \$25,000, was incorporated last week. The directors are E. H. Pfeiffer, Albert Levy, H. O. Patterson, all of Brooklyn.

Dr. George F. Kunz, of Tiffany & Co., returned last week from a short vacation spent at his country home. Dr. Kunz has recently been appointed a member of the committee which is planning the Hudson-River celebration, to take place in 1909.

Invitations have been issued for the marriage of Abe Brautman, of E. Brautman's, 697 Grand St., Brooklyn, and Miss Jessie Edelson, the ceremony to take place Monday next in Webster Hall, N. Y. After the wedding the young couple will leave on an extended trip.

M. Rosen, 386 W. 50th St., was summoned last week by the police of the W. 4th St. station on the charge of receiving stolen property. According to the police several colored persons who were implicated in the theft of a quantity of jewelry from Mrs. M. Armory, 230 W. 76th St., owned some articles with Mr. Rosen. The jeweler denies receiving any of the property.

A summons was obtained last Friday in the Essex Market Court for Locketz & Winkel, 318 E. Houston St., accusing them of violating the New York gold law by filing a slide which did not assay to the degree of fineness required by the stamp. The complainant was J. Jacoves, of the Brooklyn Watch Chain Co., 275 Bowery. The case may be heard on Friday of this week.

All the stock in the branch store of the firm of Jaccard & King Jewelry Co., 400 5th Ave., has recently been shipped to the store in St. Louis under the direction of H. McCleary, who remained after the store was closed for this purpose.

A report that the company will reopen a New York branch in another location farther north on 5th Ave. has been heard in the trade, but not confirmed.

A sentence to Elmira Reformatory was imposed last Friday in the Court of General Sessions on John Renner, the 17-year-old youth employed on one of the United

States Express Co.'s delivery wagons, who pleaded guilty to the theft of a package containing a diamond necklace which was shipped to a firm in Jersey City. An attempt was made to pawn the necklace at L. Rothman's pawnshop at 36 Park Row, and the pawnbroker notified the police who arrested Renner.

In a decision by T. S. Sharretts, the Board of United States General Appraisers, New York, sustained, last week, a claim filed by Hawley, Green & Engel and others of New York, it being held that metal belts and ornaments are dutiable at the rate of 45 per cent. ad valorem under the provision in the Dingley tariff law for manufactures of metal. Most of the belts and ornaments were set with imitations of diamonds and other precious stones, and were enamelled. The finding of the Board is in harmony with recent rulings of the courts.

Bernard Steinfeld, 404 Sixth Ave., who sells on the road, reported to the police of New Haven Tuesday of last week that jewelry to the value of \$4,000 had been stolen from him. He said that he was on his way to the railroad station when a man jumped from among the cars in the railroad yards and seized his sample case. Mr. Steinfeld pursued the robber, he said, for some distance, but was unable to catch the thief. The missing jewelry includes 10 diamond rings, two diamond sunbursts, two locketts and four gold watches.

Amusement was caused last week on arrival at the South Brooklyn docks of the British steamship *Manchester Merchant*, whose officers and men brought quite a lot of supposed gems. It seems that when the ship touched at Colombo in Ceylon the coolies, who came aboard, offered for sale what appeared to be rubies and diamonds of much value, being large and brilliant. Somebody whispered to the sailors that the coolies were not aware of the value of the precious stones. Officers and men traded watches, money and other valuables for these supposed stones. Until the ship reached Brooklyn, as the story goes, the sailors believed that they had made their fortunes by investing in these articles. The supposed rubies and diamonds were made of glass and, it is said, had been shipped to Ceylon from the United States.

Shreve & Co., San Francisco, will soon open, according to report, a branch store in New York. It is further said that the company has already leased a store, which is now being remodeled in the Cambridge Hotel property, at Fifth Ave. and 33d St. No definite announcement has yet been made, but the report is generally credited in the trade. If the store in the Hotel Cambridge property is taken it is possible that the company will have besides the Fifth Ave. front an entrance on 33d St., which would be regarded as quite desirable, being opposite one of the entrances to the Waldorf-Astoria. There are two jewelry houses now in the Hotel Cambridge property, those of Thomas Kirkpatrick and William Reiman. The remodelling of the upper part of the building and of two of the stores is being completed by the holders of the lease, the Gorham Mfg. Co., as was announced in last week's issue. While three jewelers in a row is something unusual in New York at present, yet people in the trade say that this would be no objec-

tion. The head of a prominent jewelry house nearby expressed doubtless the feeling of others when he said to a CIRCULAR-WEEKLY reporter: "When a number of high-grade stores are brought together they are a benefit to one another. We all know what the Rue de la Paix is in Paris. The more jewelry concerns that establish themselves on Fifth Ave. the better it will be for all of us. The coming of Shreve & Co., if they have decided to open here, will be heartily welcomed by New York jewelers. A house of their standing could not fail to add strength to any section in which they should locate a branch."

**Trans-Atlantic Voyagers.**

TO EUROPE.

D. Atlas, of Atlas & Fisher, Philadelphia, Pa., will sail June 9.

C. F. G. Bene, Cincinnati, will sail June 7 on the *Grosser Kurfurst*.

Emil Lewy, of Lewy & Cohn, New York, sailed Saturday on the *Finland*.

Harris Michalson, of I. L. Michalson's Sons, Ltd., Montreal, Can., sailed recently.

A. and E. Ludwig, of A. Ludwig & Son, New York, sailed recently on the *Graf Waldersee*.

Carl H. Weidemann, of Borrelli and Vitelli, New York, sailed Saturday on the *New York*.

Clement Weaver, of the Bailey, Banks & Biddle Co., Philadelphia, sailed recently on the *St. Paul*.

D. A. Weinburg, of Siegel, Rothschild & Co., Baltimore, Md., will sail on the *Barbarossa*, June 16.

Willard H. Wheeler and Newton H. Rogers, of the Hayden W. Wheeler Co., sailed Saturday on the *Campania*.

Sailing to-morrow on *La Provence* will be Charles S. Isabel, of Edward Van Dam, and J. H. Vernon, both of New York.

Meyer Goodfriend, of Goodfriend Bros., New York, and his niece, Miss Cora Goodfriend, sailed last Wednesday on the *Oceanic*.

Sailing on the *Kaiser Wilhelm der Grosse* recently were: Zach A. Oppenheimer, Leopold Stern, of Stern Bros. & Co.; H. H. Jacobson, of Jacobson Bros., all of New York.

Sailing on the *Kaiser Wilhelm II.*, May 22, were: B. Hyman, of Hirsh & Hyman, New York; Herman Keck, of the Herman Keck Mfg. Co., Cincinnati, O.; E. Arnstein, of Arnstein Bros. & Co., New York; Jules Franklin, New York.

FROM EUROPE.

R. Reinhart, New York, returned recently on the *Kaiser Wilhelm II.*

I. Newton Levinson, of the S. Cottle Co., New York, will return about June 15.

Jacob Strauss, of Jacob Strauss & Sons, returned May 15 on the *Kaiser Wilhelm II.*

**Market Price of Silver Bars.**

The following are the quotations of silver bars in London and New York, as reported by Zimmermann & Forshay:

	New York.	London.
May 22.....	\$.67½	31 3-16d.
" 23.....	.68	31 3-8d.
" 24.....	.67¾	31 5-16d.
" 25.....	.67%	31 3-16d.
" 26.....	.67%	31 1-4d.
" 28.....	.67%	31 1-4d.

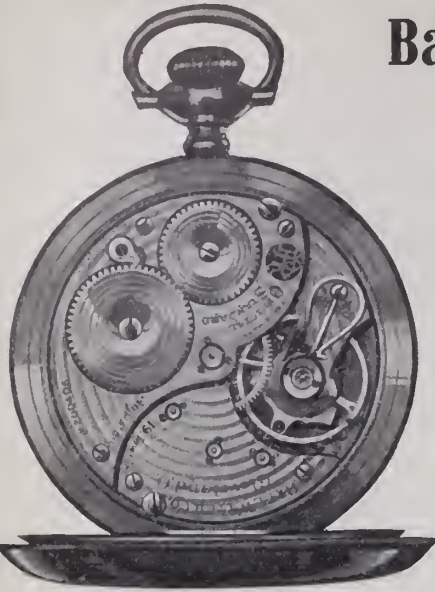

## Ball's Official Standard R.R. Watches

WHAT WOULD YOU GIVE FOR A LIFELONG CUSTOMER?

Try this plan.

Sell your next watch customer a "Ball."

Its reliable performance will convince him you are a dealer to be depended on—he'll keep coming back for other things.

The watch will win you his business and friendship for always.

*Write for booklet, and watch this space.*

We want to add a lot of new friends to the Ball family of railroad watch dealers.

### THE WEBB C. BALL WATCH CO.

CLEVELAND  
Ball Building

CHICAGO  
804-6-8 Railway Exchange

ESTABLISHED 1854.

INCORPORATED 1893.

JUERGENS & ANDERSEN Co.,  
DIAMONDS,  
MAKERS OF FINE JEWELRY,  
92 TO 98 STATE STREET,  
CHICAGO

23-25 Looijersgracht, Amsterdam, Holland.

# THE HERMAN KECK MFG. CO.

## CUTTERS OF

# DIAMONDS.

### FOR SALE.

A complete diamond cutting outfit of twenty benches, European make, consisting of sawing machines, rounding machines, laps, tongues, dops, scouring stands, etc., all in first class condition. Will sell cheap, if sold in bulk at once, as we have replaced them with American tools.

MANUFACTURING JEWELERS, SILVERSMITHS.

Recutting and Repairing of Diamonds.

17-19-21-23 West Fourth St.,  
CINCINNATI, O.

## RUDOLPH NOEL & CO.

IMPORTERS OF

Diamonds, Pearls, Rubies, Emeralds, Sapphires, Opals, Olivines,  
Cat's-Eyes, Rose Diamonds and Reconstructed Rubies

2 Tulp Straat, AMSTERDAM

'Phone 1902 John

37-39 Malden Lane, NEW YORK



# WESTERN DEPARTMENT

Western Office:  
204 COLUMBUS MEMORIAL BUILDING,  
CHICAGO.

Telephone:  
4079 CENTRAL,  
CHICAGO.

CHICAGO, WEDNESDAY, MAY 30, 1906.

No. 17.

## Kansas City.

J. Norton, of the C. B. Norton Jewelry Co., is at present a member of the jury in the criminal court.

Anna Huth, of the office force of the Edwards & Sloane Jewelry Co., left last week for a short vacation trip.

E. E. Branche, a student at the Kansas City Polytechnic Institute, has resumed his studies, after a visit of several weeks to the country.

Charles Makepeace, a student at the Kansas City Polytechnic Institute, has just returned to work, after an absence of about a month.

W. T. Medley, Yellville, Ark., and E. A. Medley, Melbourne, Ark., have just arrived in this city, and taken up their studies with the Southwestern Optical College.

Paul Preston, who covers Southeast Kansas, Oklahoma and Indian Territory for the Edwards & Sloane Jewelry Co., is on a short vacation, and is paying a visit to relatives in Butler, Mo.

C. F. Allison, manager of the Eagle Jewelry Co., 215 E. 12th St., reported to the police that his store was robbed the other night of 15 gold watches and 30 rings and eight lockets. The burglar forced a rear window.

E. P. Kionka, of Kionka & Kionka, has notified his firm that, having finished his trip through Tennessee and Kentucky, he has gone direct to Wisconsin, and will transfer his trade in that section before coming home.

Wm. L. Foutch, of the Southwestern Optical College, who lives in Gurdon, Ark., has returned to his work here, after having attended the organization meeting of the Arkansas association. He reports a very enthusiastic association as having been formed.

The following jewelers called on the local jobbers during the past week: D. P. Melli, Frontenac, Kans.; H. W. Walter, Jarcke, Junction City, Kans.; S. J. Huey, Celestior Springs, Mo.; J. H. Whiteside, Liberty, Mo.; Walter Sperling, Seneca, Mo.; S. H. Ledden, Sedan, Kans.

Dr. S. W. Lane, president of the Southwestern Optical College, writes that he has nearly completed his trip through the south and that the secretary of the American asso-

ciation on his organization work. He will be home the latter part of this week. In Oklahoma the doctor had the pleasure of seeing six graduates of his school selected among the officers of the local association.

## Denver

A. L. Shelley, of the Geo. Bell Co., left for Arizona, last week. Mr. Shelley will visit the mineral mines of the territory and secure minerals for specimens and cutting purposes.

Thomas Heard, Los Angeles, Cal., manufacturer of the Heard Improved Suction eyeglasses, was in this city, last week, on his way home from a tour of the east and northwest. Mr. Heard was interested in the California Jewelry Co., San Francisco, and reports that he lost over \$40,000 in the recent disaster.

The police are looking for one C. Davis, who secured goods from jewelry and other firms of this city under false pretences. One of his victims was the Enterprise Jewelry Co. Davis told J. Solomon, proprietor of the concern, that he conducted a general merchandise store at 338 Colorado Ave., Colorado City, and represented that he was of good standing with a prominent dry goods firm and trunk factory here. On these statements Mr. Solomon gave him \$85 worth of diamonds on credit. The man then went to the firms whom he had used as recommendations and using Mr. Solomon's name secured \$1,000 or more of merchandise on credit. He defrauded other jewelers and merchants in the same way, leaving town with, it is thought, over \$5,000 worth of stock. It has been ascertained upon investigation that his statements concerning the store at Colorado City were true, but since his disappearance it has been closed. Davis was only a recent arrival in the town and nothing is known of him there. He is described as being about 40 years of age and suffering from asthma. Because of the latter affliction he is believed to be still in Colorado.

The Goldstein-Weisser Jewelry Co., Peoria, Ill., has dissolved.

The business of the late Lorena Baker, Martinsville, Ill., is now conducted by A. Low & Son.

## Chicago Notes.

Announcement has been made by the South Bend Watch Co. that the management has decided not to have a half-holiday Saturdays this Summer at the factory, and there will be no Summer vacation, owing to the fact that the plant will have to run continuously with a full force.

John P. Byrne, secretary of Lyon & Healy, was given a silver loving cup, last week, by employes of the firm. The donors are: C. N. Post, J. F. Bowers, G. E. Griswold, C. R. Fuller, W. H. Leckie, C. F. Ippel, H. H. Jefferson, R. B. Gregory, P. J. Healy, A. J. Keefe, T. F. Mullaney, T. F. Delaney.

Herman F. Hahn, head of the firm of H. F. Hahn & Co., was recently elected president of the United Hebrew Charities of this city. Mr. Hahn, who has been a resident of Chicago since 1873 has been vice-president and president of the Michael Reese Hospital, and is a member of the Standard Jewelers and Iroquois Clubs.

Albert Schuprum, said to be a salesman for a New York jewelry house, who is charged with beating Mrs. A. Asquith, 1363 Sheffield Ave., a week ago, was arraigned before Justice Mahoney at the Sheffield Ave. Police Court. Schuprum told the Court that he was intoxicated at the time he struck the woman and declared that he would take the pledge if the Court would allow him a continuance.

It was announced last week that Mrs. Timothy B. Blackstone, widow of the former president of the Chicago and Alton Railroad, has sold to Otto Young for \$500,000 the family homestead at Michigan Ave. and Hubbard Court. Mrs. Blackstone parted with the place on the stipulation that Mr. Young would tear the building down as soon as she left, allowing no one else to occupy it. It will be razed, accordingly, early next Spring, Mr. Young securing possession on Jan. 1. The lot upon which the house stands has a frontage of 80 feet and a depth of 172 feet.

Julius Kahn, former president of the now defunct Cash Buyers' Union First National Co-operative Society, was arraigned last Wednesday before Judge S. H. Bethea in the United States District Court, charged in three counts of an indictment with op-

# To the Jobbing Trade.

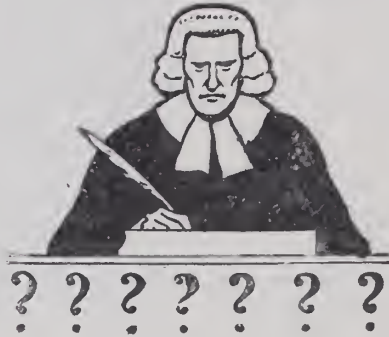

Judge the question for yourself. Does it pay you to mount your own diamonds when we sell them already set and charge the regular prices for the mountings, and the importer's price for the diamonds, selling them by weight?

See and compare. That's all we ask, and have no fear of the result.

**IMPORTERS**

**SHIMAN BROS & CO.**

87 MAIDEN LANE, N. Y.

LONDON: 50 HOLBORN VIADUCT.  
AMSTERDAM: 2 TULP STRAAT.

FACTORY,  
1, 3, 5 GOLD STRLET.

**MANUFACTURERS**

erating three separate schemes to defraud the public by the use of the mails in soliciting the sale of stocks through that agency. Kahn was in court and was represented by Attorney William S. Forrest. Attorney Forrest pleaded for two weeks in which to decide what action he would take in controverting the indictments. Judge Landis said he must plead, demur or move to quash at once. Attorney Forrest then demurred to the indictment.

Anton Nordla, claiming to be a watchmaker, residing on State St., Chicago, was found ill in the yard, at Elgin, Friday afternoon. Nordla was conveyed to the prison station, where a physician was called to attend him. He probably will be sent to Chicago if he recovers.

J. P. Byrne, the president of the Chicago Jewelers Association was recently elected president of the National Association of Piano Dealers of America at the convention of that organization at Washington, D. C. The association selected Chicago as the place of meeting next year.

Miss Zeldia Ermine Stewart, of this city, co-operating with the Chicago Women's Club, in making a report on woman and industry, showing existing conditions of factory women in Illinois, states that conditions of women employed at the watch factories of Illinois are the best she has experienced anywhere.

## Omaha.

L. C. Pedersen, Walnut, Ia., has sold his jewelry interests to C. A. Elder.

C. H. Jansen, with the Shook Mfg. Co., has just returned from a trip through Colorado.

Fred Brodegaard & Co. will supply 14 gold emblem pins to the Ladies' Danish Society.

The wife of W. H. Valhove, watchmaker with Shook Mfg. Co., has gone to Cleveland, O., on a visit.

Albert Edholm has gone out on the Lander, Wyo., extension of the Northwestern Railroad in search of new trout streams.

J. C. Mitchell has purchased the jewelry store of Harry Engels, Red Cloud, Nebr., while Mr. Engels has bought the store of J. H. Le Roy, Fairbury, Nebr.

News was received here recently that J. F. Ingalls, Long Pine, Nebr., shot himself in the abdomen May 23 and died a few hours afterward. The deceased was unmarried.

Out-of-town buyers in this city last week included: K. C. Koons, Beatrice; D. Davis, Falls City; Fred Gardner, Lincoln; J. W. Crabill, Plattsmouth, and C. E. Smith, Kingsley.

F. Willman, a pioneer jeweler of St. Water, Minn., who recently closed out his business, spent several days in Omaha last week, while en route to the coast on a pleasure trip.

George W. Ryan, of the firm of Mahinney & Ryan Co., accompanied by his wife, has returned home from a two month trip spent in Europe. They visited France, Germany, Holland and England. Mr. Ryan purchased extensively while abroad.

C. G. & L. L. Otwell, Laurel, Del., has been succeeded by C. G. Otwell, who will continue the business alone.



## Cincinnati.

John A. Herchede, of the Herchede Hall Clock Co., is home again from his eastern trip.

Louis F. E. Hummel, 9 Emery Arcade, is enjoying a 10 days' rest at West Baden, Ind.

E. J. Fox, of Lindenberg & Fox, and family have gone to their Summer cottage at Tower Hill.

John C. Daller, Sr., manager of the Clemens Oskamp Co., is making a business trip through Ohio.

Clifford Husman, formerly with Lindenberg, Strauss & Co., has taken a position with Joseph Mehmert.

L. M. Levy, secretary of the Philadelphia Watch Case Co., at Riverside, N. J., was a visitor here last week.

B. Ganz, of the Gustave Fox Co., is making a special trip through Illinois, Indiana, Michigan and Ohio.

J. D. Fuhr, a clerk in Schwartz's pawnshop on Central Ave., died suddenly in the store, last week, of heart disease.

Hess Henle, of A. G. Schwab & Bro., left last week for a two weeks' pleasure tour of New York, Boston and Atlantic City.

I. N. Fox, of Fox Bros. & Co., has returned from Europe, where he visited the diamond markets. Sol Fox, of this firm, returns in June.

Joseph Noterman, of Joseph Noterman & Co., and E. H. Croninger, with their wives, are attending the Knights Templar Conclave at Paris, Ky.

C. J. Bene, formerly of the firm of Beue, Lindenberg & Co., will leave Cincinnati, June 1, for New York, from which city he will sail for Europe June 7.

Bitterman Bros., Evansville, Ind., have purchased new fixtures in this city for their new store, which is reported to be one of the finest in that section of Indiana.

Out-of-town buyers who replenished their stock here, last week, included Frank Emmerling, Hillsboro, O.; J. N. Embrey, North Lewisburg, O.; J. C. Fischer, Flemingsburg, Ky.; E. B. Scott, Batavia, O.

The glass front in the store of A. C. Ackman, at 9th and Pike Sts., Covington, Ky., was broken by thieves the past week. No goods were stolen, as the thieves were frightened away before they could get anything.

Joseph Becker, for some years connected with the Cincinnati branch of the Philadelphia Watch Case Co. and well known here, has retired from business and gone to Fayetteville, Mo. John Derwin, a former Cincinnati jeweler, is Mr. Becker's successor.

Floyd Nester, Boonville, Ind., who was recently married to Miss Mary E. Metsker, of Noblesville, Ind., came to this city in the course of their honeymoon and visited Cincinnati friends. Fred. Heinzle and wife, of Fell City, Ind., were also here in company with the bride and groom.

A few days ago Jacob Reinstatler, jeweler at Clark and Baymiller Sts., and his little daughter Olga, while seated in the front of their home, were bitten by an infuriated bull dog, which, with its owner, was passing by. The dog first attacked the child and would not release her until it was beaten almost into insensibility by its

owner. While Mr. Reinstatler was taking the name and address of the man the dog bit him on the hand and then turned on his master, biting the latter severely. Officers were called and they attempted to take the dog away to shoot it. It then leaped to the throat of its master, but was immediately shot. The wounds of Mr. Reinstatler and his daughter were cauterized and both are reported as doing well.

## St. Louis.

W. W. Purcey is the proprietor of a new jewelry store that has opened at 4304 Page Ave.

A. Hagen, formerly of 3160 Easton Ave., has moved further east, and is now located at 3540 Olive St.

A. H. Aylesworth, president of J. F. Dailey & Co., was here from Chicago several days last week.

Alvin L. Bauman, president of the L. Bauman Jewelry Co., has announced by cable his safe arrival in Paris.

A. C. Arnold, of Arnold & Co., Texarkana, Ark., was a visitor in St. Louis last week, combining business with a visit to his relatives here.

Jacob B. Pollack is the latest to open a new jewelry store in this city, his store being located at 6116 Easton Ave. Mr. Pollack is the son of Joseph Pollack, of 1133 N. 4th St.

Meyer Hurwitz has opened a new store in the Arcade at 503 Collinsville Ave., East St. Louis. His establishment is one of the largest on the east side. He is well known in St. Louis.

W. H. Wheeler, Palmyra, Ill.; Enno Dick, New Baden, Ill., John Ketting and E. J. Baumann, Ste. Genevieve, Mo., were among the visiting jewelers in the local market last week.

Goodman King, president of the Mermod, Jaccard & King Jewelry Co., probably will sail from Cherbourg, June 9, after a visit abroad. Mr. King will remain several days in New York, and he is due to arrive in St. Louis about June 20.

F. J. Bross, one of the traveling representatives for the L. Bauman Jewelry Co., departs this week to enjoy his vacation, after a successful season. From St. Louis he goes to French Lick Springs, Ind., and thence to Lake Minnetonka, Minn.

A police report states that T. J. Klein, a salesman for the Sterling Silver Co., left his sample case, valued at \$35, in charge of a small boy, and that the case was stolen from the youth. The directory fails to give the name of the Sterling Silver Co.

The stockholders of the Brooks Jewelry & Optical Co., *Globe-Democrat* building, have elected the following officers and directors: Jas. J. Burke, president and treasurer; Paul E. Pautler, vice-president, and Arthur G. Sudheimer, secretary. Mr. Burke is 33 years old, and the others are each 21, making the average age of the directors only 25, the youngest average of any corporation in Missouri, with a capital of \$25,000.

Herman Mauch, president of the Retail Jewelers' Association of Missouri; Frederick W. Drost, and Martin Hacker, the St. Louis jewelers who attended the conclave of the Missouri Knights Templar at

Joplin, have returned with expressions of having had a most enjoyable time. C. S. Poole, Joplin, was a member of an important committee that rendered great assistance in entertaining the visitors, Charles A. Mauch, Marshall, Mo., a brother of the St. Louis jeweler, was also at the conclave.

Harry Smith, a negro burglar, who was caught, recently, in the act of robbing the jewelry store of William F. Mueller, at 1804 Olive St., was captured in Union Station after a long and exciting chase. When Smith was run down on his person were found two silver watches, three silver match safes, some silver knives and forks and a silver-backed hat brush, identified as having been stolen from the Mueller store. At the rear door of the place was a lot of silverware, two handsome toilet sets and other articles of the total value of \$200. A gold watch and chain with a diamond studded charm, a pair of gold-rimmed spectacles and some gold cuff buttons were found on Smith, and the police believe these articles were also stolen.

J. F. Dailey, manager of J. F. Dailey & Co., a time payment house, states that a warrant has been issued for the arrest of one of their outside representatives, Charles E. Pitcher, who is said to have decamped with diamonds and watches to the value of \$400. Pitcher left the Dailey establishment with the samples Saturday afternoon, May 12, and nothing has been heard from him since. At first it was thought that his disappearance might be the result of foul play, but investigation developed the fact that Pitcher had collected various sums which he did not turn into the office. Pitcher is described as being 5 feet 10 inches in height, having light hair and sometimes wearing a light mustache. He is thin and inclined to stoop, has a prominent nose and a receding chin. He has worked for various time-payment houses, including Loftis Bros. & Co., Chicago and St. Louis, and at one time was assistant manager of the branch here, the Walker-Edmund Co. and Jones & Dreyer, Chicago. He has been with the Dailey firm for several months.

## Minneapolis and St. Paul.

W. F. Renich, of Kirchner & Renich, Minneapolis, is ill of typhoid pneumonia.

Charles Olson and wife, Minneapolis, left May 24 for a visit to Sweden. They will be gone about three months.

C. P. Greene, of the Minneapolis School of Watchmaking and Engraving, has returned from a short trip to Iowa.

The Jewelers Security Alliance has added the following members in Minneapolis: H. Birkenhauer & Co., Johantgen & Kohl, Reed-Bennett Co., E. E. Spaulding and W. G. Leber.

The R. G. Winter Jewelry Co., Minneapolis, closed its store Thursday to rearrange stocks for a sale, previous to moving to the new location at 608 Nicolett Ave. The company will be in the new quarters about Aug. 1.

G. B. Ellestad, Lanesboro, Minn., last week, was in the Twin Cities on his way to Fort Francis, Ont., on the international line between Minnesota and Ontario. It is necessary to go to Winnipeg in order to reach the city of Fort Francis by rail.



# A. C. BARD & CO.

IMPORTERS AND CUTTERS OF **DIAMONDS**

Loose or mounted goods on memo. to responsible dealers.

103 STATE ST., CHICAGO. COLUMBUS MEMORIAL BUILDING.

## Anniversary Clock

TRADE-MARK REGISTERED.

All *genuine* Anniversary Clocks running 400 days, bear the above name plainly lettered on the dials.

**Beware of Imitations** and infringements of our trade-mark.

Every up-to-date jeweler should have the Anniversary Clock in stock.



Colonial Mantel Regulator No. 1, Mexican Onyx and Bronze Case. Height, 13½ in.; width, 10¾ in.; Porcelain Dial, 1 in.



If you wish the ordinary 400-day clock, with brass base, we have it at \$8.00 each, but do not guarantee or recommend it.

**THE BOWLER & BURDICK CO.,**  
CLEVELAND, O.

Sole Agents for the U. S.

Send for Catalogue

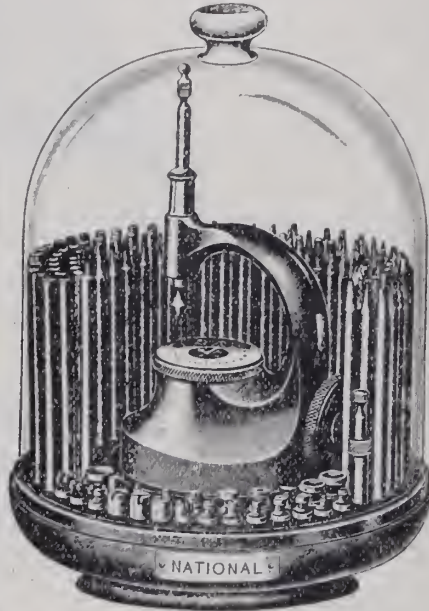

### Our Special 60 Days' Offer

The above Staking Tool with 100 Punches and 24 Stumps for \$16.00, less 6% Cash with order. Mention this paper.

Buy the **Columbian Brand American Made Balance Staffs and Balance Jewels, Etc.**



Balance staffs, Balance jewels, Cap jewels, Plate jewels, Roller jewels, and Mainsprings. They are the best made and we guarantee all our brand to give entire satisfaction or we shall replace them with new material.

**THE COLUMBIAN JEWELRY MFG. CO.,**

Importers and Jobbers of

Watchmakers', Jewelers' and Opticians' Supplies.

ROOMS Nos. 427 to 430 CENTRAL BLOCK,  
PUEBLO, COLO.

John A. Blair, Manager.

### "PRACTICAL COURSE IN ADJUSTING."

PRICE \$2.50.

ALL JOBBERS OR

**JEWELERS' CIRCULAR PUBLISHING CO.**



The **AMERICA Alarm** is a trade-waker for dull stores—a special price on such a necessary article is a good advertisement that pays its own way.

The Western Clock Mfg. Co.  
LA SALLE, ILL.

# Rockford Watches Speak for Themselves.

## San Francisco.

### TRADE CONDITIONS.

The San Francisco retailers who have re-established themselves in either temporary or permanent quarters in that city, report that trade conditions continue to show a slight improvement from day to day. So far sales of articles of utility, such as cutlery, spoons and hollow ware, are the largest. The demand for wedding rings is still unusually large and there is a growing demand for jewelry of various grades. Even the dealers in solid goods and in cut glass report that a certain demand is springing up. One prominent feature of the trade is a demand for souvenirs which have been through the fire. During the last few days jewelers are offering burned goods with considerable success. Both jobbers and retailers are doing considerable business in damaged souvenir spoons, which are meeting with a good sale from collectors and others. Souvenirs of this sort are retailing at from \$1 to \$2 apiece.

The W. K. Vanderslice Co. has located in a temporary office on Devisadero St., near Geary St.

Radke & Co., formerly at 118 Sutter St. and at 65 Geary St., are now doing business at 1813 Devisadero St.

Karl Eber & Co., retail jewelers, formerly at 206 Kearney St., opened last week with a line of jewelry, silverware, etc., on Castro St.

C. J. Auger, formerly at 303 Kearney St., has now taken a store at the corner of Van Ness Ave. and Market St., in the new retail district.

William Glindemann, formerly at 53d St., has secured quarters in the new Fillmore St. retail district. His new store is on Fillmore St., near McAllister St.

A. Sanders, formerly in business here, but who has been staying at San Luis Obispo since the fire, has returned to this city for the purpose of resuming business.

The James A. Sorensen Co., formerly at 103 6th St., has opened a store at 1255 Fulton St., and is also opening a branch store at the corner of 20th and Mission Sts.

It is definitely announced that Brittain & Co., formerly at 120 Geary St., but who since the fire have entered the hardware trade, will not reopen in the jewelry business.

Thomas Fairbrother, who, before the fire, was located at 609 Taylor St., has had his safe moved to Napa, Cal., where it will be opened. Mr. Fairbrother will probably remain at Napa for some time.

Julius A. Young, manufacturers' agent, now in the Globe Hotel, Broadway, Oakland, is having fixtures installed in his new quarters at 717 Market St. He expects to remove to San Francisco within a few days.

The Fleissner, Marshall Co., formerly in business at 14 Geary St., has taken temporary offices at Mr. Fleissner's residence on Vallejo St. As yet it has not been decided when or where the company will reopen its store.

A. Katz, 925 Broadway, Oakland, reported to the police a few days ago that he was robbed of a diamond ring by two soldiers who entered the store ostensibly to buy a ring, but who ran out with a ring when his back was turned.

J. R. Jenkel, formerly in business at 817 Market St., in the old Flood building, has completed arrangements for a temporary store on Van Ness Ave., between Sutter and Bush Sts. His new store will have a frontage of 22 feet and a depth of 55 feet.

The Emporium, San Francisco's largest

general store, has secured a location at the corner of Van Ness Ave. and Post St. A temporary building will be erected here as soon as possible, and the plans call for jewelry, cut glass and kindred departments.

The Owl Drug Co., which has a large department devoted to toilet articles and sundries, has arranged to open a store on Van Ness Ave., between California and Sacramento Sts. The store will have a frontage of 50 feet and a depth of 100 feet.

Mr. Warren, of the Elgin National Watch Co., came out from Chicago last week to assist Mr. Morse, manager of the company's San Francisco agency, in getting re-established. Temporary quarters have been taken at 525 13th St., Oakland, and a permanent location in San Francisco will be secured as soon as possible.

Henry Wolff, formerly located at 120 Sutter St., reports that his safe, when pulled out of the ruins, two weeks after the fire, was still red hot in places and that the wheels of the safe were so hot they burned tracks in the planks up which the safe was pulled. The contents of the safe were found to be in poor condition.

Hammersmith & Field have secured a good temporary location at the corner of Van Ness Ave. and Eddy St., where they have opened with a stock of jewelry and silverware. They are preparing to fit up the new store quite handsomely and to remain there until permanent quarters can be secured in the downtown district.

Nordman Bros. are requesting eastern manufacturers who did business with the house to furnish the concern with a statement, showing the amount of merchandise purchased since Jan. 1. This is done for the purpose of adjusting their insurance claim, as the fire destroyed all records. The firm is now located at 2505 Clay St.

William Allan Hargear has assumed the management of Shreve & Co.'s Oakland office, 1103½ Broadway. Shreve & Co. are now equipped with a fair amount of stock at their temporary store, 2429 Jackson St., this city, and are going ahead rapidly with the preparations of refitting and reopening the former store at the corner of Post St. and Grant Ave.

The Nathan-Dohrman Co., wholesalers and retailers of tableware, hollow ware, cut glass, art goods and house furnishings, has secured temporary quarters on Van Ness Ave., between Pine and California Sts. The store will have an average width of 100 feet and an average depth of 120 feet. Besides the frontage on Van Ness Ave., the plans provide for a wing with a 25-foot frontage on California St.

A. I. Hall & Son, who are now partially located in San Francisco and partially in Oakland, report the arrival of 11 tons of clocks at the railroad yards, but owing to the congestion of the railroad business and the inability of the railroad company to secure sufficient help to effect a clearance, the clocks are still undelivered, although there is at present a great demand for this class of goods from all over the State. There is also a good demand for watches.

The store now occupied by William Wilson, on Broadway near 11th St., Oakland, has been leased with the remainder of the building to the United Cigar Stores Co. The latter company has demanded an increase in rent from \$135 to \$350 per month. It is

not yet known whether or not Mr. Wilson will pay the increase; in fact, it is reported that the store he now occupies will be converted into a restaurant. Mr. Wilson has been in business in Oakland for 40 years, and his is said to be the oldest mercantile business in the city.

Joseph H. Eames, a diamond setter, formerly located in the Thurlow Block, at 126 Kearney St., has been arrested on a charge of felony embezzlement preferred by F. De Ferrari & Co., formerly in the jewelry business at 217 Montgomery St. The management of the latter company claims that at the time of the fire Mr. Eames had in his possession eight diamonds valued at \$1,000 belonging to F. De Ferrari & Co. Mr. Eames claims that the diamonds had been lost out of the safe through a hole which was burned in it at the time of the fire.

## Indianapolis.

Herman L. Rost, Columbus, Ind., spent last Sunday with his brother, Carl L. Rost and family, of this city.

The police have not succeeded in getting any clue which might lead to the identity of the man who recently passed a forged check at the Cullen Optical & Jewelry Co.'s store.

A gold bar worth \$180 and made of Indiana gold, mined in Morgan county at the placer mine of the Gold Creek Mining Co., was on exhibition in this city recently. The gold was 22 karat.

J. H. Reed has returned from a six weeks' visit along the Pacific coast. He spent several days in San Francisco, where he succeeded in getting many fine photographs of the earthquake ruins.

Out-of-town jewelers who visited the local jobbers and manufacturers last week, included: Aaron Pursel, Noblesville; Mr. Barnes, of Barnes & Foster, Spencer; H. Wheeler, Dana; J. A. Pickett, New Castle; C. E. Hodgen and Ross J. Haseltine, Kokomo; J. F. Harding, Brownsburg; H. A. Pauley, Bloomington; B. Maier, Edinburg; D. S. Whittaker, Lebanon, and Mr. Raber, of Clark & Raber, Anderson.

## Pacific Coast Notes.

A. W. Susen, Monterey, Mex., has gone to Dallas on a short business trip.

Thomas H. Ryland, New York, called on the jewelers in Santa Fe, N. Mex., last week.

T. R. Jones, Phoenix, Ariz., will leave June 1 for Southern California, where he may locate.

D. S. Binford, Whittier, Cal., attended the monthly meeting of the Southern California Optical Society, in Los Angeles, last week.

E. R. Hubbard, Lompoc, Cal., is making improvements in his store. He now occupies the entire front of the building and has added a line of silverware.

A. E. Springborg, Redlands, Cal., is making extensive additions to his jewelry store in the way of furniture. A solid oak cut glass room is being placed in the rear of the show room, where a large stock of cut glass, hand-painted china and Tiffany glass will be displayed. The room will be lined with plate glass mirrors on two sides and brilliantly lighted with electric lights.

# FANS FOR GRADUATION, WEDDINGS, CONFIRMATION.

HEADQUARTERS FOR THE MOST EXCLUSIVE LINE IN THIS COUNTRY.

Similar goods  
are not  
obtainable  
elsewhere.

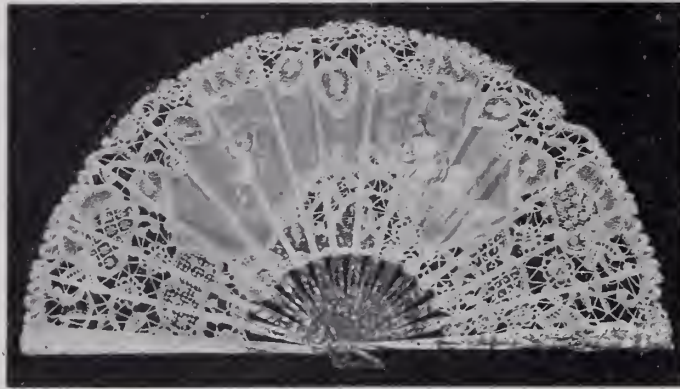

They are of  
original design  
and my own  
creation.

## NECKLACES

IMITATION PEARL AND FANCY  
BEAD, IN ALL NEWEST SHADES  
AND EXQUISITE COLORINGS.

*Samples of Fans and Necklaces sent on request.*

LOUIS STEINER, Importer,  
520 and 522 BROADWAY, NEW YORK.

## Bigalke & Eckert Co.

— IMPORTERS OF —  
**WATCHES**

No. 1 MAIDEN LANE,

NEW YORK

Plain Watches in all Styles, Grades and Prices.

Single and Split Second Timers in Nickel and Gun Metal Cases.

Chronographs, Split Seconds, Repeaters. Fancy Decorated Watches for Ladies.

Finest and Most Extensive Assortment of Flat and Ultra Flat Watches.

Sole Agents for **Haas, Neveux & Cie.** Fine Geneva Watches

INDEX TO ADVERTISEMENTS.

Adams & Singleton.....	30	Forsinger, J. W.....	87	Noel, Rudolph, & Co.....	62
Alkin, Lambert & Co.....	102	Foster, Theodore W. & Bro. Co.....	32	Nonnenmann, A., & J. Aschenbrenner.....	100
Allsopp & Allsopp.....	21	Four-Track News.....	100	Noterman, Jos., & Co.....	72
Allsopp Bros.....	18	Fox, Gustave, Co.....	21	Novelty Engineering Ass'n.....	96
Alsterlund, H. E., & Co.....	30	Freund, Henry, & Bro.....	19	Ohan, G.....	20
Alvin Mfg. Co.....	Inside front cover	Friedlander, R. L. & M.....	Outside back cover	Omega Watches.....	85
American Gem & Pearl Co.....	52	Garreud & Griser.....	10	Oppenheimer Bros. & Veith.....	36
American Platinum Works.....	102	Gesswein, F. W., Co.....	96	Oppenheimer, H. E., & Co.....	36
American Waltham Watch Co.....	76	Goldsmith, C. P., & Co.....	18	Oriental Bank.....	58
Arch Crown Mfg. Co.....	56	Goldsmith, Leo.....	15	Osmun Parker Mfg. Co.....	22
Arnstein Bros. & Co.....	Outside back cover	Goodfriend Bros.....	42	Ostby & Barton Co.....	16
Art Stamping & Mfg. Co.....	27	Gorham Mfg. Co.....	51	Parks, G. W., Co.....	12
Austin, John, & Son.....	Outside back cover	Greer Mfg. Co.....	102	Patek, Philippe & Co.....	84
Aztec Turquoise Co.....	40	Griffoul, August.....	103	Penfold, Wm. C., Co.....	87
Bagg, Perline & Co.....	41	Guardian Trust Co.....	58	Potter & Bullintou Co.....	14
Baker, Geo. M.....	Outside back cover	Hagstoz, T. B., Ltd.....	101	Power, Chas. L., & Co.....	42
Ball, Webb C., Watch Co.....	62	Harris & Harrington.....	Outside back cover	Powers & Mayer.....	15
Bard, A. C., & Co.....	66	Hedges, A. J., & Co.....	22	Prior, Charles M.....	96
Baschkopf, Jacob.....	40	Hedges, Wm. S., & Co.....	42	Prybil, P.....	103
Bass, E. & J.....	21	Heitz Bros.....	100	Racine, Jules.....	48
Bassett Jewelry Co.....	30	Heller, L., & Son.....	38	Reichhelm, E. P., & Co.....	96
Bastian Bros.....	104	Herpers Bros.....	96	Reis, G., & Bro.....	31
Bates & Bacon.....	16	Hirschberg, A. S.....	40	Renzlehausen, W. F., Co.....	104
Bealmeier, H., & Co.....	98	Hodemjyl & Walker.....	38	Revell, A. H., & Co.....	Outside back cover
Berge, J. & H.....	103	Holtzer-Cabot Electric Co.....	103	Ries & Armstrong.....	96
Bergalke & Eckert Co.....	68	Hotel St. James.....	30	Riviere Brass & Bronze Works.....	98
Bizney, S. O., & Co.....	4	Howard, E., Clock Co.....	72	Rockford Watch Co.....	66
Billings, Chester, & Son.....	40	Hraba, Louis W.....	98	Roger Williams Silver Co.....	31
Bishop, R. W.....	103	Humphrey, John B.....	40	Rosenman, A.....	46
Blackinton, R., & Co.....	30	Hutchison & Hustis.....	29	Rosenfeld, Wm. I.....	48
Blackinton, W. & S., Co.....	9	Illinois Watch Co.....	13	Roy Watch Case Co.....	86
Blancard & Co.....	100	International Silver Co.....	60	Rudolph & Snedeker.....	84
Boote, Edward.....	98	Jacot Music Box Co.....	98	Rumpf, C. F., & Sons.....	100
Borrelli & Vitelli.....	42	Jeantheur, F., Jr.....	103	Saart, W. H., Co.....	28
Boston Jewelry Co.....	28	Jeanne, Frederick A.....	44	Saunders, Meurer & Co.....	42
Bowden, J. B., & Co.....	18	Johnsten, W. J., Co.....	10, 11	Schiff, M.....	22
Bowler & Burdick Co.....	66	Juergens & Andersen Co.....	62	Schultz, Leiss & Co.....	20
Bradley Polytechnic Institute.....	96	Juergensen, Jules.....	84	Sessions Clock Co.....	87
Brower, Maurice.....	46	Kahn, L. & M., & Co.....	Outside back cover	Shiman Bros., & Co.....	64
Bruhl Bros. & Henus Co.....	Outside back cover	Keck, Herman, Mfg. Co.....	62	Siegel, Rothschild & Co.....	72
Buckley, Sam'l., & Co.....	25	Keut & Woodland.....	24	Simmons, R. F., Co.....	8
Bunde & Upmeyer Co.....	50	Ketcham & McDougall.....	100	Smith, Alfred H., & Co.....	36
Bohne, C. H., Co.....	31	Keystone Watch Case Co.....	81	Smith, E. H. H., Silver Co.....	31
Barrington & Co.....	22	Klipper Bros.....	71	Smith, Wm., & Co.....	31
Barter, Howe & Co.....	23	Kohlbusch, Herman, Sr.....	50	Snow & Westcott.....	25
Batham National Bank.....	58	Kohn, Aols, & Co.....	22	Sohn & Hyman.....	46
Bhopard Freres.....	50	Koshlaud & Italie Co.....	26	Solidarity Watch Case Co.....	42
Columbian Jewelry Mfg. Co.....	66	Kremenz & Co.....	19	Spencer, E. L., Co.....	29
Bonley & Straight.....	104	Lackner & Ohl.....	48	State Bank.....	58
Cooper Diamond Co.....	40	Langendorf Watch Co.....	84	Steiner, Louis.....	68
Cooper & Forman.....	48	Larter & Sons.....	34	Stern Bros. & Co.....	46, Inside back cover
Cottle, S., Co.....	25	Leimann Bros.....	72	Sternau, S., & Co.....	12
Cohn, M.....	24	Lelong, L., & Bro.....	Outside back cover	Stiven, John S.....	20
Cross & Bequelin.....	27, 56	Levy, Robt.....	20	Strauss, Ignaz, & Co.....	Outside back cover
Crossman, Chas. S., & Co.....	48	Lewy & Cohen.....	27	Strauss, Jacob, & Sons.....	46
Crossman Co.....	44	Lissauer & Co.....	38	Street, Geo. O., & Sons.....	23
Crouch & Fitzgerald.....	98	Loeb, Wm., & Co.....	27	Tavannes Watch Co.....	72
Cattelbaum & Friedman.....	52	Lorsch, Albert, & Co.....	Outside back cover	Thomas, Seth, Clock Co.....	86
Cray, Clark & Co.....	23	Loth, Joseph, & Co.....	25	Trenton Watch Co.....	86
Cederick's Sons, James H.....	104	Low, Martin, & Taussig.....	38	Trout, Charles L., & Co.....	24
Cepasse Mfg. Co.....	24	Lowe, Edwin, & Co., Inc.....	28	U. S. Electro-Chemical Co.....	96
De Selms Watch School.....	103	Luthy & Hine.....	25	Wadsworth Watch Case Co.....	6, 7
Diamond Point Pen Co.....	102	Lyons Gem Co.....	40	Wagner Mfg. Co.....	52
Disheim, Hipp., & Bro.....	84	Mackey Jewelry Co.....	28	Waite-Thresher Co.....	29
Donnelly, J. J.....	104	Maebert & Reiss.....	102	Washburn, C. Irving.....	20
Dorflinger, C., & Sons.....	98	Maerle City Glass Co.....	98	Wells, Chester H.....	18
Dulk, Robt.....	40	Market & Fulton National Bank.....	58	Wendell & Co.....	5
Dunbar, Leach, Garner Co.....	102	Mercantile National Bank.....	59	Western Clock Mfg. Co.....	66
Dunn, Thomas J., & Co.....	26	Meriden Britannia Co.....	60	Wheeler, Hayden W., & Co.....	36
Durand & Co.....	22	Meyerowitz Bros.....	33	Whiteside & Blank.....	23
Eichberg & Co.....	46	Miller, Fuller & Whiting.....	28	Whiting & Davis.....	14
Elgin National Watch Co.....	78	Moore & Sons.....	24	Whiting Mfg. Co.....	17
Eliaasof Bros. & Co.....	50	Mount & Woodhull.....	44	Wightman & Hough Co.....	28
E. P. H. Chain Catch.....	30	Mueller Lapidary Co.....	40	Witsenhausen, L.....	18
Ehys, Joseph, & Co.....	1	Myers, S. F., Co.....	48	Wodiska, Julius.....	26
Fairchild & Co.....	102	Newburgh, R.....	84	Wolfsheim & Sachs.....	27
Favre-Jacot, Georges, & Co.....	85	New England Watch Co.....	82	Wood, C. F., & Co.....	Outside back cover
Feeley, W. J., Co.....	25	New York Standard Watch Co.....	80	Wood, J. R., & Sons.....	2, 3
Forman Co.....	100	New York Telephone Co.....	102		

## Special Notices.

Payable invariably in advance.  
 Rates 75c. per insertion for notices not exceeding 25 words; additional words, 2c. each.  
**SITUATIONS WANTED, 1c. a word each insertion; minimum charge, 25c.**  
 Heavy type, 5c. a word; minimum charge, \$1.25.  
 Display cards, \$2.00 per inch.  
 In all cases, if answers are to be forwarded, 10c. extra to cover postage must be enclosed.

*All answers to advertisements addressed care The Jewelers' Circular-Weekly, should be sent to the New York Office, unless the Chicago Office is specifically mentioned.*

## Situations Wanted.

A FIRST CLASS engraver desires a position at once. "E., 6407," care Jewelers' Circular-Weekly.

WATCHMAKER, engraver and jeweler of ability is open for engagement. Address "C., 6331," care Jewelers' Circular-Weekly.

SITUATION WANTED by lady engraver, during the Summer months. Address "L. E.," Room 1104 Heyworth Bldg., Chicago, Ill.

EXPERIENCED TRAVELER, practical jeweler and watchmaker, wants strictly A1 line for western territory. Box 147, Minneapolis, Minn.

YOUNG MAN, letter and monogram engraver, wants position, with opportunity to learn watchmaking. Milton Gebhard, 735 Sansom St., Philadelphia, Pa.

WANTED, in south, situation as watchmaker, with A1 store; only with gentl. man of refinement and standing. Mr. Haldeman, care Mrs. F. F. Trefzer, Union, S. C.

SITUATION WANTED; fine watchmaker of 10 years' experience; plain engraver and good salesman; age 28; total abstainer; best of reference. Box 47, Blaine, Mich.

SALESMAN, five years' experience, selling department and jewelry stores in middle west, is open for a similar position. "A. B. R., 6312," care Jewelers' Circular-Weekly.

SALESMAN, years of experience and established trade, wants medium priced line of jewelry; to deliver northwest trade, on commission basis. Box 147, Minneapolis, Minn.

WANTED, by young man, engraver, position at once; can do some jewelry repairing; samples and references on request. Address "G., 6388," care Jewelers' Circular-Weekly.

WANTED, A POSITION as engraver, book-keeper, cashier and saleslady; good references; terms reasonable. Address "Enquirer, 5877," care Jewelers' Circular-Weekly.

WANTED, steady position with chance to improve, on watchwork; first class; or clock and jewelry repairing; fair plain engraver; south preferred. "R., 6410," care Jewelers' Circular-Weekly.

FIRST CLASS manufacturing jeweler of business ability, wants position as foreman of jewelry factory; 14 years' experience at bench; references. Address "Ability, 5465," care Jewelers' Circular-Weekly.

WATCHMAKER and plain engraver (22) desires position; owns all tools; will work for reasonable salary, where there is a chance for advancement. "Reasonable, 6396," care Jewelers' Circular Weekly.

YOUNG MAN, age 20, with two years' experience, wants steady position with good firm to finish trade; speaks German; references furnished. Address Frank E. Rohloff, R. R., No. 5, Appleton, Wis.

WATCHMAKER desires position; young man; good workman; own tools; accustomed to taking in work; can do hard soldering and some engraving; best of reference. "S., 6402," care Jewelers' Circular Weekly.

WANTED, by a first class watchmaker (Japanese), a position with good house; have had 12 years' experience; can wait on trade; either city or country. Address Mami, care H. Webber, 244 W. 116th St., New York.

FIRST CLASS watchmaker wants permanent position; competent to take full charge; large experience on fine and complicated work; fine tools; best of references. Address "Time, 6290," care Jewelers' Circular-Weekly.

OPTICIAN AND WATCHMAKER would like position with some reliable house; can take charge of watch repair department or optical department; best reference. "C. E., 6420," care Jewelers' Circular-Weekly.

SALESMAN; 20 years' experience; at present with a Fifth Ave. store in New York; capable of waiting on fine trade; will be open for engagement after June 5. "Fifth Avenue, 6419," care Jewelers' Circular-Weekly.

POSITION WANTED by a young lady as first class letter and monogram engraver; willing to act as saleslady; would prefer to work in Albany, Troy, Utica or nearby; best reference. Address "L., 6324," care Jewelers' Circular-Weekly.

WANTED, POSITION by young man studying optics; good on clocks and jewelry; fair plain engraver; know something of watchwork; the south or southern part of Louisiana preferred. Address "O., 6409," care Jewelers' Circular-Weekly.

WATCHMAKER, competent to take full charge of work, will be open for a position in about a week; thoroughly experienced on fine and complicated work; has had charge for a downtown house in New York several years; up-to-date tools. Address "Vanguard, 6415," care Jewelers' Circular-Weekly.

## Side Lines Wanted.

WANTED, by experienced traveling salesman, on commission, a line either of jewelry, combs, silver, watches, or some line for jewelers in west and northwest States. "Commission, 6230," care Jewelers' Circular-Weekly.

WANTED, by the undersigned, line of high grade goods or diamond goods for highest class retail trade of Chicago and outlying towns, on commission; will guarantee results; bank and commercial references. Elmer A. Rich, Room 803, 103 State St., Chicago, Ill.

SIDE LINE, salesman selling a very popular line to the leading jewelers in central states wants another first class line on a commission basis; manufacturers or specialty preferred. "Rapid, 6399," care Jewelers' Circular-Weekly.

## Help Wanted.

WANTED, practical watchmaker; must have good references. S. L. Levy, 483 Main St., Buffalo, N. Y.

WANTED, a watchmaker to go into Michigan. Apply H. F. Hahn & Co., 156 Wabash Ave., Chicago, Ill.

WATCHMAKER; young, single; mail us three years' good references; state wages. Greenleaf & Crosby Co., Jacksonville, Fla.

WANTED, a good engraver and jobbing jeweler; permanent position to the right man; references required. T. Kircher, Davenport, Ia.

AT ONCE, a good engraver, clock and jewelry repairer; steady position to a good man. Address "J., 6367," care Jewelers' Circular-Weekly.

WANTED, manufacturing jeweler and jobber; must be good engraver; only steady, sober man need apply. C. A. Tucker, 1123 O St., Lincoln, Nebr.

WANTED, experienced jewelry salesman for jobbing trade; eastern territory; references required. Address "Z., 6334," care Jewelers' Circular-Weekly.

WANTED, jewelry and clock repairer; good city in New Jersey; permanent and pleasant place; good wages. M. Sickles & Sons, 726 Chestnut St., Philadelphia, Pa.

WANTED, diamond mounters and setters, also jobbing jewelers, permanent positions; good wages. E. Maritz Jewelry Mfg. Co., 217 North 6th St., St. Louis, Mo.

WANTED, a fine engraver and good optician; permanent position; send sample of engraving and reference; salary \$25 per week. Edwards & LeBron, Chattanooga, Tenn.

WANTED, AT ONCE, experienced watchmaker and engraver; permanent position; will pay good salary; send sample of engraving and references. Burt Ramsay, Cleveland, O.

WANTED, WATCHMAKER, young man or old man, for repairing; about 10 watches per week no tools needed; fan in the shop; state price wanted. F. C. Rivoire, Napoleonville, La.

WANTED, by Aug. 1, young and up-to-date jewelry salesman, to accept traveling position; fine opportunity for hustling young man. Address "S., 6387," care Jewelers' Circular-Weekly.

WANTED, a first class jewelry repairer; good wages and steady work guaranteed to the right man; none but steady, sober men need apply. Address "W., 6405," care Jewelers' Circular Weekly.

WANTED, first class traveling jewelry salesman for Missouri and Kansas, principally; must be experienced and well recommended; address in own handwriting. L. Bauman Jewelry Co., St. Louis, Mo.

WANTED, assistant manager; large wholesale house in middle west; young man preferred; fine chance for advancement; watches, diamonds, jewelry, etc. "Chance, 6426," care Jewelers' Circular-Weekly.

FIRST CLASS watchmaker and optician wanted good opportunity offered to right party; steady position; in one of the large cities in Pennsylvania; write at once. L. W. Rubenstein, 5 Maiden Lane, New York.

AN EXPERIENCED cut glass salesman, with a established trade; guaranteed salary to right party; reference required from last employers; give full particulars. Address "Cut Glass, 6412," care Jewelers' Circular-Weekly.

WANTED, watch and clockmaker; must be good pivoter and lathe hand; good chance to improve man about 22 preferred; steady job to right man; state wages expected and send reference. Ransay, 1221 F St. N. W., Washington, D. C.

WANTED by jewelry and watch house salesman for middle west. Address "A. G., 6180," care Jewelers' Circular-Weekly.

BY JEWELER, immediately, experienced clock and jewelry repairer, salesman and assistant watchmaker; good workman; permanent; near Boston; give full experience, references and wages. Address C. E. H., Box 5256, Boston, Mass.

WANTED, AT ONCE, a competent watchmaker plain engraver and jewelry repairer; permanent position; salary, \$20 week; chance of advancement; references and sample of engraving 1 first letter; apply at once. A. Rabinowitz, Stamford, Conn.

WANTED, a first class, competent, experienced and capable retail jewelry salesman; southern man preferred; when making application please state experience, give reference and salary wanted. Apply to the J. J. Sweeney Jewelry Co., Houston, Tex.

WANTED, first class watchmaker and engraver; send sample of engraving and references in first letter, stating salary wanted; give age and experience; steady employment and good wages to the right man. Address Henry Iversen & Co., Corsicana, Tex.

SIDE LINE for experienced salesman, calling on best jewelry trade in New York, Pennsylvania and East; well known; popular 10-K. and 14-K. jewelry line, with big inducements; address with full particulars. "N., 6282," care Jewelers' Circular-Weekly.

WANTED, a first class watchmaker, engraver and jeweler; surroundings pleasant; position permanent; one capable of taking charge of repair department; splendid opening for good man; state age, experience, etc. H. B. Dodge, 42 Mark St., Lynn, Mass.

JEWELER, young man with three to five years experience, repairing and order work; permanent position for bright young man and opportunity to learn fine work; state age, experience, etc., in answer. E. J. Scheer & Co., 144 Main St., Rochester, N. Y.

WATCHMAKER, must be first class and capable workman, experienced and competent to take charge of department; fine trade; largest store in the city; good salary and permanent position; state experience, age, references, etc., and send photo in answer. E. J. Scheer & Co., 144 Main St., Rochester, N. Y.

**HELP WANTED.—Continued.**

WANTED, a good engraver on all general work; must do fine script and monogram work of all kinds, do all hard and soft soldering and general jewelry work, repair clocks and do window trimming; don't particularly care for a watchmaker; correspond at once. Austin & Prescott, Main St., Batavia, N. Y.

WANTED, strictly first class combination man (watchmaker, jeweler and engraver); must be sober and well recommended; good salary and permanent position to good man; must be a willing worker, rapid and very thorough; state salary expected and send sample engraving first letter. Thos. Van Auken & Co., 516 Pearl St., Beaumont, Tex.

THIRTY-FIVE (\$35) DOLLARS per week for a capable, experienced manufacturing jeweler and engraver; one who can do stone setting and enameling. "Capable, 6338," care Jewelers' Circular-Weekly.

ANNOUNCEMENT; on or before June 1, we will make room for a limited number of young beginners, to learn and perfect themselves in the art of practical watch repairing; we train them quicker and with closer attention than the crowded horological schools. For terms or other information apply direct or by letter to Maebert & Reiss, practical and theoretical watchmakers, 71-73 Nassau St., cor. John St., New York.

SALESMAN acquainted with best trade in New York City and Brooklyn to handle well known and advertised line of mountings as side line, on commission. Address, "Mountings, 6413," care Jewelers' Circular-Weekly.

SALESMAN for New York City and vicinity, wanted by well known manufacturer of 10k. gold jewelry; sample stock; must have acquaintance with jewelry and department stores; no objection to good man representing another line; all replies confidential. "Gold, 6418," care Jewelers' Circular-Weekly.

**Business Opportunities.**

OR SALE, old established jewelry business, Brooklyn, N. Y. Inquire E. Dreyer, Materials, 73-75 Nassau St., New York.

OR SALE, jewelry and optical business; northern Ohio; population, 7,000; 10 factories; good farming community; invoice, \$4,500; best reasons for selling. "Ohio, 6393," care Jewelers' Circular-Weekly.

OR SALE, well equipped manufacturing jewelry shop, in rapidly growing western city of 40,000; good machinery; old established place; no competition. Address "F. G., 6347," care Jewelers' Circular-Weekly.

ARTNER WANTED, man about 30, who is well acquainted with the jewelry trade and can invest about \$5,000 in an old established manufacturing jewelry concern of A1 reputation. Address "Maiden Lane, 6228," care Jewelers' Circular-Weekly.

OR SALE, wholesale jewelry business, established five years; incorporated; good opportunity for a man of some experience; death of one of firm cause of selling business; located in St. Louis; address for information. Aug Zeiss, 6817 S. Broadway, St. Louis, Mo.

Will purchase an interest in a retail jewelry business; established, well and favorably known; located in one of the most prosperous cities of 200,000 inhabitants in the United States. Address "Rare Opportunity, 6341," care Jewelers' Circular-Weekly.

DO YOU WISH TO RETIRE? We buy jewelry stores to any amount; also entire stocks of jewelry, diamonds, watches, silverware, fixtures, etc.; we are known all over the United States to pay highest spot cash; notify us, we will call on you at once; all business transacted we handle strictly confidential. Address Brooklyn Purchasing Syndicate, 608 Broadway, Brooklyn, N. Y., or Tel. 2328, Williamsburg.

CHICAGO JEWELRY STORE; good location; established 29 years; owner wishes to retire; stock has been reduced; will invoice, with fixtures and material, about \$4,500 to \$4,800; repairs, \$2,100 yearly; don't write unless you have the cash and mean business. Inquire of Stein & Ellbogen Co., Columbus Memorial Bldg., Chicago, Ill.

QUICK ACTION by corresponding with us; we buy your entire stock; or send us your surplus stock of watches and diamonds; we originated this method and have twenty years of quick action and good service to our credit. Joseph Brown & Co., Fifth Ave. and Madison St., Chicago, Ill.

**To Let.**

DESK ROOM or part of office to let. 3 Maiden Lane, Room 53, New York.

WILL RENT, small and large offices; good north light; manufacturer's representatives or diamond dealer preferred; telephone connection and safe; apply at once. Room 54, 7 Maiden Lane, New York.

PART OF OFFICE to lease; good light; suitable for watchmaker, diamond broker or dealer in precious stones; desk, chairs and shelf furnished. Address "Cockcroft Building, 6246," care Jewelers' Circular-Weekly.

**For Sale.**

FOR SALE, small lot of gold scarfpins and brooches; also plated buttons and studs. "Gold, 6417," care Jewelers' Circular-Weekly.

YORK SAFE CO. jewelers' safe, watches, jewelry, show cases, counters, work bench and tools; store room can be leased; cheap rent; low expense; healthy location. F. H. Hoffer, Carlisle, Pa.

**Wanted to Purchase.**

WANTED TO BUY, drop press with 100 pound hammer and screw press, capable of cutting blanks 1/4 inch thick; must be in first class condition and cheap; give prices. Address "H. A. C., 6383," care Jewelers' Circular-Weekly.

**Legal Notice.**

NOTICE; all firms having accounts against us are requested to send itemized statements of same without delay. The Fleissner Marshall Co., temporary address, 1932 Baker St., San Francisco, Cal.

**Miscellaneous.**

WATCH REPAIRING for the trade; low prices. Paul Friedman, Room 120, 51-53 Maiden Lane, New York.

SOMETHING entirely new in the line of window decoration; send five two-cent stamps for sample and postage. Address The Window Exhibitor Co., 74 Cortlandt St., New York.

**TO LET.**

Three Desirable Light Lofts

At 31 MAIDEN LANE, N. Y.,

One door from Nassau St. Prominent location, center of jewelry district. Address F. J. Whiton, 130 Broadway, New York; or, your own broker.

**Summer Residence for Rent**

during July and August, at Montclair, N. J.; beautifully situated; contains 11 rooms and 2 bath-rooms; handsomely furnished; also use of team of fine horses, 3 carriages, coachman, etc.; unusual opportunity for desirable party. Address "Montclair, 6366," care Jewelers' Circular-Weekly.

**Mother of Pearl Clock.**

SPECIALTY: PEARL WATCHES

Ladies' and Gentlemen's

Nurses' Watches, Repeaters and Chronographs.

Extra flat watches in Gold, Silver, Gold Filled and Gun Metal.

Enameled Watches

of all kinds.

Write us immediately for information if interested in the new season's offerings.

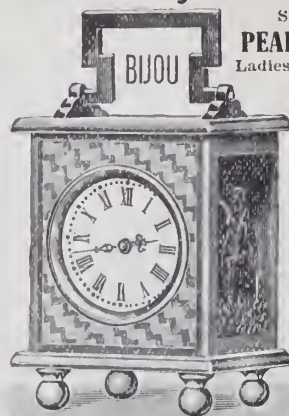

Exact Size—Cylinder and Lever Movement.

**KLIPPER BROS.,**

59 Maiden Lane, NEW YORK.

THE ONLY BOOK OF THE KIND EVER PUBLISHED.

AN ENCYCLOPEDIA-DICTIONARY AND REFERENCE HANDBOOK OF THE OPHTHALMIC SCIENCES.

Designed to Give, in Complete and Accurate Statement, and in the Readiest Form for Popular Use the Orthography, Pronunciation, Meaning and Etymology of All the Words and Terms Used in the Ophthalmic Sciences.

And in Addition to Give in Didactic Form a Complete Treatise on Such Subjects as Demand a Wider and More Elaborate Treatment.

By R. H. KNOWLES, M. D.

PRICE \$2.50

IN SUBSTANTIAL CLOTH BINDING.

PUBLISHED BY THE JEWELERS' CIRCULAR PUBLISHING CO., 11 John St., cor. Broadway, New York.

INDISPENSABLE TO OPTICIANS.

**WORKSHOP NOTES**

(Third Edition)

For Jewelers and Watchmakers.

A collection of the latest practical receipts on the manufacture and repairing of watches, clocks and jewelry.

Price, \$2.50

300 pages (size 7 1/2 x 10 1/4 inches), bound in cloth, stiff covers. Should be on every workbench.

Published by

THE JEWELERS' CIRCULAR PUBLISHING CO.,

11 John St., Cor. Broadway, New York.

# QUALITY COUNTS

## The Increasing Sale of TAVANNES WATCHES

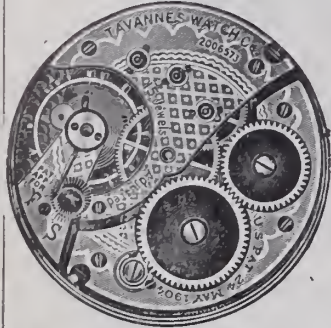

Proves their worth as timekeepers

FULLY GUARANTEED  
For sale through the jobbing trade



**TAVANNES WATCH CO.,**  
2 & 4 Maiden Lane, New York.

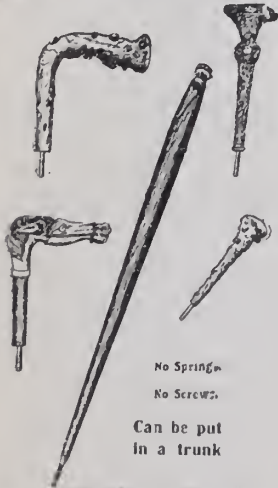

No Springs  
No Screws  
Can be put  
in a trunk

### THE PERFECT SHAPE UMBRELLA "MAIDEN BALTIMORE"

It is now nearing the time when Jewelers are looking toward purchasing their stocks for the Fall and Holiday seasons in Umbrellas and Canes. We are prepared with our line, which we have specially designed for the Jewelry Trade. It consists of rare novelties, and things entirely new and exclusive.

Our Detachable Handle Umbrella has met with great favor, and will increase your Umbrella Business, as it is the only one on the market without levers, springs or screws.  
We make Umbrellas from \$1.50, with Sterling Silver and Gold Handles, up to \$125.00 each, and Canes from 50 cents up to \$25.00 each. *Send for a Selection, Express Paid.*

**SIEGEL, ROTHSCHILD & CO.,** 418-420 West Baltimore St., BALTIMORE, MD.  
NEW YORK SALESROOM 353 Broadway      MAKERS      PHILADELPHIA SALESROOM 1011 Chestnut Street

### LEIMAN'S NEW SAND BLAST.

SIMPLE. EFFECTIVE. ECONOMICAL.

**NEW FEATURES**—Let us tell you about them.  
**RESULTS**—Let us show you samples of work done.

#### Improved High Pressure Blower

NOISELESS. INEXPENSIVE.

Delivers Greater Volume at Higher Pressure Than Any Other Made.

#### LEIMAN BROS.,

Jewelers', Silversmiths' and Metal Workers' Machinery, Tools and WORK BENCHES,

141 Centre Street, NEW YORK.

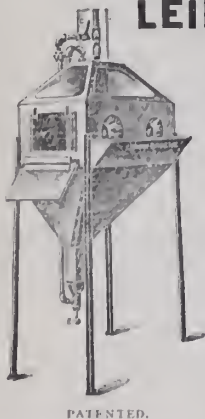

PATENTED.

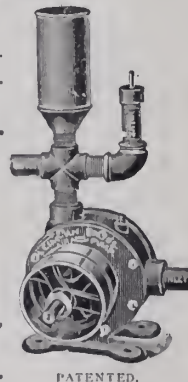

PATENTED.

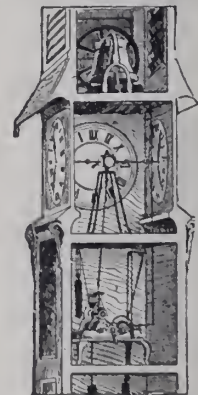

MAKERS OF

### Tower and Street Clock

For particulars write us, mentioning The Jewelers' Circular, We

**E. HOWARD CLOCK CO.,**  
EST. 1842. BOSTON, MASS., U. S.

### TRADE-MARKS

OF THE JEWELRY AND KINDRED TRADES.  
Over 4,000 Marks. Second Edition. Price, \$3.00.  
The Jewelers' Circular Pub. Co., 11 John St., N. Y.

# JOS. NOTERMAN & CO. DIAMONDS

IMPORTERS AND CUTTERS

Recutting and Repairing odd shaped and chipped stones a speciality. Manufacturers of Mountings and Fine Jewelry. Special Designs Furnished.

CINCINNATI, OHIO.



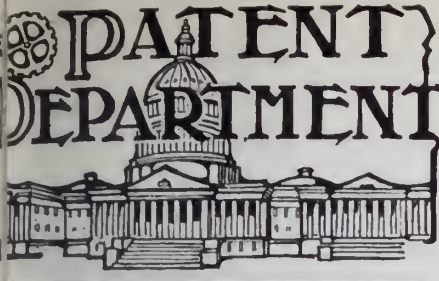

IN WHICH IS CONTAINED A LIST OF THE LATEST PATENTS GRANTED BY THE UNITED STATES AND GREAT BRITAIN, THE UNITED STATES PATENTS THAT HAVE EXPIRED AND THE REGISTERED TRADE-MARKS.]

UNITED STATES PATENTS.

ISSUE OF MAY 22, 1906.

**20,963. BRACELET.** FREDERICK FETTING, Providence, R. I., assignor to the Potter & Buffinton Co. Filed Jan. 5, 1906. Serial No. 294,725.

In a bracelet, two hollow wings, in combination with a tube having a projecting head fixed in one



ing and slotted, of a reinforcing-strip having a projecting upper portion and a lower portion of less breadth than the outer diameter of the tube closely mounted in the tube, and a pivot-pin fixed in the other hollow wing and traversing the head of the tube and the upper end of the reinforcing strip.

**20,998. TELESCOPIC SIGHT FOR FIRE-ARMS.** AMBROSE SWASEY, Cleveland, O., assignor to the Warner & Swasey Co., Cleveland, O. Filed Oct. 10, 1905. Serial No. 282,096.

The combination of a supporting member arranged to be secured to a firearm, a sight device rotatably mounted on the supporting member, a socket portion on the supporting member having a screw-threaded bore, a screw operating in said

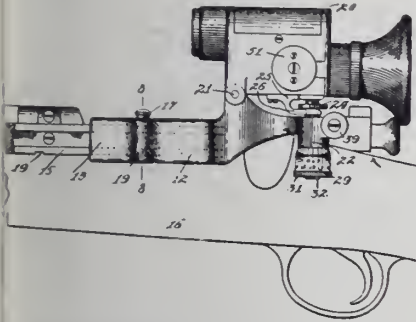

are and engaging the sight device by one extremity, the screw having an annular slot adjacent its end, and an arm secured to the sight device and engaging the screw at said slotted portion.

**21,124. PERCOLATOR.** GEORGE E. SAVAGE, Meriden, Conn., assignor to Manning, Bowman & Co., Meriden, Conn. Filed Aug. 31, 1905. Serial No. 276,524.

In a percolator, a fluid-holding body having an in-

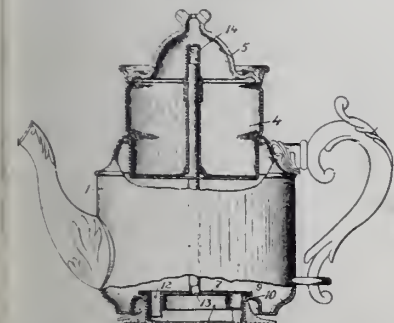

egral bottom portion forming a relatively small heating-chamber at the base, a cover member form-

ing the top of the heating-chamber, a percolator-tube connected to the cover, said cover having an inlet discharging close to the bottom for the passage of fluid from the body to the heating-chamber, and a base with a ring formed separately from the bottom of the heating-chamber and laterally surrounding and secured in intimate contact with the outer side walls, of the heating-chamber and extended horizontally beyond the bottom of the heating-chamber to form an extended base for the percolator and vertically spaced apart from the body of the percolator.

**21,125. PERCOLATOR.** GEORGE E. SAVAGE and JAMES W. CHAPMAN, Meriden, Conn., assignors to Manning, Bowman & Co., Meriden, Conn. Filed Aug. 31, 1905. Serial No. 276,525.

In a percolator, a liquid-reservoir, a receptacle for holding the grounds, a heating-chamber having

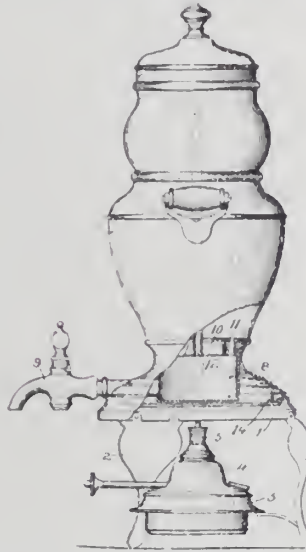

lateral walls exposed to the flame, a cap having an inlet and an outlet, and a base-flange secured at the top of and extending laterally of said chamber

**21,140. SELF-WINDING ELECTRIC CLOCK.** BERNHARD TROPP, New York, assignor to William Henry Laird, New York. Filed July 16, 1904. Serial No. 216,817.

The combination substantially as described of a driving power, a driven mechanism, an electric motor, winding mechanism interposed between the same and the driving power, a primary circuit-closer, comprising a stationary contact member and a co-operating contact member carried by a wheel of the driven mechanism for periodically

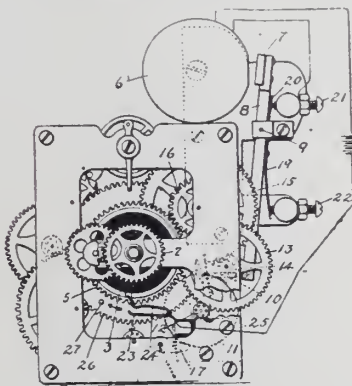

but momentarily closing the circuit of the motor at one point, and a secondary independently-operating circuit-closer comprising a fixed contact member and a co-operating contact member carried by a wheel connected with the winding mechanism.

**21,141. LENS-FINDER FOR CLINICAL THERMOMETERS.** WALDEMAR UDE, St. Louis, Mo., assignor to Johnson & Johnson, New Brunswick, N. J. Filed Dec. 18, 1905. Serial No. 292,246.

The combination with the tube of a thermometer,



of a lens-finder, comprising an opaque member inclosing a portion of the tube of the thermometer

and having an open space for the lens, and having a portion of its sides at a distance from the thermometer-tube to form means for manual engagement.

**21,146. ADVERTISING APPARATUS.** FREDERICK J. WALTON and LONGINUS V. ROGERS, Finchley, England. Filed June 23, 1905. Serial No. 266,620.

In advertising apparatus, the combination with a framework having display-orifices of advertisement-carrying boards, of a chain connection between said boards, pulleys over which such chain con-

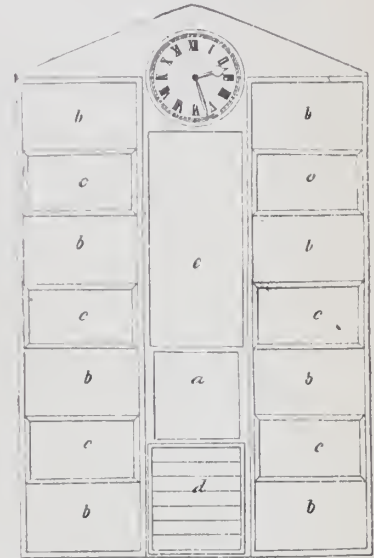

nection runs, a centrally-journaled clockwork-operated lever, a connecting-rod pivoted at one end to one of the advertisement-carrying boards and at the other end to one end of the centrally-journaled clockwork-operated lever, and means for retarding and releasing said lever at predetermined intervals.

**21,320. FOLDING BRUSH.** MELBURN H. TUPPER, Buda, Cal. Filed June 7, 1905. Serial No. 264,048.

In a device of the class described the combination with a substantially box-shaped body having the sides formed of a double thickness with an interior hollow portion, of the cross-pieces extend-



ing into slots formed in the inner portion of said side pieces, bars adapted to slide in between the walls of said hollow sides and support the ends of the pivoted rods, vertically-slotted resiliently-held bars fitting in the hollow portion in the side walls and adapted to coact with the slotted walls to removably retain the pivoted rods in position.

**21,396. JEWEL-PIN AND PALLET-STONE SETTER.** OLE O. AUNE, Waltham, Mass. Filed June 3, 1905. Serial No. 263,546.

A tool comprising grippers for holding a jewel-pin, means for holding a balance in assembling

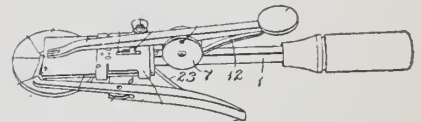

relation to the pin, and a heat-conducting shield in close proximity thereto adapted to receive heat from a flame and to prevent the flame coming into contact with the jewel or any part of the balance.

**21,406. ALCOHOL-BURNER.** JOHN H. ERNST, New York, assignor to Silver & Co., Brooklyn, N. Y. Filed July 15, 1905. Serial No. 269,815.

In an alcohol-burner, the combination with a supporting-tripod of a burner-bowl consisting of two pieces united by a circumferential bead by which the burner is supported in its tripod, the uppermost piece having a flame-orifice, a circumferential bead about its upper edge and a circumferential series of air-admitting holes separated from

each other by interspaces of greater width than the individual holes and located between the two circumferential beads, means for preventing the burner from rotating in the tripod, a band located between and confined in place by said beads and

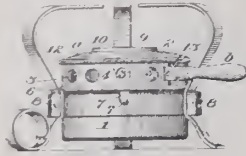

provided with air-holes and interspaces corresponding with said air-holes and interspaces in the upper portion of the bowl, and a handle to which the ends of said band are secured.

**821,445. COFFEE PERCOLATOR.** ALONZO A. WARNER, New Britain, Conn., assignor to Landers, Frary & Clark, New Britain, Conn. Filed Dec. 22, 1905. Serial No. 292,942.

A coffee-percolator comprising a vessel, a pumping-tube and means for forcing the fluid up through the tube when the vessel is properly

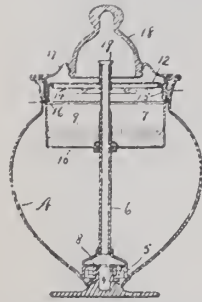

heated, with a cup at the upper part of the said tube and vessel and a retainer for the said cup, the said cup having a suitable strainer for its lower part, an internal retainer-seat and outlets for its upper part, and the said retainer having a screen and a flanged rim fitted to the said cup for forming an annular overflow-space between the said cup and retainer.

**821,545. PUNCH-BOWL.** JOSEPH SIMMS, Detroit, Mich. Filed June 22, 1905. Serial No. 266,502.

A dispensing-receptacle for beverages compris-

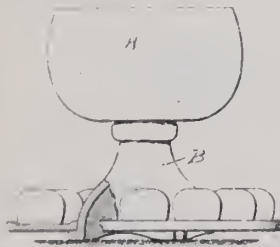

ing the bowl proper in combination with a detachable base-support formed with projecting means at its base, and a detachable annular tray supported on its lower face by said projecting means, substantially as described.

**821,547. BADGE.** NELSON STAFFORD, Brooklyn, N. Y., assignor to the N. Stafford Co., New York. Filed Jan. 16, 1905. Serial No. 241,178.

A badge, name or designation plate, comprising a recessed base-plate, a frame-plate fitting and received in the base-plate, a name-plate received



into the frame-plate and fastening devices connecting the frame-plate and base-plate, concealed by the name-plate, and other devices for connecting the base-plate to an article for support.

DESIGNS.

**38,017. BADGE.** DALLETH Z. MERCHANT, Portsmouth, Va. Filed March 23, 1906. Serial No. 307,726. Term of patent 3 1/2 years.

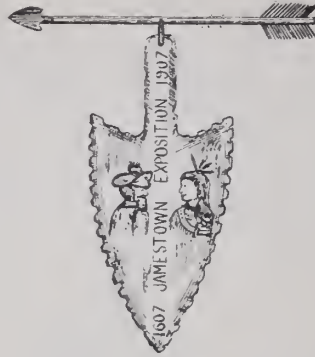

**38,018. HANDLE FOR SPOONS, FORKS OR SIMILAR ARTICLES.** JOHN CLULEE, Wallingford, Conn., assignor to the International



Silver Co., Meriden, Conn. Filed April 9, 1906. Serial No. 310,882. Term of patent 7 years.

**38,019. HANDLE FOR SPOONS, FORKS OR SIMILAR ARTICLES.** JOHN CLULEE, Wallingford, Conn., assignor to the International



Silver Co., Meriden, Conn. Filed April 9, 1906. Serial No. 310,883. Term of patent 7 years.

**38,020. HANDLE FOR SPOONS, FORKS OR SIMILAR ARTICLES.** WILLIAM C. COOMAN, Providence, R. I., assignor to the Gor-



ham Mfg. Co., Providence, R. I. Filed April 12, 1906. Serial No. 311,398. Term of patent 14 years.

**38,021. BACK FOR BRUSHES, MIRRORS OR**



SIMILAR ARTICLES. SIDNEY A. KELLER, New York, assignor to the William H. Saart

Co. Filed April 7, 1906. Serial No. 310,532. Term of patent 3 1/2 years.

**38,022. CLOCK-FRAME.** STANLEY M. LAWSON



Cincinnati, O. Filed April 4, 1906. Ser. No. 309,945. Term of patent 3 1/2 years.

UNITED STATES TRADE-MARKS.

[The following trade-marks have been adjudged entitled to registration under the Act of Feb. 20, 1905, and are published by the Patent Office in compliance with Sec. 6, of said act, which provides "Any person who believes he would be damaged by the registration of a mark may oppose the same by filing notice of opposition, stating the ground therefor, in the Patent Office, within 30 days after the publication of the mark sought to be registered, which said notice of opposition shall be verified by the person filing the same before one of the officers mentioned in Sec. 2, of this act. If no notice of opposition is filed within said time the Commissioner shall issue a certificate of registration therefor, as hereinafter provided for."]

PUBLISHED MAY 22, 1906

SER. No. 11,556. EYEGLASSES, SPECTACLES, OPERA AND FIELD GLASSES, AND FRAMES AND LENSES THEREFOR. GLOBE OPTICAL Co., Boston, Mass. Filed Aug. 11, 1905.



The representation of a globe having thereon the designating prescription-symbol R and scrolls bearing the words, THE HOUSE OF NEW ENGLAND.

SER. No. 11,828. SAFETY-PINS. THE AMERICAN PIN Co., Waterville, Conn. Filed Aug. 19, 1905. Used 10 years.



A red seal with the conventional sign for pure sterling printed thereon in black, associated with the word "STERLING."

SER. No. 13,837. SILVER AND SILVER PLATED HOLLOW WARE, FLAT WARE AND TABLE WARE. HIBBARD, SPENCER BARTLETT & Co., Chicago. Filed Oct. 21, 1905. Used 10 years.



The letters O V B with a panel extending across the same upon which appear the words OUR VERY BEST.

SER. No. 13,865. POCKET AND TABLE

KNIVES, BUTCHERS, BOWIE AND FARRIERS' KNIVES AND RAZORS. GEORGE WOSTENHOLM & SON LTD., Sheffield, Eng., and New York. Filed Oct. 23, 1905.

**I X L**

The letters I X L, arranged in the order given. The I separated from the X L by a star. SER. No. 16,637. WATCH MOVEMENTS AND WATCH CASES. LOUIS MANFIMMER & Bros., Chicago, Ill. Filed Jan. 31, 1906.

**ATLAS**

The word ATLAS. SER. No. 18,387. SAFETY-PINS. THE AMERICAN PIN CO., Waterville, Conn. Filed March 31, 1906.



A solid Greek cross, printed upon a white background.

TRADE-MARKS REGISTERED MAY 22, 1906.

21,839. WATCHES, WATCH CASES, WATCH MOVEMENTS AND PARTS THEREOF. NEW YORK STANDARD WATCH CO., Jersey City, N. J.

The representation of a globe surrounded by clouds and on which is perched an eagle with outstretched wings and having a timepiece suspended in its beak, the globe bearing the words "THE BEST WATCH IN THE WORLD FOR THE MONEY." Filed April 19, 1905. Serial No. 2,271. Published March 27, 1906.

2,840. STERLING-SILVER JEWELRY FOR PERSONAL ADORNMENT. THEODORE W. FOSTER & BRO. CO., Providence, R. I. The letters and character "F. & B." Filed June 9, 1905. Serial No. 7,755. Published March 27, 1906.

2,929. MAINSPRING FOR TIMEPIECES. BENJAMIN ALLEN, Chicago. The letters, character and abbreviation "B A & C" on the diamond-shaped figure. Filed Sept. 7, 1905. Serial No. 12,352. Published March 27, 1906.

2,953. SPECTACLES, EYEGLASSES AND LENSES. A. K. HAWKES, Atlanta, Ga. The representation of two eyes, the word HAWKES, and a scroll being placed between said eyes, and a pair of spectacles located below said eyes and showing on the center of the same a crystal with rays radiating therefrom and the words "CRYSTALIZED LENSES" below the spectacles, the whole being surrounded by a plain border straight at the upper part and curved at the sides and lower part. Used 10 years. Filed Nov. 1, 1905. Serial No. 14,161. Published March 27, 1906.

2,859. WATCHES, WATCH CASES AND WATCH MOVEMENTS. PHILADELPHIA WATCH CASE CO., Riverside, N. J. The word "EXCELSIOR." Filed May 8, 1905. Serial No. 4,595. Published March 27, 1906.

2,989. CLOCKS AND WATCHES. THE WESTERN CLOCK MFG. CO., La Salle, Ill. The letters "O. K." inclosed in quotation-marks. Filed Nov. 9, 1905. Serial No. 14,444. Published March 27, 1906.

**UNITED STATES PATENTS THAT HAVE EXPIRED.**

[Reported especially for THE JEWELERS' CIRCULAR—WEEKLY by R. W. Bishop, Patent Attorney, Washington, D. C.]

Issued May 21, 1889.

3,509. CANDLE-GUARD. HUBERT BOVE, Philadelphia, Pa.

3,511. WATCH CASE PENDANT. W. W. BRADLEY, Newport, Ky., assignor to J. C. Dueber, same place.

3,525. DIAL. M. V. B. ETHRIDGE, Boston,

Mass., assignor of two-thirds to John Swann, New York, and H. E. Waite, West Newton, Mass.

103,591. CHAIN. JAMES INGRAM, Lawrence, Mass.

103,761. NECKTIE-FASTENER. W. H. KRATSE, Chicago.

103,779. WATCH CASE PENDANT. E. C. ROHRER and ISIDORA JOSEPH, Waco, Tex.

103,782. HANDLE FOR TEA OR COFFEE POTS. MICHAEL SELPS, Meriden, Conn., assignor to Manning, Bowman & Co., same place.

103,787. WATCH. O. F. STEDMAN, Ravenna, O.

103,812. CLOCK FRAME. D. A. WIANT, New Bethlehem, Pa.

103,820. WATCH. A. M. VFAKEL, Sellersville, Pa., assignor to Cressman & Veakel, same place.

103,849. STAKING-TOOL. GASPARD MARTEL, Roston, Mass.

Designs issued May 17, 1892, for 14 years.

21,548 and 21,549. WATCH CASES. J. C. DUEBER, Canton, O.

Designs issued May 23, 1899, for 7 years.

30,829. CLOCK FACE. S. P. THRASHER, New Haven, Conn.

30,834. POCKETBOOK. W. H. THURBER, Providence, R. I.

30,859. DISPLAY-BOX. J. F. SIMONS, Philadelphia, Pa.

**BRITISH PATENTS.**

(ABRIDGMENTS OF SPECIFICATIONS 1905, FROM THE Illustrated Official Journal.)

ISSUE OF MAY 9, 1906

152. VEIL FASTENINGS. A. B. PLUMMER, 17 New St., Leicester, Jan. 10.

A clip for veils consists of two triangular metal frames formed with two of their sides coincident, the frames turning about this side as an axis. In Fig. 1, the frames 2 have two sides in common provided with lugs 3 and bearing a pivot pin 4.

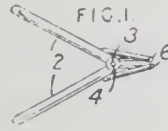

A spring, consisting of a coil of wire, is formed upon the pivot pin, the ends of which are connected to the thumb-pieces 6 which form part of the frames. In use, the frames are opened by pressing the thumb-pieces together, and the veil is passed through the lower frame.

704. MATCH BOXES, ETC. D. INNES, 65 Great Tower St., London, E. C. Jan. 13.

Match-boxes and cigar and cigarette cases are made so that the contents are raised to facilitate removal when the lids are opened. The platform

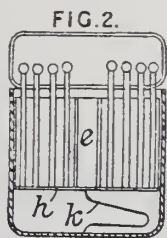

h, Figs. 2 and 4, on which the matches rest, is provided with a back and guides moving in contact with the pocket e, and is raised by the spring k, after the lid has been opened by pressing the button g. When the lid is closed, the spur l depresses the platform. The platform may be provided with clips to hold coins. Reference is made to Specifications No. 3742, A.D. 1874, and Nos. 18,961 and 23,427, A.D. 1893.

708. LENSES. S. D. CHALMERS, Northampton Institute, Clerkenwell, London, E. C. Jan. 13.

The invention relates to improvements in Fresnel's dioptric lenses as used for lighthouses. The

reflecting-surface A B of the prism is made flat instead of curved, the necessary curvature being given to either one or both of the refracting surfaces, A C, B C.

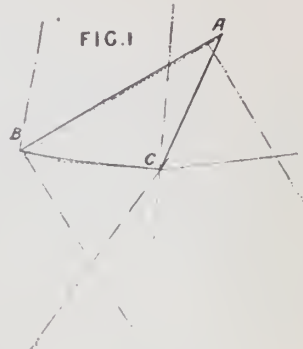

Complete specifications accepted May 2, 1906. 1905.

20,069. BROOCH-FASTENING. GOODE, GOODE & SARJEANT.

20,504. LENS. CHURCHILL.

26,798. CHECK CLOCK. VOGELMANN. 1906.

3,690. PENCIL CASE. PENKALA.

3,069. HAIR WEAVER. MILES. Applications filed April 23 to April 28, 1906.

9,444. MATCH BOX AND ASH TRAY. G. H. ADAMS, Leeds.

9,494. BRACELET-FASTENING. W. J. HUTCHINSON, London.

9,534. MATCH-BOX CIGAR-CUTTER. FRANK SIMMONS, London.

9,554. CHAIN. AUGUSTE KIEHNLE, Manchester.

9,657. PURSE. JACOB BOGDANSKI, Glasgow.

9,668. TIME CHECKING APPARATUS. J. L. CORBETT, London.

9,740. SLEEVE LINKS. STANLEY JOHNSTONE, Birmingham.

9,880. TIME RECORDER. ALFRED VANDELDE, Strand, London.

9,902. CANDLE EXTINGUISHER. G. S. STEVENSON, London.

9,917. FOLDING BUTTON HOOK AND SHOE HORN. A. A. GREEN, London.

9,918. FOLDING SHOE HORN, BUTTON HOOK AND POLISH HOLDER. A. A. GREEN, London.

9,974. TIME RECORDER. T. J. HEWITT and C. J. HEWITT, Liverpool.

**Precious Stones in Madagascar.**

CONSUL HUNT reports from Tamatave that the probability of the existence of many rich deposits of precious stones in Madagascar has caused the government of the colony to employ an expert geologist to make a report on the situation there. He has already commenced operations in the district between Ambatolampy and Antsirabe, where he has discovered zircons, garnets, sapphires, beryls of various hues, and tourmalines.

Mr. Hunt will make an analysis of these specimens and render a report with regard to their commercial value.

Hitchcock & Gohl, Springfield, Mass., were among the plaintiffs who recently preferred charges against Chas. G. Bruffee, who was arraigned about a week ago in the criminal sitting of the Superior Court. From the opticians, Bruffee is alleged to have stolen five pairs of opera glasses valued at \$10 each, and two telescopes valued at \$4 each. Bruffee, in his defense, pleaded an alibi.

# WALTHAM WATCHES

---

We beg to announce the issuing of the following described 16 size movements:

## 16 SIZE, $\frac{3}{4}$ PLATE, S. W. MOVEMENTS

LEVER SETTING

OPEN FACE.

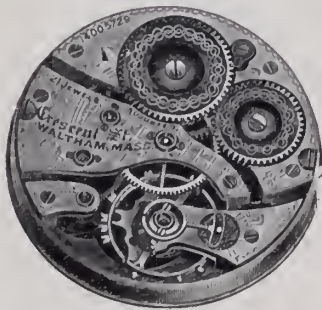

Crescent St., Nickel;

21 Fine Ruby Jewels; Raised Gold Settings; Jewel Pin Set without Shellac; Double Roller Escapement; Steel Escape Wheel; Exposed Sapphire Pallets; Compensating Balance, Adjusted to Temperature, Isochronism and Five Positions; Patent Breguet Hairspring, Hardened and Tempered in Form; Patent Micrometric Regulator; Tempered Steel Safety Barrel; Exposed Winding Wheels; Double Sunk Dial.

---

**AMERICAN WALTHAM WATCH CO.,**

**WALTHAM. MASS.**

# THE HOROLOGICAL REVIEW.



## The Making of Clock Cords.

Translated expressly for THE JEWELERS' CIRCULAR WEEKLY from the *Revue Internationale de l'Horlogerie.*

IN treating of parachutes we called attention to the importance of clock cords and to the serious consequences that their breakage may entail; it now seems inter-

fitted with a certain number of bobbins—as many as the strand is to have wires. These wires unwind themselves simultaneously, and when all have reached a certain point they twist themselves up into a spiral shape, the progress of this operation being regulated as desired.

Fig. 1 shows a simple machine of this character with 12 bobbins, each one of

tandem. It is composed of four parts arranged, respectively, for six, 12, 18 and 24 bobbins, that is to say, a total of 61 bobbins, counting the hemp core advancing through the central tube, which passes from one end to the other of the machine.

The tandem machine is adapted for the making of strands of a variable number of wires, thus, in using only the six bobbins at the left of that which is seen in Fig. 3 one can make a strand of seven wires, the seventh wire of which serves as core coming out of the single bobbin that one sees on the left of the illustration. In using the 12 bobbins of the second section one can make strands of 13 wires. The third section gives strands of 19 wires, and the fourth, strands of 25 wires. By coupling one section with another or two others, one obtains strands of other arrangements.

The machine shown in Fig. 4 is more complicated. It is the reunion of the two modes of manufacture, hence its name, the compound machine. It carries 42 bobbins of metallic wire, and produces at the finish a cable composed of six strands, of seven wires. This is the type of clock cables of which we are treating in this article.

The six bobbins at the left are provided

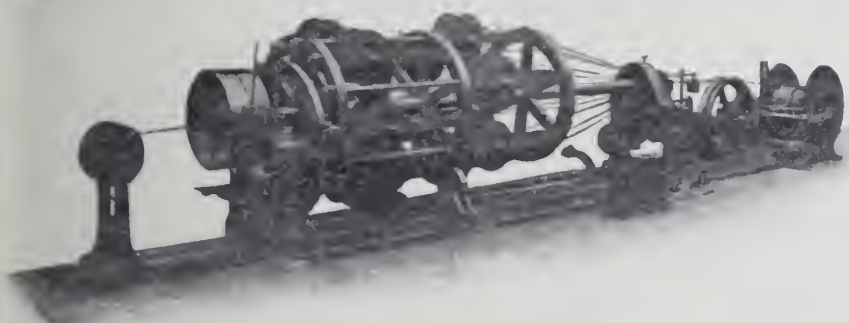

FIG. 1.

esting to say something of their fabrication and their composition.

The diameters used in metallic cords for use in tower clocks are limited between one millimeter and a half and eight millimeters. The cords may be of iron or of steel; the iron cords present greater resistance to breakage, particularly in the large sizes.

Let us call attention to the fact that a clock cord is submitted to other causes of deterioration than the carrying of the weight. Among the principal of these causes is that of the successive shocks which the cord receives and which do not occur by continuous movement, but by jolts, at the moments when the clocks strike and when the running of the clock causes the cable to unwind.

Although in principle the manufacture of these cables does not appear to show any mechanical difficulty, nevertheless special machines of large proportions are required. Illustrated herewith are some types of these machines from drawings which have been kindly sent us by Thos. Barraclough, of London, Eng., a specialist in this line. The cord, properly speaking, is composed of a number of strands with a central core of hemp. Their manufacture consists of two distinct operations: the setting up of the strands and the joining of these strands with the core in a cable.

A machine for making the strands is

which can take more than 60 kilos of metallic wire, representing in one piece a strand of 720 kilos in weight. Fig. 2 shows a ma-

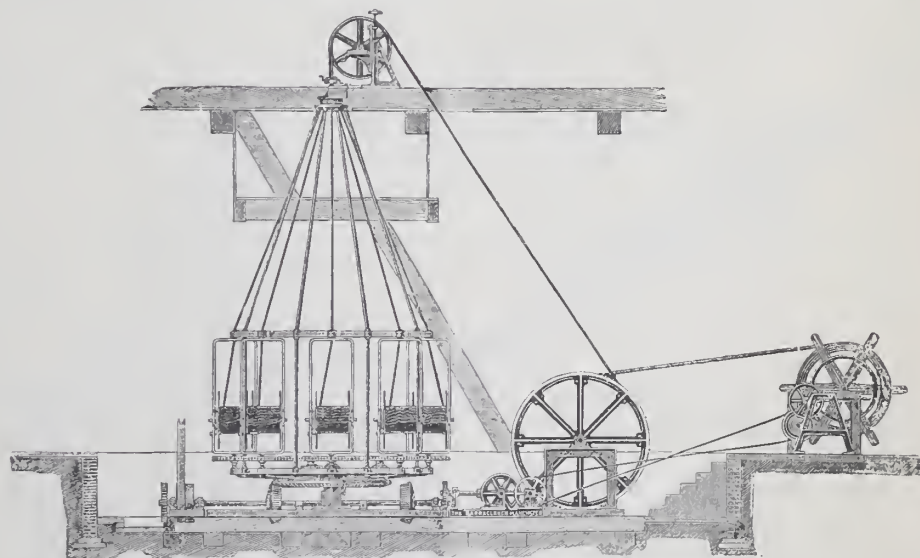

FIG. 2.

chine for cabling eight strands of the preceding machine. Each of the bobbins can take 1,000 kilos of the stranding wire. Fig. 3 represents a stranding machine set up

with the six wires destined to form the center of the six strands. The 36 following bobbins, divided into two groups in the illustration, represent the six series of six



*Time  
O my friend  
is money!*

—BULWER-LYTTON.

And in this money making age there is an enormous and increasing demand for accurate timekeepers. This means that time is money for the dealer who carries a stock of

# ELGIN Watches

See Jobbers' list for prices or write the Company.

Every dealer is invited to send for the Elgin Art Booklet, "Timemakers and Timekeepers," illustrating the history and development of the watch.

## ELGIN NATIONAL WATCH COMPANY

Factories, ELGIN, Illinois, U. S. A.  
General Offices, 131 Wabash Ave., Chicago.

NEW YORK OFFICE, 11 John Street.  
SAN FRANCISCO OFFICE, 206 Kearny St.



wires which are to twist themselves around the six central wires. The core of the cord comes from the left, passing as usual through the central tube which runs from one end to the other of the machine. This machine is highly interesting, for all its movements and its arrangements are combined in such a way as to obtain absolute precision. In each strand the enwrapping may be more or less tightly twisted, as desired, the angle under which the wires present themselves to the direction of the central wire being subject to modification. Before proceeding to twist itself around the temp core of the cable, each strand goes through a sort of spinning chamber, or rope walk, which secures its perfect regularity. A roller guide conducts it afterward to the several terminal spinning chambers, which surround the core.

These spinning chambers are so arranged that the adjustable pressure by means of

The bobbins are of two meters in diameter and each one of them may be loaded with 8,000 kilos of wire. This permits the manufacture, in one piece, of a cord of 48,000 kilos. Taking, in conclusion, an example relating to clock work, we must note that a cord of five millimeters in diameter is a very current type, weighing about 65 grammes to the meter and composed of 42 divisions.

Let us suppose that a cable was manufactured by the capacity of these machines of only the limited diameter of eight millimeters. Every bobbin can hold 25 kilos of wire, which would be a total weight of 1,050 kilos, which would represent a length of 16,000 meters in one piece and without a splice. With these colossal figures we are indeed far from those small pieces, so fine and delicate that one asks oneself what fairy fingers could have fashioned them, and which hold the record for smallness at

**Some Experiments Recently Made With a Seconds Pendulum.**

(A paper read to members of the Municipal School of Technology by T. D. WRIGHT.)

THE subject of this paper was suggested by a long series of experiments with a regulator made in our own workshop for the purpose of testing the value of Dr. Guillaume's nickel steel alloy for the rods of compensation pendulums.

The alloy is commercially known as "Invar," suggesting invariability. I am sorry to admit that my specimen has not justified its claim to the title. I commenced the experiments with quite an earnest confidence that a material had been discovered which would be invaluable to the clockmaker, but have been disappointed.

As I have only experimented with one rod the results must not be taken as conclusive, the more so as in the course of

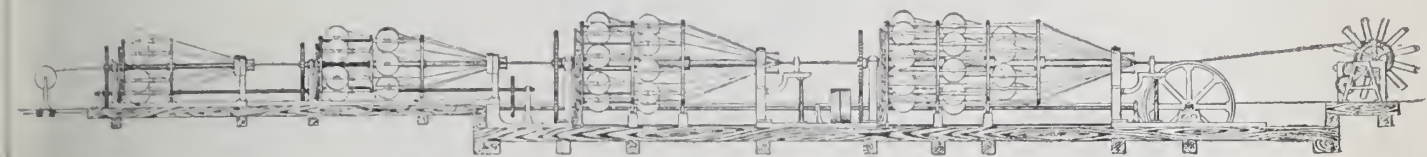

FIG. 3.

prings permits the production of cables of various diameters. They are also movable in the horizontal direction, that they may give to the cable the suitable twist. After having made several turns on a moving drum of about 1.50 meters in diameter, the completed cable passes between two compressing rollers, which fix the necessary tension. It then proceeds to twist itself on bobbins or reels which serve as its vehicle toward the demand.

The movements of the various parts of the machine are harmonized in such a way that each bobbin turns in the proper direction. Its working can also be reversed in order that the twisting of the wires of the strands, and on the other hand, that of the strands around the cable, may be made in the right direction (that is to say, in the contrary direction, one to the other), or in the same direction of both.

The machines for making metallic cables are very extensive, as may be seen by the few figures given relating to the weight of wire for the bobbins. We complete these figures by giving some others.

The central tube of the compound machine, which we have been discussing, measures no less than 5.50 meters in length. It may be adjusted to produce strands having as many as 19 wires each. The machines of the style seen in Fig. 2 will serve to make a cable with strands which reach even greater dimensions. It is true that cables are made there which are very different from those which are intended for the use of clocks. The most powerful model with six bobbins, occupies a space of 14 meters by 6, without counting the place reserved for the storing reels which one sees on the right.\*

\*This space requirement is far surpassed by the largest of the strand machines, which measures 22 meters in length. As regards the tandem machine, length space requirement is 37½ meters by more than three meters in width.

the other end for the clock-making industry. But is it not the prerogative of this marvelous branch of mechanical art to lead us on from surprise to surprise?

**Another Historical Clock.**

IN the possession of August E. Weinert, 3607 Graceland Ave., Indianapolis, Ind., is a bronze clock, gilded, to which is attached a history. The clock was made in France and is a beautiful piece of art work. It stands upon a bronze base four and a half inches high, and beside the clock on the same base is a full length figure of George Washington, in regimental attire, one arm resting upon the clock. In one hand he holds a scroll; the other hand is

the experiments it was found that other factors than the temperature error affected the rate. I wish particularly to draw your attention to the influence of the isochronism of the vibrations of different dimensions of the pendulum spring, and to the effect of change of temperature on the arc of vibration.

You are all probably aware of the general principle of compensation pendulums. When the temperature is raised, the rod, if made of any ordinary material, lengthens, carrying the rating nut away from the suspension; on the rating nut, in this type of pendulum, is supported a tube of some material having a greater expansion than the rod for the same change of temperature: on the top of this tube rests the

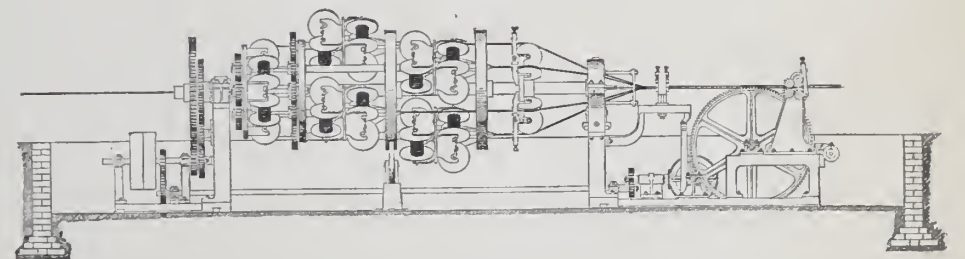

FIG. 4.

at his side resting upon a sword. This figure, of solid bronze, is 10 inches high.

Surmounting the clock is a bronze eagle with spread wings. Below the clock is the inscription, "First in War, First in Peace, First in the Hearts of His Countrymen." Across the front of the base in bas-relief is a symbolic scene representing Washington returning to the pursuits of peace.

The tradition that goes with this piece of French art is that the clock was presented to Washington; that afterward it came into the possession of some member of the family of Henry Clay, and later, after the Civil War, was sold.

bob, supported at, or near, its center of gravity. The expansion and contraction of the bob so supported has little or no effect on the time length, and if the relative lengths of the rod and compensating tube are inversely as their respective coefficients of expansion, the time length of the pendulum, i.e., the distance between its centers of oscillation and suspension, will remain constant in all temperatures. If, for instance, ordinary steel expands 12 times as much as nickel steel, we must employ one inch of steel tube for every foot of nickel steel in the whole rod.

My pendulum has a round "Invar" rod

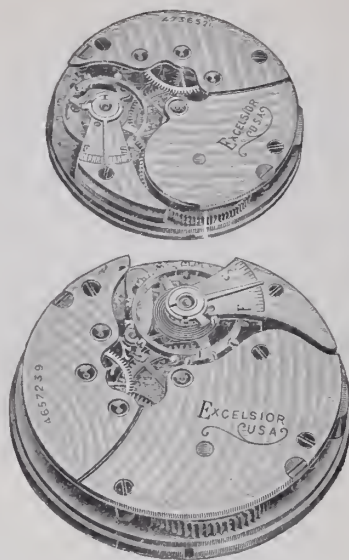

# “THE EXCELSIOR”

in 18 and 6 Size— $\frac{3}{4}$  Plate  
Hunting or Open Face

A New American Made Thin Model  
Made for the Jewelry Trade Only

PRICE PROTECTED

18 Size—Hunting—Lever Set  
18 Size—Open Face—Pendant Set  
6 Size—Hunting or O. F.—Pendant Set

Nickel Damascened 7 Jewels, Stem Wind, Cut Expansion Balance,  
Breguet Hair Spring, White Enamelled Dial

“THE EXCELSIOR” fills a long felt want for a reliable  
time-keeping movement whose price is absolutely protected

SECURE CONFIDENTIAL LIST FROM YOUR JOBBER





### “THE VOGUE,”

As the name implies, is the newest and latest of

# KEYSTONE SOLID GOLD WATCH CASES

¶ This New Model Case is the Thinnest and Most Compact Case made for an American movement.

¶ Standard 12 size Open-Face movements can be fitted into this case with ease.

¶ Flush Joint—made in 12 size Queen only.

KEYSTONE 14 K. SOLID GOLD CASES ASSAY  
585 THOUSANDTHS FINE

Trade Mark



in back

14 K. GOLD ASSAYS 583 THOUSANDTHS FINE

Note this warranty



in cap

## The Keystone Watch Case Co.

Philadelphia

New York  
Chicago

Cincinnati  
San Francisco

Over 3,000 different effects are now being presented to the jobbers in the NEW FALL LINE OF ATTRACTIVE PATTERNS. The best and most comprehensive line ever displayed anywhere.

# Let us be Partners

We are advertising the New England Watch to one third of the population of the United States. Next Fall this advertising is going to create a public awakening; is going to cumulatively force business for the Fall and Christmas season, and now, Mr. Jeweler, we want you for a full partner.

Thousands of convinced people are already writing us asking where they can buy the New England Watches. We don't sell to consumers and so we want you to make these sales. We want to refer these inquiries to you, and you get the profits—you make just so many new customers.

We are in earnest about this partnership plan. Your interests are our interests and we are going to work with you and for you. We are sending out men to find out just how we can help the jewelers. We are going to carry out an extensive plan of co-operation with you.

How can we assist you? What can we do to make our partnership more profitable? Write us your suggestions and get the details of our plan.

The New England Watch occupies a field all its own, Mr. Jeweler. It is built distinctly for the general public and advertising is going to make—is making—it the favorite watch of the Great American People.

A letter asking us for our plans will be a letter written in the interest of increased business. Better write it NOW.

## Special Offer To the Jewelry Trade

Commencing May 1, 1906, we withdrew from our price lists enameled watches heretofore shown in lists and catalogues under series "S" (ELF) styles. To clear our stock of enamels in the 10 ligne series "S" (ELF) watches, we offer a rearrangement of this style by substituting our new 4-jewel "SS" movement in place of the 12-jewel "S" movement previously used in this watch. This new movement is a superior time keeper, and it is fully guaranteed. We have a limited stock of the following colors, but guarantee no patterns:

Red, Blue, Green, Electric Blue, Mauve, Turquoise, Pearl, Violet, Black, Miscellaneous.

These cases and colorings are the same as formerly, and all with swivel pendants.

We reduce prices as follows:

Series SS (ELF) Enamel Watches, each, \$7.00.

Series SS (ELF) Enamel Watch, with Fleur-de-lis Brooch, enameled, and box, \$8.00.

No quantity guaranteed, but will be sold at these prices until stock is exhausted.

Can be obtained at Factory, Offices or Distributing Agents.

## The Cowboy



The very latest in a strong, finely finished watch.

Open face, nickel silver, screw case. Stem wind and set. Six-jeweled movement.

Flat parallel crystals; 10-karat gold filled crystal ring, and gold filled crown.

In every way a desirable time piece, durable and stylish.

Trade Price,  
\$3.00

Retail Price,  
\$5.00



Address DEPARTMENT OF PUBLICITY,

# NEW ENGLAND WATCH CO.,

WATERBURY, CONN.

mm. in diameter (about 5-16ths of an inch). The tube is of mild steel, with a bore large enough to pass freely over the rod, and an outside diameter of half an inch.

The bob is a pair of steel cylinders, each 1 in. long and 2 in. in diameter, connected by a short stout steel cross-bar firmly screwed into each, leaving a space of about three-quarters of an inch between the cylinders, so that there is no danger of the compensating tube touching either of them. The under side of the cross-bar, resting on top of the tube, is at about the center of gravity of the bob.

The weight of the bob is 11 lb 2 oz. The weight of the whole pendulum is 15 lb 8 oz.

As it was desirable to have the rating cut below the bottom of the bob, our first suspension spring was made 1 in. long on top piece to collar; the collar on top rod, in which the lower end of spring was fixed, was made of brass about 1 in. long. Estimating that it would need fully 1 in. of the mild steel tube to compensate the spring and collar, there remained 2 in. of rod upwards, if required, to compensate the nickel steel rod.

The spring was of tempered steel 1 in. long, 1/2 in. wide, and .011 in. thick. I expected to have the bob supported at its center of gravity because, so long as that point remained at a constant distance from the center of suspension, the two main factors affecting the rate of vibration—the driving moment of the bob about the suspension, and the moment of inertia of the bob (considered as a particle) about the same point—would remain constant. I recognized that any increase of temperature, by increasing the dimensions of the bob, must increase the moment of inertia of the bob about its own center of gravity, and that this would tend to make the rate slower in higher temperatures; and that the greater heat would also increase the driving moments, and the moments of inertia of the rod, the compensating tube and the rating nut.

Dr. Bryant had made a series of calculations to determine the true point of support, and later, W. N. Barber contributed an article to the *Horological Journal* (see February, March, April, 1905), dealing in an exhaustive manner with the subject. As will be seen by Mr. Barber's paper the subject is an exceedingly complex one, in which the exact value of all the factors involved cannot be accurately estimated. The difficulty is increased by the fact that we are never sure that two specimens of similar material will have precisely equal co-efficients of expansion.

I reasoned that in the first place the effect of these subsidiary moments was comparatively small, that it would only be necessary to have a slightly longer compensating tube to experimentally adjust the compensation for any two given temperatures and that the error, at intermediate temperatures would then be very small indeed. Anyway, if it should be significant, it would be possible to measure it.

The regular has a Graham escapement with jeweled pallets, and the escape wheel

and verge holes are jeweled. A first grade "Invar" rod was obtained from Agar Baugh, and the experiments were commenced in March, 1904. Mr. Baugh did not know the exact co-efficient of the rod, but thought it might safely be taken as less than .000001 per 1 deg. C. It had been through the annealing process considered necessary to "set" the alloy. If it should prove to have as large an expansion as the above the 4 1/2 in. of tube we started with would be insufficient, but we thought it would do, as we could remove the brass collar, if necessary, and substitute a nickel steel one, and could use a nickel steel spring if required. The case is a plain one made for experimental purposes, and although not really airtight it fits well, so that a light will not burn in it when the door is closed.

The lower end of rod was cut in a screw-cutting lathe with 50 threads to the inch, and the nut is divided into 60 equal parts, so that three divisions equal 1-1,000th of an inch. In rapidly obtaining an approximate regulation it is well to remember that one turn of the nut upwards has more effect than one turn downwards, and it is also convenient to know that, with a seconds pendulum, a difference in length of 1-1,000th of an inch produces, almost exactly, a difference in rate of 1 second per day.

The temperature experiments were commenced by placing spirit lamps in the case, but as the door had to be left open a little way to keep the lamps alight, the temperature was variable and air currents were set up disturbing the arc and causing irregularities. It was quite evident, however, that the clock was gaining in the higher temperatures. The natural changes of temperature in the room were too small to give us much information. During this time we varied the arc of vibration by using different weights, and observed the effects on the isochronism. With a weight of 8 lb. and an arc of 4.8 deg. the rate was nearly six seconds per day slower than with a light weight, and an arc of 3 deg. We removed the spring and substituted one 1/2 in. long and .005 in. thick. As Arthur Webb and Thomas Hewitt had clearly impressed upon me the value attached by the older makers to the isochronal hole in the pendulum spring, I made one in this, although I did not find that modern makers adopted it. The hole was nearly .25 in. diameter, and was to be opened oval upwards or downwards to quicken or retard the rate in the long arcs. When set going we found the long arcs now one second per day *faster* than the short ones.

At the time of the August Bank Holiday, as the room would be unoccupied for three days, I shut it up and heated it with an anthracite stove, maintaining a fairly even temperature from 80 deg. to 90 deg. for the whole time. During this time the clock went more than two seconds per day faster than at the normal temperature of about 70 deg. F., although I had shortened the tube to 4.2 in., so that the nut was only well free of bottom of bob. Did the "Invar" rod actually contract in higher temperatures?

A hot water circulator suggested by Mr. Morrison was now fitted. A long brass

tube 2 1/4 in. in diameter was fixed inside the case, reaching nearly to the bottom, and passing out through the top. Two unions were fitted to the tube, one a little below case top, the other nearly at the bottom. A sealed copper tank was fitted outside the clock below both unions. From the upper union a pipe passed into the top of the tank and terminated there, from the lower one a pipe passed into the tank terminating about an inch from the bottom. The cistern was heated by a Bunsen gas jet, and a constant temperature of about 90 deg. F. could be maintained for weeks.

The greatest variation did not exceed 1 deg., unless we allowed the water to evaporate below the level of the top joint, and thus stop the circulation. When the water tube reached 150 deg., the case was about 90 deg. The daily evaporation amounts to several inches, and we found it best to refill with hot water of about the same temperature as that of the tube, as there was less tendency to "spit." In first filling with cold water we were troubled a good deal by the spitting as the temperature rose and unless the top of case is watertight there may be trouble. It is also necessary to make ample allowance for the expansion of the water. On one occasion we filled the tube too full, and when the water got hot it ran over the top, found its way inside into the movement, so that we were compelled, there and then, to take it to pieces and clean it. We then soldered an elbow on the tube, carrying the outlet away from the case altogether, and had no further trouble of the kind. The additional tubing also allowed us a much larger margin for evaporation, so that it was only necessary to refill at intervals of three or four days.

About this time the pendulum, which had been lent for demonstration purposes at a conversazione at the Northampton Institute, had its spring buckled. A new one of the same dimensions was made, but as the top piece was rather small and slight, I made a new larger and stouter one. This embraced more of the spring, and the new acting dimensions were now .39 of an inch long, .62 wide, and .005 thick, with the similar hole in the center. As might have been expected this alteration made the long arcs still faster.

(To be continued.)

### Horological Notes.

ONE of the most curious clocks in the world, says the *Engineer*, is said to be that which tells the time to the inhabitants of an American backwood town. The machinery, which includes nothing but a dial, hands and lever, is connected with a geyser, which shoots out an immense column of hot water every 38 seconds. This spouting never varies to the tenth of a second. Every time the water spouts up it strikes the lever and moves the hands forward 38 seconds.

An immense new clock sold by E. White, Rutland, Vt., was installed recently in the new town hall at Wallingford. The time-piece has four dials, each six feet in diameter, and a pendulum nine feet long. It will strike a bell weighing 2,500 pounds.

A new town clock, the gift of George H. Catlin, Scranton, Pa., has just been erected in Shoreham, Vt.

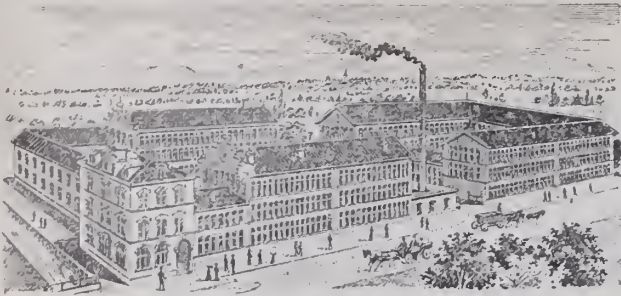

This illustration shows our main factory exactly as it exists, where 3,000 complete watches are made daily.

# LANGENDORF WATCH CO.

CHAUX-DE-FONDS, SWITZERLAND.

It will be of great interest to every jeweler to learn that we are devoting our full attention to this market. The existing conditions in the watch trade have convinced us that there is a long felt want for moderate priced, but accurate Swiss Watches.

We wish to call your attention to our LONVILLE MOVEMENT. It has a lever escapement and is being made in Os, 12s and 16s, fitting perfectly all American cases. This movement is salable and profitable. Our Watches and Movements will be introduced in this market bearing the following names:

- |          |          |
|----------|----------|
| SOLDALE  | HIGHMERE |
| BONDALE  | LONVILLE |
| CLAREFAX | NAMTOC   |
| PEARLHAM | LADY MAY |

SOLE AGENTS FOR UNITED STATES,

**BYRON L. STRASBURGER & CO.,**  
17 Maiden Lane, New York, N. Y.

## SECURE Your Agency NOW!

One in each locality. For the Unexcelled

## NARDIN WATCHES and CHRONOMETERS.

Plain and Complicated Watches in all Grades.

General Agent

**R. NEWBURGH,**

12-16 John Street, NEW YORK.

## 46 out of 99 PRIZES

were awarded to

## PATEK, PHILIPPE & CO.

In the Timing Contest of the Astronomical Observatory in Geneva, for the year 1905, comprising: The only First Unique Prize for Best Average Running; 2 First Prizes out of 3; 5 Second Prizes out of 10; 8 Third Prizes out of 18; 9 Fourth Prizes out of 24; 10 Honorable Mentions out of 23; 11 Simple Mentions out of 21. 11 Manufacturers participated.

68 NASSAU ST., NEW YORK.

GENEVA, SWITZERLAND.

**JULES JÜRGENSEN**  
Watches and Chronometers

PARIS "THE GRAND PRIX" - 1900

SOLE

RUDOLPH & SNEDEKER,  
65 Nassau St., New York

AGENTS

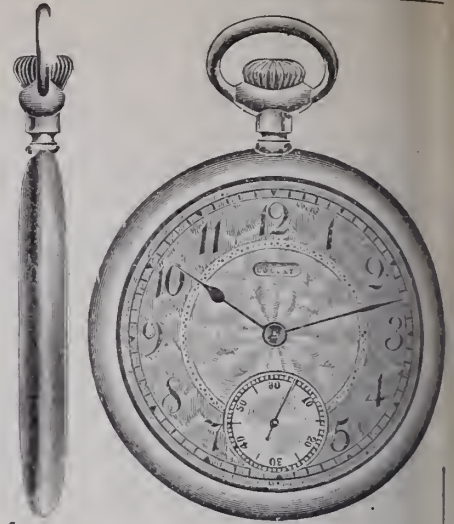

Actual Size.

# LOCUST

Extra Thin Model,

SEVEN JEWEL,  
LEVER,  
PENDANT SET,

CASED IN

## Fahys Bassine 20 Year Filled

Screw Back and Bezel,  
also in  
Silver, Gun Metal  
and  
Solid Nickel Case.

BEST VALUE EVER OFFERED.

TRY THEM.

WE GUARANTEE EVERY  
LOCUST WATCH.

All Parts Interchangeable.  
Finished Material Always on Hand.

IF YOUR JOBBER CANNOT  
SUPPLY YOU,  
WRITE US.

**Hipp. Didisheim & Bro.,**

49 Malden Lane,  
New York.

Chicago Office, - Columbus Bldg.



# ZENITH

## MOVEMENTS

Give the

**RIGHT TIME  
EVERY TIME  
For a LIFE TIME**

**Grand Prize, Paris Exposition, 1900**

Made in O size, 12 size, 16 size, all grades  
Hunting or Open Face, Pendant Set

INTRODUCED FOR THE FIRST TIME IN AMERICA, THOUGH ONE OF  
THE BEST KNOWN WATCHES IN EUROPE FOR GENERATIONS

Manufactured by

**GEORGES FAVRE-JACOT & CO., Locle, Switzerland**

HIPP. DIDISHEIM & BRO., Sole Agents, { 49 MAIDEN LANE, NEW YORK.  
COLUMBUS BUILDING, CHICAGO.

# OMEGA

MOVEMENTS ARE FINE TIME PIECES.

All made with Lever Escapements and Double Roller.  
Pendant Set. Fitting American Cases.

Made in 6 Different Grades.

10 LIGNE. 11 LIGNE. 0 SIZE. 12 SIZE. 16 SIZE.  
From 7 Jewels to 21 Jewels,  
Adjusted to heat and cold and 5 positions.

*Why is it so many  
watch movements  
are sold under the  
plea that they are  
just as good as the  
Omega? There  
must be a reason.*

PRICES NOT ADVERTISED IN ANY JOURNAL.

A Trial will convince you of their merits. Send for price list.

SELLING AGENTS:

**EDMOND E. ROBERT, CROSS & BEGUELIN,**  
3 MAIDEN LANE, 17 MAIDEN LANE,  
NEW YORK. NEW YORK.



For **BEAUTY** of **DESIGN**, **PERFECTION** of **FINISH** and **RELIABILITY** Combined with **Moderate Price**

# TRENTON WATCHES ARE UNEQUALLED



No. 140. Bridge Model, 16 Size, 15 Jewel, Hunting and Open-Face, Pendant Setting.

A sample line is convincing. They are pendant setting in all sizes, fitting regular pendant setting cases, decorated dials and Louis XV hands.

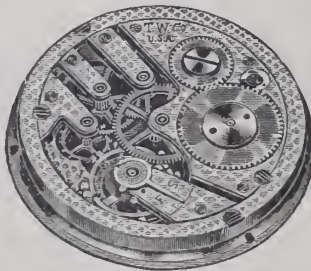

No. 320. Bridge Model, 12 Size, 7 Jewel, Hunting and Open-Face, Pendant Setting.

A NEAT SIGN OR ADVERTISING BOOKLET FOR THE ASKING



No. 100. Bridge Model, 0 Size, 7 Jewel, Hunting and Open-Face, Pendant Setting.

JOBBER SELL TRENTONS.

PRICE LIST ON APPLICATION.

Manufactured and Guaranteed by

**Trenton Watch Co., - Trenton, New Jersey.**

## SETH THOMAS CLOCK COMPANY.

Established 1813.

### MODENA.

Mahogany Case, with Marqueterie. Convex Poreclain Dial. Convex Beveled Glass.



8 Day

Half-hour Strike. Cathedral Bell. Height, 12 Inches.

List, \$15.00.

**SETH THOMAS CLOCK COMPANY,**  
51 Maiden Lane, New York. 70 Wabash Avenue, Chicago.

IF IT'S A

# ROY

TRADE MARK  
IT'S STANDARD



O Size Bassine Engraved Cases, made from assayed Gold, quality as stamped.

**ROY WATCH CASE COMPANY,**



21-23 Maiden Lane, NEW YORK.

SAN FRANCISCO. LONDON, ENG.

# PROSPERITY AND WATCH BUYING

**W**HILE THE WATCH as a staple necessity is always in demand, still sales are augmented in volume and value in periods of prosperity.

The present era of prosperity justifies optimism on the part of the Trade. Very little effort should suffice to increase your Watch business.

These offices, being Watch centers, encourage development in these lines in view of firm confidence in prevailing prosperity.

## J. W. FORSINGER,

LEADING AMERICAN WATCHES AND MOVEMENTS

CHICAGO  
103 STATE ST.

NEW YORK  
2 MAIDEN LANE

## Sessions Clocks

Superior finish. Reasonable prices.

Have you seen our

**New and Exclusive Designs**  
in Mantel and Hanging Clocks?

Write for Catalog and supplement.

**The Sessions Clock Co.**

Main Office and Factories,

Forestville, Connecticut, U. S. A.

New York Salesrooms,

37 Maiden Lane.



WHOLESALE

# DUEBER-HAMPDEN COMPLETE WATCHES

The conceded friend makers for the retail dealer. We are certain that we can help you make customers if you will write us for prices on Chains, Rings and all kinds of High-Grade Jewelry.

**WM. C. PENFOLD CO.**

WHOLESALE JEWELERS

AND AGENTS FOR DUEBER-HAMPDEN WATCHES

818-820 Chestnut St., Philadelphia, Pa.

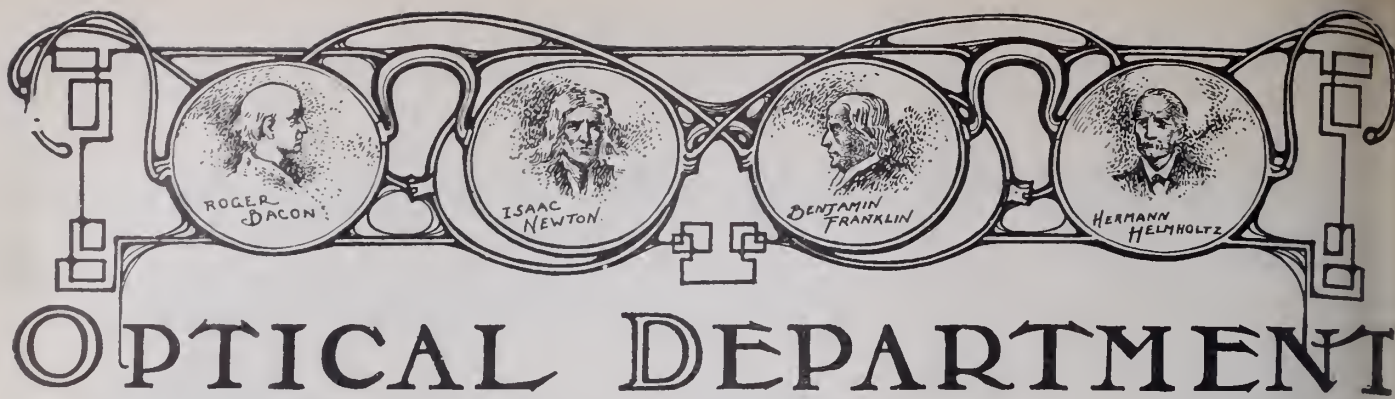

## Is the Time Ripe for a Recognized College of Optometry?

(Abstracts from a lecture delivered by F. W. P. Simmons, before the New England Association of Opticians, Boston, Mass., May 16, 1906.)\*

[Editor's Note.—That readers may fully appreciate the value of Mr. Simmons' remarks, it may be well to review the situation from its origin. Years ago, A. Jay Cross, of New York, pleaded earnestly for a higher educational status; John C. Eberhardt, Dayton, O., joined hands with Mr. Cross, and together they worked, believing that while legislation was desirable, it could best be secured by raising the educational standard. On Nov. 15, 1905, E. LeRoy Rycer urged the Optical Society of the City of New York to act upon this subject, and proposed the formation of the "American Academy of Optometry," believing this a practical solution of the problem. This plan met with hearty approval from all sections of the Union and its influence was felt nowhere more forcibly than in New England, where it rekindled the old spirit that, in 1898, resulted in the establishment of the "New England Optical Institute." The college scheme proved a failure, not because it was lacking in itself, but because the members of the optometrical profession did not see fit to take advantage of the chance thereby given to improve their education. It has been conceded upon good authority that the only fault of this institution was its being 10 years in advance of the times. With the usual Yankee aggressiveness and praiseworthy intrepidity, Mr. Simmons now proposes the formation of another optical college, in somewhat the following terms.]

"Mr. President, fellow members and friends: The mention of the word friends makes me fear that I have more friends in the audience now than I will have an hour from now, for my present task is not a pleasant one; but one wherein I must tell the optician what he is not, rather than what he is.

"When the subject was first given to me I divided it into two sections—first, whether or not a college should be established, and, second, if so, where it should be established. That a college should be formed cannot be questioned, nor do I think its location should be questioned. It must be in Boston. Where else can we have it? What other city has any right to have it, and what other city has the same advantages?

"Before going any further let me tell you that we will have a school—don't doubt that for a minute. The term used to designate members of our calling is a point that demands careful consideration. The word optometrist is a good one, brought to the front by prominent men and papers. We still, however, call ourselves opticians, either because we are conservative or because we are afraid the public will not understand

\*See issue of the *Circular Weekly of May 23*, for a full report of the *Twelfth Annual Convention of the New England Association of Opticians*.

other terms. It is true that the public understands the meaning of the word optician in a general sense, although it has not learned to differentiate between the man who grinds the lenses and he who examines the eye.

"I dare not give definite preference to any particular term, but I do state emphatically that if we have a school it must give us a name—a name that will withstand criticism. This name must include a degree, but a degree that will not, in any way, infringe on medicine.

"Six or seven years ago we had a school. Whether it was good or not, I will not attempt to discuss here, but the time has come now "to make some distinction between the various grades. A clerk behind the counter in the wholesale house is an optician; the peddler traveling through the country is an optician; the helper in the shop is an optician, and the little foreigner who wished to go to night school and was asked his occupation, replied, 'optician.' Between refracting opticians, eyesight specialist, consulting optician, examining optician, graduate optician, eyesight refractionist, optometrist, etc., etc., the public does not know where it is at.

"The school must give us a standard, a high standard, but it must also give us a name, else it is worthless. We do not begin to know the A, B, C of what we should. Asking a patient if he can see better or worse is not optical work.

"Since the New England Association of Opticians was established there has been a thirst for knowledge among opticians. We have had a medical lecturer, but he didn't know, or didn't tell us, that which we sought; maybe he was justified, maybe not.

"I think we should condemn many of the optical advertisements that appear in the daily press. Sometimes a paper contains more fake medical optical ads. than news. Such advertising drags good and bad alike down into the mud. When a man advertises to sell \$3 gold glasses for \$1, he is treading on treacherous ground. I don't want to see unreasonably high prices charged, nor a fee for examination if the examination is not good; but when we get a school our services will be worth something. Any man who charges a fee, yet lacks a thorough knowledge of his work, is as much a fakir as he who sells the \$3 glasses for \$1. We must do something to improve. We are far from perfect. I have taken a retinoscope and selected a cylinder that seemed perfect, and then have the patient accept a sphere, yet I have used the retinoscope for 13 years.

"The opticians are doing most of the re-

fracting work and will continue to do it, for each year shows more patients leaving the oculist for the optician. Last year I refracted 1,402 new cases; 500 had previously been to oculists, less than 60 had been to fellow opticians, and the rest had worn glasses before.

"It shows plainly that the oculist is holding his work. If, however, the public comes to us, we must be able to do all that our duty to them requires. We should know all about disease, but must not treat it. If a troublesome refractive case presents itself, don't send it to an oculist, but to another optician; the optician will be loyal to you, the oculist will not, and to make that doubly sure we must formulate a Code of Ethics and abide by it. Though we should in no way treat disease, we should know all about it and, going still further, we should know all about those drugs to have any bearing, direct or indirect, upon the eye.

"Legislation will come, but only after we have established a school with so firm a foundation that physicians, who intend making a specialty of eye work, will come for post-graduate instruction.

"The school should give thorough training in anatomy, physiology, neurology, optics, applied optics and refraction, root a branch.

"The sessions should be held in the evening and, instead of a two or three month course, a two or three years' course should be given.

"Three years ago we arranged to take course of lectures at the Massachusetts School of Technology. Some time after a number of the men took private courses from one of the professors of Tufts College. Thus it is evident that we are realizing that the time is coming when a college will be needed and supported.

"Within a year the Y. M. C. A. is to consider the advisability of incorporating a course of optometry in its series. It gives a recognized law course and what will prevent it from giving a recognized optometric course? Before we can expect a degree, we must make ourselves proficient, and to that we must have a school. A school that can give us a well earned name will give us unquestionable rights, and one of the privileges would be just legislative recognition. There is no time like the present or no place like Boston."

The Hamilton Jewelry & Optical Co. Ltd., Hamilton, Ont., has been reorganized. H. Barnard and R. Broughton have been large shareholders and have been appointed directors.



## Optical Department.

### The Health Ray Lenses.

Lecture by Dr. ARTHUR C. CAMPBELL, Topeka, Kans., before the convention of the New England Association of Opticians, May 16, 1906.)

MAN is at the bottom of an atmosphere and through this comes to him all the external foods and forces by which he is sustained. To the action of these forces, willingly or unwillingly, we and all lower orders of animal life must submit. One of our chief concerns is to so utilize these forces that they may help and not injure the processes of our life.

#### LIGHT.

First among these forces is light. We are told that the sun is the great dynamo in which this force originates; that it is a wave or vibration, which emanates from the sun and travels unerringly in straight lines in every direction to the farthest confines of the solar system. That a small action of this force penetrates our atmosphere and impinges upon us, the living organisms.

#### LIGHT AND LIFE.

Again we are confronted with the fact that light not only accompanies life, but it is absolutely essential to it. The helianthus and the daisy turning their faces ever to the sun, the white stalks of the cellar-town potato, the eyeless fish of subterranean rivers, who are lineal descendants of animals who once lived in the light, the leached, almost bloodless, arteries of the prisoner of Chillon and Monte Cristo, all are evidence to the necessary life-giving virtue of light.

Science has made a more exhaustive and serious study of light than of any other object, not excepting electricity. It has found that a beam of white light is by no means a simple force, but is made up of an infinite number of vibrations or wave lengths, each varying from its fellow in length, rapidity and other characteristics.

#### THE SPECTRUM COLORS.

In this discovery scientists were aided by the colors which made their appearance in

the spectrum, created by passing light through a prism. We may well imagine with what eagerness they hailed the fresh discovery that each spectrum color was due to a wave having a certain rate of vibration; that at one end the red ray moved like a dray horse compared with the thoroughbred violet at the other extremity of the scale. Thus they led to the announcement that solar light passing through any medium of refraction whether the rain drop in the heavens, the dew glistening upon the grass, the quartz quarried from the earth, the glass manufactured by the ingenuity of man, or by the accident of the desert fire, is composed of seven colors.

Our scientists have advanced to a still more important conclusion by establishing the fact that each ray differed from its fellow in its essential properties; the red moving at the rate of 395 trillionths vibrations per second, each having a wave length of 700 millionths of a millimeter, exhibits the greatest amount of heat and but little chemical effect, while the violet moving at the rate of 756 trillionths vibrations per second (in round numbers double that of the red) with a wave length of 396 millionths of a millimeter (one-half so long as the red), presents comparatively little heat effect but marked actinism, or, in plain words, power to produce growth.

#### GRADATION OF COLORS.

You will observe in the spectrum that the colors are not clearly defined, the red shading insensibly into the orange, each successive color overlapping its predecessor, the indigo shading into the violet with the same absence of demarcation. Experiments have also disclosed that heating and actinic effects are blended in its various colors according to their respective distances from the red and violet ends. But the tremendous importance of the spectrum was appreciated only when it was discovered that beyond the red, invisible to the eye, are heat rays hotter than the red itself, and that outside the violet are invisible waves more actinic in chemical power than any we can see.

At this point the theorist, our scientist, turns over the subject of light to the practical man of affairs, with the injunction, "Here is what light is, what will you do with it?" The consumptive stakes his life upon the answer, seeking the open air sanitariums of various parts of the world, not only for pure air, but also the elixir of life—unadulterated sunshine.

Finsen by his experiments in the laboratory and sick room demonstrated light to be a remedial agent in the treatment of many diseases and established an indisputable connection between light and the health of the living organisms. Finsen's conclusions have been adopted by all the authorities in this country and Europe, who have admitted light to be not only a curative of disease, but also a preserver of health.

I attended a meeting of some of the most eminent American optical manufacturers in the City of New York, in October last. During their discussion I advanced the statement that light, which will not pass through our present spectacle lenses, possesses and imparts to the human system certain very valuable health-giving properties. To this they demurred, and at last adjourned the meeting for several hours for the purpose of taking the testimony of three of New York's best oculists upon the point in question. Telephone communications revealed the fact that not three of the great oculists in the city could be found qualified to judge in the matter (I think they could be found if they had searched harder).

This surprised the manufacturers and the major part of them departed to their respective homes, wondering whether your speaker knew whereof he spoke in regard to the therapeutic value of light. On the following day C. L. Merry, of Kansas City, Mo., Dr. Julius King and his son, Walter, of New York, went with me to the office of Dr. M. A. Cleaves, the acknowledged authority on light in this country (though not an oculist) to submit the question of the physiological action of that part of solar



GROUP OF OPTICIANS AND THEIR FRIENDS WHO ATTENDED THE 12TH ANNUAL CONVENTION OF THE NEW ENGLAND ASSOCIATION OF OPTICIANS.

## Optical Department.

light which they admitted would pass through my lenses, but would not the regular. To that select few I gave my initial lecture with the aid of the chart which I have before me to-night.

### LIGHT AND OPEN AIR TREATMENT.

After a general statement as to the curative properties of light, I touched upon the sanitariums of Colorado, New Mexico, and that one of Dr. Leuterwasser, who exposes his patients nude to the sun, and various other resorts, not forgetting the one at Saranac Lake, N. Y., where they sleep outdoors in the winter with the thermometer at 30 degrees below zero, and suffer no inconvenience. On the contrary, thousands are cured yearly of pulmonary tuberculosis with nothing but the aid of Nature's light, good wholesome food and oxygen, which is found in much larger quantities in any cold climate.

I then reviewed the work of that great professor, Niles Finsen, to whom we are indebted more than to any other man for our knowledge as to what particular part each wave length plays in the role of health and cure of disease. Finsen first, through the action of light, produced the immediate destruction of the disease germs themselves. Later he became thoroughly convinced that the action of light was primarily upon the blood and nervous system.

As proof of this statement many interesting experiments were made, one of which, the picture of the great Finsen lamp, will aid you to understand. A piece of Aristo photographic paper was placed on the under side of the lobe of his wife's ear; the outer surface of the ear was then exposed to the light energy of a 20,000 candle-power arc light for one hour, without discoloring the paper in the least. He then expelled the blood from the exposed ear and turned the light on for five minutes, blackening the paper beneath the ear, demonstrating two facts: First, that light penetrates the tissues of the body, and, second, that it is absorbed by the blood.

### WHAT ARE HEALTH RAYS.

At this point Dr. Cleaves said, "Gentlemen, step this way." In an adjoining room she turned on a great searchlight that once belonged to an ocean liner, saying, "To show you the truthfulness of Dr. Campbell's statement, notice when I place my hand in its course, the red rays only are transmitted. If it were possible for me to render my hand bloodless we would see a white light very much as it is before it enters the hand. This demonstrates that the health rays, as he calls them, are absorbed by the blood." Dr. Julius King asked what color rays were absorbed by the blood. Dr. Cleaves responded in the language of Finsen, "The blue, indigo, violet and ultra violet." These are the health rays.

Doubtless many of you read about a month ago of Professor Gates, of Washington, D. C., making experiments with ultra violet light, showing whether a person is actually dead or not. This novelty was known to Finsen 12 or 15 years before his death, and is simply another experiment proving that in the living organism these health giving rays of light are absorbed by

the blood, while in the dead, where the blood is not circulating, they pass through the tissues.

Do not understand me as saying that ultra-violet light taken alone is beneficial to the eye. On the contrary, allow me to most emphatically say it is detrimental if taken in quantities, though they are among the most important healing rays, and when properly mixed with the other parts of solar light as it comes to us, it is most certainly beneficial and thought by many to be the most active part of the health rays. These will not pass through glass to any great extent, as is well known.

I then exhibited this picture of a few of the many diseases cured in the Finsen laboratories. The center picture taken before and after treatment is copied from Rational Hydrotherapy, by Dr. John H. Kellogg, of Battle Creek, Mich., who visited Finsen and gives his endorsement of Finsen's work in his last edition, where these two pictures may be found.

### HEAT AND HEALTH-RAY FUNCTIONS.

It is the function of the red end of the spectrum, or heat rays, to so warm the soil as to make possible the growth of plant life, but it is to the health rays we are indebted for that life-giving quality which enters into the plant in a mysterious way and causes it to come forth in all its beauty and bear fruit.

### HOW THE HEALTH RAYS ACT.

In a similar mysterious way these short wave lengths, the health rays, enter into and produce the changes in the blood, causing both the white and red corpuscles to increase in size and number, giving to the white, the scavengers, a greater strength and vitality to fasten themselves upon disease germs; others are thrown out in waste matter as puss or are surrounded in a capsule and therefore kept from destroying the tissues, as in tuberculosis; these health rays, moreover, increase the number and size of the red and multiply their capacity for carrying oxygen and food to feed the tissues, burn up the waste matter and carry away the debris that accumulates.

Another very important function of light must not be overlooked. Concentrate a beam of white light upon living flesh, and you will have, as I have endeavored to show in the illustration, an enlargement of the small arteries, which are controlled reflexly from the nerve centers of the brain and chord. This dilatation enables the blood to flow easily and copiously, bearing upon its crimson tide nutrition to wasting brain and other tissues, and discharging into its excretory organs, the sewers of the body, the poisonous products to be thrown out. Now, combining this illustration with Dr. Cleaves' explanations, we have, by the use of light alone, a better supply and quality of blood and a larger channel through which it may pass, and have also well in hand the physiological processes of growth and repair.

### HEALTH AND THE EYE.

The relation between health and the eye; this special organ of sight, is the main object of our interest. Each organ of the body acts upon the vital fluid blood in a manner peculiar to itself. I need but mention to you the office performed by the liver, stomach, pancreas, lymphatics, etc.,

and those strange but little understood bodies, the ductless glands. Each is necessary, each must perform its function or the blood is vitiated and ill-health results. Life may cease because the blood is not supplied with the element furnished by each organ. The lungs are the special organs of aeration, yet not all the work of oxidation is performed by the lungs.

The body's covering is constantly inhaling and exhaling air. In the same sense, and to a greater degree, the eye is the special sense of sight, the gateway through which the light flows and discharges its energy, nourishing the blood. To a greater degree I say, because every civilized man increases the burden of nutrition imposed upon the eye by concealing the major portion of his body with clothing, which otherwise could and would absorb much of the needed light through the skin.

Natives in semi-civilized countries, like Liberia and even Mexico, cure themselves of many diseases by exposing their entire bodies to the sun. Indeed, the African is almost wholly free from these dread diseases in his native land, while in this country it is a common saying in the dissecting room that negroes either have tuberculosis or syphilis. There is but one explanation to this, and that is that through his black skin almost wholly covered with wearing apparel it is impossible for enough of the health rays to penetrate and vitalize the blood.

Rob the system of these health rays and disease will result. Great Britain furnishes us a good example of this, there being a greater percentage of deaths from the white plague on these islands than in any other civilized country, from the fact that the atmosphere with its great number of cloudy and foggy days absorbs the health rays and deprives the system of vitalizing force. We are told that Massachusetts, on account of her cloudy weather, also claims a great number of victims of consumption, some 4,000 dying annually in this clouded State alone.

(To be continued.)

## Another Staunch Advocate of an American Academy of Optometry.

ROCHESTER, N. Y., May 23, 1906.

Editor THE JEWELERS' CIRCULAR—WEEKLY

I personally think it a good thing, and if it is properly handled it would certainly benefit every optometrist, as we never can get any too much knowledge. Moreover in order to get that knowledge in a medical school we must first prepare for it with several years' college work, and every optometrist has not the time to spend to get through so much work.

I think if we could have a standard college for optometrists, which would teach optics exclusively and grant a proper diploma when proficient, we would certainly be much better off than at the present time.

C. S. SUMERISKI,

Secretary Rochester Optical Society.

Dodge & Whitney, Lansing, Mich., have moved into their new store, at 208 Washington Ave., S. The optical department is a feature of the new quarters.



SOME ATTRACTIVE EXHIBITS SEEN AT THE RECENT CONVENTION OF THE NEW ENGLAND ASSOCIATION OF OPTICIANS. (Described in last week's issue of THE CIRCULAR-WEEKLY; also see page 92.)

## Optical Department.

### Optical Notes and Briefs.

W. R. Livingston, Brush, Colo., was a recent visitor to the optical trade in Denver, Colo.

E. Amsden has taken a position as optician with the Columbian Optical Co., Denver, Colo.

Dr. C. M. Haviland, optician and oculist, Fort Collins, Colo., was in Denver, Colo., recently, on business.

W. E. Dodd, Butte, Mont., has gone to Chicago, to take a post-graduate course at an ophthalmic college there.

Herman Silbert, optician, 482 Washington St., Buffalo, N. Y., is the inventor of a mounting for eyeglasses, soon to be perfected and put on the market.

Mason Smith, for several years in the branch optical store of A. Martin, 617 Main St., Buffalo, N. Y., has gone to New York, and may remain there after he takes a rest in the hope of benefiting his health.

The North Dakota State Board of Optometry met in Grand Forks recently, to close up business for the year, prior to starting with a new board July 1. The present board has completed its three years' term, and accomplished a great deal of good work in that time.

A meeting of the Executive Committee of the Buffalo, N. Y., Optical Society, was held at the home of the society's president, Mr. Simcox, last Thursday. At this meeting Roger Williams, of the Failing Optical Co., an enthusiastic steam yachtsman, announced he would take the society members in his yacht to Rochester, N. Y., to attend the convention of the American Association of Opticians.

Andrew Brown, of D. V. Brown, 740 Sansom St., Philadelphia, Pa., was one of the subjects last week of Anna Eva Fay, who is appearing at a local theatre, and who asserts her power to tell secrets of all sorts and to read minds. Mr. Brown wanted to know what had become of some valuable certificates which he had mislaid. To his astonishment and delight Miss Fay told him where they were hidden and the recovery of the certificates prompted Mr. Brown to write Miss Fay a flattering and appreciative letter.

One of the features of the civic parade at the centennial celebration of the city of Geneva, N. Y., recently, were the two floats of the Standard Optical Co., of that city. The first float displayed all styles of lenses, gold and silver, gold filled and Roman alloy material used in manufacturing spectacles. On this float was also a quantity of completed goods made by this company. The second float was called the machinery float. On this was an optical bench, a lens marker, a standard lens cutter and drill, a prisoptometer and an Acme edge grinder. A demonstration of the work of the different machines was given on the float. Besides the floats 160 men employes of the concern took part in the parade.

A burglar alarm thwarted a bold attempt to rob the rooms occupied by F. A. Hardy & Co., wholesale opticians, on the fifth floor of the Arapahoe building, 1622

Arapahoe St., Denver, Colo., last Wednesday night. The thieves climbed a fire escape and entered through a window. They seemed to have first centered their attention

door sounded and scared them away. That the would-be robbers were desperate and would have blown open the vault, had other means failed, was evidenced by fuses com-



EXHIBIT OF STEVENS & CO., PROVIDENCE, R. I. (ALSO SEE PAGE 91.)

on a safe containing \$1,000 worth of gold spectacle frames, but before they could pry it open, a burglar alarm attached to the

monly used by bank thieves in setting nitroglycerine, which were found scattered all over the floor of the room.

# RETAIL JEWELERS ADVERTISING

The use of this department is open to every retail jeweler and optician. Forward for criticism your newspaper ads., booklets, catalogues, novelties, circulars, etc. Ask advice and offer suggestions. Replies in these columns are unbiased. Make letters as full and particular as you desire. Every letter and ad. sent will receive full attention, though the publication of the matter may sometimes be delayed several weeks.

## What Some Jewelers Say.

**J**EWELRY to turn the heart is shown in our new assortment of dainty things for this season. Ornaments for hair, neck and waist are here aplenty. Combs, hat pins, barrettes, stick pins, belt buckles of chaste design and exquisite workmanship. They are developed in various metals and the styles range from Louis XVI. to Art Nouveau. Prices are as attractive as the goods. A. E. Dwelle, successor to E. W. Blossom, Sterling, Ill.

Brodnax—\$8.50 for 100 invitations; large double envelopes. We believe that we understand the art of first-class engraving. Our workmen are competent—the best engravers to be found in America, and their work constantly excites favorable comment. We are particular about the kind of paper that goes in our invitations. It is a pure vestal white in color and strong, tough fiber in quality, the kind that can fold and

**W**ITH the dawning of Friday will be ushered in the wedding month, during which the jeweler should continue the appeal to prospective gift-buyers which began—or, at least, should have begun—in the month of May, thus allowing eight weeks of persistent advertising. Several samples of June advertisements were pub-

well written. The unusual type used in the catch phrase, name plate, etc., makes the announcement conspicuous and easy to read. In a previous issue THE CIRCULAR-WEEKLY reviewed the advertising methods of J. Selinger, Washington, D. C., and the latter recently forwarded the accompanying two ads., together with several others. The

### Diamonds to be Dearer.

Through the largest Diamond dealers in the East we have had a 15 per cent advance on the rough, has been cables, to take effect within 15 days.

Women! Do not be wise in these NOW! We are getting on to 1906 prices—guaranteed 10 per cent. less than any other dealer's.

We urge a comparison of goods and prices—the only true guide is value.

A Diamond guarantee with each sale.

Your money back, less 10 per cent. in two years.

Write for selection package, all charges paid.

**Jos. Goodman & Son,**  
Main and Union Streets.

### At Rolshoven's for Wedding and Anniversary Gifts

The very best lines we offer in Sterling Silver, Diamonds and Jewelry represent the latest designs. With beauty and art in detail, give our special low prices.

<b>IN DIAMONDS.</b>	<b>PEARL AND RUBY.</b>
SOLE DIAMOND DEALER	SOLE PEARL AND RUBY DEALER
SOLE DIAMOND DEALER	SOLE PEARL AND RUBY DEALER
SOLE DIAMOND DEALER	SOLE PEARL AND RUBY DEALER
SOLE DIAMOND DEALER	SOLE PEARL AND RUBY DEALER
SOLE DIAMOND DEALER	SOLE PEARL AND RUBY DEALER
SOLE DIAMOND DEALER	SOLE PEARL AND RUBY DEALER
SOLE DIAMOND DEALER	SOLE PEARL AND RUBY DEALER
SOLE DIAMOND DEALER	SOLE PEARL AND RUBY DEALER
SOLE DIAMOND DEALER	SOLE PEARL AND RUBY DEALER

**F. Rolshoven & Co.**  
Established 1855.  
11 WOODWARD AVENUE.

### Hess & Slagers

#### Diamonds, Watches & Jewelry

We claim to be one of the largest dealers of fine Southern Diamonds in the South, and we want to absolutely secure every customer who makes a purchase from us against any loss. It is our desire to make a proposition to all purchasers of gems, either at our Main street or Bay street store, that will in a way make them practically safe and give them for a very small price the use of any kind of a Diamond that they desire to wear. This proposition on its face appears itself, and as to our reliability ask any local bank in Jacksonville, and find out if we do not live up to every obligation that we make, and if our signature is not absolutely safe. We will sell you a \$50 Diamond or \$100 one, and no matter if Diamonds decrease in value, you have a standing offer, whether you remain in Jacksonville or move to New York or Chicago, that we will give you \$30 in cash for one and \$60 for the other. High priced Diamonds up to \$500 same proposition. If this sounds expensive to a customer and we have inside information that 25 per cent to 40 per cent will be added in value during 1906, you have made a money-making investment, and you are wearing the Diamond. This offer is made not alone to satisfy us in selling stones, but also to prove to you, without any doubt, that our points are based on such a small percentage that we stand ready to hand you in cash \$150 for an article that you paid \$150 for. When you purchase a Diamond from us your receipt states the correct weight, the quality of the Diamond and each mounting has our stock number engraved on it. This number corresponds to the entry in our books. Consequently you can give our receipt and the Diamond to any express office in the United States and your money will reach you as fast as the South Sea Express Company's mail steamer. We are and have been for the past ten years direct Diamond importers, and buy only fine, well-cut stones, and make our selections in full paper lots. We claim, and can prove, that our knowledge of Diamonds as an individual and a little better than the average gem dealer, and it is our different to give you only the finest white goods that are on the market. Our business has eleven years' experience in retail and the reason it is in this way is that our customers. One day we work another and the entire chain of Diamond purchasers, respectively correct. Keep out values, take us a chance, especially in fine Engagement Rings. We have the assortment and the price. In reference to Watches, we have every high-grade make and only employ expert national workmen. Our firm represents the Atlantic Coast Line, as watch inspectors, and have fully 300 of these employees registered on our books, proving our ability to handle with care the finest watch movements manufactured.

**Hess & Slagers**  
Diamonds, Watches & Jewelry

339 W. Bay

### Your Eyes are Your Breadwinners.

If you find that anything is wrong with your eyes—your sight "blurs," if you have headaches—come and let us examine them. By being prompt in attending to your eyes at the first signs of trouble you will be able to have the defect speedily corrected.

We make an accurate examination without any charge. We understand the scientific fitting of eyes with the proper lenses and we are prepared to supply the best quality lenses and frames as cheaply as any one in this or any other state. But bear in mind this positive fact, we give you our services absolutely

**Free of Charge,**

and for the glasses we ask you what they are worth as so much merchandise; the actual value cannot be computed in dollars and cents, for when properly fitted they become such a positive help in aiding you to perform your duties more correctly and less laboriously, that the question of price becomes a mere trifle.

**Frank E. Davis,**  
Jeweler and Optician,  
Corner Columbian Building.



### The Service Offered by Our Optical Department is Unsurpassed.

It is impossible for you to get better service than we give. Our Optical Department is in charge of a graduate optician, who thoroughly understands his business. The latest scientific instruments are used, including a new model ophthalmoscope, for the detecting of astigmatism.

**Eyes Examined Free.**

We do not make any charge whatever for giving a thorough examination of the eyes, and if glasses are required, we will tell you.

**"You Need Selinger's Eye Service."**

Our special leader is a pair of Solid Gold Spring rimless eyeglasses, with case and silk guard, for only **\$1.**

**Selinger's, F and 9th.**  
Look for the Big Clock.  
Optician—Prescriptions Accurately Filled, Price



### "You Need Selinger's Eye Service."

### Headaches are often caused by eye strain.

Have you ever thought that probably yours comes from that source? It would be wise to let us examine your eyes—and, if you need glasses we can tell you. This examination is absolutely FREE.

As a special we offer a **SOLID GOLD Spring Rimless Eyeglass, with Case and \$1.00 Guard, for**

**SELINGER'S, F & 9th Sts.**  
"Look for the Big Clock."

lished in the issue of THE CIRCULAR-WEEKLY May 2, the present week's announcements being of a various character, with the exception of the ad. of Fred Rolshoven & Co., Detroit, Mich., which offers fit suggestions in a general way. The ad. of Joseph Goodman & Son, Memphis, Tenn., reduced from four and a half columns, double column, is "newsy" and typographically attractive. "Your money back, less 10 per cent., in two years" ought to furnish food for thought to those seeking profitable investments. The attractive "proposition" of Hess & Slager, Jacksonville, Fla., which occupied a space of 10 x 6 1/2 inches, is worth reading. The advertisement just at the right of it was received a short time ago from Frank E. Davis, an enterprising jeweler and optician of Northampton, Mass. It was reduced originally in a space of 10 x 4 1/2 inches. The catch phrase is one that will appeal strongly to many. The text that follows is

design of the first ad., which occupied five and three-quarter inches, double column, is striking, and the text tells why one should take advantage of Selinger's service. The type is well chosen. The ad. below this is rather attractive, too. The text is cleverly constructed, particularly in view of the recent form of bill governing the practice of medicine introduced in New York. Should this bill become a law, it will be a misdemeanor for any one other than a physician to relieve pain; hence one can readily see its aim at the optician, who must be careful not to promise in his ads. to effect cures. A scrutinizing analysis of the wording of the Selinger ad. will show that the advertiser keeps strictly within the pale of the law. He says "headaches are often caused by eyestrain." He does not say "We can fit your eyes with glasses and cure your headaches," but merely "If you need glasses we can tell you."

bend many times without breaking. One of our chief officers gives the engraving department his personal and special attention. He studies carefully all the new things that are presented and from the best of them our styles are drawn. If your invitation bears the Brodnax imprint you will know that it is the best of its class that can be produced. We would like to send you our sample book No. 17, which shows the proper forms for invitations and announcements, and also for all the necessary enclosures, such as church, reception and at home cards. George T. Brodnax, Memphis, Tenn. Our exhibit of high class jewelry was never so temptingly beautiful as at present. A tremendous variety to choose from and interesting prices throughout the collection. Jeweled rings of great beauty, scarf pins, cuff links, bracelets, etc. See our diamonds.—Frank F. Stapf, Dunkirk, N. Y.



That this department shall prove mutually beneficial to our readers, it is desirable that the members of the trade generally communicate with THE JEWELERS' CIRCULAR-WEEKLY regarding any advantageous device or plan which they are utilizing in connection with their business.

**A TECHNICAL WINDOW DISPLAY.**  
 Processes of Manufacture Which Never Fail to Attract Attention.

**K**NOWLEDGE is something of which every individual owner is proud. But it is to the owner of occult knowledge that the greatest expansion of chest occurs

ingress of the general public is debarred, where none but the chosen few are permitted entry!  
 Are you a Mason? Oh, the marvelous

long and often, a catering to the thirst for information that exists in the person of the show window gazer. A certain branch of instructional, or shall it be called cultural window trims have been suggested, sufficient to give the retail jeweler, desirous of outdoing the average competitor in window displays, a direction in which to exert his ingenuity.  
 But there are numberless divergent sources of instructional information that can be dealt out to the public, each of which



(1) BLANK. (2) ROLL. (3) PRESS-OUT. (4) ROUGH. (5 AND 6) STRIKE-UP. (7) POLISH. (8) SILVER PLATE. (9) HAND BURNISH.

from a consciousness of "inner" information. The feeling of ownership is "comparative" to the "position" of the ignorant "common herd." But the proud feeling of sole ownership is the real "superlative" in that line of sensation.  
 Watch the look of supremacy among the theatregoing crowd of the man who has been "behind the scenes." And see the open display of admiration or envy of his uninitiated companions when just a few words leak out of the conditions that rule in the "wings" or the actions of the "profess" in the "greenroom." What wonders are supposed to be hidden anywhere where

mysteries that are attached to the workings that go on the other side of the veil! Do not superciliously call those thrills that creep up the human spine upon the hope of disclosures just rank, idle curiosity that killed the cat. However, call it what you choose, the fact of this desire for hidden knowledge pervading every fiber of all cultured humans has to be acknowledged, and, accepting this condition of things, the owner of a store front has the key to the hearts of the passing multitude. Let him make honest and earnest use of it.  
 The writer, in the "educational" show window series, has dwelt upon, perhaps too

will appeal to this same sentiment or curiosity, whichever you care to term it.  
 There is, for instance, ready to the hand of the retail jeweler information which is absolutely unknown to the public, which even the deep learning between the covers of the encyclopedias does not reveal. This would be of an attractive character that must draw the crowd of intelligent treasure-seekers so thickly strewn among the throngs on every busy sidewalk.  
 Well does the writer remember one of the most "taking" features in the wily performance of the late world-renowned pedagogue, Dr. Lynn—his showing "ly

**Storekeeping Department.**

... was done," after one of his feats of edgerdemain, touched the hearts of his admiring audience. And when, after he had shown "how it was done" and the public was no wiser than before, they were just as delighted as if the conjuror had actually imparted his secret.

There is a lot of action that goes on in the gold and silversmithing factory that can be divulged without passing over to the eager enquirer anything that will injure either the trade or the reputation of the factory. Pass it out. The public wants it. The writer would like to know "how the wheels go round," as Helen's babies expressed it, for, becoming a foolish scribe instead of learning a useful trade, like that of the gold and silver smith, he missed all this useful and highly interesting knowledge.

Teach us all you can and dare in your show window.

If you desire to get some clue as to how to go about the work, perhaps the writer might suggest, leaving you to do. Let us take as an example:

**A SPOON DISPLAY.**

Some time ago the American Silver Co., Bristol, Conn., put together on a stiff cardboard backing, in size about 22 inches long by 10 inches wide, a capital, practical exposition of the "Evolution of a Teaspoon." This clever piece of advertising gives a graphic view of the nine grades of transition through which the teaspoon passes in its manufacture before it becomes a thing of beauty and utility in its burnished state. An illustration of that concern's "evolution" card is given herewith. No doubt many of THE CIRCULAR-WEEKLY readers have already seen it, as it is not by any means a recent device. It serves, however, as a directive force on which to build a window trim that, if not exactly novel in its source, can be extended into instructional show window displays that will offer attractive and "occult" features—and sell goods.

The weak point in this or similar "evolutionary" cards is, from our present standpoint, that it is too condensed—it does not make a window display, but a feature in the window.

Suppose we extend the space and elaborate on the instruction afforded. How would it be to separate these nine exhibits sufficiently apart from one another to fill out the window? Let us give the display a taking caption on a card located above the entire exhibition, something catchy, say:

A Spoon—Full  
of  
Factory Facts.

Then we mount on three cards, separately, nuggets of the three metals composing the alloy base with the words (one on each): "Nickel," "Copper," "Zinc." Grouping these cards, we put a caption to the trio in such words as:

Best Alloy for Table Ware.

Next take in hand process No. 1, the "blank." Mount it on a card, with its technical name on top, and, underneath, a few salient points concerning the process gleaned from the factory, such as its being cut by a steel die (if it is); the pressure needed of so many pounds to the square inch; the thickness of the plate from which it is cut, etc.

Follow this with a card alongside, containing the second process of the evolution. Set the title "roll" over the exhibit, and under it (in as few words as possible), the leading features of the process—run through rollers and reduced, under so many horsepower pressure, to such and such a thickness.

Now for No. 3: State how "press out" is done, etc. And so continue a carefully carried out technical display, with description, of the remainder of those nine stages. But perhaps the thing is just a little bit "dry" bait for the vitiated tastes of some of our prospective customers. Suppose we squeeze a little of lighter matter in to increase the size of the show and make a diversion.

How would it be to bring in a little history to spice the window story. A show card, for instance, as follows:

Ben Butler Loved Spoons.

Another:

AN ANCIENT CUSTOM.  
For Centuries Children Have  
Cut Their Teeth on Spoons.

Display some "Apostle" spoons. Germans still have them in their customs. Append a card reading:

"APOSTLE" SPOONS.  
European Godfather Gifts  
to Cut the Child's Teeth On.  
Child Christened in Patron Saint's Name  
on Spoon.

Make three little piles of cockle, mussel and clam shells. Put a card at their back, thus:

FIRST SPOONS EVER USED.  
Cockle, Mussel and Clam Shells.  
So History Tells Us.

Display a few horn spoons, with the following card:

HORN SPOONS WERE AMONG THE FIRST.  
An Old Saying:  
"To Make a Spoon or Spoil a Horn."

Add a few wooden and bone spoons with a card:

Table Ware Progenitors.

Another card, perhaps to fill in a blank space, might be:

Our Distant Forefathers Said:  
"He Wants a Long Spoon  
Who Sups With the Devil."

Try to get at least one snuff spoon. The

Scotch especially used them up to within a recent date, and they should be available to the energetic seeker. Some such card as this might be used:

"SNUFF" SPOONS.  
It Was  
"Take a Spoon of Snuff"  
Before the Day of  
"Take a Pinch of Snuff."  
Which Was Cleanest?

All this is, perhaps, progressive window trimming, and, maybe, up-to-date. If so, can't we get ahead of this date and produce an advanced style? This "evolution" display explains what the factory does, but can't we pull in the factory itself? At least a part of it. Get photos of the machines and add them to each process.

The cigar and the cigarette dealer puts a man or woman into the window to show how "smokes" and "death tubes" are put together, and the jeweler himself puts the watch tinker to work in his show window. Old and stale as the sight is, there are still always a few to watch the process—maybe due to just innate human cussedness of "hangin' round" while seeing the other man work.

Why not call into requisition an expert or two from your tableware manufacturer to "demonstrate." At least you could put a polisher in the window. A small electric motor takes up very little space and would "mote" all the polishing or burnishing needed in one corner of the window. Put a pile of "Silver Plate" spoons (as on that "evolution" card) on one side of the demonstrator and, as he burnishes them, let him heap them on a pile on the other side. Put a big card between the unfinished and finished spoons, thus:

STEP INSIDE.  
Take One Home.  
25c.

If the pattern is novel or very pretty, you might make a big enough sale to pay for the window on that spoon sale. Those who enter will probably buy other stock besides a mere spoon.

These window suggestions are to pull the customer in. You can assuredly "do the rest." C. W. C.

**Cheerfulness in Business.**

CHEERFULNESS has a wonderful effect upon our physical natures. Show me a thin, dyspeptic, chalky face apology for a man who goes around groaning over his real or fancied ailments, and I will show you a man from whom cheerfulness has departed—not always because sickness has driven it out, but too often because moroseness has courted physical disability. "Let good digestion wait on appetite," and mirth on both.

Optimism and cheerfulness go hand in hand. Pessimism and mental disturbance are twin sisters. If you have not a sound body and a sound mind you cannot fill the measure of your position and turn out work satisfactory to your employer and yourself.—*The Business Man's Magazine and the Bookkeeper.*

What Tool is of More Importance to THE MAKERS OF FINE JEWELRY than

A FIRST CLASS SAW ?

SHARP—TRUE—UNIFORM  
—PERFECTLY TEMPERED

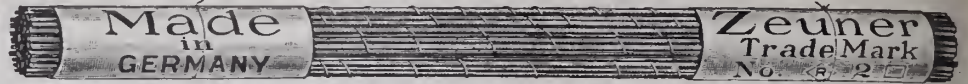

Such is the **ZEUNER SAW.**

TRY THEM, for "Only the Best are Good Enough," and only the Best are Cheap. Trial orders promptly filled under guarantee of perfect satisfaction, which applies also to our "AMERICAN SWISS FILES."

**E. P. REICHELHM & CO.,** 23 JOHN STREET, NEW YORK.

**THE REMINGTON RING EXPANDER.**

The most useful implement a jeweler can own.

PRICE \$7.00 NICKEL PLATED INCLUDING A STEP MANDREL AND EIGHT ROLLS

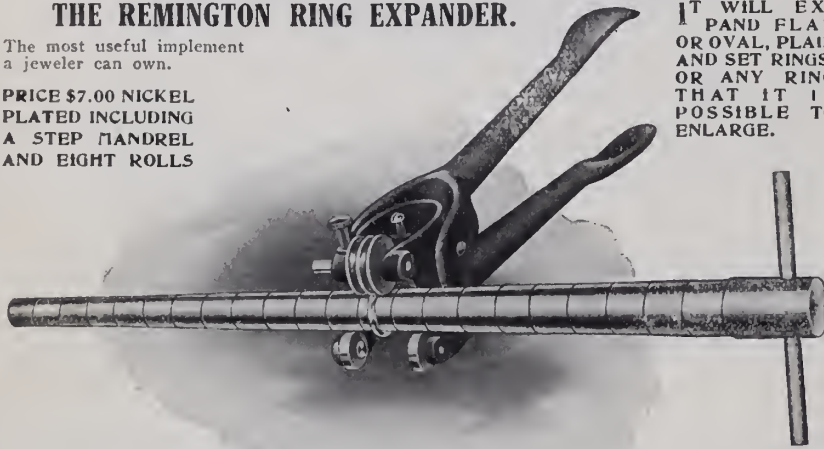

IT WILL EXPAND FLAT OR OVAL, PLAIN AND SET RINGS, OR ANY RING THAT IT IS POSSIBLE TO ENLARGE.

IF YOUR JOBBER CANNOT SUPPLY YOU WRITE TO US DIRECT.

**SPECIAL FEATURES OF THE REMINGTON RING EXPANDER.**

A MANDREL WITH STEPS SQUARED and 1/2 size variation is used to prevent tapering of the ring. THE FOUR SMALL ROLLS ON THE LOWER JAW OF THE TOOL (see cut) PREVENT FRICTION, and make it possible to use any amount of pressure WITHOUT ROUGHING THE MANDREL. THE PRESSURE IS CONTROLLED BY THE HAND and it is not necessary to use a vise or other implement when operating the REMINGTON.

Manufacturers of Patent Tools and Machinery.

**NOVELTY ENGINEERING ASSOCIATION, FITCHBURG, MASS.**

**OUR ELECTRO-PLATING SALTS**

when dissolved in water make a plating solution a once ready for work and of always correct shades. Know that we are the originators and manufacturers of the Dark Green Gold Salts (Antique) and other Shades of Green. Likewise the Rose and Orange Rose Gold Salts used for single and double gilding, and of good many other shades now on the market.

Our Roman Gold Salt produce an almost bright deposit, requiring little or no scratch brushing. French Grey, 14 or 18 Kt. gold, Old English gold, Silver Ebonyizer, in fact any shade wanted, can be had of us. Write for circular.

Our Automatic Electro Plating Machine specially designed for the small manufacturing and the retail Jeweler, will be of interest to them. See for Pamphlet.

**U.S. ELECTRO-CHEMICAL CO.** H. Hirschbach, Prop. 80 Elm Str. N. Y.



**GLARDONS' SWISS FILES**

are the HIGHEST STANDARD of Excellence.

We are Sole Agents for the United States and Canada.

**F. W. Gesswein Company,**

Established 1868. Incorporated 1890. **WILLIAM DIXON, PRES.** Dealers in Fine Tools and Supplies, 39 John Street, New York.

**Horological Department BRADLEY POLYTECHNIC INSTITUTE, Formerly Parsons Horological Institute, PEORIA, ILLINOIS.**

Largest and Best Watch School in America. We teach Watch Work, Jewelry, Engraving, Clock Work, Optics. Tuition reasonable. Board and room in school at moderate rates. Send for Catalog of Informal

**"Perfect Yourself"**

In ENGRAVING and EXPERT WATCH WORK. Take a Post-Graduate Course.

**RIES & ARMSTRONG, Macon, Ga.**

"PRACTICAL COURSE IN ADJUSTING." Price, \$2.50.

All Jobbers or Jewelers' Circular Publishing

**HERPERS BROS.** MAKERS OF

**BRACELET SETTINGS**

IN 10, 14 AND 18 KARAT GOLD AND IN PLATINUM.

ALSO A COMPLETE LINE OF GALLERIES AND FINDINGS.

OFFICE AND FACTORY: NEWARK, N. J., U. S. A. NEW YORK BRANCH: 41-43 MAIDEN LANE

12 NEW PATTERNS

**DESIGNS For Silverware, Novelties and Jewelry . . . FINE ETCHING**

Etching at present, and for a long time to come, will be the decoration, par excellence, for Sterling Silver. We employ the best etchers in the country. **CHARLES M. PRIOR** (PHONE 1224 HARLEM) 1683 Madison Ave., New York



# Workshop Notes & Queries



[Answers are also solicited from our readers to the questions published on this page.]

**QUESTION No. 1568.—To Transfer Engraving.**—Will you kindly tell me the best way to transfer engraving to articles that are the French gray finish on them?

R. F. L.

**ANSWER:**—An engraving which is printed may be transferred to any metallic surface by diluted turpentine varnish. Engraving in metal may be transferred to any other metal by diluted black alcohol varnish by means of pressure, using a piece of rough paper.

**QUESTION No. 1569.—Kermess Finish.**—I was recently shown several pieces of copper articles that were said to have a kermess finish. Kindly tell me how this finish is obtained.

K. F.

**ANSWER:**—This finish has only recently made its appearance. The method of producing it is described in the *Metal Industry* as follows: Take 1 pint of common nitric acid and dissolve in it sulphate of copper until complete saturation has taken place. Dissolve 1 oz. of this mixture in 1 gal. of water. This procedure will produce a greenish opaque solution. Now add enough mucatic acid, C.P., to clear it up, and then add 1 oz. of pulverized bloodstone. This solution should be used near the boiling point. It produces a beautiful finish on copper or copper plated goods, which is better than bronze medaille.

**QUESTION No. 1570.—Lead-Antimony Alloy.**—Please give me a formula to produce a lead and antimony alloy, suitable for casting purposes.

L. A. A.

**ANSWER:**—For lead and antimony alloy the right proportions must be used, otherwise the castings will break. Use lead, 84 lbs.; antimony, 15 lbs.; tin, 1 lb.

**QUESTION No. 1571.—Etching on Brass.**—I have a number of brass nameplates, on which I want to etch names. Can you tell me how I should go about this?

E. B.

**ANSWER:**—Make a "stop-off" varnish, or resist, taking 1 part of resin and Burgundy pitch and ½ or 1 part of dry asphaltum. This is moulded into a stick. The names should be plainly written on the plates with ink or soft pencil. The plates are then warmed and the stick of resist is rubbed over it, so it will cover all except the written name. Then place the plates, when dry, in a flat porcelain dish, with the names upward, and pour over this nitric acid, diluted with five times the quantity of water. When the letters are etched deep enough, rinse in cold water and place the plates in turpentine until the resist has all been dissolved. If the letters are to be in black, then fill them in with black lacquer. When well dried, remove the surplus black lacquer with a cloth and alcohol.

**QUESTION No. 1572.—Argasoid.**—Please

give me the alloy of argasoid. A. P.

**ANSWER:**—Argasoid is a substitute for silver. It costs about 50 per cent. more than brass. The composition is: Tin, 4.035; lead, 3.544; copper, 55.780; nickel, 13.406; zinc, 23.198; iron, trace.

**QUESTION No. 1573.—Watch Dial Cement.**—Which is the proper cement for fastening the seconds dial in an enameled sunk second dial?

**ANSWER:**—Dial manufacturers generally use warm glue, somewhat fluid, and mix with it a small quantity of gypsum or coarse plaster of paris, which composition, when dry, becomes very hard. This mixture, as long as not hardened allows one to place the small dial in its proper position.

**QUESTION No. 1574.—Fresh Water Pearls.**—Will you kindly tell me in what special kind of clam pearls are found?

B. D.

**ANSWER:**—Fresh water pearls are secured from the shell of the fresh water mussel, and are taken from the mantle of the mollusk, close to the lips or soft part of the mussel or oyster. These mussels are generally found in shallow water in running streams. They might be found in rivers of Michigan or in the little streams running into the lakes, although the great region of production is in Arkansas in the territories of the Mississippi, in the Missouri river, in Wisconsin and along the borders of Iowa.

## A New Filtering Apparatus.

IN this age of uninterrupted invention and industrial combination it is not enough for a goldsmith to be a competent craftsman in his own special line. The growth of the jewelry industry and the art of goldsmithing make it incumbent on the individual goldsmith to be up to date in a commercial sense and to be in a position to offer his goods at reasonable prices and with the smallest possible waste of time and material if he wishes to compete successfully with his rivals.

An entirely new system of filtering which has been put upon the market deserves mention, owing to its practical nature and the simplicity of its operation. The sweepings and metallic waste have hitherto, it is true, been subjected to special treatment in factories and workshops, but the goldsmith's hand water and the waste water from polishing were treated according to primitive methods and goldsmiths often poured the waste water away on account of the complicated nature of the manipulation required.

These drawbacks are now, to a very great extent, obviated by the filtering contrivance described herewith, which can be supplied in a simple form to the smallest workshop

and at the same time be made available for large establishments by connecting several filtering plants together. The apparatus possesses the great advantage that it is delivered ready for immediate use, and can be set up by the operator himself, thus entirely doing away with the cost of installation, etc.

The inventor of this system, Söhle, is a professional man, who has been occupied for many years with the treatment of waste water, and has arrived at his results by exhaustive experiments carried on during that time.

The principal feature of the contrivance consists in the omission of the felted funnel hitherto used, which was often liable to become corroded by the acids present in the waste water, and to get choked and brittle on account of particles of soap and grit in the polishing water. A firm filtering mass fixed in a barrel makes possible an auto-



AN EFFECTIVE FILTERING DEVICE.

matic filtering of the waste water without expensive adjuncts or annoying loss of time. It has been shown that the water running away after filtering is absolutely free from any metallic refuse, and that this refuse can be treated dry, together with other refuse.

The apparatus need not occupy any space required for other purposes, as it can be placed in a cellar or basement. If no other space is available, it may be set up in the workshop, as it has no unpleasant odor whatever.

The invention, says the *Journal der Goldschmiedekunst*, has already been introduced into many European gold and silversmiths' factories and workshops and has met with unanimous approval. J. Schmalz, Pforzheim, dealer in tools and machinery, has the exclusive right of sale in Europe.

## A New Solder.

A SOLDER for aluminum has been invented, says Consul Atwell, of Roubaix, by Fernand Hecht, a mechanic of that city. With a soldering iron he can join together two pieces of the metal or join aluminum to copper, brass, or iron. The invention is simple, no acids or salts being used. Mr. Hecht exhibited his process satisfactorily before the professors of chemistry of the Faculty of Science, and was also awarded a medal from the Northern Industrial Society of France for making a discovery of great importance.

L. E. Winchester, formerly a watch repairer for J. W. Ware, Dunkirk, N. Y., has purchased the jewelry stock of F. S. Jolls, in Fredonia, N. Y. Mr. Jolls has retired owing to ill health, and will move to a more agreeable climate.

**C. DORFLINGER & SONS,**

36 MURRAY STREET, NEW YORK.

*Works, White Mills, Wayne Co., Penna.*

Manufacturers of plain and cut Table Glassware of the highest quality.



**ENGLISH :: GLASS.**

Large Assortment of  
FANCY VASES,  
GENTRE PIEGES and  
ROCK CRYSTAL STEM WARE,

Particularly adapted for the  
Jewelry Trade.

Write for particulars.

Sole Agent for the Celebrated CAULDON CHINA.

**EDWARD BOOTE,**  
46 West Broadway :: New York.



**Hat Pin Holders**

New, Practical, Pretty,  
and Quick Sellers.

No. 823.  
Hat Pin Holder.  
Ladore.

WRITE FOR PRICES.

**Maple City Glass Co.,**  
CUT GLASS TABLEWARE,  
**Hawley, Pa.**

SALESROOMS:

New York—H. B. Stites, 253 Broadway.  
Baltimore—Green & Thomas, 33 S. Charles St.  
Boston—Sweetser-Bennett Co., 101 Tremont St.  
Buffalo—J. R. Stadlinger, 685 Main St.  
Indianapolis—J. A. Dugan Co., 22 S. Capitol Ave.  
Duluth—Duluth Crockery Co., 6th Ave. and West St.  
Denver—Western Selling Co., 1617 Lawrence St.

**The Riviere Brass & Bronze Works**

cordially invite the Trade to inspect their new line of

**Electroliers, Chandeliers and  
Brass and Bronze Novelties**

now on exhibition in their new showrooms (recently enlarged) at

**328-330-332 Seventh Avenue**

(Between 28th & 29th Streets)

**NEW YORK CITY**

**CROUCH & FITZGERALD**



**Jewelry Trunks and Cases**

177 Broadway  
Bet. Cortlandt  
and Dey Sts.

688 Broadway  
723 6th Ave.,  
New York

Established 1870.

Manufacturer of

**LOUIS W. HRABA, Fine Leather Goods,**

29 East 19th St., New York.

Exclusively for the Jewelry Trade.

**JACOT MUSIC BOX CO.**  
IMPORTERS.

Stella and Ideal Music Boxes

39 UNION SQUARE, N. Y.

**CLOCKS, BRONZES, CUT GLASS and ART NOVELTIES.**

WHOLESALE DISTRIBUTORS **COMMUNITY SILVER** SEND FOR CATALOGUE

**H. BEALMEAR & CO., 234-236 Park Avenue, Baltimore, Md.**

# THE CONNOISSEUR

*Devoted to Art Pottery, China, Marbles, Bronzes, Cut and Decorated Glass Ware, Bric-à-Brac, Lamps, Art Metal Wares, Fancy Goods and Kindred Lines.*



**Exhibit of Pottery, Glass, Silver, Pewter, Etc., of the Georgian Era.**

THE trustees of the Whitechapel Art Gallery have organized an interesting exhibition illustrating the Georgian era, as widely as their space and funds will allow, as a special contributor to the *Pottery Gazette* of London. This, the Spring exhibition, opened March 29 and closed May 1.

The committee aimed at presenting a survey of British art in the 18th century in its many sided character rather than at representing any one branch of it. The desire was to arouse rather than satisfy interest and appreciation in this period of national art, seeing that the spirit of the Georgian period is so predominant to-day, the present exhibition illustrating the art of that era is most opportune. The exhibits consist of paintings, sketches, engravings, prints, maps, mezzotints, books, silver plate, pewter, linen, costumes, needlework, furniture, pottery, glass, etc., and a number of interesting relics and curios. There are loans from the South Kensington Museum, and many are private collections have been generously lent by their owners. Some of them have not before been seen in a public exhibition. The pottery exhibits are of more than ordinary interest, and are entitled to mention here.

There is a Chippendale cabinet, lent by W. H. Spottiswoode, containing a collection of Lowestoft china, lent by W. W. R. Spelman, author of an interesting monograph on Lowestoft ware. Mr. Spelman is the owner of the greater portion of the molds, saggars and broken china recently discovered on the site of the old works, and which have established the fact, which was before a subject of doubt, that china was really made at Lowestoft. The discovery, however, points to the conclusion that it was made there only in comparatively small quantities. Mr. Spelman gave an interesting lecture on the subject, illustrated by lantern slides, at the gallery, April 18.

There is a fine collection of old Staffordshire pottery, lent by B. T. Harland, appropriately shown in another Chippendale bookcase, lent by Mr. Spottiswoode. While British porcelain of the Georgian era was largely copied from the Chinese and Continental wares, the pottery of the period was essentially British. Among the pieces lent by Mr. Harland are Astbury wares and white salt-glazed teapots, both made in the first half of the 18th century. The salt-glazed ware is very light, and has a rough surface. The teapots are curiously formed as houses, animals, shells, and even ships. Examples of what is called "Whieldon" pottery, the splashed wares, date about the

middle of the century. A collection of Bristol china is shown by Alfred Trapnell. In a large case in the center of the gallery, among other exhibits, there is a terra-cotta bust of Pope by Roubillac, with Staffordshire figures lent by Wilson Steers and some other specimens of pottery.

The authorities of the South Kensington Museum lent a representative selection of old English porcelain of the period illustrated by the exhibition. This includes good specimens of the soft-paste porcelain made at Chelsea, Bow, Derby, Worcester and other early factories. Another case of pottery from the South Kensington Museum contains examples of the figures for which Staffordshire potteries were famous. There are humorous groups on the lines of the familiar "Parson and Clerk," and a number of Toby jugs, busts and figures of the late 18th and early 19th centuries, colored in the showy style of the period. A case of Wedgwood ware, also from South Kensington, contained vases, plaques and medallions in the famous jasper ware, while the black "basalt" was also well represented. There was a section of a case (C) containing several interesting examples of old Adams ware.

There was a pair of 18th century Adams jasper oviform covered vases, on foot, with designs in relief, representing the seasons, and also a pair of vases and covers of the same period in solid pale blue Adams jasper with acanthus leafage in white relief and Romanesque border. Both pairs are of the period of 1780 and were lent by Percy Adams. H. Merton Thoms lent a number of transfer-printed pieces of Worcester, Longton Hall and Liverpool china. A number of cups, jugs and mugs were decorated with printed portraits of kings, queens and heroes of the time—a very popular form of china decoration. Most of the transfer-printed pieces shown were made at Worcester from 1756 to 1766. The process was first used in Liverpool, London and Worcester, and widely extended until it has become a very important branch of decoration in the potteries.

Preparations are being made for a new line of bric-à-brac that will be introduced to the trade by S. A. Weller, Zanesville, O. Samples will be shown about July 1 in the store of the New York agent, C. H. Taylor, at Park Place and West Broadway.

Burglars broke into the store of A. Seidensticker, 237 High St., Hamilton, O., a fortnight ago, but were frightened away before securing any plunder. The rear window had been pried open and foot marks were found on the floor of the store by Arthur Seidensticker on the morning following the robbery.

**Customs Decisions on Statuary, Glass Ware, Earthen Ware and Kindred Lines**

PROTESTS involving the duty on statuary, glass ware and earthen ware have been decided in the last week by the Board of United States General Appraisers, New York, as follows:

*Statuary, Bases for Busts.*—Protest, etc., of L. Straus & Sons, *et al.*, against the assessment of duty by the Collector at New York. Abstract 9303 (T. D. 26902) followed, relating to bases for busts.

*Cut and Colored Glass.*—United States *v.* Marcel Schmidt (3633) and United States *v.* D. Lisner & Co. (3647). United States Court of Appeals, second circuit, April 14, 1906. Nos. 153 and 199. Appeals from the Circuit Court of the United States for the southern district of New York. Appeals dismissed by consent. In the decisions below (T. D. 26462) the Circuit Court affirmed decisions of the Board of United States General Appraisers, Abstract 2175 (T. D. 25462) and Abstract 2519 (T. D. 25513), which had held certain articles composed chiefly of cut or colored glass to be dutiable as manufactures of glass under Par. 112, Tariff Act of 1897. Note T. D. 25486.

*Molded Earthen Ware With Single Color Glaze.*—United States *v.* L. Straus & Sons. United States Circuit Court, southern district of New York, April 27, 1906. On application for review of a decision of the Board of United States General Appraisers. Decision reversed by consent. The goods in controversy consisted of earthen ware embellished with molded designs and coated with a single-color glaze. They were held dutiable by the Board under Par. 96, Tariff Act of 1897, as earthen ware "plain white and without super-added ornamentation of any kind," against the Government's contention that it is dutiable under the provision in the same paragraph for earthen ware "painted, tinted, stained, \* \* \* or otherwise decorated or ornamented in any manner." For decision below see G. A. 6061 (T. D. 26443). The decision in this case was not on the merits of the contentions made, but was consented to on behalf of the importers because the correct contention was not made in the importers' protest.

## Decline of English Glass Production.

THE decline of the glass industry in Great Britain is a subject of discussion in that country, and is attributed to the free-trade policy of the nation. In 1871 the imports of glass goods were \$4,974,440 in value, and in 1904 \$18,636,500. In the meantime 30,000 British workmen in the glass trade were thrown out of employment.

The price of glassware in England now is said to be greater than if the goods were made at home, but foreign manufacturers would lower prices if English competition were increased.

Webb Huston is being sought by the authorities of Evansville, Ind., accused of obtaining \$365 from three banking institutions and articles of jewelry from Kruckemeyer & Cohn under false pretenses. Huston is said to be well connected in Evansville.



# ART Leather Goods

We now have on exhibition in our New York Salesroom a choice collection of

**EUROPEAN NOVELTIES**

IMPORTATION ORDERS SOLICITED

**C. F. RUMPP & SONS**  
Philadelphia

New York Salesroom, 683 and 685 Broadway



## The Thimble House.



No. 149.

Thimbles are not a side line with us—They are our main business. We study Thimbles, our designers study thimbles, our workmen study thimbles—The result is the finest and largest line of Thimbles on the Market.



No. 136.

**KETCHAM & McDOUGALL,**

Manufacturers,

37 & 39 Maiden Lane, New York.

Send for Catalogue.

Established 1832.

ALSO MAKERS OF THE NEW AUTOMATIC EYE-GLASS HOLDERS.

## HEINTZ BROTHERS.



We Make the Largest Line of Solid Gold Set Rings in America for the Retail Trade.

## BLANCARD & CO.,

96 MAIDEN LANE,

NEW YORK.

WELL MADE GOLD FINDINGS.

### CRANBERRY LAKE REGION OF THE ADIRONDACK MOUNTAINS

a section full of large fish is described in New York Central Lines Four-Track Series No. 32, which contains a beautiful map of this region printed in four colors. Copy will be sent free, postpaid, on receipt of a two-cent stamp by George H. Daniels, Manager, General Advertising Department, Room 61-A, Grand Central Station, New York.

THE



TAKE YOU TO THIS REGION FROM EVERY DIRECTION

C. F. DALY  
Passenger Traffic Mgr.  
NEW YORK

W. J. LYNCH  
Passenger Traffic Mgr.  
CHICAGO

## SIGNS

WE make the kind that people notice. Silent speakers that are always telling about you. Fac-simile of signatures sawed from metal for cementing to windows. "No trouble to ship out of town."

**THE FORMAN CO.**  
SIX LIBERTY PLACE  
NEAR MAIDEN LANE · NEW YORK

**A. Nonnenmann & J. Aschenbrenner,**  
114-118 East 23d St., New York.

**Original Designers** for Platinum, Gold and Silver Jewelry. Artistic Designs for Silverware and Novelties furnished at shortest notice.



REVIVAL OF CHINA BIRD ORNAMENTS.

THAT old styles come round again is indicated by a glance at bird ornaments which are now seen in some importing houses and which were familiar in the stores of 40 years ago. The birds, usually of life size, are sometimes suspended within golden rings, which may be conveniently hung almost anywhere. Other birds are placed upon standards, which also serve for match cases and for other similar useful purposes. The material is china highly colored to represent the varied plumage of the winged tribe. One of the importers said that the molds which had been used in the German factories nearly half a century ago and had been thrown aside for many years, were recently taken out again. They were then used in producing the present collection of bird ornaments, which are enjoying much of their old time popularity.

GERMAN CHINA BRIC-A-BRAC.

IN the salesrooms of Chas. Ahrenfeldt & Co., 52 Murray St., is an attractive line of German china bric-à-brac in drab background and relief ornamentation in bronze effects; several fine, large vases are ornamented with female figures, executed in full relief and in *art nouveau* styles. Other vases come in Greek form, with medallion ornaments, showing classical heads. Among the novelties are windmills, with children in playful attitudes, and maidens holding flower bowls. Another piece has a maiden filling a water jug from a spring, under which is a bowl.

FRENCH china in a satisfactory demand for French china.

Importers say that the import season now drawing to a close has been satisfactory in the volume of business that has been booked. Although the bulk of the orders were obtained in the early months of the year, scattered requests have been coming through May. By the middle of June the import business will be closed, and the attention of the importers and manufacturers will be given to the production and distribution of the goods. The heaviest deliveries are generally made in August and September, about the time that the American agents visit the factories for the purpose of selecting samples for the following year's business. The designers of the large houses have been busy all year and the result of their work will be submitted toward the end of the Summer to the inspection of American agents who pick out the works which in their judgment will appeal most strongly to the trade in this country.

The offerings, when they reach New York, therefore, represent the combined skill and discrimination of artists and business men.

The cut glass manufacturers quite generally agree that the past season has been prosperous. While the orders naturally diminished as the warm weather approached, yet even through May business was far from being at a standstill. The inquiries which are coming from buyers indicate much interest in the offerings to be made for new season, now about to open.

THE RAMBLER.

Recent Tariff Changes by Foreign Countries.

THE new tariff of Spain, which goes into effect July 1, has two scales of duty, the first and general scale, referring to products and all merchandise of countries generally, and the second, the rate to be applied to goods of countries which concede their lowest duty to Spanish products; provided that the Spanish Government considers such duties show sufficient reciprocity to warrant this concession. Among the rates that may interest manufacturers of the jewelry and kindred trades are the following:

	Scale I. Pesetas.	Scale II. Pesetas.
Mirrors .....	100.00	100.00
Silver-plated goods, per kilo.....	9.00	6.00
Optical instruments, per kilo.....	15.00	15.00
Gold watches, each.....	20.00	15.00
Silver watches and those of other metals, each .....	4.00	2.00
Works of clocks, and parts of same not otherwise provided for, per kilo .....	5.00	3.50

Consul Ruffin, of Asuncion, Paraguay, in speaking of the customs law which went into effect March 15, says the percentage of duty to be paid remains the same as fixed by the law of 1899. Among the lines which pay 5 per cent. ad valorem are gold and silver jewelry, with or without gems; scientific instruments, with or without handles adorned with gold, silver or platinum; gold and silver watches, and utensils of silver.

Among those paying 40 per cent. ad valorem are crystals in general, books covered with tortoise-shell, mother-of-pearl, ivory, imitation of pearl, or having embossings of gold or silver. Cases in which jewelry, etc., are enclosed are to be declared apart from their contents. Delft glass and porcelain, which come with other articles, will be weighed apart, adding 25 per cent. tare for brute weight to the delft and glassware, and 30 per cent. to the porcelain.

Testing Pottery by Touch and Smell.

IN the general overhauling which the Metropolitan Museum of Art, New York, underwent through its change in management, the Japanese pottery exhibits received their fair share of attention. Professor Morse thoroughly, but rapidly, tested the catalogue identification of every piece. It is reported that in most cases the touch of his fingers tells him what he wants to know about the date of any vessel. Sometimes the sense of smell comes to his aid, as in the case of certain forgeries, whose beautiful deep tone has been produced by boiling in oil.—*Pottery Gazette*.

Arabia's Ancient Turquoise Mines.

THE goddess of turquoise and the turquoise mines in old Arabia are the things Prof. Petrie, the English archaeologist, has been studying, says a daily exchange. As a member of a scientific exploring party he spent several months among the mountain ranges of the Sinai district of old Arabia, on a stretch of level ground some 2,300 feet above sea level. There they pitched their tents, accompanied by 30 workmen and the native chief of the district.

At the top levels was the sandstone in which were caverns worked by parties of ancient Egyptians for turquoise. Some tablets still remaining showed that those parties were carefully selected and carried on their labors systematically. Here, in this desert region, to which supplies of food and water had to be brought from a long distance, the men mined in companies of 500 or 600. The usual time for the search was from December to March. One expedition had conveyed to it daily something like five tons of food. The caverns themselves were examples of patient industry.

The famous temple of the goddess of turquoise, to whom the workers did homage, was 250 feet long and contained a range of chambers or courts. From one of the tablets it appeared that a certain expedition went out of the recognized season. But its labors were successful and were therefore duly acknowledged with great gratitude to the patron goddess.

Of the ancient inscriptions 250 have been copied. They have an important bearing on the age of the turquoise expeditions, long before the birth of Christ, as well as on the Semitic form of workship in vogue before the establishment of Judaism.

Mining for Rubies in Burmah.

THE system practiced for obtaining rubies in the mining districts in Burmah is of the most primitive description, says the *Searchlight*. The mining shafts are simply holes about two feet square, sunk to a depth varying up to 50 or 60 feet. The shoring up of the walls of the shaft is most crude, the sides being supported by posts at the corners and branches of small trees secured carefully against the sides by means of stout sticks.

The miner carries a tin pot similar in shape to a blunt-edged cone on his head. He squats down in one corner and digs between his knees in the opposite corner. The earth or *byon*, as the ruby-bearing earth is called, is conveyed to the top, as fast as it is excavated, in small buckets let down from above.

The apparatus for raising and lowering the buckets is simple in the extreme. A stout bamboo post about 20 feet high, called a *maungdine*, is fixed upright in the ground at a convenient distance from the pit or dwin, and a long, thinner bamboo pivoted horizontally into the upper end of it, so as to project an eighth from the mine and the long arm toward the mine.

C. W. Ernsting, San Diego, Cal., has renovated his store and erected a new street clock in front of his establishment.

*Mercantile Fountain Pen*

# The Best Self-Filling Attachment

made and guaranteed by

**AIKIN, LAMBERT & CO.,** 19 Malden Lane, NEW YORK.

Retail Price:

**\$3.00**

**\$3.50**

**\$4.50**

Send for Price Lists and Discounts.

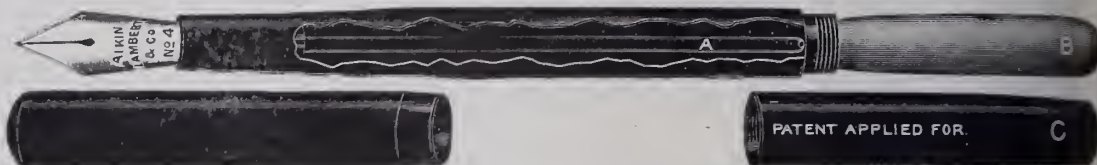

## FISHING MADE EASY

By Using  
The Greer  
Pat. Lever  
Hooks.

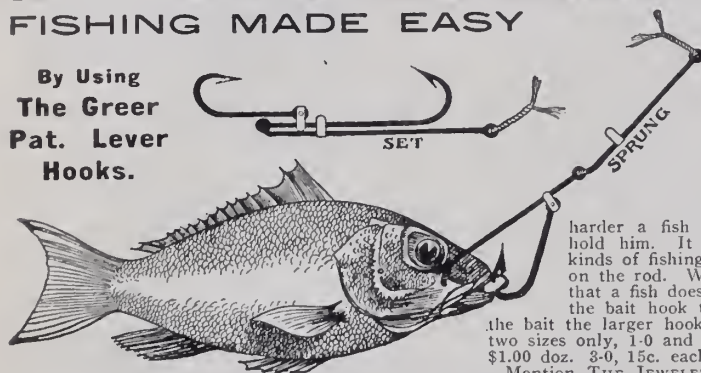

## THE BEST FISH HOOK ON EARTH

for Sea, Lake and River Fishing. No losing bait, nor coming home without your largest fish. No breaking loose or tearing out. No one can afford to fish without one. No springs to get out of order. It is simple and strong, being a lever, the harder a fish pulls the stronger it will hold him. It is easily adjusted to all kinds of fishing by sliding the little clamp on the rod. We claim for the lever hook that a fish does not have to be hooked on the bait hook to get him, if he pulls on the bait the larger hook will spear him. Made in two sizes only, 1-0 and 3-0. Price: 1-0, 10c. each; \$1.00 doz. 3-0, 15c. each, \$1.50 doz. Mention THE JEWELERS' CIRCULAR-WEEKLY.

Manufactured by **GREER MANUFACTURING CO.,** Atlanta, Ga.

# ROLLED GOLD PLATE SEAMLESS WIRE AND TUBING

**DUNBAR, LEACH, GARNER CO.,**

MANUFACTURERS,  
ATTLEBORO, MASS.

# FAIRCHILD & COMPANY

225 to 233 Fourth Ave.

NEW YORK CITY.

Manufacturers of GOLD PENS, PENCILS, PENHOLDERS, SEGAR CUTTERS, SPECIALTIES, PENCILS SET WITH JEWELS.

Style, quality and workmanship acknowledged the very best.



# Two Telephone Systems

in Greater New York would mean for Business Men

Two Books to Consult  
Two Bells to Answer  
Two Bills to Pay

## MAEBERT & REIS!

WATCHMAKERS TO THE TRADE  
Wheel Cutters and Adjusters

Accurate Work—Low Prices—Quick Return  
We receive parcels by mail or express from over the United States.

71 and 73 NASSAU ST., Corner John,  
(The New "Cockcroft" Bldg.) NEW YORK

# DIAMOND POINT FOUNTAIN PENS



No. 2WC \$7.50 per dozen. Guarantee in every box.

Largest Manufacturers of Popular Price Fountain Pens in the United States.

Send for Illustrated price list of 14 Kt. Gold Fountain Pens.

Good case assortment 1 dozen pens, \$9.00.

DIAMOND POINT PEN CO.

100-102 Beekman Street, New York

# PLATINUM AMERICAN PLATINUM WORKS NEW YORK OFFICE 41 Cortlandt Street NEWARK, N. J.

# HOLTZER=CABOT JEWELERS' MOTORS

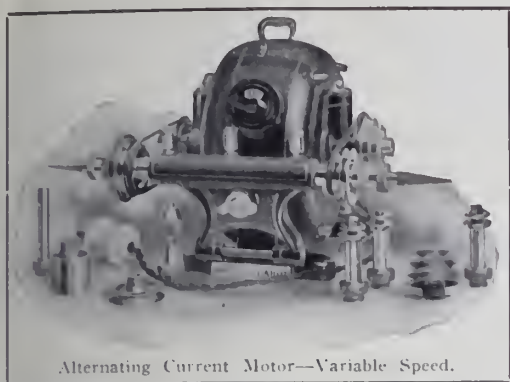

Alternating Current Motor—Variable Speed.

for *BUFFING and GRINDING*

have had a four years' trial in practically all classes of work. Made for Alternating and Direct Current Circuits, in sizes—1/5 to 1 H. P.—to carry buffing and grinding wheels up to 10 inches diameter.

A full line of chucks for all requirements.

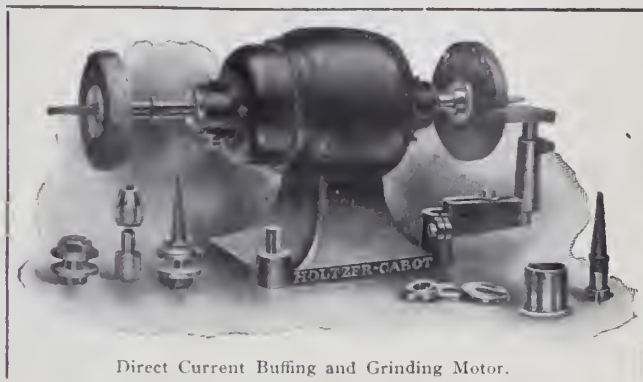

Direct Current Buffing and Grinding Motor.

All our motors are covered by a guarantee of one year.

Write and tell us what class of work you would like to do and we will send you our Form 409, "Special Announcement and Proposition to Jewelry People—

A LATHE MOTOR ON TRIAL."

**THE HOLTZER=CABOT ELECTRIC CO.,** Boston (Brookline), Mass.

CHICAGO OFFICE, 395-7 Dearborn Street.

## CRUCIBLES.

Jewelers' Supplies,  
Etc.

Established 1850.

**J. & H. BERGE,**  
98 John Street,  
NEW YORK.



**CASTINGS** Gold, Silver, Bronze, Brass,  
German-silver, Copper & Iron,  
Supply Jewelers, Silversmiths,  
Die-makers, Mould-makers, etc.  
L. D. Tel. 2072 L.  
Unbreakable Bronze Forces. Hard Bronze Engraving  
Plates. Cast Iron Forces for making Steel Dies.  
Chandelier, Undercut Work, Statuary.  
**AUGUST GRIFFOUL,** 313 HALSEY STREET,  
NEWARK, N. J.

**F. JEANDHEUR, Jr.**

near 17 John St., N. Y. Third Floor.

**Gold and Silver Plating**  
SPECIAL WORK AND COLORING  
IN ALL SHADES A SPECIALTY.

Established 1868. **Platina Plating.**

## PATENTS

obtained on inventions and designs. Trade-  
marks, prints and labels registered.

**R. W. BISHOP,**  
ATTORNEY AT LAW,

28 C Street N.W., Washington, D. C.

## LEARN WATCHMAKING AT HOME

THE De SELMS CHART SYSTEM, copyrighted and patented. The  
simple, practical and up to the minute method of learning.  
Saves you time and money while learning and puts you in a position to  
more than double your income.  
A million timepieces to be repaired. Accurate time is a necessity in the  
modern world. When time is money the watchmaker gets his share of  
it. Positions for graduates. Booklet free. Write to-day.

The De SELMS WATCH SCHOOL,

109 Perry Street, ATTICA, INDIANA.

Above Cut Shows Our  
**METAL SPINNING LATHE**  
We manufacture these lathes in sizes from 12-inch to 44-inch Swing,  
and can equip sizes 18-inch and larger with our Chucks for oval work.

Write for  
Catalogue  
**P. PRYIBIL,** 512-524 W. 41st St., New York.

# Bastian's Class Pins and Badges

When you handle Bastian Bros' Class Pins and Badges, you handle goods that are known to every intelligent person wherever English is spoken. We have advertised extensively and persistently in Leading Magazines until the name of Bastian bears the same relation to class pins that the name Elgin does to a watch.

No other manufacturer can meet our prices—it is an impossibility for him to do so—because we own the only patented process whereby one girl with one machine can do the work of six skilled workmen.

Note these Prices:

Silver-Plated Pins, per doz.,	\$1.00
Sterling Silver Pins, "	2.50
Gold Plate . . . . .	3.00
Solid Gold . . . . .	15.00

## 25% Discount to Retailers

Silver-Plated Pins retail at 10 cents and Sterling Silver at 25 cents. They are finely made of heavy metal, and on the Sterling Silver Pins the best French enamel is used.

We also make to order Badges, Medals and Buttons in either Gold, Silver, Bronze or Ribbon, and we rigidly guarantee everything we make.



OUR HANDSOME NEW CATALOGUE IS FREE TO JEWELERS.  
**BASTIAN BROS.,** N. 21 South Avenue  
 ROCHESTER, N. Y.

**WM. F. RENZIEHAUSEN CO.,**  
**GOLD and SILVER REFINERS**  
 Sweep Smelters, Assayers and Analytical Chemists  
 Rolling of FINE AND STERLING SILVER a Specialty.  
 Long Distance Telephone, 3759-R. 45-49 Oliver Street, NEWARK, N. J.

**MERIT:—**  
**DISPATCH:—**  
 Two of the many pertinent factors that make us excel.  
**CONLEY & STRAIGHT,**  
 Gold and Silver Refiners,  
 Assayers and Sweep Smelters,  
 236 EDDY STREET, - PROVIDENCE, R. I.  
 Dealers in Fine Gold, Silver and Copper. All kinds of Gold and Silver Anodes

**JAMES J. DONNELLY,**  
 Gold and Silver Electro Plater,  
 Fire Gilder and Colorer,  
 41 and 43 Maiden Lane, New York  
 Prompt Attention Given to Mail Orders.

Frank Dederick. Established 58 Years. James E. Dederick.  
**James H. Dederick's Sons,**  
 Assayers and Bullion Dealers.  
 All qualities of Gold and Silver, in Plate, Square and Round Wire, Rolled to any gauge.  
 ALL QUALITIES OF GOLD AND SILVER SOLDER.  
 16 Maiden Lane. . . . . NEW YORK.  
 We buy Old Gold and Silver.

**HONEST AND PROMPT RETURNS FOR YOUR OLD GOLD, SILVER FILINGS, SWEEPINGS &c..**

**WE BUY**  
 Old Gold and Silver Filings, Polishings, Sweeps, Hand Washings, etc. We will make accurate valuations and hold consignment subject to your acceptance. If valuation is not satisfactory, we reship to you at our expense.  
**WE PAY FOR OLD GOLD:**  

22 K. 88c. per dwt.	12 K. 48c. per dwt.
20 K. 80c. " "	10 K. 40c. " "
18 K. 72c. " "	8 K. 32c. " "
16 K. 64c. " "	6 K. 24c. " "
14 K. 56c. " "	4 K. 16c. " "

 MARKET RATES FOR SILVER AND PLATINUM.  
 Try us and you will appreciate our Squareness, Promptness and Accuracy.  
**T. B. HAGSTOZ, Ltd.,** Main Office, 709 Sansom St., Philadelphia, Pa  
 SMELTERS, ASSAYERS, REFINERS.

**WE SELL**  
 Gold, Silver and Platinum, various qualities, rolled flat or drawn to wire of any gauge.  
**PRICES OF ALLOYED GOLD:**  

10 K. 48c. per dwt.	14 K. 64c. per dwt.
12 K. 56c. " "	16 K. 72c. " "
18 K. 80c. per dwt.	

 Gold and Silver Solder, either from formulas furnished or our own. "T. B. H." Alloy, 25c. per oz. Guinea Gold, 75c. per lb. Shot Copper, 40c. per lb. We will send table for alloying without charge. They save figuring.





M2417

# FAHYS Montauk Case



M2773

Unless it perform its function, the greatest force ever devised is of less use than a baby's rattle to a full grown man; it is the performance that counts.

You must grant us that we have the force, the organization to manufacture the best 20 year case on the market.

Every jeweler knows the Montauk to be the best 20 year case, and those who have bought it before are buying it again, which is a good indication that it is the case the people want.

JOSEPH FAHYS & CO.

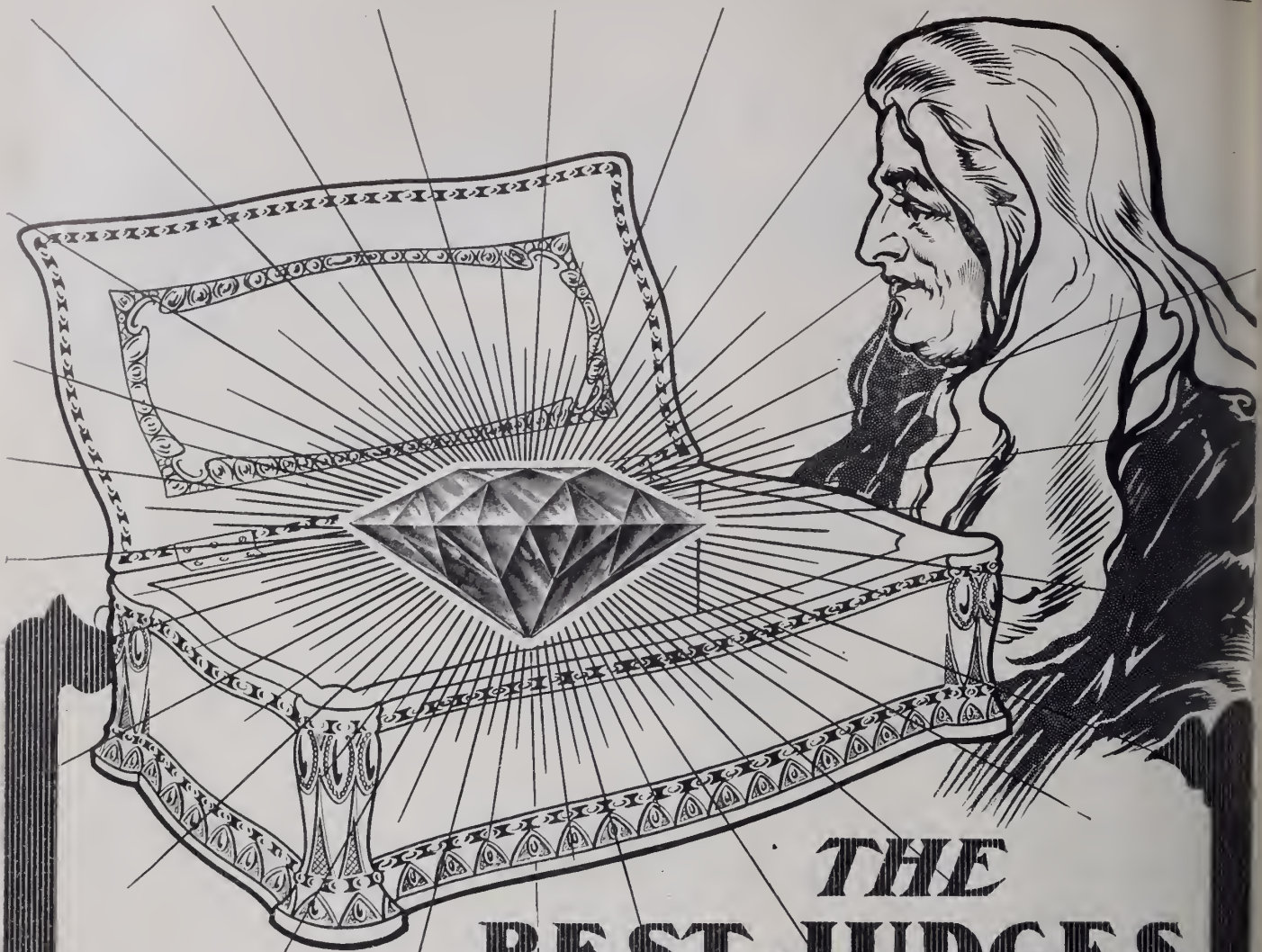

## THE BEST JUDGES

Are the most critical as to the cutting, when considering the worth of a diamond—it's the cutting that makes the diamond brilliant—it's because of its brilliancy that the diamond is so highly prized.

The diamonds we offer are cut in our own cutting works, and no effort spared to see that they are cut right. The price we ask for them—the actual cost of the rough stone, plus the workmen's wages, with our modest profit added.

---

**J. R. WOOD & SONS,**  
Diamond Cutters,

Cutting Works:  
1327-1329 Atlantic Ave., Brooklyn.

2 Maiden Lane, New York.





## We Stand Behind Everything We Sell

guaranteeing it to be exactly what it is represented to be.

You can be perfectly sure that you are getting the quality you think you are buying, and that the workmanship is the very best obtainable—while you are paying nothing extra for this, for our prices are the lowest it is possible to furnish honest goods for.

**J. R. Wood & Sons,**  
RING MAKERS.

2 Maiden Lane,

New York.

# We Have Doubled our Line for the Fall Trade

in Vest Chains, Guard Chains, Fobs, Locketts, Grand Paris, etc., coupled with a large number of new ideas which we will not dwell upon at this time. When you see our line you will wonder at our new creations, and it will bother you to know how we can give you so much for the money. Don't mention it to anyone.

## Design, Workmanship, Quality and Durability

are the four factors which have made the

# BIGNEY CHAINS

the most popular in the market to-day. They are handled and worn by more people than any other make.

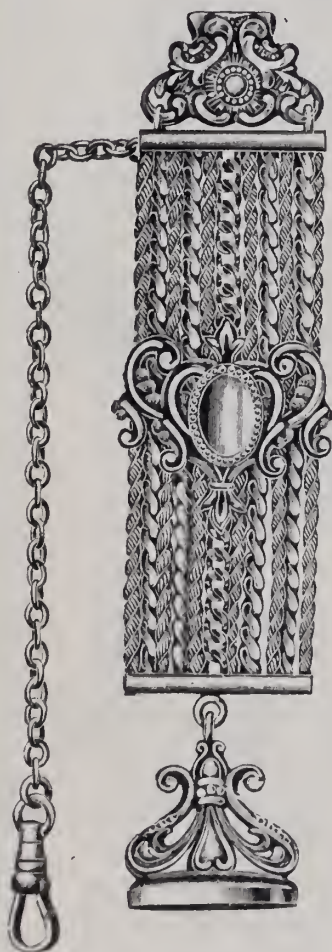

# S. O. Bigney & Co.

NEW YORK OFFICE,  
3 MAIDEN LANE.

FACTORY, Attleboro, Mass.

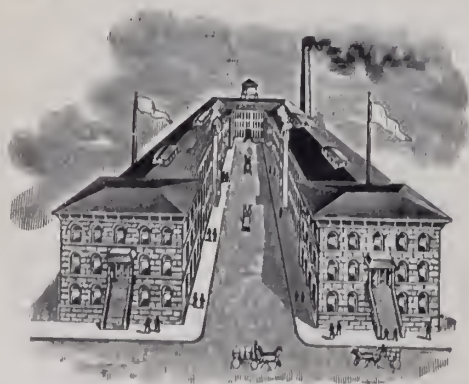

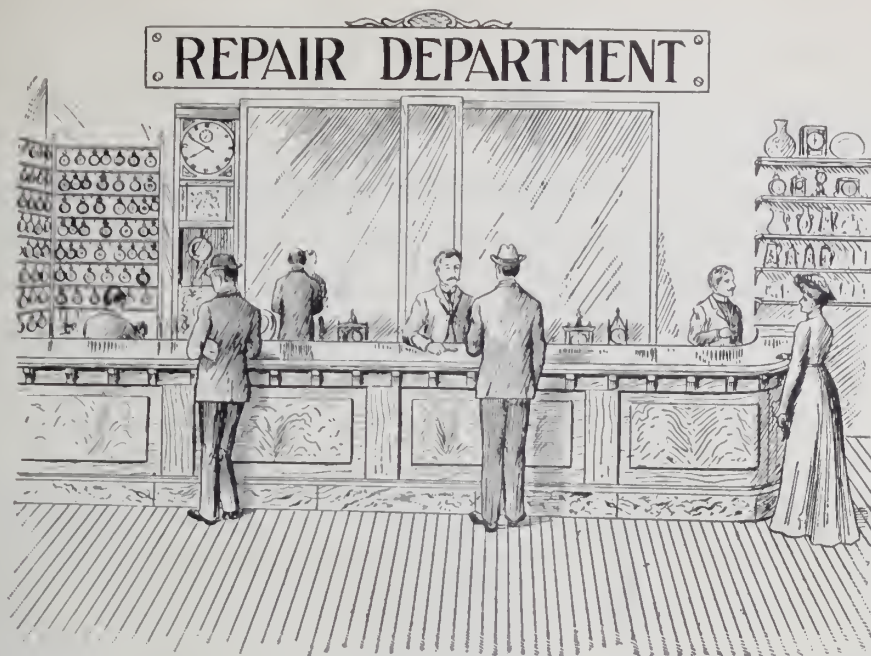

# The REPAIRING

END OF YOUR BUSINESS IS THE  
MOST IMPORTANT PART OF IT

More people come into your store to leave work than to purchase goods.

Almost every one of your good customers became so through your repair department.

Progressive jewelers know this and concentrate their efforts on the repair department of their business. They give it the most prominent place in their stores; they emphasize it in all their advertisements; they keep themselves and their employes thoroughly informed on the costs of all kinds of work, new ideas and methods; they are courteous and accommodating to repair customers; have all work ready when promised; and do only such work at home as they can do well.

They send all the rest to us.

We devote our entire time, energy, capital, and twenty-five years' experience to this important branch of the jewelry business; employ and educate the best help that can be obtained; systematize and inspect the work, and use every modern method to produce the best work promptly at reasonable prices.

It is to your interest to do business with us, it is to our interest to have you.

Let us work together.

## WENDELL & COMPANY

The Special Manufacturers for the Retail Jewelry Trade  
Do a larger variety of work than any other firm in the country

TWO WONDERFUL SHOPS:

103 and 105 William Street  
Near Maiden Lane  
NEW YORK

57 Washington Street  
Near State Street  
CHICAGO

## WADSWORTH PERMANENT

**T**HE WORD "PERMANENT" naturally carries weight. Purchasers want *lasting quality*. This is as true of filled cases as of solid—maximum of wear is the final test.

### **"WORTHY OF ITS NAME."**

The above phrase is linked with the WADSWORTH "PERMANENT" WATCH CASE. To Durability is added Style; and to both, Inexpensiveness. Jewelers endorse these claims.

## *The* Wadsworth Watch Case Co.

CHICAGO  
Columbus Building

SAN FRANCISCO  
717 Market St.

NEW YORK  
49 Maiden Lane

FACTORY, DAYTON, KY.

---

---

The Case that has won the Permanent Friendship  
of all who have Made its Acquaintance.



Your Jobber can Introduce You.

## *The* Wadsworth Watch Case Co.

CHICAGO  
Columbus Building

SAN FRANCISCO  
717 Market St.

NEW YORK  
49 Maiden Lane

FACTORY, DAYTON, KY.

---

# Simmons Golf Chains

These pony Golf or Shirt Waist Chains are first-class summer-season sellers. They are the most attractive, convenient and serviceable chains for outing wear that have ever been offered.

The safety fastener is our own patent and can be had with no other chains. It is simple, strong, absolutely secure and easily adjusted—has no prongs to tear vest or trousers' band.

Order a trial assortment of your jobber; if he can't supply you, we'll send you direct a selection and render bill through any reliable wholesale watch and jewelry house you may name.

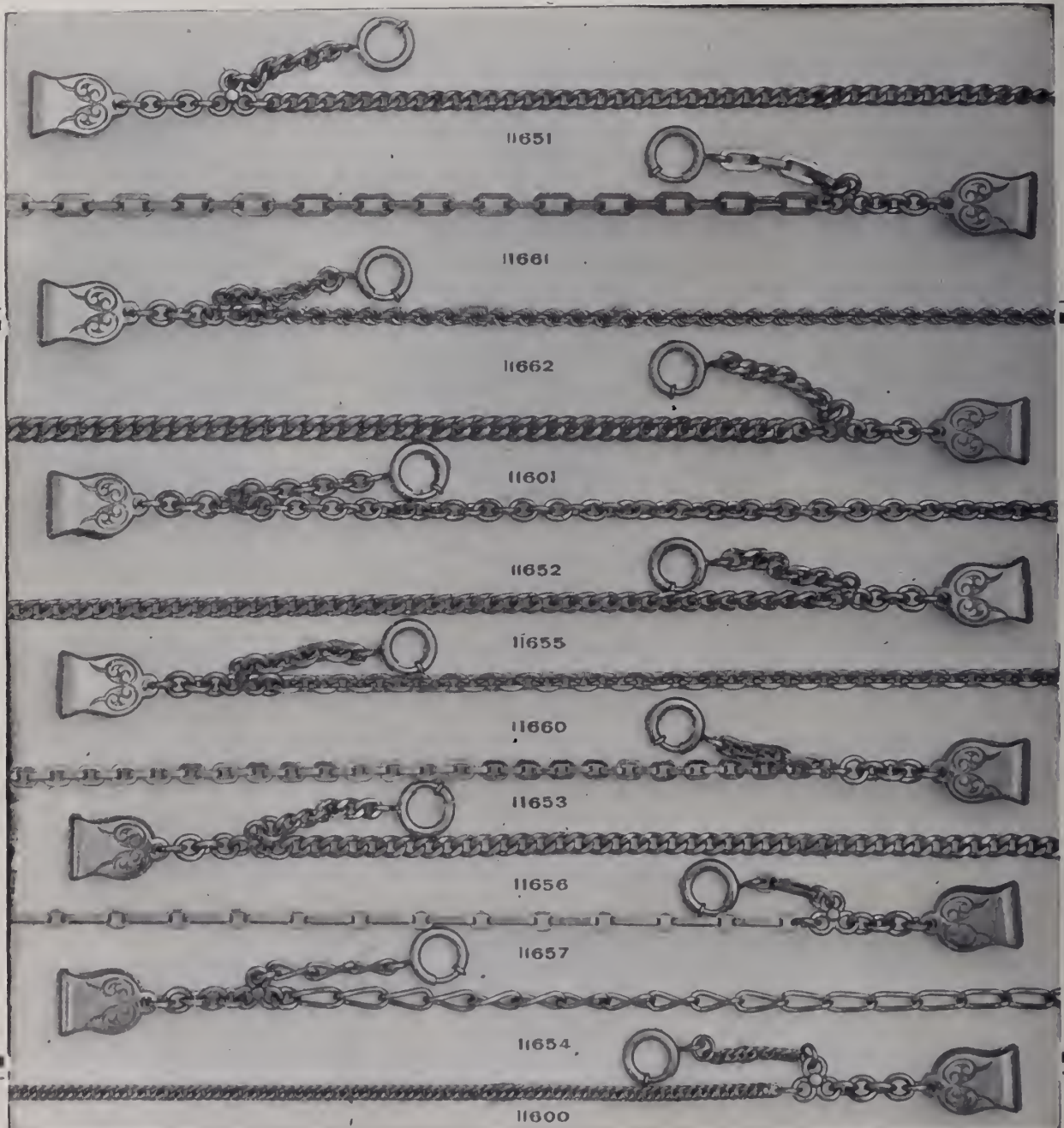

**R. F. SIMMONS COMPANY,** Main Office and Works, **ATTLEBORO, MASS.**  
 Salesrooms: 9-13 Maiden Lane, New York; 42 Madison St. (Heyworth Building), Chicago.





**S**ILVERWARE destined for the general service and adornment of the table should, in order to be wholly satisfying, possess not only a markedly decorative effect, but an opulent dignity and a well defined individuality of design.

¶ It is the belief of the Whiting Company that in their new Louis Quatorze pattern, which has been applied to every article suitable for table use, these essentials of success are very prominently displayed.

¶ With the confidence born of this belief, therefore, they beg to call attention to their novel and original treatment of one of the most popular, as it is one of the most effective, of historical styles.



**WHITING MFG. CO., SILVERSMITHS**  
 Broadway and 19th Street, New York.

# Is There a Watch Trust ?

Is a Live Topic at the Present Time in Congress.

## **This Question Will be Fully and Able Elucidated**

and every jeweler is urged to keep posted on this subject, as it will be not only instructive, but profitable to know of abuses that are of vital interest to all who sell Watches.

Why should the retail jeweler have to pay more for Watches than do department stores and mail order houses and scheme trades? is an old question.

**And now comes another question of discrimination that is worthy of long discussion in the Congress of the United States.**

The essence of the question is:

**Why can American Watches be bought in other Countries for little more than half of what Americans at home have to pay for them ?**

All who have the interest of the Watch business at heart can have copies of the speeches on this subject sent on application.

## **The W. J. JOHNSTON COMPANY,**

Wholesale Agents for the Leading American Watch Companies,

**Fifth Avenue and Market Street, Pittsburgh, Pa.**

# **The W. J. JOHNSTON COMPANY,**

Wholesale Agents for the Leading American Watch Companies,

**Fifth Avenue and Market Street, Pittsburgh, Pa.**

We present a list of Watch Companies that we are Wholesale Agents for, each and all of whom are **Free, Independent** and **Self-respecting**, who manage and mind their own business, and depend only on the merits of their goods to make sales for them.

Not one of these Companies is a member of any Watch Trust or allied to any Watch Combination, and in no manner requires Alliances to help, or force, the sale of its products.

## **The Dueber-Hampden Watch Co.**

**Illinois Watch Co.**

**Hamilton Watch Co.**

**Trenton Watch Co.**

**Seth Thomas Watch Co.**

**New England Watch Co.**

**Jos. Fahys & Co.**

**Wadsworth Watch Case Co.**

**Dueber Watch Case Co.**

The products of these Companies are made for The American Market and they recognize the right of Americans to get as much for their dollar as do the people of other countries.

# THE WESTERN CLOCK MFG. CO. LA SALLE, ILL.

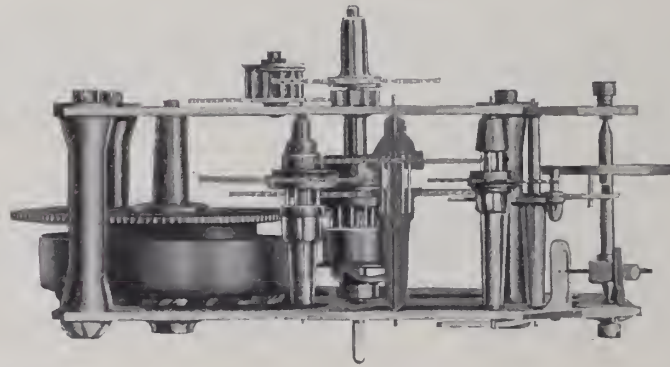

## THE AMERICA ALARM AND CLOCK

The AMERICA Alarm is what most alarms are not ; a clock, an accurate timekeeper, besides a mere sleep breaker.

**BECAUSE** the WESTERN casting process permits to make pivots of a highly polished wire, of the hardest steel and only 21 thousandths of an inch thick.

**BECAUSE** these pivots transmit to a hard steel and brass train the initial power, supplied by an elastic non-breaking mainspring, with a minimum friction loss.

**BECAUSE** the WESTERN hard steel pallets, locking and unlocking 250 times per minute on a clubbed-tooth wheel, produce an absolutely perfect escapement.

**I**T is the unanimous opinion of those jewelers who have examined the new O and 12 size movements of the ILLINOIS WATCH CO. that they are the best watches in these sizes ever manufactured in America.



## It's Time to Go Yachting and Camping

Every jeweler should see that his stock is complete with Sternau Chafing Dishes, Dainty lunches, such as lobster a la Newburg, clams in every style, etc., can be prepared on board the yacht or at the camp, to satisfy the most fastidious.

The Chafing Dish with its accessories is almost indispensable where yachting and camping are concerned. Made in nickel-plate and silver-plate.

Our Traveling Companions and Touring Chafing Dishes are also desirable for yachting and camping. They take up but little room when not in use, as their parts are collapsible and fit into the cup or dish.

New York Showrooms:  
Park Place, cor. Broadway,  
Opposite Post Office.

**S. STERNAU & CO.**  
*Makers of Coffee Machines, Fancy Kettles,  
Trays, Smoking Sets, etc.*

Office and Factory  
195 Plymouth Street,  
Brooklyn, N. Y.

**A**FTER we have made your acquaintance through our advertising, we find it no trouble to become intimate. Our goods do that for us. There is a certain standard to be reached in manufacturing. Well-made jewelry, exclusive designs, of **10K that is 10K**, is the standard. If this is the center of the target, then we have struck a "bull's eye."



No. 804.

LOCKETS  
BUTTONS  
BROOCHES  
BRACELETS  
PEN KNIVES  
CIGAR CUTTERS

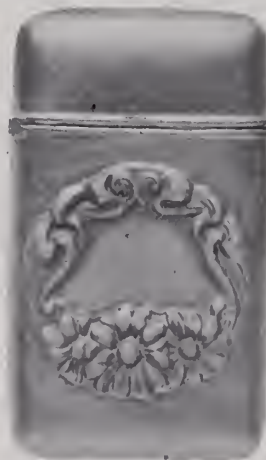

No. 700-36.

MATCH BOXES  
SCARF PINS  
BEAD NECKS  
TIE CLASPS  
HEART CHARMS  
FOBS, Etc.



No. 802.

Made in the best way possible is our goal, and with our low prices in the lead we easily cross the tape far in advance of our closest competitor. Write for selection package, "Dept. C," and convince yourself

**ROBT. LEVY,** MANUFACTURING JEWELER  
Green and Columbia Streets, Newark, N. J.

*"We never follow the Fashion, the Fashions Follow Us."*

MAURICE L. POWERS.



JOSH W. MAYER.

*Always in Red.*

## Distinctiveness.

SOME ONE with a mental twist that lets him say profound things cleverly, offers this: "We incline toward perfection through expression—by doing a thing as well as it can be done constantly and consistently it becomes a habit." We have found it so in the manufacture of our new productions—for them we can promise much—a deal more than you have ever found in Diamond Mounted Jewelry other than ours. Be specific, say you? Good. The first vital essential is the making—ours is expressive. It insures distinctiveness and character, perfect unity in proportion and grace in every line and curve.

The second is the style—that rests with you. We will present at our coming exhibition, to be held in our offices from August 13th to 18th inclusive, hundreds of different models, from the extremely conservative to the most radical which good taste sanctions.

Then the materials; we had rather not enter into a discussion nor will we evade the issue. No matter what price you elect to pay for any of our productions, we pledge ourselves as to the excellence and high grade of the Diamonds, Sapphires, Emeralds, Pearls or other precious stones used in any of our goods. That ends our contention, excepting the prices, which are our magnet, being the lowest in the market for the quality of goods.

Once a visit always a visit.

## POWERS and MAYER,

Makers of Diamond Mounted Jewelry THAT SELLS.

258-260 Fifth Avenue,  
NEW YORK.

We are always pleased to ship goods on memorandum when satisfactory references are given.



**J**UNE is the month of roses and we are busy all month turning out "Rose" jewelry for the Fall season. Our trade-mark, the "Rose," on any article stands for quality and excellence and has a reputation of forty years back of it.

Our new seller, "The Rose" thin model Swiss 15 jewel watch, cased up by the Crescent Watch Case Co., is moving rapidly and the trade who have handled same report sales right along. We have placed a rush order for an additional large quantity. If not already supplied, write us for sample.

## HENRY FREUND & BRO.,

71 NASSAU STREET, NEW YORK.

Elk and Eagle Goods a Specialty.

"Sellers of Sellers."



## THE Bracelet Hit OF THE Season.

**T**HE illustrations, which are exact size, show two of the best selling Bracelets of a big bracelet season.

Made of Rolled Plate, Pierced, Engraved—a neat, strong joint and catch—with and without stones, from  $\frac{1}{2}$  to  $1\frac{1}{4}$  inches wide.

Our line offers an unsurpassed range of styles.

ASK YOUR JOBBER—HE HAS THEM.

**WHITING & DAVIS, Plainville, Mass.**  
NEW YORK OFFICE, 7 MAIDEN LANE.



**NORMA**  
TRADE MARK

# The New NORMA

## Patented Adjustable Bracelets

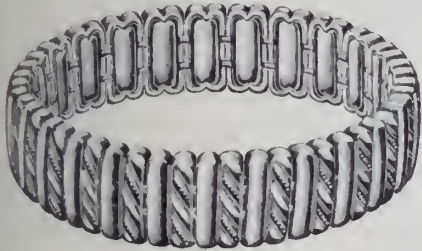

No. 253.



No. 265.



No. 254.



No. 271.



Examine our Popular Prices  
ranging from

**\$16.50 to \$36.00**  
per dozen

The illustrations represent a few of the many styles we make.

THE QUALITY OF ALL THESE  
GOODS IS FULLY GUARANTEED

Send for our new illustrated booklet of patterns and prices.

MADE ONLY BY

**The F. H. Sadler Co.**

80 County Street,  
ATTLEBORO, MASS.

Address all communications to Attleboro, Mass.

New York Office, - 180 Broadway.  
Room 43.

**NORMA**  
TRADE MARK

We Make

# BRACELETS

both in Joint and Nethersole — with and without stones.  
Call on us for the P. & B. Co. lines of

FOBS, LOCKETS,  
TIE CLASPS, BROOCHES,  
SCARF PINS,  
HAT PINS.

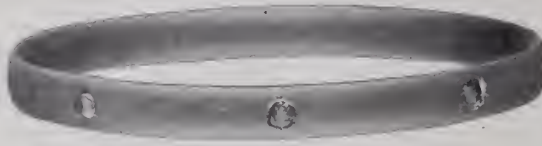

BABY PINS, BEAD NECKS,  
CUFF BUTTONS,  
CROSSES, BRACELETS,  
AND WAIST SETS.



We are the largest  
Exclusive Makers of  
10K. Jewelry.

Potter  
&  
Buffinton  
Co.,  
Providence,  
R. I.

NEW YORK OFFICE,  
65 Nassau Street.  
San Francisco Office,  
206 Kearny Street.



Our New  
ACME  
Joint.  
Pat. May 22 1906.

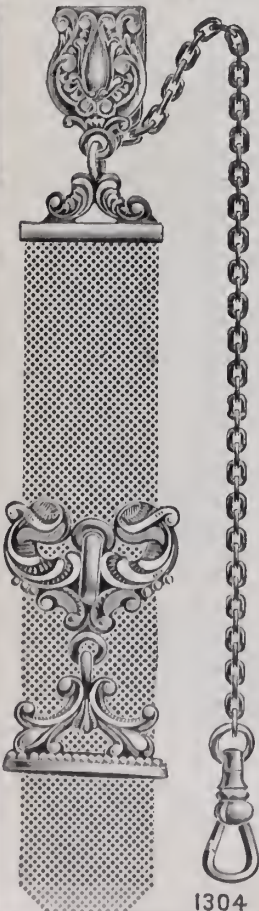

1304

# BATES & BACON,

NEW YORK OFFICE  
9 Maiden Lane

ATTLEBORO, MASS.

CHICAGO OFFICE  
103 State Street

Makers of

## HIGH GRADE CHAINS.

The BEST SAFETY FOB is one of our specialties; Gent's Vests, Dickens, Lorgnettes, Secret Locket Chains, Locketts, Chate-laines, and the unexcelled

## "Bates" Bracelet

"KANT-KUM-OFF"

## Seven Sizes.

Just the Bracelet to be worn over the Long Gloves so much in Fashion.

**NO HUNTING** for the Invisible Catch.  
**Just PULL and TWIST.**



No. 32  
PATENTED



No. 22  
PATENTED



B.123  
PATENTED



GOLD  
RINGS

BROOCHES AND MOUNTINGS

Also GOLD FILLED RINGS, including the popular THREE CROWN

Ostby & Barton Company respectfully announce to the jobbing trade that their fall line comprising many new and original designs is now ready.

OSTBY & BARTON COMPANY

New York, 13 Maiden Lane  
Chicago, 103 State Street

PROVIDENCE, R. I.

The "Bryant" Rings.

WE have made the **Bryant Rings** for 50 years, and know how to make first class goods. The stone setting—which every retailer knows is a very important part of the work—we give special attention to. The **Bryant Rings** will help your reputation as a first class Jeweler.



TRADE-MARK.

M. B. BRYANT & Co., No. 7 MAIDEN LANE,  
NEW YORK.

The Bowden Rings

ARE COMPLETE IN VARIETY, CORRECT IN  
QUALITY AND PERFECT IN FINISH. WE  
MAKE EVERY VARIETY OF FINGER RINGS.

J. B. BOWDEN & CO.,

1 Maiden Lane.

NEW YORK.

# Grace of the Lorgnette Chain.



IF WATCH AND CHAIN belong together, even more do Chain and Lorgnette. The latter are made for one another, being really a unit—component parts of one design. Fifty years of pre-eminence in these lines. Lorgnette Chains from



\$30.00 to \$300.00.

**Durand & Company,**

49-51 Franklin Street,  
Newark, N. J.



## SOLID GOLD CHAINS EXCLUSIVELY

The best workmanship, plump quality, most attractive designs and very lowest prices are characteristic of our **SOLID GOLD CHAINS**



For 56 years exacting Jewelers have found our Chains ready sellers, very profitable to handle and most durable in service.

We have no salesmen, and our prices are therefore very low. We will be pleased to send you a selection package.

1850 1906

**ALOIS KOHN & CO.**

Makers of  
**SOLID GOLD CHAINS**  
of every kind.

16-18 Maiden Lane  
New York



## EVERYTHING IN MOURNING JEWELRY.

**A. J. HEDGES & CO.,**

Makers of Exclusive Designs in 14K. Jewelry,  
14 JOHN STREET, NEW YORK.

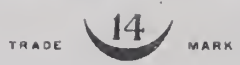
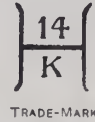

## OSMUN-PARKER MFG. CO.

MAKERS OF

*Fine Pearl and Diamond Goods*

338 Mulberry Street  
NEWARK, N. J.

ESTABLISHED 1871.

Factory and Office: Newark, N. J.

INCORPORATED 1900.

# CARRINGTON & CO.,

## Patent Pocket Match Box

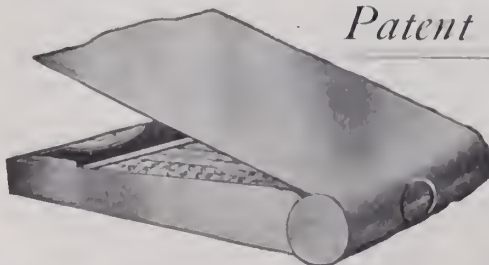

14K. ONLY IN STOCK.

Book Safety Matches with  
Steel Cigar Cutter.  
(Patented.)



Sales Agent:  
7 Maiden Lane,  
NEW YORK.



## M. SCHIFF

Established 1876

82-84 Nassau St., N. Y.  
Phone 801 John.

Manufacturer of fine  
Diamond Mountings, Locks  
and Buttons. Patentee of

## THE NEW IMPROVE Ear Screw

The only one on the mark  
of its kind, absolutely secure  
Special attention paid to  
order work.



# Fancy Bead Necklaces

**A** CERTAIN DELICACY in their decorative effects has won for our Fancy Bead Necklaces established place and merited appreciation.

On no goods does the dainty Vermicilli Decoration appear to better advantage—a specialty with us.

Plain Graduated Necklaces. Also Fancy Graduated. Alternated Beads, Plain and Vermicilli; also the latter in straight sizes.

The arrangement, color and finish of these goods give them distinction.

# Day, Clark & Company

14 KARAT  
ONLY

25

Maiden Lane  
New York



# WHITESIDE & BLANK

## SCARF PINS

NEW GRECIAN EFFECTS

Fancy Stones, Diamonds or Pearls.



No. 4038½ Sapphire and Diamond. No. 4032 Sapphire.  
No. 4030¼ Aquamarine. No. 4040¼ Baroque and Diamond.

NEWARK, N. J.,  
Lafayette and Liberty Streets.

NEW YORK,  
14 and 16 John Street.

ESTABLISHED 1841.

# Carter, Howe & Co.

TRADE



MARK

MANUFACTURERS OF

# Gold Jewelry,

9, 11, 13 MAIDEN LANE, NEW YORK.

FACTORY, NEWARK, N. J.

A. CARTER.

G. R. HOWE.

W. T. CARTER.

W. T. GOUGH.

# SCARF PINS



Established in New York 1837.

# Geo. O. Street & Sons.

24 JOHN ST., NEW YORK.  
103 STATE ST., CHICAGO.

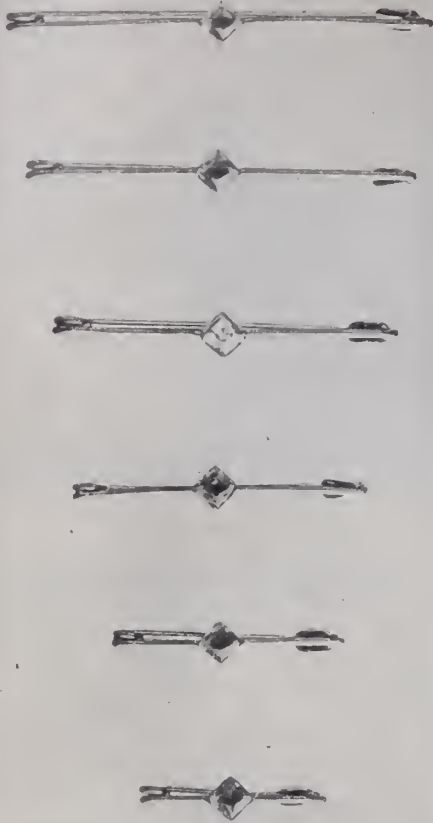

## EVERY PROGRESSIVE JEWELER

should see that his stock is complete with the new solid Gold Scarf and Handy Pins.

These pins will be worn extensively this year by ladies as well as gentlemen. Now is the time to order. Made in sizes from 1 to 2¼ inches, mounted with stone or perfectly plain. Write for prices.

### SCHULTZ, LEISS & CO.

OFFICES:

14 John Street,  
New York.

103 State Street,  
Chicago.

FACTORY: Cor. McWhorter and Oliver  
Streets, Newark, N. J.

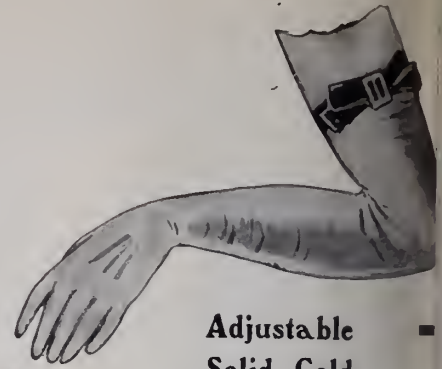

Adjustable  
Solid Gold

## Glove Garters

in Gold, Silver and Plated.  
THAT NEW THING.

OUR

Showings of Gold, Gold Filled and Silver Jewelry for Spring are complete in

- |             |                   |
|-------------|-------------------|
| Brooches    | Crosses           |
| Links       | Rosaries          |
| Scarf Pins  | Fobs              |
| Bracelets   | Combs             |
| Hat Pins    | Waist Sets        |
| Buckles     | Collar Supporters |
| Dog Collars | La Vallieres      |
|             | etc.              |

Chas. L. Trout & Co.

15 Maiden Lane,

New York.

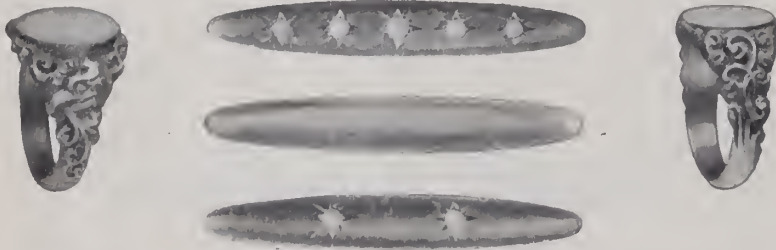

Quality and Finish Consistent  
with twenty years' experience.  
Original and Exclusive Designs.

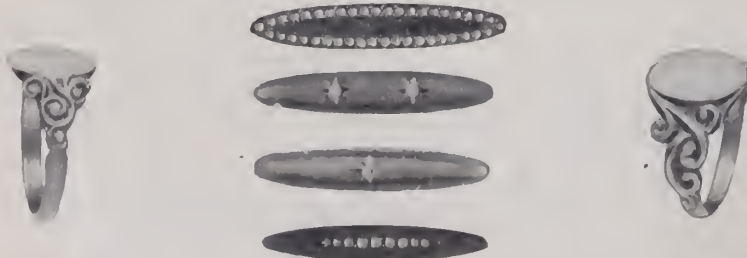

## MOORE & SON,

ESTABLISHED 1886. NEWARK, N. J. INCORPORATED 1903.

## Unique Silver Deposit WHISKEY JUG



7 Inches High.

Just one piece from one of  
the best selling and most  
attractive lines in town.

Depasse Mfg. Co.,

41-43 Maiden Lane,

New York.

ROBERT DULK  
DESIGNER,

Etching in Gold and Silver  
Telephone, 3960 Chelsea.

No. 70 5th Avenue,

NEW YORK

**SAM BUCKLEY & CO.**

English Fancy Goods.



Carry in New York a full line of

**ENGLISH PLATED WAITERS.**

118-122 Holborn, E. C.,  
London, England.

100 William St., New York.

**THE WASHBURN SECURITY MAGIC NUT**

Automatic Holder for ear studs, scarf pins, etc.  
All sizes of scarf-pin wire. Guaranteed.

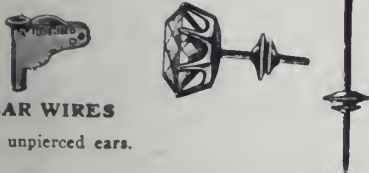

**EAR WIRES**  
for unpierced ears.

**SAFETY CATCH**  
For brooches, etc.  
Can be applied to any work where pin tongues are used.

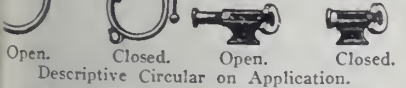

Open. Closed. Open. Closed.  
Descriptive Circular on Application.  
Pearl drilling and Adjusting a specialty.  
Special Order Work and Repairing.

IRVING WASHBURN, 12-16 John St., N. Y.

**CASSIUS W. SEYMOUR,**  
39 Malden Lane, New York.

ALLOW ME TO CALL ON YOU IN THIS WAY



**Jewelers' Stationer and Printer**  
Jewelers' Cards,  
Tissue Paper,  
Tags,  
Blank Books, etc.

**ROLL AND FLAT PAPERS.**  
Estimates cheerfully given. Mail orders promptly attended to.  
Let us quote you our prices on manifold books and sealing wax.

**THE CROHN PATENT SAFETY GUARD.**

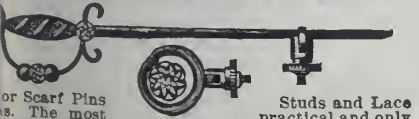

for Scarf Pins. The most reliable one invented. Price, \$1.50 per doz. For sale all wholesale jewelers and material houses. Sample mail, 25c; in 10k. gold, \$1.00; 14k., \$1.25. M. CROHN, maker and inventor, 48 and 50 Malden Lane, N. Y.

**THE MOUNTING THAT SELLS**

Earscrews,  
Earrings,  
Studs,  
Scarf Pins,  
and Rings  
of every description.



Pat. Oct. 24, 1905.

Made in  
Platinum,  
18K.,  
14K.,  
all sizes.

It gives light and brilliancy to the stone.

Manufacturer of a general line of Platinum,  
18K. and 14K. Mountings.  
Prompt attention given to special order work.  
Estimates and designs submitted.  
Diamonds recut and repaired.

**JULIUS WODISKA,**

40 JOHN STREET,

NEW YORK.

**ALLSOPP & ALLSOPP'S**  
HIGH CLASS  
**BRACELETS**

MOUNTED IN COMBINATIONS OF

Dia. and Pearl  
Dia. " Sapphire  
Dia. " Emer'lds  
Dia. " Baroques

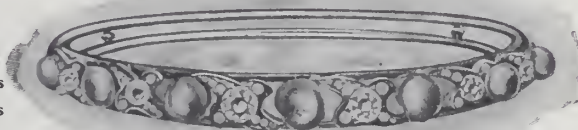

Amethysts  
Topazes  
Peridots  
Aquamarines  
Etc.

18-20 COLUMBIA ST.



TRADE-MARK.

NEWARK, N. J.

**"THE BRACELET HOUSE."**  
**KENT & WOODLAND,**

BRACELETS FOR EVERY WOMAN AND MISS.

16 John Street, New York.

San Francisco Office,  
Care JULIUS A. YOUNG.

"Nethersole Bangles,"  
Plain and with Stones.

"Pinhole" Secret Snap,  
with and without pre-  
cious and semi-precious  
stones.

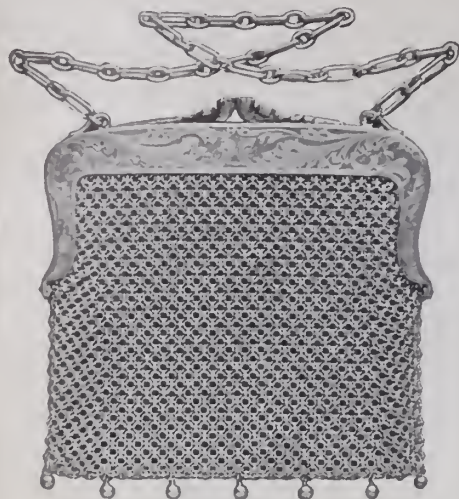

# S. Cottle Co.

Makers of Fine Gold and Silver Mesh Bags.

Our designer is now in Europe visiting the leading fashionable cities on the continent. On his return early in July we will be prepared to show the newest and most artistic designs in Gold Novelties, as well as a complete line of Bags and Bracelets.

31 East 17th Street,  
New York.

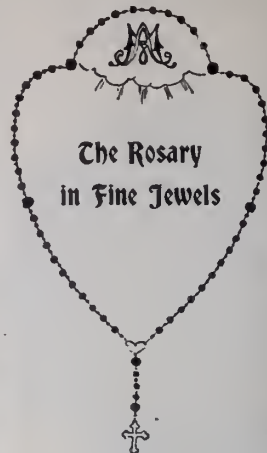

The Rosary  
in Fine Jewels

Fine Rosaries in pure and imitation stone. Mounted in solid gold and rolled gold-plate

ALL COLORS

Our special illustrated catalogue will give interesting advice regarding prices and discounts.



MADE BY

The **W. J. Feeley Co.**  
Providence, Rhode Island,  
Ecclesiastical Art Metal Workers

## Bridesmaids' and Ushers' Pins

We would suggest something with color. Brooches, Scarf Pins and Handy Pins with Amethysts, Topazes, Garnets, Peridots, Aquamarines, Jades and Baroque Pearls. We have a large variety of patterns at moderate prices.

REGARDING OUR FOBS WE HAVE NOTHING TO SAY—THEY SPEAK FOR THEMSELVES.

**SNOW & WESTCOTT,**

Makers of Good Jewelry for Over Seventy Years,

21 MAIDEN LANE,

NEW YORK.

ADOLPH LUTHY.

### LUTHY & HINE,

PERCY W. HINE.

13 EAST 30TH STREET, NEW YORK.

MANUFACTURERS OF

**Artistic Gold and Platinum Mounted Diamond Jewelry.**

Odd and Exclusive Patterns in NECKLACES, BROOCHES, BRACELETS, RINGS, RIBBON COLLARETTES, Etc.

MOUNTED WITH AQUAMARINES, PERIDOTS, AMETHYSTS AND OTHER PRECIOUS STONES.

(DIAMOND MOUNTED COMBS A SPECIALTY.)

Everything New Under the Sun  
IN MODERN JEWELRY  
OF EVERY DESCRIPTION

## Signet Rings

(OUR OWN MAKE)

A SPECIALTY.

We Solicit Memorandum Orders

**L. Witsenhausen**

47-49 Maiden Lane,  
New York.

Manufacturers of MODERN JEWELRY  
Chicago, 405 Masonic Temple  
(L. KATLINSKY.)

**DESIGNS** For Silverware, Novelties and Jewelry . . . . . **FINE ETCHING**

Etching at present, and for a long time to come, will be the decoration, par excellence, for Sterling Silver. We employ the best etchers in the country.  
CHARLES M. PRIOR (PHONE 1224 HARLEM) 1683 Madison Ave., New York



**Has One of Our  
8 Salesmen  
Called On  
You?**

They are showing the most attractive lines of American Watches, Diamonds and Jewelry that are being shown this season.

**"We cover the country."**

From our  
New York Office:  
H. OLLENDORFF  
T. OLLENDORFF  
H. GOLDSTEIN

From our  
Pittsburg Office:  
W. S. BICKART  
J. S. BICKART  
W. E. PARISH  
S. A. REUTER

Special Southern Representative:  
O. J. SOMERS

Should your wants necessitate an immediate delivery before our representative's arrival, either our New York or Pittsburg office will give your order by mail PROMPT and CAREFUL attention.

**I. Ollendorff Co.**

JOBBER IN

Watches, Diamonds and Jewelry

PITTSBURG, PA.:

Cor. Liberty Ave. & 6th St.

NEW YORK:

54 Maiden Lane

ESTABLISHED 1868.

**CROUCH & FITZGERALD**

**Jewelry  
Trunks  
and Cases**

177 Broadway,  
Bet. Cortlandt  
and Dey Sts.

688 Broadway,  
723 6th Ave.,  
New York.

**Look for the Stamp**

on back of



The Standard American Collar Button.

**Krementz  
Collar Buttons and Studs**

**The Government Stamp**

on every bar of gold issued by the U. S. Assay Office giving its Quality, Weight and Value, is known and accepted all over the world as absolutely correct.

**The Kremmentz Stamp**

is universally recognized by dealers and wearers with the same confidence.



**KREMENTZ & CO.,**

49 Chestnut Street,

Dept. A.

NEWARK, N. J.

**Send for booklet "The Story of a Collar Button"—Free**

## The Kenilworth Bracelet.

(Patented Jan. 2, 1906, No. 808,805.)

No. 4086.

All of the foremost jobbing houses now carry a full line in stock, and you will miss an opportunity if you fail to see them. Ask your jobber to show you the full line.

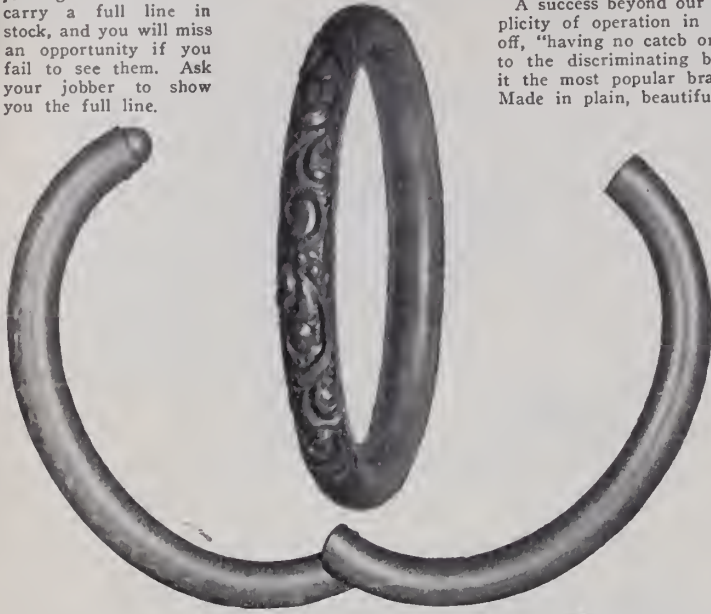

A success beyond our expectations. Its simplicity of operation in putting on or taking off, "having no catch or snap," commends it to the discriminating buyer, and has made it the most popular bracelet on the market. Made in plain, beautifully chased and stone set, plain polished, English and Roman finishes, and in gold-filled and sterling silver.

Manufactured by

**Doran,  
Bagnall  
& Co.,**

North Attleboro,  
Mass.

194 BROADWAY,  
NEW YORK.

67 WABASH AVE.  
CHICAGO.

126 KEARNY ST.,  
SAN FRANCISCO.

EVERYTHING IN LOCKETS AND CHAINS.

THE BASSETT JEWELRY CO.,

PROVIDENCE, R. I.

Our Salesmen have started out with their Complete Line of

## EMBLEM GOODS

for the Fall Trade.

Many new and original designs have been added and we know they will prove good sellers.

BE SURE AND LOOK 'EM OVER WHEN OUR SALESMAN CALLS.

## IRONS & RUSSELL,

MANUFACTURERS OF EMBLEMS,

NEW YORK OFFICE:  
11 MAIDEN LANE.

MAIN OFFICE and FACTORY:  
95 CHESTNUT ST., PROVIDENCE, R. I.



THE TRADE

desirous of keeping in touch with modern, profit-producing methods, should always consult the 500 pages of

OUR BIG CATALOGUE,

with its 30,000 illustrations and long list prices. We send this splendid book free on request.

*S. F. Myers & Co.*

Headquarters for Dueber-Hampden Watches.  
WHOLESALE JEWELERS

The New S. F. Myers Bldg. 47C-49 Maiden Lane New York.



Ladies' Fancy Stone Rings  
and Stone Scarf Pins  
in 10K. that defy  
competition.

Our reputation for making the finest and most complete line of 10-K. gold band rings is still maintained—ask your jobber.

THE  
**EDWIN LOWE & CO., Inc.**

F. W. BODWELL, V.-Pres. and Gen. Mgr.,  
116 Chestnut St., PROVIDENCE, R. I.  
New York Representative, E. T. Wilson, 180 Bway.  
Western Representative, S. H. Brower.

## RINGS

**WM. LOEB & CO.**

101 Sabin St.,

Providence, R. I.

New York Office, 37 Maiden Lane.

**ORKIN BROS.**

373 WASHINGTON ST.,

Jewelers' Bldg., BOSTON, MASS.

Manufacturers of diamond mountings, and repairers to the trade. Importers of precious, semi-precious and imitation stones.

A Full Line Always in Stock at  
Lowest Prices.

We aim to be the foremost  
jobbing house of Boston.

Send us your repairs, or write us for information.

**W**ait  
**A**nd See  
**I**n the "Celebrated Case"  
**T**his Season's New Goods.  
**E**very one a Seller

**T**here  
**H**RESHERS  
**'**S  
**G**OODS  
**S**ELL

**Waite-Thresher  
 Company**

61 PECK ST., PROVIDENCE, R. I.  
 7 Maiden Lane, NEW YORK. 1203 Heyworth Bldg. CHICAGO, ILL.

1876

1906

**Hutchison & Huestis**  
**RING MAKERS**

FACTORY, - - - PROVIDENCE, R. I.



*Jade is in vogue*  
*See our Jade Rings*

JOBGING TRADE ONLY

NEW YORK,  
 3 Maiden Lane.

CHICAGO,  
 Columbus Bldg.  
 Harry H. Miller.

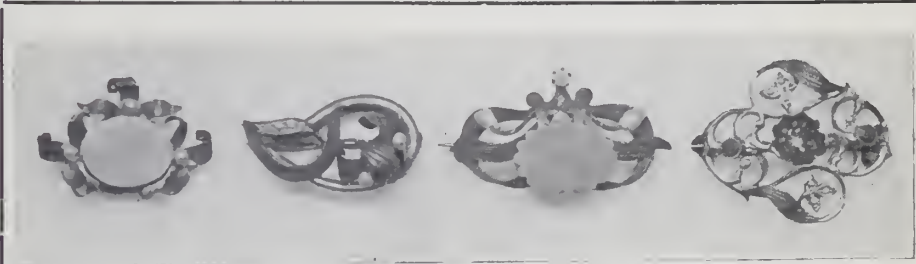

**BROOCHES**

WE have over four hundred styles of Gold Brooches set with all the popular stones in vogue; not at fancy prices, but at figures that cause them to sell.

We have Gold Barrettes in a variety of shapes and styles.

*Insist upon seeing the designs  
 of Gold Jewelry made by the*

**E. L. SPENCER COMPANY,**

*Makers of Gold Jewelry for the Jobbing Trade.*

ORDERS PROVE OUR GOODS SELL.

95 Chestnut Street,

PROVIDENCE, R. I.

New York Office, 9-11-13 Maiden Lane.

SAMPLES ONLY.

**EGYPTIAN PEARLS**

—  
FINEST  
OF  
ARTIFICIAL  
PEARLS.

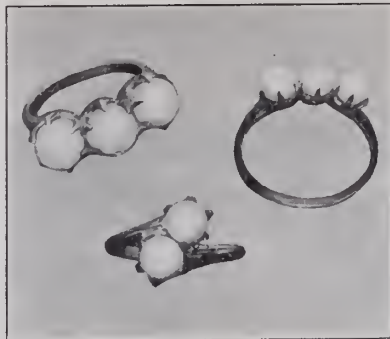

**EGYPTIAN PEARLS**

—  
MOUNTED  
IN  
POPULAR  
JEWELRY.

**T**HE PEARL has always symbolized Beauty and Value. Nature's product is most closely approximated in the handsome "EGYPTIAN" Pearls. The iridescence, weight and color of natural Pearls are retained; and inspection of the "EGYPTIAN" Pearls will demonstrate their pre-eminence. The results attained are possible only by a special process, supplemented by expert workmanship. The articles of Jewelry to which "EGYPTIAN" Pearls are applied are artistic creations meriting your attention.

**GEORGE H. CAHOONE COMPANY,**

Makers of Artistic Jewelry.

PROVIDENCE—7 Beverly Street.

NEW YORK—9 Maiden Lane.

ESTABLISHED 1861.

**R. BLACKINTON & CO.,**

3 MAIDEN LANE, NEW YORK.

FACTORY, NORTH ATLEBORO, MASS.

**Manufacturing Jewelers and Silversmiths.**

TRADE  MARK.

Toilet and Manicure Articles, Flatware, Sterling and German Silver Wrist Bags, Gent's and Ladies' Card Cases, Vanity Boxes, Jewel Boxes, Match Safes, Picture Frames, Belt Buckles, Cigarette Cases, Pen-knives and up-to-date Novelties.

W. B. BALLOU,

ROSWELL BLACKINTON ESTATE,

WALTER BALLOU, J. R. MORSS. R. BLACKINTON, Jr.



**HERMAN KOHLBUSCH, Sr.,**

ESTABLISHED 1859.



Manufacturer of Fine Balances and Weights for every purpose where accuracy is required.

Office and Salesroom, 194 BROADWAY, NEW YORK.

Send for Price List.

Tel. 370 Cortlandt.

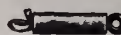

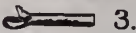
-  1. Snap complete.
-  2. Outside of Snap.
-  3. Inside of Snap.

**The E. P. H. Patent NON-PULL-OUT Neck Chain Snap**

*is a patented snap that insures the wearer against loss of*

**CHAIN or CHARM**  
for it positively will not pull out

Made in 10 and 14 Karat Gold and In Gold Filled.

Can be had of the following Wholesale Selling Agents:

- Messrs. W. Green & Co., 81 Nassau St., New York.
- M. Sickles & Sons, Philadelphia
- E. A. Cowan & Co., Boston
- E. & J. Swigart, Cincinnati
- Swartchild & Co., Chicago
- Nordman Brothers, San Francisco
- Leonard Krower, New Orleans
- Bauman-Massa Jewelry Co., St. Louis

**PRICES.**

- 14 Karat—Small, \$7 per doz. net
- Large, \$7.50 per doz. net
- 10 Karat—Small, \$6 per doz. net
- Large, \$6.50 per doz. net
- Gold Filled—Small, \$2 per doz. net
- Large, \$2.25 per doz. net

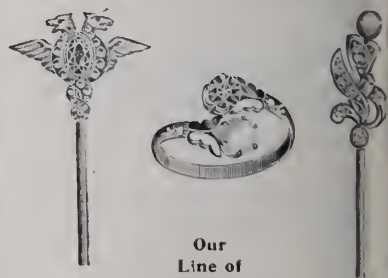

Our Line of

**Rings, Scarf Pins, Ear Screws, Brooches, Crosses, Etc**

is the kind that sells  
Insist on seeing the designs of Gold Jewelry manufactured by the

**AMERICAN RING CO.,**

94 Point St., Providence, R. I.

Makers of Gold Jewelry that is sold to the Jobbing Trade.

**Try Wells' Perfect Ring Adjuster**

1 doz. asst. sizes 10k gold filled (gold front twice as thick as on back). \$1  
1 doz. asst. sizes solid 10k gold. \$1  
1 doz. asst. sizes metal. 85c. Ask for jobber for them, or I will send, prepaid once (only on receipt of price) samples—one small and one med large gold filled and one metal all for 50c. Address



**CHESTER H. WELLS, Jeweler Meshoppen.**

**INSTRUMENTS for VACATION USE.**

**The Warner and Swasey**

**Prism Binocular**



*Now is the time to push the sale of these instruments. Write us at once for prices and discounts*

**2-inch Prism Terrestrial Telescope.**



**The Warner & Swasey Company,**  
Dept. C,  
Cleveland, OHIO.

**Boston Jewelry Manufacturing Co.**

**The Mounting and Repairing House of New England.**

We eclipse all others in design, quality, promptness and finish of work.

A line of entirely new styles in mountings always on hand.

**Jewelers' Building, BOSTON, MASS.**

**FALL LOCKETS**



Trade-mark stamped in each Locket



**Our FALL LINE OF LOCKET CREATIONS** will convince the discriminating buyer of the value of W. & H. Locketts. Fifty years of successful experience justify the confidence in our line.

3 Maiden Lane **Wightman & Hough Co.** Providence, R. I.  
New York

**COMBS**

**OUR** new line shows many designs, highly artistic and attractive, that will prove rapid sellers.

The highest class of workmanship is characteristic of all our lines.



- Combs
- Brooches
- Scarf Pins
- Bracelets
- Barrettes
- Buttons
- Baby Pins
- Crosses
- Waist Sets
- Hat Pins
- Collarettes
- Silver Novelties



TRADE MARK  
**ALWAYS ON THE GO**

LOOK FOR THE TRADE-MARK

**MILLER, FULLER & WHITING, MANUFACTURING JEWELERS**  
N. Y. Office, 9-11 Maiden Lane NORTH ATTLEBORO, MASS.

**Roger Williams Silver Co.,**

PROVIDENCE, R. I., AND NEW YORK, 860 BROADWAY.

**Sterling Only.**

*RICH DESIGNS :: :: :: Photos on Application.*

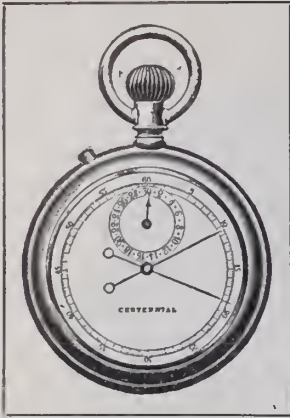

Timer is 1/8 Larger than cut

THE OLD RELIABLE  
**Centennial**

SPLIT SECOND TIMER

*"None better made"*

Suitable for Racing and  
Mechanical Purposes.

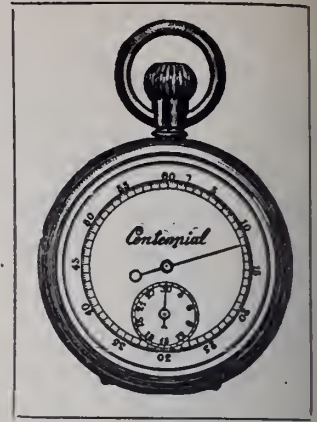

Timer is 1/8 larger than cut

**CROSS & BEGUELIN, Manufacturers, New York.**

**The Comb House**

We manufacture a complete line of

**FINE MOUNTED COMBS**

in 14 K., 10 K., Sterling Gilt and Gold Filled.

Also all kinds of PLAIN, REAL and IMITATION TORTOISE  
SHELL COMBS.

**Wagner Manufacturing Co.**

41 Union Square,

Repair Work  
a Specialty.

**New York.** Factory, Lorimer St. and  
Throop Ave., B'klyn, N. Y.



**To Jobbers Only—**

When you think of Toilet Goods,  
please remember us. Our goods  
are high grade and can be retailed  
at popular prices.

*Special Terms on Early Business*

**Art Stamping & Mfg. Co.**

411 Commerce Street, PHILADELPHIA, PA.

**FAIRCHILD & COMPANY**  
225 to 233 Fourth Ave. NEW YORK CITY.

Manufacturers of GOLD PENS, PENCILS,  
PENHOLDERS, SEGAR CUTTERS, SPE-  
CIALTIES, PENCILS SET WITH JEWELS.

*Style, quality and workmanship acknowledged  
the very best.*



**Trade-Marks** of the Jewelry ar  
Kindred Trade  
Second Edition. Price, \$3.00. The Jewelers' Ci  
cular Publishing Co., 11 John St., New York.

**E. H. H. SMITH SILVER CO.**  
BRIDGEPORT, CONN.

Silversmiths' Building,  
CHICAGO, ILL.

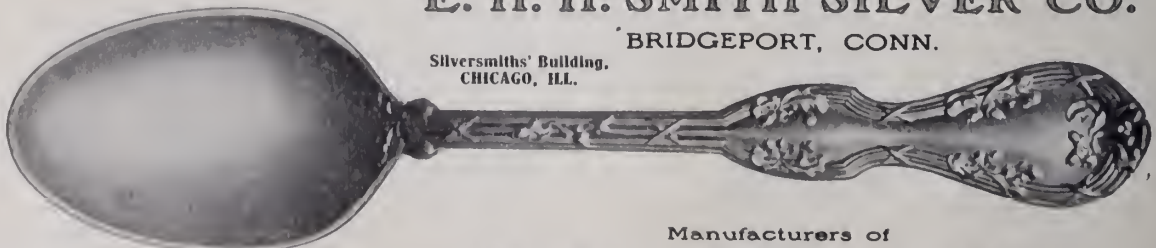

THE OAK.

Manufacturers of

**Sterling Effects in Plate**

# MONOGRAMS.

In Gold, Silver and Plate.

A complete line of Two and Three-Letter Monograms always in stock.

SPECIAL DESIGNS TO ORDER.

Elegant  
Silk Ribbon  
and  
Leather Strap  
FOBS.

Always  
Acceptable as  
Gifts.

A Beautiful Solid  
14-K. Gold  
Monogram Fob  
with Ribbon and  
Swivel, complete,  
any three  
letters desired,  
for,

**\$10.00**

Send for new  
Illustrated Catalogue,

showing the largest  
selection of stock  
Fob Monograms,  
from 50c. in Gold Plate  
upward.

Create a demand for  
these Fobs by display-  
ing a few samples in  
your window.

**OUR**

**SPECIALTY:**

MONOGRAMS  
AND INITIALS FOR  
POCKET BOOKS,  
BAGS, ETC.

Gold Plated...each \$4.50  
Gold Filled...each 7.50  
4-karat Gold...each 15.00  
These prices are list  
and subject to discounts  
as shown in our new  
illustrated catalogue.

Send for Fob and Monogram Catalogue  
or other information to

**Thomas J. Dunn & Co.,**  
101 and 103 Chambers St.,  
Dept. J. NEW YORK CITY.

# WORLD BRAND SILVER

1857  
STANDARD  
OF THE  
WORLD

Nenuphar  
Pattern

**Base Metal**

☞ Manufactured in our own factory by workmen selected because of their knowledge and practical experience in its manufacture and use and with a view to obtaining the best possible results.

**Silver**

☞ Not Less Than 50 per cent. heavier plate than the regular "Standard." Made in two grades, six and fourteen ounce plate.

**Designs**

☞ Six fancy patterns—*original* in design and unexcelled in execution. Also four plain patterns.

**Prices**

As low as consistent with quality.  
*Write for catalogue and prices.*

**THE AMERICAN SILVER COMPANY**  
BRISTOL, CONN.

46 West Broadway, New York. Silversmiths' Building, Chicago, Ill

# Ross, Saltman & Anderson

MANUFACTURERS OF

**Rings and Diamond  
Mountings**

89 FULTON STREET,  
NEW YORK

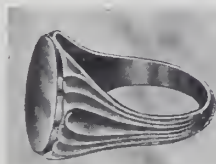

699



204

Jewelers will find it desirable and profitable to keep in touch with our new and artistic monthly productions. They represent that originality and perfection upon which we propose to establish a substantial reputation.



REGISTERED

# The "ARMLET"



**F. & B.**  
**"ARMLET"**  
 Secret Joint  
 Pat. ~~1905~~  
 Size 2 3/8 in.

- |                  |                                  |   |
|------------------|----------------------------------|---|
| <b>474</b>       | <b>476</b>                       | <b>477</b>                                  |
| <b>474 POL.</b>  | <b>476 Rose Gold Half Chased</b> | <b>477 Rose Gold, Half Chased, 5 Stones</b> |
| <b>475 ROM.</b>  | <b>507 O. E.</b>                 | <b>522 O. E.</b>                            |
| <b>506 O. E.</b> | <b>530 Rose Gold Full " "</b>    | <b>546 Rose Gold " " 6 Brillants</b>        |
|                  | <b>538 O. E.</b>                 |   |

Color of stones as ordered, Amethyst, Ruby, Sapphire, Olivene, Topaz, Aquamarine, Almondine, Turquoise and Rose Stones.

Bracelets made with secret joint and push catch. High-grade Seamless Gold-filled Stock. Each bracelet in fine leatherette covered box.



### BRACELET 473 ROSE.

COLOR OF STONES AS ORDERED.

Amethyst, Ruby, Sapphire, Olivene, Topaz, Aquamarine and Turquoise.

Two of the above Bracelets snapped together, makes a nice dog collar 14 in. long.



Locket  
2825  
Rose



Pin  
3632  
Rose and Green  
Brillants



Pin  
3647 Pearls  
3648 Brillants  
3649 Turquoise



Pin  
3629  
Baroque Pearls  
and Brillants



Locket  
2826  
Rose

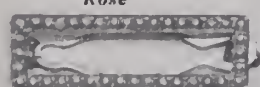

Hair Barrette  
3660 Pearls  
3659 Brills.



Cuff Pin  
3624  
Roman



Cuff Pin  
3622  
Roman



Hair Barrette  
3652 Pearls  
3651 Brills.



Hat Pin  
710  
Rose and Green  
Polish Signet

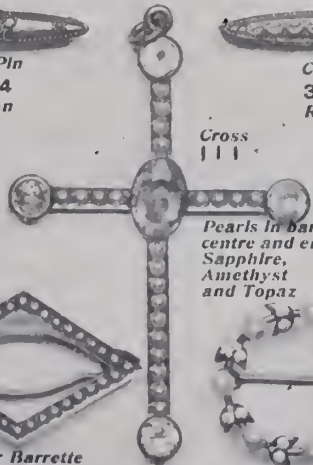

Cross  
111

Pearls in Bars,  
centre and ends.  
Sapphire,  
Amethyst  
and Topaz



Hat Pin  
705  
Rose  
Polish Signet



Links  
751 Rose

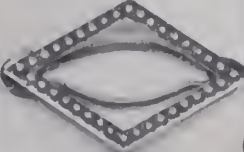

Hair Barrette  
3658 Pearls  
3657 Brillants

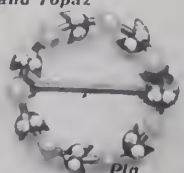

Pin  
3603 Baroque Pearls  
and Brillants



Links  
758 Green  
757 Rose

These are only a few examples of our new goods; see our complete lines.

**Theodore W. Foster & Bro. Co.**  
 MANUFACTURING JEWELERS AND SILVERSMITHS,  
 100 Richmond Street, Providence, R. I.

Established 187

See our Lines  
 of Goods for  
 Articles suitable for gifts

A full line  
 PHOTO. FRAMES  
 both Sterling Silver  
 and 14 K. Gold Filled  
 CROSSES, PENDANTS,  
 NECKLACES, CHAINS, Locketts,  
 GNETTE CHAINS,  
 LOCKETS, CHAIN  
 VEST, DICKIE  
 and FOB CHAINS  
 BRACELETS, BROOCHES,  
 BROOCHES, EARRINGS,  
 RINGS, LINKS, TONS,  
 SCARF PINS, HAT  
 PINS, RETTE PINS,  
 WAIST SETS, CHAIN  
 MOUTHS, DOG COLLARS  
 and BUCKLES, RING  
 BOOK-MARKS and a  
 large variety of

Sterling  
Silver  
Novelties

MANICURE TOILET SETS  
 pieces, also  
 DESK SETS  
 SEWING SETS  
 TRAVELING  
 SHAVING  
 SMOKING  
 FLASKS and  
 goods suitable  
 gentlemen's use

Do not fail to  
 order a few  
 our new  
 lets,

"The Armet"



**Truth in Report That Rough Diamonds With Cleavage Lines Marked Are Imported at New York.**

Diamonds with lines of cleavage marked in ink are not being imported, and a report at such a practice has begun is pronounced erroneous by the customs authorities. The report probably originated in the fact that some months ago an importing firm brought in a quantity of rough diamonds on which the lines of cleavage were marked in black ink. The Collector of the port called upon Gen. George W. Mndil, the precious stone examiner, as to whether or not these marks advanced the stones in value. Gen Mndil advised that there was no advancement in condition, as these marks represented the labor of an expert cleaver. He said that if the time spent by the cleaver in tracing the lines was worth \$100, then certainly an additional value to that extent had been imparted to the stones. If the stones were imported with such lines drawn, he said, then the services of an expert cleaver would not be required in this country. A man with a slight training, it has claimed, could cleave after the lines were drawn. As the cleavers are the highest paid employes in the diamond business, the saving in labor was declared to be considerable.

The Collector accordingly took the position that if the stones were marked, then the duty of 10 per cent. would be imposed on the importation would not come in free of rough diamonds. An additional question was raised as to whether or not a penalty had been incurred by under valuation. The importers offered to erase the ink marks in the presence of the customs authorities, but the latter held that this could not be legally done. After conference, an arrangement was finally made so that the marked diamonds were sent back to Europe, to the cognitor, who erased the marks and then returned them to this country.

Since that time, the customs authorities say, no rough diamonds have come into this port that bore any marks except those marked by nature.

**Fire Does \$18,000 Damage to Stock of Simon Davis & Co., Pittsburg, Pa.**

PITTSBURG, Pa., May 31.—The wholesale jewelry establishment of Simon Davis & Co., 725 Liberty Ave., was damaged by fire at 3 o'clock yesterday morning to the extent of \$18,000, with \$15,000 insurance. The cause of the blaze is not known, but it is supposed to have originated from crossed electric light wires.

The Davis establishment occupies the entire second story of the building at Liberty Ave. and 8th St., and the fire in it was discovered by a watchman of the building. It soon turned in an alarm. The flames were confined to the second floor. The rear end of the jewelry establishment was gutted and the fixtures and the stock, except what was in the safes, were ruined. Two sample trunks were also destroyed.

Mr. Davis in speaking of his loss to-day said: "I carried a stock valued at \$22,000, with insurance of \$15,000 in many companies. The loss has not been adjusted by any of the companies, but will be in a day or two. The best jewelry was locked up in the safe. The origin of the fire is a mystery, and the

only plausible explanation seems to be that the electric light wires must have become crossed, because there was no fire about the building." Mr. Davis said that he has already resumed business and is now engaged in taking an inventory of the stock not scorched by the fire. Repairs to the damage building will be made at once, but it will be several weeks before the store assumes its natural conditions.

Assistant Chief Robert McKinley, of the Pittsburg fire department, badly lacerated his left hand by pulling a hose through a brick wall.

**Jewelry, Clocks, Watches, Silverware and Kindred Lines Exported from New York.**

Washington, D. C., May 30.—The following were the exports of jewelry, silverware and optical goods, clocks, watches and kindred lines from the Port of New York for the week just ended:

- Alexandria: 2 packages clocks, \$110.
- Bombay: 63 packages clocks, \$934; 15 packages watches, \$2,582.
- Bremen: 1 package plated ware, \$150; 2 packages watches, \$1,325; 2 packages optical goods, \$306.
- Buenos Ayres: 9 packages plated ware, \$1,100; 3 packages optical goods, \$152; 4 packages watches, \$764; 5 packages plated ware, \$628; 1 package jewelry, \$336; 1 package watches, \$518; 36 packages clocks, \$103.
- Calcutta: 69 packages clocks, \$1,570; 12 packages clocks, \$210.
- Capetown: 2 packages watches, \$381; 2 packages silverware, \$1,045.
- Cardenas: 11 packages clocks, \$337.
- Christiania: 17 packages clocks, \$590.
- Colon: 1 package watches, \$190; 2 packages watches, \$156.
- Copenhagen: 14 packages clocks, \$293; 6 packages silverware, \$114.
- Delagoa Bay: 19 packages clocks, \$467.
- Fayal: 18 packages clocks, \$190.
- Genoa: 15 packages clocks, \$620; 2 packages jewelry, \$1,000.
- Glasgow: 53 packages clocks, \$1,210.
- Hamburg: 4 packages clocks, \$222.
- Hamilton: 4 packages plated ware, \$168; 9 packages clocks, \$209.
- Havana: 1 package jewelry, \$401; 1 package optical goods, \$134; 1 package silverware, \$237; 2 packages plated ware, \$1,477; 1 package optical goods, \$188; 7 packages jewelry, \$2,458.
- Havre: 5 packages jewelry, \$475.
- Liverpool: 3 barrels jewelers' sweepings, \$150; 128 packages clocks, \$1,376; 3 packages jewelry, \$583; 3 packages plated ware, \$1,183; 1 package jewelry, \$1,000; 2 packages optical goods, \$375.
- London: 66 packages clocks, \$1,377; 1 package optical goods, \$583; 8 packages plated ware, \$706; 5 packages silverware, \$326; 12 packages optical goods, \$3,050; 22 packages watches, \$3,999; 1 package jewelry, \$455; 208 packages clocks, \$2,316.
- Mazatlan: 8 packages clocks, \$230.
- Montevideo: 1 package jewelry, \$354.
- Naples: 2 packages jewelry, \$500.
- Para: 2 packages jewelry, \$550.
- Rio de Janeiro: 2 packages optical goods, \$1,641.
- Savanilla: 20 packages watches, \$130.
- Shanghai: 37 packages clocks, \$818; 2 packages watches, \$800.
- Singapore: 2 packages plated ware, \$185.
- Southampton: 1 package watches, \$325.
- Sydney: 28 packages plated ware, \$2,697; 2 packages watches, \$175.
- Tampico: 82 packages clocks, \$1,358.
- Trinidad: 3 packages plated ware, \$229.
- Valparaiso: 5 packages plated ware, \$781.
- Vera Cruz: 5 packages plated ware, \$502; 10 packages clocks, \$108.

Mr. and Mrs. E. H. Hopkins, Penn Yan, N. Y., who recently returned from a three months' trip to California, had a fortunate escape from the catastrophe that visited San Francisco, having left the Palace Hotel just 12 hours before the earthquake occurred.

**News of the Death of James D. Lincoln, a Great Shock to His Friends and Relatives.**

NORTH ATTLEBORO, May 30.—The news published in the last issue of THE JEWELERS' CIRCULAR-WEEKLY to the effect that James Danielson Lincoln, a pioneer jeweler of Plainville, died suddenly Saturday, May 26, at his winter home in Pasadena, Cal., was a shock to the many friends and relatives of the deceased, who were not even aware that he was ill. His last letter home told of no ailment, but said that he was planning, in June, to make a journey to Alaska before returning to North Attleboro. Diabetes was given as the cause of his death.

Mr. Lincoln was born March 30, 1823, in the town of Brimfield, Mass., and was the



THE LATE JAMES DANIELSON LINCOLN.

son of Dr. Asa and Sarah E. (Danielson) Lincoln. At the age of seven his mother died and he went to live with his uncle and aunt in Franklin. He received his education in the Franklin and Wrentham academies, and after graduation taught school in Walpole. He then made preparations to become a physician, but circumstances, however, led him into business with his uncle, Fisher Thayer, of Wrentham, who was a thread manufacturer. When Mr. Thayer died, Mr. Lincoln became associated with the jewelry firm of Draper, Tift & Bacon, which, after Mr. Tift's death, became known to the trade as Lincoln, Bacon & Co. For some years he has been out of business.

In 1880 Mr. Lincoln married Mrs. Eliza Melcher, but had no children. In 1889 and 1890 he represented the town of Wrentham in the Legislature. Mr. Lincoln was always fond of his birthplace, and in 1903 presented his native town with a memorial library costing at least \$25,000.

Immediately upon receipt of the news of Mr. Lincoln's death, his step-son, Woodbury Melcher, hastened to California. In accordance with Mr. Lincoln's wish his body will be cremated and burial will be at Laconia, N. H.

J. F. Lindvall, Moline, Ill., has installed new fixtures and show cases and otherwise improved the interior of his store.

The Larter Shirt Stud  
is the only stud that  
can be used in any  
style shirt, including  
the coat shirt.

The variety of pat-  
terns is almost unlim-  
ited, the largest shirt  
stud stock in America.

Larter & Sons

21 & 23 Maiden Lane

New York

Graceful Example of British Silversmithing  
Presented to Sailors of the North  
Atlantic Fleet.

AN example of graceful silversmithing seen in the cup illustrated on front cover of this issue, which was presented to the seamen of the United States North Atlantic fleet by the seamen of H. M. Second Cruiser Squadron, under command of H. S. H. Prince Louis of Battenberg. It is understood that this cup, which was recently exhibited by Tiffany & Co. New York, will be used as a yearly trophy for the best 12-oared boat crew of the North Atlantic fleet.

The cup, which measures 31 inches height, was made in London, England, and is of silver, richly plated all over with gold. It is of urn shape and of a classical design in vogue near the close of the 19th century. The inscription begins with names of the boats in the North Atlantic fleet, which took part in the entertainment of the squadron of Prince Louis, in the Fall of last year, as follows: *Maine, Albatross, Illinois, Iowa, Kearsarge, Kentucky, Massachusetts, Missouri, West Virginia, Pennsylvania, Maryland, Colorado, Mayflower, and Yankton*. Then follows this testimonial of friendship: "To the enlisted men of the North Atlantic fleet from their British cousins of the Second Cruiser Squadron on board the *Drake, Cornwall, Essex, Bedford, Cumberland*. In grateful remembrance of the many kindnesses, tokens of good fellowship and wonderful entertainments that were given to them in cordial friendship by their comrades across the sea, Annapolis, Nov. 1 to Nov. 20, 1905, New York."

Bill to Establish Court of Customs Appeals Introduced in Congress.

A bill was introduced at Washington last week, by Representative Needham, creating a United States Court of Customs Appeals, to consist of a Chief Justice and two Associate Justices appointed by the President and ratified by the Senate. The object is to take away from the circuit courts the appeals from the decisions of the United States Board of General Appraisers. Exclusive jurisdiction to review the Board's rulings is to be entrusted to the new court if it is created and from the decisions of this court the only appeal would be to the Supreme Court of the United States.

Newberry, Mich., Jeweler Dies of Gunshot Wound Received by Accident  
May 13.

MARQUETTE, Mich., May 30.—Edward Gruber, a jeweler at Newberry, who was accidentally shot May 13 by Elizabeth Haling, his betrothed, while the couple were hunting, died May 25. The body was taken to Shepherd, Mich., Gruber's former home for burial.

About two weeks ago a fire broke out in a store next door to the jewelry store of A. Steuber, Le Roy, N. Y. An explosion occurred which completely wrecked the show window on that side of Mr. Steuber's store.

**Imports of Clocks, Watches, Jewelry and Gems Into Canada.**

TORONTO, Can., June 1.—The monthly report of the Department of Trade and Commerce of Canada for February gives the imports for home consumption in the jewelry and kindred trades as follows:

	Month of February,		Eight months ended	
	1905.	1906.	Feb. 28,	1906.
<b>Watches:</b>				
Great Britain.....	\$360	\$474	\$7,743	\$7,687
United States.....	19,463	18,178	162,084	175,220
Germany.....	2,880	2,980	28,490	26,070
Other countries.....	274	405	10,146	12,637
<b>Totals.....</b>	<b>\$22,986</b>	<b>\$22,037</b>	<b>\$208,493</b>	<b>\$221,614</b>
<b>Jewelry:</b>				
Great Britain.....	\$1,394	\$1,020	\$16,732	\$20,071
United States.....	45,761	62,469	450,674	475,565
Switzerland.....	12,455	15,367	135,268	116,369
Other countries.....	1,124	438	22,806	36,711
<b>Totals.....</b>	<b>\$60,734</b>	<b>\$79,294</b>	<b>\$625,483</b>	<b>\$648,716</b>
<b>Gold and silver and manufactures of:</b>				
Great Britain.....	\$4,045	\$4,969	\$54,102	\$47,893
United States.....	69,347	74,604	477,086	468,725
Germany.....	898	1,014	38,411	37,417
Other countries.....	2,640	3,669	24,115	22,237
<b>Totals.....</b>	<b>\$76,930</b>	<b>\$84,256</b>	<b>\$593,714</b>	<b>\$576,272</b>
<b>Precious stones of all kinds and imitations of (valuable):</b>				
Great Britain.....	\$3,415	\$8,232	\$73,813	\$101,414
United States.....	17,476	18,819	218,341	207,652
Other countries.....	2,924	3,020	41,575	39,124
<b>Totals.....</b>	<b>\$23,815</b>	<b>\$30,071</b>	<b>\$333,729</b>	<b>\$348,190</b>
<b>Precious stones of all kinds and imitations of (valueless):</b>				
Great Britain.....	\$10	\$230	\$6,490	\$6,179
United States.....	1,892	3,172	12,016	15,810
Other countries.....	99	1,199	13,070	17,310
<b>Totals.....</b>	<b>\$2,001</b>	<b>\$4,601</b>	<b>\$31,576</b>	<b>\$39,299</b>
<b>Precious stones of all kinds and imitations of (valueless):</b>				
Great Britain.....	\$369	\$51,341	\$136,748	\$265,402
United States.....	2,757	11,229	76,016	68,320
Holland.....	46,690	15,790	179,163	216,216
Other countries.....	21,628	8,407	450,576	242,622
<b>Totals.....</b>	<b>\$71,444</b>	<b>\$86,767</b>	<b>\$842,503</b>	<b>\$792,560</b>

**Death of Walter W. Chase.**

EVIDENCE, R. I., May 30.—The funeral of Walter Wayland Chase, well known in the jewelry circles, who died last Thursday was held from his late residence, 261 St. Monday. The services were conducted by Rev. Charles M. Melden, pastor of the Mathewson St. M. E. Church, where the deceased was an active member, and he was attended by a large number of the members of the church as well as others who had come to love and respect the deceased. The bearers were Herbert S. Jones, Alexander J. Morrison, representing the Epworth League, and Elmer D. Nickerson and Carleton C. Carter, of the Young Men's class. The floral remembrances were unusually attractive. Interment was at the Mount Pleasant Burial Ground.

Walter W. Chase died about 1 o'clock Thursday afternoon after an illness of less than a week, peritonitis being the cause of death. He was the son of the late William C. Chase and Aitana F. Chase, and was born in this city Dec. 15, 1866. He attended the common schools here and was a pupil at the High School. After leaving school he entered the jewelry business and had followed it ever since. About six years ago he started with his father-in-law a jewelry manufacturing establishment on Clifford St. He made the style of the Chase Mfg. Co. For many years he was president of the Epworth Church, and was also a member of the Order of United Workmen.

He is survived by a widow and one brother, Walter A. Chase.

**Jewelry Valued at \$2,730 Stolen from St. Louis Firm and Police Are Searching for Watchmaker.**

ST. LOUIS, Mo., June 1.—Diamonds and jewelry of the value of \$2,730 were stolen from the Jaeger Loan & Jewelry Co., 2615 Olive St., and a watchmaker formerly in the employ of that firm and bearing the name of Eugene C. H. von Hartman is charged with the theft of the valuables.

The articles were stolen Tuesday night, according to the statement of J. M. Chiswell, treasurer of the company, but the robbery was not discovered until Wednesday morning, when Mr. Chiswell opened the safe. The articles were taken while the goods were being removed from the show windows to the safe, it is believed. The watchmaker did not return to work Wednesday, and has not since been found.

Von Hartman claimed to have been a captain in the German army, and also a veteran of the Spanish and Boer wars. He is tall and lanky, has four scars from sabre cuts on his left wrist, weighs about 170 pounds, and is in a sickly condition. He wore a high collar and a pair of elephant hide low-quarter shoes bought in London.

A reward of \$100 has been placed in the hands of Chief of Detectives Desmond, of the St. Louis police force, by the company for the arrest of Von Hartman.

Scott S. Rowley, for a number of years in the jewelry business at Brockport, N. Y., died of anemia, recently, in California, whence he had gone for a milder climate. The interment was made at Brockport.

**Death of Reuben Harris.**

WASHINGTON, D. C., June 1.—In the death of Reuben Harris, senior member of the firm of R. Harris & Co., which occurred at his residence in this city about 11 o'clock on the evening of May 28, the jewelry trade of Washington loses one of its oldest and best-known members. While Mr. Harris had been in bad health for some time his death was entirely unexpected. Early in the evening he had been conversing with A. D. Prince, his partner, and spoke about how well he felt, expressing his determination of going to the firm's store the next morning. His wife and two daughters were with him at the time he died and he passed away so peacefully that it was several minutes before they realized the end had come.

Mr. Harris had been a sufferer from a form of acute nervousness for more than a year and it finally resulted in a breaking down of his nervous system. Several months ago he went abroad and spent considerable time in the south of France and in Italy for the benefit of his health. About two weeks ago he returned and paid one visit to the store, greeting his associates and employes. Since then he had been confined to his home.

Reuben Harris was born in New York, Oct. 9, 1857, and was of Scotch and English descent. He was engaged in the jewelry business here for a period of 28 years, being associated with A. D. Prince, who was a first cousin. He was educated for the most part at various educational institutions in Berlin and was an accomplished linguist, speaking fluently English, German and French. Mr. Harris is survived by his wife, and two married and two single daughters.

Regarding Mr. Harris a friend said: "He was a man of the most genial disposition. As a business man he was exceptionally successful, and he had the distinction of being one of the best judges of precious stones in this country."

The funeral services were held at the home of the deceased on 16th St., at 10 o'clock, Thursday morning, being conducted by Dr. Louis Stern, of the Washington Hebrew Congregation, and Rabbi Abram Simon. The latter delivered the funeral oration, which was both eloquent and touching. He said that Mr. Harris, by his exemplary life, had won the admiration and respect of all with whom he came in contact. Possessed of that tremendous energy for which he was noted, he overtaxed himself, but in doing so he won the unstinted admiration of all, owing to his integrity and strict probity.

At the conclusion of the services the casket was borne to the hearse through double lines of a delegation of St. John's Lodge, No. 11, F. A. A. M. The pallbearers were David Frankel and Isadore Saks, New York; Louis Stern, Philadelphia; S. Salabes, Baltimore, and Charles Goldsmith, Emile Berliner, Ernest Mayer and Harry King, of this city. The Masonic service was omitted and the interment was private at the cemetery of the Washington Hebrew Congregation.

W. S. Johnson has sold out his entire stock of jewelry, etc., in Baxter, Ia., to George H. Pease.

# HAYDEN W. WHEELER & CO.

## MOUNTED DIAMONDS



Our stock of Mounted Diamonds includes the newest and best ideas for the approaching June Weddings. We are also splendidly equipped to furnish special designs.



NECKLACES, BRACELETS AND LA VALLIERES ARE AMONG THE PREVAILING FADS AT PRESENT.

AMSTERDAM  
2 TULP STRAAT

LONDON  
50 HOLBORN VIADUCT

2 MAIDEN LANE, NEW YORK

TELEPHONE  
7365 CORTLANDT

ORDER

# DIAMONDS

ON MEMORANDUM FROM

## ALFRED H. SMITH & CO.

170 BROADWAY, NEW YORK.  
Corner Maiden Lane.

London.  
6 Holborn Viaduct.

Chicago.  
103 State Street.

## Oppenheimer Bros. & Veith, Cutters of Diamonds,

65 NASSAU ST. (PRESCOTT BUILDING), NEW YORK.

AMSTERDAM,  
2 Tulp Straat.

LONDON,  
40 Holborn Viaduct.

CUTTING WORKS,  
Cor. Union & Nevins Sts., Brooklyn.

## HENRY E. OPPENHEIMER & CO.,

51 Holborn Viaduct, London.  
50 Rue de Chat-audun, Paris.  
7 Place Loos, Antwerp.

Tel. 621 Cortlandt.

3 MAIDEN LANE, NEW YORK.

DIAMONDS, PEARLS AND PRECIOUS STONES.

MEMORANDUM ORDERS SOLICITED.

**First Prosecution Begun Under Gold Law of New York—Wrangle Results in an Adjournment.**

Finkel, of Locketz & Finkel, jewelry manufacturer at 318 E. Houston St., New York, Friday afternoon was before Magistrate Finn, in the Essex Market Court, to answer a charge of violating the gold stamping law of New York. The complaint was made by J. Jacoves, of the Brooklyn Watch Coin Co., 275 Bowery, who claimed that Finkel had sold him a chain slide that did not assay up to the quality mark stamped on it.

For four years the complainant said he had bought from time to time from the defendant slides which were afterward used in making up chains. The last purchase made several years ago was of 21 slides, for which a bill of about \$30 was rendered. The slides were marked 14k. and bore the firm's initials. The bill as rendered describes the property as 14 karat slides. One or more of these slides were assayed and, it is claimed, showed less than 14 karat quality.

The denial was made by the defendant as to the fact that slides, guaranteed to be 14 karat in fineness, were sold to the complainants. The contentions of the defense, so far as they were brought out at the trial, were in relation to the veracity and motive of the complainant and the accuracy of the assay.

When the case was called Irving Kremer, of Kremer & Kremer, who appeared as counsel for the complainant, briefly stated to the Magistrate the character of the proceeding. The attorney said that he could prove by the testimony of a representative of the United States Assay Office that the slides did not assay 14 karat in fineness, and did not assay up to 13 karat in fineness, although the law allows a maximum variation of only one karat from the mark.

Laurice Blumen, of the Brooklyn Watch Coin Co., testified that he bought the slides, and he asked Mr. Finkel if he was positive as to the slides being of 14 karat gold. Mr. Finkel replied emphatically that the gold was of the designated standard. The bill that was rendered was presented in evidence. The witness said that he tested one of the slides and found that it was below the standard. He said that he had sent two slides to the United States Assay Office to be assayed. His partner, J. Jacoves, carried the slides to the assayer for that purpose.

The slides sent to the assay office were introduced in evidence. One had been cut into two halves, and one of the pieces had been assayed. The other slide had been assayed as a whole.

Col. L. Jungentob, the attorney for the defendant, then cross-examined Mr. Blumen. In answer to a question the witness said that his firm now manufactures slides. Mr. Kremer objected that this evidence was immaterial, but the Magistrate ruled that it was proper for the defendant to go into the question of the complainant's motive and if business rivalry could be shown. Some questions were also asked in relation to a series of the complainant's notes held by the defendant. Mr. Jungentob said that according to proof which would be introduced the summons in this case was served

on the day when one of these notes fell due.

Questions were also asked by the defendant's attorney to indicate the possibility of somebody tampering with the slides after they were delivered by his client and before they reached the assay office.

Mr. Kremer kept up a line of vigorous objections to the questions asked on cross-examination, and said the opposition was prematurely going into issues before the complainant had opportunity to present the affirmative evidence.

The principal trouble came when Mr. Blumen was asked for the stone on which he made his preliminary test, and to demonstrate to the court how he did it.

Mr. Kremer said that his client was not an expert, and that it was the intention of the complainant, as soon as the court would permit, to introduce the expert from the assay office, who was qualified to testify along this line. The magistrate ruled, however, that as Mr. Blumen had been for a number of years in the business and had actually made a preliminary test, the questions were proper.

When the testing stone was produced the defendant's counsel demanded to know where was the impression made by the test, and intimated that its disappearance from the stone was suspicious. Another slide similar to those that were assayed was presented to the witness by the defendant's lawyer, who asked that this be also tested. Again Mr. Kremer vigorously protested, saying that this outside slide had nothing to do with the case, that his client was in no respect qualified to give evidence of the character required, and that such evidence was immaterial.

During the discussion that arose Mr. Blumen insisted on answering some questions after his counsel had instructed him not to do so. The witness remarked that he had nothing to conceal, and wished to be entirely fair. Mr. Kremer, who had been getting more and more impatient, remarked that the examination could not go on, as he could not permit himself to be made a fool of by his client.

Magistrate Finn arose from the bench and was about to leave the room, apparently not intending to hear any more of the case. Mr. Kremer apologized, however, and the Magistrate consented to have the hearing continued next Friday before him in the 57th St. Court.

Mr. Cummings, of the United States Assay Office, was on hand as a witness, but his testimony was not introduced at this hearing. It was said his assays showed a fineness respectively of 11 3/4 and 12 2/10 karat, the former being of a half and the latter of an entire slide.

It will be contended by the defendant that the assay of the upper half of the slide was unfair because it included a stone-set ornament soldered in 10 places to the slide. The top and bottom of the slide are soldered to the sides.

Wm. McElroy, Plainfield, N. J., who was arrested last week while intoxicated had in his possession three nickel watches, a score of cheap rings, a quantity of plated chains, tea spoons and other articles. He denied that the property had been stolen, but the police are holding him pending an investigation.

**Chicago Jobbers Organize to Prevent Manufacturers Selling to Both Retailers and Wholesalers.**

CHICAGO, June 2.—One of the most important meetings ever held in the jewelry trade in Chicago took place this week, when prominent members of every jobbing jewelry house in Chicago met to devise plans for combating the manufacturers of plated and filled jewelry who sell both the retail and jobbing trade. The prosperous condition of the country in general has led many manufacturers to increase their output. Cities and towns heretofore visited only by the jobber have lately been invaded by the manufacturer. The increased facilities of transportation afforded by the electric inter-urban lines have made it possible for the manufacturer's representative carrying a small special line to visit towns heretofore considered jobbers' exclusive territory.

While the wholesale jewelry trade here is in a very prosperous condition, yet the jobbers think it is unfair for a manufacturer to sell to them and then try to sell the same goods to the jobber's customers. With this condition confronting them an organization has been formed here with the view of curtailing some of the abuses which are considered to exist.

The plan for such an organization has been discussed for some time in the past. Its culmination came this week when the association was organized with the following officers: President, Julius Schnering, of Otto Young & Co.; vice-president, B. C. Allen, of Benj. Allen & Co.; secretary, Harry Cohen, of the Stein & Ellbogen Co.; treasurer, Harry Hahn, of H. F. Hahn & Co. These gentlemen, together with Lem. W. Flershem, of Lapp & Flershem, and Mr. Alister, of Norris, Alister & Co., also constitute the Board of Directors.

The association, while not aiming to take drastic measures against manufacturers who sell both the jobbing and retail trades, seeks to protect itself and aims to have a harmonious understanding with certain manufacturers who are working strongly to sell both branches of the trade. Notices will soon be sent to all manufacturers who sell the jobbing trade and a "get-together" conference will probably soon be held.

**Importations at the Port of New York.**

Weeks Ended June 2, 1905, and June 1, 1906.

China, Glass and Earthen Ware:	1905.	1906.
China .....	\$76,421	\$112,799
Earthen ware .....	10,937	13,299
Glass ware .....	27,687	38,027
Optical glass .....	3,237	438
Instruments:		
Musical .....	17,624	20,363
Optical .....	9,443	5,951
Philosophical .....	1,721	2,579
Jewelry, etc.:		
Jewelry .....	7,317	4,920
Precious stones .....	856,917	612,816
Watches .....	37,932	42,540
Metals, etc.:		
Bronzes .....	5,723	.....
Cutlery .....	34,628	28,727
Dutch metal .....	7,813	3,499
Platina .....	13,375	58,756
Plated ware .....	.....	34
Silverware .....	1,476	557
Miscellaneous:		
Alabaster ornaments .....	351	.....
Beads .....	3,673	4,622
Clocks .....	7,673	3,394
Fans .....	5,001	6,956
Fancy goods .....	8,171	9,380
Ivory .....	65,663	8,734
Ivory, manufactures of.....	236	372
Marble, manufactures of...	17,972	6,744

**AMETHYST**

In Siberian, Brazilian and D'Auvergne qualities, in all shapes and sizes. Golden and Madeira topaz. Half, round and bouton pearls. Reconstructed rubies, opals, garnets, and doublets in the fancy colors and fancy shapes—uniform grades, especially selected for the American Market.

*L. Heller & Son*

Importers of Precious and Imitation Stones.

New York, 51 Maiden Lane  
Paris, 5 Cite Trevisé

Providence, 212 Union Street  
Idar, 14 Hauptstrasse

TELEPHONE 219 JOHN.

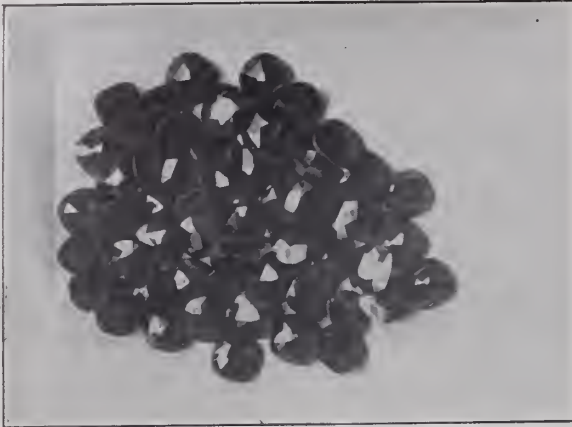

GEORGE H. HODENPYL.

WALTER N. WALKER

**DIAMONDS**

AND

DIAMOND JEWELRY

**HODENPYL & WALKER**

Unique  
and  
Staple Patterns

170 Broadway, New York  
Corner of Maiden Lane  
TELEPHONE, 1898 CORTLAND

Repairing and Recutting  
Diamonds  
a Specialty

<p>OUR <b>40th</b> YEAR</p> <p>IN BUSINESS</p> <p>1866-1906</p>	<p><b>DIAMONDS</b> LOOSE AND MOUNTED</p>	<p><b>CASES and MOVEMENTS</b> ALL MAKES AND GRADES</p>	<p><b>JEWELRY</b> GOLD AND PLATED</p>
<p>ORDERS SOLICITED FROM RESPONSIBLE JEWELERS.      GOODS SENT ON SELECTION.</p> <p>All our goods are either direct importations, our own manufacture or bought for cash enabling us to offer special inducements in prices and terms.</p>			
		<p>EST. 1866.</p> <p><i>Lissauer &amp; Company</i></p> <p>Importers.</p> <p>2 TULPSTRAAT, AMSTERDAM.</p>	<p>12 MAIDEN LANE (ONE FLIGHT UP)</p> <p>P. O. Box, 1625, <b>NEW YORK.</b></p>

**PEARLS ROUND, BUTTON AND HALF.**

Selection Papers Sent on Request

**MARTIN LOW & TAUSSIG,**

51 Maiden Lane, New York.  
Telephone, 2817-John.

139 Mathewson St., Providence, R. I.  
Telephone, 3037-Union.

**MEYEROWITZ BROS.,**

IMPORTERS OF **DIAMONDS,** 37-39 MAIDEN LANE, NEW YORK CITY

A Complete Line of Precious, Semi-Precious and Imitation Stones. Mail orders promptly attended to.

### Canadian Firm Accused of Illegally Stamping Word "Sheffield" on Cutlery Made in Niagara Falls.

NIAGARA FALLS, CAN., June 1.—The Ontario Silver Co., of this place, is charged with violating the Canadian law by the wrongful stamping of cutlery manufactured by them. An information was laid by Chief of Police Mains against George W. Clark, manager of the company, and the case came before Police Magistrate Crikshank, May 30, and was adjourned for a week.

The information accuses the defendant of unlawfully conspiring by deceit and falsehood and other fraudulent means to defraud the public, contrary to the criminal code. It is alleged that the Ontario Silver Co. has been making cutlery and stamping it falsely with the word "Sheffield" as though it were made in Sheffield, Eng. The cutlery so marked was afterward sold throughout Canada through wholesalers, jobbers, manufacturers and retailers.

The police searched the factory premises and discovered the following among other things:

Sheffield Knife Co., No. 12, Sheffield, England.

Manufactured by Leonard & Lee, Sheffield—two knives marked on handle 710 and 5.

Royal Oak Cutlery Works, Sheffield (Ro.).

Royal Cutlery Co., Sheffield, England.

The correspondence obtained in the office of the company is said to indicate that the company proposed to stop the use of these dies when the stock of cutlery already marked with them had been disposed of.

The proceedings have been instigated by the Cutlers' Co. of Sheffield, which is a sort of guild representing the cutlery industries of Sheffield, Eng., which are acting for the protection of Sheffield's reputation. Information came to the Cutlers' Co. early in 1904 that a very large manufacturing trade was being carried on in Ontario in common cutlery which was marked "Sheffield, England." The case was put into the hands of the Cutlers' Co.'s lawyers, one of whom was about to visit Canada to interview the Canadian government, which he did in October of that year. He saw Hon. Sydney Fisher, Minister of Agriculture, and urged that proceedings should be instituted under the merchandise marks act with a view to putting a stop to the infringement. Mr. Fisher promised to have the matter referred to the Justice Department for an opinion.

For some time nothing was done, but finally as the Cutlers' Co. urged the matter persistently and secured the intervention of the British Colonial Office, the Department of Justice stated that proceedings would be taken against the offenders under the criminal code, but that as the administration of criminal law rested with the provincial and not the Dominion authorities the attention of the Attorney-General of Ontario should be drawn to the case. This course was taken by the Cutlers' Co. through its solicitors, Malone, Malone & Holden, of Toronto, with the result that after long delay the machinery of the law has at last been set in motion.

The case excites widespread interest in the trade, as many houses have these goods

in stock and the clauses of the code under which action is taken render the seller equally liable with the manufacturer.

### Atlanta Jeweler Swindled With Worthless Checks, But Subsequently Recovers the Articles Sold—Warning for Bankers.

ATLANTA, Ga., June 1.—Several prominent jewelers of Atlanta, among them N. Kaiser & Co., 15 Decatur St., are said to have been the victims Thursday afternoon of a man passing under the name of E. W. Jordan, who passed checks purporting to be drawn by the Baldwin Locomotive Works, Philadelphia, on the Philadelphia National Bank. Over \$1,000, it is said, was thus secured and Jordan escaped from the city.

Jordan approached Mr. Kaiser, representing himself as being associated with the Baldwin Locomotive Works. After having made several purchases, the man presented a check on the Philadelphia National Bank in payment. This check was immediately sent to the Fourth National Bank of Atlanta, and returned. At the same time Charles A. Ryan, cashier of the Fourth National, visited Mr. Kaiser and explained why.

L. P. Hillyer, secretary of the Georgia Bankers' Association, had recently sent out a warning to banks over the State, cautioning them against checks signed by a man named Jordan. When Mr. Kaiser therefore sent such a check he was informed of Jordan's character. This happened about five minutes after the man had secured the goods.

Mr. Kaiser chased up the street in pursuit of Jordan, and later in the day, in some manner concerning which the dealer declines to talk, the jewelry was restored.

Jordan has not been captured, but his arrest is expected.

Jordan is described in Secretary Hillyer's circular as a tall, broad-shouldered, light-complexioned man, slightly bald.

### Cincinnati Police Arrest Negro Who Is Accused of Robbing Windows of Many Jewelers.

CINCINNATI, O., June 2.—James Taylor, alias "Gravy," a negro, was brought before the local criminal court yesterday on the charge of larceny, waived examination, and was bound over to the Grand Jury in \$5,000 bail. The arrest of Taylor, Saturday afternoon, has wound up a series of window robberies which have been going on for the last six weeks, and which have been a great puzzle to the police. The prisoner is the man who broke and robbed the windows of William Fink, 1424 Main St., and also that of Jacob Morris, at 1227 Vine St.

Taylor's third and last attempt at robbing jewelry store windows was made Saturday, when he smashed a window in the store of Andrew Alich at 930 W. Liberty St. and succeeded in getting about 12 rings set with diamonds, opals and pearls, and valued at about \$700. Taylor carried a granite brick wrapped in a newspaper and waited his chance to break the window. When the proprietor's back was turned he completed his work, mounted a stolen wheel which he had in hiding, and rode away.

Twice before he had done this successfully and disappeared, though the police started after him; but after the robbery of Mr. Alich's store the police tracked him to a cellar of a private residence on Freeman Ave., not far distant, and forced him to surrender at the point of revolvers.

When taken into custody, Taylor told the officers where to find the plunder he had hidden in the cellar. Eight rings of the 12 stolen from Mr. Alich were found in the rafters, and four are still missing. Part of the loot from the Morris and Fink robberies had previously been located in other places.

Taylor has been out of the workhouse about two months, and had been staying at Lockland, O., but came to the city occasionally to rob jewelers. Two years ago, it is said, he stole about \$7,000 worth of gems from the Palm Beach Hotel in Florida, where he was employed as waiter, and the most of this was recovered in Cincinnati. He is said by the police to have served a term in a New York prison under the name of Charles Johnson, for grand larceny.

### Mae Thomas, Who Swallowed Diamond Stolen from Omaha Jewelers, Refuses to Undergo Operation and Will be Placed on Trial.

OMAHA, Neb., May 31.—The \$350 diamond swallowed by Miss Mae Thomas, three weeks ago, in the jewelry store of T. L. Combs & Co., has been located by the X-ray process, tightly clinging to the intestines in the region of the appendix. According to experts who have examined Miss Thomas, the membrane surrounding the diamond is inflamed and may cause appendicitis, thereby making an operation necessary.

It is said that the culet, or elongated point on the under side of the diamond, has penetrated the walls of the intestines and is stuck in that position. Whether or not it will ever be dislodged without an operation is a question. Physicians say that mucus may form around the stone in such quantities as to prevent it from ever troubling the girl.

She has been confined in the County Jail, and for a time it was believed that she would submit to an operation. The pain which she seemed to feel for several days subsided and she refused to allow the doctors to operate, although willing to take any medicine offered. She says that she would like to have the diamond removed, but objects to the use of a knife.

To-day it is given out that the young woman will be placed on trial for grand larceny, and as she has already confessed the theft of the diamond, it is supposed that a sentence of imprisonment will be imposed.

A meeting of creditors of Henry Greenbaum, Richfield Springs, N. Y., who is in bankruptcy, was held before Referee Hoyer at Oneonta last week, and the creditors elected David W. Woods, of Richfield Springs, as the trustee. Many claims were filed. The trustee was required to give a bond for \$4,000 and he has taken possession of the bankrupt's property.

SEND TO US ANY QUANTITY OF

# AMERICAN PEARLS

WE BUY FOR CASH.

Send by registered mail or express; we will make an offer  
by return mail. We will also buy any quantity of

**BAROQUE PEARLS (SLUGS).**

**BUNDE & UPMAYER CO.,**

Mack Block,

MILWAUKEE, WIS.

# MAURICE BROWER

Headquarters for American Pearls

Telephone, 6233 Cortlandt

12-16 JOHN STREET, NEW YORK

---

---

I make a specialty of purchasing for cash, jewelry and all kinds of precious stones which your customers desire to dispose of and which you do not wish to buy yourself.

---

---

Entire Stocks and Estates Bought. Bank References Given.

The Finest Collection of American Pearls in Stock.



**Frank Allsopp Killed in an Automobile Accident and His Wife Badly Injured.**

NEWARK, N. J., June 4.—The funeral of Frank Allsopp, of the wholesale jewelry manufacturing firm of Allsopp & Allsopp, Columbia St., this city, was held this afternoon at the home of his parents, Mr. and Mrs. George Allsopp. It was largely attended by members of the trade and business men generally, as he was more than ordinarily popular.

Mr. Allsopp's sudden death in an automobile accident near New Brunswick, Friday, was a great shock to the business community, particularly the jewelry trade. His wife, who was seriously injured in the same accident, was brought from the Wells Hospital at New Brunswick on Saturday afternoon and is now in St. Michael's Hospital in this city. She was told of her husband's death just before leaving New Brunswick as she insisted upon having him taken to Newark with her or knowing exactly what had happened to him. She has borne up remarkably under the shock. Both her legs are broken and one of her knees shattered. A successful operation was performed on the latter Saturday night, and to-day it was said that she is improving and that in the absence of any development of internal injuries which was at first feared it is now expected that she will recover.

Mr. Allsopp was an ardent automobilist. He had owned a big and powerful touring car since Easter week. With his three babies and his wife he made a fast run to Asbury Park on Friday, starting on the return trip to Newark at 1 o'clock in the afternoon. The three young women are the Misses Nellie and Annie Allsopp, daughters of Henry Allsopp, also a manufacturing jeweler, and Miss Florence Baker, of 21 Madison Ave. They occupied the rear seat of the machine.

While running at high speed on a straight stretch of road near Old Bridge, Mr. Allsopp tooted his horn for a wagon, which was ahead and going in the same direction, to turn out. The driver did so, but when Mr. Allsopp tooted his horn a second time the driver evidently became confused and turned back into the middle of the road and then directly across the path of the touring car. In order to avoid a collision Mr. Allsopp turned his machine sharply to the side of the road. Unfortunately there was a telegraph pole at that spot. The machine struck it with frightful force just as Mrs. Allsopp slid out of the machine to the ground and Mr. Allsopp slid into her seat. The front end of the automobile was smashed up and a piece of it struck Allsopp on the left side of the head, fracturing his skull and causing almost instant death. The three young women were brown at least 30 feet but escaped serious injury. Mrs. Allsopp lost consciousness and was later removed to the New Brunswick Hospital, the body of Allsopp being taken to a morgue in the same city.

Mr. Allsopp was a partner in the jewelry business with his brothers Thomas, Albert E. and Edmund F. He was one of seven sons, and was 31 years old. He was married but leaves no children. He had been highly successful in business.

**Death of David Daggett Coddling.**

NORTH ATTLEBORO, June 3.—David Daggett Coddling, one of the foremost citizens of North Attleboro and one of its pioneer jewelers, died this morning after an illness which extended over a period of months.

Mr. Coddling was born in Attleboro, Aug. 25, 1832, the son of Chloe Daggett and Abiel Coddling. At the age of 16 he removed to North Attleboro, and has made his home here ever since. He was one of the early partners in E. Ira Richards & Co., and assisted in the formation of T. I. Smith & Co., which is to-day one of the biggest jewelry concerns in the United States. After his withdrawal from T. I. Smith & Co. he founded the firm of D. D. Coddling & Co. When this concern went out of existence in 1888 Mr. Coddling withdrew from active business life.

Mr. Coddling married Miss Pemelia Kent, of Attleboro. From the union were born six children, five of whom survive—Mrs. E. A. Follett, D. Edgar Coddling, Mrs. George W. Cheever, of Boston; Miss Ada Coddling and Mrs. Newell C. Bullard. The funeral will be held Wednesday afternoon at his late residence, 21 High St.

**Death of James R. Connell.**

PORTSMOUTH, N. H., May 30.—James R. Connell, who died suddenly of heart disease Sunday, was the oldest jeweler of this city and had been in business continuously for over 35 years.

The deceased was born at Schroon Lake, N. Y., in 1849, and became a member of the firm of Hutchinson & Connell, in 1872, continuing until 1880, when the firm dissolved. Both partners remained in the trade, conducting separate establishments. Mr. Connell had a good business and built up a large trade. Outside of the jewelry business Mr. Connell was interested in other enterprises and was one of the most prominent merchants of the town. He was highly regarded as a citizen and had held several positions of trust, at one time being a member of the City Council. He is survived by a widow, three brothers and three sisters. One of his brothers was Congressman from Nebraska and was succeeded in 1890 by William J. Bryan. The funeral was held Tuesday.

The first of what is to be a series of baseball games between nines recruited from Philadelphia jewelry houses was played Saturday at Logan between teams representing M. Sickles & Sons and S. O. Hurlburt & Sons. Sol. Sickles provided the balls and bats, and the employes of both establishments, as well as many other baseball enthusiasts in the trade witnessed a well-played game. Max Polak captained the nine of M. Sickles & Sons, and John A. Smith that of H. O. Hurlburt & Sons. The score was 22 to 7, in favor of M. Sickles & Sons' team. The line up was as follows: M. Sickles & Sons—G. Hunt, ss.; C. Levy, lb.; T. Baer, c.; B. Kirscher, p.; B. Robertson, 3b.; M. Polak, rf.; T. Madden, 2b.; C. Bohrer, lf.; B. Artz, cf. H. O. Hurlburt & Sons—H. Shope, lf.; E. Farnan, cf.; J. Weyl, lb.; E. Kranich, ss.; Seels, rf.; F. Barman, 3b.; F. Hurlburt, 2b.; J. Smith, c., and P. Schropter, p.

**Certain Buckles and Millinery Ornaments Held to be Dutiable at 45 Per Cent.**

Dress and belt buckles and various millinery ornaments are held to be dutiable at 45 per cent, as manufactures of glass or paste and not at 60 per cent, as jewelry by a decision announced last week by the Board of United States General Appraisers, New York, sustaining in part a protest of Hawley, Green & Engel, against the assessment of duty by the collector at New York. General Appraiser Sharretts in his opinion says:

"The merchandise covered by these protests consists of—

"1. Dress and belt buckles, clasps, slides, cabochons, and other ornaments composed of steel or other base metal, some of which are more or less elaborately enameled and some set with imitations of diamonds, rubies, sapphires, etc., all the foregoing being similar to the merchandise covered by findings 2 and 3 of G. A. 6141 (T. D. 26681).

"2. Ornaments composed of metal and paste in imitation of jet, returned by the appraiser as manufactures of colored glass and metal, glass chief value, and assessed by the collector with duty at the rate of 60 per cent, ad valorem under Par. 100, tariff act of 1897, said ornaments being similar to those passed upon by the Circuit Court for the Southern District of New York in *Bader v. United States* (116 Fed. Rep., 541).

"From the Board's decision in G. A. 6141 (*supra*), wherein it was held that belt buckles and clasps similar to those now in dispute were dutiable at 60 per cent, ad valorem under Par. 434, the importers duly appealed to the Circuit Court for the Southern District of New York, *Blumenthal v. United States* (suit 4108), and introduced additional evidence before the referee.

"Influenced by the decision of the Circuit Court of Appeals, second circuit, in *United States v. Schiff* (139 Fed. Rep., 549; T. D. 26492), an order of reversal has now been entered in suit 4108 (*supra*), and acquiesced in by the Treasury Department, following which acquiescence of the Department we sustain the claim in the protests that all the merchandise returned by the appraiser as jewelry and assessed with duty at the rate of 60 per cent, ad valorem is dutiable at 45 per cent, ad valorem under Par. 112 or 193, tariff act of 1897.

"As to the merchandise included in the second class, on the authority of *Bader v. United States* (*supra*), we also sustain the claim in the protests that the same is dutiable at the rate of 45 per cent, ad valorem under Par. 112.

"The decision of the collector in each case is reversed to the extent indicated."

**Market Price of Silver Bars.**

The following are the quotations of silver bars in London and New York, as reported by Zimmerman & Forshay:

	New York.	London.
May 29.....	\$.67¾	31 1-8d.
" 31.....	.67¾	31 1-8d.
June 1.....	.67¾	31 1-8d.
" 2.....	.67¼	31 1-16d.

M. O. Knudson has succeeded to the business of J. E. Hunt, in Inwood, Ia.

ADDISON W. WOODHULL, President.  
FRANK K. HUFF, Vice-President.

GILBERT T. WOODHULL, Treasurer.  
WILLIAM J. McQUILLIN, Secretary.

# MOUNT & WOODHULL,

IMPORTERS OF

**DIAMONDS,  
OTHER PRECIOUS STONES,  
PEARLS, ETC.**

MAKERS OF

**FINE  
DIAMOND  
JEWELRY.**

**26 Maiden Lane,  
(Southwest Corner Nassau Street)**

**NEW YORK.**

**PARIS ADDRESS:  
5 SQUARE DE L'OPERA.**

**BAGG, PERINE & CO.,**  
RARE SPECIMENS OF  
DIAMONDS AND OTHER  
PRECIOUS STONES,  
21 & 23 MAIDEN LANE, NEW YORK.  
Tel. No. 6228 Cortlandt.

**EMERALDS,  
DIAMONDS  
AND  
PEARLS.**

**RUBIES AND  
SAPPHIRES.**

**CABLE ADDRESS:  
MILBAGG.**

## Pearl Necklaces and Collarettes.

**Mounted  
Diamond  
Jewelry**

of every  
description.



*Ludwig Nissen*

*Ernst Weiss*

*Emil Knopf  
Johann W. Ruelker  
Joseph L. Wood*

182 & 184 BROADWAY  
NEW YORK

Large  
assortment  
of all kinds of  
very fine, fancy  
and rare gems,  
including Pearls,  
Diamonds, Rubies,  
Emeralds and Sapphires.

**Particularly Fancy  
Colored and Fancy  
Shaped Diamonds.**

## Scenes in San Francisco.

Snapshots of Jewelers and Jewelry  
Store Sites Taken by a New Yorker  
Directly After the Earthquake.

Pictures presented in this issue of scenes in San Francisco are from photographs taken immediately after the great earthquake by Fred. H. Wilkinson, who for a number of years has traveled in the west for the A. Wittnauer Co., 13 Maiden Lane, New York. The prints were kindly loaned to THE CIRCULAR-WEEKLY by Mr. Wilkinson in order that its readers might have an opportunity of getting from them a vivid impression of the happenings in the city which they were recorded by his faithful camera.

When the earthquake came Mr. Wilkinson was in bed at the Palace Hotel. He hurried down to the office and took his three sample cases to the Crocker-Woolworth safe deposit vaults. After some difficulty he prevailed upon the night watchman to place the cases inside the door, and the watchman said that a little later they would be put in one of the vaults. The traveler had, therefore, the satisfaction within an hour after the earthquake of seeing his cases in a comparatively safe place. The watchman, however, refused to give any receipt. Later in the day Mr. Wilkinson returned to learn if the cases had been placed in the vaults. At that time everything was in confusion. He found that the vault were packed full and was told that his cases were inside one of them. With much difficulty he induced the officers of the company to open the vaults until he finally satisfied himself that the cases had been thrown together with all kinds of property, all in the greatest confusion. The officers of the company would give no receipt for anything. They had by that time a force of watchmen who saw that nothing was taken away.

From the day of the earthquake until May 6 Mr. Wilkinson remained in the city, at which time he came east he had the knowledge that all his samples had been saved, the cases having been returned to his custody. During that time Mr. Wilkinson enjoyed the hospitality of G. A. Fleissner, of the Fleissner & Marshall Co. The jeweler's firm's store was in the wrecked district, but Mr. Fleissner's home was fortunately 10 or 12 blocks from the edge of the fire zone. Mr. Wilkinson says that to Mr. Fleissner's open-hearted hospitality a number of persons in the trade are under deep obligations.

Herbert Van Ness, who represents several Newark and New York houses in San Francisco, his brother Arthur Van Ness, who was associated in the business, and the mother were sheltered at the Fleissner home.

Having plenty of time on his hands Mr. Wilkinson went about with his camera and obtained one of the finest collections of photographs of the ruins in different parts of the city that has been seen in the east. The pictures in this issue were selected because of special interest to members of the trade.

In the accompanying pictures No. 1 shows a group of jewelers who have been out foraging and are returning to G. A. Fleissner's residence. The group included Mr. Fleissner and David Marshall, of the



SCENES IN THE JEWELRY DISTRICT OF SAN FRANCISCO DIRECTLY AFTER THE EARTHQUAKE.  
(See text on pages 42 and 45.)

**WM S. HEDGES & CO.,**

IMPORTERS AND CUTTERS OF

**DIAMONDS.**

Precious Stones and Pearls.

**170 Broadway, Corner Maiden Lane. New York.**

27 Holborn Viaduct, London.

**Saunders, Meurer & Co.** Cutters and Importers of**DIAMONDS** AND OTHER  
PRECIOUS STONES

FINE PEARLS A SPECIALTY.

65 Nassau St., cor. John St., Prescott Building,  
Telephone, 1613 Cortland. **NEW YORK.****Chas. L. Power & Co.,** Cutters and Importers,**DIAMONDS**

AND OTHER PRECIOUS STONES,

170 Broadway, corner Maiden Lane, **NEW YORK.**

27 Holborn Viaduct, London.

**GOODFRIEND BROS.,**

IMPORTERS AND CUTTERS OF PRECIOUS AND IMITATION STONES.

Pearls

Rubies

Sapphires

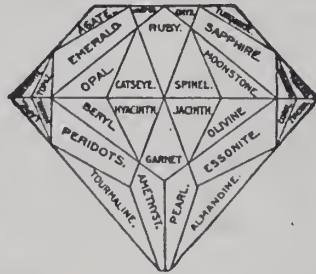

Tourmalines

Gem Corals

Opals

Emeralds

COPYRIGHT, 1895, BY GOODFRIEND BROS.

25<sup>th</sup> Westminister St., Providence, R. I.  
10 Rue Cadet, Paris.Tel. No.  
632 Cortl't.

9-11-13 Maiden Lane, New York.

**T**HE continued scarcity of fine Pearls is the conspicuous feature of the day in European markets.

It not only takes days of hunting, but oftentimes weeks, before one can find what he **actually** needs.

American buyers are therefore quite ready to appreciate the value of the co-operation of a "GEMFINDER" always on the spot.

A word in advance of your coming to Europe and an idea of your wants would insure the possibility of securing the desired goods and save time.

**FREDERICK A. JEANNE,**

"Gemfinder,"

5, Square de l'Opéra, PARIS, FRANCE.

London: Chancery Lane Safe Deposits. New York: Maiden Lane Safe Deposit Co.

**Mr. Retailer:**

If the American People only **KNEW** the purity of the product of the **SOLIDARITY WATCH CASE CO.**, advertising would be a waste of money.

We never buy old gold and nothing but Virgin Gold, alloyed to 18k. and 14k., is ever allowed to enter our product.

That rich appearance which always distinguishes our cases demonstrates these facts.

Sold through the Jobbers only

**SOLIDARITY****Watch Case Co.**

Established 1885.

**3 Maiden Lane, New York.**

GENERAL SELLING AGENTS

JOHN W. SHERWOOD  
FRANK E. HARMER

Fleissner & Marshall Co.; Mr. Marshall's brother, Robert, and Mr. Wilkinson.

Picture No. 2 shows ruins of Market St., on which were so many jewelry concerns. The building which stands at the left with the high tower, little damaged, is the Call building, and just to the right of it stands all that is left of the Camm building, in which numerous jewelers had offices.

Picture No. 3 shows a group out foraging. Herbert Van Ness is at the left, Mr. Wilkinson is in the center and at the right with his coat off is Robert Marshall.

Shreve & Co.'s store is shown in picture No. 4 this being a side view taken from Post St.

Ruins of the Fleissner & Marshall Co.'s store are vividly set forth in picture No. 5.

ther Van Ness, without a hat. At the right is Mr. Samuelson, of the Towle Mfg. Co. In the center are Mr. Fleissner's parents and the mother of the Van Ness brothers.

**San Francisco's Wholesale and Retail Houses Re-Establishing Themselves in the City—Jobbers Moving Back from Oakland.**

SAN FRANCISCO, Cal., May 31.—The San Francisco wholesale trade has been busy this week getting itself re-established in San Francisco. Most of the jobbers, who were for a time in the Globe Hotel building in Oakland, are now located in San Francisco, where stock is being arranged for business. The quarters so far occupied are

**The Diamond Markets.**

ANTWERP, May 24.—Business is exceptionally quiet at present, owing chiefly to the scarcity of the desirable goods. Very large stones are not asked for, but small white and light brown roses, as well as good m $\acute{e}$ lée of about 250 francs per carat, are in great demand. Clean goods being scarce, ordinary sorts, such as brown, yellow and "atlas" are selling at good prices. The same can also be said of defective stones.

A well-known diamond manufacturer, J. F. De Roeck, living at Berchem, Longue rue St. Jacques, 97, died recently at the age of 41 years.

The following are among those who have been here during the past fortnight: Messrs. Jacob Strauss, Alf. Loewenthal, Ben Rees, Rosenlack, Laubheim, De Sola Mendés, of New York; Mr. Sickles, Philadelphia; Mr. Kohn, Vienna; Messrs. M. Slabetzky, Wmsz B. Rapoport, Slycer, Mitacoulo, Arm. Levy, Herrenstein, Aronstein, S. Horowitz, Lambert frères, M. De Vries, all of Paris; Mr. Monnasschn, St. Petersburg; Mr. H. Strauss, Hanau; Mr. Churgin, Kiev; Mr. Sommer, Basel; Mr. Beckman, New Zealand; Messrs. Abend, Frenzel, Berlin; Mr. Kahn, Stuttgart; Mr. Urbanck, Frankfurt at Main; Mr. Goldsmidt, London; Mr. Weintraub, Warsaw; Mr. J. Benhaïm, Constantinople; Mr. Krall, Elberfeld.

The "Gilde der Antwerpsche Diamant Nyverheid," which has employers as honorary members, celebrated the anniversary of its founding by a procession followed by a meeting and ball at the Grand Cafe, rue Breydel.

AMSTERDAM, May 23.—A slight improvement in the diamond trade here has been noticed within the last few days. There have been several good purchases by American buyers of m $\acute{e}$ lée in two, three and four grains. Numerous merchants and brokers left recently for Paris, taking with them a stock of small roses and brilliants. Merchants in this city were able to procure more lots of rough diamonds at London. They bought Bultfontein, Kimberley, Wesselson and Jaegersfontein diamonds.

The several local diamond shops are still working full force.

PARIS, May 24.—The weather is bad, and the condition of the precious stone market is not much better. The number of foreign merchants who were looked for this month has been fewer than expected, in consequence of which the transactions were not as large as hoped for. The sale of diamonds were not so good, but pearls were bought in much larger quantities. Colored stones are very quiet at this time, due to the fact that many of the regular buyers of this kind of goods have not yet arrived.

The firm of Picard & Carpentier was recently established, with offices at 8, rue de Choiseul, for a term of four years with a capital of 75,000 francs.

Mr. Menki, a diamond merchant of rue de Chateaudun, was married last week to Miss Mervick.

Large quantities of industrial "borts" were placed on the market and sold.



LEVINSON BUILDING, SHOWING RUINS OF STORES OF W. K. VANDERSLICE CO. AND CALIFORNIA JEWELRY CO.

G. A. Fleissner is at the right, and his clerk, Herbert Brandon, at the left. The safe sank out of sight.

The seventh floor of the Camm building is shown in picture No. 6. Mr. Wilkinson is standing on a girder, where had been the office of Wm. Landrum, the representative of several eastern jewelry houses.

John and Julius Hammersmith, of Hammersmith & Field, are standing outside their wrecked store in picture No. 7, and are looking at the ruined interior.

In the picture No. 8 John Hammersmith and an employe have entered the store and are shown standing at the safe. It will be noticed that the door of the safe is partly open. Whether it was accidentally left open before the fire, or was loosened by the flames, is uncertain.

After the ruins of Hammersmith & Field's store had been carefully searched under the direction of the members of the firm a part of the debris was thrown across the street. The picture No. 9 shows a group of men searching this debris thinking that something of value may be found there.

A group standing outside of G. A. Fleissner's house is shown in the last picture. At the left, wearing a soft hat, is Herbert Van Ness; next to him is his brother, Ar-

more or less incomplete, and the furnishings are not of the best. Jobbers have been obliged to content themselves for the time being with whatever is most available in the way of safes, counters and wall cases.

Some retail stores which were established early on Fillmore St. are doing well with certain classes of goods. Most of the best-known stores are, however, still only partially established. The new stores on Van Ness Ave. are being put up rapidly and will be occupied within a week or two. One retail store has already announced a location in the downtown district on Market St. There is a notable falling off in the number of booths and tents, which have been scattered along Market and other streets for the sale of curios, burned jewelry and silverware, burned art goods, and other novelties recovered from the ruins of Chinatown. The city authorities have imposed a license and other restrictions which are tending to reduce the number of these transient establishments.

In Oakland the trade is heavy and the jewelers are doing a better business than before, the increase in population making itself felt. There has, however, been a decided inflation in rents and this is causing adverse comment.

# Chester Billings & Son

1840

Successors to  
Kandel, Barmore & Billings

1906

Importers of Diamonds  
Other Precious Stones, and  
Pearls, Diamond Jewelry

1840, Kandel & Barmore; 1866, Kandel, Barmore & Co.; 1880, Kandel, Barmore & Billings; 1897, Chester Billings & Son

New York, 58 Nassau Street, 29 Maiden Lane  
London: 22 Holborn Viaduct, E. C. Paris: 53 Rue de Chateaudun  
Amsterdam: 2 Tulp Straat

## FINE AMETHYSTS AND AQUAMARINES

We are prepared to furnish you with a selection at once, and solicit your order on memorandum.

UNIQUE STONES  
are our  
SPECIALTY.

Send for our new booklet containing a list of over 100 precious stones, their distinguishing features and colors, also articles on "THE INFLUENCE OF GEMS ON CERTAIN DAYS," and "THE SIGNIFICANCE OF GEMS," a handy book of reference that will assist you in selling.

## The Passmore Gem Co.,

373 WASHINGTON STREET,  
BOSTON, MASS.



### COOPER'S SUN RAY DIAMOND

HAS 100 per cent. more brilliancy than any other style of cutting.

*We Challenge the World.*

Send your old mine and yellow diamonds to be recut; if the effect is not 100 per cent. better, NO CHARGE.

**COOPER DIAMOND**  
Cutting and Polishing Industry of America  
49 MAIDEN LANE, NEW YORK.

Factories, 8th Ave. & 18th St., Brooklyn.

### L. BONET, CAMEO PORTRAITS,



Importer of Precious Stones,  
41 Union Square, NEW YORK.



TRADE-MARK.

## AZTEC TURQUOISES

Mines: MINERAL PARK, ARIZONA.



TRADE-MARK.

Of true CERULEAN BLUE, the rarest and most fashionable shade. Turquoises bearing Company's trade-mark are GUARANTEED. A new Turquoise will be given without question to replace any that discolors. The leading Jewelers of the World sell AZTEC TURQUOISES.

**THE AZTEC TURQUOISE COMPANY,**  
12-16 JOHN STREET, NEW YORK.

## GARREAU & GRISER

60 & 70 Nassau St., New York.

LAPIDARIES. PRECIOUS STONES  
GEMS in Unique Cuttings.

Cutters of  
DIAMONDS

THE BOSTON DIAMOND HOUSE

## JOHN B. HUMPHREY CO.

387 Washington St., Boston, Mass.

We are receiving Monthly Shipments of Diamonds from our Brazilian Mines, which are on exhibition at our Boston Office.

Cutters of  
DIAMONDS

THE MUELLER LAPIDARY CO.,

248 Halsey Street, Newark, N. J.

CUTTERS

Precious and Semi-Precious Stones.

### Board of United States General Appraisers Passes on Cases Involving Duties on Jewelry and Precious Stones.

The Board of United States General Appraisers, New York, have announced, in the last week, the following decisions on cases involving duties on jewelry, precious stones and imitations:

**MILLINERY ORNAMENTS.**—Protest of J. Johnson & Co. against the assessment of duty by the Collector at New York. G. A. 6130 (T. D. 26653) followed, relating to millinery ornaments.

**RECONSTRUCTED RUBIES.**—Protests, etc., of G. A. Woodman *et al.* against the assessment of duty by the Collector at Chicago. G. A. 6336 (T. D. 27278) followed, relating to reconstructed rubies.

**IMITATION PRECIOUS STONES.**—Protests, etc., of Albert Lorsch & Co. against the assessment of duty by the Collector at Providence. G. A. 6289 (T. D. 27112) and G. A. 6342 (T. D. 27292) followed, relating to imitation precious stones.

**IMITATION PRECIOUS STONES.**—Protests, etc., of Loeb & Co. *et al.* against the assessment of duty by the Collector at New York. Same as above.

**BRASS SWIVELS—PARTS OF JEWELRY.**—Protests, etc., of C. B. Richard & Co. against the assessment of duty by the Collector at New York. G. A. 2889 (T. D. 7255) followed, relating to brass swivels and parts of jewelry.

**BRASS SWIVELS—PARTS OF JEWELRY.**—Protests, etc., of Manhattan Chain Co. *et al.* Same as above.

**PRECIOUS STONES.**—Protest of G. Veeck against the assessment of duty by the Collector at New York. The merchandise consisted of precious stones cut in the form of beads and of drops or pendants, but not set. As claimed by the importer, it was held dutiable as precious stones cut but not set under Par. 435, Tariff Act of 1897. G. A. 6097 (T. D. 26586) followed.

**RECONSTRUCTED RUBIES.**—Protests, etc., of American Express Co. *et al.* against the assessment of duty by the Collector at New York. Same as above.

**RECONSTRUCTED RUBIES.**—Protests, etc., of A. G. Guerden against the assessment of duty by the Collector at Philadelphia. Same as above.

**ORNAMENTAL PINS—JEWELRY.**—Protest of Goldberg & Co. against the assessment of duty by the Collector at New York. The articles in dispute consisted of fancy ornamental pins, which the Board held to have been properly classified under Par. 434, Tariff Act of 1897, as jewelry.

**CHATELAINE BAGS—LACE WEARING APPAREL.**—Protest of C. H. Wyman & Co. against the assessment of duty by the Surveyor at St. Louis. On the authority of Tiffany & Co. United States (T. D. 25316), the Board held chatelaine bags set with imitation of precious stones not to be jewelry but to be dutiable as manufactures of metal under Par. 193, Tariff Act of 1897, as claimed by the importers. Certain wearing apparel was held to have been properly classified under Par. 339, relating to embroideries and articles composed in part of lace. G. A. 5866 (T. D. 25844) followed.

**RECONSTRUCTED RUBIES.**—Protests, etc., of Sam Hochhaus *et al.* against the assess-

ment of duty by the Collector at New York. G. A. 6336 (T. D. 27278) followed, relating to reconstructed rubies.

**TOY JEWELRY.**—Protest of A. Strauss & Co. against the assessment of duty by the Collector at New York. Certain jewelry designed solely for the amusement of children was held dutiable as toys under Par. 418, Tariff Act of 1897. Strauss & Co. United States (T. D. 26903) followed.

**IMITATION PRECIOUS STONES.**—Protest of Rud. C. Hahn & Co. against the assessment of duty by the Collector at New York. G. A. 6289 (T. D. 27112) followed, relating to imitation precious stones.

**IMITATION PRECIOUS STONES.**—Protest of H. Nordlinger's Sons against the assessment of duty by the Collector at Providence. Same as above.

**IMITATION PEARLS, PIERCED.**—Protest of Overton & Co. against the assessment of duty by the Collector at New York. G. A. 6088 (T. D. 26554) followed, relating to pierced imitation pearls.

**BELT PINS.**—Protests, etc., of Callender McAuslan & Troup Co. against the assessment of duty by the Collector at Providence. G. A. 6139 (T. D. 26679) followed, relating to belt pins.

**IMITATION PRECIOUS STONES.**—Protests, etc., of Julius Mamluck & Co. against the assessment of duty by the Collector at New York. G. A. 6289 (T. D. 27112) followed, relating to imitation precious stones.

**IMITATION PRECIOUS STONES.**—Protests etc., of H. Nordlinger's Sons against the assessment of duty by the Collector at Providence. The Board held circular pieces of glass or paste, five-eighths of an inch in diameter, molded so as to represent in high relief the frontal part of an owl's head, and ornamented with superadded decoration, to have been properly classified as manufactures of paste under Par. 112, Tariff Act of 1897. But the importers' contention that the importations should have been classified as imitation precious stones under Par. 435 was sustained (1) as to incrustated stones, (2) as to circular pieces of glass or paste about one-half inch in diameter, the backs of which have been impressed with a series of diamond-shaped figures outlined in silver foil and colored in imitation of precious stones, the stamping and coloring being effected during the process of manufacture and not subsequent thereto, and (3) as to oblong pieces of glass or paste made in imitation of jet, one and one-quarter inches long and three-quarters of an inch wide. Note G. A. 5386 (T. D. 24581), G. A. 5981 (T. D. 26206), G. A. 6342 (T. D. 27292), and G. A. 6289 (T. D. 27112).

**IMITATION PEARLS, PIERCED.**—Protest of R. F. Lang against the assessment of duty by the Collector at New York. G. A. 6088 (T. D. 26554) followed, relating to imitation pearls pierced.

**PRECIOUS STONES.**—Protest of G. Veeck against the assessment of duty by the Collector at New York. Certain so-called "kristall rondelles" were held dutiable as precious stones cut but not set, under Par. 435, Tariff Act of 1897. G. A. 6097 (T. D. 26586) followed.

**METAL FOR CHAINS—JEWELRY.**—Protest of Albert Lorsch & Co. against the assessment of duty by the Collector at New York.

The merchandise consisted of metal fob chains, and was held to have been properly classified as jewelry under Par. 434, Tariff Act of 1897.

**SILVER WATCH CHAINS—JEWELRY.**—Protests, etc., of Albert Lorsch & Co. against the assessment of duty by the Collector at New York. The merchandise consisted of silver watch chains and was held to have been properly classified as jewelry under Par. 434, Tariff Act of 1897.

**PRECIOUS STONES.**—Protest of Nordlinger & Mamluck against the assessment of duty by the Collector at New York. The merchandise was held dutiable as precious stones under Par. 435, Tariff Act of 1897, as claimed by the importers.

**ROCK-CRYSTAL INTAGLIOS.**—Protest 22824/h of Nordlinger & Mamluck against the assessment of duty by the Collector at New York. G. A. 6285 (T. D. 27108) followed, relating to rock-crystal intaglios.

**BRASS SNAPS—NECKLET SNAPS—JEWELRY.**—Protests, etc., of Manhattan Chain Co. against the assessment of duty by the Collector of Customs at New York. The merchandise, which was classified as parts of jewelry under Par. 434, Tariff Act of 1897, was claimed to be dutiable as manufactures of metal under Par. 193. As to a portion consisting of necklet snaps set with imitation precious stones, the Board found it to be commonly known as parts of jewelry. As to another portion, consisting of brass swivels, valued at about seven cents per gross, the Board held it not to be parts of jewelry, and sustained the protest to that extent. G. A. 6330 (T. D. 27,255) followed.

**MILLINERY ORNAMENTS—IMITATION PRECIOUS STONES.**—Protest 125,542 of Veit, Son & Co. against the assessment of duty. As claimed by the importers, a portion of the merchandise, consisting of millinery ornaments, was held dutiable as manufactures of the component of chief value, and another portion, consisting of imitation rock crystals, was held dutiable as imitation precious stones under Par. 435, tariff act of 1897.

### Death of Fred. R. Ingalls.

LONG PINE, Nebr., May 30.—Fred. R. Ingalls, who died last week as a result of a bullet wound self-inflicted, had been in the jewelry business here for a long time, and the tragedy was quite a shock to his many friends in this section. Mr. Ingalls had been drinking heavily, and a warrant had been issued for his arrest as an inebriate. When the Sheriff tried to serve the warrant last Wednesday, Mr. Ingalls resisted arrest, drew a revolver and finally fired two bullets into himself, receiving fatal wounds in the abdomen from which he died the following day.

The deceased was the son of J. F. Ingalls, an old and well-known jeweler, who started in business in Waukegan, Ill., over 40 years ago. In 1891 the elder Ingalls opened a branch store in Long Pine and took his son in partnership as J. F. Ingalls & Son. After continuing for 10 years the deceased took over the business, which he conducted until the breaking out of the Spanish-American War, and then turned the store over to his father while he served in the American army. When the war was over he came back to Long Pine and resumed business again.

# EICHBERG & CO.,

IMPORTERS AND CUTTERS OF

## DIAMONDS.

65 NASSAU STREET,

(Prescott Building.)

NEW YORK.

# STERN BROS. & CO.,

IMPORTERS AND CUTTERS OF

## DIAMONDS,

CUTTING WORKS:  
138-142 West 14th St., N. Y.

CHICAGO, LONDON,  
103 State Street. 29 Ely Place.

68 Nassau St.,  
NEW YORK.

GUESSING HAS CEASED TO BE A VIRTUE

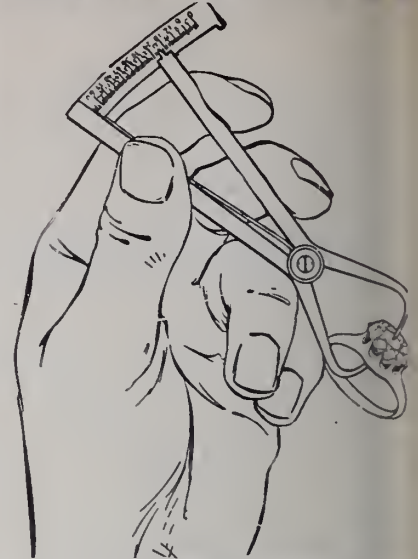

THE MOE DIAMOND WEIGHT GAUGE is the only correct system for determining weight of mounted diamonds.

ENDORSED BY THE LEADING JEWELERS. Those who are not familiar with the device kindly send for descriptive booklet.

Charles Moe, Inventor, 80 Adams St.,  
CHICAGO, U. S. A.

Price for Instrument and Book, \$3.75 prepaid.

May also order from the following agents:  
D. C. PERCIVAL & CO., Boston; CROSS  
BEGUELIN and R., L. & M. FRIEDLANDER  
New York; M. SICKLES & SONS, Philadelphia  
NORDMAN BROS., San Francisco; E. &  
SWIGART, Cincinnati; LEONARD KROWE  
New Orleans.

BACKES & STRAUSS, Sole Agents for Europe  
and India, London, E. C., 14-17 Holborn Viaduct

**A. ROSEMAN, 9-11-13 Maiden Lane, New York**

IMPORTER OF

# DIAMONDS

Maker of Diamond Jewelry



TRADE-MARK.

Established 1872

HEADQUARTERS FOR

# AMERICAN WATCHES

ESTABLISHED  
1872.

# E. HAHN & CO.,

33, HATTON GARDEN, 33  
LONDON.

CABLE ADDRESS:  
"AQUAMARINE," LONDON.

Precious Stones, Semi-Precious Stones,  
Ceylon Fancy Stones, Pearls, Corals, Opals  
and All Novelties in Stones suitable for

- I. All Jewelry and Export Purposes.
- II. Art Metal Work, Church Work.
- III. Mechanical Purposes.
- IV. Collectors, Educational purposes, Museums.

IMPORTERS

## DIAMONDS

CUTTERS

# Jacob Strauss & Sons

14 MAIDEN LANE

NEW YORK

**LEO GOLDSMITH, IMPORTER OF DIAMONDS**

TELEPHONE: 4115 CORTLAND.

and Precious Stones. Headquarters for Reconstructed Rubies and Sapphires. All sizes and forms.

9-13 MAIDEN LANE,

NEW YORK.

# SOHN and HYMAN

IMPORTERS OF PRECIOUS AND IMITATION STONES

Crystals Engraved and Painted from Photo. Crests and Coats of Arms Engraved. Stone Seal Engravers and Incrusters. Lapidary Work a Specialty.

JOBGING STONES A SPECIALTY

47 and 49 Maiden Lane,

NEW YORK

## REMOVAL NOTICE!

# THE LYONS GEM CO.,

Have Removed to

## 35 Maiden Lane, New York.

A FULL AND COMPLETE LINE OF PRECIOUS,  
SEMI-PRECIOUS AND IMITATION  
STONES ALWAYS IN STOCK.

Our Specialty is Scientific Rubies.

Local and out of town jobs promptly attended to at reasonable prices. Send us your mountings to be set with matched stones. A trial order will convince you that our prices are right, and our goods select.

JACOB BASCHKOPF,  
DIAMONDSETTER

LETTER AND MONOGRAM

ENGRAVER,

9-13 MAIDEN LANE,

Room 701  
Jewelers' Bldg.

NEW YORK

# EVERY REPAIR

Should Have a Copy of

## "The JEWELRY REPAIRER'S HANDBOOK"

Issued by

THE JEWELERS' CIRCULAR PUBLISHING CO.,

11 John St., New York.

Price 75 Cents



### Another Attempt to Get Goods from Maiden Lane Firm by Means of a Forged Order.

An effort was made to obtain three field glasses from the Julius King Optical Co., Maiden Lane, New York, by means of forged order, last Monday. At 9 o'clock the morning a uniformed messenger boy appeared and presented to Leo Wormser envelope on which was the name of the B. Claflin Co., dry goods jobbers. In it was an order written on the company's letterhead as follows:

NEW YORK, June 4, 1906.  
 The Julius King Optical Co., 2 Maiden Lane:  
 Gentlemen—Kindly send by bearer 1/21, 1/24, No. 550 glasses, on memo., and oblige,  
 The H. B. CLAFLIN Co.  
 Per Morris.

S.—Enclose memo, bills inside.

Mr. Wormser was suspicious and besides had some time ago ceased to deliver goods on written orders. The H. B. Claflin had not ordered this way before. Stepping to the telephone Mr. Wormser quickly learned that the order was forged. The affidavits sent one of their men and a detective came from police headquarters.

The boy, when questioned, said that he had been sent from 296 Broadway, where he had answered a call, and had met a man in the hallway. The man told him to get a package and carry it over to Claflin's. It was concluded that the man's intention was to intercept the boy before he got to the goods house.

Accordingly a dummy package was given to the lad and he was told to walk over to the dry goods house. The detective followed. Presumably, the man had been warned by the delay as he did not appear. Detectives Nugent and McGuinness are trying to find the forger. The glasses described in the order cost about \$40.

### Voluntary Petition in Bankruptcy Filed Against Edelhoff Bros. & Co.

A petition in bankruptcy was filed Wednesday of last week against Edelhoff Bros. Co., formerly retailers at 574 Fifth Ave., with the following creditors: Larter & Sons, \$1; Fera & Kadison, \$14,063; Carter, Lowe & Co., \$181. Rawson L. Wood, of R. Wood & Sons, early in March was appointed receiver, and under his receiver-ship a systematic examination of the books and accounts has been made and all of the assets available up to this time have been put into cash.

As the receiver had no power to distribute the assets he and the other creditors presented by the Jewelers Board of Trade arranged for the filing of the bankruptcy petition. The allegation made in the petition is that the corporation, while insolvent, delivered to favored creditors diamonds and other assets to the value of \$5,000.

The appointment of the receiver for this corporation was one of the consequences of the failure of Schickerling Bros. & Co., manufacturers at 28 E. 22nd St. The affairs of the two corporations were so closely woven together that the bankruptcy of one involved the other. Because of the closeness with which some of the accounts were kept and the complicated character of the relations between the two concerns an examination of the books has been an

unusually intricate process and the experts only recently completed their labors.

### Decisions by the Board of United States General Appraisers, Affecting Duties on Decorated Art Wares, Etc.

Decisions by the Board of United States General Appraisers, New York, in cases involving duties on decorated earthen ware, glass ware and various art products, have been announced in the last week as follows:

*Earthen Ware Heads.*—Protest of D. Buhig against the assessment of duty by the Collector at New York. Protest sustained on the authority of G. A. 6229 (T. D. 26915), relating to earthen ware heads.

*Molded Glass, Imitation Jet.*—Protest of Veit, Son & Co. against the assessment of duty by the Collector at New York. Certain articles made in imitation of jet, which were classified as cut glass under Par. 100, Tariff Act of 1897, were found to be composed of molded or pressed glass, and held dutiable under Par. 112 as manufactures of glass as claimed by the importers.

*Stems, Manufactures of Metal.*—Protest of Geo. Borgfeldt & Co. against the assessment of duty by the Collector at Baltimore. Certain stems with metal lids, which were classified as decorated earthen ware or stone ware, were claimed to be dutiable under Par. 193, Tariff Act of 1897, as manufactures of metal. Protest sustained.

*Church Statuary.*—Protest of J. Ochoa y Hermano against the assessment of duty by the Collector at San Juan. Benziger v. United States (192 U. S., 38; T. D. 21977) followed, relating to church statuary.

*Medallions.*—Protest of Geo. Borgfeldt & Co. against the assessment of duty by the Collector at Philadelphia. A portion of the merchandise, consisting of glass medallions with metal frames, was held dutiable as manufactures of metal under Par. 193, Tariff Act of 1897, as claimed by the importers. G. A. 6064 (T. D. 26446) followed.

### Trade Gossip.

Webb C. Ball, Cleveland, O., has been appointed general time inspector of the Lehigh Valley Railroad, with headquarters at South Bethlehem, Pa.

Isaac Brush, Bridgeport, has had on display in his show window the silver loving cup which will be given as a prize to-day, in a competitive drill between Ivanhoe and St. Paul's Commandery, Knights Templar, at Madison Hall, at that place.

The Holtzer-Cabot Electric Co., Brookline and Boston, Mass., is mailing the trade a concise and artistic four-page circular, dealing with the company's 1906 model electric lathe motors for buffing, grinding, polishing, etc. The folder is printed in two colors, and shows excellent cuts of the firm's Boston and Brookline manufacturing and office buildings. Perhaps the most novel feature contained in the text is the offer of the company to install a motor on trial, subject to the acceptance of the jeweler after having given it a severe and thorough test. A price-list and eight clear illustrations of direct, alternating and combination motors, buffers and grinders and their many interchangeable parts, artistically arranged, complete the instructive circular.

The first meeting of the creditors of Otto H. Fasoldt, Albany, N. Y., who was recently adjudged a bankrupt, will be held before William Mansing, referee in bankruptcy, Steefel building, Albany, N. Y., June 12 at 3.30 P. M., at which time creditors may attend, prove their claims, examine the bankrupt and elect a trustee.

### Death of Joseph Wineburgh.

UTICA, N. Y., June 4.—Joseph Wineburgh, senior member of Joseph Wineburgh & Sons, jewelers at 32 Genesee St., died at 6 o'clock this morning. While Mr. Wineburgh had been in declining health for several years he was up and able to be about yesterday. Death was due to Bright's disease.

Mr. Wineburgh, who was in his 74th year, was a native of Russia. Several years before he had reached his majority he had decided to seek his fortunes in the United States and coming here settled upon Utica as his future home, and for over half a century he had been one of its most honored residents. Mr. Wineburgh was 18 years old when he started his long and successful business career here. After reaching this city he soon branched out in business, traveling all over the northern part of the State selling dry goods and jewelry. He soon acquired a reputation for honesty and fair dealing, which he retained throughout his business career. Mr. Wineburgh formed many acquaintances and 27 years ago when he decided to engage in the retail jewelry business in this city, he started the foundation of a business which had been unusually successful.

The store was first located at 32 Genesee St., and there it has remained. When the late Jacob Wineburgh became of business age, his father admitted him to the firm and the name was changed to Joseph Wineburgh & Son. This was about 15 years ago, and later another son, Hyman Wineburgh, was admitted to the partnership and the firm became Joseph Wineburgh & Sons. A few years ago Mr. Wineburgh's health began to fail and the business was entrusted to Mr. Wineburgh's sons. Jacob Wineburgh, who had been associated with his father for many years, died on Aug. 21, 1905, and since then Hyman Wineburgh and another son, Edward, had been in charge of the firm's business.

Deceased was a business man who believed that success was only acquired through strict application to business and unflinching honesty in dealing with the public. He obtained the confidence of people in Utica and Central New York, and for many years he enjoyed a large and remunerative business. The foundation which Mr. Wineburgh laid was well cared for by his sons. Mr. Wineburgh retired from active participation in the business about seven or eight years ago.

It was largely due to the efforts of Mr. Wineburgh that the House of Jacob was formed in Seneca. He was one of the founders of the society. He also was a member of the Independent Order of Odd Fellows and became a member of Shenandoah Lodge No. 95 on April 21, 1865, and in 1889 the grand lodge of the State presented him with an Odd Fellows' veteran badge.

Mr. Wineburgh is survived by a widow, formerly Rosa Epstein, who lives at the family residence, 153 Blandina St., two sons, Hyman and Edward Wineburgh, and two daughters, Mrs. I. Marks, of Bradford, Pa., and Mrs. A. S. Workman, of Montreal.

R. E. Schubart, Wheeling, W. Va., will sail from New York, on a pleasure trip to Europe, June 22.

**EDUARD VAN DAM**  
**DIAMOND CUTTER**  
 AMSTERDAM NEW YORK ANTWERP

**DIAMONDS**  
 Complete Stock—Right Prices  
 'NOUGH SAID  
**WM. I. ROSENFELD**  
 19 Maiden Lane NEW YORK

**CORAL**  
**CORAL**  
**CORAL**  
**BORRELLI & VITELLI,**  
**CORAL MANUFACTURING COMPANY,**  
 All kinds of Coral—DROPS, BUTTONS, LENTILLES,  
 CORAL NECKLACES, Graduated and Uniform.  
**PINK AND WHITE CORAL A SPECIALTY.**  
 GOLD MEDAL, ST. LOUIS, 1904.  
 GRAND PRIX, LIEGE, 1905.  
 3 Via Amedeo, Torre del Greco, Italy. 32 Rue d'Hauteville, Paris, France.  
 401 Broadway, New York.  
 Telephone, 5412 Franklin.

**CULMAN BALANCE CHUCK**  
 For Refinishing Balance Pivots, without removing the Hair-spring or Roller, and protecting them while the pivots are being polished. ONCE TRIED, ALWAYS USED. FREE ON 10 DAYS' TRIAL.  
 OVER 1000 SOLD THE FIRST YEAR. PRICE, \$3.50.  
**C. CULMAN, 316 N. Sixth Street, ST. LOUIS, MO.**



**Creditors File Involuntary Bankruptcy Petition Against I. G. Dillon & Son Co., Wheeling, W. Va.**

An involuntary petition in bankruptcy was filed last Saturday against the I. G. Dillon & Son Co., retail jewelers at Wheeling, W. Va., in the United States Court at Wheeling. The petition was filed by attorneys representing the Jewelers Board of Trade, New York. Secretary Safford, with power of attorney from a number of the New York creditors, went to Wheeling earlier in the week to complete an investigation which he began some time ago. The circumstances having been detailed in THE CIRCULAR-WEEKLY of May 9.

A receiver has been in possession of the business for some time, having been appointed by the State courts on I. G. Dillon's application. The appointment of the receiver destroyed plans which had been forming with a view to the creditors granting an extension. Mr. Safford and a committee of creditors concluded that the company is insolvent and that the best method of adjusting affairs was by a resort to bankruptcy court.

The company's liabilities amount to \$1,000,000, of which nearly one-third is due to Wheeling banks, but this indebtedness is said to be almost fully secured. The nominal value of the assets, including property given as collateral security, is \$190,000. The greater part of the merchandise indebtedness is owing to New York creditors.

**Creditors of Schickerling Bros. & Co. Hold First Meeting and Elect Trustee in Bankruptcy.**

Creditors of Schickerling Bros. & Co., who were jewelry manufacturers at 28-22d St., New York, held yesterday their first formal meeting, under the terms of the bankruptcy act, in the office of F. Pendleton, 25 Broad St., the referee in charge of the case. The Jewelers Board of Trade was represented by Attorney Mervyn A. Mackenzie, of Hastings-Gleason. The receiver, Robert C. Moore, was represented by Thomas & Oppenheimer, who are associated in the case with A. Karselen.

By a unanimous vote Receiver Moore was chosen trustee. No effort to vote was made on the part of the secured creditors. After some general discussion of the condition of affairs an adjournment was taken to June 19 at 2 p. m.

The petition in bankruptcy against the company was filed three months ago. Liabilities have been given at \$160,000, which a considerable part is secured by assignments of merchandise and open accounts. The officers of the corporation were instrumental in forming Edel Bros. & Co., who had a retail store at Fifth Ave., New York, and who are also in bankruptcy.

During the recent horse show in Wheeling, Man., Can., D. R. Dingwall, of place, attracted a great deal of attention to his show window by displaying the head of a horse's head within a large horse sign and surrounded by a circle, the entire sign being made up of diamonds, rubies, emeralds and topazes, valued at \$87,000.

# Our Traveling Representatives



Shuman, of Shuman Bros., was in San Francisco, Cal., last week, visiting the trade. Among the traveling representatives to visit New York, last week, were: Charles F. G. Champenois & Co.; Fred J. Foster, Unger & T. Laffey, Gorham Mfg. Co.; E. A. Reed, J. & Barton.

Among the traveling men who called upon the trade in Denver, Colo., recently, were: Carl Domick, H. F. Hahn & Co.; R. L. Robertson, Denver Mfg. Co.; L. W. Bruns, Juergens & Anderson Co.; Louis Freund, Henry Freund & Co.

Among the representatives of wholesale houses recently in Detroit, Mich., were: J. T. Griffith, Carter, Howe & Co.; H. W. Valentine, Alvan Co.; C. B. Bartlett, Whiting Mfg. Co.; A. J. Eker, Osmun-Parker Mfg. Co.; L. E. Smith, M. Bryant & Co.

Among the following traveling representatives visited the trade in Lancaster, Pa., recently: T. D. Bailey, S. Gatter, C. G. Cushman, Reed & Barton; C. S. Lake, Whiting Mfg. Co.; J. F. Crane, Mandeville, Carrow & Crane; W. B. Ehlers, Ehlers & Co.; A. C. Fellinger, N. H. White & Co.; M. G. Charles P. Goldsmith & Co.; Julius Reidel, Canada Community, Ltd.; S. K. Jones, Harry Lissner, Jacobson Bros.; George S. Melville, F. B. Myers Silver Co.; H. B. Bliss, Gorham Mfg. Co. Among the traveling salesmen who called on the trade in St. Louis, Mo., last week, were the following: Mr. Crossin, Crossin & Co.; G. W. Becker, Martin, Copeland & Co.; Emil Pick, Daniel, Riglander & Co.; C. E. Sutton, Flint, Lind & Co.; Mr. McLoughlin, E. S. McLaughlin & Co.; E. A. Warner, Adolph Tanzer; E. A. Reed, J. & Barton; Emil Herbeck, Herbeck-Demer Co.; R. B. Carr, Link & Angell; T. S. Sturgis, Hely Bros.; H. H. Meyer, William B. Kerr & Co. Inc.; S. W. Abbey, E. Ira Richards & Co.; B. Levy, Orient Mfg. Co.

Among the traveling men visiting Boston, Mass., during the week, included: Frank Burns, Pairpoint Corporation; Louis Nordlinger, L. & M. Kahn & Co.; Link Waite, G. K. Webster & Co.; John A. Abel, J. B. Co.; Benjamin Griscom, Bippart, Griscom & Osborn; Robert Simpson, Riker Bros.; Mr. Eckinton, R. Blackinton & Co.; Charles Duffy, Jos. Richardson & Co.; J. Cooper Stone, Jones & Woodland; Alex. Chase; Mr. Martin, Martin, Copeland & Co.; Gustav Saacke, Wildpret & Co.; Mr. Steere, Arnold & Steere; Charles Stearns, George H. Fuller & Son Co.; T. G. Frothingham.

Among the traveling representatives calling on jewelers in Chicago, Nehr, last week, included: L. Bruns, Juergens & Anderson Co.; W. A. Crocker, Christies De Baccarat; A. S. Riley, Mandeville, Crow & Crane; Mr. Dick, St. Louis Silver Ware Co.; E. E. Spaulding, Alstopp Bros. and Bassett Jewelry Co.; M. D. Aneker, Langfeld Bros. & Co.; W. S. Willis, Gorham Mfg. Co.; Fred Foster, Unger Bros.; F. E. Whiting, Whiting & Davis; C. H. Anderson, Ross, Saltman & Anderson; Meyer Lehmann, Ludwig Lehmann; Mr. Finberg, Berg Mfg. Co.; K. L. Taylor, Riley & French; M. Bliss, Bliss Bros. Co.; W. F. Drexmit, Key-Stone Watch Case Co.; Harry Mix, Wightman & Co.; Andrew S. Cooper, Parks Bros. & Juergens; Henry Freund, Henry Freund & Co.

Among the following traveling salesmen have been called on the trade in Kansas City, Mo., during the week: A. H. Oakley, Thornton Bros.; F. R. Bell, W. H. Saart Co.; Chas. S. Peckham, J. Peckham & Co.; John W. Case, H. F. Carpen & Son; H. A. Adams, Kraus & Deitsch; H. Meyer, Wm. B. Kerr & Co., Inc.; D. A. Dason, Wallach & Davidson; Mr. Marsh, C. A. Marsh & Co.; A. Oppenheimer, Rudolph Wolff & Co.; F. A. Fairbrother, Armstrong Braiding Co.; C. H. Howard, Mason, Howard & Co.; Edgar H. Potter & Buffinton Co.; Hubert Somborn, Op. Didisheim & Bro.; Fred J. Foster, Unger & T. Laffey; H. R. Blackman, Champenois & Co.; W. Crocker, Paul Durand; C. E. Sutton, Flint,

Blood & Co.; Mr. Remington, Carter, Qvarnstrom & Remington; Mr. Fox, Fox & Co.; Joe Frank, Sussfeld, Lorsch & Co.; Helmer Thompson, F. H. Noble & Co.; J. Gocus, National Jewelry Case Co.; W. R. Stevens, Bay State Optical Co.

Traveling representatives who visited the trade in Cincinnati, O., last week, included: James Baker, Frank M. Whiting & Co.; C. E. Hulstrom, International Silver Co.; Mr. Young, Whiteside & Blank; E. A. Reed, Reed & Barton; Mr. Washbourne, Graff, Washbourne & Dunn; Sig. Stern, Stern Bros. & Co.; Ike Price, Louis Strasburger's Son & Co.; Norbert Gunsburger, L. & M. Kahn & Co.; Max Loebritz, Duerber Watch Case Mfg. Co.; Mr. Sunnauer, Oppenheimer Bros. & Veith; F. C. Allen, Sansbury & Nellis; R. B. Carr, Link & Angell; Mr. Delano, Day, Clark & Co.; John Goodwin, Durand & Co.; Charles Williams, Gorham Mfg. Co.; Helmer Thompson, F. H. Noble & Co.; Mr. Stanley, Hercules Safety Clasp Co.; E. S. Fishback, Hamilton Watch Co.; George Bleecker, Martin, Copeland & Co.; Christopher Morgan, Rogers & Bro.; D. Skutch, New Haven Clock Co.; E. P. Tiffany, F. H. Sadler & Co.; Mr. Crossin, Crossin & Co.; M. E. Thornton, A. Lounsbury & Son.

## Connecticut.

E. A. Bliss and Wm. Rettenmeyer, Meriden, sailed Thursday for a month's trip to Europe.

Jas. Clulee, Wallingford, has assigned to the International Silver Co., Meriden, two patented designs for spoons, forks, etc.

The New Haven Clock Co.'s baseball team on Decoration Day defeated the F. B. Pfeleghar baseball nine by a score of 20 to 3.

The International Silver Co. has planned to erect an addition to its plant in Bridgeport. The structure will be of brick, mill construction. The dimensions will be 48 by 200 feet.

The annual excursion of the Landers, Frary & Clark Mutual Aid Society, New Britain, will be held Saturday, Aug. 4. The trip will be made as usual to Sabin Rock. Special trains will be chartered.

W. F. Tetro, formerly with Lee Roberts, Bristol, and later in the employ of John R. Clayton, Waterbury, has purchased a store in Northampton, Mass., where he will engage in business on his own account.

John W. Davis, formerly with the Holmes & Edwards Silver Co., Bridgeport, was committed to the insane asylum, Middletown, last week by Judge Nobbs upon application of Supt. Brennan of the Charity Department. Davis, it is said, is suffering from religious mania.

A. Frank, optician, Bridgeport, was thrown from his carriage May 30, while out driving with his fiancee, Miss Mabel Harris, and sustained numerous bruises and a compound fracture of his right arm. Miss Harris is also suffering from shock.

A large trophy cup which has been on display for several days in the show window of Perry & Stone, New Britain, has attracted a great deal of attention. The cup was presented to C. A. Whipple, superintendent of McGuire & Penniman, Providence, R. I., by his associates, and was supplied by the above mentioned jewelry firm.

The Bradley & Hubbard Mfg. Co., Meriden, expects to complete the work of equipping its entire plant with electricity by next Fall. The work includes the wiring of the factory for 600 electric lights to be used instead of the Meriden Electric Light Co.'s power and lamps. The latter will be retained for use in an emergency. Many of the local factories are now equipped with their own electric lighting plants.

## News Gleanings.

Mrs. Susan M. Randall has discontinued her store at Brockport, N. Y.

A fire, which took place at Stamford, Tex., recently, did considerable damage to J. M. Lively's jewelry store in that town.

Edward Wilhelm, a veteran jeweler of Phillipsburg, Mont., died recently as a result of heart failure. He was 66 years of age.

Corwin Bros. & Johnson, Park City, Mont., report having suffered a burglar loss of about \$100 worth of watches, silverware, etc.

Milwaukee (Wis.) jewelers, Wednesday evening, organized a local society, which all retail jewelers in the city will be invited to join. The purpose of the organization is to hold monthly meetings, at which the conditions of trade will be discussed. The officers elected are: President, A. J. Stoessel; vice-president, George Durner; secretary, Franklin Thompson; treasurer, Frank P. Wilde. Plans for the convention of the new State organization to be held here on June 27 and 28, were made at the meeting.

Adolph Weis, who was accused of stealing jewelry from Joshua Sutta, 175 Meadow St., New Haven, was sentenced May 27 to 60 days' imprisonment. Weis, it was alleged, obtained several hundred dollars worth of stock from the jeweler under the pretext that he was a salesman. He was subsequently arrested in Cleveland, to which place he had shipped the jewelry, and brought back to New Haven. The defendant's attorney stated that most of the stolen property had been restored to the owner.

J. G. Schumann, Richmond, Va., was visited recently by a negro who wanted to see some watch keys. The jeweler, who suspected the man, watched him closely while he busied himself fixing some keys. Suddenly he saw the negro lean over the show case, slide back the door and pick up a watch with a hook. Though Mr. Schumann jumped quickly the thief was quicker and rushed out the door with the jeweler in pursuit. He was finally captured and locked up as a suspicious person. It was later found he had robbed other men as well, in all being accused of stealing 13 watches in different stores. The man, who gave his name as William Thomas, was sent to jail for six months on one charge and held for the Grand Jury on others.

Two men called at the jewelry store of J. F. Kohler, Richmond, Va., recently and purchased two cheap rings. Later in the day one of the men came back and asked that one ring be exchanged. While looking over the tray the stranger deftly slipped the cheap ring he had purchased in the place of a three-stone diamond ring worth \$400, while the jeweler's attention was attracted in another direction. A short time later the second man returned and worked the same trick, taking a large solitaire diamond ring. A description of both men was given to the police. The trick might have been exposed at once but for the fact that the strangers had asked the jeweler to leave his tags on the rings which they had first purchased, and when they replaced these in the tray it was not apparent that a substitution had been made.

## DOMESTIC versus FOREIGN CUTTING

### IMPORTANT TO MANUFACTURERS

FROM  
MORF  
M  
S  
S  
S

American and Egyptian Peridots and other Precious Stones are being cut by us to Special Shapes and Sizes.

They are much superior to imported goods in cut and accuracy of size.

Manufacturers should bear in mind that there is no waste where every stone is a gem.

We carry every Precious Stone but the Diamond.

TO  
M  
A  
R  
K  
E  
T

AMERICAN GEM AND PEARL CO.

14 & 16 CHURCH ST., NEW YORK

LONDON—16 Holborn Viaduct

PARIS—39 Rue de Chateaudun

## Koshland & Italic Co.

702 Chestnut Street, PHILADELPHIA, PA.

¶ You must be satisfied with everything you buy of us.

¶ If you are not, let us know and you soon will be.

Diamonds, Watches and Jewelry

## Trans-Atlantic Voyagers.

### TO EUROPE.

C. J. Bene, Cincinnati, O., will sail to-morrow.

Andrew Patterson, of R. C. Hahn & Co. sailed to-day on the *Baltic*.

Herman Levy, New York, sailed yesterday on the *Kronprinz Wilhelm*.

B. H. Davis, of B. H. Davis & Co., sailed last Thursday on the *Deutschland*.

H. R. Beguelin, of Cross & Beguelin, New York, sailed Saturday on the *Iturra*.

Arthur Silberfeld, New York, will sail June 12 on the *Kaiser Wilhelm der Gross*.

E. Adler Gardner, with the E. A. Bl. Co., New York, sailed yesterday on the *Prinz Oskar*.

W. A. Schlossman, with H. F. Hahn Co., Chicago, and wife, will sail to-morrow on the *Grosser Kurfurst*.

Wm. Kinscherf, Jr., of the William Kinscherf Co., New York, sailed recently on the *Kaiserin Auguste Victoria*.

Sailing last Wednesday on the *New Amsterdam* were: Julius Kaufman, of G. friend Bros., New York; Max J. Lissauer of Lissauer & Co., and wife, New York.

### FROM EUROPE.

A. Roseman and son returned recently on the *Finland*.

John Silberfeld, Antwerp, arrived last week on the *Lucania*.

M. F. Harris, of Harris & Harrington returned May 30 on the *Carmania*.

Leopold H. Herzfelder, with Dav Mayer, New York, returned yesterday on the *Kroonland*.

Returning last week on the *Kronprinz Wilhelm* were: Maurice Brower, D. de S. Mendes, of the Mendes Cutting Factory.

### Utica.

William A. O'Donnell has acquired interest in the C. J. Wells Co., retail jewelers at Liberty and Genesee Sts. Since the death of Calvin J. Wells the business has been conducted by Mrs. Wells, with the assistance of Mr. O'Donnell, who has been identified with the firm for several years.

Theodore O. Loveland and James Records, trading as the Moline, Ill., Jewelry Co., sued Walter Drejza before Judge Pritchard to recover \$150 for goods alleged to have been delivered to Drejza as agent. Drejza claimed that he had repaid the money due the company, minus a commission of 33⅓ per cent. A jury gave the plaintiffs a verdict for \$6.75 and a motion for a new trial was denied.

About \$9,000 was realized from the recent sale at the American Art Gallery, New York, of the works of Paul Noe, the Belgian sculptor, who lost his life in a balloon ascension, and the money will be forwarded to his mother and sister. The executor retained the plaster originals of all the sculptured figures in order that a limited number of castings could be made by the Gorham Mfg. Co. Orders for the castings will be taken, so that the finding to the sculptor's relatives will be increased. The Belgian government has asked for some of the castings and is expected that several will be placed in the Metropolitan and Brooklyn Museums.

**Attleboro.**

Frank Emmons Guild, son of Emmons Guild, of the W. H. Wilmarth Co., and himself a manufacturing jeweler in Providence, R. I., will take a bride the evening of June 14, in the person of Miss Ethel Rose Wolfenden, of this town.

J. W. Luther & Co., through Treasurer Louis C. Luther, last week filed with the Secretary of the Commonwealth the following annual corporation report: Machinery, \$3,000; cash and debts receivable, \$15,250; manufactures and merchandise, \$10,750; capital stock, \$35,000; accounts payable, \$2,000.

A. S. Ingraham & Co., through Treasurer Robert S. Ingraham, last week filed with the Secretary of the Commonwealth the following annual corporation statement: Machinery, \$3,000; cash and debts receivable, \$13,089; merchandise, \$1,700; good will, \$6,000; capital stock, \$20,000; accounts payable, \$2,155; profit and loss, \$634.

The Poole Silver Co., Taunton, last week, through Treasurer Edward F. Roach, filed the following annual corporation report: Real estate, \$21,000; machinery, \$16,000; cash and debts receivable, \$13,912; manufactures and merchandise, \$12,012; capital stock, \$10,000; accounts payable, \$1,106; surplus, \$16,000; profit and loss, \$7,538.

The public library trustees of this town, in which the late Louis J. Lamb, of C. H. Allen & Co., was a member for years, have embodied their regrets at his recent death in a set of resolutions, adopted last week. They are particularly eloquent, showing a true appreciation of his high ideals, keen insight, wise judgment and kindly sympathies. His widow, Mrs. Elizabeth B. Lamb, has been appointed guardian of his youngest son, a minor. The management of his firm, C. H. Allen & Co., continues for the present without change, except his absence. Mr. Lamb was in general charge at the factory, assisted by his brother and partner, William H. Lamb, while the third partner, C. H. Allen, was chief traveling salesman.

Edward Scott Shannon, a New York business man, was married last week to Miss Edith Morton Smith, only daughter of William H. Smith, of Smith & Crosby, one of the foremost manufacturing jewelers of an older generation in this town. They will reside in New York City. The wedding was attended by an unpleasant incident, a Boston newspaper the next day printing a sensational story about an elopement, which brought the family much undesired prominence. The story has been publicly stigmatized as without foundation.

Ernest D. Gilmore, of E. D. Gilmore & Co.; Herman T. Regnell, of Regnell, Biggley & Co.; A. Vinton Cobb, of A. V. Cobb & Co.; Charles A. Marsh, of A. Marsh & Co.; Ernest M. Bliss, of the Bliss Bros. Co.; Mark E. Rowe, William E. Coles, and Edgar A. Remington, of Carter, Qvarnstrom & Remington, are manufacturing jewelers elected to office in the Young Men's Christian Association last week. The main support of this body is that of the jewelry manufacturers, who like to keep a conveniently located and wholesome recreation place for the young men in their employ.

**North Attleboro.**

Theron I. Smith and party arrived home Monday from a three months' European trip.

The Bugbee & Niles Co. was obliged this week to operate its factory 13 hours a day.

Alfred Sweet, western salesman for J. F. Sturdy's Sons, returned last Wednesday from an extended trip.

Walter C. Sherman is home from a four weeks' trip through the west in the interests of the Estate of O. M. Draper.

Accidents to boilers caused the factories of the H. F. Barrows Co. and Payne & Baker Mfg. Co. to be closed for a half day on Thursday.

Mrs. J. H. Peckham underwent a serious surgical operation in Providence last week and is reported to be making satisfactory progress.

The engagement is announced of Miss Lillian Bagnall, daughter of Joseph Bagnall, of the Doran, Bagnall Co., to Frank Lester Holbrook, with G. K. Webster & Co.

The Webster Co. has filed its annual statement. The figures are: Real estate, \$37,807; machinery, \$61,126; cash and debts receivable, \$185,021; merchandise, \$181,899; total, \$469,153. Capital stock, \$175,000; accounts payable, \$120,854; surplus, \$15,000; profit and loss, \$158,299; total, \$469,153.

Christopher Dobra, treasurer of the B. S. Freeman Co., has filed the following financial report for his concern: Machinery, \$16,638; cash and debts receivable, \$36,061; merchandise, \$15,000; patent rights, \$2,000; total, \$69,699. Capital stock, \$25,000; floating indebtedness, \$39,303; profit and loss, \$5,396; total, \$69,699.

E. I. Franklin & Co. and 34 other manufacturing jewelry concerns have signed a petition that will ask the board of Selectmen to clothe the Rhode Island Co. with power to act as a common carrier. The jewelers are anxious to see the 'railway company vested with this power so that it may carry its packages and express from and to Providence. A hearing has been set for June 14.

The filing of a petition by the Rhode Island Company asking the selectmen to allow an extension of their rails on Elm St. is taken as confirmation of the report that this Summer a four-story brick jewelry factory is to be erected by Boston capitalists. The extension of the rails it is said is desired because it will make it possible to build the factory much cheaper than otherwise through the big saving in expenses of carting.

James Mitchell has purchased the business of Harry Engels, Red Cloud, Nebr.

L. E. Walker, who recently purchased a stock of jewelry, etc., in Benkelman, Nebr., has now purchased the store building of C. R. Walker & Co.

In the District Court at Paterson, Judge Lewis, on Tuesday of last week, awarded a judgment for \$61 against M. Roemer, of 603 Main St., for the purchase price of a quantity of jewelry bought from the Lyon Taylor Co., of Iowa. The defense claimed that the jewelry was not of the character represented.

**New Stores and Enterprises.**

W. F. Tetro is a new jeweler in Northampton, Mass.

Gaston Wilson has just commenced business in St. John, Wash.

E. J. Bonner recently started in business as an optician in Chillumthe, Ill.

George Osborne is about to engage in the jewelry business in Laharpe, Kans.

R. J. Rulford, formerly of Beaver City, Nebr., has opened a store at Alma, Kans.

H. E. Lee, optician, recently opened an office in room 15, Waverly building, Hartford, Conn.

W. O. Hayward, a graduate of the St. Louis Watchmaking School, has opened a new jewelry store at Atwood, Kans.

M. L. R. Howald, formerly in the employ of A. H. Coleman, Massillon, O., has just started in business for himself at Salem, O.

The Royal Jewelry Co., of New York, with a capital of \$2,500, has been incorporated by Herbert Gray, Lucy S. Gray and C. R. Spies, of New York.

Hurwitz Bros. & Bloom is the name of a new wholesale jewelry house which has started in business in Rochester, N. Y. The firm now occupies offices in the new Central building on Main St., E.

George Fruh, a watchmaker, who was formerly located with Joseph Hornback, Cincinnati, O., for many years, has bought out the L. C. Klotter business at Brighton, Cincinnati, O., and will carry on a retail jewelry and repair business.

The C. F. Scheckleton Co. has been incorporated in Massachusetts to deal in many articles, among which jewelry is included. The capital is \$1,000, and the president is T. A. Kelleher, Winchester, Mass., and the treasurer, Charles T. Scheckleton, Boston.

The Flagg Cutlery Co., Monmouth and 12th Sts., Jersey City, N. J., was incorporated last week for the purpose of manufacturing gold and silverware, also glass ware, in addition to cutlery. The authorized capital is \$100,000. Incorporators: James H. Flagg, Brooklyn, N. Y.; John L. de Saullles, New York; George M. Clarke, New York.

J. F. Dailey, of J. F. Dailey & Co., St. Louis, Mo., has been in Chicago arranging for the opening of their time-payment house there, of which he will have personal charge. The new store, which was opened on Monday, is located at 68 E. Washington St. Ralph W. Wilson, who has been with the Dailey firm since it started in business, will be the manager of the St. Louis house.

A. G. Lietsch, of Mt. Union, Ia., and his cousin, Harry Slingluff, of Burlington, Ia., have bought the business of H. L. Tucker, New London, Ia., and will take possession about June 10.

John J. Kingsley, Inc., is the name of the concern which recently received a Massachusetts charter to manufacture and deal in watches, with a capital of \$25,000. Albert E. Knowlton, Boston, is the treasurer of the company.

Thomas E. Gonterman, Granite City, Ill., expects to have his new store at 19th and D Sts. ready for occupancy by Sept. 1. The building will be two stories high and will cost \$14,000. Mr. Gonterman was in St. Louis last week.

WATCHESDIAMONDS**AT WHOLESALE ONLY**

**W**E DO NOT *RETAIL*, which means that we protect the *Retail Trade* by *Positively Refusing* to sell any goods other than at *Wholesale*. Any *Jobber* who *Retails* becomes a competitor of the *Retailer*.

*Are you buying your Watches, Diamonds, Jewelry, Cut Glass and Silverware from a competitor of yourself? We are not your competitor and we solicit your trade.*

**D. C. PERCIVAL & CO., Inc.,**  
373 WASHINGTON ST., BOSTON, MASS.

IMPORTERS OF DIAMONDS.

Manufacturers and Jobbers *only* of *Watches, Jewelry, Silverware, Cut Glass* and a complete *material* department.

JEWELRYCUT GLASSSILVERWARE

**FANS** FOR GRADUATION, WEDDINGS,  
CONFIRMATION.

HEADQUARTERS FOR THE MOST EXCLUSIVE LINE IN THIS COUNTRY.

Similar goods  
are not  
obtainable  
elsewhere.

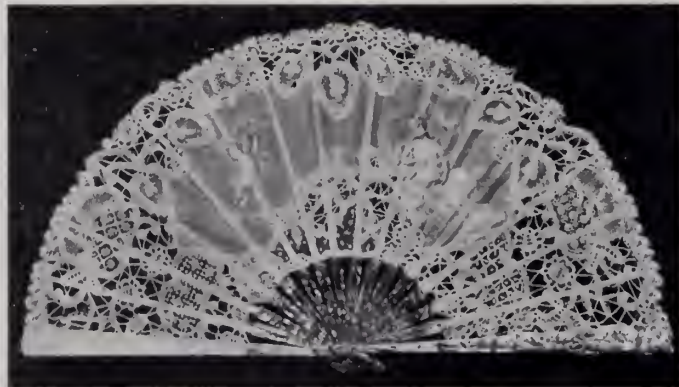

They are of  
original design  
and my own  
creation.

**NECKLACES**

IMITATION PEARL AND FANCY  
BEAD, IN ALL NEWEST SHADES  
AND EXQUISITE COLORINGS.

*Samples of Fans and Necklaces sent on request.*

**LOUIS STEINER, Importer,**

520 and 522 BROADWAY, NEW YORK.

## Boston.

Arthur H. Pray, of the Tremont building, has been on a trip to Rangeley lakes. Charles A. Damon, with Daniel Pratt's son, is home again from an outing at oleb, Me.

Carl D. Smith, of the Smith-Patterson Co., returned last week from a brief outing up to New Hampshire.

Joseph Cowan arrived home on Monday on an extended business trip through the Rio valley and Lake region.

H. M. Thompson is a new salesman in New England territory for the E. H. Saxton Co., of the Washington building.

Irving Smith, of the Crescent Watch Case Co., was in Boston last week, at the New England office of the company in the Jewellers' building.

R. Kelse McKeen, salesman for the Thomas Long Co., has returned from a 900-mile pleasure trip to Canada, his journey extending to Edmonton, Alberta.

The J. J. Round Co. has been incorporated to do a jewelry business, with a capital of \$25,000. Alfred A. Phillips, John J. Round and John G. Ellis are the directors.

E. A. Cowan sailed for Europe Thursday, accompanied by Mrs. Cowan, and will be gone about two months, visiting the trade centers of the Continent and England.

H. N. Lockwood, repairer of watches, clocks and jewelry, has removed from 9 Bromfield St. to 61 Bromfield St., near Tremont St., where he is more comfortably situated.

Fred H. Woodman, 352 Washington St., has taken the New England agency for the Buffalo Mfg. Co. He has also engaged Skelding as traveling man in New England territory.

E. C. Fitch, Jr., of the Montreal office of the Waltham Watch Co., and R. A. Kette, of the Chicago office of the company, have been in Boston at the company's headquarters during the past week.

C. C. Bogle, of Bogle Bros., White River Junction, Vt., who was in the jobbing trade in Boston on Summer St., about a decade ago, has been here during the past week, renewing old acquaintance in the jewelry district.

W. F. Macomber, who travels in the north and southwest for E. A. Cowan & Co., has been home for a short time from his Spring trip, and is now taking an outing in northern New England, accompanied by Mrs. Macomber.

Col. S. O. Bigney was a visitor to several of the jobbing houses in the trade last week, which has not been wont to receive calls from him since he became a member of the Governor's Council, as frequently in former years.

L. W. Adams, of Adams & Singleton, has joined the automobile enthusiasts, and is planning a long vacation tour in his new car. C. H. Singleton, of the same firm, has opened his Summer home at Winthrop for the shore season.

William A. Darling, formerly in business at Quincy, Mass., has accepted a position with Charles W. Johonnot, who succeeded the late C. W. Beals. Mr. Darling was associated with Mr. Beals, it is interesting to note in this connection, when he

first learned the business, nearly 25 years ago.

J. George Martin, who left the clock trade some months ago for a position in the Stock Exchange clearing house, has returned to his earlier occupation, and is now connected with the Boston office of the Wm. L. Gilbert Clock Co.

In a prize contest inaugurated by the Boston *Herald* upon its removal to new quarters, the name of C. E. Durgin, with the Thomas Long Co., is entered, and he has the distinction of leading in popularity this week by 100,000 votes.

The W. E. Woodman Co.'s establishment, where an auction sale has been held daily since the concern's failure, several months ago, is shortly to change its method of doing business, it is understood, giving up the auction feature, and returning to ordinary selling.

Lawrence F. Percival, of D. C. Percival & Co., whose wedding was announced a few weeks ago, returned last week from a wedding trip to Europe with his bride. D. C. Percival, Sr., who is an enthusiastic devotee of the fisherman's rod, has been enjoying a brief sojourn at Rangeley lakes.

Henry Arnold, of D. C. Percival & Co., is now in New Hampshire, recuperating from the effects of the surgical operation to which he submitted a few months ago, and it is expected that he will be able to return to business in August, if no further setbacks are encountered by him in the meantime.

On Monday of this week a loan exhibition of early American silver, which promises to be of much interest, opened at the Boston Museum of Fine Arts. There are nearly 350 pieces in the collection, including more than 50 by Paul Revere. In the exhibit also there are specimens from the church plate of Boston and vicinity, and several private owners among old Boston families have permitted heirlooms of fine workmanship to be shown anonymously.

## Lancaster, Pa.

Walter Kahn has moved to Nashville, Tenn., where he will open a repair establishment.

Frederick Matthias, formerly of Mahanoy City, Pa., has located in business at Millersville.

F. A. Peters and W. F. Meiskey, of the H. S. Meiskey Co., visited the Gettysburg battlefield last week.

T. Wilson Dubbs, jeweler, accompanied by W. Scott Leinbach, spent a couple of days fishing on the Chesapeake Bay, last week.

Among the jewelers visiting here last week were John Eimerbrink, York; H. F. Andrews, Strasburg, and Henry Fochl, Columbia.

Roy Portner and William McAvoy, aged 12 and 10 years, respectively, who some time ago robbed Harry Sobel's jewelry store, were convicted in the Juvenile Court and sent to the House of Refuge.

G. William Reisner exhibited last week in a N. Queen St. show window two sets of handsome medals made at his factory, for the winners of athletic meets, one being for the public schools of Springfield, O., the other for the Hill School,

Pottstown, Pa., and the Penn Charter School of Philadelphia.

By an error it was reported last week that James A. Currie, formerly with S. Kurtz Zook, intended to locate in Sheridan or New Castle. This Mr. Currie denies as being without any foundation in fact.

Francis J. Kemper, a Denver, Col., jeweler, spent last week with Lancaster relatives, en route to New York. Wilton G. Potter, a London, England, jewelry manufacturer, who is visiting Philadelphia relatives, spent a couple of days in Lancaster last week.

Frank Gerkin, with G. W. Loar & Co., Grafton, W. Va., has just finished a course in engraving at the Ezra F. Bowman Technical School and returned home. Paul Wentz, with F. W. Kochler, Sharon, Pa., has entered this school for a course in watchmaking.

The newly elected Board of Directors of the Non-Retailing Co., organized on May 29 by electing the following officers: President, A. F. Hostetter; Vice-President, John W. Eshleman; Secretary, Milo B. Herr. On Saturday Alfred B. Moyer, manager of the company, and Director Milo B. Herr, with their wives, left for a month's western trip, which will include Chicago, Denver, the Yellowstone Park, Duluth and the Great Lakes.

## Omaha.

S. W. Lindsay has erected a new electric sign in front of his store.

John Larson, of T. L. Combs & Co., has gone on an extended trip to Sweden.

R. J. Rulfford, Beaver City, Nebr., has opened a jewelry store in Alma, Kans.

George W. Ryan, of Mawhinney & Ryan Co., was in Fairbury, Nebr., on business last week.

Hilmar G. Anderson, Fremont, Nebr., was in the city last week buying stock and returned home with a brand new "Rambler" automobile.

J. A. Reuling, Wymore, Nebr.; Mr. Ross, Bancroft; S. H. Avery, Auburn; J. W. Mefford, Ainsworth; P. W. Napier, Decatur; L. S. Robinson, Glenwood, Ia., and W. A. Queenby, Lead, S. Dak., were in the city last week.

## Canada Notes.

E. Raymer, Edmonton, Alba., has sold out to Jackson Bros.

W. H. Atkinson succeeds J. E. Atkinson in the jewelry business, Deloraine, Man.

James D. Fowler, Fredericton, N. B., is dead.

The jewelers of Hamilton, Ont., have agreed to close their stores on Wednesday afternoons during the summer months.

E. Taylor, for many years with the Hudson Bay Co., Winnipeg, Man., has been appointed managing director of Gowans, Kent & Co., manufacturers of china and cut glass.

On account of the increase in the price of silver the Hemsley Mfg. Co., Montreal; Roden Bros., and the Toronto Jewelry Mfg. Co., Toronto, Ont., have advanced the price of souvenir goods 10 per cent.

# GORHAM SILVER

## JUNE WEDDING GIFTS.

- ¶ June has always been the month of Roses, but it is nowadays the month of Weddings also.
- ¶ The display of wedding gifts at a fashionable wedding is hardly held to be complete unless a chest of spoons and forks or some other articles of Gorham silver are included.
- ¶ The sagacious Jeweler, therefore, will at this season take particular pains to add to his stock such lines of flatware and other ware as will be likely to secure the attention of the buyers of Wedding presents.
- ¶ In anticipation of these June Wedding demands, the Gorham Mfg. Co. have prepared a number of unusually attractive special pieces.

## GORHAM M'F'G CO.



CHICAGO,  
137 Wabash Ave.

Silversmiths and Goldsmiths

Fifth Avenue and 36th Street, New York.

BRANCHES:

NEW YORK,  
23 Maiden Lane.

SAN FRANCISCO,  
120 Sutter St.

LONDON,  
Ely Place.



WORKS: Providence and New York.



**THE JEWELERS' CIRCULAR**  
 THE HOROLOGICAL REVIEW.  
**THE JEWELERS' WEEKLY**  
 THE JEWELERS' REVIEW

PUBLISHED EVERY WEDNESDAY BY  
**THE JEWELERS' CIRCULAR PUB'G CO.,**  
 11 JOHN ST. COR. BROADWAY, NEW YORK.  
 TELEPHONE: CABLE ADDRESS:  
 48 CORTLANDT. JEWELAR NEW YORK

OL. LII JUNE 6, 1906. No. 18.

Subscription in U. S., Canada and Mexico, \$2.00  
 Other Countries in Postal Union, . . . \$5.00  
 Single Copies, . . . . .10

Can be paid by check or money order. Remittances in  
 money are at sender's risk.

Notices of changes in standing advertisements  
 must be received one week in advance; new mat-  
 ter can be received up to Monday.

No attention paid to communications unless ac-  
 companied by full name and address of the writer.  
 This is asked not necessarily for publication, but  
 as evidence of good faith.

**Index to Special Articles.**

	Page.
Ver Cup Presented by British Sailors to Men of American Navy. Illustrated on front cover; text on page.....	34
High Diamonds With Lines of Cleavage Marked, Not Being Imported.....	33
He Does \$15,000 Damage to S. Davis & Co. Jewelry, Clocks, Watches, etc., Exported from New York.....	33
Deer of the Late James D. Lincoln.....	33
Bill to Establish Court of Customs Appeals..	33
Exports of Watches, Jewelry, Gems, etc., Into Canada.....	35
Death of Walter W. Chase.....	35
Jewelry Stolen from St. Louis Firm.....	35
Death of Reuben Harris.....	35
First Prosecution Under New York Gold Law.	37
Chicago Jobbers Organize to Prevent Abuses. Exports at New York.....	37
Canadian Firm Accused of Illegally Stamping Word "Sheffield" on Their Product.....	39
Swindler Operates in Atlanta, Ga.....	39
Window Smasher Arrested in Cincin- nati, O.....	39
Woman Who Swallowed Stolen Diamond Refuses to Submit to Operation.....	39
Bank Allsopp Killed in an Automobile Acci- dent.....	41
Death of David D. Coddling.....	41
Death of James R. Connell.....	41
Jewelry and Ornaments Not Dutiable as Jew- elry.....	41
Shakes in San Francisco Directly After the Earthquake and Fire.....	42, 43
Shakes in San Francisco's Houses Re-establishing Them- selves in the Stricken City.....	45
Shakes in Diamond Markets.....	45
Recent Customs Decisions on Jewelry and Precious Stones.....	47
Death of Fred R. Ingalls.....	47
Another Attempt to Swindle With Forged Orders.....	49
Bankruptcy Petition Filed Against Edelhoff Bros. & Co.....	49
Death of Joseph Wineburgh.....	49
Bankruptcy Petition Against I. G. Dillon & Son Co.....	50
Whickerling Bros. & Co.'s Creditors Meet....	50
Death of John C. MacClymont.....	58
European Pawnshops.....	63
Patent Department.....	83
Opticians Hold Annual Convention.....	84
"Get the Habit".....	86
Anatomy of the Nervous System.....	87
The Big Clocks That Give Time to New Yorkers in Manhattan, Brooklyn and the Bronx—Church Clocks of Manhattan.....	89
Watch Repairing.....	93
Systematizing Stenographic Work.....	98
Suggestions of Noodle Philosophy.....	99
Model Retail Jewelry Establishment of Germany.....	99
Good Rules to Follow.....	99
How to Improve the Snap of a Watch Case.....	101
The History of Majolica.....	103
Reappraisements of China, etc.....	103
Residence in China.....	103
A Suit of Importance to Importers.....	105
Main Styles, Past and Present.....	105
Coloring of Gems by Radium Rays.....	105

**THE CASE** of a woman who swallowed a diamond stolen from an Omaha, Nebr., jeweler, and refused to be operated upon in order that the gem be recovered, has attracted wide attention throughout the country, and brings up a novel point as far as the right to recover stolen property is concerned. There is a general principle of law that a man is entitled to recover his own property, by proper legal procedure, no matter where it may be, and that no act of a thief can give title either to himself or to any one else. In attempting to apply this principle, however, the jeweler and the authorities in Omaha seem to have found themselves in the same dilemma as was the Shylock of Shakespeare, who, though entitled to his pound of flesh, had only the right to remove it without taking blood. It is contended that if the woman who swallowed the diamond was operated upon without her consent the jeweler, while having the right to recover the stone, would be responsible for man-slaughter in case the operation proved fatal. This is by no means the first instance in which a thief has swallowed stolen jewelry and gems, but it is the first case of the kind that has presented the novel point as to the right to recover the gem by an enforced operation. While the woman will probably be prosecuted for larceny the outcome of the case as to the recovery of the gem will be awaited with interest.

**Gem Importations** AS foretold in the last issue of THE CIRCULAR - WEEKLY

the precious stone importations into the Port of New York for the month of May broke all previous records, amounting in value to \$4,021,405.06 as against \$3,233,825.31 in May last year, which until that time held the record. Of the importations of last month the value of the cut precious stones and pearls amounted to \$2,673,542.96, which was about \$400,000 above the record figures of last year, and the value of the uncut stones, principally diamonds, was \$1,347,862.10, which beat by more than \$100,000 the record for these gems in May which was made in 1901. It will clearly be seen from this that there is now no doubt that the figures for the fiscal year, which ends this month, will surpass all records of the Custom House, indicating that the consumption of precious stones in this country shows a continuous increase despite the fact that importers are not able to obtain all they want in certain sizes and qualities. How the figures of last month compare with those of May in previous years will be found by an inspection of the following table.

May.	Uncut.	Cut.	Total.
1906....	\$1,347,862.10	\$2,673,542.96	\$4,021,405.06
1905....	972,918.95	2,260,906.36	3,233,825.31
1904....	1,051,594.42	1,328,241.59	2,379,836.01
1903....	567,086.18	1,855,497.78	2,422,583.96
1902....	889,229.02	1,386,647.04	2,275,946.06
1901....	1,235,877.78	1,944,395.37	3,180,273.15
1900....	513,597.85	804,761.16	1,318,359.01
1899....	432,851.45	1,200,711.59	1,723,563.04
1898....	134,909.40	202,759.85	337,669.25

In relation to the imports of precious stones and pearls in the current fiscal year, Gen. Geo. W. Mindil, the precious stone examiner at the Port of New York, said several days ago that the preponderance of

diamonds is about as great as in any preceding year, with pearls continuing second in financial importance. He said that in the last year there has been a notable increase in the imports of button pearls, which he attributes to the scarcity and the consequently higher price of round Oriental pearls. Rubies and emeralds, he said, have come in considerable value, and some cheaper stones, such as amethysts and garnets have been imported in considerable number and in weight, probably exceeding that of some higher priced gems. The importation of peridots has been rather heavy; also of opals. Gen. Mindil says that there has been an advance in price of nearly all gems. He states that diamonds of all grades have been constantly going up in cost, just as the importers have repeatedly predicted in the past year.

**Good Outlook for** OWING to the absence from Washington of Representative Vreeland,

who introduced the Jewelry Trades' Gold and Silver Stamping Law, which has been passed by both branches of Congress, the bill which had been returned to the House because the Senate had made two slight amendments, was not acted on last week. The chances are now that a Conference Committee will be appointed this week, the bill reported to both Houses, passed and sent to the President within a very short time.

The only difference between the bill as it passed the House and as it passed the Senate is the change in the penalty made by the latter body, reducing the fine of \$1,000 and six months' imprisonment to a fine of \$500 and three months' imprisonment, and also an extension of time in which the bill shall go into effect from six months to one year after its passage. As far as the reduction in penalty is concerned, THE CIRCULAR - WEEKLY has heard no objections whatever to the Senate amendment, either from members of the trade or from members of Congress. The extension of time in which the bill is to go into effect, from six months to a year, was done at the request of Providence manufacturers, who wished to protect themselves on the goods for the Christmas trade, some of which were already in process of manufacture.

It is now likely that if the bill can be passed immediately, Senator Aldrich, who introduced this amendment at the request of the Providence manufacturers, may consent to a compromise such as having the bill go into effect Jan. 1, 1907, which would be satisfactory to all parties interested in the measure.

**Jewelers Gold Bars Withdrawn and Exchanged at New York.**

Week Ended June 2, 1906.

The U. S. Assay Office reports:

Gold bars exchanged for gold coin....	\$341,379.68
Gold bars paid depositors.....	58,248.89
Total .....	\$399,628.57

Of this the gold bars exchanged for gold coin are reported as follows:

May 28.....	\$112,752.35
" 29.....	76,273.92
" 30.....	75,995.82
June 1.....	40,484.81
" 2.....	35,872.78
Total .....	\$341,379.68

# JUNE WEDDINGS



*SOMETIMES,  
all of a sudden, you  
find you have to meet an  
extraordinary demand  
—a wedding or something of  
that sort—for*

*Diamond Jewelry and Diamonds.  
That's the time to write us!*

*Give us an idea of range of prices, and you'll get the  
richest assortment to be had in New York City.*

## CROSS & BEGUELIN

*Importers and Cutters of Diamonds and Precious Stones*

43 Rue de Meslay, PARIS Telephone, 2188 Cortlandt 17 Maiden Lane, NEW YORK

## ARCH CROWN MOUNTINGS IMPROVE DIAMONDS

*Why not set  
your diamonds  
in the mounting  
that displays  
them best?*

*Send for samples.*

**Arch Crown Mfg. Co** 26 Camp Street  
Newark, N. J.

## Last Week's New York Arrivals

**THE CIRCULAR-WEEKLY** each day posts its office a bulletin of the latest buyers visiting New York, which every member of the trade cordially invited to copy.

- ALBANY, N. Y., A. Weidman, Grand Union.  
AUBURN, N. Y., W. C. Crosman, Astor House.  
BALTIMORE, MD., J. M. Oppenheimer (M. Oppenheimer & Son), Herald Sq.  
BOSTON, MASS., G. A. Reidpath (R. H. Wall & Co.), Imperial.  
BUFFALO, N. Y., S. A. Mester (the Swanwick Co.), Grand.  
BURLINGTON, VT., F. D. Abernethy (H. Allen & Co.), Imperial.  
CHICAGO, K. Landau (K. & S. Landau), Broadway Central.  
S. Rothschild (Rothschild & Co.), Cadogan.  
ELGIN, ILL., Mrs. L. H. Bauer, Victoria.  
ELMIRA, N. Y., O. Freudenheim (Freudenheim & Lande), Albert.  
LOUISVILLE, KY., D. J. Gleason (J. M. Ransom, Norton & Co.), Savoy.  
C. W. Sherwood (J. Bacon & Sons), Church St.  
MINNEAPOLIS, MINN., C. Olson (C. Olson Co.), Breslin.  
NORWALK, O., P. C. Curtiss (C. F. Jackson Co.), Astor House.  
PHILADELPHIA, PA., F. Dilshemer (F. Dilshemer & Co.), Astor House.  
R. Quinn (John Wanamaker), Woodstock.  
PLATTSBURG, N. Y., G. F. Tuttle (F. Paes Co.), Breslin.  
RICHMOND, VA., L. Cohen (Cohen Co.), Grand.  
ST. LOUIS, MO., F. W. Drosten (F. W. Drosten Jewelry Co.), Waldorf Astoria.  
SCRANTON, PA., J. Levy (N. B. Levy & Bro.), Broadway Central.  
SPRINGFIELD, MASS., G. D. Sleigh (F. R. Wallace), Herald Sq.  
UTICA, N. Y., F. Morath (J. B. Wells & Sons Co.), Albert.  
WASHINGTON, D. C., F. F. Finin (S. Kauffmann & Sons Co.), York.  
A. Rosenthal (M. Goldenberg), Grand.  
WILKES BARRE, PA., J. Leibson, Broadway Central.

### Death of John C. MacClymont.

John C. MacClymont, who was well known in the jewelry trade, died last Saturday at his home in Plainfield, N. J., in the 69th year. Mr. MacClymont began his business career with Ramee & Greason, remaining with them for three years, from 1866 to 1868. Then John R. Greason sold out his interest and Mr. MacClymont came a member of the firm, the style changing to Ramee, Schaffer & MacClymont. In more recent years he has been associated successively with Krentz & Co. and H. A. Kirby Co.

Funeral services were conducted last evening at his late home, 78 Washington Ave., North Plainfield. Interment will be at Woodlawn, N. Y.

In the recent suit of the Elgin Jewelry Co. against Anthony Bolinsky, of Mount Airy, Pa., the verdict was given in favor of the defendant. The suit was brought to recover the sum of \$200 with interest for a certain amount of jewelry which had been forwarded to the defendant under an alleged contract under the date of Feb. 29, 1906. The goods were duly delivered, but the defendant claimed that the conditions of sale as set forth in the alleged contract were different from what had been represented to him by the agent for the contract. He therefore sent the goods back.

## New York Notes.

Alexander Backer, 2313 Eighth Ave., is out of business.

Jarris Henkin moved recently from 165 Avenue C to 199 Flatbush Ave., Brooklyn. Announcement is made by Paul Greenberg, 272 Delancey St., that he will soon retire.

Frank, 76 Bowery, will occupy the space in the new building now being erected at 11 Bowery.

Julius Kaufman, of Goodfriend Bros., sailed for Europe last Wednesday on the *Ve Amsterdam*.

Against the Marvin Watch Co. a judgment for \$103 in favor of the city of New York was filed Friday.

H. Davis, of B. H. Davis & Co., sailed Thursday on the *Deutschland*, to visitwerp, Amsterdam, Paris and London.

Judgment for \$139 was filed last Thursday against the United States Electric Clock Co., and in favor of the City of New York.

The C. O. Sweet & Son Co., Attleboro, Mass., have opened a New York office at 10 Maiden Lane, in charge of George T. Johnson.

Lease for a long term of the store at 22 Fifth Ave. has been taken by the Enter-Hoecker Co., opticians at 1145 Broadway.

A pearl and diamond given by Empress Eugenie to Edward A. Crane, is left by his will, which was filed for probate last Thursday, to one of the members of his family. Sympathy of many friends is extended to Max Traub, eastern representative of Lissauer & Co., whose mother died last Thursday. The funeral services were held Sunday last.

Miss Lenore Stern, the daughter of Sigmond Stern, of Stern Bros. & Co., was united in marriage to Arthur Lederer, of Cleveland, at 6 o'clock Monday evening in Immonico's.

At the annual meeting of the directors of the Charles E. Hancock Co., held in Providence, R. I., last week, L. H. Carpenter, New York representative, was elected vice-president of the corporation.

Maurice Bender was held for examination last week in the Essex Market Police Court on the charge of obtaining \$160 from Rebecca Hoecker, 35 W. 117th St., by selling her an imitation diamond.

John Silberfeld, Antwerp, a brother-in-law of Leon Weiner, of Weiner, Garson & Nye, of 277 Grand St., arrived here last week on the *Lucania*, bringing with him an assortment of diamonds and emeralds.

Adler Gardner, western representative of the E. A. Bliss Co., 321 Fifth Ave., started yesterday on the *Prinz Oskar*, for a six months' trip to Italy, Switzerland, Germany, Holland, Belgium, France and England.

Sentence of not less than three years in prison was imposed last Thursday by Recorder Goff on Charles P. Moody, convicted of bigamy; also of grand larceny in obtaining jewelry from Chas. S. Crossman & Co.

A certificate was filed last Thursday incorporating a retail jewelry house under the name of H. Sacks, New York. The authorized capital is \$4,000; directors, Paul Sacks,

57 Second Ave.; Rosie Sacks, 1939 Third Ave.; Abraham Sacks, 272 Bleecker St., New York.

Sunday next will be the date of the 40th annual picnic to be given by the New York Watchmakers' Society at Oak Hill Park, Elmhurst, L. I. There will be amusements of various kinds and dinner will be served at 1 o'clock.

Charged with stealing from the jewelry department of a Sixth Ave. store, Thomas Peleso and his wife, of 250 E. 117th St., were last Thursday held by Magistrate Breen, in the Jefferson Market Court, in \$300 bail for examination.

At the store of M. Teela & Co., recently opened at 929 Broadway as a branch of the concern at 47 Boulevard Kausssman, Paris, the stock comprises artificial pearls, rubies, sapphires and emeralds. The New York branch was recently incorporated.

Max J. Lissauer, of Lissauer & Co., and wife sailed for Amsterdam on the *Ve Amsterdam*, last Wednesday. Mr. Lissauer will visit the principal cities of Holland, England, Germany and France, and expects to make a three or four months' trip.

An imitation pearl necklace, having a clasp set with small diamonds, was found one day last week in front of 92 Maiden Lane by a small boy who turned over the property to Detective Muldoon. The necklace, which is valued at \$50, is now at Police Headquarters awaiting an owner.

George Whitney, also known as "Old George" and as "The Fakir," who for many years had peddled cheap jewelry along the Bowery, was found dying at dawn one day last week in front of a Pearl St. lodging house. Before he could be taken to a hospital he was dead.

H. Z. & H. Oppenheimer, of 48 Maiden Lane, recently had the pleasure of extending congratulations to their parents, Mr. and Mrs. Zachariah Oppenheimer, whose golden wedding anniversary was celebrated at their Summer home in Far Rockaway, L. I. Numerous friends extended best wishes.

Glass diamonds and other cheap jewelry were found in the possession of two men who were arrested Sunday when coming out of a vacant house in W. 143d St. The men, who gave the names of Charles White and George Wilson, are suspected by the police of being burglars and were held in \$1,000 bail.

After being conducted for 40 years at 49 Catharine St. the business of Hannah Tannenholz was removed this week to 755 Lexington Ave. Mrs. Tannenholz, whose late husband established the business, now admits into partnership her son, Maurice, under the firm style of H. Tannenholz & Son. The store at 49 Catharine St. has been sold to Herman Rogalsky.

A certificate was filed last Saturday incorporating the Edwin Heathcote Co., with \$3,000 capital. The directors named are: N. M. Stevens, John Chattle and J. C. Heathcote, Brooklyn. It will be recalled that Edwin C. Heathcote, 13 Maiden Lane, recently went into bankruptcy after reporting the loss of a stock of jewelry valued at \$10,000 in a Brooklyn Bridge car.

Entertaining stories of his trip to Tennessee, Mississippi and Louisiana are being told these days to his friends by Colonel

John L. Shepherd, of the Keystone Watch Case Co. Although a Virginia boy, Colonel Shepherd had not been back to the south for many years, and his visit to his sisters and other relatives living in the States mentioned, was an event which he thoroughly enjoyed.

William Scheer, 544 Fifth Ave., who is the president of the Bell Harbor Yacht Club, entertained the members on Memorial Day at a dinner served in the clubhouse at Rockaway Beach. The dining hall was handsomely decorated for the occasion, and the boats in commission, by dressing ship, made a pretty scene in the harbor. The club has been built up mainly through Mr. Scheer's efforts.

A discharge from liabilities of \$12,716 was granted last week by the United States District Court to Theodore Sander, who was in business at 1278 Broadway until January, when an involuntary petition in bankruptcy was filed against him. A few days before the filing of the petition he made an assignment to Frederick Alt. The stock was since sold by the receiver under the direction of the bankruptcy court for \$1,500. The only other assets were fixtures and accounts.

At a dinner given recently by 50 representatives of importing houses to George W. Whitehead, who lately resigned as appraiser at the port of New York, there were present among others: E. J. Dingee, of the Gorham Mfg. Co.; Percy F. Frazee, of Alfred H. Smith & Co.; D. J. Frankel, of Joseph Frankel's Sons; S. Arnstein, of Arnstein Bros. & Co.; R. H. Kirkpatrick, of Chester Billings & Son; Ludwig Nissen, of Ludwig Nissen & Co.; August Goldsmith, of Stern Bros. & Co.; Wm. H. Sandford, of Tiffany & Co., and Theodore B. Starr.

Udall & Ballou is the style under which a new company was incorporated last week to take over the business conducted up to this time by the firm under the same name at 499 Fifth Ave. The company will occupy a new location, having obtained the lease of the store at 574 Fifth Ave., near 47th St., formerly occupied by Edelhoff Bros. & Co. The capital stock of Udall & Ballou is \$150,000, divided into shares of \$100 each. The directors for the first year are: Frederick H. Ridgeway and George W. Cudlipp, of New York City, and Lewis F. Wilson, of Elizabeth, N. J., in addition to the officers. The officers are as follows: Frank Udall, president; F. W. Barthman, Jr., vice-president, and Herbert Ballou, treasurer.

Creditors of Bernard Steinfeld, 504 Sixth Ave., who sells jewelry on the road, met at his request last Saturday in the office of Hastings & Gleason, 258 Broadway. Mr. Steinfeld was present and related the details of the robbery at New Haven, of which a brief account was given in last week's issue. Mr. Steinfeld said that the jewelry taken from him at that time was worth \$4,000. He showed the sample case which, he said, had been wrenched from his hand by the robber. The case was afterwards found in the railroad yards. The lock had not been opened, but a slit had been made in the side with a knife. Mr. Steinfeld offered the creditors 30 per cent. The liabilities repre-

IN THE HEART OF THE JEWELRY DISTRICT.

# Guardian Trust Company,

170 BROADWAY, COR. MAIDEN LANE, NEW YORK.

Capital and Surplus - Over \$1,000,000

Equitable rates of interest allowed on surplus funds.

Collection of out-of-town items made on reciprocal basis.

FRANK W. WOOLWORTH, President.	LATHROP C. HAYNES, Secretary.	Prominent Jewelers Among our Directors	LUDWIG NISSEN, A. K. SLOAN, LEOPOLD STERN.
GEORGE W. FAIRCHILD, Vice-President.	ALFRED M. BARRETT, Asst. Sec'y.		
CHARLES L. ROBINSON, Vice-President.			

# THE ORIENTAL BANK.

ESTABLISHED 1853.

182 and 184 Broadway, <sup>Corner</sup> JOHN STREET, NEW YORK.

Capital, - - - \$750,000.00.

Surplus and Profits, 1,100,000.00.

*ACCOUNTS FROM THE JEWELRY TRADE ARE SOLICITED.*

R. W. JONES, Jr., President.	LUDWIG NISSEN,	} Vice-Presidents.
NELSON G. AYRES, First Vice-President.	ERSKINE HEWITT,	
GEO. W. ADAMS, Cashier	CHARLES J. DAY,	
R. B. ESTERBROOK, Assistant Cashier.		

# The Market and Fulton National Bank of New York.

ORGANIZED 1852

81-83 FULTON STREET.

Capital, \$1,000,000. Surplus, \$1,335,000.

ALEXANDER GILBERT, President.  
R. A. PARKER - - Vice-President.  
T. J. STEVENS, - - - Cashier.  
JOHN H. CARR, - Asst. Cashier.

Invites the Accounts of Jewelers.

Will extend every facility that good banking will justify.

**SAFE DEPOSIT VAULTS.**

# The Chatham National Bank

Broadway and John Street, New York

H. P. DOREMUS, Cashier      GEORGE M. HARD, President      W. H. STRAWN, Ass't Cashier

# THE STATE BANK

376-378 GRAND STREET, NEW YORK

Capital and Earned Surplus, over \$1,100,000. Deposits over Fourteen Million.

Offers a favorable market for short and long time jewelry and diamond paper

# *The Mercantile National Bank of the City of New York*

*Cordially invites Accounts  
from Good Merchants  
in the Jewelry Trade.*

**CONVENIENT LOCATION,  
AMPLE CAPITAL,  
LARGE SURPLUS,  
LONG EXPERIENCE.**

*FREDERICK B. SCHENCK, President.*

*MILES M. O'BRIEN, }  
WILLIAM H. TAYLOR, } Vice Presidents.*

*JAMES V. LOTT, Cashier,  
EMIL KLEIN, Asst. Cashier,  
ALFRED W. DAY, Asst. Cashier.*

<i>Capital,</i>	•	•	•	<i>\$3,000,000</i>
<i>Surplus,</i>	•	•	•	<i>\$3,000,000</i>

*Broadway, Corner of Dey Street,  
New York.*

# FREE

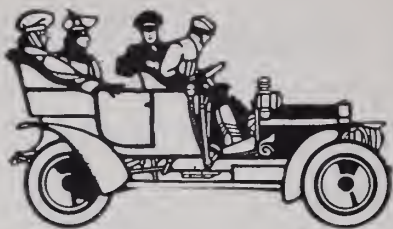

# TO RETAIL JEWELERS

To celebrate the **FORTIETH ANNIVERSARY**  
OF THE  
**W. & S. BLACKINTON CO.,**

and to commemorate the making of the first gold filled, hard-soldered, fancy-link vest chains by Wm. Blackinton, we make this announcement of direct interest to all  
Retail Jewelers

## Between May 1, 1906, and January 1, 1907

Every Blackinton Dickens, Waldemar, Pony or Neglige Chain will bear an aluminum tag, illustrated herewith



### SAVE THESE TAGS

Every one has a definite value.

In January, 1907, we will award to retail jewelers according to number of Aluminum Chain Tags collected up to January 1

## Four Capital Prizes

For the largest number of tags

**ONE TOURING CAR**—an automobile of STANDARD GRADE—1907 model

For the NEXT largest number of tags

**ONE RUNABOUT AUTOMOBILE**—high-grade—1907 model.

For the NEXT largest number of tags

**ONE MOTORCYCLE**—warranted to be A1—1907 model.

For the NEXT largest number of tags

**ONE AMERICAN WATCHMAKERS' LATHE**—of latest standard design.



Retailers who do not win one of the four capital prizes may exchange their tags for chains as below provided, or can realize on their tags as they use the chains.

**FOR 40 TAGS**—we will deliver free, one of our GLOBE one-eighth gold filled vest chains

**FOR 75 TAGS**—we will deliver free two GLOBE chains

**FOR 100 TAGS**—we will deliver free three GLOBE chains

N. B.—Refuse to receive from jobbers any of our chains that do not bear the coupon tags.

We offer a choice of twelve handsome patterns of Globe one-eighth gold filled chains in selecting premiums and illustrations will be mailed free on request. Globe one-eighth gold filled chains are guaranteed to assay one-eighth, are gold soldered and are warranted to give satisfaction for twenty years. Old Reliable W. & S. B. ★ gold soldered, 1-10 chains, are the best known chains in the world and have no superior in design, finish or wearing qualities. All Blackinton chains are made by our Wearbest process which hardens the gold and greatly increases the wearing qualities. No other chains are made in this manner.

Retailers who find difficulty in obtaining Blackinton Chains may, upon request, receive a list of jobbers who handle the goods in their territory, or a selection package will be shipped through any jobber whom the retailer may designate.

**1866 — W. & S. BLACKINTON CO. NORTH ATTLEBORO — 1906**  
MASSACHUSETTS

## New York Notes.

(Continued from page 59.)

nted by those present amounts to \$4,600. ere was a difference of opinion as to ether or not the offer should be accepted, d no conclusion was reached.

Sumner Clarke, formerly of Lakewood, now at Red Bank, N. J.

Julius Rothenberg, Jersey City, has ad- tted as a partner Mr. Bernhardt, and firm style will be Rothenberg & Bern- rdt.

Pmsler & Ghinger is the name of a new manufacturing diamond mountings at Maiden Lane. It is composed of E. nsler and J. Ghinger, the latter having merly dealt in diamonds at the same ad- ress.

An alarm for Mrs. Wm. De Freest, ose husband is a designer in the silver n of Luxenberg & Haskell, 127 Grand , was sent out by the police last Satur- y. She had been in a sanitarium some uths ago and her husband feared that e had met some harm. The next day it s learned that Mrs. De Freest was vis- ing with relatives at New Brunswick, J.

C. G. Alford returned last wee' after ssing a month in Saranac Lake Inn. uch of his time was given to fishing in the ke and streams thereabouts, and those who ow of Mr. Alford's prowess in this sport ll not be surprised on being told that he ade some catches that attracted attention. he New York *Herald* of last Sunday er- d the fact that a four-and-a-half-pound eckled trout caught by Mr. Alford was e of the most beautiful specimens of the sh that had been seen in that part of the ate in many a day.

Because of some difficulty in getting the esent address of William W. Randall, the weler who had desk room at 20 Maiden ane until recently, the order requiring him o turn over property valued at \$600 to the trustee in bankruptcy of his estate, has not et been served. The order was granted vo or three weeks ago, but about that time r. Randall gave up his desk room in the aiden Lane office. A visit to the house in rooklyn given in the city directory as his ome also proved fruitless, so that Hastings Gleason, who obtained the order, as at- rneys for the trustee, are still trying to erve it.

Theo. A. Kohn & Son, 221 Fifth Ave., nt, last Thursday, an alexandrite weigh- g six and a half carats to Mrs. H. E. mith, at the Belgravia apartment, Fifth ve. and 49th St. A day or two later rs. Smith called up the jewelry firm nd asked why the stone had not been de- vered. The jewelers then made an in- uestigation. They learned that when their essenger reached the Belgravia with the ackage he was informed that Mrs. Smith as not at home. Robert Eckler, a young e employed as hall boy, who had given e information as to Mrs. Smith being ut, also offered to keep the package until er return. The police arrested Eckler, ho was held in \$2,000 bail in the York- ille Police Court on the charge of grand rceury. Afterward the alexandrite, which as an especially fine specimen, was re- rned to the firm.

## European Pawnshops.

GERMAN ESTABLISHMENTS REGULATED FOR THE PUBLIC WELFARE.

**A. M. THACKARA**, Consul General, sends from Berlin an exhaustive statement concerning the pawnbrokers of that city, and also of other parts of Germany.

There are no pawnshops under the management of the municipal authorities in Berlin, but there is a royal pawn office and numerous private pawnbrokers, who have to be licensed and are strictly regulated by law. The Royal Prussian pawn office was established in 1834 under the control of the Royal Bank. The purpose of its establishment was the promotion of the common welfare, and all profits from the business, or any surplus which remains after charging a moderate rate of interest and deducting all costs of administration, are devoted to charitable purposes. It was established by a cabinet order signed by Frederick William in 1834. The officers are appointed by the bank, and there are strict regulations for the conduct of the business and for auditing of the accounts. The institution lends from one-half up to two-thirds of their estimated value upon all movable effects not expressly prohibited, including jewels, precious stones, gold, silver, copper, brass, tin, and similar metals, articles of clothing, and other useful objects for the storage of which no great space is required. Excluded from acceptance as pledges are worn-out goods, fluids, copper plates, books, and all fragile articles, or others easily spoiled or which would cause fire.

Persons who want to borrow money from the pawnshop, providing they are not known to officers of the institution, have to establish their identity by documents or by the testimony of credible persons, or from those who are prohibited by law from borrowing. There are specially appointed appraisers to estimate the value of any article pledged. A ticket is issued showing the name of the pawner, a description of the pledge, its estimated value, and the amount loaned on it. If the pledge is not redeemed, it is sold; and if any greater amount is obtained for it than the amount loaned, the excess is returned to the person who pledged the article. Every pawner has the right to redeem his pledge before the contract time has expired, but interest must at least be paid for one month. Provision is made for the recovery of the article pawned providing the owner loses his pawn ticket.

The lowest amount upon which money is loaned is 1 thaler, equal to 71 cents, except that in the department of the royal pawn office in the district of Berlin where the poorer classes reside, a loan is made on 2 marks, equal to 47 cents. The rate of interest on money loaned on pledges which the royal pawn office may legally charge is 1 per cent. per month, or 12 per cent. per annum. Upon easily negotiable securities, however, such as city, state, or government bonds, it may charge interest at the rate of 6 per cent. per year, but never less. In other words, the royal pawn office is not permitted to enter into competition with the banking houses.

The surplus, donated to charitable pur-

poses is not large. In 1888 it was \$14,764, in 1889 it fell to \$10,765, and in 1900 there was a loss of \$2,860. The profits in 1904 were \$2,131. These figures of the royal pawn office and its branches show that it is difficult to make it pay expenses. There are 174 private pawn shops in Berlin, so much more conveniently situated that they take the business away from the royal office. These private establishments are regulated very strictly, and the sale of unredeemed pledges has to be carried on by officers designated by the government. The appraised value of the loans of the royal pawn office was at the close of March, 1905, \$1,067,398. The working capital of the royal pawn office at the close of 1905 was \$883,072.

Among the persons who borrowed money at the royal office were merchants, artisans, tradesmen, capitalists, and property owners, artists, actors, military men, and people of all classes. There are no reliable statistics available which would indicate the amount of business done by the private pawnshops in Berlin. One of the principal local pawnbrokers estimates that the pledges of the 174 private pawnshops will average about \$10,000 each annually, the value of the pledges reaching \$10,710,000 and the loans \$3,570,000. They all seem to be prosperous.

In none of the cities in Germany can the public pawn institutions compete with the private pawnbroker, notwithstanding that the public institutions, on account of their official character, afford greater security in the storage of the pledges, the values are estimated by sworn appraisers, the rate of interest is lower, and in case of auction sale of the unredeemed pledges the pawner is better protected.

In the royal offices the pawner may redeem his pledge within a month by the payment of a month's interest, while in the private pawnshop no less than two months' interest is ever charged, however short may be the loan period. In the Government institution after the pledge is sold by auction the pawner is relieved from all responsibility, no matter if the price obtained at the sale should be less than the amount loaned with interest and the cost of sale. Under similar conditions, however, the private pawnbroker may sue the pawner for the difference. A private pawnbroker may charge interest of 2 per cent. per month, or 24 per cent. per year on loans not exceeding \$7.14, while the royal pawn office may only demand 1 per cent. per month, or 12 per cent. a year.

In a great majority of the Prussian cities of more than 50,000 inhabitants the existing municipal pawn offices were founded in the first half of the nineteenth century. After the year 1881 there were only two newly established—Essen in 1881 and Altona in 1882. On the other hand, the municipal pawn office of Magdeburg, founded in 1840, was suspended on the first of February, 1891, and negotiations are in progress looking for the dissolution of the municipal pawn office at Breslau which has existed since 1781.

(To be continued.)

Harry Silver has sold out his jewelry store in Seattle, Wash.

J. B. Pederson, Leeds, N. Dak., will erect a store building of concrete blocks for the use of Pederson & Waters, jewelers.

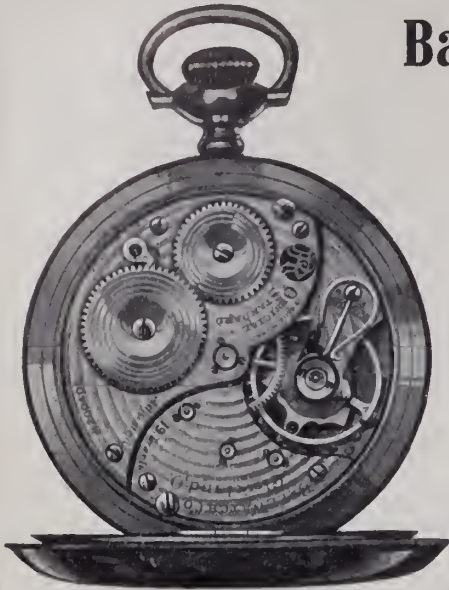

## Ball's Official Standard R.R. Watches

WHAT WOULD YOU GIVE FOR A LIFELONG CUSTOMER?

Try this plan.

Sell your next watch customer a "Ball."

Its reliable performance will convince him you are a dealer to be depended on—he'll keep coming back for other things.

The watch will win you his business and friendship for always.

*Write for booklet, and watch this space.*

We want to add a lot of new friends to the Ball family of railroad watch dealers.

### THE WEBB C. BALL WATCH CO.

CLEVELAND  
Ball Building

CHICAGO  
804-6-8 Railway Exchange

ESTABLISHED 1854.

INCORPORATED 189

## JUERGENS & ANDERSEN Co.,

DIAMONDS,

MAKERS OF FINE JEWELRY,

92 TO 98 STATE STREET,  
CHICAGO.

23-25 Looijersgracht, Amsterdam, Holland.

# THE HERMAN KECK MFG. CO.

CUTTERS OF

# DIAMONDS.

### FOR SALE.

A complete diamond cutting outfit of twenty benches, European make, consisting of sawing machines, rounding machines, laps, tongues, dops, scouring stands, etc., all in first class condition. Will sell cheap, if sold in bulk at once, as we have replaced them with American tools.

MANUFACTURING JEWELERS, SILVERSMITHS.

Recutting and Repairing of Diamonds.

17-19-21-23 West Fourth St.,  
CINCINNATI, O.

## RUDOLPH NOEL & CO

IMPORTERS OF

Diamonds, Pearls, Rubies, Emeralds, Sapphires, Opals, Olivines,  
Cat's-Eyes, Rose Diamonds and Reconstructed Rubies

2 Tulp Straat, AMSTERDAM

Phone 1902 John

37-39 Malden Lane, NEW YORK



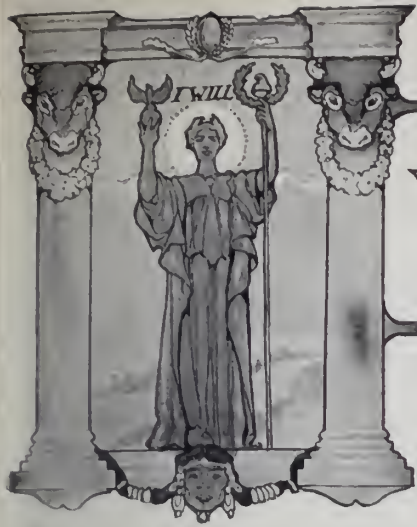

# WESTERN DEPARTMENT

Western Office:  
204 COLUMBUS MEMORIAL BUILDING,  
CHICAGO.

Telephone:  
4079 CENTRAL,  
CHICAGO.

VOL. LII.

CHICAGO, WEDNESDAY, JUNE 6, 1906.

No. 18.

## Chicago Notes.

J. Ziegler is on a western trip.  
Reuben W. Cohen is in Minneapolis this week.  
A. C. Becken has returned from a visit to New York.  
Geo. T. Bynner has returned from a western trip.  
James W. Clark has returned from a Canadian fishing trip.  
Martin A. Hagen, Fargo, N. Dak., was a visitor here last week.  
Max L. Silverberg, diamond dealer, will sail for Europe in June.  
J. A. Cunningham is in the northwest for Regnell, Bigney & Co.  
Joe Crawford, with J. W. Forsinger, has returned from a western trip.  
I. L. Gross, with the Knickerbocker Silver Co., is on a southern trip.  
Theo. Jacobs & Co. have removed to room 214, Silversmiths building.  
L. A. Eppenstein has returned from a lengthy trip to the Pacific Coast.  
W. A. Fay, with the John T. Mauran Mig Co., is on the Pacific coast.  
Oscar A. Lessing, with S. & B. Lederer Co., is on a trip to the northwest.  
Jack Stanley, accompanied by Mrs. Stanley, has returned from a visit to the east.  
"Ed" Walther, with the D. F. Briggs Co., is back from a northwestern trip.  
W. S. Sparrow, western agent for Stern Bros. & Co., is on a trip to the coast.  
Ben. Roth has opened a new jewelry store on Madison St., near La Salle St.  
Joe Witty, of Hopkins & Witty, Dubuque, Ia., was a visitor here last week.  
Bernard Weinstein, 533 S. Halsted St., is taking a vacation at West Baden, Ind.  
G. M. Landon, with the Homan Silver Plate Co., has returned from a northwest trip.  
Larry Edwards, with Chas. E. Hancock Co., has returned from a trip through the west.  
B. S. Sandfelder, with McRae & Keeler, has returned from a six weeks' visit to the factory.  
P. H. Boyson, of the Boyson Co., Cedar Rapids, Ia., visited Chicago last week on a purchasing trip.  
A. Courvoisier & Co., manufacturing jewelers, have removed from McVickers Thea-

tre building to room 914 Silversmiths building.

"Jim" Edwards, with the B. S. Freeman Co., has returned from a trip to the Middle Atlantic States.

B. F. Hirsch, representing Becker & Co., has removed from 19 Wabash Ave. to room 410 Silversmiths building.

J. S. Mayer, with the Mauser Mfg. Co., is on a two months' eastern visit to the factory at Mt. Vernon, N. Y.

John J. Decker, with Wm. A. Rogers, Ltd., is receiving the congratulations of his friends on the occasion of the birth of a daughter.

Victor Paltrovitch is opening a new jewelry store at 68 State St., in part of the premises formerly occupied by the Shourds-Adcock-Teufel Co.

Charged with embezzling \$2,000 from a former employer Theodore Pieper, bookkeeper for the Geneva Optical Co., was arrested here last week.

Geo. W. Pettee, with T. G. Hawkes & Co., and Fred L. Pettee, with the Waterbury Clock Co., will spend the Summer in the upper lakes region.

The cottage being erected at Lake Geneva by C. H. Knights, is nearing completion. Mr. Knights will occupy it with his family during the Summer.

Robert C. Abt, with Herbert W. Allen & Co., was married last week to Miss Kate Ward. Mr. and Mrs. Abt spent their honeymoon at The Dells, Wis.

Henry G. Rettig, of Rettig, Hess & Madson, injured his right leg while playing baseball Decoration Day. Mr. Rettig now walks with the assistance of a cane.

W. T. Austin, 550 W. Madison St., has bought out the jewelry store of Herman Schultz, 970 Milwaukee Ave., and is conducting business at the latter address.

F. R. Sheridan, of Arnold & Steere, arrived from the coast last week with his wife and family, who had been spending the Winter and Spring in Los Angeles.

H. W. Gilmore & Co. have been incorporated with a capital of \$5,000 to manufacture and sell jewelry. The incorporators are: William R. Payne, H. W. Gilmore, L. B. Drew.

J. F. Dailey & Co., instalment jewelers, St. Louis, Mo., have opened an instalment and retail jewelry store at 63 Washington

St., on the premises formerly occupied by Clapp & Cowl.

J. B. Renkin, manufacturer's agent in San Francisco, is on his way here accompanied by his wife. Mr. and Mrs. Renkin lost all their personal belongings in the San Francisco fire.

At a meeting of the creditors of The Cash Buyers' Union, held last week, Chas. L. Billings, an attorney at 100 Washington St., was appointed trustee. Mr. Billings has 60 days to file his report.

The Benedict Mfg. Co. has moved its local offices from room 903 to room 805 151 Wabash Ave. E. H. Banker, vice-president of the Benedict Mfg. Co., will start on a trip to the coast June 25.

W. A. Schlossman, with H. F. Hahn & Co., left for New York Friday, accompanied by his wife. Mr. and Mrs. Schlossman sail for Europe to-morrow on the *Grosser Kurfurst* for a two months' trip.

An automobile collided with a carriage containing Dr. J. B. McFatrigh and some friends last week. Dr. McFatrigh was thrown to the street, but outside of a shaking up sustained no further injury.

Charles C. Hoefler, of the Woodstock-Hoefler Watch & Jewelry Co., Kansas City, Mo., spent the latter part of last week here. Mr. Hoefler reports the business outlook in Kansas City very good for the Fall trade.

E. Staehli, of Staehli & Brunn, returned from Switzerland last week on the *Kronprinz Wilhelm*. While abroad Mr. Staehli made arrangements whereby shipments of watches made by his firm at Chaux De Fonds will be greatly facilitated.

The address is wanted here of Robert E. Corbett, formerly New England salesman for the Rockford Watch Co. Mr. Corbett lives in Danbury, Conn., and was last heard from in Boston. The Rockford Watch Co., Rockford, Ill., would like to know his whereabouts.

Albert L. Alexander, a jeweler of Mapleton, Ia., eloped with Miss Lela V. Douglas, of Sac City, Ia., and they were married in Milwaukee.

Harry Jahlinger, jewelry and silverware buyer, formerly at the Emporium, San Francisco, Cal., has recently accepted a similar position with the Henry Siegel Co., Boston, Mass.

# To the Jobbing Trade.



out of 100 a Looker becomes a Buyer when inspecting the showing of diamond jewelry and mountings manufactured by us.

Just now we lay special stress on our Fall assortment of Diamond Tiffany Bunch Rings.



## Denver

Fred R. Warner, with Sam Mayer, has returned from a business trip to St. Louis, Mo.

Joseph I. Schwartz left last week for the mountains to try his luck as a fisherman.

Word has been received here that Dan C. Philips, of San Francisco, will shortly arrive in Denver to establish himself in the optical business.

Among those recently engaged by the Joseph I. Schwartz Jewelry Co. is D. A. Martin, well known among local jewelers.

A. Costather, a refugee watchmaker in San Francisco, had trouble on arrival in Denver. He became involved in an altercation on a street car and was fined at the police court for disturbing the peace.

The silver centerpiece donated by the Daughters of the American Revolution of Denver to the cruiser *Colorado*, has just been finished, and has been on exhibition this week in the windows of the Boyd Park Jewelry Co. The piece is a silver dish which can be used for either flowers or fruit. It is engraved in the center with the crest of the D. A. R., and is richly wrought about the border with hand-chased raised renaissance work. Another silver dish fits inside to hold moist sand for flowers, and over it is a solid gold screen to keep the flowers in place. Underneath the side of the dish is the inscription, "Presented by the Colorado Daughters of the American Revolution."

A fine array of prizes presented by manufacturing jewelers throughout the country for the coming national convention of the Elks is now on exhibition in the window of Sam Mayer in the Mercantile building. The gifts were donated through the efforts of Mr. Mayer, and will be given to the owners of residences having the handsomest decorations in honor of the Elks-visit. The first prize is a gold clock set consisting of three pieces presented by the Jennings Bros. Mfg. Co., Bridgeport, Conn. A handsome cut glass vase is the gift of J. D. Bergen & Co. The New Haven Clock Co. is the donor of a china clock. A lady's gold chatelaine bag, a unique belt buckle and an exquisite gold vandy box set with diamonds are presented by the E. A. Bliss Co., of Meriden, Conn. Frank Whiting & Co., Attleboro, Mass., are represented by a silver water pitcher. A sterling silver topped cut glass ink well is from the Woodside Sterling Co., New York. A solid silver berry bowl is from Unger Bros. Newark, N. J. A beautiful brooch set in sapphires is from Fishel, Nessler & Co. New York; a gold fob, from Louis Freund, a solid gold elk's tooth from Gustave Fox and a gold watch from Sprochnle & Co. Chicago.

Elof Benson, Youngstown, O., will sail for Europe some time this month, and on his trip will visit Sweden and Switzerland making a visit to the watch factories in the latter country.

J. Frank Reaves, formerly superintendent of the Rockford Watch Co., Rockford, Ill., recently resigned to accept a position in a similar capacity with the South Bend Watch Co., South Bend, Ind.

## St. Louis.

S. E. Bamber, secretary of the Hess & Culbertson Jewelry Co., is on a three weeks' trip through Ohio.

O. Miller, associated in business with L. A. King, Hawkinsville, Ga., is spending a few days in this city.

J. A. Jerauld, a manufacturing jeweler of Providence, R. I., called on the local trade here last week.

Alvin L. Bauman, president of the L. Bauman Jewelry Co., is now in the Antwerp diamond market.

Paul E. Pautler, of the Brooks Jewelry Optical Co., made a short trip into south-west Missouri last week.

Meyer Schinderman is in Kansas and Missouri this week for the L. Bauman Jewelry Co., handling loose diamonds only.

F. Warneke has gone to Europe for a trip. In his absence the business in the Leuitable building is being looked after by his son.

E. Nickell has disposed of his business at 237 Grand Ave. to A. Bonjot, formerly with the F. W. Drost Jewelry Co. Mr. Nickell will take a trip to Europe.

Goodman King, president of the Mermod, Jaccard & King Jewelry Co., was among the Americans who registered at the New York Herald Paris Bureau last week.

Max Schmidt, of the material department of the Bauman-Massa Jewelry Co., has been called to his home in Houston, Tex., on account of the illness of his father.

Joseph Auer, of the Bauman-Massa Jewelry Co., departed Sunday for a vacation trip. He went from here to Minnesota, and hence starts for a tour through Yellowstone Park, to be gone about four weeks.

W. F. Kemper, secretary of the Retail Jewelers' Association of Missouri, was away from his store last week, owing to injuries received by Mrs. Kemper, who fell while moving into their new home at 3450 Sidney St.

The Mermod, Jaccard & King Jewelry Co.'s fishing enthusiasts report a most successful outing, bringing home 265 game fish, according to the sworn statement of Walter D. Ely, of the repair department. The same crew made another trip last Saturday.

The Hess & Culbertson Jewelry Co. is now doing all of its own repairing, opening a shop in the Ornel building in which the store is located. Eight men are employed in the shop, which is in charge of E. J. Helmerichs, formerly with the Mermod, Jaccard & King Jewelry Co.

In the Circuit Court of St. Louis County a decree of divorce was granted last week to Mrs. Jessie B. Morrison against Samuel E. Morrison of Morrison, Levy & Co. By stipulation, judgment for alimony was entered at the rate of \$40 a month for the first year, \$50 a month for the second year and \$60 a month for the third year. After that there will be further determination of the amount.

Among the visiting jewelers in the local market last week were the following: George Notermann, Nokomis, Ill.; J. J. Gaffner, St. Jacob, Ill.; Robert Tetley, Farmington, Mo.; L. J. Empfield, Paragould, Ark.; J. Harvell, Litchfield, Ill.; L. A. Tomley, Poplar Bluff, Mo.; H. Cham-

bers, Bonne Terre, Mo.; Charles Goodrich, Caruthersville, Mo.; Ben. Bowden, Mayfield, Ky.; Fred Simon, Collinsville, Ill.

The Maschmeyer-Richards Silver Co. is now doing business in its handsome quarters, 300 Carleton building, 6th and Olive Sts. A. Maschmeyer was with the Jordan Cutlery Co., St. Louis, for 27 years, and was formerly manager of the New York house of R. Wallace & Sons Mfg. Co. D. P. Richards was with the Jordan Cutlery Co. for seven years. The new firm is a wholesale dealer in sterling silver, silver plate and cut glass.

The negro who was recently arrested after a wild chase on the charge of robbing the store of William F. Mueller, 1891 Olive St., escaped from the City Hospital, and is still at large. He dropped from the ledge of the hospital building to the ground between 30 and 40 feet, and eluded hospital attendants who tried to apprehend him. The negro had been identified as David Henderson, a chief on the private car of Theodore F. Shonts, president of the Clover Leaf Railroad, and the head of the Panama Canal Commission.

It was reported in the issue of THE CIRCULAR-WEEKLY of May 30 that Jacob B. Pollock was the latest jeweler to begin business in St. Louis, Mo. This was erroneous, as Mr. Pollock opened his store Jan. 4, 1906, at 6116 Easton Ave., near Wellston, Mo. He is the son of Alexander J. Pollock, of 106 N. 4th St., and is also the owner of the Wellston Jewelry Mfg. Co., which is located near his establishment. The office and factory are in Wellston. Alexander J. Pollock will move from his present location into more commodious and newly furnished quarters at 12 N. 4th St., this city, on or about June 15.

## Indianapolis.

An itinerant watch repairer known as Sol Joseph died in this city recently.

Announcement is made that a new jewelry store will be opened in the Claypool Hotel building.

The local post office has held up the mail of the "Guess Novelty Jewelry Co." pending an investigation.

The family of A. W. Gray, of Gray, Gribben & Gray, has returned after a visit of several weeks in Kansas.

Local merchants have received announcement of the marriage of Floyd Nester, Boonville, Ind., and Miss Mary E. Metsker, Noblesville.

The local trade has been notified of the establishment of a new store in Vincennes under the name of the Henkers, Baker Jewelry Co.

Through the Federal Court in this city, Harry R. Greyer, who assigned several weeks ago, has offered his creditors 20 cents on the dollar.

Traveling representatives say that Bitterman Bros. have completed extensive improvements to their store in Evansville and that their store now is one of the handsomest in southern Indiana.

Out-of-town jewelers who visited the local jobbers and manufacturers last week included B. Maier, Edinburg; D. S. Whitaker, Lebanon; Aaron Pursel, Noblesville; Mr. Barnes, of Barnes & Foster, Spencer;

H. Wheeler, Dana; J. A. Pickett, New Castle; C. E. Hodgen and Ross J. Haseltine, Kokomo; J. F. Harding, Brownsburg; H. A. Pauley, Bloomington, and Mr. Raber, of Clark & Raber, Anderson.

## San Francisco.

Matt. Draghicevich, formerly at 1024 Washington St., is now located at 1529 Green St.

Carran & Green secured quarters, June 1, at 1510 Buchanan St., between Geary and O'Farrell Sts.

J. Hirschfeld has opened an office at 1740 Bush St., for the purpose of buying diamonds and other precious stones.

Julius A. Young moved from his temporary location in Oakland to his new quarters in the Kamm building this week.

Radke & Co., who opened for business some days ago at 1813 Devisadero St., have secured a full stock and have their factory running in good shape.

Wm. Wilson, a prominent Oakland jeweler, located for many years on Broadway, has leased a new store on San Pablo Ave., into which he will soon move.

The Field & Cole Curio Co., formerly at 327 Kearny St., is located temporarily at 19 S. 1st St., San Jose, but will reopen in San Francisco in the near future.

Adolf J. Grinberg, of Adolf J. Grinberg & Son, 1 Maiden Lane, New York, is in San Francisco with offices at 1015 Van Ness Ave., for the purpose of buying diamonds, pearls and other precious stones.

Walter Graves, a wholesale silverware and cut glass dealer, formerly at 120 Sutter St., and since the fire in the Globe Hotel building in Oakland, removed this week to the newly re-opened Kamm building in San Francisco.

T. Lundy, formerly in the retail business at 4 3d St., and on Market St., opposite the Call building, is now having a building erected on Market St., near Grant Ave., which he will occupy early in June with a stock of retail jewelry. This will be the first retail jewelry store to open in the center of the burned district. Mr. Lundy is now located at temporary offices at 947 Stanyon St.

D. J. Barr, a manufacturer's representative, formerly located at 120 Sutter St., has secured offices and salesrooms at 376 Oak St., from which point his business will be conducted during the reconstruction period. Mr. Barr represents J. A. Deknatel & Son, Inc.; Herbst & Wassall and Wm. Link. Mr. Barr has not yet recovered his safe nor even located it in the mass of ruins at 120 Sutter St.

Wm. B. Glidden, wholesale dealer in silverware and table cutlery, and Coast representative of R. Wallace & Sons Mfg. Co., E. G. Webster & Son and Wm. S. Hicks' Sons, has decided to remain at 1116 Broadway, Oakland, until suitable permanent quarters can be had in San Francisco. He prefers to put up with the inconvenience of handling his trade from Oakland rather than to accept anything now offered in San Francisco.

F. H. Shields, Mount Sterling, Ill., recently sold out to Mrs. E. M. Cox, who will continue the business.

### Kansas City.

C. J. Benson, Lee's Summit, Mo., was in the city this week on a buying trip.

The Edwards & Sloane Jewelry Co. has begun closing at 1 o'clock on Saturdays.

Noble L. Fuller, of the Edwards & Sloane Jewelry Co., is expected back from his buying trip the middle of next week.

E. S. Villmoare, who travels for the C. B. Norton Jewelry Co., in Missouri and Texas, is in the house again this week.

Jake Levin, a traveler for Kionka & Kionka, who has been covering Kansas and Oklahoma, is on the home stretch now.

W. C. Schumann, who covers Kansas and Oklahoma for the C. B. Norton Jewelry Co., is paying the house a visit this week.

Fred C. Merry, vice-president of the Merry Optical Co., has just returned from a visit to the company's house in Memphis, Tenn.

Leo H. Ludwig, of the Edwards & Sloane Jewelry Co., will leave next week for a trip of a couple of weeks to the material markets.

The engagement is announced of Hazel Bell Rosenbaum, of this city, to Herbert Koppel, of the material department of the Meyer Jewelry Co.

O. W. C. Smith, a pupil of the Kansas City Polytechnic Institute, has accepted a position in the watchmaking department of the Jones Dry Goods Co.

F. E. Fricke, of the Meyer Jewelry Co., has sold his home on Norton Ave., and is now building on S. Troost Ave., where he expects to make his residence about Aug. 1.

D. B. Ward is busy these days, getting ready his wholesale business. He expects to open about the middle of June. The style of the new firm will be the Ward & Crellin Jewelry Co.

A. N. Bennett has finished his course with the Kansas City Polytechnic Institute, and has gone to Warsaw, Mo., where he will open a jewelry department in the Fair Store, conducted by his father.

O. H. Stevens, a pawnbroker of this city, was arraigned this week on two indictments. One was for receiving stolen property and the other charged him with perjury. He pleaded not guilty, and was released on bond.

The following retailers from the surrounding country have been calling on the jobbers this week: W. W. Whiteside, Liberty, Mo.; J. A. Zimmerman, Warrensburg,

Mo.; L. E. DeLanty, Parkville, Mo., and S. J. Huey, Excelsior Springs, Mo.

William E. Huston, secretary of the American Association of Opticians, has returned from a southern trip, where he has been forming State organizations, and reports a great deal of enthusiasm in Oklahoma, Arkansas, Alabama and Mississippi.

J. L. Holland, a jewelry salesman, who was stopping at the Savoy Hotel, reported last week that a sample case in his room had been robbed of two dozen gold watches, one dozen gold rings, three gold watch chains, three bracelets, a lot of gold fountain pens, collar buttons and small articles.

Dr. S. W. Lane, president of the Southwestern Optical College, has just returned from his trip through the south, where he helped to form the State associations which have affiliated with the American Association of Opticians. The Doctor will in all probability attend the meeting of the Iowa association on June 12 and 13 and he and Mrs. Lane will both attend the Rochester meeting.

The Jaccard Jewelry Corporation, now located at 1032 Main St., has secured a long-time lease on the property at 1017-19 Walnut St, two doors from the Cady & Olmstead Jewelry Co., four doors from Harry Carswell, and across the street from Gurney & Ware, and the Hewson building, which was recently leased by J. W. Mercer. That will make the block between 10th and 11th Sts., on Walnut St., a retail jewelry center.

### Minneapolis.

It is reported that J. S. Cohen, of St. Paul, has gone to Seattle.

F. L. Metzger, of S. Jacobs & Co., was injured in a runaway accident recently.

F. L. Bosworth, of the F. L. Bosworth Co., has gone to New York on a business trip.

John Felkel, of the material department of S. H. Clausin & Co., has gone to Milwaukee to spend his vacation.

The Minneapolis Jewelry Mfg. Co. has begun moving from the Andrus building to the new Security Bank building.

A. H. Wick, a merchant of Fergus Falls, Minn., has won a suit brought against him by an Iowa manufacturing concern to collect for some jewelry. Wick set up that the goods were sadly misrepresented. The

Supreme Court of Minnesota said: "The a traveling salesman falsely representing that he had made sales of similar articles to a competitor engaged in the same business is an artifice used to cheat or deceive another."

M. L. Finkelstein, the St. Paul retailer won the suit brought by Harry Rose against him for \$15,285 damages for false arrest.

Recent callers on the jobbing trade were Martin A. Hagan, Fargo, N. Dak.; A. Rost, St. Peter, Minn.; W. H. Reighart, Minot, N. Dak.; J. M. Chalmers, Lake City, Minn.; Julius Anderson, Mora, Minn.

### Detroit.

Wright, Kay & Co. have commenced suit against John Grant, a former superintendent of the Detroit United Railway, on a promissory note for \$164.62.

Burr, Patterson & Co. have taken additional space in the building at 73 W. F. St., to accommodate their increasing business.

Salesmen for the E. H. Pudrith Co., a now on their second trip. M. E. Rowland is in Ohio, and Wm. H. Horton is in Michigan.

Alterations in the store of Hugh Connolly, State and Griswold Sts., are almost completed. The basement will be occupied by the cut glass, clock and optical departments, and the street floor by jewelry. Mr. Connolly will have three times the room in business that he had before.

Mrs. Anna Trebilcock, wife of E. Trebilcock, jeweler, at 324 Woodward Av. charged him with non-support, and served out a warrant. He was released on bail, and the examination was set for June 6. Trebilcock was robbed six weeks ago of about \$1,500 worth of goods, which were later recovered.

Thos. Coffman has purchased the business of J. A. Robinson, in Toronto, Kans.

David B. Sickles, of New York, former diplomatic representative of the United States in Siam, recently furnished the State Department with a list of articles that may be profitably sent by manufacturers in the United States to Siam. In this list enumerates clocks, jewelry, music box, musical instruments, nautical instruments and watches.

## JOS. NOTERMAN & CO. DIAMONDS

IMPORTERS AND CUTTERS

Recutting and Repairing odd shaped and chipped stones a specialty. Manufacturers of Mountings and Fine Jewelry. Special Designs Furnished.

CINCINNATI, OHIO.

# Rockford Watches Speak for Themselves

INDEX TO ADVERTISEMENTS.

Allyn, Lambert & Co.....	100	Freund, Henry, & Bro.....	16	Oppenheimer Bros. & Veith.....	36
Alsopp & Alsopp.....	23	Friedlander, R. L. & M.....	Outside back cover	Oppenheimer, H. E., & Co.....	36
Amv Mfg. Co.....	Inside front cover	Garreand & Griser.....	46	Oriental Bank.....	60
American Cuckoo Clock Co.....	97	Gesswein, F. W., Co.....	100	Orkin Bros.....	26
American Gem & Pearl Co.....	52	Goldsmith, Leo.....	48	Osmun-Parker Mfg. Co.....	20
American Platinum Works.....	108	Goodfriend Bros.....	44	Ostby & Barton Co.....	19
American Ring Co.....	28	Gorham Mfg. Co.....	56	Page-Davis Co.....	104
American Silver Co.....	31	Griffoul, August.....	107	Pairpoint Corporation.....	102
American Waltham Watch Co.....	88	Guardian Trust Co.....	60	Passmore Gem Co.....	46
Arch Crown Mfg. Co.....	58	Hagstoz, T. B., Ltd.....	108	Patek, Philippe & Co.....	95
Austein Bros. & Co.....	Outside back cover	Hahn, E., & Co.....	48	Penfold, Wm. C., Co.....	98
Aut stamping & Mfg. Co.....	30	Harris & Harrington.....	Outside back cover	Percival, D. C., & Co.....	54
Bastin, John, & Son.....	Outside back cover	Hedges, A. J., & Co.....	20	Pomfret-Goldy School.....	190
Beete Turquoise Co.....	46	Hedges, Wm. S., & Co.....	44	Potter & Buffinton Co.....	18
Bee, Perline & Co.....	42	Helutz Bros.....	82	Potter Shell Works.....	104
Bell, Webb C., Watch Co.....	64	Heller, L., & Son.....	38	Power, Chas. L., & Co.....	44
Beschkopf, Jacob.....	48	Herrers Bros.....	100	Powers & Mayer.....	15
Bissett Jewelry Co.....	26	Hirsh & Hyman.....	Outside back cover	Prior, Charles M.....	24
Bates & Bacon.....	18	Hodenpyl & Walker.....	66	Prybil, P.....	107
Baume & Mercier, H. & Co.....	102	Hotel St. James.....	104	Rachne, Jules.....	97
Berge, J. & H.....	108	Howard, E., Clock Co.....	97	Reichhelm, E. P., & Co.....	100
Berglake & Eckert Co.....	80	Hrabal, Louis W.....	102	Reuziehausen, W. F., Co.....	108
Bigney, S. O., & Co.....	4	Humphrey, John B.....	46	Revell, A. H., & Co.....	Outside back cover
Billings, Chester, & Son.....	46	Hutchison & Huestis.....	27	Ries & Armstrong.....	106
Bishop, R. W.....	107	Illinois Watch Co.....	13	Robert, Edmond E.....	94
Blackinton, R., & Co.....	28	Irons & Russell.....	26	Rockford Watch Co.....	72
Blackinton, W. & S., Co.....	62	Incot Music Box Co.....	102	Roger Williams Silver Co.....	29
Bancard & Co.....	108	Jeantheur, F., Jr.....	108	Roseman, A.....	48
Bonet, L.....	46	Jeanne, Frederick A.....	44	Rosenfeld, Wm. I.....	50
Bonte, Edward.....	102	Johnston, W. J., Co.....	10, 11	Ross, Saltman & Anderson.....	31
Borrelli & Vitelli.....	50	Jorgeson, F. C., & Co.....	107	Roy Watch Case Co.....	92
Boston Jewelry Co.....	29	Juergens & Andersen Co.....	64	Rudolph & Snedeker.....	95
Bowden, J. B., & Co.....	19	Juergensen, Jules.....	95	Rumpp, C. F., & Sons.....	106
Bradley Polytechnic Institute.....	107	Kahn, L. & M., & Co.....	Outside back cover	Sadler, F. H., Co.....	17
Brower, Maurice.....	40	Kassel, Abe.....	107	Saunders, Meurer & Co.....	44
Buehl Bros. & Henius Co.....	Outside back cover	Keck, Herman, Mfg. Co.....	64	Schiff, M.....	20
Bryan, M. B., & Co.....	19	Keut & Woodland.....	23	Schultz, Leiss & Co.....	22
Buckley, Sam'l., & Co.....	23	Ketcham & McLougall.....	106	Sessions Clock Co.....	56
Bunde & Upmeyer Co.....	40	Klipper Bros.....	95	Seymour, Cassius W.....	23
Buhoone, C. H., Co.....	28	Kohlbusch, Herman, Sr.....	28	Sibman Bros. & Co.....	70
Burrington & Co.....	20	Kohn, Mois, & Co.....	20	Simmons, R. F., Co.....	8
Burter, Howe & Co.....	21	Kohn & Co.....	76	Smith, Alfred H., & Co.....	36
Batham National Bank.....	60	Koshland & Italie Co.....	52	Smith, E. H. H., Silver Co.....	30
Chopard Frères.....	78	Kremientz & Co.....	25	Snow & Westcott.....	24
Conley & Straight.....	108	Lackner & Ohl.....	106	Sohn & Hyman.....	48
Cooper Diamond Co.....	46	Langendorf Watch Co.....	94	Solidarity Watch Case Co.....	44
Cooper & Forman.....	97	Larter & Sons.....	34	Spencer, E. L., Co.....	27
Cottle, S., Co.....	24	Lees & Sanders.....	108	State Bank.....	60
Crohn, M.....	23	Leimann Bros.....	107	Steiner, Louis.....	54
Cross & Beguelin.....	30, 58	Lelong, L., & Bro.....	Outside back cover	Stern Bros. & Co.....	48, Inside back cover
Crouch & Fitzgerald.....	25	Levy, Roht.....	14	Sternau, S., & Co.....	14
Culman, C.....	50	Levy & Cohen.....	106	Stilwell, L. W.....	104
Daily, C. M.....	107	Libbey Glass Co.....	104	Stiven, John S.....	107
Day, Clark & Co.....	21	Lissauer & Co.....	38	Strauss, Ignaz, & Co.....	Outside back cover
Depasse Mfg. Co.....	22	Loeh, Wm., & Co.....	26	Strauss, Jacob, & Sons.....	48
De Selms Watch School.....	97	Lorsch, Alhert, & Co.....	Outside back cover	Street, Geo. O., & Sons.....	21
Diamond Point Pen Co.....	100	Low, Martin, & Taussig.....	38	Tavannes Watch Co.....	78
Didisheim, Hipp. & Bro.....	94	Lowe, Edwin, & Co., Inc.....	26	Thomas, Seth, Clock Co.....	92
Donnelly, J. J.....	108	Luthy & Hine.....	24	Trenton Watch Co.....	92
Doran, Bagnall & Co.....	26	Lyons Gem Co.....	48	Trout, Charles L., & Co.....	22
Dorfinger, C., & Sons.....	102	Maebert & Reiss.....	97	Van Dam, Eduard.....	50
Dowd, J. C., & Co.....	78	Maple City Glass Co.....	102	Wadsworth Watch Case Co.....	6, 7
Duik, Roht.....	22	Market & Fulton National Bank.....	60	Wagner Mfg. Co.....	30
Dunbar, Leach, Garner Co.....	108	Mathey Bros., Mathez & Co.....	95	Waite-Thresher Co.....	47
Dunn, Thomas J., & Co.....	31	Mercantile National Bank.....	61	Warner & Swasey Co.....	29
Durand & Co.....	20	Meyerowitz Bros.....	38	Washburn, C. Irving.....	23
Eden, C. H., Co.....	80	Miller, Fuller & Whiting.....	29	Wells, Chester H.....	28
Elchberg & Co.....	48	Moe, Chas.....	48	Wendell & Co.....	5
Elgin National Watch Co.....	90	Moore & Sons.....	22	Western Clock Mfg. Co.....	12
Ellassof Bros. & Co.....	78	Mount & Woodhull.....	42	Wheeler, Hayden W., & Co.....	36
E. P. H. Chain Catch.....	28	Mueller Lapidary Co.....	46	Whiteside & Blank.....	11
Fahys, Joseph, & Co.....	1	Myers, S. F., Co.....	26	Whiting & Davis.....	16
Fairchild & Co.....	30	New York Telephone Co.....	106	Whiting Mfg. Co.....	9
Favre-Jacot, Georges, & Co.....	95	Nissen, Ludwig, & Co.....	42	Wightman & Hough Co.....	29
Feeley, W. J., Co.....	24	Noel, Rudolph, & Co.....	64	Witsenhausen, L.....	24
Forman Co.....	102	Nonnenmann, A., & J. Aschenbrenner.....	100	Wodiska, Julius.....	23
Forsinger, J. W.....	96	Noterman, Jos., & Co.....	72	Wolfsheim & Sachs.....	104
Foster, Theodore W., & Bro. Co.....	32	Ohan, G.....	97	Wood, C. F., & Co.....	Outside back cover
Four-Track News.....	104	Ollendorf, I., Co.....	25	Wood, J. R., & Sons.....	2, 3

## Special Notices.

Payable invariably in advance.

Rates 75c. per insertion for notices not exceeding 25 words; additional words, 2c. each.

SITUATIONS WANTED, 1c. a word each insertion; minimum charge, 25c.

Heavy type, 5c. a word; minimum charge, \$1.25. Display cards, \$2.00 per inch.

In all cases, if answers are to be forwarded, 10c. extra to cover postage must be enclosed.

*All answers to advertisements addressed care The Jewelers' Circular-Weekly, should be sent to the New York Office, unless the Chicago Office is specifically mentioned.*

## Situations Wanted.

WATCHMAKER, engraver and jeweler of ability is open for engagement. Address "C., 6331," care Jewelers' Circular-Weekly.

EXPERIENCED, first class letter and monogram engraver is open for position, at once. "A. C. A., 6445," care Jewelers' Circular-Weekly.

SALESMAN of experience, with trade in middle west, wants to connect with a manufacturer. "Z., 6489," care Jewelers' Circular-Weekly.

FIRST CLASS WATCHMAKER, also repeater maker, wants position; good reference. Address "R., 6433," care Jewelers' Circular-Weekly.

YOUNG MAN, 23 years old, wishes position as salesman or to work inside in wholesale house. "I., 6498," care Jewelers' Circular-Weekly.

WANTED, in south, situation as watchmaker, with A1 store; only with gentleman of refinement and standing. Mr. Haldeman, 106 S. 2d St., Columbia, Pa.

WANTED, permanent position by A1 watchmaker; 13 years' experience; best of references. Address "Watchmaker," 1131 E. Jersey St., Elizabeth, N. J.

YOUNG MAN, letter and monogram engraver, wants position, with opportunity to learn watchmaking. Milton Gebhard, 735 Sansom St., Philadelphia, Pa.

POSITION WANTED as designer and enameler of fine jewelry; also capable of taking charge of a jewelry shop. "K., 6476," care Jewelers' Circular-Weekly.

ENERGETIC jewelry and watch salesman wants position inside or outside; speaks also French and German. "Watches, 6516," care Jewelers' Circular-Weekly.

WANTED, by young man (24) position as general engraver, with opportunity to learn watchmaking; references; prefer New England. Address Box 92, Holden, Mass.

WANTED, POSITION as stock clerk and salesman, with wholesale watch and jewelry house; 20 years' experience. Address "J. C., 6487," care Jewelers' Circular-Weekly.

WANTED, A POSITION as engraver, book-keeper, cashier and saleslady; good references; terms reasonable. Address "Enquirer, 5877," care Jewelers' Circular-Weekly.

YOUNG MAN (28), experienced jewelry salesman, also competent to do ordinary repairs on watches and clocks, desires position. Address L. S. Gottlieb, Thomaston, Conn.

YOUNG MAN, age 22, desires position with wholesale jewelry house; four years' experience in retail store, best of references. Address "W. F., 6431," care Jewelers' Circular-Weekly.

WANTED, steady position with chance to improve, on watchwork; first class; or clock and jewelry repairing; fair plain engraver; south preferred. "R., 6410," care Jewelers' Circular-Weekly.

WANTED, POSITION to improve on watch work, by young man with seven years' experience at the clock and watch bench; have all tools. "J. R. S., 6409," care Jewelers' Circular-Weekly.

WATCHMAKER, competent on fine and complicated work, also fine railroad watches, fine tools; can take charge of work and make it pay. "Curtis, 6160," care Jewelers' Circular-Weekly.

FIRST CLASS manufacturing jeweler of business ability, wants position as foreman of jewelry factory; 14 years' experience at bench; references. Address "Ability, 5465," care Jewelers' Circular-Weekly.

EXPERIENCED TRAVELER, with jewelry and optical trade, wants position with first class jobbing house or manufacturer, to represent them. "Represent, 6485," care Jewelers' Circular-Weekly.

POSITION WANTED by an experienced engraver on general lettering and monogram work; good salesman and window dresser; would like to have a position at once. M. A. Sherre, Batavia, N. Y.

YOUNG LADY, conversant with the jewelry business; seven years' experience in a wholesale jewelry house, desires position; \$12 to \$15; best of references. "F. K., 6435," care Jewelers' Circular-Weekly.

A YOUNG MAN, now with jeweler on Fifth Ave., New York, wishes to make a change; is a capable salesman, of good address and appearance, with best of references. "M., 6432," care Jewelers' Circular-Weekly.

ENGRAVER, young man, desires position to finish trade; good letterer on flat ware; also have some knowledge of scrip copper plate engraving; samples on request. "Script, 6479," care Jewelers' Circular-Weekly.

PRACTICAL REFRACTIONIST and watchmaker of ability; good salesman; good address and appearance; open for position at once; eastern Pennsylvania preferred. "N., 6506," care Jewelers' Circular-Weekly.

JEWELRY SALESMAN, with well established trade in Pennsylvania, New York, Ohio and West Virginia, is open for engagement with manufacturers or jobbers. "V., 6431," care Jewelers' Circular-Weekly.

A FIRST CLASS German watchmaker, 28 years old, who speaks some English, desires to obtain a permanent position; preferably in the south; answer, naming compensation. "A. B., P. O. Box 100, Houston, Tex.

A FIRST CLASS watchmaker and salesman, competent refractionist and frame fitter, desires to make a change; American; age 35; only first class houses in New York or vicinity considered; those who would appreciate the services of a man of ability address. "Successful, 6505," care Jewelers' Circular-Weekly.

**TO MANUFACTURERS and jobbers, situation wanted by a successful traveling salesman; middle west to the coast preferred. Address "C., 6474," care Jewelers' Circular-Weekly, 204 Columbus Memorial Bldg., Chicago, Ill.**

## Help Wanted.

GOOD WATCHMAKER wanted. A. Andrews, 1 Maiden Lane, New York.

JEWELER AND ENGRAVER; easy work and good salary. Ries & Armstrong, Macon, Ga.

WANTED, a good engraver and jobbing jeweler; permanent position to the right man; references required. T. Kircher, Davenport, Ia.

WANTED, first class salesman with an established trade; northwest territory, salary or commission. King, Raichle & King, Buffalo, N. Y.

AT ONCE, a good engraver, clock and jewelry repairer; steady position to a good man. Address "J., 6367," care Jewelers' Circular-Weekly.

WANTED, A WATCHMAKER; permanent position; address with references; state wages. "R., 6442," care Jewelers' Circular-Weekly.

WANTED, AT ONCE, man to repair clocks and watches; state price and what you can do, in first letter. H. H. Caswell, Asbury Park, N. J.

WANTED, a first class refracting and manufacturing optician to go south. Apply to "L., care Gorham Mfg. Co., 23 Maiden Lane, New York.

WANTED, a young lady thoroughly experienced in the jewelry line, to take charge of travelers' samples. Fried Kaufman, 565 Broadway, New York.

WANTED, AT ONCE, a first class watchmaker, engraver and jeweler; good wages, and permanent position. Address "F. L. C., 387 Main St., Norfolk, Va.

WANTED, IMMEDIATELY, first class watchmaker; good, light, pleasant shop; fine class of work; permanent position. J. H. Sawyer, Bar Harbor, Maine.

WATCH REPAIRER, who is willing to act as salesman in retail store in Maine; salary, \$25 a week. Address "Portland, 6511," care Jewelers' Circular-Weekly.

WANTED, AT ONCE, a watchmaker and engraver; permanent position for a good man send reference with application. J. W. Jones Mt. Sterling, Ky.

WANTED, diamond mounters and setters, also jobbing jewelers; permanent positions; good wages. E. Maritz Jewelry Mfg. Co., 217 N. 6th St., St. Louis, Mo.

WANTED, a fine engraver and good optician; permanent position; send sample of engraving and reference; salary \$25 per week. Edwards, LeBron, Chattanooga, Tenn.

WANTED, an experienced salesman by retail jeweler on Fifth Ave., New York; state experience and salary expected. Address "Jeweler, 6438," care Jewelers' Circular-Weekly.

AT ONCE, a good young man for clock and jewelry repairing and take care of stock; reference required; New England. Address "S., 6457," care Jewelers' Circular-Weekly.

WANTED WATCHMAKER; plain engraver preferred; permanent position; state experience a ability and give references. J. Hervey Dear, 115 Park Ave., Plainfield, N. J.

WANTED, AT ONCE, experienced watchmaker and engraver; permanent position; will pay good salary; send sample of engraving and references. Burt Ramsay, Cleveland, O.

WANTED, a first class watchmaker; one who engrave preferred; write fully, giving age, experience, references and, if engraver, send sample. Edward Vail & Co., Wichita, Kans.

WANTED, an experienced young man to take charge of diamond department in large retail store; out of town; good salary. Address "Retail, 6440," care Jewelers' Circular-Weekly.

FIRST CLASS WATCHMAKER, all around jeweler; good engraver; rapid workman; send sample; must have tools and good reference; steady position to right man. Dr. Parmenter, Norwalk, Me.

WATCHMAKER, must be good salesman; permanent position; good salary for right man; Florida; inquire 12 o'clock noon, every day a week. Jules Aschheim, 37 Maiden Lane, New York.

WANTED, a first class jewelry repairer; good wages and steady work guaranteed to the right man; none but steady, sober men need apply. Address "W., 6405," care Jewelers' Circular-Weekly.

WATCHMAKER and engraver, with set of tools wanted in the State of Maine; good salary; steady position for the right man; apply by letter or in person. P. Katz & Co., 51 Maiden Lane, New York.

WANTED, assistant manager; large wholesale house in middle west; young man preferred; chance for advancement; watches, diamonds, jewelry, etc. "Chance, 6426," care Jewelers' Circular-Weekly.

WANTED, competent watchmaker on Swiss American watches, fair jeweler and plain graver; salary, \$21 per week; references; tools required. Samuel Phillips, 485-487 Ada St., Stamford, Conn.

A FIRST CLASS ENGRAVER; one who can do all kinds of lettering and monogram engraving can use a good steady man at a good salary. Apply to A. Newsalt, Jeweler, cor. Fourth and Main Sts., Dayton, O.

WANTED, WATCHMAKER and engraver, must be competent and willing; pleasant and permanent position in a fine New England store; salary expected. Address "H., 6443," care Jewelers' Circular-Weekly.

FIRST CLASS watchmaker and optician want good opportunity offered to right party; steady position; in one of the large cities in Pennsylvania; write at once. L. W. Rubenstein, 4 Maiden Lane, New York.

WATCHMAKER, engraver and optician, first class watchmaker only; must be first class man; good salary and permanent position to right party; Greater New York. Address "J., 6514," care Jewelers' Circular-Weekly.

**HELP WANTED.—Continued.**

**EXPERIENCED** cut glass salesman, with an established trade; guaranteed salary to attract; reference required from last employers; see full particulars. Address "Cut Glass, 6412," care Jewelers' Circular-Weekly.

**WANTED**, first class diamond, precious and imitation stone salesman for southern and western territory, right position for right man; apply by letter, stating experience. Address "Confidential, 655," care Jewelers' Circular-Weekly.

**WANTED**, watch and clockmaker; must be good worker and lathe hand; good chance to improve; an about 22 preferred; steady job to right man; state wages expected and send reference. Ramsey, 1221 F St. N. W., Washington, D. C.

**WANTED** for middle west, salesman with established trade. Adolph Goldsmith & Son, 68 Nassau St., New York.

**WANTED** competent bookkeeper, understanding jewelry business. Address "American, 6441," care Jewelers' Circular-Weekly.

**WANTED JEWELER**; permanent position; state reference, ability, age and salary in first letter. Wm. Schweigert & Co., Augusta, Ga.

**WANTED**, a first class all around jeweler, one who is capable of doing first class repairing and making new goods, also can do plain engraving; wages, \$30 per week; steady position; unless you in a quality don't answer. E. F. Mayer, Butte, Mont.

**JEWELER**, immediately, experienced clock and jewelry repairer, salesman and assistant watchmaker; good workman; permanent; near Boston, give full experience, references and ages. Address C. E. H., Box 5256, Boston, Mass.

**SALESMAN** wanted by manufacturer of high grade line of 10-K, and 14-K, jewelry, for jobbers and department store trade, or a good man with capital who wants to interest himself in business. "S., 6513," care Jewelers' Circular-Weekly.

**WATCH** and jewelry salesman of experience wanted, in large New York retail store; bright young man preferred; state full particulars in application, also weekly salary wanted. Address L. J. W., 6310," care Jewelers' Circular-Weekly.

**WANTED**, a first class, competent, experienced and capable retail jewelry salesman; southern man preferred; when making application please state experience, give reference and salary wanted. Apply to the J. J. Sweeney Jewelry Co., Houston, Tex.

**WANTED**, first class watchmaker and engraver; send sample of engraving and references in first letter, stating salary wanted; give age and experience; steady employment and good wages to right man. Address Henry Iversen & Co., Corsicana, Tex.

**WANTED**, thoroughly competent diamond salesman who has practical knowledge of precious stones, and some experience in New York City jewelry stores; apply with full data, stating salary wanted. "N. Y. Z., 6509," care Jewelers' Circular-Weekly.

**WANTED**, WATCHMAKER, engraver and salesman; is there a good all around man ready to accept permanent position in southern New York, hours, 8 to 6; state wages, age, experience, reference, and all particulars, etc. "D., 6478," care Jewelers' Circular-Weekly.

**HIGH GRADE SALESMAN** for well known line of mountings; eastern and middle states. Address, "Eastern, 6480," care Jewelers' Circular-Weekly.

**TRAVELER** with large following in eastern and middle states; splendid opportunity for efficient man. Apply to Jonas Koch, 37 Maiden Lane, New York.

**WANTED**, competent man to take charge of diamond department in large establishment in flourishing southern city; must be experienced and have first class reference; salary, \$1,800 per annum, with good prospects for advancement. "Diamond, 6450," care Jewelers' Circular-Weekly.

**WANTED**, a good engraver on all general work; must do fine script and monogram work of all kinds; do all hard and soft soldering and general jewelry work, repair clocks and do window trimming; don't particularly care for a watchmaker; correspond at once. Austin & Prescott, Main St., Batavia, N. Y.

**WANTED**, strictly first class combination man (watchmaker, jeweler and engraver); must be sober and well recommended; good salary and permanent position to good man; must be a willing worker, rapid and very thorough; state salary expected and send sample engraving first letter. Thos. Van Auken & Co., 516 Pearl St., Beaumont, Tex.

**REPRESENTATIVE**; an important Swiss watch factory wants an active, serious and honest representative in the United States. Address Offer with particulars to Case Postale, 4398, Chaux de Fonds, Switzerland.

**SALESMAN** acquainted with best trade in New York City and Brooklyn to handle well known and advertised line of mountings as side line, on commission. Address, "Mountings, 6413," care Jewelers' Circular-Weekly.

**SALESMAN** for New York City and vicinity, wanted by well known manufacturer of 10k. gold jewelry; sample stock; must have acquaintance with jewelry and department stores; no objection to good man representing another line; all replies confidential. "Gold, 6418," care Jewelers' Circular-Weekly.

**AN OPPORTUNITY** to represent a leading manufacturer on the road, will be created for a young man with a knowledge of the jewelry business; must be of pleasing address and appearance, aggressive, naturally a good salesman and have best of reference. Address "L. K. T., 6502," care Jewelers' Circular-Weekly.

**Side Lines Wanted.**

**TRAVELER**, going south, will take side line of gold rings or silver novelties on commission basis. "D., 6491," care Jewelers' Circular-Weekly.

**WANTED**, agencies for lines, diamond mountings, emblem goods and other leading jewelry lines; well known west of Missouri River; first class references. S. H. Friend, San Mateo, Cal.

**JEWELRY SALESMAN**, now selling the best city trade; would like to take another line in the Fall or sooner; can show good reason for changing, and would prefer 14-K, line on either salary or commission. "W., 6500," care Jewelers' Circular-Weekly.

**WANTED**, by the undersigned, line of high grade goods or diamond goods for highest class retail trade of Chicago and outlying towns, on commission; will guarantee results; bank and commercial references. Elmer A. Rich, Room 803, 103 State St., Chicago, Ill.

**Business Opportunities.**

**OPTICAL** and jewelry business for sale; dairy section of central Minnesota; splendid opportunity for competent optometrist. "Minn., 6438," care Jewelers' Circular-Weekly.

**FOR SALE**, well established jewelry store on Third Ave., New York; good, steady repair trade; retiring on account of illness. S. Goldschmidt, 259 Third Ave., New York.

**OLD ESTABLISHED** jewelry and optical business in a growing town of 1,600; western New York; inventory about \$2,000. Address "Opportunity, 6465," care Jewelers' Circular-Weekly.

**FOR SALE**, jewelry business with good repair trade, in Jersey town of over 6,000; stock and fixtures invoice \$1,800; cash price, \$1,200. Address "Cash, 6481," care Jewelers' Circular-Weekly.

**PARTNER WANTED**, man about 30, who is well acquainted with the jewelry trade and can invest about \$5,000 in an old established manufacturing jewelry concern of A1 reputation. Address "Maiden Lane, 6228," care Jewelers' Circular-Weekly.

**FOR SALE**, a well established jewelry store in western Pennsylvania; a good mining town of 5,000 population; repairs average \$150 a month; will reduce stock to \$1,000; present stock, \$5,000. Address "Opportunity, 6469," care Jewelers' Circular-Weekly.

**\$7,000** will purchase an interest in a retail jewelry business; established, well and favorably known; located in one of the most prosperous cities of 200,000 inhabitants in the United States. Address "Pare Opportunity, 6341," care Jewelers' Circular-Weekly.

**FOR SALE** in Norfolk, Va., to settle an estate, the business of the Harris Jewelry Co.; situated in the most desirable location of the city, an unusual opportunity to purchase a prosperous business. Address R. Harris & Co., 7th and D Sts., N. W., Washington, D. C.

**CASH PAID** for entire jewelry stores and stocks; send us your surplus stock, and we will send you a check by return mail; if our offer is unsatisfactory we return your goods; we act quickly and strictly confidential. Jos. Brown & Co., Fifth Ave. and Madison St., Chicago, Ill.

**DO YOU WISH TO RETIRE?** We buy jewelry stores to any amount; also entire stocks of jewelry, diamonds, watches, silverware, fixtures, etc.; we are known all over the United States to pay highest spot cash; notify us, we will call on you at once; all business transacted we handle strictly confidential. Address Brooklyn Purchasing Syndicate, 608 Broadway, Brooklyn, N. Y., or Tel. 2328, Williamsburg.

**For Sale.**

**TWO VERY FINE** Scott show cases, 11 feet long, with tables to match, 22 inches wide, cost \$300; \$135; all plate glass. Room 1002, 71 Nassau St., New York.

**FOR SALE**, at 50 cents on the dollar, 40 ruby velvet trays, for watches, rings, chains, lockets and plain, to stock, all or part. Room 605, 92 William St., New York.

**FOR SALE, CHEAP**, one pair Mossburg rolls, 8 x 12 inches; one Reichhelm hlower, and other machinery; send for list. W. H. King, 25 Camfield St., Newark, N. J.

**FOR SALE**, at a bargain, 7/8-1/64 carat white stone, set in Gypsy 14-K setting, \$114; cost \$130, 30 days ago; also, a few 1/2 to 1 1/4 carat stones, set in rings, at bargains; sent on memo. to well rated jewelers with the understanding you report at once and send cash for what you keep. Dan. I. Murray, Broker, 3 Maiden Lane, New York.

**To Let.**

**DESK ROOM** or part of office to let. 3 Maiden Lane, Room 53, New York.

**WATCHMAKER** can have fine bench room and work. Room 103, 1 Maiden Lane, New York.

**TO LET**, shop room, for setter or engraver. Inquire Room 8, 20 Maiden Lane, New York.

**BENCH** and desk room to let; very light. Isidor Stern, Diamond Setter, 51 Maiden Lane, New York.

**TO LET**, part of an exceptionally desirable office, with fine north light; opportunity for precious stone business or manufacturer's agent. Room 48, Lorsch Bldg., 37 Maiden Lane, New York.

## The Aristocrat of all 10K. Lines.

HOW often we hear the jewelers say something like this: "You certainly do know how to make your line look like fine 14K. goods. There has been room for just such a 10K. line for a long time."

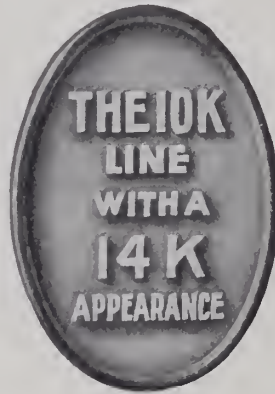

*Knowles*

Camp and Orchard Streets Newark, New Jersey

## Special Notices.

(Continued from page 75.)

### TO LET.—Continued.

WILL RENT to desirable party, desk room with office privileges, in light, attractive office; manufacturer's representative or diamond dealer preferred. "Maiden Lane, 6368," care Jewels' Circular-Weekly.

MEDIUM SIZED, light office for salesroom building at 7 Maiden Lane, New York, fourth floor; reasonable rent to manufacturer or dealer in jewelry. Call or address "W. H. H.," R. 44, 7 Maiden Lane, N. Y.

AN EXCELLENT OPPORTUNITY to secure corner store in new building at Syracuse, N. Y. especially adapted for retail jewelry business has frontage of 42 feet and depth of 35 feet; give less room if required. For particulars, address to Wellington W. Tabor, Syracuse, N. Y.

### Wanted to Purchase.

STREET CLOCK (post) wanted for cash. See particulars to Harris & Schuster, 9 Maiden Lane, New York.

WANTED, TO PURCHASE, second hand telescopes, must be in good condition. He Fein & Co., 49 Maiden Lane, New York

TWO OR THREE show cases and one or two wall cases wanted; must be in good condition. Harris & Schuster, 9 Maiden Lane, New York

WANTED TO BUY office fixtures, etc., in near Maiden Lane, New York; small room which rent is reasonable and will not be advanced within a year, or would buy out small jobber or porter for spot cash; tell me in confidence what you have to offer. Address "Broker, 6419," Jewels' Circular-Weekly.

WANTED safe of standard make; fire and burglar proof; no drawers or partitions required; inside dimensions not over 60 inches high, 50 inches wide, 18 inches deep; state lowest cash price. Address, "Safes, 6495," care Jewels' Circular-Weekly.

### Miscellaneous.

SOMETHING entirely new in the line of window decoration; send five two-cent stamps for sample and postage. Address The Window Exhibitor Co., 74 Cortlandt St., New York

WANTED catalogs of machinery, suitable for badge manufacturing. Adams, 40 Pine St., Rensselaer, N. Y.

### TO LET.

#### Three Desirable Light Loft

At 31 MAIDEN LANE, N. Y.,

One door from Nassau St. Prominent location, center of jewelry district. Address F. J. White, 130 Broadway, New York; or, your own broker.

#### Summer Residence for Rent

at Montclair, N. J.; beautifully situated, contains 11 rooms and 2 bathrooms; handsomely furnished also use of team of fine horses, 3 carriages, coachman, etc.; unusual opportunity for desirable party. Address "6366," care Jewels' Circular Weekly

THE ONLY BOOK OF THE KIND  
EVER PUBLISHED.

AN  
**ENCYCLOPEDIA-DICTIONARY**  
AND  
**REFERENCE HANDBOOK**  
OF THE  
**OPHTHALMIC SCIENCES.**

Designed to Give, in Complete and Accurate Statement, and in the Readiest Form for Popular Use the Orthography, Pronunciation, Meaning and Etymology of All the Words and Terms Used in the Ophthalmic Sciences.

And in Addition to Give in Didactic Form a Complete Treatise on Such Subjects as Demand a Wider and More Elaborate Treatment.

By **R. H. KNOWLES, M. D.**

**PRICE \$2.50**  
IN SUBSTANTIAL CLOTH BINDING.

PUBLISHED BY  
**THE JEWELERS' CIRCULAR  
PUBLISHING CO.,**  
11 John St., cor. Broadway, New York.

INDISPENSABLE TO OPTICIANS.

**WORKSHOP NOTES**  
(Third Edition)  
For Jewelers and Watchmakers.

A collection of the latest practical receipts on the manufacture and repairing of watches, clocks and jewelry.	Price, <b>\$2.50</b>	300 pages (size 7½x 10¼ inches), bound in cloth, stiff covers. Should be on every workbench.
--	-------------------------	--

Published by  
**THE JEWELERS' CIRCULAR  
PUBLISHING CO.,**  
11 John St., Cor. Broadway, New York.

**"PRACTICAL COURSE  
IN  
ADJUSTING."**  
PRICE \$2.50.  
ALL JOBBERS OR  
**JEWELERS' CIRCULAR PUBLISHING CO.**



## Buffalo, N. Y.

### TRADE CONDITIONS.

Buffalo jewelers say that there has been a pronounced renewal of trade activity in the last two weeks. That the early Spring trade was disappointing to some is conceded, and the awakening has been most gratifying. The change came with nothing of a rush.

Mrs. Frank Hammond, wife of the jeweler at 54 Seneca St., is the guest of her daughter in St. Louis, Mo.

P. T. Martin, optician at 620 Walden St., in a few days will take charge of Chas. F. Damm's optical department.

George E. Dehas, for several years with F. Chouffet, has taken charge of Chas. F. Damm's salesroom, 520 Main St.

S. Dreyfus & Co. have moved from 511 Washington St. to the Mutual building, in Carl St. They now occupy very handsome quarters.

E. Hazarel, head salesman with C. F. Chouffet, 379 Main St., rejoices over the arrival of a boy baby, last week, his first child.

A. E. Sipe, diamond importer, 8 Mooney Building, has begun his 15 per cent. annual discount sale, preparatory to leaving for his yearly trip to Europe.

Edward Arnold, for several years in the employ of Chas. F. Damm, has been made foreman of the factory, as a reward for his industry and efficient services.

Ralph W. Bixby, son of F. G. Bixby, watch adjuster, has gone to Cleveland, O., where he is employed in the department of publicity of the Sherwin-Williams Co.

Richard C. Landers has left the employ of Peterson & Co., Genesee St. retailers, and has gone with Sirret & Svensson, retailers, 116 Franklin St., taking charge of their watch repairing work.

James P. Matson, who for several years was a manufacturing jeweler at 444 Main St., has discontinued his factory and has accepted employment with Heintz Bros., wholesale jewelers at Swan and Ellicott Sts.

Fred Elsheimer, for a number of years in charge of the repair department of Fred T. In's jewelry store at 87 E. Genesee St., has taken charge of the watch adjusting department of the T. & E. Dickinson & Co.'s store, 472 Main St.

Buehl Bros., who have been selling the Philip Fischer bankrupt stock at public auction in Main St., have nearly completed their task. They will soon put the W. Z. J. den stock on sale, and if it goes too slowly they will sell it at auction in some other city.

Walter Harrington pleaded guilty before Justice Kenefick, last Wednesday, to the charge of stealing a tray of diamonds worth \$100 from Mrs. Paul Foerster, in her husband's store, at 134 Seneca St. Sentence has not been pronounced. Harrington was arrested in New Orleans. He has given the names of his accomplices.

Last evening the marriage of Julius Boasberg, of the firm of H. & J. Boasberg, 384 Main St., pawnbrokers and jewelers, and Miss Leonore Gerodzinsky, of this city, took place in the Colonial in Lafayette Ave., the Rev. Dr. Aaron, rabbi of Temple Beth Zion, officiating. Charles Folk was best man and Miss Flora Boasberg, niece of the bride-

groom, was bridesmaid. Mr. and Mrs. Boasberg left soon after the ceremony was performed for Brighton Beach, where they will reside. The bridegroom is in charge of the firm's branch store at 1358 Broadway, New York City.

## Pittsburg.

The auction which was in force at 818 Liberty Ave., has closed.

Otto Heeren, of Heeren Bros. & Co., recently returned from a two months' European trip.

W. J. Johnston, of the W. J. Johnston Co., who has been in Washington on business, has returned to Pittsburg.

M. L. R. Howard, who has opened a store at Salem, O., bought his first bill of goods from West, White & Christy.

J. Loughrey Roberts, of the J. M. Roberts & Son Co., who has been at Atlantic City for the benefit of his health, has returned to Pittsburg greatly improved.

J. R. Reed & Co. will, in a week, begin the semi-annual inspection of watches of all trainmen employed on the Pennsylvania lines west. Several thousand watches will be examined.

Chas. S. Untermeyer, of Chas. Keller & Co., New York, is reported to have narrowly escaped injury several days ago, while riding in an automobile from Brad-dock to Pittsburg. The axle of the machine broke about the time he reached his destination.

The following out-of-town merchants last week called on the local trade: A. Katzenmeyer, Burgettstown; H. R. Barney, East Liverpool; Frank Worrell, Canonsburg; J. Linnenbrink, Rochester; W. E. Johnston, Canonsburg; P. J. Manson, Jeanette; Frank Murdock, Ligonier; Henry Zilliken, Wellsburg.

A new wholesale house is to be incorporated in Pittsburg, to be known probably as the Marsh, Brown & Mather Co., absorbing the firm of Marsh, Brown & Mather, which has quarters in the Bessemer building, 6th St. and Duquesne Way. W. O. Harrison, who for the last 12 years has been associated with the George B. Barrett Co., will be the new partner in the company. He will sever his connection with the Barrett concern Aug. 1, at which time he becomes a member of the new corporation.

Some of the local jewelers are agitating the holding of a jeweler's picnic in the near future. The plan has been suggested to THE CIRCULAR-WEEKLY correspondent by several who desire some one to take hold of the idea and push it to a successful conclusion. It has been a generation or two since the jewelers of Pittsburg have enjoyed a jollification among themselves. It is admitted on all sides that the local jewelers are not as fraternal as they should be.

M. A. Mead & Co., with quarters in the Farmer's Bank building, are represented on the Merchants and Manufacturers' sixth trade extension tour, which is this week invading northeastern Ohio and northwestern Pennsylvania. The tour began last Monday and will end Friday night. About 100 merchants are traveling in a special train. The following towns are being visited: Alliance, Ashtabula, Canton, Conneaut, Erie, Kent, Leetonia, Mansfield, Massillon, Niles, Rav-

enna, Salem, Warren, Wooster and Youngstown. These tours, it is estimated, have brought back to Pittsburg orders aggregating \$600,000 a trip.

J. Alexander Hardy, of the Hardy & Hayes Co., has again invested heavily in real estate, buying the lot adjoining the Penn building in Penn Ave., to the east of that structure. He organized a syndicate which bought properties through to Liberty Ave., Mr. Hardy taking the Penn Ave. lot on which there is a small building, in order to protect the Penn building, which he also owns. His new purchase is a lot 20 feet wide and 240 feet deep. The properties in question cost \$350,000. The value of Mr. Hardy's downtown real estate holdings now approximate, so it is said, close to \$1,000,000.

## New Orleans, La.

Edward Claudel has succeeded to the business of E. & L. Claudel, 121 Carondelet St.

L. Fishel, the veteran Canal St. jeweler, will move about September next to 129 Carondelet St. Mr. Fishel has been in the business in New Orleans for the past 35 years.

Louis Moss, the Carondelet St. jeweler and diamond setter, who embezzled over \$1,000 worth of jewels from Wm. Frantz & Co., and whose plea of guilty of larceny was accepted by the District-Attorney, has been sentenced to serve one year at hard labor in the State penitentiary.

Mayor Martin Behrman, of New Orleans, has accepted the position of chairman of the large committee named to solicit funds for the purchase of a silver service for the battleship *Louisiana*. Thomas G. Rapier, manager of the *Picayune*, and A. R. Blakely have been named vice-chairmen, and the work will be pushed forward vigorously. Mayor Behrman has decided upon \$10,000 as the price to be paid for the service, and the general committee has agreed that the service should in some way be identified with the State in a manner that would be most emphatic. With that end in view, Mayor Behrman will suggest that each parish appropriate \$100 to be put into an article connected with the set. For instance, the smaller parishes, according to the plan, will purchase the goblets, and each goblet will bear the name of the parish donating the money; towns like Shreveport, Baton Rouge, Monroe and Lake Charles will pay for the fruit baskets, the ladels, trays, etc., and New Orleans will undertake to collect enough to buy the punch bowl. The committee also determined that the contract should be given to a Louisiana firm of silversmiths or jewelers, and in a short time the firms will be asked to present designs.

A valuable optical invention is reported by Councilor-General W. Ruhlee, of Vienna, who states that a Hungarian chemist after several years of experiments, has produced a fluid optical lens of great power, which can be made cheaply. A fluid substance is enclosed between two thin crystals overcoming certain defects of optical lenses.



## String Pearls

DAME FASHION DICTATES  
STRING PEARLS

Our stock is complete.  
Prices range from

30c. to \$25.00 per String

Selection packages sent on request.

## Rhinestone Combs

New, Artistic and Exclusive  
Parisian Designs

\$18 to \$84 per dozen

# CHOPARD FRÈRES

MAKERS OF ART JEWELRY NOVELTIES.

49 Maiden Lane - - - NEW YORK

FACTORY: 35 Rue Des Trois Bornes, PARIS, FRANCE.



*"Ebonoid"*  
TRADE MARK

IS SO WELL KNOWN that it requires little comment. Neither heat nor moisture will affect it, and its beautiful ivory black finish is indestructible, making it as handsome and serviceable as ebony, at one-fifth the cost. "EBONOID" trimmed with silver creates a most striking contrast. Our trimming is of the best white metal, quadruple plate, and will wear a lifetime. Ask your jobber to



show you our new line of **Stelns, Loving Cups, Shaving Mugs and Brushes, Vases, Claret Pitchers, Smokers' Sets, etc.**, and don't fail to send to-day for our illustrated circular showing our new designs.

**J. C. DOWD & CO.** 524 @ 528 Broadway  
NEW YORK

**Eliassof Bros. & Co.**

IMPORTERS  
AND  
JOBBER'S OF

**DIAMONDS  
WATCHES  
JEWELRY**

9-11-13 MAIDEN LANE,  
NEW YORK.

100 STATE STREET,  
ALBANY, N.Y.



A LARGE ASSORTMENT OF DIAMOND  
MOUNTED JEWELRY CARRIED IN STOCK.

# QUALITY COUNTS

The Increasing Sale of - - - TAVANNES WATCHES

Proves their worth as timekeepers

FULLY GUARANTEED

For sale through the jobbing trade

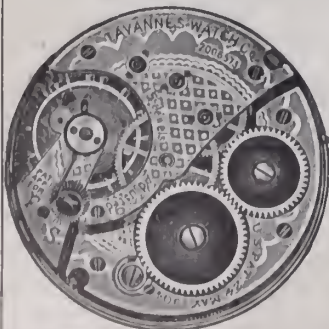

**TAVANNES WATCH CO.,**  
2 & 4 Maiden Lane, New York.

## Cincinnati.

William Owen, Elm St., will go south this week.

Dave Kaufman, of O. E. Weidlich & Co., in New York on business.

The Saturday afternoon closing among jewelers of Cincinnati began June 2.

Arno Dorst, of the Dorst Co., is home again after a two weeks' vacation in South Carolina.

Edward Elsbach, manager for Hahn & Openheimer, is ill with an attack of typhoid fever.

Hugo Lindenberg, of Lindenberg & Fox, started on a fishing trip to Lake Nevea, Wis.

The six-year-old son of J. C. Miller, of Miller Jewelry Co., is reported as very ill with typhoid fever.

A. A. Spiegel, of the Gustave Fox Co., returned from a very successful and extended business trip.

S. Lindenberg, of Lindenberg, Strauss & Co., with his wife, left June 3 for a stay in New York and the east.

N. T. Arnold, Owensboro, Ky., purchased fixtures and stock here last week for a new store into which he has moved.

The Plaut Jewelry Co. has moved from its old location on W. 5th St. to the second floor in the Neave building at 4th and Race Sts.

Mr. Bentel, Sr., of the Bentel Bros. Co., Hamilton, O., was here last week on his return from visiting his daughter in Chillicothe, O.

Elizah Steitler, Owensboro, Ky., has purchased the William L. Coppersmith stock and will start in the retail jewelry business at that place.

D. A. Pless, Morristown, Tenn., after a long illness, was in town last week. He is getting ready to again call on his southern trade.

S. D. Parker, formerly with A. J. Clark, Parkersville, Tenn., stated to Cincinnati friends last week that he is now with Geo. Calhoun & Co., Nashville, Tenn.

Joseph Noterman, of Joseph Noterman & Co., and E. M. H. Croninger have returned from Paris, Ky., where they attended the Kentucky annual conclave of the Knights Templar.

Edward Mittendorf, manager for E. & J. Wigart, with his wife, and Albert Sauer, Newport, Ky., with his wife, will spend a few weeks in the east visiting various points of interest.

The marriage of Miss Laura E. Duhme, daughter of Herman Duhme, Jr., formerly of Duhme Bros., to F. W. Stevenson, of Cincinnati, took place yesterday at the bride's home in Wyoming.

Lee Kahn, of Lindenberg & Fox, and wife have gone to Atlantic City and New York for a three weeks' stay. C. B. Goldsmith, of this house, with his wife, leaves for a vacation at Petoskey, Mich.

George Newstedt has contracted for a very fine three-dial street clock, which will be built at the corner in front of his store. It will be the only one of its kind in the city and will be a fine piece of workmanship. Jacob Frohman, of Frohman & Co., and Gradison, 20 Emery Arcade, have left for a 10 days' stay at French Lick Springs, Ind. B. S. Newman, of the above firm, and

wife are taking a six weeks' trip among the eastern cities.

A handsome silver loving cup made by Theo. Neuhaus & Co., will be presented by ex-Mayor Julius Fleishman to the prize winner at the Latonia races, June 15, as the Cincinnati Trophy Stakes of the Latonia Jockey Club.

R. J. Timmerman and John Kappes, Batesville, Ind., were here last week prior to Mr. Timmerman's departure on a hunting expedition in Arkansas. Mr. Kappes will conduct the Timmerman business during the latter's absence.

Out-of-town dealers who were here last week buying stock, and not elsewhere mentioned, included: H. G. Knoeke, with Victor Bogaert, Lexington, Ky.; A. Clooney, Maysville, Ky.; Harry Cohen, Indianapolis, Ind.; A. J. Winters, Paris, Ky.; Walter Bentel, Hamilton, O.

Friends in this city received word from Minneapolis last week of the death of Mrs. Herman Duhme, widow of the late Herman Duhme, a former well-known member of the trade. Mrs. Duhme was 72 years of age and was the second wife of the jeweler. She is survived by one son, Albert G. Duhme, of Cincinnati, and two daughters, Mrs. Eustis, of Minneapolis, and Mrs. Ives, of Cincinnati. Frank and Herman Duhme, Jr., of Cincinnati were her stepsons. The remains were brought here and interred in Spring Grove Cemetery.

## Philadelphia.

The Avis Cut Glass Co., Avis, Pa., was incorporated last week with a capital of \$5,000.

A Sheppard, watchmaker, has taken a position with F. X. Lieberman, 3525 N. 5th St.

Sol. Sickles, of M. Sickles & Sons, returned last week from a pleasure trip to the Pacific Coast.

Abe Sickles, of M. Sickles & Sons, returned home recently on the *Deutschland* from a purchasing trip abroad.

J. B. Bechtel, of J. B. Bechtel & Co., last week leased for the Summer a handsome country place at Perkasio, Bucks County, Pa.

Lou. Sickles, of M. Sickles & Sons, has abandoned the seashore for the country. He has taken a house at Bala for the Summer.

The International Silver Co. instituted suit in the local courts last week against the Spiro Soap Co., to recover on a contract.

Retailers in town during the week included: L. L. Bickings, Norristown; David Krause, North Wales, Pa.; H. S. Kratz, Souderton, Pa.

William Cavanaugh and Herman Neiegele, jewelers, were last week appointed to serve on the June Grand Jury of the Criminal Court.

J. J. Zimmern, southern representative of M. Sickles & Sons, starts to-day on a trip through the south, going to Savannah on the steamship *Berkshire*.

Andrew Brown, 740 Sansom St., was one of the delegates last week to the Lincoln Party State Convention, which nominated Lewis Emery, Jr., for Governor.

John Ernst, watchmaker, lately with F. L. Shaw, Camden, N. J., has started as a

watchmaker for the trade with Ferdinand Dilshheimer & Co., 710 Chestnut St.

J. E. Caldwell & Co. have been awarded the contract for the prizes for the West Jersey Horse Show Association to be held this week at the Camden Country Club.

Joseph H. Brazier, formerly active in the firm of J. E. Caldwell & Co., left recently with his family to spend the Summer at their country home, Kennebunkport, Me.

Joseph T. Bailey and Charles W. Bailey, president and vice-president, respectively, of the Bailey, Banks & Biddle Co., have opened their cottage at Newport for the Summer.

J. E. Caldwell & Co. received the contract last week for a handsome silver service of exclusive design presented to William S. Hilles, city editor of the *Bulletin*, on the occasion of his marriage.

The Board of Governors of the Jewelers' Club met last week to complete arrangements for the field day and annual Summer outing, to be given in the latter part of this month at a Delaware river resort.

John F. Simons, of Simons, Bro. & Co., was elected a director recently of the Manufacturers' Club, in which he has long been active. John Gordon Gray, of Queen & Co., opticians, was elected a vice-president.

The Koshland & Italic Co., manufacturing and wholesale jewelers, 7th and Chestnut Sts., have applied for articles of incorporation under the Pennsylvania State laws. The application is to be granted June 18. The incorporators are: Charles Koshland, Bernard Italic and George E. Donaldson, all of whom have been in the firm of Koshland & Italic and were previously with the old firm, Wm. Morris & Co., which they succeeded.

A large party of members of the Jewelers' Club participated in the opening recently of the "Ours Club" at Atlantic City, which is regarded as an auxiliary of the Jewelers' Club. Among those who went to the seashore to join in the festivities were: J. Warner Hutchins, Jacob Bender, Jr., John Brandt, Fritz Bloch, Joseph Cadwallader, A. J. Le Jambre, Jacob Alburger, L. Whitehead, J. Clifford Wilson, Charles Eisenlohr and about a score of others, all well known to the trade.

The plate glass window of M. D. Sanders' jewelry store, 713 South St., was smashed last week by a thief, and alarm clocks, spoons and other articles were stolen. The thief was captured before proceeding far and the goods recovered. He was identified as William McElroy, an old-time thief, and promptly sent to jail. While being taken out of the van he made a futile dash for liberty. The incarceration of McElroy, familiarly known to the police as "Old Dock," is a relief to jewelers, whom he almost invariably makes his victims.

L. P. White removed last week from 7th and Chestnut Sts. to the Burd building at 9th and Chestnut Sts. Mr. White now occupies the entire front portion of the second floor of the building, comprising three large airy rooms. In the old location the increasing volume of business crowded the establishment. In the new quarters Mr. White has the advantage of elevator service, a modern lighting and heating system and room for a larger stock which is to be handled, especially in clocks and watches. Three large new safes have been added.

Bigalke & Eckert Co.  
 IMPORTERS OF WATCHES,  
 No. 1 MAIDEN LANE, NEW YORK.

Single and Split Second Timers in Nickel and Gun Metal Cases.

Complete Assortment of Chronographs, Split Seconds and Minute Repeaters.

SOLE AGENTS FOR

Haus, Neveux & Cie.

FINE GENEVA WATCHES.

# Princess Alice Adjustable Bracelet



\$7.50 per Dozen



\$4.00 per Dozen



\$7.50 per Dozen

THE PRINCESS ALICE BRACELET is now ready in plain, signet and stone designs. These bracelets are having phenomenal run and if you have none of them in stock you should send for samples at once.

## OUR \$15.00 SAMPLE ASSORTMENT

is making a big hit all over the country, and it will pay you to get one. This assortment is sent on approval, express prepaid and if, on examination, the bracelets are not satisfactory, you may return all or a part of them at our expense. SEND FOR AN ASSORTMENT TO-DAY.

**C. H. EDEN COMPANY,**

New York Office,

-

699 Broadway.

ATTLEBORO  
 MASS.

## Pacific Coast Notes.

F. A. Marcher, of Los Angeles, Cal., has been visiting the trade in New Mexico. John Hood, a jeweler of Santa Rosa, Ill., has moved his store into new apartments in the Mailer building in that city.

J. H. Holcombe, formerly with Paul V. Arin, of Haywards, Cal., has left for Argentine Republic, where he expects to remain for a year.

J. R. Hicks, a jeweler of Silver City, N. M., has secured quarters in the new All Block, which will be ready for occupancy during the coming week. Mr. Hicks expects to be fully installed in the new store by the middle of June.

The Hofman Jewelry Co., Columbus, Ohio, have secured a controlling interest in several gem mines near Pala, San Diego county, Cal., including the Tourmaline Queen, Tourmaline King, Homestake and of whit Gem. O. S. Hofman and R. N. Whitford, president and vice-president of the company, have been in San Diego county in the interests of the company. Mr. Whitford is now on his way back to Columbus, but Mr. Hofman will remain permanently at San Diego.

The safe taken to Napa, Cal., from San Francisco, by Mr. Fairbrother, a few days ago, has been opened. It contained about \$300 worth of gold and silver watches, diamonds and gold rings, sets of cutlery, and other jewelry, all in the trays in the safe; also about \$65 in coin, several insurance policies and a "greenback." Mr. Fairbrother drilled holes in the outer doors of the safe and succeeded in opening it Saturday. The watches, chains, rings, etc., were somewhat damaged by the extreme heat, the smoke and steam.

## Rochester.

The following judgments were taken in Municipal Court recently by default: Don Danks vs. Jacob Athenuse, \$42.55; Don Danks vs. John Poloski, \$8; Durward Danks vs. Herman Gohn, \$22, and Malcolm I. Danks vs. Elmer Warren, \$10.80. Fire breaking out in the cigar store adjoining the store of E. E. Bausch & Son and the E. S. Ettenheimer & Co., last week, caused some uneasiness to these concerns for some time. The firemen got the flames under control in short order, however, and the only damage the two adjoining stores suffered was through the smoke which penetrated into both establishments.

Gloves, purses, watches, scarf pins, rings, shirt studs, brooches and many other articles of jewelry disappeared mysteriously from this city on Decoration Day during the celebration. One of the heaviest losers to the light fingered gentry was Charles Scheid, of the jewelry firm of Merkle & Scheid, on W. Main St., whose pocket was picked of a purse containing \$85 while he was watching the parade from a point in the vicinity of his store. How the theft was committed only the thief knows.

The Henry Oemish Co. is preparing to make some extensive alterations in its store at the corner of East Ave. and Main St., E. Arrangements have been practically completed whereby Mr. Oemish secures the use of the store adjoining on Main St., East and East Ave. The interior will be

completely rearranged, there will be new and modern fixtures installed, the entrances will be changed and the store remodeled so that it will, it is said, be one of the most modern and handsome in the city. Work will probably be started within a month or so.

## Baltimore.

William P. Jacobi, of Jacobi & Jenkins, has moved into his new country home, recently built near Lauraville.

Charles C. Stieff and Joseph Tate were appointed co-receivers with David Ambach for the J. W. Putts Co. last week by Judge Morris. Each gave a bond in \$50,000.

A. Wallenhorst has taken possession of his new store at 11 and 13 S. Gay St. The building stands on the site on which his store stood before the great fire of 1904.

Among the numerous packages of unclaimed freight at the claim warehouse of the Baltimore & Ohio Railroad, at Locust Point, was one containing 100 nickel watches. A few days ago a thief broke into the box and stole 18 of the watches. Hugo Reese has since been arrested.

The bronze trophy offered by the New York Clothing House as the prize for a marksmanship contest on the State Rifle Range in the week of Aug. 13, was ordered from the Hennegen, Bates Co. The bronze figure, called "Post Pugnans," is 35 inches high and represents a warrior sheathing his sword. It rests upon a mahogany base on which is a silver plate suitably inscribed.

Jacobi & Jenkins, silversmiths, 216 N. Charles St., are having their entire building remodeled. The salesroom on the first floor will be extended back to twice the size it occupies at present, and a newly designed store front will be introduced. The factory which formerly occupied the rear of the first floor has been moved upstairs to allow more room. All the old partitions are to be removed, so as to make the salesroom the more spacious, and to allow an abundant display. The offices will be in the rear on the left side. The stairway leading to the second floor will be reversed so the ascent will begin from the back instead of the middle of the room. New floorings are to be laid, both up and down stairs.

The official and souvenir badge of the National Credit Men's Association, whose convention will be held in Baltimore, June 13, 14 and 15, was made by the Hyatt Mfg. Co. The design is a unique and tasteful creation, and is of sterling silver. Beginning at the top it suggests the famous products of Maryland—the canvas-back ducks, terrapin, oysters and crabs—arranged in a clever manner surrounding the shield of Maryland which is also encircled by the name of the Association. Below this group is a sphere upheld by a female figure, symbolical of credit. Baltimore is prominently brought out on the map in raised letters. This female figure rests above a phoenix, indicating the new Baltimore rising from the ashes. The seal of the State is in colored enamel.

Thieves recently broke into the store of D. Girson & Co., 20 E. Park St., Butte, Mont., through a rear window, and stole seven watches and eight rings.

## Providence.

After a long sojourn at 109 Friendship St., the George B. Darling Lapidary Co. has now removed to 212 Union St.

The directors of the Chas. E. Hancock Co. held their annual meeting last week and L. H. Carpenter, the New York representative, was elected vice-president of the concern.

Among the buyers in town last week were J. D. Jacobs, of D. Jacobs & Co., Cincinnati; A. C. Becken, Chicago; Jesse Levy, Philadelphia; Mr. Rothchild, Chicago; Miss Mulcahey, Chicago.

The stock of the T. F. Greenwood Co. has been disposed of to Paul and Rinaldo Castiglioni and Joseph Capaldi. The new owners are president, treasurer and secretary, in the order given.

Councilman Parks, one of the local manufacturers, who occupies a responsible committee position in the Common Council, is taking an active part in the agitation now going on relative to city finances and the park problem.

A permit was issued last week to the Gorham Mfg. Co. for the erection of a two-story brick building to be used as a smelting shop. The structure will be 32.9 feet in height and will have a floor of reinforced concrete.

The Aldrich Battery, of which E. Merle Bixby, in charge of the silverware department at the Shepard Co.'s store, is Captain, is planning to have a reunion and dinner. This was an organization formed during the campaign a year ago.

A draft for a trifle over \$3,100 has been forwarded to the Jewelers' and Silversmiths' Relief Association of San Francisco by Treasurer Holmes, of the New England Manufacturing Jewelers' and Silversmiths' Association. Shreve & Co. will see that the money is turned over to the proper parties.

The spoon and die departments of the Gorham Mfg. Co. held their annual Summer outing at the Warwick Club, Saturday. About 100 participated, and a most enjoyable time was had. There was a series of sports, and this was followed by a ball game which proved one of the features of the occasion. A Rhode Island clam dinner was served.

It is probable that on the date of the annual outing of the New England Manufacturing Jewelers and Silversmiths' Association, June 22 there will be an innovation in the form of a baseball game between nines representing the Attleboro and this city. Some of the jewelers are by no means strangers to the ball field, and many of those who do not play themselves are active "fans." Invitations for the contest have already been issued.

In the District Court last week Alfred Alexander, said to hail from Boston, entered a plea of not guilty to a charge of William O. Clark, a manufacturing jeweler, that the prisoner had stolen \$300. Mr. Clark claimed that while riding in a hack between Warwick Road and Lenox in company with Alexander and others three \$100 bills had disappeared from his clothes, and he accused the prisoner for taking them. Alexander was held in \$1,000 bail.

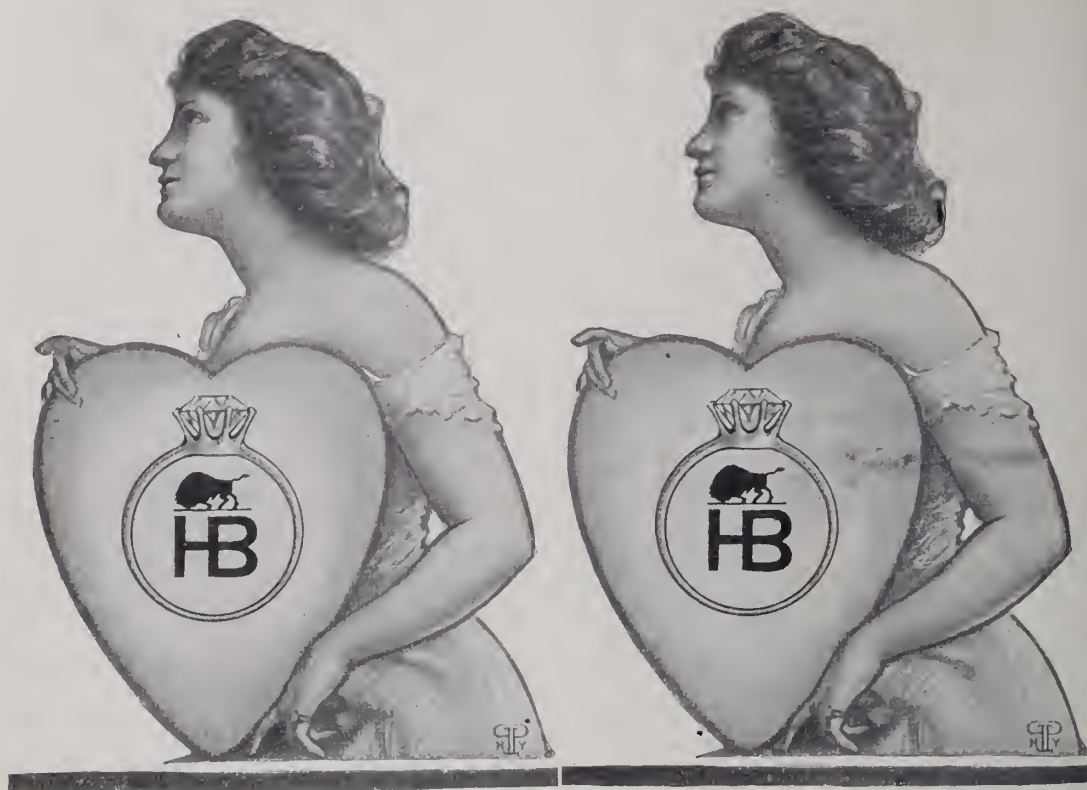

## FOR FALL TRADE

June furnishes the first opportunity for “looking backward” on the year’s progress and planning the Fall Campaign. The progressive Retailer realizing the value of **HB** rings will not hesitate when making his selection for the new season.

Our Fall line is more complete than ever before and the beauty and variety of designs combine to make an attractive and salable product.

Memorandum selection sent to responsible concerns

**HEINTZ BROTHERS, Buffalo, N. Y.**

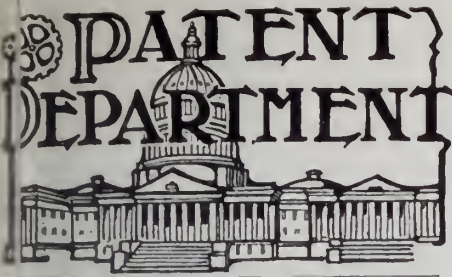

WHICH IS CONTAINED A LIST OF THE LATEST PATENTS GRANTED BY THE UNITED STATES AND GREAT BRITAIN, THE UNITED STATES PATENTS THAT HAVE EXPIRED AND THE REGISTERED TRADE-MARKS.]

**BRITISH PATENTS.**

ABSTRACTS OF SPECIFICATIONS, 1905, FROM *The Illustrated Official Journal.*

ISSUE OF MAY 16, 1906

23. **NECKTIE, ETC., FASTENINGS.** A. SCHWABER, Hanover, Germany. Jan. 16. *Necktie-Retainers, Sleeve-Links, Flower Pins, Button-hole, Jewelry Fastenings.*—Relates a stud with a gripping-device in the head for

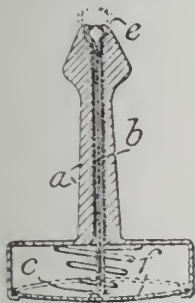

purpose of retaining neckties, etc., and for holding such objects as flowers, orders, etc. The head is formed in one piece with an axial hole throughout its length leading into a hollow in the stem. In the stem is placed the loop b, the free ends of which are formed into claws c normally seated in a recess in the head by the spring e. By pressing the false base-plate f, the claws can be made to protrude and grip the necktie, etc., which on releasing the plate f, drawn into the head of the stud. In a modification, no spring action is applied, the claws normally projecting somewhat beyond the head to enable them to be pulled out hand.

28. **FOUNTAIN PENS.** R. A. HAMILTON, W. IRVINE and J. P. LEIN, all of New York, U. S. Jan. 16.

In a self-filling reservoir pen, the compressible reservoir 5, of rubber or other suitable material, secured to the contracted portion 4 of the body portion 1, which has a duct 3 leading to the nib 2.



The reservoir is adapted to be compressed for filling by a bar 9, of curved cross-section to avoid impinging the reservoir, extending nearly the whole length of the reservoir. A spring 8, preferably of flat form and attached to, or formed in one with, the protecting tube 7, is attached at the other end approximately the middle of the bar 9, so that, when the compressing force exerted by the operator's finger through the elliptical opening 13 is withdrawn, the spring 8 withdraws the bar 9, and allows the tube 5 to expand freely and take in ink. The end-tube fits over the tube 7 to prevent accidental compression of the reservoir, slits 11 being formed in the tube 7 to allow it to expand and contract and to intentionally engage the end-tube.

94. **SLEEVE-LINKS OR STUDS.** H. HODGETTS, Weston-super-Mare, Somersetshire. Jan. 17. In one form the stud is made with a base plate

a rigidly connected to a stem b. The end of the stem is formed as shown in Fig. 2, and carries a head c jointed at c to the stem. The head c carries

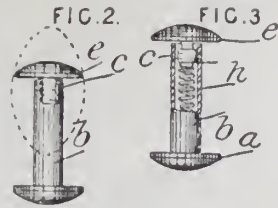

a knuckle which is held in position by means of a coiled spring h. In a modification, heads e are pivoted to both ends of the stem.

925. **PINCENEZ.** A. OEHLSCHLAGER, Ruppinerstrasse, Rathenow, Prussia. Jan. 17. (Date applied for under Patents Act, 1901, Feb. 16, 1904.)

The frames of so-called cylindrical eyeglasses are constructed so that each of the two relatively displaceable parts of the bridge forms one piece with

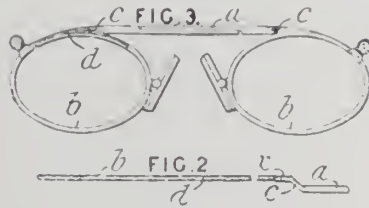

the corresponding eyeglass frame, being set back by means of a cranked portion or "break" at c. Fig. 2 is a plan of such a piece, previous to its being bent into the closed ring form shown in Fig. 3. A groove d for holding the glass is made in the part b, without interruption to the break c, and is made wider or deeper at the part x, Fig. 2, in order that the free end of the frame portion when it is bent round may be secured in it by soldering.

932. **TELESCOPES.** J. MITCHISON, London, Jan. 17.

The bodies of prismatic and other binoculars and telescopes are constructed of two parts, which are made from tubes of suitable cross-sections cut into lengths and fitted one within the other with their axes at right-angles to one another. Fig. 2 shows an inner part which is cut from a tube of the form shown in Fig. 1, and is then cut away at

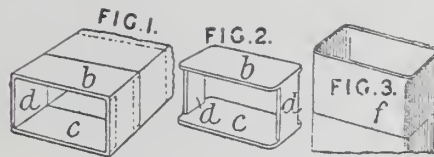

the corners to fit into an outer part f cut from a tube of the form shown in Fig. 3. The two parts are held together by vulcanite or other outer plates; the prism systems are mounted on supports which may be attached to the slides d, as described in Specification No. 20,164, A.D. 1904, and the plates b, c are formed with openings to accommodate the eye-pieces and object glasses.

940. **SAFETY-PINS.** R. P. BROWN, Philadelphia, Pa., U. S. Jan. 17.

To prevent sidewise movement, a projection b<sup>s</sup> on the shield is bent over between the two side

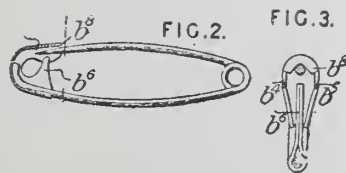

wings b<sup>4</sup>, b<sup>5</sup>, to form a V-shaped seat for the pin. A triangular guide tongue b<sup>6</sup> projects from the base of the shield and also serves to prevent the pin from slipping out of position.

1,121. **CLOCKS AND WATCHES.** W. McMILLAN, Milnegavie, Scotland. Jan. 20.

*Escapements.*—In the lever escapement, especially when used in stop-watches for timing pigeon

races, etc., the lever a is provided with passing springs, b, so that, if it is shaken away from the

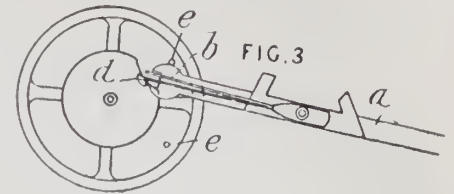

banking-pins e, the impulse pin d will not encounter it on the wrong side of the notch. (Reference has been directed under Patents Act, 1902, to Specification No. 1249, A.D. 1874.)

- Complete specifications accepted May 9, 1906.
- 4,366. BINOCULARS. MITCHISON.
  - 19,650. CALENDAR-CLOCK. SATTLER. 1906.
  - 1,810. HANDS FOR CLOCKS. BERTHOUD-HUGONOT.
  - 7,593. MATCH BOX. GRAHAM. Applications filed April 30 to May 5, 1906.
  - 10,141. ASH TRAY. FREDERICK MELTON, London.
  - 10,169. BROOCH. JOHN BRITCHER, Hastings.
  - 10,174. FOUNTAIN PEN. JOHN NAPLETON, London. Complete specification.
  - 10,190. HOSE-SUPPORTER. G. H. PHEIPS, London. Complete specification.
  - 10,256. EYEGLASSES. F. H. WHEWAY, Birmingham.
  - 10,267. PENCIL CASE. S. H. DONALDSON, London.
  - 10,283. CIRCUIT-CLOSER FOR CLOCKS AND WATCHES. CARL SCHWAN, Berlin. Complete specification.
  - 10,351 and 10,352. BRUSHES, MIRRORS, ETC. K. J. HINDE, Edghaston, Birmingham.
  - 10,468. CARD CASE. W. T. CONNOR, Birmingham. Complete specification.
  - 10,473. HAIR-PIN. M. E. A. WALLIS, Ashford, Middlesex.
  - 10,557. FOUNTAIN PEN. THOMAS BATTY, Colchester.

**UNITED STATES PATENTS THAT HAVE EXPIRED.**

[Reported especially for THE JEWELERS' CIRCULAR-WEEKLY by R. W. Bishop, Patent Attorney, Washington, D. C.]

Issued May 28, 1889.

- 403,943. SAFETY ATTACHMENT FOR WATCHES. C. G. KREBAUM, Havana, Ill.
- 403,999. GRAVITY CLOCK-ESCAPEMENT. FERDINAND GUNDORPH, Portland, Ore.
- 404,003. SAFETY-PEN. G. W. HERBERT, Birmingham, and SAMUEL GUINERY, Epsom, England.
- 404,027. PENHOLDER. G. W. BALDWIN, Schaghticoke, N. Y., assignor of one-half to G. H. Stevenson, same place.
- 404,039. UMBRELLA. C. W. HARRIS, Hartford, Conn.
- 404,092, 404,093 and 404,094. ORNAMENTAL RING FOR JEWELRY. G. H. KNIGHT, Providence, R. I., assignor to W. R. Lane & Co., same place.
- 404,099. WATCHMAKER'S LATHE. STEPHEN MESSERER, Newark, N. J., assignor of one-half to Jean Tack, same place.
- 404,102. CATCH-PIN. E. H. NASH, Westport, Conn., assignor to Lloyd Nash and E. N. Sipperley, same place.
- 404,127 and 404,128. CURLING-IRONS. G. L. THOMPSON, Chicago.
- 404,129. COMBINED COMB AND CURLING-IRON. G. L. THOMPSON, Chicago.
- 404,246 and 404,247. INK-WELLS. S. G. BALDWIN, Marion, Ind.
- 404,323. BUCKLE. G. M. TYRRELL, New Haven, Conn. Designs issued May 30, 1899, for 7 years.
- 30,874. SPOON HANDLE. G. W. SHIEBLER, New York.
- 30,918. GARMENT-SUPPORTER. E. N. LA VEINE, Kansas City, Mo.

\*Owing to a delay at the Patent Office the United States patents issued May 29 were not received in time to be used in this issue. They will be published next week.

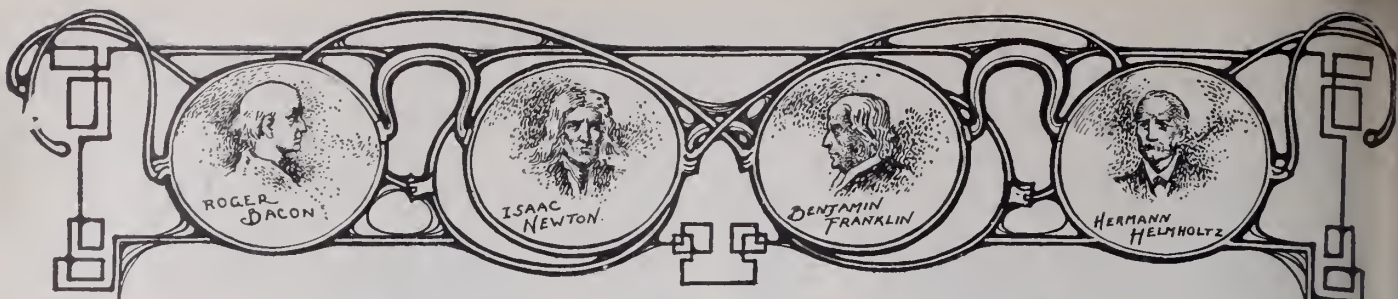

# OPTICAL DEPARTMENT

## Fourth Annual Meeting of the OHIO OPTICAL ASSOCIATION

Association now known as the Ohio State Optical Association

COLUMBUS, O., May 30.—The Ohio Optical Association yesterday closed its fourth annual meeting. The sessions Monday and yesterday were well attended, and some important business matters were disposed of. The name of the association was changed, a new constitution and by-laws and a code of ethics were adopted, a section of optometrists was provided for and the organization decided that its members shall all be members of the American Association of Opticians.

The word "State" was added to the name of the association, making it "The Ohio State Optical Association."

The convention was called to order in the convention room of the Great Southern

order for Tuesday at noon. This committee was composed of F. P. Barr, Lancaster; A. L. Thoma, Dayton, and E. L. Jones, Sandusky. The report of Treasurer White was heard and received, showing the society to be in satisfactory financial condition. The treasurer was tendered a vote of thanks for good work during the year.



J. B. WHITE, TREASURER.

Hotel, Monday afternoon, at 1:30 o'clock, the morning having been spent in registration and hand shaking. After the reading and approval of the minutes, the members immediately got to work. The question of a minimum price list came up under the head of unfinished business, and on motion, action was deferred until the next annual meeting. The report of the Committee on Constitution and By-laws was received, and its consideration made a special



F. P. BARR, PRESIDENT.

After a discussion on the general topic of the good of the order, a motion was made by J. C. Eberhardt, Dayton, and carried, to the effect that a committee be appointed on ways and means to advance the interests of the association.

Next on the program was the president's annual address, delivered by F. W. Wallis, Columbus. Mr. Wallis reviewed the work done during the year. While the growth of the organization had not been remarkable, it was steady and healthy and satisfactory to the officers. He drew interesting comparisons between the Ohio association and other State associations of the country, and dwelt at length on the educational work inaugurated at the last annual meeting. He very strongly advocated advanced study for all members of the association.

The first lecture was by Prof. George A.

Rogers, Chicago, who was introduced by Mr. Eberhardt, his topic being "Diagnosis of Optical Defects and Verification of Findings."

The annual banquet was held at 6 o'clock in the evening in the hotel. The president had previously designated Mr. Eberhardt as toastmaster. There were several short talks and some story telling by Frederick King, Cleveland; George Spencer, Cincinnati; Prof. Rogers, and others, "Shop talk" being conspicuous by absence. The menu was as follows:

- Russian Caviar with Egg.
- Puree of Tomato aux Cratons.
- Radishes. Pimolas.
- Broiled Chicken Halibut, Maître d'Hotel.
- Cucumbers. Potatoes. Croquettes.
- Fried Soft Shell Crabs, Tartar Sauce.
- Braised Calves' Sweetbread, Financiere.
- Roast Short Ribs of Beef, Essence.
- Peas in Cream. Browned New Potatoes.
- New Buttered Beets.
- Chicken Salad.
- Lemon Ice Cream. Assorted Cake.
- Cheese, Roquefort. Wafers.
- Coffee.
- Cigars.

An evening session was held immediately



E. L. JONES, SECRETARY.

following the banquet, at which there was another lecture by Prof. Rogers and a paper by F. P. Barr, Lancaster, vice-president of the association, he having chosen for his topic "Get the Habit."

The president appointed the new Committee on Ways and Means to advance the organization as follows: F. P. Barr, Lancaster; Fred A. Clough, Mt. Vernon; J. C. Eberhardt, Dayton; A. L. Thoma, Dayton; and C. D. Brooke, Chillicothe. A Com-



**Optical Department.**

on Nominations was also appointed, its members being: G. G. Boehm, Middletown; C. A. Bauer, Lancaster; G. A. Cornwell, Custer; G. S. Dietrich, Kinton, and B. J. Covert, Athens.

**TUESDAY'S SESSION.**

When the morning session opened yesterday a congratulatory telegram was received from President Scholler, of the Michigan Society of Optometrists, and on motion the Association voted thanks to him for his good wishes. Mr. Eberhardt spoke extemporaneously on "Ocular Nerve Economics," comprising in this talk extracts of the papers on the same subject which he recently contributed to THE CIRCULAR-WEEKLY.

Mr. Eberhardt prefaced his talk by giving some of his personal experiences in the city of Dayton as showing the need for the care of the eyes of school children. He told of some day see a fund started where school children whose parents were in urgent or partially indigent circumstances could be supplied with glasses. He has been a member of the Board of Education in Dayton, and has unusual opportunities of observation in this line.

The speaker advised against furnishing glasses for nothing in these cases. In order to get away from the charity idea, which is unpleasant to many who can ill afford to pay the regular price, he said he wishes the needed glasses at a nominal price; cost and a very small profit. Mr. Eberhardt was rather dubious as to how he could be received in the Board of Education, as five of its members were physicians. He had been warmly welcomed, however, and the physicians were his good friends, were deeply interested in optical work and often

referred cases to him. He was certain that all reputable physicians were interested in the advancement of the science of optometry and advancement of members of the profession through optical societies.

Mr. Eberhardt read a letter which had been sent out to oculists throughout the State by Dr. Stevenson, member of the State Oculists' Association and also of the American Medical Association, in which the latter called attention to the fact that the opticians had a State organization which was doing much good and held annual meetings which were largely attended. The fact was used to urge oculists to attend the State meeting of their own society. This Mr. Eberhardt looked upon as a very encouraging sign of the times and an indication of the good that comes through organization. The value of State meetings could not be measured in dollars, he said.

In regard to education, Mr. Eberhardt took the opposite of the old saw, "Beware of the man who knows one book." He advised members to know one book, and to know it thoroughly. He knew personally opticians who had read 20 or 25 books, and who knew this, that and the other, supposedly, but who "fell down" wonderfully when asked the simplest question. He advised a thorough knowledge of one book in preference to wide reading without absorption.

The balance of his talk was more technical, being a resumé, as stated previously, of articles by him which have appeared in THE CIRCULAR-WEEKLY.

The report of the Committee on Constitution and By-laws was then taken up and adopted section by section. The objects of the association, as stated in the new constitution, are as follows:

1. The encouragement of the science of

optics and the attainment of a higher practical and scientific knowledge by its members. (2) To discourage the indiscriminate sale of spectacles by irresponsible and incompetent persons. (3) The protection of its members from legislation harmful to the optical profession. (4) To promote good fellowship by holding annual meetings for the interchange of thoughts and experience, for mutual improvement and education.

Active and honorary members are provided for. The officers are president, vice-president, secretary, treasurer, executive committee of three and a membership committee of three. The secretary's salary was increased from \$25 to \$50 a year, and the treasurer was made exempt from dues in return for his services and placed under a \$100 bond.

There was considerable discussion regarding the duties of the Executive Committee. These were limited under the old constitution to practically nothing except attending to business matters requiring attention between annual meetings. The new constitution provides they shall elect the place of meeting, arrange the program and have charge of all "legislation and ordinary business not requiring a special vote." Mr. Eberhardt objected to this provision, saying it took from the president his most important duties. Mr. Thoma insisted the committee should have something to do so it would not be an almost entirely useless body. Mr. Thoma finally suggested the compromise arrangement that the president, vice-president and secretary should comprise the committee, and this was adopted. The Membership Committee, after some discussion, was given power to elect members.

There was a minority report in regard to the annual dues. The majority report pro-



A GROUP OF OPTICIANS WHO ATTENDED THE FOURTH ANNUAL CONVENTION OF THE OHIO ASSOCIATION AT COLUMBUS.

## Optical Department.

vided that the annual dues should also include dues in the American association, and that all members of the State association should be members of the National body. The minority report provided merely for State dues. The majority report was adopted, after some discussion, Mr. Eberhardt speaking in its favor.

The Optometrical section was established without dissent. Requisites of membership are: Good standing in the Ohio State association, and evidence of qualification to be determined by a board of examiners.

The following code of ethics was adopted:

### CODE OF ETHICS.

#### ARTICLE 1.—LOYALTY.

Section 1. Every member of this society shall feel it a duty to further the interests of the society, not only by attendance at meetings and payment of dues, but by supporting the work proposed by it.

Section 2. An optician can best show his loyalty by his personal conduct and the character of his professional work.

Section 3. An optician should avoid unkind criticism of others as being unprofessional.

#### ARTICLE 2.—DUTIES TO A PATRON.

The confidence shown in an optician by a patient placing his case in his care, should under no circumstances be abused. No exaggeration of a patron's visual imperfection should be made to influence a sale. The welfare of a patron's eyes should be above the desire to make a sale, and if glasses are not necessary the patient should be frankly told so.

#### ARTICLE 3.—DUTIES TO PHYSICIANS.

Cases that in any way indicate the need of medical treatment should be referred to a competent specialist or the family physician, and it is deemed unwise to suggest any kind of drug or eye lotion, but advise all such patients to consult medical authority.

#### ARTICLE 4.—DUTIES TO THE PUBLIC.

An optician should be diligent in enlightening the public regarding the care of the eyes and the causes and danger of defective vision and eyestrain. He should constantly endeavor to raise the standard of competency among opticians, and do all in his power to secure legislative recognition of the practice of optometry, and afterwards be vigilant to keep it effective and beneficial.

The joint question whether the word "optician" should be used in the code instead of "optometrist" and whether "patron" or "patient" was preferable evoked some debate. It was finally decided to use "optician" instead of "optometrist," thus holding out invitation to all interested in the optical business to become members. It was deemed best to take in all the opticians and make optometrists of them later. Nor was it deemed wise to "borrow titles or phrases, or pretend to be something which we are not," so the word patient was stricken out and patron inserted.

Adjournment was had for lunch, and at the afternoon session the Committee on Nominations reported the following: F. P. Barr, Lancaster, president; A. L. Thoma, Dayton, vice-president; E. L. Jones, Sandusky, secretary; J. B. White, Columbus, treasurer. The secretary was instructed to cast the vote of the body for this ticket. The new Membership Committee is: F. A. Stengel, Marion; C. A. McDonald, Columbus, and Josephine Nixon, Marietta. The Examining Board is composed of: J. C. Eberhardt, Dayton; F. W. Williams, Portsmouth; C. S. Hartman, Wapakoneta.

Last year's Executive Committee, composed of W. E. Harris, Columbus; E. Klein, Cincinnati, and F. A. Stengel, Marion, which acted as an Auditing Committee, re-

ported the books of the treasurer in good condition.

Letters were read from B. B. Clark, president of the American Association of Opticians, and F. Nelson Wyngate, Plymouth, England, extending best wishes to the Ohio association. A letter was received from the Cedar Point Pleasure Co. inviting the association to meet at Cedar Point, a Summer resort on Lake Erie, in 1907.

On motion, "Physiology of Vision," five volumes, were purchased for the use of members of the association.

The Membership Committee reported on 19 applications.

Prof. Rogers' third lecture was delivered at the afternoon session.

There were exhibits by the Julius King Optical Co., in charge of Frederick King and R. J. Sime; the White-Haines Optical Co., in charge of F. T. Prosser; the Columbus Pharmacal Co., in charge of H. E. White; the Eye-Fix Remedy Co., represented by Dr. Frank T. Leys; the Zonola Remedy Co., represented by V. D. Reese, and an exhibit of books of interest to the trade, by L. S. Wells. The Eye-Fix Co. presented the association with its badge—a gilt bar with the word "Member," from which was suspended by a small silk American flag a circular celluloid piece with the inscription: "Ohio Optical Association, May 28, 29, 1906, Columbus."

### "Get the Habit"

(Address of F. P. BARR, Lancaster, O., before the Ohio State Opticians' Association, Columbus, O., May 28, 1906.)

THIS subject is to be a nucleus from which I will endeavor to evolve some new principles for the advancement of the optical profession, as well as a stimulus for new energy in good old principles. We must accomplish more in the next two years than we did in the last. We must move onward and upward or stagnation will throttle our future. In giving utterance to these words I am simply speaking the sentiments of the present as dictated by the spirit of progress. We must assume new attitudes in keeping with our gradually rising, influential and universally recognized profession.

The time has come when we must labor harder and make less noise; when we must be diligent in study and pay higher respect to ethics; when we must learn to recognize the sensitive ground over which we are traveling and be able to bridge the pitfalls accordingly.

Time and opportunity are ours; a network of knowledge, practical ability, justice and honor should be interwoven under such uniting circumstances until we are entrenched in the confidence of the people and the laws of our State, as the leaders of the most scientific profession and the noblest calling (outside the ministry) in the world to-day. Suffering humanity in various forms and conditions that have their origin in eye troubles, is making an appeal to us and we must heed the cry or in a few years to come we must bear the stamp of indifference and neglect.

We are maintaining State associations for the benefit of every soul within the State as well as for ourselves individually. But we,

as optometrists, are supposed to get the essence of learning and practical ideas a principles by our intermingling, so that when we return to our homes we may disseminate these truths, orally or through the chief medium—glasses—in such a way as gain for us the deserving sympathy and praises of our fellowmen.

Much of the world is discouraged and many are despairing. Many are going with but one end in view—to satisfy material wants of the day. Few rise to a bread and butter ambition. We must learn to have higher aspirations and ambitions, for we have difficult, exact and perplexing questions that call for inspiration not manifest in past years—clear, broad and comprehensive mind, heart as big as your body, and an optical enthusiasm larger than both, will fit you to win a following. Such a principle may be your motto if you are going to be in the front ranks of the optometric profession, in which Ohio must and will lead. "Get the habit" of being conservative, your convictions, be practical and abreast of the current of modern thought—above all, learn to exercise good common sense. Learn to think. "Get the habit."

Along these lines and for your consideration I present the following thoughts:

First—Leave it optional with the members individually of our State Association whether or no they affiliate with the national body.

Second—Have no member of our State association as president, vice-president or secretary unless he or she has affiliated with the national association and is in good standing at the time of seeking office.

Third—Make your president the delegate to the national body.

Fourth—In case it is absolutely impossible for the president to attend the national convention, the vice-president becomes State delegate.

Fifth—Railroad fare for said delegate be paid out of our treasury.

Sixth—All other expenses to be paid said delegate, unless otherwise ordered, a two-thirds vote of attending members.

Leaving it optional with members of the State association as to whether or not they will become members of the national body has some very strong points in its favor.

We have members who do not affiliate with the American Association of Opticians, for it is of little interest to them personally and they never expect to attend these meetings. They would much rather contribute to the State association amount required of them for the national body, thereby making the local organization stronger, which in turn gives us the great strength to the national association.

For the strength of a chain depends on the individual strength of its links, every State organization is a link in the great national chain.

Again, we have some strong members who hesitate to connect with us because they do not care, nor feel able, to support both the local association and American Association at the same time.

Under my plan if a man has any desire to advance, he will get so interested in optical matters by the time he has worked his way through the chairs in his local org-

## Optical Department.

## Anatomy of the Nervous System.

(Lecture recently delivered before the Rochester Optical Society by DR. RALPH H. WILLIAMS.)  
(Continued from issue of May 9.)

### LIGHT AND THE EYE.

**N**OW let us consider the conditions between light and the eye itself. There is no more vascular organ in the body than the eye. Outside of its crystal coats, it is a veritable network of arteries and veins. The iris is supplied with blood far in excess of the needs of its tissues and the ciliary process comes well forward beneath the iris for no other reason than to receive the action of light. You are all familiar with the appearance of the retina, a network of blood vessels.

But one says, "What has this to do with our business?" We are only interested in the manufacture and proper fitting of spectacle lenses. This probably is true, and yet you must guide your footsteps carefully and see to it that you deprive the tissues of none of the forces nature has intended for their health and growth, not alone because of the responsibility you assume towards your fellow when you presume to meddle with the care of the most priceless gem in this casket of life, the delicate, sensitive eye, but commercially, because the medical men have been looking for many years for some good reason to wipe the optometrist from the face of the earth, and it will be well for you to keep abreast of the times.

The most delicate of all tissues, those of the eye, feed, grow and live mainly upon the health ray light. We know that the normal healthy eye absorbs the health rays. We know that the lenses of regular stock prevent the health rays almost wholly from reaching the eye. We know that the vitalizing energy of light imparted to the normal, un-spectacled eye is largely obliterated by the regular lenses. Finally, we know that the health-ray lenses transmit these health rays and do not interfere with the conditions above referred to. In short, we know that a health-ray lens brings back a deficient eye to the nearest possible condition of a healthy and normal eye, but if we take away those health rays the blood vessel would wither and the tissues starve, as is the case in cave animals; and though we may have corrected a serious visual trouble, stopped an enormous amount of headache, and done, from an optical standpoint, a really marvelous thing, yet in most cases the cure may be worse than the disease. The continued use of our present lens material by successive generations will cause hereditary deficient eyesight and eye weaknesses of allied nature.

### HYPEROPIA.

Let us take a few cases, for example. First, hyperopia. At birth nearly all eyes are hyperopic, developing gradually until the age of 12 to 16, when they are by most authorities considered full grown. Great writers claim that the majority of cases of hyperopia are an under development of the eyeball from front to back. We say the eyeball is too short. Now, if a child of 10 be hyperopic three diopters we prescribe a plus spherical lens, which, as is well known, corrects the eye strain. But in so doing our material used absorbs the health rays and produces the evil changes in tissue and blood before referred to.

This result is not confined to the eyeball and its parts alone, but it extends particularly to that third of the brain which is a part and parcel of the visual apparatus. Though we are not blind like the cave fish or salamander, it cannot be denied that the tendency is in that direction, and sufferers are compelled to wear lenses through life, or suffer severe "eye strain" and accompanying disadvantages.

### MYOPIA.

In myopia, the condition is no better. It is caused in most cases as is hyperopia in the adult, by the failure of the blood to carry the proper food to the tissues, or by a failure of the tissues to use the blood after receiving it. This malnutrition produces a weakening of the sclerotic coat. The weakened tissue, unable to endure the pressure of the eye muscles, gives way sufficient to increase the depth of the eyeball from front to back.

For the cure of this condition the eye must take on the proper elements to stay this disease and restore strength to the enveloping coats. Lenses should be used that will cause the blood to perform its function, in addition to correcting refraction.

When we put glasses in front of the eye which absorb the health rays, though we may have corrected the error of refraction, we have added fuel to the fire so far as the curing of the trouble is concerned.

### CATARACT.

Again, the cataract, though a different disease, is a condition caused by faulty nutrition. The use of glasses which absorb the health rays will accomplish the same irreparable injury, as pointed out above, while glasses which permit the passage of health rays will be a handmaiden to Nature by giving the tissues food and growth.

### OTHER EXAMPLES.

Examples multiply, but these three will suffice. What is true of hyperopia, myopia and cataract is true of every neural disease of the eye not resulting from external injury or systematic derangement. They rest in part upon insufficient or faulty nutrition, and the health rays must, therefore, be utilized.

(To be continued.)

The *Globe News* is the title given to a trade paper published on the 15th of each month by the Globe Optical Co., Boston, Mass. Its pages, of which there are 12, are 6 in. by 9 in. in size. Its motto is: "For Your Interests and Our Own." The first issue contains a description of a number of the Globe Optical Co.'s departments; an essay on "The Man Who Sells Things"; an article on "Competition" and one entitled "Who Are the Fortunate Ones?" Some of its principal features are the departments called "Idea Exchange," "Globe News" and "Classified Advertisements." In the first readers may air their views; in the second are described the latest goods placed on the market, and the third contains "wanted" and "for sale" ads. One full page is devoted to a novel scheme. Here, each issue, will be found the notice of a special bargain, some instrument, tool or fixture, that will be sold at an especially low price during the current month. An offer is also made to pay 25 per cent. of the cost of individual electric car advertising of a number of articles specified by name.

tion that he will forever be a standard bearer in the affairs of the national organization.

No man appreciates the magnitude of the American Association of Opticians until he has attended several meetings, and becomes familiar with its workings. It is the great central head to which before long we must look for advanced and general directions. As being true, it will surely be considered an honor for any man to become the president of our local organizations, thus bringing his attendance at the national convention as a representative from this progressive body of optometrists.

"Get the habit" of being progressive along service lines and you can win laurels which will bear the stamp of the highest honor possible to be achieved.

In making our president the delegate to the national convention, it does away with sending a delegate each year and at the same time gives our organization a representative who is up in optical matters and a man who has at heart the principles of universal good. This condition must exist for the welfare of both societies. In the payment of railroad fare we have another incentive to promotion.

Who would not naturally strive to secure a position that would in itself not only be an honor, but also carry with it a profitable and pleasant trip? Every member within the sound of my voice I think will agree with me in saying that this feature will add materially to the efforts to secure so honorable a position as president of the Ohio Association of Opticians.

I could carry this subject much further, but time will not permit. Therefore, let me conclude and impress once again upon your memories that no honorable and profitable achievement is attained unless produced by labor. "Get the habit." In our battle of life as in every other field there are constantly presented new phases, and he only expects to be victorious who is ready to show a new front as often as the situation shows a new peril. Be vigilant, diligent, and determined to win, pursue but one course, that of your chosen profession. No nobler professional calling exists.

Remember—

*The man who seeks one thing in life, and but one,*

*lays hope to achieve it before life is done,*

*but he who seeks all things wherever he goes,*

*only reaps from the hopes which around him he sows*

*the harvest of barren regrets.*

There were 19 different styles of automobile spectacles and goggles on one tray in an optician's window, an interesting proof of the benefit of motoring to this title, says a writer in the *New York Sun*. The opticians are quick to cater to the patrons in every sport and some of the automobile spectacles seemed the first cousins of the sports first offered to bicyclists. They are, too, glasses with a special clip for golfers, warranted not to fall off when giving a shot, besides special spectacles for rifle shots, field gunners, fishermen, etc.

# WALTHAM WATCHES

---

We beg to announce the issuing of the following described 16 size movement:

16 SIZE,  $\frac{3}{4}$  PLATE, S. W. MOVEMENTS

LEVER SETTING

OPEN FACE

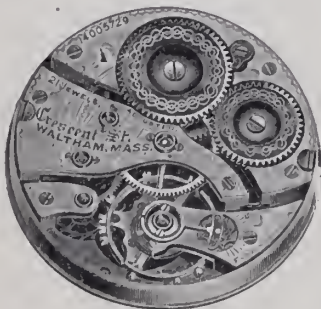

Crescent St., Nickel;

21 Fine Ruby Jewels; Raised Gold Settings; Jewel Pin Set without Shellac; Double Roller Escapement; Steel Escape Wheel; Exposed Sapphire Pallets; Compensating Balance, Adjusted to Temperature, Isochronism and Five Positions; Patent Breguet Hairspring, Hardened and Tempered in Form; Patent Micrometric Regulator; Tempered Steel Safety Barrel; Exposed Winding Wheels; Double Sunk Dial.

---

AMERICAN WALTHAM WATCH CO.,  
WALTHAM, MASS.

# THE HOROLOGICAL REVIEW.

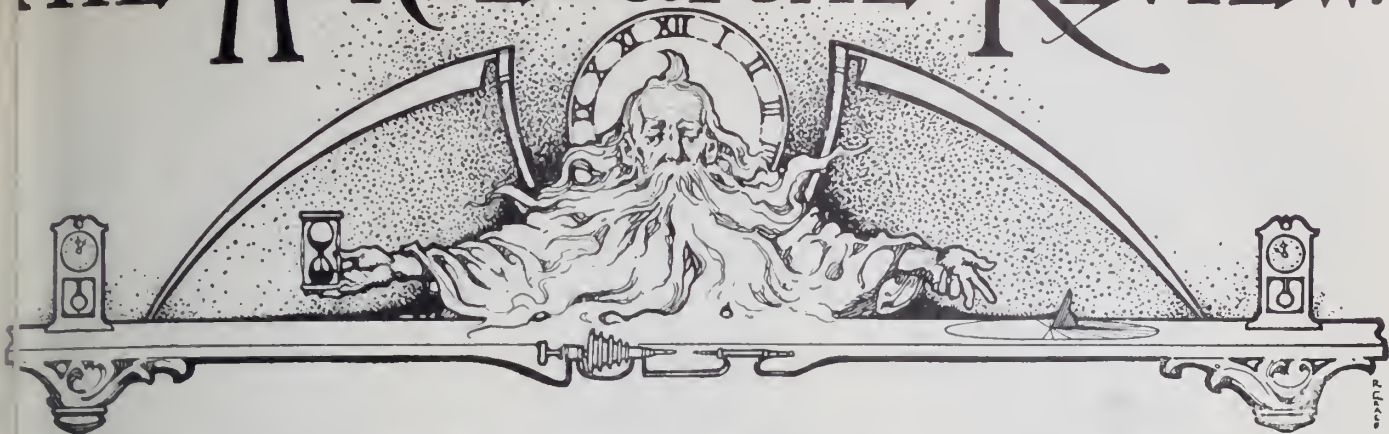

## How Father Knickerbocker Marks *the* Hours

Prominent Clocks That Give the Time to New Yorkers in Manhattan, Brooklyn and the Bronx.

(Continued from issue of May 23.)

MANHATTAN'S CHURCH CLOCKS AND CHIMES.

**R**EARING their tapering spires high skyward, fingers pointing to heaven, the church steeples of an antiquity reaching beyond the age of written history stimulate the worshipper to lofty aspiration and ethereal contemplation of a Creator's wonders. The bulbous synagogues' apex, the minaretted temples of the Mohammedan and the Gothic bristling needles of the Christian's sacred edifice, all alike point to the blue expansive canopy, admonishing their congregations mutely of

er life beyond this short mundane existence.

The priest of ancient Egypt conceived the ring sign on similar lines (though he ordered the apex of his angle less acute) when he, for a monument to his departed wife, depositing the remains, their mouldering partially checked of the mighty rulers gigantic tombs of stone. He massed the great stone edifices, shaped so that for many centuries around their vast cumulation should be seen into the centuries pointing toward the heavenly dome.

The elementary expression of religious faith in future existence in both ancient and modern times we find to be ever presented as an index pointing to the starry worlds above.

For the origin whence we derive the church bells that from their steeples proclaim the passing hours, we must look back

to pagan and idolatrous times. Adopted by Europeans first as messengers of terrible import to the surrounding country folk, warning by their far reaching clanging tones of the approach of the dreaded Saracen

The tocsin bell became later converted into the pacific use of calling the country farmer and the villager from their labors to attend religious devotions.

With rapt attention do we harken to the joyous peals of the chimes, those "wedding bells" that acclaim the happy event; that pact of dual unity for a mutual participation of life's pleasures and sorrow alike. The solemn tolling of the sad message of bereavement; that prolonged, harsh parting which but for religion's faith would hold forth no hope of future reunion. From birth to death the church belfry preaches in sonorous accents of earthly time and human event.

And what of time's passage the belfry tells to our ear; the hands on the dial in the steeple corroborate to the eye each minute of their course 'round their diurnal orbit. On account of their relative value as well as their numerical importance the



JOHN'S CHURCH.



ST. MARK'S CHURCH.

hordes, calling to arms to protect home and family from devastation and death at the hands of the blood-thirsty eastern fanatic army, the bells were placed in the highest buildings—the churches.



THE CLOCKS IN ST. GEORGE'S TOWERS.

church clocks are well worthy a chapter by themselves.

The ancient land-marks of lower New York, such as Holy Trinity and St. Paul's, have already had their merits discussed in an earlier division of this series. But one of our ancient churches, the venerable Protestant Episcopal St. John's, on Varick St., contains one of this country's most aged public servitors within its spire. With its seven-and-a-half-foot pendulum so

# An Argument for the ELGIN Dealer

The records of the Weather Bureau show a difference of 181 degrees between the extremes of heat and cold in the United States. A watch to be adapted to the use of the traveler must be able to maintain its accuracy under widely varying conditions of temperature. One reason why the

## ELGIN Watch

is pre-eminently the traveler's watch is found in the fact that all Elgin Watches are tested by oven heat and by refrigeration before leaving the factory. Their wonderful timekeeping qualities are undisturbed by extremes of temperature, damp or drought, jar or jolt, or by varying positions.

LOWEST  
UNITED STATES  
TEMPERATURE  
63° BELOW

HIGHEST  
UNITED STATES  
TEMPERATURE  
118° ABOVE

The above is one of the many good arguments for the Elgin Watch, all of which help the dealer to sell Elgins.

See Jobbers' list for prices or write the Company.

Every dealer is invited to send for the Elgin Art Booklet, "Timemakers and Timekeepers," illustrating the history and development of the watch.

### ELGIN NATIONAL WATCH COMPANY

Factories, ELGIN, Illinois, U. S. A.  
General Offices, 131 Wabash Ave., Chicago.

NEW YORK OFFICE, 11 John Street.  
SAN FRANCISCO OFFICE, 206 Kearny St.

er that each swing causes the whole mechanism to shake and every tooth in the escapement wheel, one time or another, torn or broken, decrepitude is fast bringing the massive works to their well-earned end. The movement is of such heavy construction that the possible dangers attending its activity have brought forward several times the proposition to replace it with a better mechanism, and each time the decision becomes more serious. But the wheels still roll by and the hours are ticked off with such a wonderful regularity that the passing crowd little know of the possible defects in its internal arrangement. Useful to the toiling East Side population are a few church dials sparsely scattered in more or less squalid surroundings.

clocks in the two towers of this brownstone building the Rev. Stephen H. Tyng wrote in 1868: "A S. Hotchkiss was the engineer and contractor of the first tower clock de-

clocks widely separated from one another, in different towers, from one movement. This movement, located between the dual towers, controls the works for the six outdoor dials as well as a clock inside the church. A peculiar feature of these dials is that they are part and parcel of the brownstone towers, the hour numerals being attached to the walls. St. George's time was for many years the city's standard, and at the present day it is said to rarely gain or lose appreciably in the course of a week.

But the space at disposal enforces our hurrying next to Fifth Ave. and 29th St., where we find the Old Dutch Reform Church, with its ancient clock, copied after the one in St. John's, whose cumbersome proportions have been described. The ancient origin of the "Old Dutch" dates back



OLD DUTCH CHURCH.



BRICK CHURCH CLOCK.

stroyed by fire in the church in November, 1865. Upon rebuilding the church one of the A. S. Hotchkiss tower clocks, manufactured by the Seth Thomas Clock Co., was obtained."

An historical incident in horology occurred in the installation of this twin clock, for the



FIFTH AVE. PRESBYTERIAN CHURCH.

to the early part of the last century, and the clock movement was constructed by Stokell, who, in his day, was a manufacturer of wide renown and whose timepieces were of the best in this country. It was installed very shortly after the erection of the building itself.

A little further uptown brings one to the old Fifth Ave. Brick Presbyterian Church, with its dials, and another few steps in the same direction show one the clock in the facade of the Protestant Episcopal Church of Heavenly Rest, on Fifth Ave., near 45th St. The latter is a timepiece of the E. Howard Clock Co., with a six-foot dial and having Westminster chimes struck on four bells. At 55th St., opposite the Hotel Gotham, the clock on the Fifth Ave. Presbyterian Church gives time to the crowds that constantly promenade that thoroughfare.

But this has brought the reader beyond a very familiar timepiece on Ninth Ave., near 31st St., in the North Presbyterian Church.

Traveling ever northward brings one at



CHURCH OF THE HEAVENLY REST.

Seth Thomas Clock Co. established a precedent when, in spite of the generally expressed expert opinions that such a condition was impracticable, they started two

St. Teresa's Roman Catholic house of worship on the corner of Rutgers and Henry St. from its dials in the brownstone tower, the four 40-inch dials in St. Nicholas (Manhattan's patron saint, by the bye) on 2d St., near Avenue A, a church of the same religious denomination, are both useful factors to a mass of workaday humanity. And yet another Roman Catholic Church, whose peculiar spire is adorned with a timepiece in this part of the city, is that of The Most Holy Redeemer, on 3d St., near Avenue B, showing how well the priests of that ancient faith watch temporality as well as spiritually over the congested masses of their flocks with these three closely neighboring places of worship.

Working one's way northward on Second Ave., at 10th St., St. Mark's and its members of those days when this section was the center of New York's wealthiest representatives, come before us. Within that aged edifice's walls A. T. Stewart, as the merchant prince, paid obeisance to his Maker, and the clock in that steeple looked down on the body-snatching act when the remains of that knight of industry vanished from the vault.

A few steps further north stands St. George's Episcopal Church, on Second Ave., corner of 16th St. Concerning the

For *BEAUTY* of *DESIGN*, *PERFECTION* of *FINISH* and *RELIABILITY* Combined with *Moderate Price*

# TRENTON WATCHES ARE UNEQUALLED



No. 140. Bridge Model, 16 Size, 15 Jewel, Hunting and Open-Face, Pendant Setting.

A sample line is convincing. They are pendant setting in all sizes, fitting regular pendant setting cases, decorated dials and Louis XV hands.

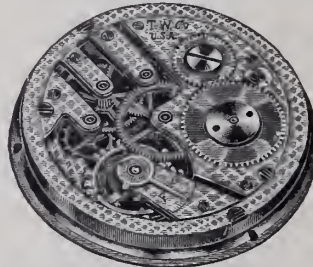

No. 320. Bridge Model, 12 Size, 7 Jewel, Hunting and Open-Face, Pendant Setting.



No. 100. Bridge Model, 0 Size, 7 Jewel, Hunting and Open-Face, Pendant Setting.

A NEAT SIGN  
OR ADVERTISING  
BOOKLET FOR  
THE ASKING

JOBBER SELL  
TRENTONS.

PRICE LIST ON  
APPLICATION.

Manufactured and Guaranteed by

Trenton Watch Co., - Trenton, New Jersey.

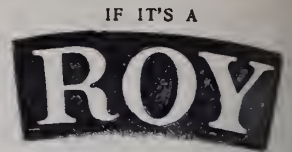

TRADE MARK  
IT'S STANDARD



O Size Bassine Engraved Cases, made from assayed Gold, quality as stamped.

ROY WATCH CASE COMPANY,



21-23 Maiden Lane  
NEW YORK.

SAN FRANCISCO.  
LONDON, ENG.

## SETH THOMAS CLOCK COMPANY.

Established 1813.

### EMPIRE No. 13.

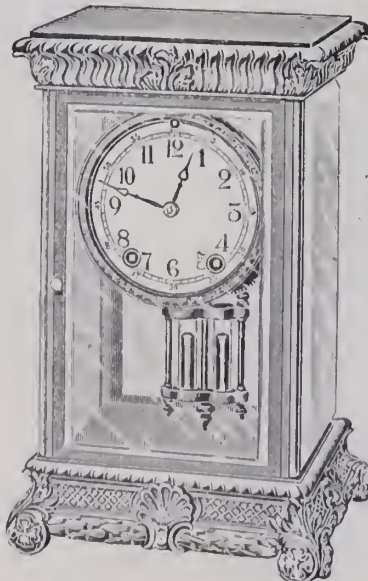

Metal case,  
**GOLD PLATED**  
and lacquered. Beveled  
plate glass front and  
sides. Height 16 inches.

Eight-day, half-hour  
strike; cathedral bell;  
4-inch porcelain dial.

List Price, \$22.00.

SETH THOMAS CLOCK COMPANY,

51 Maiden Lane, New York.

70 Wabash Avenue, Chicago.



a to Harlem with its recent marvelous transformation from goat pastures to busy streets and mills.

and the homeseeker from the more shelterly sections carries his religion with him, as is amply exemplified in the many beautiful churches already erected in this part of the city. Of clocks within the people and the church tower also there is no lack, though space is not sufficient within these columns to mention more than a few.

On 127th St. and Fifth Ave. stands St. Andrew's Protestant Episcopal Church with its useful dial conspicuous alike by its position and dimensions. Washington Heights Presbyterian Church, on 155th St. Amsterdam Ave., also by its timepiece evinces the gratitude of a passing public.

Before bidding good-bye and best wishes to these benefactors of humanity, just another word as to the adversities that beset them.

A good inkling of the difficulties with which a faithful tower clock has to contend in climatic changes, etc., was told the



ST. ANDREW'S P. E. CHURCH.

writer in discussing the subject. A slight exactitude during several days was noted one very stormy Winter in the time of the dedication of one of our steeple clocks. The writer sent up to investigate reported that snow had gathered on the pendulum, then melted and then frozen into masses of ice which had grown to an accumulation that made the pendulum beat thunderous strokes similar accumulations of ice on the side of the tower. The arc of the swing had come so shortened the wonder was that it beat any old time at all.

(To be continued.)

The Sulzbacher, Peck Jewelry Co., Florence, S. C., capitalized at \$15,000, has obtained permission to change its name to the Sulzbacher Jewelry Co.

Watch Repairing.

By H. REINECKE.

(Continued from issue of May 16.)

A FURTHER discussion of points appertaining to the mainspring will appear with the subject of examining, repairing and cleaning of watches. A watch repairer in the course of his every-day business has to use the lathe and the file. At the present time the younger members of the profession are using the American lathe almost exclusively, while some of the older ones, who have been brought up to use the old-fashioned turns, still cling to its use. As the old styles of clocks and watches have been made with its assistance and with a view of being repaired by its use, and as the nearer acquaintance with this tool may increase our mechanical knowledge, it may not be amiss to introduce some of the younger members of the horological fraternity to this venerable tool.

The turns is a small dead center lathe, in which watchmakers turn and pivot staffs,

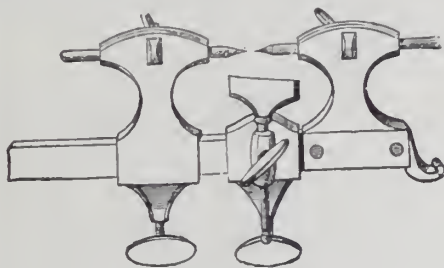

THE TURNS.

arbors, etc. The work is centered in the turns and has a ferrule attached to it, so that it may be rotated either with a bow or by a cord connected with a wheel, to which motion is given by the hand or foot. These turns are principally manufactured in Switzerland or in the older countries of Europe. They are made of several sizes and somewhat different in style. Small ones are made for the exclusive use of watch work and larger ones for musical movements, clock work, and other horological devices. While it is claimed that the American watchmaker's lathe has superseded the small turns entirely, the latter has still its uses in repairing old styles of watches and making certain small parts of modern ones, as for instance, the fitting of a new escape wheel pinion of cylinder watches of small sizes and other parts. The large turns still remain a very handy tool in making repairs to hall clocks and doing other odd jobs.

The illustration is the form of the turns generally met with.

Steel and brass runners are used with those turns for turning and polishing pivots, etc. Ivory runners ridged for polishing pivots of clocks are often used. The runners shown herewith are the larger size used in the larger tools, but serve as patterns for forming smaller ones. Such runners are generally made of pieces of rods of bright polished steel wire, which fit the holes or bearings of the heads or tail stocks of the turns without any turning down. A short description of the runners here shown is now in order: A is pierced to a short distance on both ends for the insertion of small male or female centers, which are intended to serve for turning and polishing

small objects, such as the large pivot of center wheel pinions, pierced center pinions, canon pinions, which cannot be readily placed upon arbors; b is intended for similar use; it is fitted with a ferrule and a carrier on one end for the turning or polishing of pinion pivots, when wheels are riveted upon such pinions, and also for tuning up brass wheels; c has on its left



RUNNERS.

end a number of graduated holes beveled on the back for filing centers of thin pieces of steel wire or pinion wire. On the other end is a reduced projection with a number of graduated countersinks for turning small pinions and balance staff pivots; this end of the runner has a mate in the opposite hole of either the head or the tail stock of the turns, with a small male or female center to support the back center of the work operated upon. This mode of turning pivots is stubbornly adhered to, being preferred to the American lathe for the purpose by some of the old watchmakers, who claim that this is the only correct mode of turning out balance staffs, where both pivots of a staff are perfectly true and in line; b may project through and have their centers trued up. The necessity of other runners of steel, brass or ivory will present itself from time to time, and other attachments are placed in the tool rest, such as a drilling fixture, for replacing broken points and many other more important and most ingenious devices, according to the inventive genius of the different workmen. In all fairness it would be rash indeed to condemn the old-fashioned turns in a summary manner and without an exhaustive investigation, for the most experienced mechanics will be astonished at times how our former horologists have accomplished so much with this tool and the assistance of a wonderful manual dexterity.

(To be continued.)

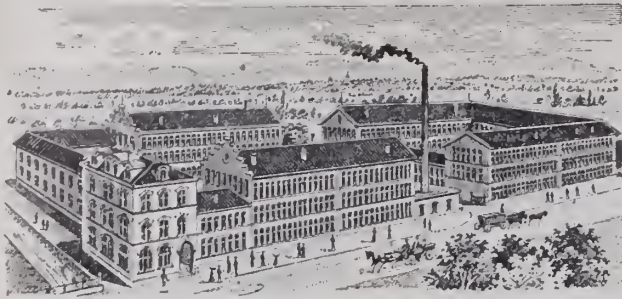

This illustration shows our main factory exactly as it exists, where 3,000 complete watches are made daily.

# LANGENDORF WATCH CO.

CHAUX-DE-FONDS, SWITZERLAND.

It will be of great interest to every jeweler to learn that we are devoting our full attention to this market. The existing conditions in the watch trade have convinced us that there is a long felt want for moderate priced, but accurate Swiss Watches.

We wish to call your attention to our LONVILLE MOVEMENT. It has a lever escapement and is being made in Os, 12s and 16s, fitting perfectly all American cases. This movement is salable and profitable. Our Watches and Movements will be introduced in this market bearing the following names:

- |          |          |
|----------|----------|
| SOLDALE  | HIGHMERE |
| BONDALE  | LONVILLE |
| CLAREFAX | NAMTOC   |
| PEARLHAM | LADY MAY |

SOLE AGENTS FOR UNITED STATES.

**BYRON L. STRASBURGER & CO.,**  
17 Maiden Lane, New York, N. Y.

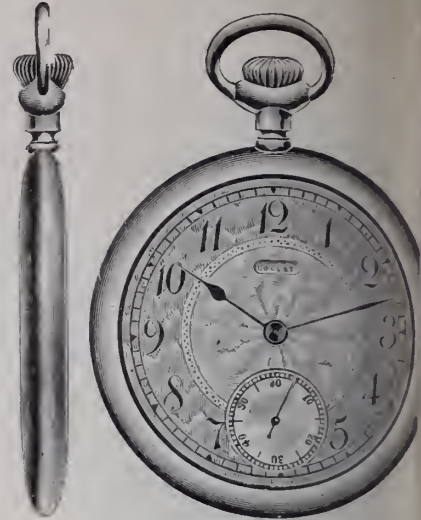

Actual Size.

# LOCUST

Extra Thin Model,

SEVEN JEWEL,  
LEVER,  
PENDANT SET,

CASED IN

**Fahys Bassine**  
**20 Year Filled**

Screw Back and Bezel,  
also in  
Silver, Gun Metal  
and  
Solid Nickel Case.

BEST VALUE EVER OFFERED

**TRY THEM.**

WE GUARANTEE EVERY  
LOCUST WATCH.

All Parts Interchangeable.  
Finished Material Always on Hand

IF YOUR JOBBER CANNOT  
SUPPLY YOU,  
**WRITE US.**

**Hipp. Didisheim & Bro**

49 Maiden Lane,  
New York.

Chicago Office, - Columbus Bl

# Vacheron & Constantin,

GENEVA,



SWITZERLAND.

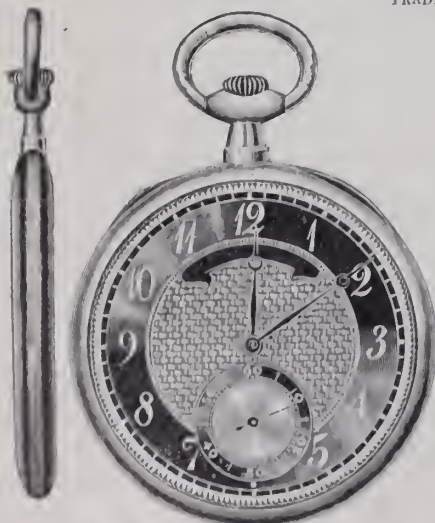

MAKERS OF EVERY VARIETY OF

High-Class  
Adjusted Watches,  
Complicated Watches,  
Extra Flat and  
Ultra Flat Watches,  
Enameled, Carved and  
Jeweled Watches.

**EDMOND E. ROBERT,** SOLE AGENT,  
3 MAIDEN LANE, NEW YORK.



# ZENITH

## MOVEMENTS

Give the

**RIGHT TIME  
EVERY TIME  
For a LIFE TIME**

**Grand Prize, Paris Exposition, 1900**

Made in O size, 12 size, 16 size, all grades

Hunting or Open Face, Pendant Set

INTRODUCED FOR THE FIRST TIME IN AMERICA, THOUGH ONE OF THE BEST KNOWN WATCHES IN EUROPE FOR GENERATIONS

Manufactured by

**GEORGES FAVRE-JACOT & CO., Locle, Switzerland**

HIPP. DIDISHEIM & BRO., Sole Agents, { 49 MAIDEN LANE, NEW YORK.  
COLUMBUS BUILDING, CHICAGO.

The Latest Importation in Watches in this

## Ring Watch



IS THE  
**MOVEMENT  
Smaller Than  
a Ten-Cent  
Piece.**

ONE OF THE MANY EXCLUSIVE NOVELTIES THAT WE MAKE A SPECIALTY OF.

Our reputation for carrying the most exclusive novelties in imported watches is well known to the Jewelry Trade.

Write us immediately for information if interested in the new season's offerings.

**KLIPPER BROS., 59 Maiden Lane, NEW YORK.**

## 46 out of 99 PRIZES

were awarded to

## PATEK, PHILIPPE & CO.

in the Timing Contest of the Astronomical Observatory in Geneva, for the year 1905, comprising: The only First Unique Prize for Best Average Running; 2 First Prizes out of 3; 5 Second Prizes out of 10; 8 Third Prizes out of 18; 9 Fourth Prizes out of 24; 10 Honorable Mentions out of 23; 11 Simple Mentions out of 21. 11 Manufacturers participated.

68 NASSAU ST., NEW YORK.

GENEVA, SWITZERLAND.

**JULES JÜRGENSEN**  
**Watches and Chronometers**

PARIS—"THE GRAND PRIX"—1900

**SOLE**  
**RUDOLPH & SNEDEKER,**  
65 Nassau St., New York  
**AGENTS**

WATCHES OF PRECISION.

## Mathey Bros., Mathez & Co.

Manufacturers and Importers of

Superior, Plain and Complicated Watches.

Sole Agents for

**CHAS. H. MEYLAN.**

SMALL WATCHES A SPECIALTY.

WATCHES DEMAGNETIZED.



12 SIZE MOVEMENTS.

Brassus, Switzerland

21 MAIDEN LANE, NEW YORK.



12 SIZE SPLITS.

# PROSPERITY AND WATCH BUYING

**W**HILE THE WATCH as a staple necessity is always in demand, still sales are augmented in volume and value in periods of prosperity.

The present era of prosperity justifies optimism on the part of the Trade. Very little effort should suffice to increase your Watch business.

These offices, being Watch centers, encourage development in these lines in view of firm confidence in prevailing prosperity.

## J. W. FORSINGER,

LEADING AMERICAN WATCHES AND MOVEMENTS

CHICAGO  
103 STATE ST.

NEW YORK  
2 MAIDEN LANE



## Sessions Clocks

Superior finish. Reasonable prices.

Have you seen our

**New and Exclusive Designs**  
in Mantel and Hanging Clocks?

Write for Catalog and supplement.

### The Sessions Clock Co.

Main Office and Factories,  
Forestown, Connecticut, U. S. A.

New York Salesrooms,  
37 Maiden Lane.



## WHOLESALE

# DUEBER-HAMPDEN COMPLETE WATCHES

The conceded friend makers for the retail dealer. We are certain that we can help you make customers if you will write us for prices on Chains, Rings and all kinds of High-Grade Jewelry.

## WM. C. PENFOLD CO.

WHOLESALE JEWELERS

AND AGENTS FOR DUEBER-HAMPDEN WATCHES

818-820 Chestnut St., Philadelphia, Pa

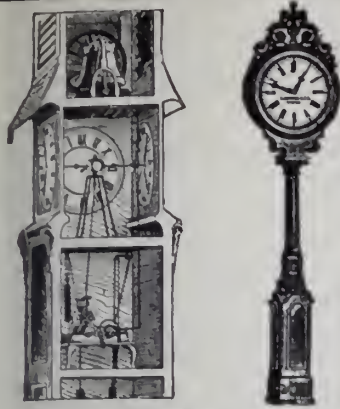

MAKERS OF

**Tower and Street Clocks**

For particulars write us, mentioning The Jewelers' Circular-Weekly.  
**E. HOWARD CLOCK CO.,**  
 ST. 1842. BOSTON, MASS., U. S. A.

**EARN WATCHMAKING AT HOME**

THE De SELMS CHART SYSTEM, copyrighted and patented. The simple, practical and up to the minute method of learning. Saves you time and money while learning and puts you in a position to than double your income.  
 million timepieces to be repaired. Accurate time is a necessity in the business world. When time is money the watchmaker gets his share of it. Positions for graduates. Booklet free. Write to-day.

**The De SELMS WATCH SCHOOL,**  
 109 Perry Street, ATTICA, INDIANA.

**MAEBERT & REISS**

WATCHMAKERS TO THE TRADE  
 Wheel Cutters and Adjusters

Accurate Work—Low Prices—Quick Returns.  
 We receive parcels by mail or express from all over the United States.

71 and 73 NASSAU ST., Corner John,  
 (the new "Cockcroft" Bldg.) NEW YORK.

**Expert WATCH and Chronometer REPAIRING**  
 FOR THE TRADE.

When others fail you we guarantee satisfaction. Trial will convince. Prices very reasonable.

List will be sent on request.

**G. OHAN,** 37-39 Maiden Lane,  
 (Hirsch Bldg., Room 27.) NEW YORK.

**Practical Course**  
**in Adjusting**

By THEO. GRIBI.

COMPRISING

review of the laws governing the motion of the balance and balance spring in watches and chronometers, and application of the principles deduced therefrom in the correction of variations of rate arising from want of isochronism, change of position and variation of temperature.

**ELUCIDATED AND DEMONSTRATED**

original experimental researches in the actual problem, never before published, showing the causes that are operative in the variation of rate, and leading to correct remedies. To which have been added chapters on

How to make a Balance Arbor with modern Appliances; How to Clean a Watch properly; and, the Lever Escapement—some Current Defects in it and How to remedy Them.

PRICE, \$2.50.

40 pages, including 18 diagram plates; Fine Paper; Large Type; Clear Illustrations; Systematically arranged; Solid Binding.

THE JEWELERS' CIRCULAR PUB. CO.  
 Publishers

11 John St., cor. Broadway, New York.

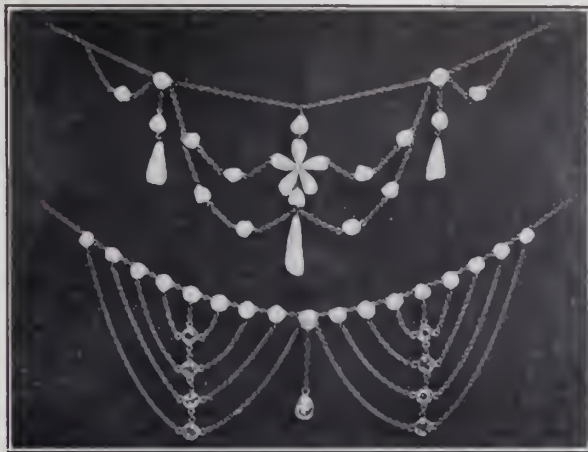

**FESTOON NECKLACES**

The increasing demand for high grade Festoon Necklaces has compelled us to make up a larger and more varied line of them than ever before, set in combination with Diamonds, Baroque Pearls, Aquamarine, Topaz, Peridots, Amethysts, Turquoise, fancy Sapphires, etc., etc.

CUFF BUTTONS BROOCH PINS BRACELETS  
 LOCKETS SCARF PINS

**COOPER & FORMAN** OFFICE AND FACTORY  
 MAKERS OF DIAMOND JEWELRY 3 MAIDEN LANE, NEW YORK

**The New Continental Watch Co.'s Movements.**



0, 12 and 16 Size. 7 to 21 Jewels.  
 All Bridge Model and Pendant Set.

Fitting all American cases without any change, interchangeable pendant set, have steel scape wheels, exposed pallets, double roller, Arabic or Roman dials, with and without marginal figures. CONTINENTAL WATCH CO. on bridges, C. W. CO. on dials except otherwise ordered. Special name or nameless movements require four months' time for delivery. Packed in glass show box inside paper box. No expense has been spared to make these movements the best on the market for the money. Every movement absolutely guaranteed. A full line of finished material constantly on hand.

For Sale by all Jobbers.

**JULES RACINE & CO.,** Exclusive Importers,  
 103 State St., Chicago. 37 MAIDEN LANE, NEW YORK.



**THIS IS HOW IT HAPPENED.**

Some few years ago we determined that first of all we were going to make the best Cuckoo Clocks that brains and skilled craftsmanship could put together; then we were going to sell them for as little as we could.

The expected happened. Quality won out as it always does. We have a country-wide reputation for making the best Cuckoo Clocks that have ever been produced, and with that reputation has come the largest Cuckoo Clock business in the world.

Better write for our new Catalogue.

**AMERICAN CUCKOO-CLOCK COMPANY**  
 Cuckoo Clocks and other Unusual Clocks  
 STATION S. PHILADELPHIA

**HEINTZ BROTHERS.**



• We Make the Largest Line of Solid Gold Set Rings in America for the Retail Trade •



That this department shall prove mutually beneficial to our readers, it is desirable that the members of the trade generally communicate with THE JEWELERS' CIRCULAR-WEEKLY regarding any advantageous device or plan which they are utilizing in connection with their business.

### Systematizing Stenographic Work.

HOW many business men know the average cost of letters typewritten in their offices? asks a writer in *Ad Sense*.

How many business men have introduced a system in their typewriting departments so as to secure the record of cost?

Which is the best method of conducting a typewriting department, a central and general force, or special stenographers for different departments?

These questions are of importance to all who desire to stop the small leaks and at the same time secure maximum results from the typewriting departments.

Before records of stenographic work can be fairly kept provision must be made for the introduction of a system which will keep the entire force constantly supplied with copy. A "copy box" will do this. This box may be an ordinary transfer file case, with the index removed, and should be placed as is most convenient to the majority of the stenographers. This box is filled with set or delayed work. The contents may include follow-up letters, personal letters to old customers, circular letters to special lists, special tabulated work; in fact, everything which can wait and is in no special rush.

When the stenographers or typewriters are out of regular work, and after they have notified the proper person, they go to the copy box and take therefrom the first copy on top.

The copy box proves a source of much time saving and profit, by saving stenographers loss of time in chasing about for work, and keeps the office force busy at profitable work. The device teaches the value of time.

The box acts also as a thermometer, indicating when it is necessary to increase or decrease the force. If the copy in the box has not been touched for a week it shows that the stenographers have been busy with their regular work, and the force may be increased temporarily; if, on the other hand, the proportion of set work completed during the week was unusually large, the number of stenographers may be decreased.

The copy box aids systematic record of the work done in the department by placing all the stenographers on an equal basis, and any record of letters written will be fair. A simple way to keep a record of letters written is to have each typewriter number her letters consecutively, and have the

reader at night quickly transcribe the number from the last letter of each on blanks provided for that purpose. At the end of the week it is an easy matter to figure the average cost of each letter.

Economically, the central or general method for the stenographic department is the best. The stenographers are placed under the direct supervision of a head stenographer, and as the services of typewriters are required by the different departments they are assigned by the person in charge of the department. As soon as the dictation is completed the stenographers return to the department to write their letters. Thus every available hour of the day is utilized, and there is an absence of novel reading by stenographers waiting for work.

With a special stenographer for each department, work is delayed when the stenographer is sick, or perhaps the stenographer takes advantage of the weaknesses of the department head and reports late in the morning if he is customarily late. There is also danger of favoritism being shown by this method, causing jealousy and discontent among the stenographers less favored.

It is the small leaks which consume the profits and prevent dividends, yet how easily these small leaks can be stopped. A system in the stenographic department will prevent friction, and if the stenographers are shown that the system is beneficial to those who do their best and make every moment count, they, too, will approve of it. The records will show the industrious and careful stenographer, and by these records reward or censure may be dealt out. Thus is established an incentive for better work.

### Living Within One's Income.

MOST spendthrifts have to keep even by schemes which savor more or less of chicanery. Young fellows behind the counter are apt to regard the ability to live partly by one's wits as rather clever and smart.

Dishonesty is certainly dishonesty, though, and calling it cleverness does not alter its disastrous effects. There is something wrong with the man who cannot live on his income. When he pleads that as an excuse for debts of dishonesty, he is talking tommyrot. "Cannot live on his income" means will not.

There is only one road for the man traveling above his class and that leads to the bankruptcy court.

### Business Courtesy.

IT is astonishing how unbusinesslike some men are in regard to the details of their business. There is, for instance, the matter of correspondence in which there are great many sinners. It is all very well to say that you dislike correspondence, but you are in business you are bound by business laws and one of the first and most important of these is to promptly take care of your correspondence. There is nothing that will injure a concern so much in the eyes of those who do business with it as neglect or carelessness in replying to communications. If you have not time to look after your business get more help. Inattention to those who call upon you is another unpardonable sin.

There are some manufacturers and wholesale salers, as well as retailers, who are the veriest boors in this respect. A gentleman called some time ago at a certain large establishment where the proprietor was busy at something in the office, and the clerks were so oblivious to everything but the work that he stood there 10 minutes without any one asking what he wanted. He walked out and took a good sized order with him to another concern where, as he said, they knew enough to look up when any one came in.—*Canadian Shoe and Leather Journal*.

### Ideas and Schemes.

VERY interesting is the little dog who sits in the show window of W. H. Gorman's store, 76 Seneca St., Buffalo, N. Y., and looks out upon the street and peeps with spectacles over his eyes. The dog is trained to sit quietly for hours. It changes attitudes at a signal from Mr. Gorman, and, best of all, he seems to thoroughly enjoy the part he takes in the duties of this store. When not in the window with the spectacles, he occasionally marches up and down the aisle on his hind legs to the enjoyment of the customer. Through all these antics he wears his glasses, which have been properly fitted by an optician.

An unusually attractive display was made in the retail jewelry store of S. W. Tassell, Danbury, Conn., recently. The store was attractively decorated in morning glories and violets and signalized the opening of a sporting goods department. Neat souvenirs were distributed to purchasers.

**Storekeeping Department.**

**Good Rules to Follow.**

DON'T worry—worry kills work.  
 Don't overeat—a sluggish stomach  
 makes a dull brain.  
 Don't smoke too much—tobacco kills am-  
 m.  
 Keep eight hours—more if you can.  
 Rest up" occasionally—a good razor cuts  
 better for it.  
 Get out medicine—fresh air and exercise  
 are the best doctors.  
 Wear light weight underclothing all year  
 round—give your skin a chance to breathe.  
 Your territory "goes dry," as you think,  
 always remember that there are one or two  
 boys laying for the chance to work  
 maybe you have a well full of water and  
 your pump—smoke up—pump harder.  
 Are you falling behind? Get started an  
 hour earlier—work an hour later. You'll  
 catch your buyer at both ends.  
 The price of good looks is right living,  
 and the reward of right living is health.  
 There is an intimate, an indissoluble re-  
 lationship between personal attractiveness  
 and success. Health and correct dress make  
 for attractiveness. For salesmen these qual-  
 itions are essential.  
 Getting orders means work—the greater  
 your number of calls, the more business you  
 will have to your credit.  
 Living up to a rule" is bad business in  
 approaching buyers. The only "rule" that  
 is valuable is that one made to fit each  
 particular call and customer.  
 Sin has many tools, but a lie is the  
 handle that fits them all." Salesmen who  
 lie for the firm to the customer, for the  
 customer to the firm and for themselves to  
 the firm, stack up as pretty fair handles.  
 This is a bit complicated—study it over.  
 Is any man worth a hundred thousand  
 dollars a year? The answer is, "yes," if he  
 can get it. Also, he can get it by earn-  
 ing it.  
 Daniel Webster once said in a famous  
 legal battle, "Here are the goods—look at  
 them." Right then he won the fight. An  
 ounce of sample case is worth a ton of  
 reasons—why-on-paper-salesmanship.  
 An authority says that 94 per cent. of  
 merchandising is done through the retailer  
 and only six per cent. by advertising. That  
 puts it up to you pretty strongly, Mr. Sales-  
 man.  
 As a rule a prospective buyer should  
 never be shown samples until he has been  
 talked to sufficiently long about the propo-  
 sition to become interested. When he is in-  
 terested samples can be shown very effectually,  
 and when properly shown the result is  
 an order in nine cases out of 10, but if im-  
 properly shown the result is a failure in  
 about the same proportion. Therefore, the  
 great importance of showing samples right.  
 To do this one must know what he is show-  
 ing them for. Samples are not shown to  
 give the merchant prices of which he knows  
 nothing and does not appreciate; they are  
 not shown to display styles of which he is  
 equally ignorant, nor to show him quality, for  
 a large number of buyers know absolutely  
 nothing about goods shown and consequent-  
 ly could not be interested in that. For

proper treatment in regard to these things  
 the merchant relies on the integrity of the  
 house from which he is buying.  
 Mr. New Man, remember that you have  
 many things to learn and if this business  
 does not come as you think it should the  
 first few days, do not let it discourage you.  
 You cannot fail if you apply your instruc-  
 tions intelligently and execute the work  
 vigorously.—*Ex.*

**Nuggets of Noodle Philosophy.**

DOND schlag your compedidor in your ad-  
 ferdisements. Auber you feel like doing  
 dot, just write oud dot adferdisements, und  
 den go py yourself all alone mit ein pox  
 of matches un read dot adferdisements oud  
 loud sehen oder ancht dimes und den bearn

**A Model Retail Jewelry Establishment of Germany.**

THE jewelers of this country, who for  
 some years have taken pride in the  
 fact that they were ahead of the Old World  
 merchants in their ideas as to store decora-  
 tion and more up-to-date in the methods of  
 displaying goods, will have to "look to their  
 laurels" if the movement manifest among  
 the German jewelers is to continue.  
 There is no doubt that jewelers of Ger-  
 many have given great attention to the sub-  
 ject of store appearance, and of recent years  
 many of them have remodelled their estab-  
 lishments in a way that would do credit to  
 merchants in artistic lines in any part of the  
 world.  
 An idea of an up-to-date German jew-



AN ATTRACTIVE JEWELRY STORE FRONT SEEN IN KOLN, GERMANY.

dem oop. You vill feel better, und der  
 public vill not laugh so mooch at your  
 oxbence.  
 \* \* \*  
 Noddings make a man feel so bully as to  
 vake himself in der morning, und remem-  
 ber dot Uncle Sam's post master depart-  
 ment vill haf a pig pundle of orders by  
 his office ven he gets dere alreaty. Ach!  
 der adferdising vas a great peeziess!

Dere is just as goot fishes in der sea as  
 effer Grover Cleveland haf catch alreaty.  
 Likewise, also dere is just as goot a chances  
 to make blenty money py adferdise as effer,  
 yes; but like Grover you must know der  
 ride kind of bait wearms to put der hook  
 on.  
 \* \* \*

I haf ein freund py der name of Sprach-  
 enlang, he makes me more tireder as a day  
 py hard vork. He dinks I like him to wisit  
 me effery vork, und he talks py der heur und  
 makes noddings ould. He is like many ad-  
 ferdisements, simbly sbace fillers. Even  
 reading matter is better as some adfertise-  
 ments.

S. Feuerstein, Green Bay, Wis., has  
 bought out the business of F. Kaiser.

elry store may be had from the illustration  
 on this page, which shows the front and  
 show window of the store of Jean Koch,  
 Koln. It is artistic in every detail. A no-  
 ticeable feature is the absolute adherence  
 to the secessionist style which has had such  
 a hold on German jewelers and their prod-  
 ucts in the last few years, manifest not only  
 in general effect, but in every detail of the  
 metal work, and even in the lettering.

For the illustration we are indebted to  
 the *Deutsche Goldschmiede-Zeitung*.

**A Stranger.**

This world is full of strange surprises,  
 You cannot fix or 'range her,  
 But the man who never advertises  
 Seems even more the *stranger*.

Louis S. Lowenthal, doing business under  
 the name of Mrs. Pauline L. Lowenthal,  
 Bradford, Pa., last week filed a voluntary  
 petition in bankruptcy.

Sweet Bros., Monticello, N. Y., are mak-  
 ing extensive improvements in the interior  
 and exterior of their store. New show  
 cases of quartered oak have been added, and  
 the old plate glass front is to be removed  
 and replaced by a larger one.

What Tool is of More Importance to  
THE MAKERS OF FINE JEWELRY than

**A FIRST CLASS SAW ?**

**SHARP—TRUE—UNIFORM  
—PERFECTLY TEMPERED**

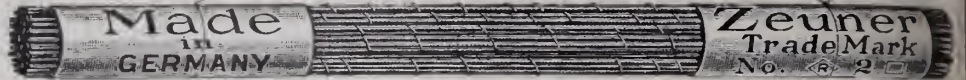

Such is the **ZEUNER SAW.**

**TRY THEM**, for "Only the Best are Good Enough," and only the Best are Cheap  
Trial orders promptly filled under guarantee of perfect satisfaction, which applies also to our  
"AMERICAN SWISS FILES."

**E. P. REICHELHLM & CO.,** 23 JOHN STREET, NEW YORK.

**HERPERS BROS..**  
MAKERS OF  
**BRACELET SETTINGS**  
IN 10, 14 AND 18 KARAT GOLD  
AND IN PLATINUM.  
ALSO A COMPLETE LINE OF  
GALLERIES AND FINDINGS.  
OFFICE AND FACTORY NEWARK, N. J., U. S. A. NEW YORK BRANCH 41-43 MAIDEN LANE  
12 NEW PATTERNS

**GLARDONS' SWISS FILES**  
are the  
**HIGHEST STANDARD**  
of Excellence.  
We are Sole Agents for the  
United States and Canada.  
**F. W. Gesswein Company,**  
Established 1868. Incorporated 1896.  
WILLIAM DIXON, PRES.  
Dealers in Fine Tools and Supplies,  
39 John Street, New York.

**DAY CLASS** | **ENGRAVING** | **NIGHT CLASS**  
THE SCHOOL FOR THOSE WITH MODERATE MEANS  
**POMFRET-GOLDY SCHOOL OF JEWELRY ENGRAVING**  
SEND FOR PROSPECTUS 319 HEED BUILDING, PHILADELPHIA, PA.

**A. Nonnenmann & J. Aschenbrenne**  
114-118 East 23d St., New York.  
**Original Designers** for Platinum Gold and Silver Jewelry. Artistic Designs for Silverware and Novelties furnished at shortest notice.  
"PRACTICAL COURSE IN ADJUSTING." Price, \$2.50.  
All Jobbers or Jewelers' Circular Publishing

**DIAMOND POINT FOUNTAIN PENS**  
  
No. 2WC \$7.50 per dozen. Guarantee in every box.  
Largest Manufacturers of Popular Price Fountain Pens in the United States.  
Send for Illustrated price list of 14 Kt. Gold Fountain Pens. Good case assortment 1 dozen pens, \$9.00.  
**DIAMOND POINT PEN CO.** 100-102 Beekman Street, New York

*Mercantile Fountain Pen* | **The Best Self-Filling Attachment**  
made and guaranteed by  
**AIKIN, LAMBERT & CO.,** 19 Maiden Lane, NEW YORK.  
Retail Price:  
**\$3.00**  
**\$3.50**  
**\$4.50**  
Send for Price Lists and Discounts.  
  
PATENT APPLIED FOR



# Workshop Notes & Queries



[Answers are also solicited from our readers to the questions published on this page.]

**QUESTION No. 1575.—Rusty Screws in broken Plate.**—How can I loosen a rusty broken screw in a watch plate? H. A.

**ANSWER:**—The easiest way is to heat the metal, when the expansion will often be sufficient to loosen the threads. If this will not do it, a strong solution of alum and water will dissolve sufficient of the steel if left in the solution for about 12 hours, so that it can be removed with ease. Pure nitric acid will become fluid if placed in a warm place, and this will accomplish the job more speedily. Neither the alum nor the nitric acid will injure the brass or the steel, if the latter is not too slight.

**QUESTION No. 1576.—Wood and Grain Alcohol.**—Is there any difference between methyl (wood alcohol) and grain alcohol in the application to such uses as occur in watch repairing business? R. L.

**ANSWER:**—Wood alcohol is seldom obtained in daily commerce as a pure article, and for this reason it is not safe to use it indiscriminately. In such a state as it is obtainable it is highly poisonous, and is bad for dipping parts of watches in it. Although it is much cheaper than grain alcohol, it cannot even be recommended for burning in lamps for blueing parts of watches made of hardened and polished steel. From an economical standpoint it is neither so recommended, as it does not give out as much heat when burned as grain alcohol.

**QUESTION No. 1577.—Rose Gold Finish.** How can I produce a rose gold finish jewelry and novelties? R. G. F.

**ANSWER:**—The current is the best regulator for producing the rose gold. In any cases where the current available is strong enough the gilding is simply burned on and then scratched off in such a manner as to produce the graded shade desired. The rose finish can, however, be brought out better by adding one-half an ounce of carbonate of copper to the gallon to the regular gold solution. The solution should also be used very hot, which materially assists producing the finish.

**QUESTION No. 1578.—Mahogany Finish Metals.**—How can I produce a mahogany finish on metals by the plating process? M. F. M.

**ANSWER:**—The metal pieces should first be plated in the regular acid copper solution, depositing the pieces from five to 10 minutes. After rinsing and washing, dip them into a solution composed of 1 gal. of water and ¼ oz. of sulphuret of potash, stirring the solution slightly. Now scratch the finish, using a little water in which has been added a little sal soda; lacquer when dry.

**QUESTION No. 1579.—Stop Off Varnish.** Please give me a formula for making

a good stop-off varnish that I can use for a worn gold solution. S. O. V.

**ANSWER:**—When necessary to use the solution warm then the solution should be in the very best condition, so that the gilding may be done rapidly, before the cyanide has had any effect on the varnish. Common air drying Japan, thinned down with benzole, painted on the articles to be treated and left to dry in a warm place, will answer as well as any stop-off varnish that can be prepared.

**QUESTION No. 1580.—Reducing Chloride of Silver to Metal.**—We have a lot of chloride of silver that we want to reduce to a metallic state. How can we do this? C. & CO.

**ANSWER:**—Take about four times its weight of the chloride of carbonate of soda and half its weight of pulverized charcoal and mix all into a paste; let dry and place in a crucible and reduce by heat. The silver will run to the bottom in the shape of a button.

**QUESTION No. 1581.—Silver Cleansing Soap.**—What is the best kind of soap for cleaning silver or plated ware, and which will not cause the metal to tarnish when dried in sawdust? B. J.

**ANSWER:**—Such soap ought to be used on all occasions, as very often soaps contain ingredients which do tarnish silver or silvered surfaces. The following is a good composition: Paris white, 5 lbs.; castile soap, ½ oz.; sweet oil, ½ oz.; liquid ammonia, 1 oz.; grain alcohol, pure, 2 ozs. The castile soap should be fine. Dissolve it in one quart of hot water, mix all the other ingredients, keeping the water very hot, and when properly mixed put in tin boxes and allow to cool.

**QUESTION No. 1582.—Antique Nile Green on Brass.**—I want to produce what is known as Nile green, and the metal to be treated is brass. Please inform me how I can do this? A. C. G.

**ANSWER:**—The brass is polished and a dead brush finish is produced; after washing, the pieces are immersed in a hot solution of water, 1 gal.; sulphate of copper, 5 ozs.; sulphate of iron, 5 ozs. The article should be kept in motion until the green color appears, and after washing and drying the piece should be well lacquered.

**QUESTION No. 1583.—Green Gold Coloring.**—Would you kindly tell me how to make a solution to obtain the green gold color, which at times is put on Roman gold jewelry? W. J. B.

**ANSWER:**—One way of producing the different colors on jewelry and lockets is to rub over with a little powder from a dust bag. It is afterwards heated in an iron pan to about 480° F. A solution for fancy coloring is made in the following manner:

Dissolve 4 ozs. of the hyposulphate of soda in 1½ pints of water, and then add a solution of 1 oz. of acetate of lead in the same quantity of water. Articles to be colored are placed in the mixture, which is then heated to a boiling point. The effect of this solution is to give different colors. It becomes successively yellow, red, scarlet, deep blue, light blue, bluish white and finally white, with a tinge of rose. By replacing the acetate of lead in the solution of sulphate of copper, brass becomes first of a fine rosy tint, then green and finally of an iridescent brown color. The following alloys which produce green gold will be useful in coloring articles of jewelry decorated with leaves, flowers, etc.: Fine gold, 1 oz.; silver, 160 grains; or, fine gold, 1 oz.; silver, 100 grains. Articles of gold may also be covered with a green gold color by the electrical process, by adding to a solution of double cyanide of gold and potassium a small proportion of cyanide of silver solution, until the desired tint is obtained. The solution should be worked cold or nearly so.

### To Improve the Snap of a Watchcase.

(Translated expressly for THE JEWELERS' CIRCULAR—WEEKLY from *La France Horlogère*.)

It is generally known that watchmakers often employ ineffective methods to restore the snap for making the back of a watch case close, as it ought to, and it will be useful, therefore, to publish a mode of

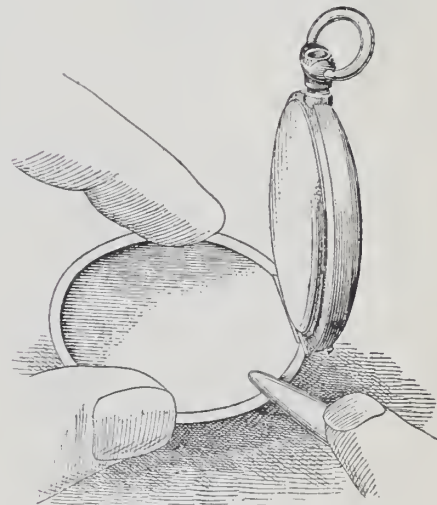

MODE OF STRENGTHENING THE SNAP OF A WATCHCASE.

restoring the snap of a watch case when it has become a little worn.

Provide yourself with a flat, oval burnisher and place the back of the watch case opened flat on some soft substance, such as a chamois skin. It is necessary to maintain the flat position of the back of the case. Charging the burnisher lightly with a little beeswax, rub the inner edge of the rim of the case, near the two sides of the joint, holding the burnisher almost horizontal, as shown in the illustration. Be careful not to touch the flat bottom of the case back.

Among the concerns which will be represented by floats in the industrial parade, to be held this month in Chattanooga, Tenn., is the Geo. W. Meyer Jewelry Co., of that place.

**C. DORFLINGER & SONS,**

36 MURRAY STREET, NEW YORK.

*Works, White Mills, Wayne Co., Penna.*

Manufacturers of plain and cut Table Glassware of the highest quality.



**ENGLISH :: GLASS.**

Large Assortment of  
FANCY VASES,  
GENTRE PIEGES and  
ROCK CRYSTAL STEM WARE,  
Particularly adapted for the  
Jewelry Trade.  
Write for particulars.

Sole Agent for the Celebrated CAULDON CHINA.

**EDWARD BOOTE,**  
46 West Broadway :: New York.



**Hat Pin Holders**

New, Practical, Pretty,  
and Quick Sellers.

No. 823. WRITE FOR PRICES.  
Hat Pin Holder.  
Ladore.

**Maple City Glass Co.,**  
CUT GLASS TABLEWARE,  
**Hawley, Pa.**

SALESROOMS:

- New York—H. B. Stiles, 253 Broadway.
- Baltimore—Green & Thomas, 33 S. Charles St.
- Boston—Sweetser-Bennett Co., 101 Tremont St.
- Buffalo—J. R. Stadlinger, 685 Main St.
- Indianapolis—J. A. Dugan Co., 22 S. Capitol Ave.
- Duluth—Duluth Crockery Co., 6th Ave. and West St.
- Denver—Western Selling Co., 1617 Lawrence St.



No. 3399. Loving Cup. Height, 10 inches.

**The Pairpoint Corporation.**

Send for Catalogue showing our complete line of

**Prize Cups and Trophies.**

BRANCHES:

- 38 Murray Street, New York City
- 36 St. Antoine Street, Montreal, P. Q.
- 717 Market Street, San Francisco, Cal.

FACTORY: NEW BEDFORD, MASS.

**SIGNS**

WHEN fixing your store, don't neglect the most important part—your SIGN. There's a great deal in getting your name before the public in the right way.

"No trouble to ship out of town."

**THE FORMAN CO.**  
SIX LIBERTY PLACE  
NEAR MAIDEN LANE · · · NEW YORK

Established 1879.

Manufacturer of

**LOUIS W. HRABA,**  **Fine Leather Goods,**

29 East 19th St., New York.

Exclusively for the Jewelry Trade.

**JACOT MUSIC BOX CO.,**  
IMPORTERS.

Stella and Ideal Music Boxes,

39 UNION SQUARE, N. Y.

**CLOCKS, BRONZES, CUT GLASS and ART NOVELTIES.**

WHOLESALE DISTRIBUTORS **COMMUNITY SILVER** SEND FOR CATALOGUE

**H. BEALMEAR & CO.,** 234-236 Park Avenue, Baltimore, Md.

# THE CONNOISSEUR

*Devoted to Art Pottery, China, Marbles, Bronzes, Cut and Decorated Glass Ware, Bric-à-Brac, Lamps, Art Metal Wares, Fancy Goods and Kindred Lines.*



## The History of Majolica.

The February and March issues of the *Keramische Monatshefte* appears an interesting article on majolica. This subject matter leads up to the beautiful ceramic and pictorial fine art ware produced in the last few years from the factory of R. M. Krause in Schweidnitz, Silesia (Germany). Numerous illustrations of this lovely ware accompany the reading matter.

Majolica ware is really," says the *Keramische Monatshefte*, "the ceramic art of the Middle Ages. At that time the art was naturalized on European soil. Toward the end of the Middle Ages it reached a perfection that brought forth some of the finest gems that ceramics and art can produce.

The zenith of perfection in production of majolica lasted over 100 years, and produced costly creations. Princes vied with each other in advancing this art and numerous celebrated art masters wedded themselves to it, and from them we receive the perfect works of art so greatly admired, even to this day.

The manufacture of majolica is a legacy from the Orient, whose people during their long period of territorial conquest planted the art on European soil. It is a true child of the East, and the art fits in so well with the time when the Moors ruled in the Spanish cities those handsome mosaics in honor of their God and appreciation of their great prophet.

But the technique of the manufacture of majolica of this people was limited. This knowledge advanced when the secret of its manufacture reached Italian soil. Here, under the ever-blue skies and the favoring breeze, breathed on by the pervading spirit of Christianity, the technique was enabled to expand and the art to expand. Here was art brought into being that could display the God of the Christian in all His might and glory. It was adapted to the representation of the Saviour and Redeemer in His life and work, His wanderings and His gospel.

Continuing, the article declares that Italy, toward the end of the Middle Ages, had lost its entire European trade with the Orient and the wealth that was derived from this commerce was largely used in the arts and sciences. Hence the lovely majolica creations from that land during those days.

But the discovery of America and other countries named Italian commerce, and art in that country declined. Thus the commencement of the second half of the 16th century witnessed the paralyzation of work in majolica. And no other country has shown so flourishing art in this line. The man-

ufacture of majolica since that time did not die out altogether, but had a miserable existence for hundreds of years in small workshops.

"At last, during the second half of last century," says the author, "some attention was paid to this art and since that time factories have risen which have brought out prominent productions. It is no longer Italy, however, where this art finds its home, but to every land of culture in Europe it has spread. Among others there are several factories in Germany which lay themselves out to create artistic examples. Among these latter is the majolica factory of R. M. Krause, in Schweidnitz, Silesia, started in 1883."

For the painting of landscapes majolica is both adapted and practical, as it permits the reproduction of the color tones as present in Nature, even in detail, and heightened loveliness, says this contemporary. And the majolica colors make possible the production of a picture of unlimited permanence, where other color arts blemish and fade.

## Reappraisements of China, Etc.

REAPPRAISEMENTS of decorated china and earthen ware were announced last week by the Board of United States General Appraisers, New York, as follows:

Decorated china from Haviland & Co., Limoges, exported Sept. 28, 1905, to Feb. 5, 1906, entered at New York (File Nos. 36955, 37822, 38601, 38526, 39050); findings of Hay, G. A.: Plates, 8½, Feston, decorated, A., entered at 5.15 francs per dozen; teas, 1st, do., entered at 5 francs per dozen; covered dish, do., entered at 2.60 francs each; plates, 8½, plain decorated, E., entered at 4.80 francs per dozen; ramikins and plates, Etoile, 18318, decorated, A., entered at 3.12 francs per dozen; pres tasses choc, Panson, 18318, entered at 4.55 francs per dozen; tea pots, 125, do., entered at 1.58 francs each; do., 75, entered at 1.06 francs each; net prices; plates, 8½, Etoile, 18318, decorated, A., entered at 5.15 francs per dozen; do., 6½, entered at 3.40 francs per dozen; do., coupe, entered at 3.40 francs per dozen; plats, ovale, 10 anses det or, do., entered at 90 francs each; do., 14, entered at 1.90 francs each. Add 5 per cent. And similar goods. Add cases and packing. All advanced 5 per cent.

Decorated earthen ware from Erico Orifici, Naples, exported Feb. 20, 1906, entered at New York (File No. 39231); findings of Board No. 2: Appliques Rose, Dapaveri, Tulipani and Crisantemi, invoiced at 65, advanced to 1 lire each. Add cases. Discount, 3 per cent. Previously published under reappraisement No. 6995, May 8, 1906.

Fahler & Landis, Allentown, Pa., recently displayed in their show window a bronze memorial tablet which will be erected in Lancaster, Pa., in memory of Wm. Koehler. The deceased was a member of the senior class of the local Theological Seminary.

## Dresden China.

THE term Dresden china has become almost synonymous with wares delicate and fanciful, for the porcelain we know best under this heading is distinguished, above all, for these qualities. The first manufactory was established at Meissen, near Dresden, its discoverer being John Bottger, protégé of the elector of Saxony, Augustus, "king of china maniacs."

Bottger's first productions were of red stone ware, specimens of which are very valuable. These were superseded in 1711 by the discovery of kaolin, which was necessary for the manufacture of fine, white porcelain. The greatest precautions were taken against the revelation of the composition of this porcelain, and for a while it was not introduced outside of Saxony, but later on imitations sprang up in France. Bottger died in 1719 and was succeeded in the management of the Meissen factory by Haroldt, and to this period belong the services decorated with Chinese figures and landscapes now so much sought after. This was indeed the golden age of the Dresden factory. Artists of eminence, such as Kandler, superintended and showed much delicacy in the execution of wreaths and flowers, birds and insects.

The factory suffered during the times of war, for in 1745 Frederick the Great entered Dresden, and several of the pieces were seized, the same thing happening again in 1759. When peace was restored Dietrich became director, but the factory and its product had deteriorated and made heavy demands upon the King's purse. He himself undertook the directorship about this time, and the period is known as the "King's period"—1778. Then followed the Marcolini period, one of red ornamentation, where we got the admired deep blue as a frequent ground floor.

Meissen porcelain, in the pure white, undecorated, was highly esteemed, and was used by the King for the purpose of presentation to those whom he delighted to honor; but specimens sometimes left the factory in white and were decorated outside. A Baron Busch is one of these decorators whose name has survived, for he was the possessor of the secret for engraving porcelain with the diamond and then rubbing in black coloring, so as to give the effect of an etching.

Much of the present Dresden china is modeled on the old styles, but both color and glaze are often too exaggerated to please the connoisseur.

The Charlesworth Optical Co. has just issued a new optical catalogue.

# LIBBEY

CUT GLASS

THE WORLD'S BEST.

"A Name to Conjure With"

The salesman's work is almost ended when he shows a piece of cut glass to the customer and says:

"This is LIBBEY'S"

All other makes are and must be judged by Libbey—no matter how much or how little you pay you can only buy Libbey perfection under the Libbey trade mark.

Customers from Maine to California know and understand this—that is why the Libbey dealer makes his sales with so little trouble.

The Libbey Glass Co.  
TOLEDO, OHIO

New York Salesroom, No. 57  
Park Place.

# Libbey

THE WORLD'S BEST

## LOOKING FOR THE NAME

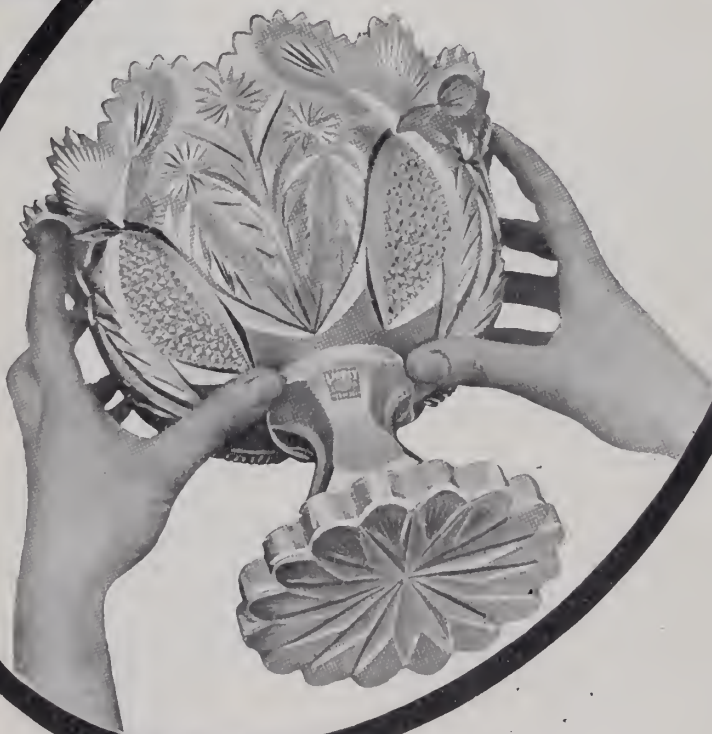

### REMOVAL NOTICE

We now occupy the new store of

The Lorsch Building, 35 Maiden Lane, N. Y.

## WOLFSHEIM & SACHS

MAKERS OF

Fine Boxes, Trays and Novelties for Jewelers and Silversmiths

35 MAIDEN LANE, N. Y.

Telephone, 3518 John.

Factory, 10 Gold Street.

### CRANBERRY LAKE REGION OF THE ADIRONDACK MOUNTAINS

a section full of large fish is described in New York Central Lines Four-Track Series No. 32, which contains a beautiful map of this region printed in four colors. Copy will be sent free, postpaid, on receipt of a two-cent stamp, on George H. Daniels, Manager, General Advertising Department, Room 61-A, Grand Central Station, New York.

THE



TAKE YOU TO THIS REGION  
FROM EVERY DIRECTION

C. F. DALY  
Passenger Traffic Mgr.  
NEW YORK

W. J. LYNCH  
Passenger Traffic Mgr.  
CHICAGO

### LEARN JEWELERS ENGRAVING

"The Engraving School that Graduates Experts."  
A fascinating, high-salaried and easily learned trade, taught thoroughly and practically by correspondence. Your instructor is the foremost authority and master workman in the world. We will teach the beginner better engraving by correspondence than he can gain in years of rigid apprenticeship. We will improve the skill of an engraver one hundred per cent. and make him master of the trade. The demand for competent engravers far exceeds the supply.

Send for handsome, illustrated prospectus.  
PAGE-DAVIS COMPANY.  
Suite 10, 90 Wabash Avenue. CHICAGO



### ELK TEET

Unmounted, genuine. Bought Indians, 10 to 300, as new sent on selection to responsible Jewelers at strictly wholesale prices; also

EAGLE, MOUNTAIN LI  
AND LYNX CLAWS.

L. W. STILWELL,

DEADWOOD, SOUTH DAKOTA  
Wholesaler of Sioux Indian Bead-Work and Curio Supply Jobber.

### Jewelers Having Tortoise Shell Goods

that have become dull or broken, can be them repaired, repolished and made as bright as new, at a small expense, by sending them to the manufacturer,

POTTER SHELL WORKS, Providence, R.

### The ST. JAMES

Corner Walnut and Thirteenth Streets  
PHILADELPHIA, PA.

The Ideal Hotel of Philadelphia  
European Plan EUGENE G. MILLER, Mgr.

Trade-Marks of the Jewelry  
Kindred Trad  
Second Edition. Price, \$3.00. The Jewelers'  
Circular Publishing Co., 11 John St., New York.

**A Suit of Importance to Importers.**

IMPORTERS in various lines are likely to be affected by a recent decision of the United States Supreme Court in the *Clerkhoff, Roffioer & Co.*'s case subjecting the firm to a penalty of double the value of a quantity of merchandise imported. It appeared from the testimony that merchandise had been taken from the company's store and distributed before the packages had been examined by the raisers. The decision of the court is based on a law which authorizes the government officials to call for the return of merchandise at any time within 10 days after the return of the invoice by the appearance of the port to the collector. In this case the collector made a demand for return of a package after it had left the possession of the importing company, which was, therefore, unable to comply with the order, and as a consequence was liable to the penalty.

V. Wickham Smith, the customs lawyer, says that the decision of the court is of a most far reaching consequence. He says, "The statute governing this case was enacted long ago when commerce was conducted along quite different lines than we pursue to-day."

Mr. Smith points out that an enormous quantity of imported goods is sold now before they arrive. Contracts are often over before the goods reach port, and under such circumstances it is important for merchants to ship from the port of arrival to purchasers in various parts of the country without any delay. The attorney makes several suggestions in order to relieve the present situation. One is that the collector and other executive officers exercise caution in the demand of the return of packages after they are delivered. The government, he urges, should increase its force at the larger ports in order to expedite the examination of packages in the public interest. It is further suggested that the Secretary of the Treasury has power to relax somewhat the present restrictions. While conditions may thus be ameliorated, he believes, that merchants, in order to obtain entirely satisfactory results should advocate remedial legislation by the present Congress.

**Chain Styles, Past and Present.**

WHAT has become of the old fashioned watch chain?" repeated the jeweler, smiling reminiscently. "I don't believe you could find one this side of the Red Lands, though a few of them may have been tucked away in strong boxes as curiosities. I've no idea what disposition has been made of them; I'm only sure I haven't seen any on one or sold one for years. Yet I can remember, as you can, when the real importance and financial standing of a man was supposed to be measured by the quality of his watch chain, and he took good care that he wasn't under-estimated. We used to handle chains that would slip an ocean liner into her dock without straining a link, and the sag of them would hold waistcoats all out of shape. Huge sets filled with hair or photographs were the proper caper. It was the same way with the watches, too. Some of them were

as big as alarm clocks and weighed three or four pounds.

"But all that's changed. The latest thing in pocket timepieces is as thin as a wafer cracker, and very light, modest chains are worn encompassing the stomach. Very 'dressy' gentlemen wear no chains. They want to create the impression that if they lose their watches they have plenty more at home or can afford to buy others."—*Providence Telegram.*

**Coloring of Gems by Radium Rays.**

GLASS is colored brown or violet by radium rays. A. Miethe studied the action of these rays on a large number of gems, and found that many of them are influenced by the rays. No general principles can be indicated, except that the more transparent gems show a greater tendency toward coloration than the opaque or highly colored ones.

Mr. Miethe used a preparation of 60 mgm. of radium bromide. A colorless diamond from Borneo was colored a light yellow after eight days and a decided lemon yellow after another eight days. On heating the diamond to 250° the yellow color was diminished, but it could not be entirely got rid of, even at a red heat. A colorless Brazil diamond showed no coloration.

A peculiar behavior was shown by a blue sapphire from Ceylon. After only two hours' exposure to radium bromide it showed coloration—green at first, then light yellow, and after a few more hours reddish yellow. After a fortnight it was dark yellow approaching chestnut. The color could be got rid of by heating, but the light yellow color always returned on cooling.

Rubies show no change, and tinted tourmalines very little. Brazil tourmalines slightly colored green and pink, respectively, at one end acquired the same color at the colorless ends on exposure to radium. This coloration took a day or two to appear.

**Time For the Tied.**

BISHOP OLMSTED, of Colorado, was talking at a dinner party in Denver, about June weddings.

"June is a lovely month," he said, "and that it should be the month of all months for weddings is a fact easily understood.

"I was amused by the remark a jeweler made the other day.

"The jeweler said that at this season it is a very common thing to see a well-dressed, handsome, intelligent looking young man come into his shop, and say, in a painfully nervous way:

"Um, ah, er—er—ah, er—ha, um—"

"In this contingency the jeweler simply calls to his clerk:

"Get out that tray of engagement rings, Jackson.'"—*Chicago Inter-Ocean.*

Merton S. Gurney, of Gurney Bros., Brockton, Mass, in his capacity as junior warden, took a prominent part recently in the celebration of its 50th anniversary by the Masonic lodge at Brockton, Mass.

George F. Ruppe, Waterbury, Conn., who was a former employe of the William L. Gilbert Clock Co., Winsted, has been appointed to a government position at Colon, on the Panama Canal.



FANCIFUL EFFECTS  
IN BOHEMIAN GLASS.

BOHEMIAN glass in unusual richness of coloring and variety of designs

is now being shown in the ware-rooms of Bawo & Dotter, 30 Barclay St., New York. The iridescent, blue, silver and straw colors are prominent, but other tints are also utilized in this collection. In the molding some clever embossed effects are produced, and these are supplemented by the work of the brush. Sea grass and other marine effects are favored. The shapes are as varied as the colors. A number of the vases are in the form of large sea shells, and there are various fantastic forms. A line of cut glass, recently received, differs from anything else now in the market, the company having taken the entire output of the factory. The designs include leaves, sheaves, an eagle and various free hand effects which are engraved on stone with a fineness almost like that seen in rock crystal. In this collection there are salad bowls, water pitchers, nappies, cheese dishes and other articles:

\*

NEW SAMPLES OF  
GLASS COMING.

AT the New York office of the J. D. Bergen Co., 38 Murray St., new

samples will make their appearance about the middle of this month, and buyers will find from that time on an increasing number of cut glass patterns for the coming season's trade. The catalogue will be ready about July 1, at which time the salesmen will start on the road. The force of designers have been particularly busy for several months getting ready for the new season.

•

The figures recently sent to the Department of Commerce and Labor giving the comparative production of eight of the principal industries of Japan during the years 1891 and 1905 show how greatly the porcelain and pottery industries of that country have developed in the past 14 years. According to the table in the report the production of porcelain and pottery in 1891 was 1,759,190 yen, while the product in 1905 had increased nearly three and a half times that sum, or 5,342,344 yen.

THE RAMBLER.

S. F. Spear has purchased a half interest in the business heretofore conducted by his brother, W. L. Spear, in McMechan, W. Va.

Harry Miller was recently arraigned in the Circuit Court in Jackson, Mich., accused of passing a forged check at the store of G. G. Case, of that place. Miller pleaded not guilty.



# ART Leather Goods

We now have on exhibition in our New York Salesroom a choice collection of  
**EUROPEAN NOVELTIES**

IMPORTATION ORDERS SOLICITED

**C. F. RUMPP & SONS**  
Philadelphia

New York Salesroom, 683 and 685 Broadway



## It's the Little Things that count.

The dainty little things that appeal at once to the casual observer. If it's useful, as well as ornamental, so much the better. Here is a **LITTLE THING**, so very useful and so pretty in design and finish, that you have but to show one to make a sale, and it yields a **BIG PROFIT**. It is called

## The Automatic Eye-Glass Holder

Can be used as well for a Pencil Holder. It is made in Enamel, Gold, Silver and Rolled Plate, in a variety of artistic designs. We fully guarantee every Holder. We mean it, and will replace any Holder that fails to satisfy. Samples sent upon request. Send for catalogue.

Est. 1832. **Kelcham & McDougall, Manufacturers,**  
37-39 MAIDEL LANE, NEW YORK.  
ALSO MAKERS OF THE LEADING LINE OF THIMBLES.



## ORNAMENTAL HAT PIN HOLDERS

A Useful and Artistic Conceit, in  
**SILVER DEPOSIT ON GLASS**

that contributes greatly to  
the appearance of any dresser

MADE IN A VARIETY OF HIGHLY ARTISTIC DESIGNS

Splendid sellers during the vacation period

**LACKNER & OHL**

50 Columbia Street

NEWARK, N. J.



## FANS

**FAN** SEASON is here, and we are prepared for it with the choicest line that has ever been imported from Paris. These dainty creations are appropriate for Graduation, Confirmation, Weddings, and in fact for any occasion, where taste and exclusiveness are requisite.

**LEWY & COHEN**

530 Broadway, NEW YORK

Importers of Fans, Brooches, Mounted Side and Back Combs, French Head Necklaces in mother-of-pearl effects, and THE "MEDICI CHAIN," a new French creation in fan chains.



SEND FOR A SELECTION MENTIONING PRICE

## Two Telephone Systems

in Greater New York would mean for Business Men

Two Books to Consul  
Two Bells to Answer  
Two Bills to Pay

## "Perfect Yourself"

in ENGRAVING and EXPERT WATCH WORK. Take a Post-Graduate Course.

RIES & ARMSTRONG, Macon, Ga

## TRADE-MARKS

OF THE

JEWELRY and KINDRED TRAILS

PRICE \$3.00.

PUBLISHED BY

THE JEWELERS' CIRCULAR PUB. O

11 John St., Cor. Broadway, New York

### Jewelers' Show Cases.

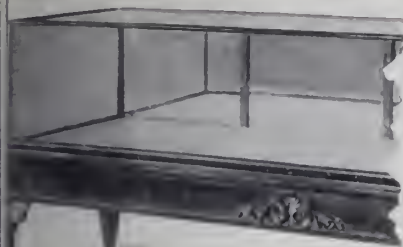

Our Small **ROSEWOOD MOULDING STEEL LINED CASE.**  
We Challenge the World to Produce a Better Case.

**F. C. JORGESON & CO.**  
11-17 N. ANN ST., CHICAGO.

Makers of all Kinds of

### Jewelers' Fixtures.

Write for illustrated circular.

OUR MOTTO: The best of Everything

### Automatic Bright Annealing Furnace

Bates & Peard Patent, Birmingham, Eng.

For Manufacturing Jewelers and Silversmiths and Watch Case Makers.  
Free from Oxides or Scale.

Illustrated Catalogue by

C. M. DALLY, Agent, 29 Broadway, N. Y.

Mention this paper.

### JOHN S. STIVEN, Gold and Silver Chaser.

Room 219, Electrical Exchange Building,

56 LIBERTY STREET. NEW YORK.

**CASTINGS** Gold, Silver, Bronze, Brass, German-silver, Copper & Iron, Supply Jewelers, Silversmiths, Die-makers, Mould-makers, etc.  
Unbreakable Bronze Forces. Hard Bronze Engraving Plates. Cast Iron Forces for making Steel Dies.  
Chandelier, Undercut Work, Statuary.  
**AUGUST GRIFFOUL,** 313 HALSEY STREET, NEWARK, N. J.

**Horological Department, BRADLEY POLYTECHNIC INSTITUTE,** Formerly Parsons Horological Institute, PEORIA, ILLINOIS.

Largest and Best Watch School in America. Teach Watch Work, Jewelry, Engraving, Clock Work, Optics. Tuition reasonable. Board and rooms near school at moderate rates. Send for Catalog of Information.

### PATENTS

Obtained on inventions and designs. Trade-marks, prints and labels registered.

**R. W. BISHOP,** ATTORNEY AT LAW,

108 C Street N.W., Washington, D. C.

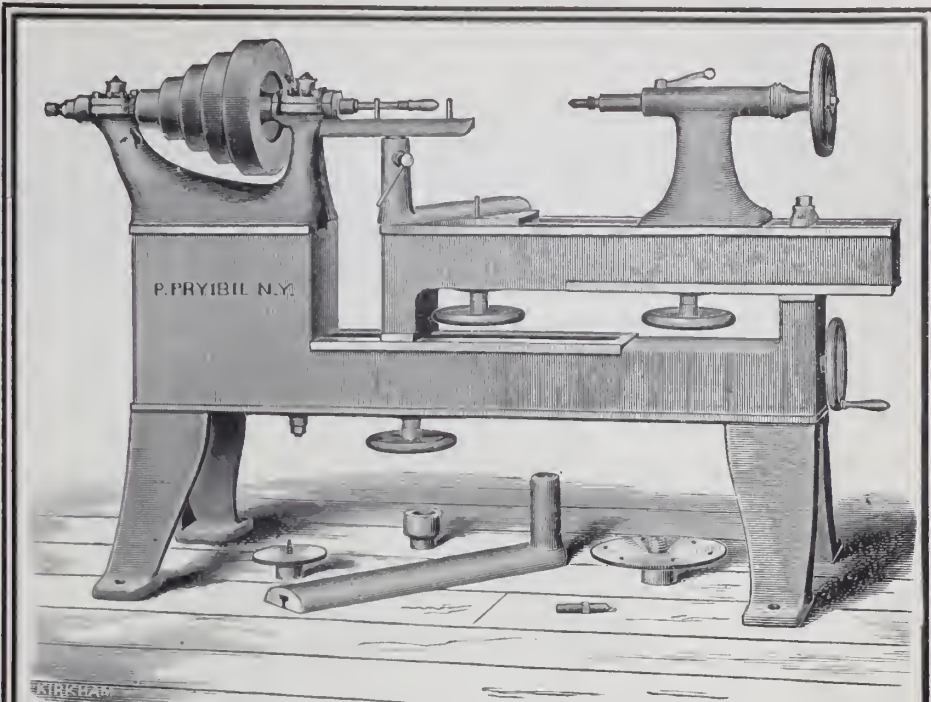

P. PRYIBIL N.Y.

Above Cut Shows Our

### EXTENSION SPINNING LATHE.

Swing of lathe 22 inches when closed, 44 inches when extended.

Substantially built for heavy work.

Write for Catalogue

**P. PRYIBIL,** 512-524 W. 41st St., New York.

### LEIMAN'S NEW SAND BLAST.

SIMPLE. EFFECTIVE. ECONOMICAL.

**NEW FEATURES**—Let us tell you about them.

**RESULTS**—Let us show you samples of work done.

### Improved High Pressure Blower

NOISELESS. INEXPENSIVE.

Delivers Greater Volume at Higher Pressure Than Any Other Made.

### LEIMAN BROS.,

Jewelers', Silversmiths' and Metal Workers' Machinery, Tools and WORK BENCHES,

141 Centre Street, NEW YORK.

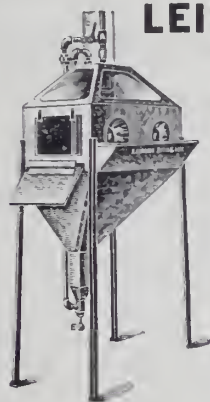

PATENTED.

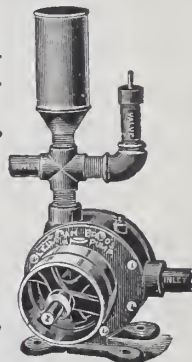

PATENTED.

### HAVE YOU SEEN OUR LINE ?

LARGEST VARIETY AND MOST COMPLETE LINE OF

**JEWELRY AND SILVERWARE CASES**  
WINDOW DISPLAYS AND SHOW-CASE EFFECTS

### ABE KASSEL

671-3-5 HUDSON ST.

NEW YORK

NEW YORK

WHY NOT SEND YOUR SWEEPS DIRECT TO THE SMELTERS?

# LEES & SANDERS, BIRMINGHAM, ENG.

Our plant is right up-to-date and specially arranged for smelting jewelers' sweepings.

SEND ON AN ENQUIRY FOR REFERENCES ON YOUR SIDE.

ESTABLISHED IN 1870.

**BLANCARD & CO.,**  
96 MAIDEN LANE,  
NEW YORK.  
WELL MADE GOLD FINDINGS.

ROLLED GOLD PLATE  
**SEAMLESS WIRE AND TUBING**  
DUNBAR, LEACH, GARNER CO.,  
MANUFACTURERS,  
ATTLEBORO, MASS.

WM. F. RENZIEHAUSEN CO.,  
GOLD and SILVER REFINERS  
Sweep Smelters, Assayers and Analytical Chemists  
Rolling of FINE AND STERLING SILVER a Specialty.  
Long Distance Telephone, 3759-R. 45-49 Oliver Street, NEWARK, N. J.

**Opportunity**  
Knocks at everyone's door at least once.  
This is yours if you would realize full value on your sweeps, etc.  
**CONLEY & STRAIGHT,**  
Gold and Silver Refiners,  
Assayers and Sweep Smelters,  
236 EDDY STREET, - PROVIDENCE, R. I.  
Dealers in Fine Gold, Silver and Copper. All kinds of Gold and Silver Anodes.

**CRUCIBLES**  
Jewelers' Supplies, Etc.  
Established 1850.  
**J. & H. BERGE,**  
98 John Street, NEW YORK.

F. JEANDHEUR, Jr.  
Rear 17 John St., N. Y. Third Floor  
**Gold and Silver Plating**  
SPECIAL WORK AND COLORING  
IN ALL SHADES A SPECIALTY.  
Established 1868. **Platine Platin**

**JAMES J. DONNELLY,**  
Gold and Silver Electro Plater,  
Fire Gilder and Colorer,  
41 and 43 Maiden Lane, New York  
Prompt Attention Given to Mail Orders.

HONEST AND  
PROMPT RETURNS FOR  
YOUR OLD GOLD,  
SILVER FILINGS,  
SWEEPINGS  
&c..

**WE BUY.**  
Old Gold and Silver Filings, Polishings, Sweeps, Hand Washings, etc. We will make accurate valuations and hold consignment subject to your acceptance. If valuation is not satisfactory, we reship to you at our expense.  
**WE PAY FOR OLD GOLD:**  
22 K. 88c. per dwt. 12 K. 48c. per dwt.  
20 K. 80c. " " 10 K. 40c. " "  
18 K. 72c. " " 8 K. 32c. " "  
16 K. 64c. " " 6 K. 24c. " "  
14 K. 56c. " " 4 K. 16c. " "  
**MARKET RATES FOR SILVER AND PLATINUM.**  
Try us and you will appreciate our Squareness, Promptness and Accuracy.

**WE SELL**  
Gold, Silver and Platinum, various qualities, rolled flat or drawn to wire of any gage.  
**PRICES OF ALLOYED GOLD:**  
10 K. 48c. per dwt. 14 K. 64c. per dwt.  
12 K. 56c. " " 16 K. 72c. " "  
18 K. 80c. per dwt.  
Gold and Silver Solder, either from formulas furnished or our own, "T. B. H." Alloy, 25c. per oz. Guinea Gold, 75c. per lb. Shot Copper, 40c. per lb. We will send tables for alloying without charge. They save figuring.

**T. B. HAGSTOZ, Ltd.,** Main Office, 709 Sansom St., Philadelphia, Pa.  
SMELTERS, ASSAYERS, REFINERS.

# PLATINUM AMERICAN PLATINUM WORKS NEW YORK OFFICE 41 Cortlandt Street NEWARK, N. J.





M 2281

# FAHYS Montauk Case



M 2280

There must be a reason why all the jewelers who stocked the Montauk Case in 1905 are buying it again in 1906, and will continue to do so. There is. It is because it is a case they know, a case they can rely upon, a case that has been upon the market for over twenty years and withstood all competition, it is a case that will outlive the present generation of jewelers and be handled with the same satisfaction by their successors.

JOSEPH FAHYS & CO.

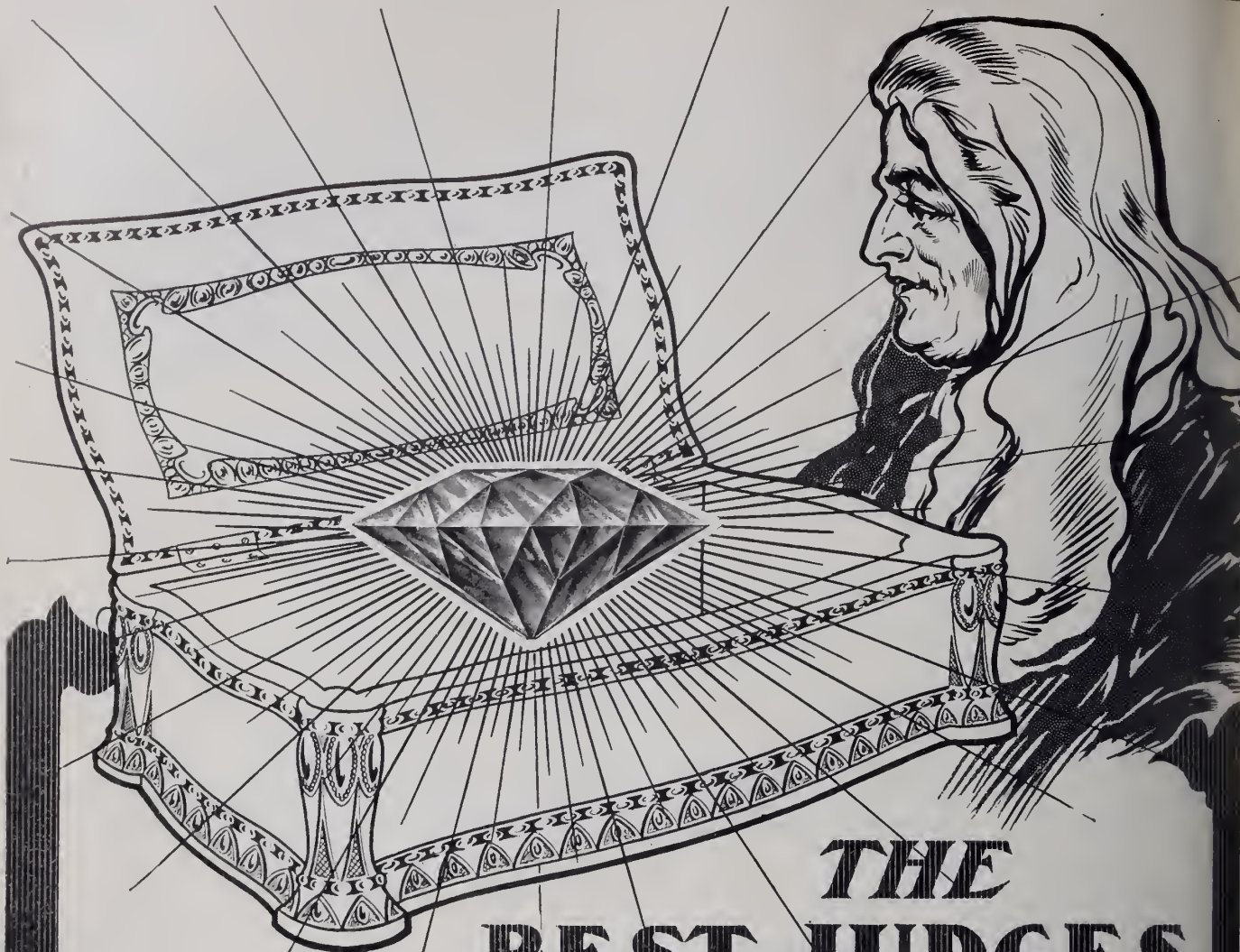

## THE BEST JUDGES

Are the most critical as to the cutting, when considering the worth of a diamond—it's the cutting that makes the diamond brilliant—it's because of its brilliancy that the diamond is so highly prized.

The diamonds we offer are cut in our own cutting works, and no effort spared to see that they are cut right. The price we ask for them—the actual cost of the rough stone, plus the workmen's wages, with our modest profit added.

---

**J. R. WOOD & SONS,**  
Diamond Cutters,

Cutting Works:  
1327-1329 Atlantic Ave., Brooklyn.

2 Maiden Lane, New York.





## We Stand Behind Everything We Sell

guaranteeing it to be exactly what it is represented to be.

You can be perfectly sure that you are getting the quality you think you are buying, and that the workmanship is the very best obtainable—while you are paying nothing extra for this, for our prices are the lowest it is possible to furnish honest goods for.

---

**J. R. Wood & Sons,**

RING MAKERS,

2 Maiden Lane,

New York.

# Design, Workmanship, Quality and Durability

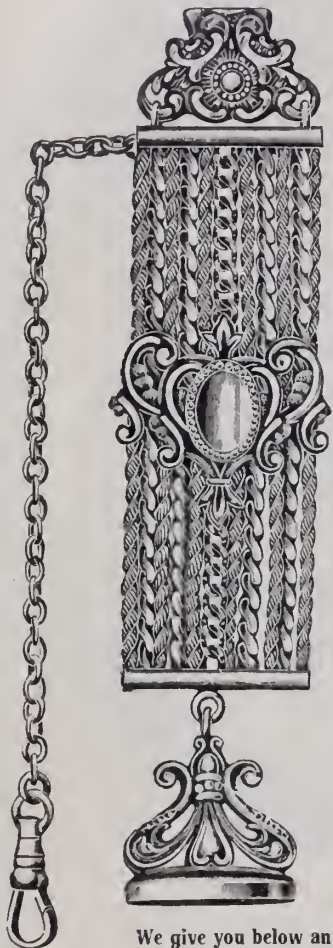

are the four factors which have made the

## BIGNEY CHAINS

the most popular in the market to-day. They are handled and worn by more people than any other make.



We give you below an exact copy of an assay of chains manufactured by the leading chain makers of the United States.

1-10 GOLD FILLED WATCH CHAINS, MINUS BAR AND SWIVEL.

Number	Gross Weight		Fineness	Value	Maker	Chain Number	Cost
	Ounces	Dec.	Gold 1000ths				
15		71	29½	\$0.43	S. O. Bigney & Co. - - - -	1155	\$2.85
16		75	50	.775		482	3.08
17		81	34	.57		3005	2.73
18		76	23½	.37		9533	2.97
19	1	00	16½	.34		83	2.14
32		52	49½	.53		213 X	2.83
34		73	34½	.52		733	2.41
46				.58		5011	3.82

1-8 CHAINS, MINUS BAR AND SWIVEL.

Number	Gross Weight		Fineness	Value	Maker	Chain Number	Cost
	Ounces	Dec.	Gold 1000ths				
35		57	68	\$0.80	S. O. Bigney & Co. - - - -	1604	\$3.96
36		60	65½	.81		7015	3.75
37		60	63	.78		4324	4.00
47		49	79	.80		2726	4.00

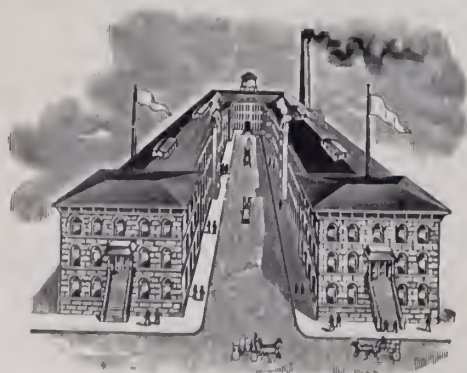

# S. O. Bigney & Co.

NEW YORK OFFICE,  
3 MAIDEN LANE.

FACTORY, Attleboro, Mass.



# Watch Case Makers, Remodelers and Repairers.

SPECIAL CASES  
MADE TO ORDER  
FOR ENGLISH, SWISS  
AND  
AMER. MOVEMENTS.

MELTING OLD GOLD  
CASES AND MAKING  
OVER INTO NEW  
CASES (USING SAME  
GOLD) A SPECIALTY.

ENGLISH CASES  
CHANGED TO FIT  
AMERICAN S. W.  
MOVEMENTS  
WITHOUT  
ALTERING OUTSIDE  
APPEARANCE.

KEY WIND CASES  
CHANGED TO STEM  
WIND.

HUNTING CASES  
CHANGED TO  
OPEN FACE.

OLD WATCH CASES  
REPAIRED AND  
RENEWED.



**Wendell & Co.,**

**2**

**WONDERFUL SHOPS:**  
103 & 105 William St.,  
NEW YORK.  
57 Washington St.,  
CHICAGO.

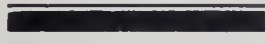

How an English Case Came to Us.



How it was Remodeled for Amer. S. W. Movement.

## New Claws on Diamond Rings.

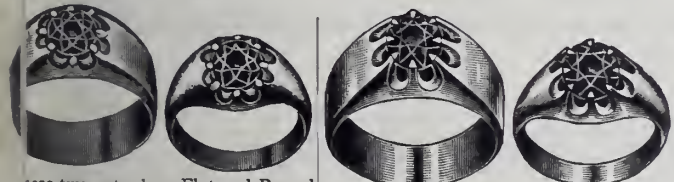

These two cuts show Flat and Round  
Ber Rings as received, with claws  
worn off and too low to permit  
setting stones again.

These cuts show the same rings with  
new high claws, stones securely reset,  
and entire rings refinished like new.

Price for six new claws, resetting stone and refinishing ring like new  
.....\$1.50 to \$3.00, list.

Price for eight new claws, resetting stone and refinishing ring like new  
.....\$2.00 to \$4.00, list.

We retip or put new claws on diamond Tiffany, Belcher, Tooth and  
rings of every description, to cost from \$1.50 to \$4.00, list, according to the  
condition of ring and number of claws on setting.

## Wendell & Company,

103 and 105 William St.,  
NEW YORK.

57 Washington St.,  
CHICAGO.

For 22 years we have been doing

# Gold and Silver Plating.

Sterling and Plated Ware Repairing for the Trade.

Do we do yours?  
Our plating rooms are the best equipped in the country for job work.



How It Came In.



How It Went Out.

### WE REPAIR

any article in the silverware line;  
making new parts to match the old  
ones that have been melted or broken  
off, the same as new.

### WE REPLATE

any metal article in gold, silver, nickel,  
bronze, brass, oxidized silver, old  
bronze, statuary bronze, and all  
antique finishes.

## Wendell & Company,

Repairers and Special Manufacturers for the Retail Jewelry Trade

**TWO WONDERFUL SHOPS:**

103 and 105 William Street,  
NEW YORK.

57 Washington Street,  
CHICAGO.



## Stone-Setting.

We carry a most complete stock of Precious and Semi-Precious Stones  
for special work and replacing lost sets. We import them direct from the  
cutters in Europe, and furnish them to the trade in single stones at dozen  
and gross prices.

Have your stone-setting done in our shops and save from thirty-five to  
fifty per cent.

We employ first class setters, and turn out work very promptly.  
No job too small to receive our careful attention.

## Gold Chains Refilled, Renewed and Repaired.

Old Chains made over into new patterns, using same gold.

**GOOD WORK. LOW PRICES. PROMPT ATTENTION.**



Sample Job as Received.



As Delivered.



Fancy Link Chain as Received for Renewing.



As Delivered.

## Wendell & Company,

The Special Manufacturers for the Retail Jewelry Trade.

**TWO WONDERFUL SHOPS:**

103 and 105 William Street,  
NEW YORK.

57 Washington Street,  
CHICAGO.

## WADSWORTH PERMANENT

THE WORD "PERMANENT" naturally carries weight. Purchasers want *lasting quality*. This is as true of filled cases as of solid—maximum of wear is the final test.

### **"WORTHY OF ITS NAME."**

The above phrase is linked with the WADSWORTH "PERMANENT" WATCH CASE. To Durability is added Style; and to both, Inexpensiveness. Jewelers endorse these claims.

## *The* Wadsworth Watch Case Co.

CHICAGO  
Columbus Building

SAN FRANCISCO  
717 Market St.

NEW YORK  
49 Maiden Lane

FACTORY, DAYTON, KY.

---

---

The Case that has won the Permanent Friendship  
of all who have Made its Acquaintance.



Your Jobber can Introduce You.

## The Wadsworth Watch Case Co.

CHICAGO  
Columbus Building

SAN FRANCISCO  
717 Market St.

NEW YORK  
49 Maiden Lane

FACTORY, DAYTON, KY.

---

**I**T is the unanimous opinion of those jewelers who have examined the new O and 12 size movements of the ILLINOIS WATCH CO. that they are the best watches in these sizes ever manufactured in America.





**S**ILVERWARE destined for the general service and adornment of the table should, in order to be wholly satisfying, possess not only a markedly decorative effect, but an opulent dignity and a well defined individuality of design.

¶ It is the belief of the Whiting Company that in their new Louis Quatorze pattern, which has been applied to every article suitable for table use, these essentials of success are very prominently displayed.

¶ With the confidence born of this belief, therefore, they beg to call attention to their novel and original treatment of one of the most popular, as it is one of the most effective, of historical styles.



**WHITING MFG. CO., SILVERSMITHS**  
 Broadway and 19th Street, New York.

# Is There a Watch Trust ?

Is a Live Topic at the Present Time in Congress.

## **This Question Will be Fully and Able Elucidated**

and every jeweler is urged to keep posted on this subject, as it will be not only instructive, but profitable to know of abuses that are of vital interest to all who sell Watches.

Why should the retail jeweler have to pay more for Watches than do department stores and mail order houses and scheme trades? is an old question.

**And now comes another question of discrimination that is worthy of long discussion in the Congress of the United States.**

The essence of the question is:

**Why can American Watches be bought in other Countries for little more than half of what Americans at home have to pay for them ?**

All who have the interest of the Watch business at heart can have copies of the speeches on this subject sent on application.

## **The W. J. JOHNSTON COMPANY,**

Wholesale Agents for the Leading American Watch Companies,

**Fifth Avenue and Market Street, Pittsburgh, Pa.**

# **The W. J. JOHNSTON COMPANY,**

Wholesale Agents for the Leading American Watch Companies,

**Fifth Avenue and Market Street, Pittsburgh, Pa.**

We present a list of Watch Companies that we are Wholesale Agents for, each and all of whom are **Free, Independent** and **Self-respecting**, who manage and mind their own business, and depend only on the merits of their goods to make sales for them.

Not one of these Companies is a member of any Watch Trust or allied to any Watch Combination, and in no manner requires Alliances to help, or force, the sale of its products.

## **The Dueber-Hampden Watch Co.**

**Illinois Watch Co.      Hamilton Watch Co.**

**Trenton Watch Co.      Seth Thomas Watch Co.**

**New England Watch Co.**

**Joseph Fahys & Co.      Wadsworth Watch Case Co.**

**Dueber Watch Case Co.**

The products of these Companies are made for The American Market and they recognize the right of Americans to get as much for their dollar as do the people of other countries.

## NATURAL WEAR MACHINE

Devised for the purpose of testing the actual wearing quality of **COMMUNITY SILVER**, in comparison with other makes of plated ware.

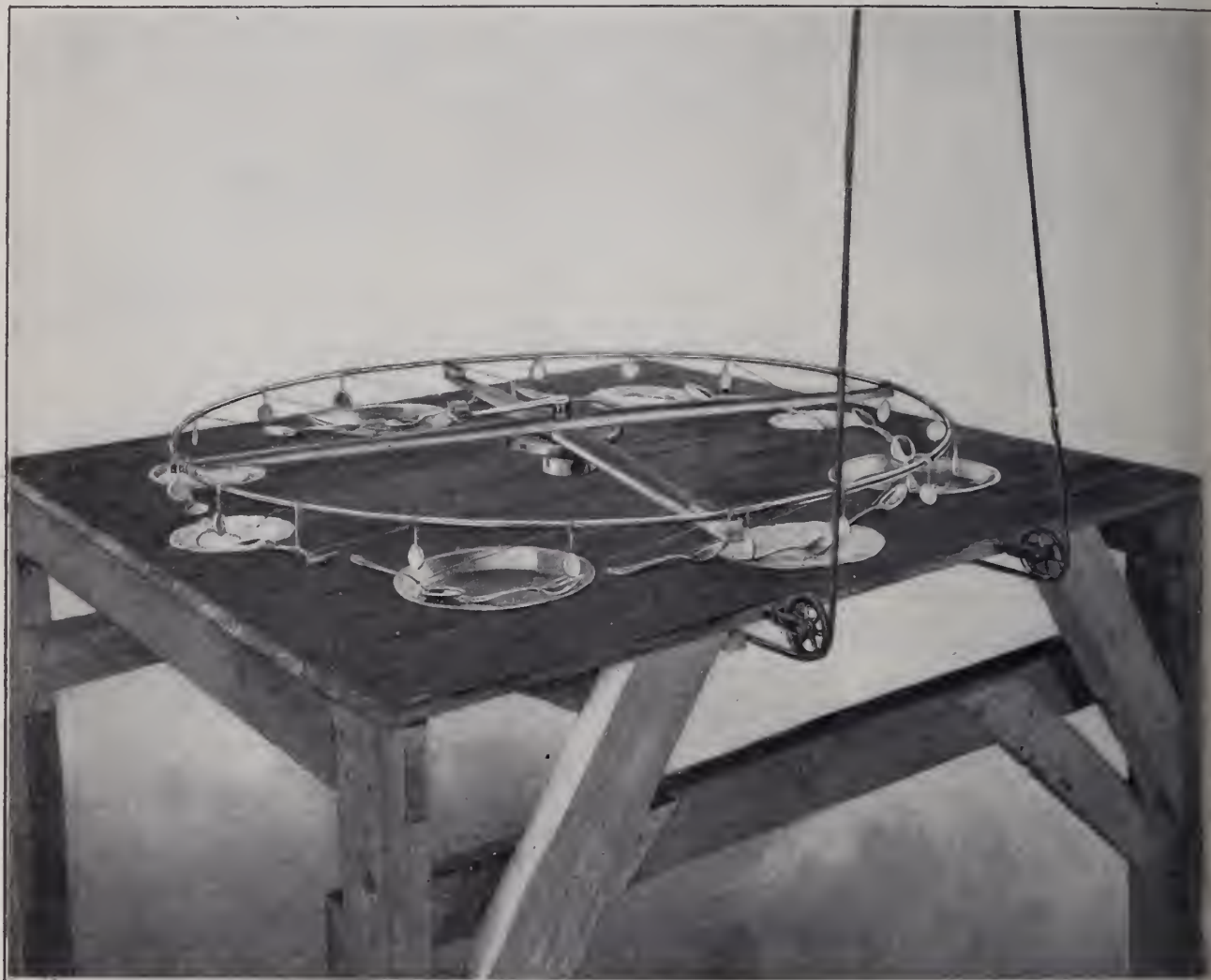

**ONEIDA COMMUNITY, LTD.**  
**ONEIDA, N.Y.**

Founded in 1848.

New York Salesroom: 395 Broadway

## MILES OF WEAR

**I**T'S A ROUGH ROAD that Silverware often has to travel. Bang and rattle attend its cleaning at the hands of over-strenuous servants.

To withstand such wear, the especially heavy plate of

# COMMUNITY SILVER

is a veritable coat of armor. This is demonstrated by the practical test shown in the illustration:

PLATED WARE OF VARIOUS MAKES SUSPENDED ON A REVOLVING ARM, WAS DRAWN ROUGHLY OVER VARIOUS OBJECTS, SUBJECTING IT TO THE HARDEST WEAR IT WOULD BE LIKELY TO MEET IN ACTUAL USE.

Before showing signs of wear **COMMUNITY SILVER** traveled a distance of nearly eighty miles—distancing the very best of its competitors. An unusual test of wearing quality, but an exact and practical one.

Remember that **COMMUNITY SILVER** gives best value to the consumer, and the most generous profit to the dealer.

**ONEIDA COMMUNITY, LTD.**

**ONEIDA, N.Y.**

Founded in 1848

New York Salesroom: 395 Broadway



---

**T**HE continued and widespread demand for Simmons Armilla shows pretty conclusively that the fashion of bracelet wearing is still growing. Beyond peradventure, there's going to be a brisk business in bracelets this coming Fall, and you'll make no mistake in choosing your Fall line now.

Surely, you won't see a more varied or attractive selection than the various styles, patterns and finishes of Simmons Armilla which the jobbers are ready to show you.

The Armilla is made in gold-filled stock (Simmons quality) and in 10K. and 14K. solid gold—affording an ample range of price for all classes of trade.

---

## R. F. SIMMONS COMPANY

Main Office and Works, ATTLEBORO, MASS.

Salesrooms: 9-13 Maiden Lane, New York.  
42 Madison St. (Heyworth Bldg.), Chicago.

*"We never follow the Fashion, the Fashions Follow Us."*

MAURICE L. POWERS.



*Always in Red.*

JOSH W. MAYER.

## COLLARS.

ONE of the reasons why we are able to produce Diamond Jewelry of such high order is because our jewelers take more than a merely mechanical interest in their work. Every one possesses artistic skill in a high degree and is permitted an individual freedom in working, which gives every piece the stamp of individuality.

Take for instance our beautiful new Collars. We shall show the most complete transformation of designs that has ever been shown in this country. There is no special period in the designs thus produced.

In order to get an excellent insight of the remarkable character of these goods, it will require a visit to our exhibition which takes place in our offices from August 13th to 18th inclusive.

This exhibition, we believe, transcends all that have gone before. It is extraordinary in its power and scope. Created by conditions, unusual and beyond control, we invite your interest in this display with the assurance that it presents the most impressive collection of fine and inexpensive Diamond Jewelry which we have yet been in a position to offer. Much depends upon the purpose and the intent of an event such as this. That you may determine whether it reaches the level of your taste and needs, we would have you know the purpose and intent which guided the organization of our annual exhibitions.

Once a visit always a visit.

### POWERS and MAYER,

Makers of Diamond Mounted Jewelry THAT SELLS.

258-260 Fifth Avenue,  
NEW YORK.

We are always pleased to ship goods on memorandum when satisfactory references are given.



### It's Time to Go Camping and Yachting

Every jeweler, to meet the demand, should have a supply of Sternau Chafing Dishes—especially the folding Chafing Dishes, which take up but a small space and are indispensable for camping and yachting parties—as warm luncheons can be prepared in them to suit the most fastidious. Made in Nickel-Plate and Silver-Plate.

Prices on request.

New York Salesrooms:  
Park Place, cor. Broadway,  
Opposite Post Office.

**S. STERNAU & CO.**  
*Makers of Coffee Machines, Trays, Fancy Kettles,  
Smoking Sets, etc.*

Office and Factory  
195 Plymouth Street,  
Brooklyn, N. Y.



No. 1511.

## As the Leader is Es- sential to the Band,

as the baton is necessary to the leader, so is our line needed to complete the stock you already carry.



No. 1539.

It is the baton and the band, so to speak. It is positively the leader of them all. Send for selection package, either mounted or unmounted, of our

- Locketts
- Buttons
- Brooches
- Bracelets
- Fobs
- Match Boxes



No. 1552.

- Pen Knives
- Cigar Cutters
- Scarf Pins
- Bead Necks
- Heart Charms
- Tie Clasps, etc.

**10K. THAT IS 10K.**

**ROBT. LEVY,** MANUFACTURING JEWELER  
Green and Columbia Streets, NEWARK, N. J.





# DUEBER

Ten Karat, **DOUBLE STOCK**, Twenty Year Cases.

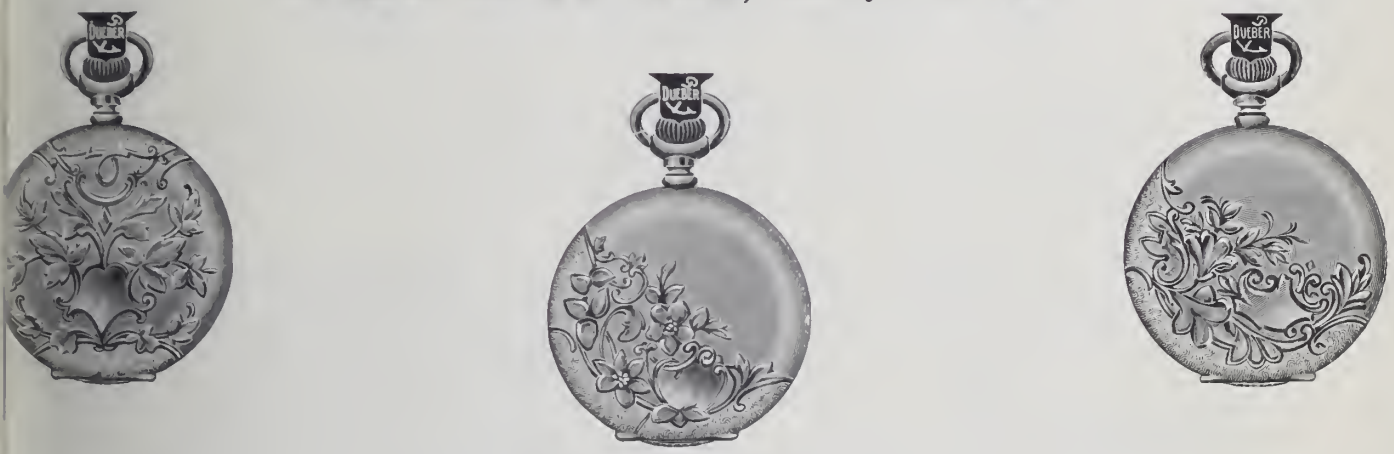

The Best Ten Karat Filled Case ever placed upon the market.





**J**UNE is the month of roses and we are busy all month turning out "Rose" jewelry for the Fall season. Our trade-mark, the "Rose," on any article stands for quality and excellence and has a reputation of forty years back of it.

Our new seller, "The Rose" thin model, 15 jewel watch, cased up by the Crescent Watch Case Co., is moving rapidly and the trade who have handled same report sales right along. We have placed a rush order for an additional large quantity. If not already supplied, write us for sample.

## HENRY FREUND & BRO.,

71 NASSAU STREET, NEW YORK.

Elk and Eagle Goods a Specialty.

"Sellers of Sellers."



We Make

# BRACELETS

both in Joint and Nethersole — with and without stones.

Call on us for the P. & B. Co. lines of

FOBS, LOCKETS,  
TIE CLASPS, BROOCHES,  
SCARF PINS,  
HAT PINS.



BABY PINS, BEAD NECKS,  
CUFF BUTTONS,  
CROSSES, BRACELETS,  
AND WAIST SETS.

We are the largest  
Exclusive Makers of  
10K. Jewelry.

Potter  
&  
Buffinton  
Co.,  
Providence,  
R. I.

NEW YORK OFFICE,  
65 Nassau Street.

San Francisco Office,  
206 Kearny Street.

Our New  
ACME  
Joint.  
Pat. May 22 1906.



Stamp  
Our  
New  
Mark  
On  
Your  
Memory



It  
Is  
A  
Guarantee  
Of  
Quality

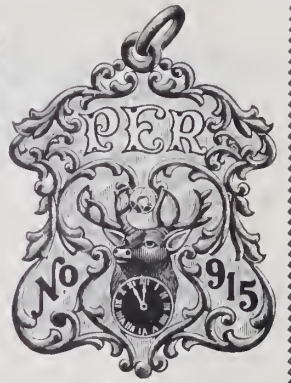

## GOING TO DENVER? WE ARE.

Our Goods Will Be Displayed Exclusively In The Largest Stores.

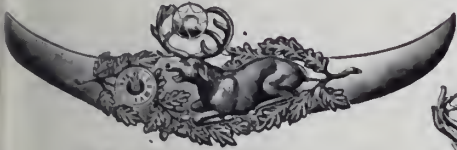

This is the time for Jewelers to stock up. The coming Convention at Denver is certain to give a decided impetus to sales.

## THE GUSTAVE FOX CO.

Largest Manufacturers of Emblem Goods in The World.

Main Office and Factory, 14-16 E. Fourth St., Cincinnati, O.  
CINCINNATI                      ANTWERP                      SAN FRANCISCO



## THE Bracelet Hit OF THE Season.

THE illustrations, which are exact size, show two of the best selling Bracelets of a big bracelet season.

Made of Rolled Plate, Pierced, Engraved—a neat, strong joint and catch—with and without stones, from ½ to 1¼ inches wide.

Our line offers an unsurpassed range of styles.

ASK YOUR JOBBER—HE HAS THEM.

**WHITING & DAVIS, Plainville, Mass.**  
NEW YORK OFFICE, 7 MAIDEN LANE.

# The Allsopp Rings

THE UP-TO-DATE LINE OF  
**SIGNET AND SET RINGS**



In twenty years we have built up a business second to none in Rings exclusively. ALLSOPP QUALITY, DESIGN and WORKMANSHIP appeal to the most fastidious. It will pay you to examine a selection package.

A ★  
TRADE-MARK.

**ALLSOPP BROS.,** ALLSOPP BUILDING, Newark, N. J.



## BRACELETS

Carved,

Engraved,

Plain or

Mounted.

**C. P. GOLDSMITH & CO.,**  
33-43 Gold Street,  
NEW YORK.



Everything New Under the Sun  
IN MODERN JEWELRY  
OF EVERY DESCRIPTION

## Signet Rings

(OUR OWN MAKE)

A SPECIALTY.

We Solicit Memorandum Orders.

**L. Witsenhausen**

47-49 Maiden Lane,  
New York.

Manufacturers **MODERN JEWELRY**  
of Chicago, 405 Masonic Temple.  
(L. KATLINSKY.)



"GRIP"  
The King of all card games, price 5c. sample pack 16c., two 30c., eight 44c. Sent prepaid at once (only on receipt of price). See last week's issue of Circular for prices of my Ring Adusters which every jeweler should have in stock. Order 1 doz. asst. Enclose the amount. Mention order No. J and I will forward a sample pack of 6th extra. Order them to-day.

CHESTER H. WELLS, Jeweler, Meshoppen, Pa

# The Bowden Rings

ARE COMPLETE IN VARIETY, CORRECT IN QUALITY AND PERFECT IN FINISH. WE MAKE EVERY VARIETY OF FINGER RINGS.

**J. B. BOWDEN & CO.,**

1 Maiden Lane.

NEW YORK.

# GOLD RINGS

BROOCHES AND MOUNTINGS

Also GOLD FILLED RINGS, including the popular THREE CROWN

Ostby & Barton Company respectfully announce to the jobbing trade that their fall line comprising many new and original designs is now ready.

OSTBY & BARTON COMPANY

New York, 13 Maiden Lane  
Chicago, 103 State Street

PROVIDENCE, R. I.

## BATES & BACON,

NEW YORK OFFICE  
9 Maiden Lane

ATTLEBORO, MASS.

CHICAGO OFFICE  
103 State Street

Makers of

HIGH GRADE CHAINS.

The BEST SAFETY FOB is one of our specialties; Gent's Vests, Dickens, Lorgnettes, Secret Locket Chains, Locketts, Chate-laines, and the unexcelled

**"Bates" Bracelet**

"KANT-KUM-OFF"

**Seven Sizes.**

Just the **Bracelet** to be worn over the **Long Gloves** so much in **Fashion.**

**NO HUNTING** for the Invisible Catch.  
**Just PULL and TWIST.**

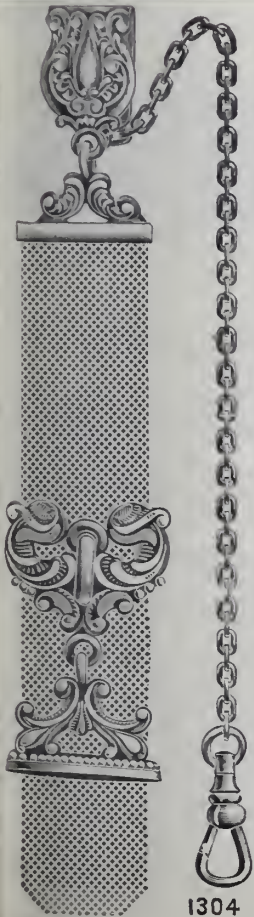
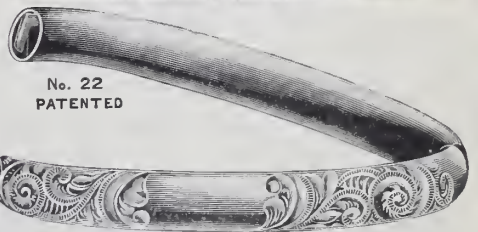

1304

# The Reign of the Bracelet.



EXPERENTIA  
DOCET

CONFORMING to the revival of Bracelets, this house offers an attractive line, including Bangle and Link Bracelets. Great variety, especially in Link Bracelets. Made in Gold and set with Precious and Semi-Precious Stones. Impressive.

PRICES: FROM \$12.00 to \$400.00.



EXPERENTIA  
DOCET

**Durand & Company,**

49-51 Franklin Street,  
Newark, N. J.



TRADE **14** MARK

**OSMUN-PARKER MFG. CO.**

MAKERS OF

*Fine Pearl and Diamond Goods*

338 Mulberry Street

NEWARK, N. J.



Fancy Designs in

*Jewelry* OF ALL KINDS.

Collarettes, Brooches,  
Scarf Pins, Buttons,  
Necklaces, Hatpins, Etc.

**A. J. Hedges & Co.,**

Makers of Exclusive Designs  
in 14K. Jewelry.

14  
K

14 John Street, New York. TRADE-MARK

ESTABLISHED  
1871.

Factory and Office: Newark, N. J.

INCORPORATED  
1900.

## CARRINGTON & CO.,

*Patent Pocket Match Box*

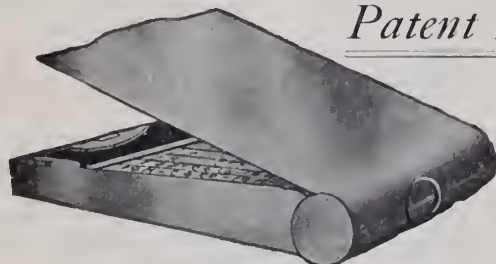

14K. ONLY IN STOCK.

Book Safety Matches with  
Steel Cigar Cutter.  
(Patented.)

14

Sales Agent:  
7 Maiden Lane,  
NEW YORK.

18



### Adjustable Glove

### Garters

IN  
GOLD AND SILVER

### Gold Jewelry

14K. in 10K.

Plain, Chased, Engraved, Diamond Set  
BRACELETS, BROOCHES,  
LINKS, LOCKETS, ELK  
BUTTONS, ETC.

**Chas. L. Trout & Co.,**

15 MAIDEN LANE, NEW YORK.

## HEINTZ BROTHERS.



• We Make the Largest Line of Solid Gold Set Rings in America for the Retail Trade •

### TRADE - MARKS

OF THE JEWELRY AND KINDRED TRADES.  
Over 4,000 Marks. Second Edition. Price, \$3.00.  
The Jewelers' Circular Pub. Co., 11 John St., N. Y.



*Always  
Specialties  
Here.*

**Necklaces:**

Fancy Bead Necklaces are a trade staple. These will do you credit. Graduated and Even Sizes. Vermicilli and other Fancy Decorations. All rich in color, design and finish.

**Hat Pins:**

Another specialty here, for which superior beauty and excellence may justly be claimed. The "Summer Hat" calls for them.

**Day, Clark  
& Company**

14 KARAT ONLY

23

Maiden Lane  
New York



**WHITESIDE & BLANK  
SCARF PINS**

NEW GRECIAN EFFECTS  
Fancy Stones, Diamonds or Pearls.



No. 4038½ Sapphire and Diamond. No. 4032 Sapphire.  
No. 4030¼ Aquamarine. No. 4040¼ Baroque and Diamond.

NEWARK, N. J.,  
Lafayette and Liberty Streets.

NEW YORK,  
14 and 16 John Street.

ESTABLISHED 1841.

**Carter, Howe & Co.**

TRADE MARK



MANUFACTURERS OF

**Gold Jewelry,**

9, 11, 13 MAIDEN LANE, NEW YORK.

FACTORY, NEWARK, N. J.

A. CARTER.

G. R. HOWE.

W. T. CARTER.

W. T. GOUGH.

**"THE BRACELET HOUSE."  
KENT & WOODLAND,**

BRACELETS FOR EVERY WOMAN AND MISS.

16 John Street, New York.

San Francisco Office,  
Care JULIUS A. YOUNG.

"Nethersole Bangles,"  
Plain and with Stones.

"Pinhole" Secret Snap,  
with and without pre-  
cious and semi-precious  
stones.

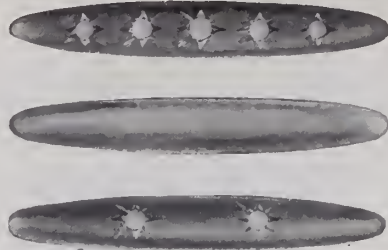

Quality and Finish Consistent  
with twenty years' experience.  
Original and Exclusive Designs.

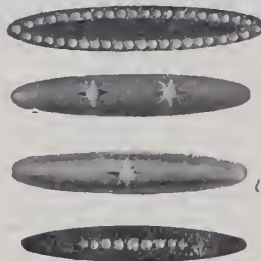

# MOORE & SON,

ESTABLISHED 1886. NEWARK, N. J. INCORPORATED 1903.

# ALLSOPP & ALLSOPP'S HIGH CLASS BRACELETS

MOUNTED IN COMBINATIONS OF

Dia. and Pearl  
Dia. " Sapphire  
Dia. " Emer'lds  
Dia. " Baroques



Amethysts  
Topazes  
Peridots  
Aquamarines  
Etc.

18-20 COLUMBIA ST.



NEWARK, N. J.

## DATTELBAUM & FRIEDMAN,

Makers of Gold Rings of All Descriptions.  
45 John Street, New York.

Our Trade-Mark: "D. F." in all our Rings is the guarantee of quality.  
Send for Catalogue.



## DESIGNS For Silverware, Novelties and Jewelry . . . FINE ETCHING

All goods left with us for etching are covered by policies which fully insure our customers against loss by fire or theft.

CHARLES M. PRIOR (PHONE 1224 HARLEM) 1683 Madison Ave., New York

# SIGNET RINGS



## Geo. O. Street & Sons

Est. 1837

24 John St., New York.  
103 State St., Chicago.

## Unique Silver Deposited WHISKEY JUG



7 Inches High.

Just one piece from one of the best selling and most attractive lines in town

Depasse Mfg. Co.,

41-43 Malden Lane, New York

### THE CROWN PATENT SAFETY GUARD



For Scarf Pins. The most practical and adjustable one invented. Price, \$1.50 per doz. Fine by all wholesale jewelers and material houses. Sold by mail, 25c; in 10k. gold, \$1.00; 14k., \$1.25. M. C. R. Maker and Inventor, 48 and 50 Malden Lane, N. Y.

## ROBERT DULY, DESIGNER,

Etching in Gold and Silver

Telephone, 3960 Chelsea.

No. 70 5th Avenue, NEW YORK





**SOLID GOLD CHAINS EXCLUSIVELY**

The best workmanship, plump quality, most attractive designs and very lowest prices are characteristic of our **SOLID GOLD CHAINS**



For 56 years exacting Jewelers have found our Chains ready sellers, very profitable to handle and most durable in service.

We have no salesmen, and our prices are therefore very low. We will be pleased to send you a selection package.

1850 1906

**ALOIS KOHN & CO.**

Makers of

**SOLID GOLD CHAINS**  
of every kind.

16-18 Maiden Lane  
New York

**M. SCHIFF**

Established 1876

82-84 Nassau St., N. Y.

Phone 801 John.

Manufacturer of fine Diamond Mountings, Locketts and Buttons. Patentee of

THE NEW IMPROVED

**Ear Screw**

The only one on the market of its kind, absolutely secure. Special attention paid to all order work.

**Look for the Stamp**

ON BACK OF



**ONE PIECE**

The Standard American Collar Button

**KREMENTZ Collar Buttons and Studs**



**Krementz Stamp**

**PARKS BROS. & ROGERS**  
20 Maiden Lane, New York  
Selling Agents to Jobbers

**KREMENTZ & CO.**  
**Newark, N. J.**

Send for booklet, "The Story of a Collar Button."—FREE

**WE MAKE THEM!**



**ELK EMBLEMS**



**EAGLE EMBLEMS**

WE are making up the 2,700 Elk Teeth which we purchased a short time ago. These are a few of the designs. We mount them with or without diamonds, just to suit your trade. They are lively sellers and profitable to handle. Write for a selection package.

**SCHULTZ, LEISS & CO.,**

OFFICES:

NEW YORK: 14 John St.

CHICAGO: 103 State St.



FACTORY:

Cor. McWhorter and Oliver Sts.

NEWARK, N. J.

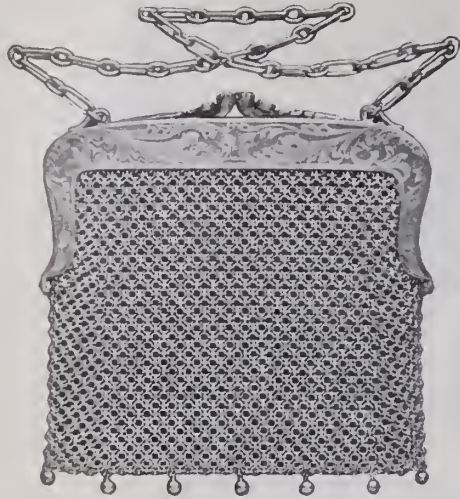

# S. Cottle Co.

Makers of Fine Gold and Silver Mesh Bags.

Our designer is now in Europe visiting the leading fashionable cities on the continent. On his return early in July we will be prepared to show the newest and most artistic designs in Gold Novelties, as well as a complete line of Bags and Bracelets.

31 East 17th Street,  
New York.

## Bridesmaids' and Ushers' Pins

We would suggest something with color. Brooches, Scarf Pins and Handy Pins with Amethysts, Topazes, Garnets, Peridots, Aquamarines, Jades and Baroque Pearls. We have a large variety of patterns at moderate prices.

REGARDING OUR FOBS WE HAVE NOTHING TO SAY—  
THEY SPEAK FOR THEMSELVES.

## SNOW & WESTCOTT,

Makers of Good Jewelry for Over Seventy Years,

21 MAIDEN LANE,

NEW YORK.



The Rosary  
in Fine Jewels

Fine Rosaries in pure and imitation stone. Mounted in solid gold and rolled gold-plate

A L L C O L O R S

Our special illustrated catalogue will give interesting advice regarding prices and discounts.



MADE BY

## The W. J. Feeley Co

Providence, Rhode Island,

Ecclesiastical Art Metal Workers

## SAM'L BUCKLEY & C.

English Fancy Goods.



Carry in New York a full line of

## ENGLISH PLATED WAITER

118-122 Holborn, E. C.,  
London, England.

100 William St., New York

ADOLPH LUTHY.

## LUTHY & HINE,

PERCY W. HINE.

13 EAST 30TH STREET, - NEW YORK.

MANUFACTURERS OF

### Artistic Gold and Platinum Mounted Diamond Jewelry.

Odd and Exclusive Patterns in NECKLACES, BROOCHES, BRACELETS, RINGS, RIBBON COLLARETTES, Etc.

MOUNTED WITH AQUAMARINES, PERIDOTS, AMETHYSTS AND OTHER PRECIOUS STONES.

(DIAMOND MOUNTED COMBS A SPECIALTY.)

## Ribbons

in stock and special designs **MADE TO ORDER**, in large or small quantities, to use with medals and for club purposes. Correspondence invited.

JOSEPH LOTH & CO., Manufacturers, 65 Greene Street, New York.

# MONOGRAMS.

In Gold, Silver and Plate.

A complete line of Two and Three-Letter Monograms always in stock.

SPECIAL DESIGNS TO ORDER.

Elegant Silk Ribbon and Leather Strap FOBS.

Always Acceptable as Gifts.

A Beautiful Solid 14-K. Gold Monogram Fob with Ribbon and Swivel, complete, any three letters desired, for

**\$10.00**

Send for new Illustrated Catalogue,

showing the largest selection of stock Fob Monograms, from 50c. in Gold Plate upward.

Create a demand for these Fobs by displaying a few samples in your window.

**OUR**

**SPECIALTY :**

MONOGRAMS AND INITIALS FOR POCKET BOOKS, BAGS, ETC.

Wide Strap Fob.  
Heavy Script Monogram  
Rounded Surface Finish.  
Each.  
14K Gold Plated. \$6.00  
14Karat Gold..... 21.00  
Gold Filled..... 9.00  
Sterling Silver..... 12.00  
These prices are list and subject to discounts as shown in our new illustrated catalogue.

Send for Fob and Monogram Catalogue or other information to

**Thomas J. Dunn & Co.,**  
101 and 103 Chambers St.,  
New York City.

# THE MOUNTING THAT SELLS

Earscrews,  
Earrings,  
Studs,  
Scarf Pins,  
and Rings  
of every description.

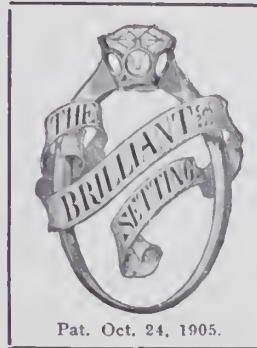

Made in  
Platinum,  
18K.,  
14K.,  
all sizes.

It gives light and brilliancy to the stone.

Manufacturer of a general line of Platinum, 18K. and 14K. Mountings.

Prompt attention given to special order work.

Estimates and designs submitted.

Diamonds recut and repaired.

## JULIUS WODISKA,

40 JOHN STREET,

NEW YORK.

## The Comb House

We manufacture a complete line of

**FINE MOUNTED COMBS**

in 14 K., 10 K., Sterling Gilt and Gold Filled.

Also all kinds of PLAIN, REAL and IMITATION TORTOISE SHELL COMBS.

**Wagner Manufacturing Co.**

41 Union Square,

New York.

Repair Work  
a Specialty.

Factory, Lorimer St. and  
Throop Ave., B'klyn, N. Y.

## Roger Williams Silver Co.,

PROVIDENCE, R. I., AND NEW YORK, 860 BROADWAY.

**Sterling Only.**

RICH DESIGNS :: :: :: Photos on Application.

# FALL O LOCKETS



Trade-mark stamped in each Locket



Our **FALL LINE OF LOCKET CREATIONS** will convince the discriminating buyer of the value of W. & H. Locketts. Fifty years of successful experience justify the confidence in our line.

3 Maiden Lane **Wightman & Hough Co.** Providence, R. I.  
New York

EVERYTHING IN LOCKETS AND CHAINS.

THE BASSETT JEWELRY CO.,

PROVIDENCE, R. I.



## OUR Silver GOODS

Jewelry and Novelties are Original, Artistic and Sellers. Our name stands for the best of everything in our line at our prices.

**THE W. H. SAART CO., Attleboro, Mass.**

OFFICES: 713 Market St., San Francisco.  
103 State St., Chicago. 204 St. James St., Montreal.  
49 Maiden Lane, New York.

Tollet Goods  
Wrist Bags  
Buckles  
Bracelets  
Hat Pins, etc.

1876

1903

# Hutchison & Huestis



## RING MAKERS



## JADE

is in vogue



SEE OUR

## JADE RINGS

Jobbing Trade Only



FACTORY

PROVIDENCE, R.

185 EDDY STREET

NEW YORK

3 Maiden Lane

CHICAGO

Columbus Building

HARRY H. MILLER

**W**ait  
**A**nd See  
**I**n the "Celebrated Case"  
**T**his Season's New Goods.  
**E**very one a Seller

**T**here  
**H**ave always been

**F**RESHERS  
**S**ELL  
**G**OODS

**Vaite-Thresher  
 Company**

PECK ST., PROVIDENCE, R. I.

Maiden Lane, 1203 Heyworth Bldg.  
 NEW YORK. CHICAGO, ILL.

**EGYPTIAN  
 PEARLS**

—  
 FINEST  
 OF  
 ARTIFICIAL  
 PEARLS.

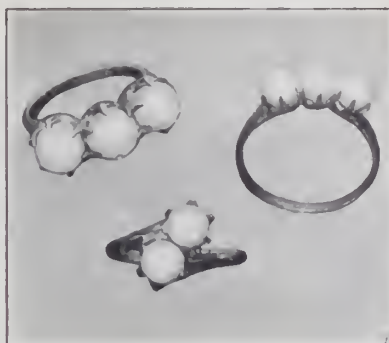

**EGYPTIAN  
 PEARLS**

—  
 MOUNTED  
 IN  
 POPULAR  
 JEWELRY.

**T**HE PEARL has always symbolized Beauty and Value. Nature's product is most closely approximated in the handsome "EGYPTIAN" Pearls. The iridescence, weight and color of natural Pearls are retained; and inspection of the "EGYPTIAN" Pearls will demonstrate their pre-eminence. The results attained are possible only by a special process, supplemented by expert workmanship. The articles of Jewelry to which "EGYPTIAN" Pearls are applied are artistic creations meriting your attention.

**GEORGE H. CAHOONE COMPANY,**

Makers of Artistic Jewelry,

PROVIDENCE—7 Beverly Street.

NEW YORK—9 Maiden Lane.



**BROOCHES**

**W**E have over four hundred styles of Gold Brooches set with all the popular stones in vogue; not at fancy prices, but at figures that cause them to sell.

We have Gold Barrettes in a variety of shapes and styles.

*Insist upon seeing the designs  
 of Gold Jewelry made by the*

**E. L. SPENCER COMPANY,**

Makers of Gold Jewelry for the Jobbing Trade.

ORDERS PROVE OUR GOODS SELL.

95 Chestnut Street,

PROVIDENCE, R. I.

New York Office, 9-11-13 Maiden Lane.

SAMPLES ONLY.

ESTABLISHED 1861.

# R. BLACKINTON & CO.,

3 MAIDEN LANE, NEW YORK.

FACTORY, NORTH ATTLEBORO, MASS.

## Manufacturing Jewelers and Silversmiths.

TRADE  MARK.

Toilet and Manicure Articles, Flatware, Sterling and German Silver Wrist Bags, Gent's and Ladies' Card Cases, Vanity Boxes, Jewel Boxes, Match Safes, Picture Frames, Belt Buckles, Cigarette Cases, Penknives and up-to-date Novelties.

W. B. BALLOU, ROSWELL BLACKINTON ESTATE,  
WALTER BALLOU, J. R. MORSS. R. BLACKINTON, Jr.

## Boston Jewelry Manufacturing Co.

### The Mounting and Repairing House of New England.

We eclipse all others in design, quality, promptness and finish of work.

A line of entirely new styles in mountings always on hand.

Jewelers' Building,  
BOSTON, MASS.

## BARRETTES

If one will pause for a moment to consider Quality, Price and Design, the conclusion is always the same, we have the Premier Line. This applies to Barrettes, and the A.O.T.G. Lines of



- |            |                  |
|------------|------------------|
| Combs      | Baby Pins        |
| Brooches   | Crosses          |
| Scarf Pins | Waist Sets       |
| Bracelets  | Hat Pins         |
| Barrettes  | Collarettes      |
| Buttons    | Silver Novelties |
- LOOK FOR THE TRADE-MARK

ALWAYS ON THE GO.

MILLER, FULLER & WHITING,  
MANUFACTURING JEWELERS,  
N. Y. Office, 9-11 Maiden Lane. N. ATTLEBORO, MASS.

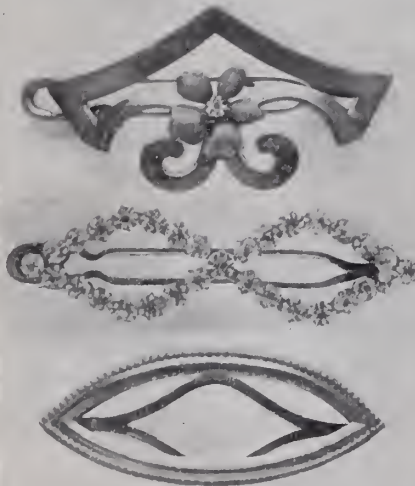

BROOCHES, SCARF PINS, ETC.  
Up-to-Date CREATIONS  
14 K. Gold on Sterling Silver  
Prices that are Unequalled  
Quality Guaranteed. Ask Your Job!

THE MACKEY JEWELRY CO.,  
235 Eddy Street, PROVIDENCE, R.



Established 1855.

# ADAMS & SINGLETON,

Successors to BROOKS & PIKE,

Manufacturers of

## Fine Diamond Mountings.

Special Attention Given to Order Work.

364 Washington Street, Boston, Mass.

## The Premier Repairing House of New England

JEWELERS, SILVERSMITHS,  
STONE, METAL, SEAL ENGRAVERS,  
AND INCRUSTERS.

LAPIDARIES AND DEALERS IN  
PRECIOUS AND IMITATION STONES

### REPAIRING

FANS AND OPERA GLASSES.  
INLAYING SILVER MONOGRAMS AND  
INSIGNIA IN PIPES.  
GOLD PLATING.

H. E. ALSTERLUND & CO.

387 WASHINGTON ST.  
AND 12 BROMFIELD ST., MASS.  
BOSTON.  
All work positively Done in Our Own Factory. Write us for terms and information.



Timer is 1/8 Larger than cut

# THE OLD RELIABLE Centennial

SPLIT SECOND TIMER

*"None better made"*

Suitable for Racing and  
Mechanical Purposes.

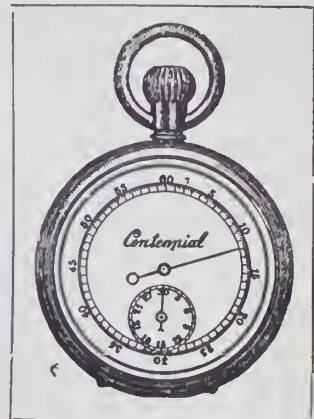

Timer is 1/8 larger than cut

## CROSS & BEGUELIN, Manufacturers, New York.



**To Jobbers Only—**

When you think of Toilet Goods,  
please remember us. Our goods  
are high grade and can be retailed  
at popular prices.

*Special Terms on Early Business*

**Art Stamping & Mfg. Co.**  
4 Commerce Street, PHILADELPHIA, PA.

# RINGS

**WM. LOEB & CO.**  
101 Sabin St.,  
Providence, R. I.  
New York Office, 37 Maiden Lane.

**Trade-Marks** of the Jewelry and  
Kindred Trades.  
Third Edition. Price, \$3.00. The Jewelers' Cir-  
cular Publishing Co., 11 John St., New York.

# FANS

Headquarters for the most exclusive line in this country  
SPECIALLY DESIGNED FOR THE FINE JEWELRY TRADE

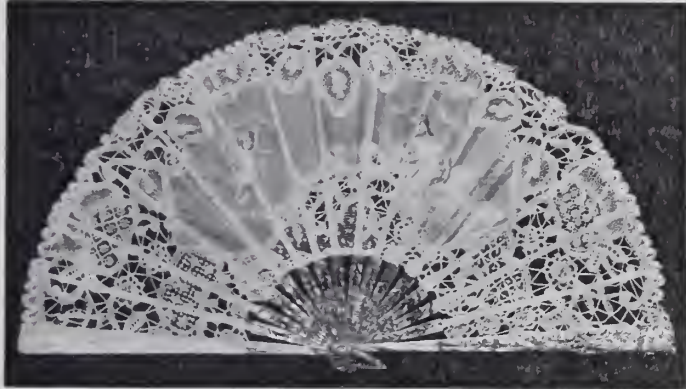

# NECKLACES

Imitation Pearl and Fancy Bead, in all newest shades and exquisite  
colorings. Write for Samples, mentioning price

**LOUIS STEINER, Importer,** 520 & 522 Broadway  
NEW YORK

## REMOVAL NOTICE

We now occupy the new store of

**The Lorsch Building, 35 Maiden Lane, N. Y.**

# WOLFSHEIM & SACHS

MAKERS OF

**Fine Boxes, Trays and Novelties for Jewelers and Silversmiths**

**35 MAIDEN LANE, N. Y.**

Telephone, 3518 John.

Factory, 10 Gold Street.



# The "ARMLET"



**F. & B.**  
**"ARMLET"**  
 Secret Joint  
 Pat. ~~1905~~  
 Size 2 3/4 in.

- |                  |                                  |   |
|------------------|----------------------------------|---|
| <b>474</b>       | <b>476</b>                       | <b>477</b>                                  |
| <b>474 POL.</b>  | <b>476 Rose Gold Half Chased</b> | <b>477 Rose Gold, Half Chased, 5 Stones</b> |
| <b>475 ROM.</b>  | <b>507 O. E.</b>                 | <b>522 O. E.</b>                            |
| <b>506 O. E.</b> | <b>530 Rose Gold Full "</b>      | <b>546 Rose Gold " " 6 Brillants</b>        |
|                  | <b>538 O. E.</b>                 |   |

Color of stones as ordered, Amethyst, Ruby, Sapphire, Olivene, Topaz, Aquamarine, Almondine, Turquoise and Rose Stones.  
 Bracelets made with secret joint and push catch. High-grade Seamless Gold-filled Stock. Each bracelet in fine leatherette covered box.



**BRACELET 473 ROSE.**  
 COLOR OF STONES AS ORDERED.

Amethyst, Ruby, Sapphire, Olivene, Topaz, Aquamarine and Turquoise.  
 Two of the above Bracelets snapped together, makes a nice dog collar 14 in. long.



Locket  
**2825**  
 Rose



Pin  
**3632**  
 Rose and Green  
 Brillants



Pin  
**3647** Pearls  
**3648** Brillants  
**3649** Turquoise



Pin  
**3629**  
 Baroque Pearls  
 and Brillants



Locket  
**2826**  
 Rose



Hair Barrette  
**3660** Pearls  
**3659** Brills.

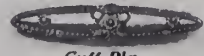

Cuff Pin  
**3624**  
 Roman



Cuff Pin  
**3622**  
 Roman



Hair Barrette  
**3652** Pearls  
**3651** Brills.

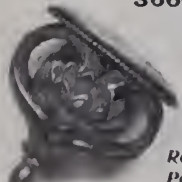

Hat Pin  
**710**  
 Rose and Green  
 Polish Signet



Cross  
 III  
 Pearls in bars,  
 centre and ends.  
 Sapphire,  
 Amethyst  
 and Topaz

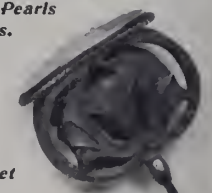

Hat Pin  
**705**  
 Rose  
 Polish Signet



Links  
**751** Rose



Hair Barrette  
**3658** Pearls  
**3657** Brillants

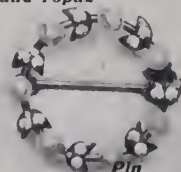

Pin  
**3603** Baroque Pearls  
 and Brillants

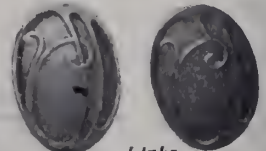

Links  
**758** Green  
**757** Rose

These are only a few examples of our new goods; see our complete lines.

**Theodore W. Foster & Bro. Co.**  
 MANUFACTURING JEWELERS AND SILVERSMITHS,  
 100 Richmond Street, Providence, R. I.

Established 73.

See our Lines  
 of Goods for  
 Articles suit-  
 able for gifts

A full line  
 PHOTO. FRAMES  
 both Sterling  
 and 14 K. Gold  
 CROSSES, P  
 ANTS, S  
 CHAINS, S  
 GNETTE C  
 LOCKETS, C  
 VEST, DIC  
 and FOB C  
 BRACELETS  
 BROOCHES,  
 RINGS, LIN  
 TONS, SCAR  
 HAT PINS  
 RETTE T  
 WAIST SETS  
 CHAIN M  
 INGS, DO  
 LARS and  
 BUCKLES,  
 BOOK-MAR  
 large variety

Sterling  
Silver  
Noveltes.

MANICURE  
 TOILET SE  
 pieces, also  
 DESK S  
 SEWING E  
 TRAVELING  
 SHAVING  
 SMOKING  
 FLASKS an  
 goods suit  
 gentlemen's

Do not fail  
 order a w  
 our new ra  
 lets,

"The Arlet"



### Tiffany & Co.'s Superintendent Pleads Guilty to Larceny and Is Released Under a Suspended Sentence.

Sentence was suspended last week in the case of John C. Brosseau, the former superintendent in the repair department of Tiffany & Co., New York, who pleaded guilty to three indictments, charging him with grand larceny by padding his employers' payrolls. The suspension of sentence was one of the indictments, the others being laid over his read.

Brosseau's arrest was reported in the issue of May 9. He pleaded guilty in court on May 29 to the charges against him, and it was said that he had previously made a confession to the District-Attorney. The suspension of sentence was announced by Judge Foster in the Court of General Sessions. This was after A. B. Cunningham, defendant's counsel, had pleaded with the court for clemency to his client. It was said that Tiffany & Co. desired the court to act leniently and that District-Attorney Jerome offered no objection to this course.

In suspending sentence, Judge Foster said:

"You have been in prison for several weeks, long enough, at least, to reflect upon the disgrace which you brought upon yourself and family. Your imprisonment is a disgrace as keen as any the court can inflict. I am going to act upon but one of the indictments and suspend sentence and let the other two indictments over you in the hope you should ever do wrong again."

In their report of the case some of the Tiffany papers said that Brosseau's relatives had restored to the company the amount of speculations, the company accepting the restitution with the approval of the court. It was further said that Brosseau had made no disclosures in relation to others which would be an additional cause for the consideration that was extended to him.

As to the exact reasons for the considerate treatment he received, however, little seems to be definitely known except among those directly concerned. From the day of the arrest it has been known that at least some members of the company, because of the long association of Brosseau with the firm, did not wish a rigorous prosecution. A reporter of THE JEWELERS' CIRCULAR—WEEKLY who was queried at Tiffany's & Co.'s as to facts was referred to Mr. Moore, who said that no information would be given out by the company.

The amount of money taken by Brosseau has been stated to be \$10,000. It has been given out also that the thefts extended back at least two years. He had been employed by the company for 35 years, and for a long time had been in charge of the repair department. The plan by which he robbed his employers was simple. He drew on the cashier for amounts in excess of the earnings of various employes, who were paid by the piece. No comparison of the various books, which might reveal dishonesty of this sort, has been made in several years, because of the implicit confidence placed in the superintendent. Some months ago members of the company, becoming convinced that there was a leakage somewhere, secured detectives and accountants at work, and this resulted in the arrest of Brosseau.

When he was placed in custody the papers intimated that he might have taken the three pear-shaped diamonds valued at \$35,000 which disappeared last year from his workrooms and have never been found. It is understood that the members of the company are convinced that there was no basis for this suspicion. He has said that he took nothing dishonestly except the money he got by padding the payrolls.

### Preparations Being Made for the Convention of the American Association of Opticians at Rochester, N. Y., July 30—August 3.

ROCHESTER, N. Y., June 7.—Every effort is being made to signalize the next annual convention of the American Association of Opticians, which will be held in this city July 30 to Aug. 3, as the greatest optical convention ever held in the United States and the committees in charge are trying to arrange all details in advance not only of the convention itself but also those which relate to the accommodation and entertainment of the many members of the optical trade who are expected to attend. In connection with the work a circular has been sent out by President B. B. Clark, to all members of the trade, which reads as follows:

"As it is the desire of the committee in charge to make adequate arrangements for the accommodation and entertainment of all attending the convention of the American Association of Opticians, July 30 to Aug. 3, it will assist those in charge if you will mail a postal card of your intention to be present to the undersigned.

"The rates of the hotels, American plan, are as follows: Powers Hotel, \$3.00 to \$4.00; Whitecomb House, \$2.00 to \$2.50; New Osburn House, \$2.00 and \$2.50; Eggleston Hotel, for men only, rooms \$1.00 and up.

"The bureau of information will have a list of private houses near the convention hall where rooms, without meals, may be secured for about \$1.00 per day. Those desiring such should write the chairman of the committee, W. J. Morse, Chamber of Commerce building.

"Hotel reservations may be had by writing the hotels and should be attended to at an early date."

### Jewelry, Clocks, Watches, Silverware and Kindred Lines Exported from New York.

WASHINGTON, D. C., June 6.—The following were the exports of jewelry, silverware and optical goods, clocks, watches and kindred lines from the Port of New York for the week just ended:

Auckland: 3 packages plated ware, \$259; 68 packages clocks, \$1,931; 1 package scopes and views, \$417; 7 packages watches, \$860.

Berlin: 32 packages clocks, \$1,931.

Bombay: 1 package watches, \$150.

Calcutta: 49 packages clocks, \$728; 7 packages watches, \$1,300.

Colon: 19 packages clocks, \$416.

Corinto: 4 packages plated ware, \$157.

Guayaquil: 1 package optical goods, \$100.

Hamburg: 6 packages optical goods, \$363; 5 packages clocks, \$156; 2 packages scopes and views, \$106.

Havana: 1 package jewelry, \$778; 1 package watches, \$112; 4 packages scopes and views, \$160.

Havre: 4 packages jewelry, \$736; 2 packages optical goods, \$126.

Liverpool: 67 packages clocks, \$1,518; 3 packages watches, \$404; 2 packages jewelry, \$500; 1 package plated ware, \$791; 8 packages clocks, \$150; 2 packages jewelry, \$1,200.

London: 47 packages clocks, \$1,502; 6 packages plated ware, \$733; 13 packages optical goods, \$3,006; 17 packages watches, \$2,348; 2 packages jewelry, \$160; 6 packages jewelry, \$160; 6 packages scopes and views, \$613; 12 packages optical goods, \$692; 41 packages clocks, \$510; 6 packages scopes, \$170.

Manaos: 1 package watches, \$120; 3 packages jewelry, \$609.

Manila: 1 package plated ware, \$219.

Rio de Janeiro: 20 packages clocks, \$385.

Savanna: 8 packages clocks, \$101.

Southampton: 1 package watches, \$310.

Sydney: 10 packages plated ware, \$868; 1 package optical goods, \$113; 78 packages clocks, \$2,102; 3 packages stereoscopic goods, \$305; 12 packages plated ware, \$1,464; 1 package jewelry, \$100.

Vera Cruz: 5 packages plated ware, \$459; 45 packages clocks, \$550.

Vienna: 1 package clocks, \$100.

Yokohama: 200 packages clocks, \$2,756.

### Rochester, N. Y., Opticians Cause Prosecution of Bogus Eye Specialist Who Pleads Guilty.

ROCHESTER, N. Y., June 6.—The opticians as well as the physicians of Monroe County have been deeply interested in the prosecution of "Dr." Horace B. Hyde, who has pleaded guilty to a charge of practicing medicine without having secured a physician's certificate, and are deeply gratified at the termination of the case, Hyde having been accused of tampering with the eyes of Frank Rabshaw, 19 Lisbon St.

Rabshaw, when he found that he was getting worse under the treatment of the prisoner, called on H. M. Bestor, president of the Rochester Optical Society, and Mr. Bestor, after examining the man and finding out what had been done to him, sent the case to Dr. Ozmun, an oculist, who succeeded in partially saving the vision of one of Rabshaw's eyes. Mr. Bestor also sent notices to the two local medical societies and furnished them with the facts and laid the matter before the Rochester Optical Society, which passed the following resolution:

*Whereas*, Such incompetent and unscrupulous depredations of one who practices our profession casts a blight upon the integrity and ability of our members. Be it

*Resolved*, That it is the sense of this society that said H. B. Hyde should be prosecuted to the full extent of the law, and further we offer our moral and financial support to the two medical societies to accomplish this end, and it is further

*Resolved*, That these resolutions be enrolled upon the minutes of our society and a copy with a copy of our code of ethics be sent to the secretaries of the two societies mentioned.

Hyde was represented in court by Attorney G. H. Smith, who advised him to plead guilty and begged for leniency on the ground that he had always borne a good reputation and had been ill-advised in practicing as he did. On behalf of the men behind the prosecution it was stated that they simply wanted to see the law enforced and did not want to be severe on the prisoner. Judge Chadsey then suspended sentence on him.

A new tariff law went into effect in Peru, Jan. 27, which modifies the tariff in the department of Loreto. In this tariff gold and silver jewelry set with precious stones and unset precious stones pay 3 per cent.; gold and silver manufactures pay 10 per cent. All other merchandise pay 30 per cent.

# ACTIVITY

## The Keynote of Our Progress

A series of pictures showing  
various forms of active life.



THE INDOMITABLE TUG.

The puffing tug-boat typifies Strength, Energy and Perseverance, qualities which have helped build up our business to its present large proportions.

Our Strength is expressed in our lines of Rings, Locketts, Sleeve Buttons, Larter Shirt Studs and Larter Vest Buttons.

Our Energy is devoted to increasing these lines and widening our market.

Our Perseverance in applying high grade art work to gold jewelry of unquestioned quality and workmanship is being rewarded by a constantly increasing business.

An inspection of our goods will demonstrate these facts.

May we prove our statement?

4  
over  
40  
years  
Ring Makers

Larter & Sons  
21-23  
Maiden Lane  
New York



### Belmont Stakes For 1906 Takes the Form of a Handsome Punch Bowl.

ONE of the most attractive racing trophies of the season was the sterling silver punch bowl and ladle, illustrated on the front cover of this issue, which was awarded the winner of the Belmont Stake contest that was run in Belmont Park, L. I. on Memorial Day. H. P. Whitney was the winner, carrying off the prize as a recognition of the gallant performance of his colt Burgomaster.

The punch bowl is ornamented with the attributes of racing—large horseshoes, racing bits, stirrups and trappings. Circumferencing the top is a border in the form of a leather strap indicating control. Four large horseshoes, suggest by their size, the wide playing field which racing occupies in this country. Smaller conventional horseshoes with laurel leaf border at the base represent the numerous occurrences of racing through the year. In the center of the bowl, within one of the horseshoes, are the words: "Belmont Stakes, 1906. Won by ———," with space for the winner's pedigree, etc.

The small racing bits in the ornamentation are sustained in position by sprays of laurel symbolizing the simplicity and ease with which a thoroughbred, well-trained horse can be guided to victory.

The bowl measures 21 inches in diameter, stands 16 inches high, and together with ladle contains 447 ounces of sterling silver. The capacity of the bowl is 10 pints. A handsome oak chest is supplied to hold the trophy.

The prize was made by Tiffany & Co. New York.

### Will of the Late Reuben Harris, Wasington, D. C., Filed for Probate.

WASHINGTON, D. C., June 7.—The will of the late Reuben Harris, bearing date March 19, 1903, was filed for probate yesterday. Under its terms one-half of the entire real estate is left to his widow in simple. The sum of \$20,000 is to be held in trust by the executors and placed at interest the amount accruing to be used for the benefit of the widow for the remainder of her natural life. After her death the amount is to be divided, when certain conditions have been fulfilled, among the children of the deceased. The provisions respecting this legacy is that it shall furnish a dowry of \$5,000, to be paid to each of the daughters at the time of her marriage.

The residue of the estate is devised to trustees, in trust for the widow during the remainder of her life. After her death it is to be apportioned among the children.

The original will named Abraham Prutz as the testator's partner, and Alexander W. Prutz as executors, but by a codicil dated March 10, 1905, Mr. Harris provides that his widow, Hattie Harris, Abraham D. Prutz and his two sons-in-law, Leon H. Reizstein and Philip King, shall act as executors in place of those first named. The executors are also to act as trustees of the trust fund provided for by the terms of the will.

J. W. Schmelz will carry on the business formerly conducted by Newlin & Schmelz, Indianapolis, Ind.

**Preparations for Meeting at Pittsburg at Which Pennsylvania Retail Jewelers' Association Will be Organized.**

PITTSBURG, Pa., June 8.—The retail jewelers of Pennsylvania are going to perfect organization in Pittsburg, at a meeting to be held at the Hotel Henry, Tuesday, July 10, which will have for its principal object the preventing of retailing by jobbers and wholesalers. The association will be known as the Pennsylvania Retail Jewelers' Association.

C. S. Wiley, who is in business at 3602 Forbes St., is the secretary of the proposed organization. Already he has received assurances from almost 100 jewelers in all parts of the State that they will unite in the movement. He says that there is a need of a thorough organization of the retail jewelers in Pennsylvania in order to combat the unfair competition of retail mail-order houses, the unjust practice of retailing by jobbers, the adverse conditions being due to the branding of gold and silver jewelry and numerous other evils which threaten the rights and prosperity of the retailer.

The association is being formed in order that the jewelers of the State may be represented at the annual convention of the National Association of Retail Jewelers, to be held in Rochester, N. Y., in August. At the meeting of the State jewelers, to be held in this city, officers will be elected and rules adopted. A number of prominent local jewelers have been spoken to, and most of them have agreed to take a part in the movement. Charles H. Hamer, of 2321-23 Frankford Ave., Philadelphia, has written to Mr Wiley, stating that he is in sympathy with the movement. Mr. Hamer was secretary of a State retailers' association, which a number of years ago died a natural death. The association will be in session for one day.

**New Members Elected by the Jewelers Security Alliance.**

The regular monthly meeting of the Executive Committee of the Jewelers' Security Alliance was held on Friday, the following members being present: Chairman Curtis, Vice-President Woods and Chambliss, Treasurer Karsch, Secretary Noyes and Messrs. Abbott, Bowden and Brown of the committee. The following new members were accepted:

B. W. Akers, Knoxville, Tenn.; John S. Allen, Carl Bergquist & Co., Minneapolis, Minn.; Beneman & Alderfer, Altoona, Pa.; Chas. F. Ann, Buffalo, N. Y.; O. E. Day, Mohawk, N. Y.; W. E. Fellows, Flint, Mich.; A. Imig & Sons, Eboyan, Wis.; S. Jacobs & Co. and W. E. Ober, Minneapolis, Minn.; Chas. A. Loughman,addock, Pa.; Walter Mayer, Pittsburg, Pa.; Jas. Alson & Co. and S. Swanson, Minneapolis, Minn.; J. A. Vignes, Kingston, E. D., N. Y.; Ashcroft Jewelry Co., St. Anthony, Idaho; L. M. Bates, Etna, Pa.; H. Birkenhauer & Co.; S. H. Busin & Co. and Meyer Cohen & Co., Minneapolis, Minn.; Walter J. Farrell, Montrose, Colo.; Hinkle Bros., Jersey City, N. J.; Aaron E. Johnson, Jewelry Mfg. Co., Minneapolis, Minn.; Keynote Watch Case Co., Oakland, Cal.; Reed-Bentley Co., Minneapolis, Minn.; S. L. Rogers, Bantam, Me.; Mrs. H. Scherztinger, Slatington, Pa.; Seidensticker, Hamilton, O.; E. E. Spaulding, Minneapolis, Minn.; Staiger & Sons, Brooklyn, N. Y.; Sweet Bros., Monticello, N. Y.; A. U. Steel, Minneapolis, Minn.; Julia Azeez, Atlantic City, N. J.; the Barker Jewelry Co., Minneapolis, Minn.; M. W. Bassett, Hartford, Conn.; Leroy Cook, Findlay, O.; August Greer, Stillwater, Minn.; Gorman & Green, Spencer, N. C.; E. L.

Hunkins, Billings, Mont.; Johantgen & Kohl, Lindquist Bros. and Wm. A. Sorensen, Minneapolis, Minn.; F. A. Shaver, Dowagiac, Mich.; Lembrecht & Co., Davenport, Ia.; W. F. Van Arsdel, Anniston, Ala.; W. A. Sheaffer, Fort Madison, Ia.

Rewards of \$100 each were ordered paid to Sheriff W. S. Russell for the arrest and conviction of a burglar who broke into the store of L. F. Ely & Sons, Sherman, Tex., and was sentenced to two years in the penitentiary, besides losing his leg through being shot while resisting arrest; and to R. H. Matthies for the arrest and conviction of two burglars who broke the window of G. A. Hauserman, Paterson, N. J., and were fined \$25 each, it being their first offense and both pleading guilty.

**Burglars Loot Atlantic City, N. J., Jewelry Store of Stock Worth More Than \$3,000.**

ATLANTIC CITY, N. J., June 6.—The police of this city are anxious to find the man or men who on Sunday broke into one of the jewelry shops conducted by Mrs. Julia Azeez, who deals in precious stones and Oriental jewelry. The robbery occurred between 1 and 2 o'clock in the afternoon in her store at 731 Board Walk, the robbers looting the place of its most valuable articles and getting away with between \$3,000 and \$4,000 worth of stock.

Included among the goods stolen is a tray of very fine pearls, baroque and round, a large quantity of rare antique necklaces and bracelets, a large lot of 14 karat gold jewelry, including many pieces set with turquoise matrix, and a magnificent seed pearl set.

Mrs. Azeez believes that some of the jewelry may be offered by the thieves or their representatives to members of the trade, as the full value of the property can only be obtained from a dealer who understands the quality of the articles. Readers of THE CIRCULAR-WEEKLY are therefore requested to keep on the lookout, and should any such articles be offered them to immediately communicate with the Atlantic City police or directly with Mrs. Azeez.

**Importations at the Port of New York.**

Weeks Ended June 9, 1905, and June 8, 1906.		
	1905.	1906.
China, Glass and Earthen Ware:		
China .....	\$102,055	\$80,571
Earthen ware .....	17,086	18,428
Glass ware .....	29,031	23,513
Optical glass .....	117	3,527
Instruments:		
Musical .....	18,432	16,311
Optical .....	7,268	5,914
Philosophical .....	4,721	2,198
Jewelry, etc.:		
Jewelry .....	10,242	7,624
Precious stones .....	\$14,908	\$10,034
Watches .....	28,943	16,725
Metals, etc.:		
Bronzes .....	6	890
Cutlery .....	31,154	28,912
Dutch metal .....	45	1,869
Platina .....	25,910	14,134
Plated ware .....		2,555
Silverware .....	3,630	405
Miscellaneous:		
Alabaster ornaments .....		39
Amber .....	18	2,121
Beads .....	3,931	1,991
Clocks .....	2,830	3,661
Fans .....	2,505	6,068
Fancy goods .....	6,506	11,811
Ivory .....	14,225	.....
Ivory, manufactures of.....	955	548
Marble, manufactures of....	2,022	18,306
Statuary .....	2,055	3,947

**Death of Bertram J. Harriott.**

Boston, Mass., June 8.—Bertram J. Harriott, son of John Harriott, and associated with his father in the badge, medal and emblem manufacturing business at the corner of Washington and Winter Sts., in this city, died Monday, June 4, at the Boston City Hospital, to which he had gone for the purpose of having a surgical operation performed. His disease, cirrhosis of the liver, had made such progress that he was unable to submit to the ordeal, and he died a fortnight after he entered the hospital.

"Bert" Harriott, as he was familiarly known to a large circle of friends, was born in Birmingham, England, but came to this



THE LATE BERTRAM J. HARRIOTT.

country when quite young. He entered his father's employ as a youth, learned the business and became the manager of the establishment. He was widely known among the jewelers of Boston and vicinity, and also in the extended social circle with which he had become identified through his many club and society affiliations.

Mr. Harriott was not only master of his chosen calling as jeweler, engraver and designer, but had musical and dramatic talent of a high order. He was an excellent violinist, orchestral conductor and composer of songs and instrumental pieces, an entertainer in elocutionary readings and private theatricals and at one time president of the Boston Dramatic Club. His versatility brought him into membership in many organizations. He was a member of the Masons, Odd Fellows, United Workmen and Order of Red Men. For a number of years he was also treasurer of the Massachusetts Bicycle Club and editor of the *Fens*, official organ of the club.

Deceased was 44 years of age and leaves a widow. He resided at 228 Huntington Ave., this city. The funeral, which took place to-day, with services at the Chapel in Forest Hills Cemetery, was attended by a large number of friends in the trade and members of many organizations.

# HAYDEN W. WHEELER & CO.

## MOUNTED DIAMONDS



Our stock of Mounted Diamonds includes the newest and best ideas for the approaching June Weddings. We are also splendidly equipped to furnish special designs.



NECKLACES, BRACELETS AND LA VALLIERES ARE AMONG THE PREVAILING FADS AT PRESENT.

AMSTERDAM  
2 TULP STRAAT

LONDON  
50 HOLBORN VIADUC

2 MAIDEN LANE, NEW YORK

TELEPHONE  
7365 CORTLANDT

ORDER

# DIAMONDS

ON MEMORANDUM FROM

## ALFRED H. SMITH & CO.

170 BROADWAY, NEW YORK.  
Corner Maiden Lane.

London.  
6 Holborn Viaduct.

Chicago,  
103 State Street.

## Oppenheimer Bros. & Veith, Cutters of Diamonds,

65 NASSAU ST. (PRESCOTT BUILDING), NEW YORK.

AMSTERDAM,  
2 Tulp Straat.

LONDON,  
40 Holborn Viaduct.

CUTTING WORKS,  
Cor. Union & Nevins Sts., Brooklyn.

## HENRY E. OPPENHEIMER & CO.,

51 Holborn Viaduct, London.  
50 Rue de Chateaudun, Paris.  
7 Place Loos, Antwerp.

Tel. 621 Cortlandt.

3 MAIDEN LANE, NEW YORK

DIAMONDS, PEARLS AND PRECIOUS STONES.

MEMORANDUM ORDERS SOLICITED.

**Santa Rosa's Great Loss.**

**Instruction of California Town Shown by Photographs—Assistance Given by Jewelers Board of Trade Thankfully Acknowledged.**

A series of excellent photographs showing the destruction wrought at Santa Rosa, Cal., by the earthquake have been received by the Jewelers Board of Trade, and are being shown to visitors, who invariably are impressed by the extent of the damage as revealed in the prints. The Board's committee on California relief funds sent some time ago outfits for a number of watchmakers, who lost everything in the earthquake and fire.

Frederick H. Larter of the committee received a letter from J. P. Overton, president in Santa Rosa, acknowledging the committee's generosity, and saying: "You have done a kind act, and one that will be much appreciated by the watchmakers and will greatly help them to get work again and to be self-supporting." The Mayor had the assistance of John Hood, who himself was not one of the beneficiaries, in the distribution of the sup-

left standing during the earthquake, doing business as usual at 523 College Ave."

"E. Noack, watchmaker and jeweler, Mendocino St., near 5th. See me for information regarding watches and jewelry left at Carter's for repairs."

"Saved from the ruins. Lewbot-Rinner Optical Co. saved most of their stock and machinery and are now located with Erwin Bros., grocers, Cor. 4th and D Sts. They duplicate any lens, whether you have the prescription or not. Prompt repairs, correct fitting glasses their specialty."

The watchmakers have sent the following acknowledgment to the committee of the receipt of the outfits and financial aid:

SANTA ROSA, Cal., May 25, 1906.  
Jewelers Board of Trade, New York City, N. Y.:

Gentlemen—The undersigned watchmakers and jewelers of the city of Santa Rosa desire to express to your esteemed Board their profoundest gratitude and thanks for the thoughtfulness and kindness shown by you in presenting to each of them a watchmaker's and jeweler's outfit, and the substantial financial relief accompanying the same.

Words can but feebly express to the esteemed members of your honorable Board the feelings of profound gratitude entertained by us toward them, and our appreciation of the kind gift you have forwarded to us at a time when we stood most in need of the articles comprised in the same, and when it would have proved to be a matter of great

graphs, sent the following letter to Mr. Hood:

June 6, 1906.

John Hood, Esq., Santa Rosa, Cal.:  
Dear Sir—Yours of May 24th received, also acknowledgment of Messrs. McGregor and others of the tools and assistance forwarded through you, and we desire to express to you our thanks for your courtesy in handling the matter as you have. We also desire to acknowledge receipt of the photographs made by Mr. McGregor which show the condition so horrible that we had no idea of extent of same. Again thanking you for your courtesy, we shall be obliged if you will keep in touch with us as to any later developments. Yours truly,

THE JEWELERS BOARD OF TRADE,  
D. L. Safford, Secretary.

**Death of Robert P. Cullen.**

INDIANAPOLIS, Ind., June 6.—Robert P. Cullen, head of the Cullen Optical & Jewelry Co., died recently in the City Hospital after a brief illness. Dropsy was the cause of death.

Mr. Cullen came to this city last March and opened a store in the Traction Terminal building. In addition to the optical business, he carried a large stock of watches and jewelry. The deceased had no relatives in this city. Before he died, Mr. Cullen authorized the Citizens' Savings De-



MAIN BUSINESS PORTION OF 4TH ST., SANTA ROSA, CAL., LOOKING WEST FROM CORNER OF MENDOCINO ST. THE STAR INDICATES SPOT WHERE JOHN HOOD'S STORE WAS LOCATED. (FROM A PHOTOGRAPH SENT TO THE JEWELERS BOARD OF TRADE.)

ies. It was Mr. Hood who first called the committee's attention to the needs of the watchmakers in his town who had lost all their possessions.

Mr. Hood in a recent letter said that the letters were sent by A. P. McGregor, one of the watchmakers. "So you will see I did not exaggerate the condition." All who have seen the pictures agree with me. Mr. Hood also sent a copy of the Press-Democrat of Santa Rosa, under date of May 24, in which is an acknowledgment of the receipt of the watchmakers' outfits and \$60 in cash accompanying each outfit.

The following advertising paragraphs indicate that the members of the trade are getting on their feet as fast as they can so:

"P. Van der Linden, only watchmaker

difficulty for us to procure new outfits to replace those we lost in the awful calamity which recently befell our unfortunate city.

With the aid of your most prized and welcome gift we will be able to again pursue our vocation and to meet the demands and needs of our customers; and whenever we shall have occasion to use these tools, we will gratefully recall the generous donors who presented them to us in our hour of trouble.

We thank you one and all from the bottom of our hearts for your generous gift, not merely for the intrinsic value of the same, nor its timeliness, but more especially because of the thoughtfulness and kindly spirit which prompted its sending, and never will the recipients of your kindness forget the helping hand you have extended to us.

With best wishes for the future success of your organization and of each of its members, we beg to remain, Sincerely and gratefully yours,

A. P. MCGREGOR, F. R. SAWYER, M. F. NOACK,  
H. R. EKSTROM, E. F. HEATH, R. M. KEOC,  
per E. F. H.

The Board, after receiving the photo-

posit Co. to look after his affairs. At his request he was taken to Greenville, Ind., for burial. The savings company will probably close out the stock.

**Jewelers Gold Bars Withdrawn and Exchanged at New York.**

Week Ended June 9, 1906.

The U. S. Assay Office reports:  
Gold bars exchanged for gold coin....\$345,574.00  
Gold bars paid depositors..... 80,767.49

Total .....	\$426,341.49
Of this the gold bars exchanged for gold coin are reported as follows:	
June 4.....	\$56,192.46
" 5.....	30,797.58
" 6.....	134,084.22
" 7.....	72,968.27
" 8.....	25,793.44
" 9.....	25,738.03
Total .....	\$345,574.00

# Mr. ABE A. HELLER

is now in charge of our European offices, with headquarters at  
**39 Rue de Chateaudun, PARIS.**



BIRDSEYE VIEW OF PARIS.

Many years of studying the Jewelry trade here have given our Mr. Abe A. Heller an intimate knowledge of the wants of the American Manufacturer, which will be of great advantage in selecting the right goods for the American Market.

## *K. Heller & Son*

Importers of Precious and Imitation Stones.

New York, 51 Maiden Lane      Providence, 212 Union Street  
 Paris, 39 Rue de Chateaudun      Idar, 14 Hauptstrasse

TELEPHONE 219 JOHN.

GEORGE H. HODENPYL.

WALTER N. WALKER

# DIAMONDS

AND

DIAMOND JEWELRY

# HODENPYL & WALKER

Unique  
 and  
 Staple Patterns

170 Broadway, New York  
 Corner of Maiden Lane  
 TELEPHONE, 1898 CORTLAND

Repairing and Recutting  
 Diamonds  
 a Specialty

OUR  
**40th**  
**YEAR**

IN  
 BUSINESS

1866-1906

**DIAMONDS**  
 LOOSE AND MOUNTED

**CASES and MOVEMENTS**  
 ALL MAKES AND GRADES

**JEWELRY**  
 GOLD AND PLATE

ORDERS SOLICITED FROM RESPONSIBLE JEWELERS.

GOODS SENT ON SELECTION.

All our goods are either direct importations, our own manufacture or bought for cash enabling us to offer special inducements in prices and terms.



EST. 1866.  
*Lissauer & Company*  
 Importers.

2 TULPSTRAAT,  
 AMSTERDAM.

12 MAIDEN LANE  
 (ONE FLIGHT UP)

P. O. Box, 1625,

NEW YORK.

# PEARLS ROUND, BUTTON AND HALF.

Selection Papers Sent on Request

**MARTIN LOW & TAUSSIG,**

51 Maiden Lane, New York.  
 Telephone, 2817-John.

139 Mathewson St., Providence, R.  
 Telephone, 3037-Union.

### Fast Honors Paid to the Late Joseph Wineburgh at Utica, N. Y.

UTICA, June 6.—Joseph Wineburgh, for 7 years senior member of Joseph Wineburgh & Sons, jewelers, whose death was noted in THE CIRCULAR-WEEKLY last week, as laid at rest yesterday. The funeral was a very quiet one. Rev. Dr. Levine had charge of the services and the pallbearers were B. Abelson and Mr. Liberman, of Abelson & Liberman, wholesale jewelers; S. Heller, Simon Monsbach, M. Lewis and M. Workman, of Montreal. The interment was in the Jewett St. cemetery.



THE LATE JOSEPH WINEBURGH.

There were many beautiful floral tributes, including one from the local jewelers association.

### Yellow Paint on Neighboring Building Hurts Jeweler's Trade in Diamonds.

NORTH ADAMS, Mass., June 9.—The jewelry trade of this section is watching with interest the developments in the controversy between L. M. Barnes, one of the leading jewelers of this section, whose store is at 51 Main St., with the owners of the Martin block, across the street from Mr. Barnes' store, as the dispute threatens to result in a lawsuit by the jeweler to compel the owners of the building to change the color with which it has been painted. Mr. Barnes has been in business here for 40 years, is highly respected as a merchant. It is believed that if he brings suit as he contemplates it will only be after careful deliberation and good legal advice.

Some time ago the owners of the Martin block painted the building a bright yellow, after which Mr. Barnes was horrified to find that the reflection from the building affected to a pronounced extent the color of the light which entered his store, and in so doing caused all his stock to have an odd appearance. While the yellow light made the silver look bad, its greatest harm lay in the color that it gave to the diamonds. In this light even the whitest of stones appeared off color, thereby not only annoying

the jeweler, but materially hurting his business in these gems. Mr. Barnes has demanded that the owner change the color of the building as he cannot do business in diamonds in his present store as long as the present color remains.

According to newspaper reports the jeweler claims he has not been able to sell a diamond for full price since the building was painted. There are no precedents generally known under which this suit could be decided, but it is believed in many quarters that the jeweler can obtain relief in a court of equity if he decides to bring an action.

### Complaint Dismissed on First Prosecution Brought Under the New York Gold Law.

The case brought against J. Finkel, of Locketz & Finkel, jewelry manufacturers at 218 E. Houston St., New York, under the new Gold Law of New York, was dismissed last Friday in the 57th St. Court by Magistrate Finn. The charges were outlined in the issue of last week. It was claimed that the defendant had sold gold chain slides, marked 14 karat, and that they had assayed below 13 karat.

Maurice Blumen and J. Jacoves, of the Brooklyn Watch Chain Co., 275 Bowery, the complainants, were present when the adjourned hearing was called. They had substituted for their former lawyer Mr. Karasik, of Karasik & Kotzen. Mr. Finkel was present with his attorney, Sol. L. Youngentob.

Mr. Karasik asked for an adjournment in order that he should have time to become familiar with the case and to obtain the presence of the assayer from the United States Assay Office, who was desired as a witness. The assayer was present at the hearing the week before, but had not been sworn. Attorney Youngentob opposed the motion for an adjournment. He said that this was an adjourned hearing, and as his client was ready to go on it would be unfair to him to grant any further delay.

Mr. Karasik then said that as the complainants were not prepared to present their case in full, and as he deemed the case important, he wished to withdraw the present complaint. Mr. Youngentob again opposed the request. The lawyer said that he was present not to consent to a withdrawal of a complaint, but to demand its dismissal as a vindication of his clients. The court granted a dismissal.

The next day Mr. Youngentob began an action in the Municipal Court, Seventh District of Brooklyn, against the Brooklyn Watch Chain Co., to recover \$45, the purchase price of a quantity of chain slides. This action was brought in Brooklyn as the complainants are residents of that borough. Mr. Jacoves refused to pay for the slides on the ground that they did not assay up to the stamp. Mr. Youngentob says that if the action before Magistrate Finn was pressed he could introduce testimony to show affirmatively that the slides actually did assay 14 karat, fully up to the degree guaranteed. Mr. Youngentob also said that he is preparing papers in a suit which he will bring in behalf of his clients against Messrs. Blumen and Jacoves to recover damages for alleged malicious prosecution.

### Ontario Silver Co.'s Manager to be Tried on Charge of Using Stamp "Sheffield."

NIAGARA FALLS, Ont., June 7.—The preliminary hearing of the charge brought by Chief of Police Mains, at the instigation of the Cutlers' Guild, of Sheffield, Eng., against George W. Clark, manager of the Ontario Silver Co., this place, of conspiracy to defraud the public by false marking of goods, was resumed yesterday before Police Magistrate Cruikshank. County Crown Attorney T. D. Cowper, of Welland, conducted the prosecution, assisted by E. T. Malone, Toronto, representing the Cutlers' Guild. J. W. Nesbitt, of Hamilton, appeared for the defense.

Chief Mains, of the Niagara Frontier police, was the only witness. He testified as to the seizure in the Ontario Silver Co.'s factory of a number of orders and letters, together with manufactured goods, dies, etc. These were produced in court. A large number of the orders were for goods marked "Sheffield." Samples of knives were stamped "Manufactured by Leonard & Lee, Sheffield." One knife produced was stamped "Sheffield Knife Co."

Correspondence was read between the company and the Meriden Britannia Co., of Hamilton, Ont. The letters from the Meriden Britannia Co. referred to a promise made by the Ontario Co. that they would cease using the Sheffield marks on their goods. The Ontario Silver Co. replied, explaining that it had ceased using these marks in manufacture, but was selling off the stock so marked already made up. Mr. Clark stated to Chief Mains that the use of several of the marks objected to had been discontinued and that others would be dropped shortly. These goods have been made and so marked for years. Evidence was also given as to the use of labels on boxes in which goods are put up to which the plaintiffs also object. In all, 35 dies were seized. On cross-examination Chief Mains admitted that Manager Clark had given him every facility and aid in his search of the factory and freely produced the correspondence and other articles seized. County Crown Attorney Cowper asked that Manager Clark be committed for trial, and the counsel for the accused said he would offer no defense. Magistrate Cruikshank then committed Clark for trial at the next court of competent jurisdiction and fixed bail at a personal bond for \$1,000.

Since the institution of the proceedings the police have purchased silverware bearing the marks objected to as fraudulent from jobbers and dealers in various parts of Canada.

It is stated that in addition to the prosecution of Manager Clark civil proceedings will be taken against the Ontario Silver Co.

In announcing last week the fact that Frank Reeves had severed his connection with the Rockford Watch Co., for which he was formerly superintendent, and had joined the South Bend Watch Co., in the same capacity, mention should have been made of the fact that Mr. Reeves will act as one of the assistants to C. T. Higginbotham, the general superintendent of the concern, and Paul R. Higginbotham will remain assistant superintendent, as formerly.

DIAMONDS

DIAMONDS

OUR  
MR. ROSENBACK  
HAS JUST RETURNED  
JUNE 12th  
ON THE KAISER WILHELM II  
FROM OUR  
FOREIGN OFFICE  
No. 2 TULP STRAAT  
AMSTERDAM  
HOLLAND

# DIAMONDS

COMPLETE  
STOCK  
RIGHT PRICES  
—  
YOUR  
BUSINESS  
SOLICITED

WM. I. ROSENFELD

19 MAIDEN LANE, NEW YORK

DIAMONDS

DIAMONDS



### Retail Jewelers of South Dakota Organize State Association at Aberdeen.

ABERDEEN, S. Dak., June 6.—An organization has been perfected among the retail jewelers of this state, a meeting having been held here June 4, at which the Retail Jewelers' Association of South Dakota was organized with an initial membership of 60. It is considered a very large proportion of the jewelers in the State, as the total is said to number but 154, and every effort will be made within the next few weeks to gain as many of the others as is possible. Officers and members of the organization having decided to make an effort to obtain every jeweler within the borders of the Commonwealth.

Briefly stated, the objects of the new association are: To afford retail jewelers the opportunity of entering into advantageous and friendly intercourse with each other; to unite for the mutual protection of the craft against the many trade abuses that exist; to quicken the interest and enlarge the views of the jeweler to the end that he will aid and encourage those who are honest and trade protection; to keep a watchful eye on the so-called illegal enterprises that are conducted to the detriment of legitimate trade, and to fight them when necessary; to carefully scrutinize the qualities and prices of goods offered by manufacturers, retailers, and, by assays and other means, commend honest makers and condemn dishonest ones; to take part in any public movement of business men for the purpose of elevating the craft.

The convention was enthusiastic on the question of a national organization as well as a state body, and elected D. G. Gallett a delegate to the convention to be held at Chester next August; a second delegate to be selected. The following officers were elected: President, H. G. Nichols, Mitchell; vice-president, D. G. Gallett, Aberdeen; secretary, O. B. Tripp, Aberdeen; treasurer, J. A. Musch, Mellette; executive committee, three-year-term, A. W. Bedisch, Aberdeen; two-year-term, W. J. Le, Woonsocket; one-year-term, E. T. Einlaus, White.

It was decided to hold the next meeting at Mitchell some time in July, the date to be named later. Any jeweler in the State who desires to join and has not already done so should send his application for membership to O. B. Tripp, secretary, 404 Main St., Aberdeen.

### Davis Bros., Galion, O., Make an Assignment Under State Laws.

GALION, Ohio, June 6.—The report last week that Davis Bros., jewelers, had made a general assignment under State laws was a surprise to the friends of both members of this firm, who have always borne excellent reputation as merchants, and sympathy is expressed for them in their present difficulty. The house was composed of Henry S. Davis and Harold Davis, both young and energetic men.

Henry S. Davis, who was formerly with Gililand, Meiskey & Co., Lancaster, Pa., (now the H. A. Meiskey Co.), started in business for himself in 1904, with C. M. Davis, succeeding the late M. R. Pogh, at

Mount Gilead, O. Henry S. Davis was later joined by his brother Harold, and then closed out the business at Mount Gilead, the present firm beginning in Galion in October of last year, under the style of Davis Bros. They carried a stock of more than \$6,000 worth of merchandise, and until recently were believed to have assets amounting to nearly \$8,000. Their principal merchandise indebtedness is in Chicago, New York and Cincinnati.

### General Appraisers Render Another Decision as to Hat, Shawl and Bonnet Pins.

A decision announced last week by the Board of General Appraisers at New York, sustained in part the protest of Dieckerhoff, Raffloer & Co. against the assessment of duty by the collector at New York on an importation of hat pins and other similar articles. It was held by the Board that hat, bonnet or shawl pins made entirely of metal in imitation of gold or silver with enameled or ornamental heads are commonly known as jewelry and are, therefore, dutiable at 60 per cent. ad valorem. Pins made of metal and set with imitations of precious stones, faceted, or set with pearl, ivory, paste, the mountings ornamented with metal bands, scroll work or other designs, are also dutiable as jewelry.

On the other hand pins made for the same purpose with black heads faceted or plain, or with plain wax, paste or glass heads of various colors, or with heads in imitation of pearls, are declared to be dutiable at 45 per cent. ad valorem as manufactures of glass or non-enumerated manufactures. In order that the latter classification may be obtained it is essential that the heads should not be adorned with metal work.

General Appraiser Sharretts in his opinion says: "These protests are lodged against the assessment of 60 per cent. ad valorem duty under Par. 437, on pins of various descriptions, including hat, bonnet, belt, shawl, and lace pins, all of which were classified by the collector as jewelry and are claimed by the importers to be dutiable at 45 per cent. ad valorem under Par. 112 or 193 of the tariff act of 1897.

"We find from the evidence taken in these cases that the merchandise marked D1 on the invoices is pins similar in all respects to those included in class 1 of G. A. 6139 (T. D. 26679), and those marked D2 are similar to those included in class 2 of said decision, which has recently been affirmed by the circuit court for the southern district of New York and acquiesced in by the Treasury Department. On the authority of the decisions cited we sustain the protests as to the goods marked D2 and affirm the Collector's decision with regard to those marked D1.

O. F. Rohwedder and J. C. MacManus have formed a partnership in the jewelry business at Sherburne, Minn.

J. P. Johnson, of Pine River, Minn., has bought a jewelry business in Aitkin, Minn., and has moved there.

Albert M. Thomas has reconstructed his store at Niagara Falls, N. Y., giving him much needed space and light.

### Pearls Reported Scarce in Europe and Advancing in Value—Sale of a Noted Necklace.

Pearls of all kinds are advancing in value to a considerable extent, and are surprisingly scarce in the European markets, said Maurice Brower, 12 John St., New York, who returned two weeks ago on the *Kronprinz Wilhelm*, after spending several weeks in Paris and London. He said that necklace pearls in the larger size have gone up fully 35 per cent. since he was abroad a year before, and those of large size and fine grade are extremely difficult to get. The present bases of these round, white pearls, he says, varies from \$9 to \$15. Large colored pearls have also advanced in value. Pink pearls of fine quality and of desirable sizes are even higher in price than white gems, he says, but it is practically impossible to get such gems in sufficient quantities to make necklaces. Even small sized pearls are declared to be much higher than they were a year ago.

Mr. Brower said that he took with him a quantity of American pearls for which he found a ready market. The only difficulty, he says, as to American gems is that the yield this year is far below the demand.

While Mr. Brower was abroad he learned of the sale of an especially beautiful necklace. The sale was made by Cortier of the Rue de la Paix, for Citroen & Co., the wholesalers formerly of New York. The buyer was Mr. Leeds, a Pittsburg man, who paid 1,000,000 francs (about \$400,000) for the necklace. It was a single strand containing 60 Oriental pearls ranging in size from 25 to 40 grains, the average being 32 grains. All the pearls were perfect white spheres.

This is the necklace, Mr. Brower said, to which reference has been made in the papers from time to time for some years as the most valuable necklace in the world's markets. He says that there is no doubt that it is the most costly necklace sold in years. There are more valuable necklaces in New York, he said, the original strands of which have been enlarged by the owners who keep adding desirable single pearls from time to time.

Recent acquisitions and loans at the Metropolitan Museum of Art, as mentioned in the monthly bulletin, just issued, include several pieces of plate. John E. Berwind has loaned a plateau of French origin, made early in the 17th century, and an enameled "nef," or ship, dating probably from the 16th century. John Cadwalader has sent some silver, and William L. Andrews a teapot made by Paul Revere, for his "Midnight Ride." Philip Schuyler has loaned a two-handled cup and cover which bears the inscription "Presented by Anne, Queen of England, to Col. Peter Schuyler of Albany, April 19th, 1710." The collection of watches loaned to the museum by Mrs. George A. Hearn in 1902 has just received an addition from Mr. Hearn of 24 specimens of English, French and Swiss workmanship of the 18th and 19th centuries. A collection of 39 clocks and watches has been lent by Maurice Sternberger.

C. W. Williams has succeeded to the jewelry business of C. W. Williams & Co., Higbee, Mo.

# Chester Billings & Son

1840

Successors to  
Kandel, Barmore & Billings

1906

Importers of Diamonds  
Other Precious Stones, and  
Pearls, Diamond Jewelry

1840, Kandel & Barmore; 1866, Kandel, Barmore & Co.; 1880, Kandel, Barmore & Billings; 1897, Chester Billings & Son

New York, 58 Nassau Street, 29 Maiden Lane  
London: 22 Holborn Viaduct, E. C. Paris: 53 Rue de Chateaudun  
Amsterdam: 2 Tulp Straat



Manufacturer of  
Diamond Mountings and  
Diamond Set Jewelry  
Importer of  
Diamonds and Precious Stones

**A. S. Hirshberg,**  
373 Washington Street, Boston, Ma

Cable Addresses: { Ashir, Boston.  
Hochschüler, Antwerp

## REMOVAL NOTICE

### THE LYONS GEM CO

Have Removed to  
**35 Maiden Lane, New York**

A FULL AND COMPLETE LINE OF PRECIOUS  
SEMI-PRECIOUS AND IMITATION  
STONES ALWAYS IN STOCK.

Our Specialty is Scientific Rubies.

Local and out of town jobs promptly  
attended to at reasonable prices.  
Send us your mountings to be set  
with matched stones. A trial order  
will convince you that our prices  
are right, and our goods selected.

## GARREAU & GRISARD

68 & 70 Nassau St., New York

LAPIDARIES. PRECIOUS  
STONES  
GEMS in Unique Cuttings.

## LEARN WATCHMAKING AT HOME

by THE DE SELMS CHART SYSTEM, copyrighted and patented.  
Most simple, practical and up to the minute method of learning.

Saves you time and money while learning and puts you to work in  
more than double your income.

50 million timepieces to be repaired. Accurate time is a necessity in the  
business world. When time is money the watchmaker gets his share of  
profit. Positions for graduates. Booklet free. Write today.

The De SELMS WATCH SCHOOL,  
109 Perry Street, ATTICA, ILLINOIS

## JACOB BASCHKOFF DIAMOND SETTER,

LETTER AND MONOGRAM  
ENGRAVER,

Room 701  
Jewelers' Bldg. 9-13 MAIDEN LANE,  
NEW YORK

Trade-Marks of the Jeweler's  
Kindred Trade  
Second Edition. Price, \$3.00. The Jeweler's  
Circular Publishing Co., 11 John St., New York



## COOPER'S SUN RAY DIAMOND

HAS 100 per cent. more brilliancy  
than any other style of cutting.

*We Challenge the World.*

Send your old mine and yellow  
diamonds to be recut; if the effect  
is not 100 per cent. better, NO  
CHARGE.

## COOPER DIAMOND

Cutting and Polishing Industry of America  
49 MAIDEN LANE, NEW YORK.

Factories, 8th Ave. & 18th St., Brooklyn.



TRADE-MARK.

## AZTEC TURQUOISES

Mines: MINERAL PARK, ARIZONA.



TRADE-MARK.

Of true CERULEAN BLUE, the rarest and most fashionable shade. Turquoises bearing Company's trade-mark are GUARANTEED. A new Turquoise will be given without question to replace any that discolors. The leading Jewelers of the World sell AZTEC TURQUOISES.

**THE AZTEC TURQUOISE COMPANY,**  
12-16 JOHN STREET, NEW YORK.

# MEYEROWITZ BROS.,

IMPORTERS OF

# DIAMONDS,

37-39 MAIDEN LANE,  
NEW YORK CITY

A Complete Line of Precious, Semi-Precious and Imitation Stones. Mail orders promptly attended to

**Morris & Joseph Klein Plead Guilty to Charge of Grand Larceny—Other Indictments Against Them.**

Morris Klein and his brother Joseph, who were members of the Klein Bros. Co., formerly manufacturing jewelers at 51 Maiden Lane, New York, appeared before Judge Ralsky in the Court of General Sessions, Flay, and pleaded guilty to a charge of grand larceny in the second degree on one of the seven indictments that have been filed against them. This step was a surprise to some of the creditors interested in the indictments.

The plea of guilty was entered on an indictment accusing the Kleins of grand larceny by obtaining, on memorandum, and possession of diamonds to the value of \$500, property of H. A. Groen & Bro. There are other indictments growing out of memorandum transactions, charging the defendants with obtaining diamonds valued at \$1,000 from Eduard Van Dam. These diamonds were a portion of those entrusted to the Kleins by Mr. Van Dam, according to the charges that he has made. The total value of the property so delivered was about \$12,000.

Abraham Levy and George M. Simpson represented the complainants in the memorandum cases. They were in court when the defendants pleaded guilty. The passing of sentence was postponed until to-day, and it is intimated that there will be a further postponement. Meanwhile the attorneys are endeavoring to trace the missing memorandum property. It is given out that diamonds and jewelry to the amount of \$24,000 was pawned at 40 per cent. of its value by Henry Levy, of Park Row, and that the defendants afterwards pawned the ticket to him for \$600. The property is not now in Mr. Levy's possession.

The attorneys for the complainants expect that the Kleins may now give some assistance in tracing the missing property, and it is further said that if they do so the court may take that fact into consideration in deciding the degree of punishment.

The assistant district attorney, who is in charge of the case, spoke in court as if it were his intention not to press any of the other indictments. The idea was that the court in passing sentence would take into account the fact that other indictments are pending.

A distinction has been pointed out, however, in the character of the indictments. Some of the presentments accuse the Kleins of obtaining merchandise by false representation in writing of their financial condition. It is argued that when various indictments are bunched together they are generally of the same class. Report has it also that the Kleins realized the grave character of the five indictments, based on their statement in writing, and proposed to make restitution in those cases. Charges of this kind, lawyers say, are not generally hard to prove as memorandum cases, which offer peculiar difficulties in obtaining conviction.

It is charged that by means of their statement in writing the Kleins obtained merchandise to the value of more than \$2,000 from D. C. Townsend & Co., and of more than \$4,000 from C. F. Wood & Co. Before sentence is passed Hastings &

Wilson, as attorneys for the Jewelers' Board of Trade, expect to be heard as to the disposition of the five indictments based on the alleged misrepresentations in writing. It is not unlikely that there will be further developments in the struggle to obtain the return of missing diamonds and jewelry. The efforts of the brothers to make restitution may also have some influence.

The petition in involuntary bankruptcy was filed against Klein Bros. Co., Inc., as related in the issue of Sept. 20, 1905. The following week the brothers were arrested on the charge of larceny made by Mr. Van Dam. The schedules in bankruptcy were filed in November, showing total liabilities of \$50,612. This did not include the memorandum transactions, which, of course, were not entered as debts. The assets, estimated at the time at more than \$9,000, have practically yielded nothing to the creditors.

**Death of Emil L. Lembke.**

Emil L. Lembke, a member of Gall & Lembke, opticians, at 21 Union Sq. and 1 W. 42d St., New York, died Friday of last week in the Hospital St. George, Brooklyn. Mr. Lembke was a native of New Jersey, and was born in Jersey City Dec. 7, 1864; two years later the family moved to Brooklyn.

The business with which he was connected was established in 1842 by his father, Charles Lembke, and Joseph Gall. Their first store was in Union Sq. In 1886 Mr. Gall died and Mr. Lembke purchased his interests, continuing alone until Jan. 1, 1896, when he admitted his two sons, the deceased, Emil L., and Charles, Jr., as partners. Charles Lembke, Sr., retired in February, 1901, and at that time J. A. Obrig was admitted as a member. In 1903 the branch store in W. 42d St. was opened.

Emil Lembke was a Mason and a member of the Crescent Club of Brooklyn. He is survived by one sister, Mrs. Emma Reichmann; one brother, Charles F. Lembke, and a widow, Meta. The funeral services were held at the home of his father-in-law, Ernest A. Obrig, 750 Lafayette Ave., Brooklyn, Sunday evening. Interment was in Greenwood Cemetery on Monday.

**Death of Henry F. Vogel.**

Henry F. Vogel, who for a long time was engaged in the manufacture of jewelry in the Maiden Lane district of New York, died Wednesday night of last week at a hospital in Brooklyn, where he had been for three weeks, having been taken there after an accident in which one of his legs were broken.

Mr. Vogel was 65 years of age. He was born in Germany, and came to this country when a young man. He was employed for a time in jewelry factories, and became a member of the firm of Vogel, Corby & Wesche, now at 17 Maiden Lane, when it was established in 1869. Ten years ago he retired. Walter V. Vogel, now a member of the firm, is a nephew of the deceased.

For 40 years deceased had been a resident of Brooklyn, his home being at 162 Garfield Pl. He was a member of a number of organizations, and was held in the highest esteem. Three sons and three daughters survive. The funeral took place Saturday, and the interment was in Greenwood Cemetery.

**Career of the Late Frank Allsopp.**

NEWARK, June 11.—Frank Allsopp, of Allsopp & Allsopp, whose death in an automobile accident was chronicled in last week's issue, was born at Birmingham, England, in 1875, and came to this country at the age of five years when his parents, Mr. and Mrs. George Allsopp settled in Providence, R. I. The family moved to this city six years later. Frank and his brothers entered the Newark public schools and he graduated from the Miller St. school. After leaving school he entered the jewelry factory of Riker Bros., and obtained a thorough knowledge of the mechanical part of the business. Five years ago he and three brothers established the firm of Allsopp & Allsopp, in which he had since continued.

Mr. Allsopp nine years ago married Miss Annie Spangler. He is survived by a widow, six brothers, George Allsopp, Jr., and



THE LATE FRANK ALLSOPP.

Henry Allsopp, composing the firm of Allsopp Bros., at Camp and Orchard Sts.; William I. Allsopp, manufacturing jeweler, at 475 Washington St., and Thomas Allsopp, Albert Allsopp and Edmund Allsopp, of the firm of Allsopp & Allsopp; by two sisters, Mrs. Charles Shirley, of Providence, R. I., and Mrs. George Sansome, of Morristown, and by his parents, Mr. and Mrs. George Allsopp.

A large circle of friends was greatly shocked by Mr. Allsopp's tragic death. He was an exceedingly popular young man, always companionable and of a pleasing personality. His fad of late had been automobiling. He had bought a large, powerful machine and greatly enjoyed speeding it.

Mrs. Allsopp, who is recovering from her especially severe injuries, has told friends that on the day of the accident she seemed to have a premonition that something would happen. Although she had always enjoyed going with Mr. Allsopp on his automobile trips, on this occasion she had tried to discourage him from going, and she says that she really was hoping until they started that the machine would get out of order or something would go wrong so that they would stay at home.

R. S. Voss, formerly of Conrad, Ia., is now at Waterloo, in the same State.

**WM S. HEDGES & CO.,**

IMPORTERS AND CUTTERS OF

**DIAMONDS.**

Precious Stones and Pearls.

**170 Broadway, Corner Maiden Lane, New York.**

27 Holborn Viaduct, London.

**Saunders, Meurer & Co.** Cutters and Importers of

**DIAMONDS** AND OTHER PRECIOUS STONES

FINE PEARLS A SPECIALTY.

**65 Nassau St., cor. John St.,** Prescott Building, Telephone, 1613 Corlland, **NEW YORK.**

**Chas. L. Power & Co.,** Cutters and Importers,

**DIAMONDS**

AND OTHER PRECIOUS STONES,

**170 Broadway, corner Maiden Lane, NEW YORK.**

27 Holborn Viaduct, London.

**GOODFRIEND BROS.,**

IMPORTERS AND CUTTERS OF PRECIOUS AND IMITATION STONES.

Pearls

Rubies

Sapphires

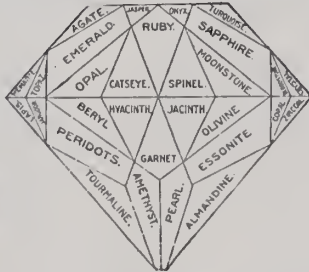

Tourmalines

Gem Corals

Opals

Emeralds

COPYRIGHT, 1895, BY GOODFRIEND BROS.

256 Westminster St., Providence, R. I.  
10 Rue Cadet, Paris.

Tel. No. 662 Cortil.

9-11-13 Maiden Lane, New York.

**CORAL**

**BORRELLI & VITELLI,**  
CORAL MANUFACTURING COMPANY,

All kinds of Coral—DROPS, BUTTONS, LENTILLES.  
CORAL NECKLACES, Graduated and Uniform.

PINK AND WHITE CORAL A SPECIALTY.

GOLD MEDAL, ST. LOUIS, 1904.  
GRAND PRIX, LIEGE, 1905.

3 Via Amedeo, Torre del Greco, Italy. 32 Rue d'Hauteville, Paris, France.  
401 Broadway, New York.

Telephone, 5412 Franklin.

**CORAL**

**CORAL**

**Mr. Retailer:**

If the American People only KNEW the purity of the product of the **SOLIDARITY WATCH CASE CO.**, advertising would be a waste of money.

We never buy old gold and nothing but Virgin Gold, alloyed to 18k. and 14k., is ever allowed to enter our product.

That rich appearance which always distinguishes our cases demonstrates these facts.

Sold through the Jobbers only

**SOLIDARITY**

**Watch Case Co**

Established 1885.

3 Maiden Lane, New York

GENERAL SELLING AGENTS

JOHN W. SHERWOOD  
FRANK E. HARMER

The Marking of Foreign Plate in England—New Marks Adopted.

LONDON, June 1—The following is an epitome of the special report of the Order in Council relating to the hall-marking of foreign plate:

The Court at Buckingham Palace, the 11th May, 1906.

PRESENT.

King's Most Excellent Majesty in Council. Whereas, By the Hall-Marking of Foreign Plate Act, 1904 (4 Edw. VII. c. 6), it is provided that:

(1) Where for the purpose of complying with sections 59 and 60 of the Customs Act, 1842, or section 11 of the Revenue Act, 1883, any plate is to be assayed, stamped and marked, or where for any other purpose any plate or article imported from any foreign part is brought to an assay office in the United Kingdom to be assayed, stamped, and marked, the plate or article shall be marked in the manner as His Majesty may determine by Order in Council so as readily to distinguish the plate or other article was wrought or made in England, Scotland, or Ireland, or was imported from foreign parts, and such mark or marks shall be deemed to be a compliance with the said

Any person, who, after a date fixed by His Majesty by Order in Council, brings or causes to be brought any plate or other article to be assayed, stamped and marked at an assay office, shall state in writing in the manner provided by His Majesty by Order in Council, whether the plate or article was wrought or made in England, Scotland, or Ireland, or was imported from foreign parts, but it shall not be necessary to make such statement in writing any plate or other article is brought to an assay office in charge of an officer of customs, the provisions of the Revenue Act, 1883,

for the purpose of being assayed, stamped, or marked as having been imported from foreign parts.

(3) Where any person, who, after the date fixed as aforesaid, brings or causes to be brought any plate or other article to be assayed, stamped, and marked at an assay office, does not know and is not able to state whether the plate or other article was wrought or made in England, Scotland, or Ireland, or was imported from foreign parts, such person shall make a statement in writing to that effect in the manner prescribed in this section, and the plate or other article referred to in the said statement shall be stamped and marked as if it were imported from foreign parts.

(4) If any person knowingly makes a false statement under this section he shall be liable, on summary conviction, under the Summary Jurisdiction Acts, to a fine not exceeding £5 for every article in respect of which the false statement is made.

(5) The Customs Act, 1842, shall apply as if a reference to the mode of marking required under this act were substituted for a reference to the mode of marking under that act.

(6) His Majesty may, by Order in Council, revoke, vary, or add to any Order in Council made under this act.

And whereas by Order in Council dated the 24th day of October, 1904, His Majesty did determine the mark or marks to be stamped or marked upon any plate or article imported from foreign parts brought to an assay office in the United Kingdom to be assayed, stamped, or marked at an assay office and did determine the form of the statement in writing to be made by any person other than an officer of customs bringing or causing to be brought any plate or article to be assayed, stamped, and marked at an assay office:

And whereas it has been found expedient (i) to vary the said Order in Council of the 24th day of October, 1904, by altering the particular marks

to be used by the assay authorities of London, Sheffield, Glasgow and Dublin, and (ii) to alter the form of the statement in writing set out in Part II. of the Schedule to the said Order and to effect these alterations it has been determined to revoke the said Order in Council of the 24th day of October, 1904:

Now, therefore, His Majesty, by and with the advice of His Privy Council and in exercise of the powers vested in him by the above recited provisions doth as from the dates hereinafter respectively specified revoke the said Order in Council of the 24th day of October, 1904, and doth determine that as from the said dates respectively:

(1) The mark or marks to be stamped or marked upon any plate or article imported from foreign parts brought to an assay office in the United Kingdom to be assayed, stamped or marked, shall be the mark or marks described in the first part of the schedule hereto and the following authorities, that is to say:

The Wardens and Commonalty of the Mystery of Goldsmiths of the City of London.

The Guardians of the Standard of Wrought Plate, Birmingham.

The Company of Goldsmiths of the City of Chester.

The Guardians of the Standard of Wrought Plate, Sheffield.

The Incorporation of Goldsmiths of the City of Edinburgh.

The Goldsmiths' Company of the City of Glasgow.

The Fraternity or Company of Goldsmiths of the City of Dublin.

Shall respectively cause to be stamped or marked upon any plate or article imported from foreign parts and brought to an assay office in the United Kingdom to be assayed, stamped or marked the

FIG. 1.

PARTICULAR MARK FOR EACH ASSAY AUTHORITY.

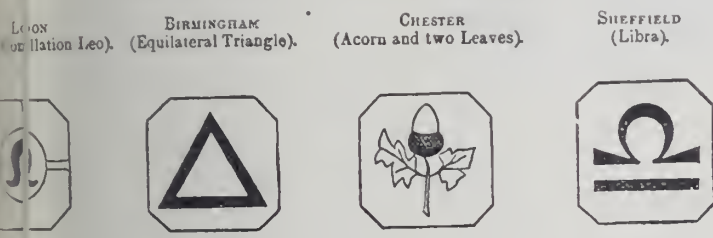

GOLD.

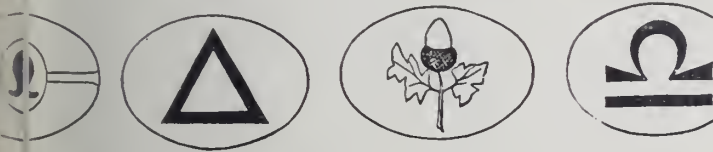

SILVER.

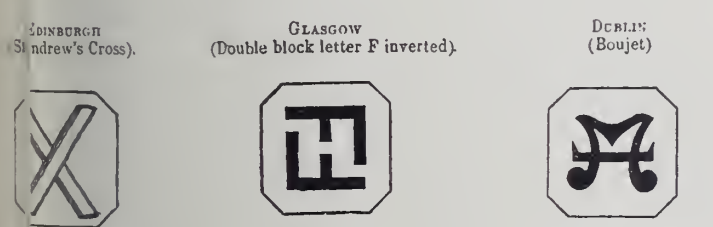

GOLD.



SILVER.

FIG. 2.

REPRESENTATION OF STANDARD MARKS.



GOLD.



GOLD.



GOLD.

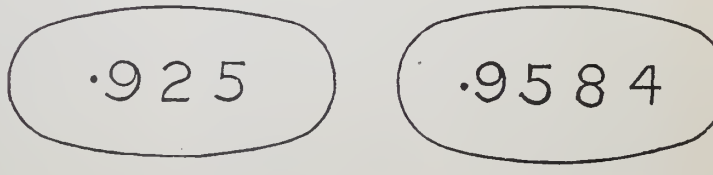

SILVER.

ADDISON W. WOODHULL, President.  
FRANK K. HUFF, Vice-President.

GILBERT T. WOODHULL, Treasurer.  
WILLIAM J. McQUILLIN, Secretary.

## MOUNT & WOODHULL,

IMPORTERS OF

DIAMONDS,

OTHER PRECIOUS STONES,

PEARLS, ETC.

MAKERS OF

FINE  
DIAMOND  
JEWELRY.

26 Maiden Lane,

(Southwest Corner Nassau Street)

NEW YORK.

PARIS ADDRESS:  
5 SQUARE DE L'OPERA.

**BAGG, PERINE & CO.,**  
RARE SPECIMENS OF  
DIAMONDS AND OTHER  
PRECIOUS STONES,  
21 & 23 MAIDEN LANE, NEW YORK.  
Tel. No. 6228 Cortlandt.

EMERALDS,  
DIAMONDS  
AND  
PEARLS.

RUBIES AND  
SAPPHIRES.

CABLE ADDRESS:  
MILBAGG.

A word to the wise is sufficient

"GEMFINDER"

## The Graduation Gifts

### CROSSMAN COMPANY

Have them in their swell 14K. line of dainty Baroque Pearl Jewelry. Art Rings, Necklaces, Pendants, Collars and Ear-Screws especially.

3 Maiden Lane, - New York.

respective mark or marks described in the part of the schedule hereto.

(2) The statement in writing to be made by person other than an officer of customs who or causes to be brought any plate or article assayed, stamped, and marked at an assay office shall be in the form and signed in the manner set out in the second part of the schedule hereto.

This order shall come into operation and effect as from and after the 29th of May, 1906, except so far as regards the assay offices of Scotland and Glasgow and as regards those offices the order shall come into operation and take effect from and after the 1st of July, 1906.

A. W. FITZGERALD

#### SCHEDULE.

##### PART I.

##### On Foreign Gold Plate or Articles.

The hall-mark particular to each assay office shown in Figure 1 of the appendix hereto, together with the decimal equivalent of the karat value, as shown in Figure 2 of the appendix.

##### On Foreign Silver Plate or Articles.

The hall-mark particular to each assay office shown in Figure 1 of the appendix hereto, together with the decimal equivalent of the standard of the silver, as shown in Figure 2 of the appendix.

The mark for the annual date letter is added by each assay authority after the mark of the particular hall and the mark for standard.

##### PART II.

I hereby certify and declare [on behalf of a person authorized by (here insert the name of the authorizing party)] that all the above-mentioned articles were

(Here set out whether wrought or made in England, Scotland, or Ireland, or whether imported from foreign parts), or,

I hereby certify and declare [on behalf of a person authorized by (here insert the name of the authorizing party)] that it is not known to me whether the said (insert the name of the authorizing party) whether the above-mentioned articles were wrought or made in England, Scotland, or Ireland, or were imported from foreign parts.

To be signed

(1) In the case of a sole trader by the trader and in the case of a private firm by a member of the firm or in either case by any other person duly authorized in writing and approved by the assay authority.

(2) In the case of a company by a director or the secretary.

#### Involuntary Bankruptcy Petition Filed Against Grosse & Kappeler, Dayton, O.

CINCINNATI, Ohio, June 8.—An involuntary petition in bankruptcy was filed today by Carl Lenz in the United States Court at this city against Grosse & Kappeler, who formerly conducted a jewelry store in Phillips House block at Dayton, O. On the petition it is said that Mr. Kappeler sold out to Mr. Grosse, a short time ago, and disposed of his stock to Bert Shroyer since then his creditors have not been paid. The petition asks that Mr. Grosse be declared a bankrupt and that Mr. Schaeffer be compelled to return goods sold to him.

The firm of Grosse & Kappeler was formed about a year ago, and was composed of William H. Grosse and John Kappeler. The former succeeded E. A. M. in 1904, and was later joined by Mr. Kappeler, who had until then been in the jewelry business. Both partners were well thought of in the trade, and were considered capable and industrious. That Mr. Kappeler had sold out to Mr. Grosse was generally known in the trade, and the filing of the bankruptcy petition, therefore, came somewhat as a surprise.

John D. Reynolds, Jr., Roland Park, Baltimore, Md., associated in business with Hennege, Bates Co., of which company his father is vice-president, and Miss J. Redmon, were united in marriage June

**Concurs in Amendments.**

**House of Representatives Agrees to Senate's Changes in Gold and Silver Stamping Law.**

WASHINGTON, D. C., June 8.—The Jew-  
elry Trades Gold and Silver Stamping Bill,  
introduced by Representative Vreeland,  
is now to President Roosevelt for his  
signature, having been passed by both  
branches of Congress, the House to-day  
having concurred in the two amendments  
which the Senate made to the measure when  
it was passed by that body.

This measure has made a record in both  
the House and Senate, and the speed with  
which it has been acted on, both by com-  
mittees and the bodies themselves, has  
caused universal surprise, but has been  
clearly indicating the fact that the  
legislation was conceded to afford a protection long  
desired by the public, and give to the jew-  
elry trade an opportunity to purge itself of  
unfair competition through dishonest  
methods that have been open to illegiti-  
mely manufacturers for many years.

The bill which has been several times pub-  
lished in these columns was favorably re-  
ported by the Committee of Interstate Com-  
merce, of the House, within a very short  
time after it was introduced, and passed by  
the House without amendment. It was  
then sent to the Senate and favorably re-  
ported by the Interstate Commerce Com-  
mittee of that body, which reduced the penalty  
and increased the time in which the bill was  
to go into effect, from six months to one  
year, after its passage.

When it was first sent back to the House  
it is believed that Mr. Sherman, who was  
temporary chairman of the Interstate Com-  
merce, when the bill was reported, and who  
showed a deep interest in the measure,  
would oppose the amendment of the Senate  
requiring the time to a year. Congressman  
Vreeland, who has worked strenuously in  
favor of the measure, went home sick this  
week and left the bill in the hands of Mr.  
Sherman, who, after consideration, decided  
not to oppose the amendments and moved  
for adoption in the House. The bill was  
quickly passed, and now simply awaits  
President Roosevelt's signature before be-  
coming a law.

**Trans-Atlantic Voyagers.**

**TO EUROPE.**

P. A. Coon, of the P. A. Coon Mfg. Co.,  
Sarasota, N. Y., sailed last week on the  
*Island*

D. Atlas, of Atlas & Fisher, Philadelphia,  
sailed Saturday on the *Kroonland*.

L. Amstel, of factory "E" of the In-  
ternational Silver Co., Meriden, Conn.,  
sailed last week on the *Amerika*. Ludwig  
Nissen, of Ludwig Nissen & Co., and Mrs.  
Nissen sailed on the same boat.

Wm. Kleinschmidt, of Kleinschmidt,  
Brooklyn & Co., New York, and wife, sailed  
recently on the *Cedric*. On the same boat  
were Henry C. Cornwell, of Theodore B.  
Cornwell, New York, and Mrs. Cornwell.

Ed. Grosse, of Grosse, of Grosse & Walker,  
New York; Arthur Qilberfeld, New York;  
Walter N. Walker, of Hodenpyl & Walker,  
New York; James P. Harper, New York;

Mark Van Wezel, of S. L. Van Wezel, New  
York, with his wife and son, and Miss Elsa  
Kahn, daughter of M. Kahn, of L. & M.  
Kahn & Co., Newark.

**FROM EUROPE.**

Returning yesterday on the *Kaiser Wil-  
helm II*, were: M. B. Rosenback, of Wm. I.  
Rosenfeld, New York; George De Vries, of  
Eduard Van Dam, New York.

Henry Fera, of Fera & Kadison, New  
York, returned last week on the *Amerika*.

**Heads of Departments of Gorham Mfg.  
Co. Hold Annual Outing.**

PROVIDENCE, R. I., June 11.—The over-  
sighters and heads of departments of the Gor-  
ham Mfg. Co. held their annual outing at  
the Warwick Club, last Saturday, a large  
number being present to enjoy the yearly  
event. Special cars took the company to  
the pleasant resort, and then a series of  
field sports was begun. These included a  
baseball game under the management of  
J. Baker and R. Durfee; bowling, J. Straker  
and C. Rivard in charge; rifle shooting, A.  
Erichsen and E. Pick; quoits, G. Rhodes  
and A. Angilly; shot put, C. Weeks and  
N. McIntosh; long kicking contest, H.  
Reeves and G. Harley.

At the conclusion of the sports a fine  
Rhode Island clam dinner with all the "fix-  
ings" was served, and then came a season  
of music and mirth, the Gorham Orchestra  
furnishing music. E. F. Aldrich was toast-  
master, and the remainder of the programme  
was as follows: Remarks, F. C. Lawton;  
remarks, J. F. P. Lawton; informal address,  
W. C. Codman; vocal selection, W. Hughes;  
address, F. A. Wing; sword contest, J. C.  
Butterworth, 3d, and Victor Castaldi.

The heads of the departments were as  
follows:

- A. R. Peck, 1858; F. A. Jordan, 1860; J. Salt,  
1862; A. F. Burgess, 1865; J. Baker, Jr., 1865;  
W. Hughes, 1865; J. E. Straker, 1865; F. A. Burt,  
1866; D. W. Darling, 1868; L. K. Seagrave, 1869;  
A. J. Angilly, 1871; C. F. Phillips, 1871; C. Web-  
ster, 1871; C. Rees, 1872; G. Robinson, 1872;  
I. Thurber, 1872; W. F. Smith, 1873; C. Fulford,  
1876; G. Wightman, 1877; E. W. Crocker, 1878;  
C. E. Weeks, 1879; W. Crook, 1880; W. A. Day,  
1880; H. V. Gardiner, 1880; W. E. Westfield, 1881;  
C. W. Crawford, 1882; A. C. Brown, 1884; W.  
D. Hall, 1884; G. W. Rhodes, 1885; E. J. White,  
1885; S. B. Allen, 1886; G. Boyle, 1886; J. H.  
Harty, 1886; N. McIntosh, 1886; J. E. Pender,  
1886; L. P. Rittmann, 1886; G. A. Townsend,  
1887; W. A. Clissold, 1888; E. A. Cordery, 1889;  
G. E. Harley, 1889; R. E. Peters, 1889; E. Sher-  
wood, 1889; E. A. Enchsen, 1890; H. Jackson,  
1890; C. N. Lawton, 1890; E. A. Truelove, 1890;  
C. W. Lee, 1890; W. S. Allebaugh, 1891; R. W.  
Higgins, 1891; W. W. Higgins, 1891; H. Reeves,  
1891; C. A. Rivard, 1891; J. A. Shearman, 1891;  
V. E. Smith, 1891; J. J. Sullivan, 1891; G. Tickell,  
1891; G. H. Wightman, 1891; W. S. Winslow,  
1891; E. I. Peck, 1892; E. H. Dimond, 1893; W.  
E. Johnson, 1893; R. I. Blanchard, 1894; E. B.  
Turner, 1894; W. E. Belcher, 1895; J. S. Briggs,  
1895; G. C. Richter, 1895; C. M. Sylvia, 1895;  
H. A. Spencer, 1896; R. Durfee, 1899; W. E.  
Gould, 1901; W. H. Achurch, 1902; J. J. Cos-  
grove, 1902; C. A. Gould, 1902; C. H. Keach,  
1902; W. F. Kingman, 1902; F. W. Mason, 1902;  
J. J. Norman, 1902; F. B. Greeley, 1903; J.  
Mueller, 1903; E. W. Woodward, 1903; W. J.  
Bannon, 1904; H. E. Chapman, 1905; J. C. Gor-  
don, 1905; G. E. Thomas, 1905; W. B. Jones,  
1906.

The guests were: J. S. Holbrook, J. F.  
P. Lawton, H. A. Bliss, E. F. Aldrich, W.  
C. Codman, F. A. Wing, F. C. Lawton, W.  
H. Whipp and W. H. Browning.

The Moultrie Jewelry Co., Moultrie, Ga.,  
recently purchased the Moultrie Book Store,  
of the same place.

**Abraham Lipp, Whose Conviction Was  
Reversed on Appeal, Not to be Tried  
Again.**

Abraham Lipp, who formerly had a jew-  
elry store at 417 Bromfield St., Boston,  
Mass., is not to be tried again on the  
charges preferred against him by Sol. Lin-  
denborn, New York. The information was  
obtained this week from Adolph H. Rosen-  
feld, who in February last argued Mr.  
Lipp's appeal in the Supreme Court, Ap-  
pellate Division, First Department. The  
appeal was from a verdict of a jury in the  
Court of General Sessions, convicting the  
Boston man of grand larceny in the first  
degree. The higher court reversed the de-  
cision and ordered a new trial. Recently  
Mr. Lipp was discharged without bail, and  
his attorney says that there is no doubt that  
the case is ended.

Mr. Rosenfeld recently received a copy  
of the opinion handed down by the Appel-  
late Division, reversing the decision of the  
lower court. The Appellate Court says that  
repeated and careful readings of the records  
justify the justices in holding that the  
conviction should not be allowed to stand.

The court then reviewed the facts. The  
defendant on July 29, 1904, bought jewelry  
from Mr. Lindenborn at his office, 170  
Broadway, to the amount of \$2,700. Mr.  
Lindenborn was not present, but was repre-  
sented in the transaction by his clerk, Cy.  
Price. Lipp gave in ostensible payment  
diamonds to the value of \$929.20, two  
checks—one for \$900, the other for \$955.20  
—and \$200 in cash. The \$900 check was  
paid on presentation, but the check for  
\$955.20 was dishonored. The complainant  
tried to show that Lipp on buying the jew-  
elry claimed to have \$2,200 in cash in his  
bank in Boston. Lipp claimed that Price  
had agreed to hold the checks instead of  
forwarding them for immediate collection.  
Price was not called as a witness, being in  
St. Louis at the time of the trial.

The following paragraphs in the opinion  
indicates the view of the court on the law  
involved:

It is manifest to us that the good faith of the  
prosecution of this defendant is seriously im-  
peached by the record. When the check for  
\$955.20 was returned to Price dishonored, he en-  
tered at once into negotiations with the defendant  
to secure its amount. From all that appears,  
Price made no claim of any felonious or fraudu-  
lent conduct on the part of the defendant in buy-  
ing the merchandise. He went to Maine to nego-  
tiate with the defendant respecting a transfer of  
real estate, took a deed of that real estate to secure  
the indebtedness and did so after conference with  
a lawyer in Maine concerning it.

On Aug. 11, 1904, Price wrote to the defendant  
as follows: "Upon receipt from you of a settle-  
ment of your account, I will deed back to you  
the property which you have this day deeded to me,  
or if I have disposed of same I will give you  
credit on account for such amount as I receive  
for the equity." The whole matter was adjusted  
as an indebtedness before this indictment was  
found. It was treated by Price as a simple in-  
debtedness and no suggestion that the transaction  
involved original responsibility was made.

The Massachusetts Retail Jewelers' As-  
sociation will meet at 2 p. m. Thursday,  
June 21, at the American House, Boston.  
Several new members will be voted in and  
delegates to the national meeting in Roches-  
ter, N. Y., Aug. 3 and 4, will be elected.  
Plans will also be completed for the asso-  
ciation's July meeting and fish dinner at  
Bass Point, Nahant.

# EICHBERG & CO.,

IMPORTERS AND CUTTERS OF

## DIAMONDS,

65 NASSAU STREET, (Prescott Building.) NEW YORK.

# STERN BROS. & CO.,

IMPORTERS AND CUTTERS OF

## DIAMONDS,

CUTTING WORKS: 68 Nassau St.,  
138-142 West 14th St., N. Y. NEW YORK.  
CHICAGO, LONDON,  
103 State St. 29 Ely Place.

### A. ROSEMAN, 9-11-13 Maiden Lane, New York

IMPORTER OF

## DIAMONDS

Maker of Diamond Jewelry



TRADE-MARK.

Established 1872

HEADQUARTERS FOR

## AMERICAN WATCHES

IMPORTERS

## DIAMONDS

CUTTERS

### Jacob Strauss & Sons

14 MAIDEN LANE

NEW YORK

### LEO GOLDSMITH, IMPORTER OF DIAMONDS

TELEPHONE: 4115 CORTLAND.

and Precious Stones. Headquarters for Reconstructed Rubies and Sapphires. All sizes and forms.

9-13 MAIDEN LANE,

NEW YORK.

### SOHN and HYMAN

IMPORTERS OF PRECIOUS AND IMITATION STONES

Crystals Engraved and Painted from Photo. Crests and Coats of Arms Engraved. Stone Seal Engravers and Incrusters. Lapidary Work a Specialty.

JOBGING STONES A SPECIALTY

47 and 49 Maiden Lane,

NEW YORK

THE BOSTON DIAMOND HOUSE

### JOHN B. HUMPHREY CO.

387 Washington St., Boston, Mass.

We are receiving Monthly Shipments of Diamonds from our Brazilian Mines, which are on exhibition at our Boston Office.

## TRADE-MARKS

OF THE JEWELRY AND KINDRED TRADES. Over 4,000 Marks. Second Edition. Price, \$3.00. The Jewelers' Circular Pub. Co., 11 John St., N. Y.

### New Stores and Enterprise

F. G. Burgy is a new jeweler in Brwick, Mo.

John Hays has begun business in wanda, Kans.

R. D. Mead has opened a jewelry ring shop in Lyons, Ga.

F. W. C. Hudson recently commenced business in Quincy, Wash.

Mr. Osment and John D. Black are to open a store in Marietta, Ga.

A. R. Hazard has opened optical parlour at 84 Adams Ave., Detroit, Mich.

Wilson Torrance recently opened a jewelry repairing shop in Davidson, N. C.

J. Greenberg last week started in business at 1324 Buchanan St., San Francisco, Cal.

Scribner & Stone have opened a jewelry and optical establishment in the Hotel block, Newport, Wash.

Mr. Harmer, a druggist, of Phoenix, Ariz., has added a stock of jewelry, and shortly move into larger quarters.

H. C. Parsons and C. R. Hotchkiss completed arrangements to open a jewelry and optical establishment in W Valley, Miss.

The Gopher Diamond Parlor has opened for business with a stock of stones, jewelry and watches on Robert St., near 6th St. Paul, Minn.

Wines & Creekmore have opened a jewelry store at Richmond, Ky., in connection with their drug store at Findlay, O. Shannon will act as manager.

The Newman Clock Co., Warwarsin, N. Y., was recently incorporated, with a capital stock of \$10,000. The incorporators were L. D. Baldwin and D. E. Miner, New York, and C. E. Ranshaw, New Jersey.

The Edwin C. Heathcote Co. was incorporated recently with a capital of \$50,000. The main office will be in New York. The incorporators were: N. M. Stevens, Chattel and J. C. Heathcote, Brooklyn, N. Y.

The Walter E. Longmate Co. is the result of a new concern incorporated in Albany, N. Y., with a capital stock of \$5,000. The incorporators were: W. E. Longmate, Buffalo, N. Y.; Nelson S. Hallett and A. R. Johnson, Buffalo, N. Y.

Maynard & Potter, Inc., have just been incorporated in the State of Massachusetts to manufacture and deal in diamonds and other precious stones, with a capital of \$50,000. The officers are: President, T. Maynard, Brookline; treasurer, Potter, Newton.

D. C. Woodward has vacated his store in the McEntyre block, 4 Merchants, Randolph, Vt., and for the Summer will conduct his business at his home in Main St.

The papers incorporating the Schweizer Bewig Jewelry Co. were filed in the office of the Probate Judge of Dallas, Ala., last week. This concern, which succeeds to the business of Schweizer jewelers and opticians, 1005 Broad St., Selma, has a capital of \$25,000, and by the following officers: Dr. F. G. D. president; A. P. Schweizer, secretary; treasurer; Geo. F. Bewig, manager. The Board of Directors is composed of the following officers, together with W. M. Vaughan and S. A. Fowlkes.



## Philadelphia.

omer Vernon, a watchmaker of this city has accepted a position with G. H. Hiner, Wildwood, N. J.

P. White is kept busy completing the finishing of his quarters in the Burdaling, 9th and Chestnut Sts.

The Parisian Rich Cut Glass Co. was last week by the United Gas Improvement Co. to recover for a gas bill allegedly owed.

P. Zane, Christiana, Pa., spent a few days in this city last week on his way home from a pleasure trip to Gettysburg, Baltimore and Washington.

E. Caldwell & Co. were awarded the contract last week for the prizes to be distributed at the polo tournament of the Philadelphia Country Club.

Warner Hutchins, 728 Sansom St., is in Chicago attending the Imperial Council of the Mystic Shrine, to which he is a delegate from the Lu Lu Temple, of this city.

Charges of stealing packages of jewelry consigned by manufacturers to local jewelers from the Adams Express Co. against G. A. Coleman and John Sutcliff were arrested and held in bail for trial.

After Korn's new jewelry store at 10th and Chestnut Sts. narrowly escaped being seriously damaged last week when two trolleys collided near it and one of them was forced on to the pavement up to the glass windows.

In a recent note it was stated that W. B. Hens, 717 Sansom St., had moved with his family to Wildwood, N. J., for the Summer. Attention should have been made of the fact that Mr. Hens will remain in Philadelphia to continue his enameling business.

A report of interest to the trade has been received here from Atlantic City, to the effect that Sarah Bernhardt purchased \$40 worth of jewelry from Boardwalk merchants while in Atlantic City last week. The Sansom St. trade is speculating as to who were the fortunate merchants.

Out-of-town retailers in this city during the week included: E. J. Weider, Pennsylvania; G. A. Jacot, South Bethlehem, Pa.; Isaac Brademann, Reading; Gustave Lanz and his son, Norristown, Pa.; J. W. Parrish, Newark, Del.; D. H. Krause, North Wales, Pa., and S. Bell, of the Bell-Smith Jewelry Co., Atlantic City, N. J.

A gold brick weighing 57.49 ounces, and valued at \$1,001.25, was exhibited in the show window of the Bailey, Banks & Biddle Co. last week, where it attracted attention from hundreds of people passing by. It was presented to the Denver Lodge of Elks by the Fifty Gold Mines Corporation of Black Hawk, Col., and will be given as first prize to the best band in uniform in the parade at the Denver reunion next month.

Since M. Sickles & Sons' baseball nine defeated the nine organized from the employees of H. O. Hurlburt & Sons last week it has been challenged by almost every other jewelry house of the city. This, the first game of the season, has stimulated interest in the games to be played, and S. Sons, Bro. & Co., I. Bedichimer & Co., L. P. White, B. F. Williams Co., and some of the leading retail houses, are preparing

to wrest the baseball laurels from Sickles' team. It is proposed to play games every Saturday during the Summer.

Accused of having robbed her employer, W. H. Rexford, proprietor of a jewelry store on Market St., Retta McMullen, a young woman, was arrested, last week, and held in \$600 bail for trial by Magistrate Eisenbrow. For weeks past Rexford has been missing money and jewelry. Suspicion was finally directed toward the young woman, who was employed as cashier, and she was arrested on the specific charge of embezzling \$1.75, part of the receipts of a sale. Upon being questioned the police say she admitted that she had stolen property at home. A detective accompanied her to her house, and there recovered 40 rings.

The board of governors of the Jewelers' Club, at its meeting Tuesday of last week, decided to hold its annual outing this Summer in the nature of a baseball game and a vaudeville show, to be given June 26. The game is to be played between the New York and Philadelphia members of the club. Calls for volunteers have been sent out by those in charge of both teams, and the rivalry promises to be of the keenest but most good-natured sort, such as characterized the baseball rivalry of the club some years ago. The management of the Philadelphia National League team has permitted the jewelers to compete for baseball honors in their field. The wives and children of the members will be invited to witness the game. Afterward it is proposed to entertain the club guests at the headquarters, 13th and Chestnut Sts. This will be followed by a vaudeville entertainment at the Athletic Club, 11th and Catharine Sts. Tickets for the ball game are to be complimentary to all members and their friends. The entertainment at the Athletic Club is proposed to be of a high-class order. Samuel H. Kendall's band has been engaged to enliven the afternoon and evening.

## Syracuse.

P. A. Coon, of the P. A. Coon Silver Mfg. Co., sailed last week on the *Friesland*, to be gone during the months of June and July.

A. Jacobson, who runs a pawn shop in E. Washington St., was recently robbed by a pickpocket of a pocketbook containing \$72 and some papers at the New York Central station, while waiting for the arrival of relatives from out of town. The police were notified.

The Jewelers' Association of Milwaukee, Wis., which was recently organized as told in the last issue of THE CIRCULAR-WEEKLY, held another meeting last week, after which it was announced that 38 of the 45 firms eligible to membership had been admitted. It was decided to admit concerns in lines allied to the jewelry trade, such as optometrists and engravers, as well as wholesale dealers. Besides the officers mentioned last week the following directors have been elected: William H. Upmeyer, Theo. Schelle and E. F. Rohn. Meetings will be held every month hereafter, and a dinner will be a part of the program of each session.

## Newark.

Percy Burnett started yesterday on the road for Schultz, Leiss & Co., and will represent them in Pennsylvania, Ohio, Michigan and Indiana.

Cards were sent out to the trade last week calling attention to the dissolution of Schwarzkopf & Dorer, and also to the incorporation of the Schwarzkopf Mfg. Co., at 475 Washington St. The plant is being improved and the facilities will be considerably increased.

The Gibson-Krugler Co. is establishing at 306 Market St. a new factory for the production of fine jewelry. F. Gibson, of the new firm, is a traveler well known in the west, where for years he successfully represented the H. A. Kirby Co., the Wm. Kinscherf Co., and Champenois & Co.

William H. Jones, of the jewelry manufacturing firm of Jones & Woodland, closed up his home in Orange last week, and on Wednesday sailed for Europe on the *Amerika*. He is accompanied by Mrs. Jones and their daughter. He took with him his new Packard automobile, and the party will spend five months in touring through Germany, France, Austria, Italy, Switzerland and England.

President L. B. Hilborn, of the New Jersey State Optical Society, writes to THE CIRCULAR-WEEKLY a communication urging that all opticians in New Jersey who are not members of the society should at once make application for membership blanks. He has been informed that at the next session of the State legislature an effort will be made by physicians to have an amendment to the medical practice act adopted for the purpose of restricting the optometrists in prescribing lenses. It is stated that the provision to be offered is drawn broadly, so as to apply to all who fit, sell, manipulate or otherwise treat or care for by manual or mechanical means any apparatus or method for the relief of any bodily ill or defect. The society, Mr. Hilborn points out, intends to defend the rights of its members, and, therefore, all opticians who should get inside the lines of the organization.

William Jeckel, 46 years old, a silversmith, who had for several months been in the employ of Unger Bros., and who lived at 47 Morton St., lost his life on Sunday while making a heroic effort to save two children from being ground to pieces by a Central Railroad train at the Spring St. station in Elizabeth. He seized the children and threw them aside in time to save them from sustaining even a scratch. Witnesses of his bravery were so certain that he could not escape injury that they turned away as the tots landed on the station platform and Jeckel made a desperate effort to reach the same spot. A fraction of a second would have saved him, but as he took the last step that was necessary to land him on the platform the pilot of the engine struck him and hurled him aside with great force. It was not thought at first that he was seriously hurt, but when he was taken to a hospital it was found that his injuries were fatal. He died a short time afterward without having regained consciousness. His body was taken to Newark on Monday. He was unmarried.

SEND TO US ANY QUANTITY OF

# AMERICAN PEARLS

WE BUY FOR CASH.

Send by registered mail or express; we will make an offer by return mail. We will also buy any quantity of

## BAROQUE PEARLS (SLUGS).

### BUNDE & UPMAYER CO.,

Mack Block,

MILWAUKEE, WIS.



### String Pearls

DAME FASHION DICTATES  
STRING PEARLS

Our stock is complete.  
Prices range from

30c. to \$25.00 per String

### Rhinestone Combs

New, Artistic and Exclusive  
Parisian Designs

\$18 to \$84 per dozen

Selection packages sent on request.

## CHOPARD FRÈRES

MAKERS OF ART JEWELRY NOVELTIES.

49 Maiden Lane - - - NEW YORK

FACTORY: 35 Rue Des Trois Bornes, PARIS, FRANCE.

## AMERICAN PEARLS

*From Ten to Ten Thousand Dollars Each*

MAURICE BROWER, 16 John St., New York.

A. Nonnenmann & J. Aschenbrenner,  
114-118 East 23d St., New York.

Original Designers for Plating  
Gold and Silver Jewelry. Artistic  
Designs for Silverware and Novelties  
finished at shortest notice.

### Eliassof Bros. & Co.

IMPORTERS  
AND  
JOBBER'S OF

### DIAMONDS WATCHES JEWELRY

9-11-13 MAIDEN LANE,  
NEW YORK.

100 STATE STREET,  
ALBANY, N.Y.



A LARGE ASSORTMENT OF DIAMOND  
MOUNTED JEWELRY CARRIED IN STOCK.

**Connecticut.**

aj. C. H. Case, Hartford, left Thurs-  
for a 10 days' trip to Rangeley Lakes,

Hirsch & Son, 1005 Main St., Hart-  
are about to sell out to M. W. Bas-

the City Hall clock, of Hartford, has  
started going again after a short  
of inactivity.

Alexander Harper, manager of the Amer-  
Silver Co.'s office in Chicago, is in  
on a short trip.

the factory of the Bradley & Hubbard  
Co., Meriden, closed June 9, and will  
in so during Centennial week.

Thomas I. Gwillim, accompanied by his  
and daughter, has left for Standish,  
where they will spend the Summer  
ths.

Emuel Stohr, a designer at Factory "E,"  
national Silver Co., Meriden, sailed  
uly on the *Amerika*, of the Hamburg-  
American Line, for Europe. He will re-  
home about July 19.

Edward B. Tileston has resigned his  
ion as foreman of the manufacturing  
ch of the chandelier department of the  
Bradley & Hubbard Mfg. Co., Meriden,  
having been associated with that com-  
e for about 36 years.

Charles Bradley, who for several years  
e a responsible position with the New  
and Watch Co., Waterbury, died Wed-  
ay, at the Hartford Hospital, aged 45  
es. Mr. Bradley's father was at one  
r Mayor of Waterbury.

o. M. Curtis, chairman of the Centen-  
Committee, last week, received from  
ident Roosevelt a letter expressing his  
ept owing to his inability to accept the  
ation of the people of Meriden to at-  
the centennial celebration, June 10-16,

old Evans, 15 years old, was killed  
ay afternoon by an automobile owned  
n driven by Edgar E. Vassick, manager  
secretary of the Burns Silver Co.,  
Bridgeport. Medical Examiner Downs  
iced the body and reported that death  
accidental.

ices have been published in the dif-  
ent departments of the Seth Thomas  
k Co.'s factory, Thomaston, notifying  
mployees that the annual Summer vaca-  
o will begin July 26 and continue until  
at 13. During that interval extensive  
movements will be made in the case

phus B. Rogers, Meriden, has received  
Congressman N. D. Sperry a letter  
ng that it will be impossible for Meri-  
e to get the additional appropriation  
ll for a new postoffice. Mr. Rogers is a  
nber of the committee appointed some  
hs ago to look after the extra appro-  
rion.

William F. Winslow, superintendent of  
William L. Gilber Clock Co., Winsted,  
brought suit for \$2,000 damages against  
own of Winsted. His automobile went  
ve a steep bank on Cottage St. last fall  
was completely wrecked. Mr. Wins-  
alleges that the road was in bad condi-  
o there being no railing at the point.

the case of Jos. Marchitto against the  
Waterbury Clock Co., Waterbury, an ac-

tion to recover \$1,200 damages for injury  
to the plaintiff's finger while working in  
the defendant's factory, Judge Reed in the  
Superior Court, Thursday, handed down  
the judgment of the plaintiff to recover a  
nominal damage amounting to \$25 and costs.

Carl G. Aldrich, formerly of Winsted,  
has entered the wholesale jewelry business  
in Boston, Mass. The business, which was  
formerly conducted in Winsted by Mr.  
Aldrich, has been absorbed by the Aldrich  
Murphy Co., Inc. The officers of the new  
concern are: President, Carl D. Aldrich;  
secretary and treasurer, Louis G. Murphy.

The silver service for the battleship *Con-  
necticut*, which has been made by the In-  
ternational Silver Co., was inspected, June  
7, by Gov. Roberts, Gen. Henry C. Dwight  
and Francis B. Allen, of Hartford, mem-  
bers of the State Commission appointed to  
make the purchase. The service will be  
exhibited during the Centennial week, in  
Meriden.

Wm. C. Hawley, of Davis & Hawley  
Co., Bridgeport, captured one of the two  
men who stole a pin set with diamonds  
and opals from the store one day last week,  
just as the thief was about to leave town  
on a train. When taken to police head-  
quarters the prisoner gave his name as  
John Rolling, and said he resided in New  
York. Rolling's confederate escaped. The  
pin, which is said to be valued at \$85, was  
not recovered. It was subsequently learned  
that the real name of the man captured by  
Hawley is Haines, and that he is well  
known to the Pinkerton Detective Agency.

**Providence.**

Councilman George W. Parks is being  
mentioned as a possible candidate for Mayor  
on the Republican ticket.

A. A. Remington and Horace Remington,  
refiners, sailed last week on a trip to Eu-  
rope, and expect to be gone several weeks.

Among the imports at the port of Provi-  
dence last week were 14 packages of imita-  
tion precious stones from Bremen, as well  
as two packages of jewelry; one package of  
imitation precious stones from Havre and  
one of clock movements from Liverpool.

Among the buyers registered in town dur-  
ing the past week were: Miss H. Graf, New  
York; Sol. Prentke, Cleveland, O.; H.  
Pichel, New York; C. H. Peterson, St.  
Paul; B. Rothschild, Chicago; E. Cohn,  
New York; Carl Rosenberg, New York.

Plans for the jewelers' outing are going  
on rapidly, and the details are rapidly be-  
ing brought into shape. The annual event  
promises to be fully as successful as those  
in the past have been, the committee leaving  
no stone unturned if by loosing it they can  
aid to the enjoyment of the occasion.

Capt. E. Merle Bixby, who has charge of  
the silverware department at the Shepard  
store, was last week re-elected captain of  
the Machine Gun Battery of the State mil-  
itia. A handsome wine cooler of Flemish  
oak with sterling silver bands and orna-  
mentation was given him as a token of ap-  
preciation of the men for his services in  
their behalf.

K. C. Naylor, San Diego, Cal., will con-  
duct business hereafter under the firm style  
of the Naylor Gem Co.

**Cleveland.**

The store of H. H. Moses, at Jefferson,  
was destroyed by fire a few days ago, with  
a loss of \$2,500. The insurance is partial,  
it is said.

The store of Harry Goldberg, 248 Su-  
perior St., was robbed early Wednesday  
morning, and Mr. Goldberg says that  
about \$1,763 worth of goods were taken.  
The thieves entered through a transom.  
The loss falls upon the burglary insurance  
company with which Mr. Goldberg car-  
ried a policy.

Stanley Touzinsky, a jeweler at 1105  
Broadway, filed a petition in bankruptcy  
last week. The liabilities are \$3,022.36,  
while the stock is valued at \$1,000. In ad-  
dition there are debts due the jeweler  
amounting to \$1,122. The larger claims  
are as follows: The Bowler & Burdick  
Co., \$200; Wingate-Nusbaum Co., \$200;  
Sigler Bros. Co., \$110; C. P. Coyne, \$225;  
Calumet Watch Co., \$71; Charles Arms-  
heimer, \$122; Joseph Brown Co., \$107; J.  
Alberts, \$130; Dans & Co., \$50; J. F.  
Schaffer & Co., \$527; J. R. Wood & Son,  
\$500; Sabutz & Sons, \$130; Laundan  
Bros., \$40.

Through the manipulation of two clever  
crooks, Gottdiner & Wicht, 2084 W. 25th  
St., lost 28 watches Wednesday. The  
young men came into the store and one of  
them engaged the clerk's attention by an  
inquiry for eye glasses. He looked at a  
number of styles and kept the clerk so busy  
that he failed to keep the usual lookout.  
While this was going on the other man  
was sauntering about the store idly. Al-  
though several other persons were in the  
room, none of them saw him make a sus-  
picious move. The man that wanted the  
glasses finally decided that none of them  
suited him and walked out with his com-  
panion. It was not until several hours  
later that the loss was discovered. Good  
descriptions of the men were furnished the  
police department, but so far they have not  
been apprehended.

**Savannah, Ga.**

Geo. R. Youmans, Way Cross, Ga., is one  
of the applicants for a charter for the Way-  
cross Hotel Co.

R. M. Hull was appointed receiver for  
Sternberg & Co., in the Superior Court,  
at Savannah, on June 9. The appointment  
was made by agreement in the case of E. A.  
Cowan & Co. against the firm. The receiver  
gave bond in the sum of \$5,000, and is au-  
thorized to sell the stock on time or for  
cash. Alexander & Edwards are attorneys  
for Sternberg & Co. Geo. W. Owens rep-  
resents E. A. Cowan & Co.

**Market Price of Silver Bars.**

The following are the quotations of sil-  
ver bars in London and New York, as re-  
ported by Zimmerman & Forshay:

	New York.	London.
June 5.....	\$.66	30 1-2d.
" 6.....	.66 1/4	30 9-16d.
" 7.....	.64 5/8	29 7-8d.
" 8.....	.65	30d.
" 9.....	.65 1/4	30 1-16d.
" 11.....	.65	30d.

J. C. MacMaus, Aekley, Ia., removed re-  
cently to Sherburne, Minn.

**FROM MINES TO MARKET**

**BUY FROM THE CUTTERS**

**K  
U  
N  
N  
I  
T  
E**

**K  
U  
N  
N  
I  
T  
E**

**NEW.  
BEAUTIFUL.  
AMERICAN.**

We are Cutting these Stones  
in various sizes and shapes at  
moderate prices.

We cut and carry every Precious  
Stone but the Diamond.

**AMERICAN GEM AND PEARL CO.**

**14 & 16 CHURCH ST., NEW YORK**  
LONDON—16 Holborn Viaduct      PARIS—39 Rue de Chateaudun

**EDUARD VAN DAM  
DIAMOND CUTTER  
AMSTERDAM NEW YORK ANTWERP**

**Diamonds Set  
Without Cost**

Means a lot of money saved during the year. This you can do very easily if you have your settings done by a first-class setter. Your diamonds will improve in value more than three times the money you pay for setting them. At the same time your mountings improve greatly. Your customers are satisfied with all the orders you turn out. You can compete with all others who are slow in grasping the importance of these facts, by giving me all your settings. I am sure you will make no mistake as I will prove these facts.

I make a specialty of setting fine Platinum Mounting Watch Cases, Locketts and Gypsy Settings.

**RUDOLF BRETTNER**

65 Nassau Street      NEW YORK

MAIL ORDERS RECEIVE PROMPT ATTENTION

Established 1883      Telephone 2547 Cortly

35 Years Manufacturing  
**CHAINS**

**S. & B. Lederer Co**

11 Maiden Lane      Factory:      131 Wabash Ave  
New York      Providence, R. I.      Chicago

**Rockford Watches Speak for Themselves.**

London, E. C., Holborn Viaduct 17.  
G. MARGUS.

ESTABLISHED 1860.  
L. O. LEVISON.

Amsterdam, Tulpstraat  
ALEX. FELDENHEIMER.

**CALIFORNIA JEWELRY COMPANY**  
Importers of

**DIAMONDS and PRECIOUS STONES**

SAN FRANCISCO, Temporary Office, Oakland, Delger Building

YOUR MEMO. ORDERS ARE SOLICITED

NEW YORK, 41 Maiden Lane

**Attleboro.**

Waldron Evans, a Boston jewelry salesman, was last week wedded to Miss Annie Cordelia French, of Taunton.

Charles P. Keeler, of McRae & Keeler, admitted himself creditably Saturday in a competition shoot at Lexington, Mass.

Louis B. Jones, of C. A. Marsh & Co., returned from a trip through the west, and Alex W. Potter, salesman for J. M. Fisher Co., is also back from a long trip.

Announcement was made a few days ago of the coming wedding of Miss Rena M. Goff, daughter of Major and Mrs. William Goff, to Frank Clifton Rounseville, son of V. H. Rounseville, of C. A. Marsh & Co., of the younger generation of ambitious jewelers.

Good start has been made on the foundation of the new shop for the D. F. Briggs.

To accommodate the structure large changes are being made in the wire system, which supplies electric light and power to the jewelry factories in the group at the center of the town.

The manufacturing jewelers noted in last week's issue of THE CIRCULAR-WEEKLY the movement of the Chicago jobbers to organize and regain control of the trade. Several interviewed show no disposition to discuss the matter for publication until the movement develops further.

Charles M. Robbins, of the Chas. M. Robbins Co., was last week honored with election to office in the Ancient and Honorable Artillery Company of Boston. Mr. Robbins is having a new cottage erected at Greenwood Park, a new Summer resort, which adds to its growing popularity largely to his interest.

Renewed efforts have been lately made to organize the workers in the jewelry factories. Former President Herman Vollmer, of the Jewelry Workers' Union of America, made a vigorous but unsuccessful effort in the line two years ago, and the present movement is being done quietly, but with some effect already apparent. No union is being formed in this town. The men are joining the Providence union.

**North Attleboro.**

George L. Paine is home from a western tour.

Fredrick E. Sturdy has been elected a director of the Mt. Hope Cemetery Association.

The electric plant which J. F. Sturdy's Sons have been busy installing in their Robinsonville factory for the past few months was placed in commission early last week.

Geo. L. Paine, Charles H. Clark and Charles Peckham have returned from the west. H. H. Pierce returned Thursday from an extended trip in the interests of the J. H. Smith Co.

Services in memoriam to the late James Danielson Lincoln were held at the Universalist Church, Sunday. A sermon was preached by the pastor, Rev. Ralph E. Conner, describing the many good qualities of the deceased jeweler.

The many friends in this town of William Clark, of Clark & Coombs, Providence, were grieved this week to hear that he was about to undergo a serious operation,

which, because of his advanced age, is considered dangerous. Previous to the big Stephen Richardson fire Mr. Clark's concern was located in North Attleboro.

The funeral of David Coddling, one of the pioneer jewelers of the town, was held on Wednesday afternoon, and the services were attended by a large circle of friends, which included a large number of manufacturers. The service was conducted by Rev. George E. Osgood, and burial was in the Mt. Hope Cemetery. The floral tributes were profuse and beautiful.

William H. Riley was seriously injured in an accident on Tuesday afternoon of last week. He was climbing into his carriage and the horse started up prematurely. Mr. Riley was caught in an awkward position and was obliged to cling to the wagon to avoid being run over. He was dragged 75 feet before the horse was stopped. Mr. Riley was badly shaken up and his left ankle was hurt.

**Buffalo, N. Y.**

Frank Johnson, diamond setter for Fred Dorn, 87 E. Genesee St., returned last Saturday from New York.

S. L. Levy, 483 Main St., has established an optical department, with L. Gottlieb in charge. Mr. Gottlieb came here from Philadelphia a few years ago.

Barthold Block, of Block Bros., returned last Saturday after a long absence on the road for his house, at 520 Main St. He reports good business in the eastern States.

An erroneous report that a man had robbed T. C. Lanke, Main and Eagle Sts., of his costliest watch last week was in circulation here. The daily newspapers ran the story without investigation. The report was absolutely untrue.

J. C. Sipe, Indianapolis, Ind., came to Buffalo a few days ago direct from New Mexico to visit his brother, A. E. Sipe, diamond importer, 8 Mooney building. A. E. Sipe is going to Indianapolis shortly to repay the visit of his brother.

Mrs. Paul Foerster, wife of the Seneca St. jeweler, whose health became greatly impaired following the robbery of \$3,000 worth of diamonds from her husband's store, three months ago, is rapidly recovering in the country, where she is sojourning.

Beginning July 1, and continuing through August, the jewelers of Genesee St. will close their stores at 6 o'clock every night in the week except on Monday and Saturday. This action is the result of a petition liberally signed. Jewelers of other sections of the city will probably take similar action.

Paul Friedlander, of R. L. & M. Friedlander, New York, was here several days of last week arranging for hotel accommodations for the New York delegation, 400 strong, who are attending the annual national convention of the Travelers' Protective Association. Mr. Friedlander secured handsome quarters at the Lafayette Hotel.

Fred A. Riefler, 420 Michigan St., has completed his 33 years in business here at the "same old stand." Mr. Riefler began as an optician in a small frame building. Later he added a stock of jewelry, and at

that time the rich people of Buffalo lived in the vicinity of his establishment. "I made money rapidly in those days," he said to a CIRCULAR-WEEKLY reporter, "and was soon able to abandon the frame building and erect the block which I now occupy."

**Toledo, O**

Samuel Leshar, Bucyrus, O., is adding the art of architecture to his regular profession. He has completed plans for a residence for a Mrs. Holmes, of that city, and is at present engaged on a set of similar drawings for a residence he will build for himself.

John Prochaska, 109 Summit St., has purchased the property at 114 Summit St. from Miss Marie Hoag, New York, the purchase price being \$20,000. The property is leased by the Merchants' Truck & Delivery Co., and while the new owner purchased it as an investment, it is understood that he did it to be on the safe side, as the property he now occupies was sold a few days ago. Mr. Prochaska owns property in this city valued at over \$50,000.

Toledo is to have an entire modern business building devoted to the jewelry business, a thing which the city has never before enjoyed. J. J. Freeman & Co., Summit St., near Madison Ave., have just closed a deal whereby S. C. and C. L. Reynolds will erect for them a four-story building which is to be devoted entirely to jewelry business. The new site is located adjoining his present one and is at present occupied by a shoe store. This is to be torn away to make room for the new building, beginning July 15. Mr. Freeman, head of the firm, states that the very latest ideas are to be incorporated in finishing the new store, and from the plans which he has already made public, it will be one of the finest in the middle west. Entirely new mahogany, plate glass and marble wall cases and show cases are to be used in the first floor, which will be done throughout in marble. The first floor will be used for general jewelry purposes. The second will be given over to lamps, cut glass, pottery and china. The third floor will be used as a store room, while the fourth floor will be devoted to manufacturing and repairing purposes. Mr. Freeman made several unsuccessful efforts previously to secure a new location.

**Denver**

P. F. O'Neill, who moved recently to the Glenam building, on 15th St., has finished the fitting up of his new store, which is replete with every facility for conducting the optical business.

Henry Bohm, of the Bohm-Allen Jewelry Co., was the victim of a runaway accident last week, which cost him the loss of a handsome carriage and injury to a valuable horse. The accident was caused by the carelessness of Jim Lee, a Chinese laundryman, who left a heavy laundry wagon, to which was hitched a fast horse, in the alley between Champa and Stout Sts. The horse ran away, and, besides endangering the lives of many pedestrians, wrecked the carriage of Mr. Bohm, which was standing in front of his store, at 16th and Arapahoe Sts.

# BLACKINTON

“Think it over,  
Mr. Retailer”

Buy Blackinton vest and Dickens chains and save the aluminum coupon tags found on the swivels. Send these tags to our factory and we will redeem them in

Globe Filled W. & S. B. ★  $\frac{1}{8}$  chains, as follows:

**40 TAGS, One Globe Chain**  
**75 TAGS, Two Globe Chains**  
**100 TAGS, Three Globe Chains**

Don't forget that we give away next January a Touring Car, a Runabout, a Motorcycle and a Watch Lathe. These prizes are all for Retail Jewelers. **Think it over**, Mr. Retailer, and buy Blackinton Chains, the standard by which all others have been judged for forty years.

“THERE'S MONEY IN IT”

**W. & S. Blackinton Co.**

New York, 14 Maiden Lane.  
 Factory, North Attleboro, Mass.



W. & S. B. ★



**Boston.**

Samuel D. McChesney, of the William B. Kerr Co., was a visitor to the Boston fair during the week.

Arthur C. Poor, who went to San Francisco several months ago to accept a position with Shreve & Co., has returned to Boston since the disaster.

C. Zinn, a leading jeweler, also a prominent financier and member of the government, Hastings, Nebr., is in Boston on a brief business and pleasure trip.

Ed Gowdy, recently of San Francisco, who for a number of years previously with Shreve, Crump & Low Co., has returned to this city, entering the repair department of the same concern.

M. Shepherd, of Shepherd & Bennett, Malden, has returned from a European tour, on which he was accompanied by his wife and daughter. They visited the principal Mediterranean cities abroad.

The New England Watchmakers' Club has been invited by the Waltham Watch Co. to a banquet at the American House, Boston, on the evening of June 19. The reception hour is 7 o'clock, and the dinner will be served at 7:30 o'clock.

The T. F. Tuttle Silver Co. recently moved from 21 Bromfield St. to 387 Washington St., where more spacious quarters have been obtained. A showroom has been added and the company will manufacture silverware for stock, selling to the trade.

Edward L. Wheeler, now with the Bohm & Bolz Co., San Francisco, but a score of years ago identified with the Boston trade, is again with the house of Bigelow, Kennerly & Co., has been in town during the week calling on former acquaintances among the jewelers.

Royal Robbins, of the Waltham Watch Co., accompanied by his family, sailed last week from Boston on a trip to Europe. J. C. Barlow, of the Waltham Watch Co.'s factory, formerly at the Montreal selling agency, has returned from a trip to the latter city.

A consignment of several hundred damaged watches that went through the San Francisco fire in jewelers' vaults has been received at the factory of the Waltham Watch Co. for renovation. They will be thoroughly overhauled, and most of them will be put in good condition again, it is understood.

A. Simonds has been chosen a director of the Ripley-Howland Mfg. Co., succeeding the late president, J. C. Donnell; H. B. Burnham, treasurer of the company, becomes president as well as treasurer. Mr. Simonds is the superintendent of the manufactory, and has been a stockholder for some time.

James S. Blake, of Kettell & Blake, is in Chicago attending the imperial council of the Mystic Shrine. Mr. Blake, who is one of the 33d degree Masons of Boston, is exceedingly popular with the fraternity as well as with his fellow-members of the jewelry trade, is a past illustrious officer of the Shrine.

Visitors in Boston during the week included: Sanford K. Gurney, Brockton; H. V. B. Locke, Amesbury; Mr. Cham-

berlain of B. M. Chamberlain & Son, Salem; S. G. Beers, Taunton; H. O. Barthelmes, Marlboro; Mrs. L. P. Davis, Falmouth; C. W. Clough, Pawtucket, R. I.; George E. Camm, Johnstown, N. Y.; A. Gamache, Brunswick, Me.

The quarters that are to be occupied by Maynard & Potter, in the new building at the corner of Boylston and Berkeley Sts. are approaching completion. Mr. Maynard was formerly of the firm of A. Stowell & Co. It is expected that the new concern will be established by the close of the Summer vacation period, and ready for business in the location named.

The Summer outing of the Boston Jewelers' Club was held at the clubhouse of the Point Shirley Club, of which some of the jewelers are members. The party went by train yesterday afternoon, June 12, to Point Shirley, where an excellent shore dinner was provided, and enjoyed an informal gathering with the clubhouse accompaniments of bowling and other shore recreations.

Thomas W. Paine, head clerk and inside salesman during the past four years for C. W. Sweetland, of the Jewelers' building died at his home in Cambridge, Thursday night last, after a long illness from liver trouble and other complications. He was about 65 years of age. Mr. Paine's final sickness, necessitating his giving up his daily employment at the office, was of a fortnight's duration. He was a Grand Army veteran, and a member of several fraternal orders. He leaves a widow and two daughters.

**Rochester.**

Morris Meyers is selling at auction 8,000 pieces of cut glass. The sales are well attended.

The following opticians have signed the petition in favor of closing their stores on Saturday afternoon during July and August: E. E. Bausch & Son, the Genesee Optical Co., Rudolph Schmidt & Co., Empire Optical Co., Clark & Bowen.

E. J. Scheer & Co. made the loving cup which the Eighth Separate Company of this city put up as a prize to be competed for by the school boys' companies who took part in the Decoration Day parade. The cup was awarded to the best drilled company.

The business started by Solonsky Bros. a few months ago on Clinton St. was recently changed in name to "The Model" jewelry store. Not only has the proprietor changed the name of the store, but, as recently noted, has also changed his name from Solonsky to Sloan.

W. H. Glenny & Co. are now showing a light line of jewelry in the basement of the establishment. This firm has always handled silverware, clocks and such lines, but it is only recently that the firm put in a line of necklaces, brooches and other jewelry appealing to women.

The following jewelers have signed the petition in favor of closing the stores at 1 o'clock on Saturday afternoon during July and August: The L. Sunderlin Co., S. D. Burritt, J. R. White & Co., J. J. Ernisse, E. J. Scheer & Co., Humburch Bros., C. F. Vanderpool, W. H. Glenny & Co., Klee &

Kroh, Henry Oemisch Co., E. S. Ettenheimer & Co., Morris Rosenbloom & Co., C. F. Wolters, George Andrus, Philip Present.

The wires that operated an electric fan in the jewelry store of Joseph Klem, 82 Main St., W., became short circuited one day last week and set fire to woodwork of the fan. Employees of the store were unable to put out the flames, and the fire department was summoned by telephone. The firemen quickly arrived on the scene and extinguished the blaze. The fan was totally ruined and the damage was in the neighborhood of \$50.

**Lancaster, Pa.**

John S. Reitschy, a watchmaker for T. Wilson Dubbs, is at present on the sick list.

Beginning the first week in July the jewelers of Lancaster will observe a Friday half-holiday.

J. M. Kreider, Denver, Pa., has entered the Ezra F. Bowman Technical School as a student in engraving.

Ralph Herr, late with Louis Weber & Son, has gone to Morgantown, Pa., to take a position as watchmaker.

Percy J. Moench, a retired jeweler, who came from New York some years ago, died last Friday near Bainbridge.

Beginning Saturday, the employes of the Hamilton Watch Co.'s factory will have a Saturday half-holiday during the Summer.

Harry Lichtenstein, formerly a jeweler of Lebanon, Pa., has gone to Williamsport, Pa., where he expects to engage again in the trade.

Walter Landis, foreman of the H. S. Meiskey Co.'s factory, had his bicycle stolen from in front of the establishment last week. The family of F. A. Huber, a traveling salesman for this company, has gone to Pequea for the Summer.

Charles L. Evans, of this city, who learned his trade at the Ezra F. Bowman Technical School, has taken a position as watchmaker with A. C. Smith, general watch inspector of all railroads in Mexico. He will be located in Mexico City.

Among the out-of-town jewelers here recently were Jacob Fisher, Elizabethtown; S. H. Miller, Mt. Joy; David B. Plymier, Groffs Store; H. L. Oberlin, of H. L. Oberlin & Bro., Columbia; J. H. Sensenig, New Holland; Samuel Jenkins, Harrisburg; H. F. Andrews, Strasburg.

Edwin L. Snyder, a well-known watchmaker and jeweler, died suddenly on June 8, after a brief illness of gastric indigestion. Deceased, who was in his 46th year, was born in Lancaster, and for many years worked at the big watch factories of the country. For the past 13 years he was with W. W. Appel, but it was his intention soon to open a jewelry store himself in Lancaster.

Phocion P. Thrasher, Mobile, Ala., has gone into bankruptcy.

H. S. Hewitt & Co., Brockton, Mass., have taken additional floor space for their main store on the principal street of the city, and have added an attractive basement department in which a line of clocks, cut glass and similar horological and art goods will be carried.

# GORHAM SILVER

"Not Strength, but Art obtains the prize."—Pope.

¶ The average Committee entrusted with the task of choosing the Trophies or Prizes bestowed in summer sporting and athletic contests is composed of men of taste and discrimination, who insist that their choice shall possess not only intrinsic but also a marked artistic value.

¶ Thus, for the reason that art appeals to them and obtains the prize of their elective preference, each succeeding summer season witnesses the offering of an increasing number of Gorham Cups and Vases as prizes in connection with Yachting, Rowing, Golf, Lawn Tennis and Athletic events in general.

¶ The Gorham Mfg. Co., therefore, take particular pleasure in directing the attention of the Jewelry Trade to their special and other pieces designed with especial reference to the above purpose.

## GORHAM M'F'G CO.



CHICAGO,  
137 Wabash Ave.

Silversmiths and Goldsmiths

Fifth Avenue and 36th Street, New York.

BRANCHES:

NEW YORK,  
23 Maiden Lane.

SAN FRANCISCO,  
120 Sutter St.

LONDON,  
Ely Place.



WORKS: Providence and New York.



**THE JEWELERS' CIRCULAR**  
 THE HOROLOGICAL REVIEW.  
 THE JEWELERS' WEEKLY.  
 THE JEWELERS' REVIEW

PUBLISHED EVERY WEDNESDAY BY  
**THE JEWELERS' CIRCULAR PUB'G CO.,**  
 1 JOHN ST. COR. BROADWAY, NEW YORK.  
 TELEPHONE: CABLE ADDRESS:  
 CORTLANDT. JEWELAR NEW YORK

V. L. LII. JUNE 13, 1906. No. 19.

Subscription in U. S., Canada and Mexico, \$2.00  
 For Countries in Postal Union, \$5.00  
 Single Copies, . . . . .10

Remittances in money or by check or money order. Remittances in money are at sender's risk.

Changes of standing advertisements may be received one week in advance; new matter can be received up to Monday.

Attention paid to communications unless accompanied by full name and address of the writer. It is asked not necessarily for publication, but as evidence of good faith.

**Index to Special Articles.**

	Page.
Business Suspended on Tiffany & Co.'s Superintendent After He Pleads Guilty to Larceny	33
Resolutions for Convention of American Association of Opticians	33
Religious Clocks, etc., Exported from New York	33
Restler Opticians Cause Prosecution of Bogus Eye Specialist	33
Bronx Stakes Trophy for 1906. Illustrated on front cover; text on page	34
Death of the Late Reuben Harris	34
Resolutions to Organize Pittsburg Retail Jewelers	35
New Members Elected by Jewelers Security Alliance	35
Robbers Loot Atlantic City Jewelry Store	35
Deaths of Jewelry, etc., at New York	35
Death of Bertram J. Harriott	35
Sa Rosa's Great Loss	37
Death of Robert P. Cullen	37
L. Honors to the Late Joseph Wineburgh	39
Yellow Paint on Neighbor's Building Hurts Business of Jeweler	39
Complaint Dismissed in First Prosecution Under New York Gold Law	39
Neara Silver Co.'s Manager Held for Trial	39
Rail Jewelers of South Dakota Organize	41
Bros. Make an Assignment	41
Final Decision on Hat Pins, etc.	41
Pins Reported Scarce in Europe	41
Morris and Joseph Klein Plead Guilty of Larceny	43
Death of Emil L. Lembke	43
Death of Henry F. Vogel	43
Death of the Late Frank Allsopp	43
Marking of Foreign Plate in England—New Marks for Gold and Silver	45
Bankruptcy Petition Filed Against Grosse & Kappeler	46
Jewelry Trade's Gold and Silver Stamping Law Goes to the President	47
Boston Jeweler's Conviction Reversed on Appeal	47
Plans of Departments of Gorham Mfg. Co. Make Merry	47
Jury Convicts Woman Who Swallowed Diamond	57
Editorial Talks on Law—(Continued)	73
Post Department	75
Scientific and Modern Time Measuring Devices. By C. T. Higginbotham	81
Time Market for Watches in Asia	87
Resting Clock Factory at Sanborton, N. H.	87
Microscopy	91
Hypermetropia Headache Dependent Upon Age	92
Optician as an Advertiser	93
The Fireproof Safe Protects—Experiences of San Francisco Jewelers	94
Advertisements Worth Reviving	94
What Made the Bowery the Old Retail Jewelry Center of New York	95
Actively Furnished Store in Mobile, Ala.	95
Workshop Notes	96
School of Art at Birmingham	99
Some Facts About Crown Derby	99
European Pawnshops—(Continued)	101

IN the news from Buffalo about the wholesale grocers' organization, it was stated last week that this body proposes to "down" the catalogue houses and abolish the trade evils which have grown out of this kind of business. How the Association was to conduct the fight was not disclosed, but should it succeed wholly or partially there is little doubt that in its work it would have the co-operation of many retail jewelers and members of other trades.

**Novel Point May Come Up for Settlement.**

ACCORDING to dispatches received last week a suit may be brought by a North Adams (Mass.) jeweler against the owners of the building opposite his store, which, if it comes before the court, will bring up a novel point of law as to the right of a man to paint his building any color that he pleases, when such color interferes with the business of a neighbor. According to the published accounts the jeweler in this case complains that the building across the street from him has been painted yellow, and that the reflection of the light therefrom affects the appearance of everything in his store, giving to the whitest of diamonds a slightly yellow tinge which materially hurts their value and sale. It will be readily understood by members of the trade how it can be almost impossible in selling gems under reflected yellow light to persuade customers that the "off color" is due to a building across the street and that the stones would be all right when the gems are taken away. The predicament of the jeweler therefore will be appreciated thoroughly by his brother members of the craft, who will wish him every success should he bring suit to abate what is to him a serious nuisance and one which deeply affects his business.

This is not the first time that such a question has arisen in the trade. Some years ago an old iron building at 5 and 7 Maiden Lane, New York, was painted a bright yellow, and immediately diamond dealers, jewelers and silverware firms on the south side of New York's jewelry thoroughfare discovered that their stocks had a decidedly yellow tinge. Legal proceedings were threatened at one time, but no suit was ever commenced, as a compromise was reached by which the building was repainted a neutral color, the jewelers paying a certain proportion of the cost.

While a suit such as contemplated by the North Adams jeweler may appear ridiculous on its face to a layman, and be considered a fit subject for the writer of humorous paragraphs, there is a serious question involved that can only be appreciated to its full extent by diamond dealers or jewelers. A settlement of the points at issue by the courts would interest the entire trade.

**Jewelry Failures During May.**

COMMERCIAL failures during May are reported to have numbered 899, with defaulted indebtedness of about \$13,000,000, as against 860 failures in the corresponding month of 1905, with liabilities of \$8,900,000. Deducting from the liabilities the indebtedness of a single insurance com-

pany, the figures remain about the same as a year ago. In the manufacturing lines there were but 179 failures, as against 209 in May last year, the liabilities in both being slightly over \$4,000,000; among trading firms there were 676 failures, as against 631 last year, with liabilities of \$4,800,000 and \$1,200,000, respectively.

According to a table showing failures by branches of business, compiled for *Dun's Review*, there were 19 failures among the jewelry and clock dealers last month, with liabilities which aggregated \$311,400, or an average of \$16,389, as against 16 failures in May last year, with liabilities of \$142,621, a marked improvement on the average. How the figures compare with previous years is shown by the same table, which gives 28 failures in May, 1904, with liabilities of \$143,135; 17 failures in May, 1903, with liabilities of \$214,701, and 16 failures in 1902, with liabilities of \$264,307.

**Exhibition of Appliances to Safeguard Jewelers.**

THE *Moniteur de la Bijouterie et de L'Horlogerie*, of Paris, has organized an exhibition of devices and methods which relate to the protection of jewelry shops against burglary, not only those which are meant to protect the store and safe, but appliances for protecting the windows and show cases as well. This exhibition is open to inventors of all nations, and proposals will be received and details furnished up to the first of July, after which the device will be on view in the rooms of the "Chambre Syndicale de la Bijouterie Joaillerie Orfevrie, etc.," in Paris. There is no doubt that such an exhibition will be of deep benefit to the retail jewelry trade throughout the world, as it will not only bring to notice all those inventions and devices for the jewelers' protection now extant, but will also stir inventors to new work in this line. Our Parisian contemporary is entitled to the praise and gratitude of the jewelry trade for its work in inaugurating such an exhibition.

**Jury Convicts Woman Who Swallowed Diamond Stolen from Omaha Jeweler.**

OMAHA, Nebr., June 10.—After deliberating for more than 24 hours the jury today decided that Mae Thomas was guilty of "eating a diamond," but asked the court to be lenient with her because of her youth. Sentence will be passed to-morrow.

Mae Thomas is the girl who stole a diamond worth \$350 a month ago from T. L. Combs & Co., and in an attempt to evade discovery placed the stone in her mouth and swallowed it. The diamond was located by X-rays and every effort short of an operation was tried to recover it, but unsuccessfully.

The trial consumed almost a week and drew big crowds. The girl confessed early in the game, but withdrew this and pleaded not guilty at the trial. She acknowledged placing the gem in her mouth for the purpose of testing it, she said, but left it to the jury to say what became of the stone after that. She will probably get a three years' sentence.

Hesse & Sturges, Boise City, Idaho, have dissolved partnership, C. W. Hesse carrying on the business alone.

# JUNE WEDDINGS

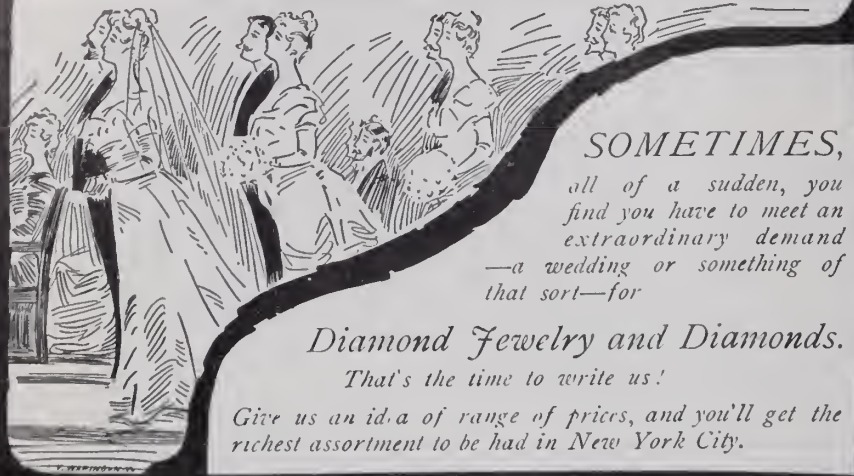

SOMETIMES,  
all of a sudden, you  
find you have to meet an  
extraordinary demand  
—a wedding or something of  
that sort—for

*Diamond Jewelry and Diamonds.*

*That's the time to write us!*

*Give us an idea of range of prices, and you'll get the  
richest assortment to be had in New York City.*

## CROSS & BEGUELIN

*Importers and Cutters of Diamonds and Precious Stones*

43 Rue de Meslay, PARIS Telephone, 2188 Cortlandt 17 Maiden Lane, NEW YORK

### ARCH CROWN MOUNTINGS IMPROVE DIAMONDS

*Why not set  
your diamonds  
in the mounting  
that displays  
them best?*

*Send for samples.*

**Arch Crown Mfg. Co** 26 Camp Street  
Newark, N. J.

## Last Week's New York Arrival

THE CIRCULAR-WEEKLY each day posts its office a bulletin of the latest buyers visit New York, which every member of the trade cordially invited to copy.

- ALBANY, N. Y., H. Gips, Herald Sq.  
AMERICUS, GA., Mr. Daniels (Daniels & Brannen), Gorham Mfg. Co., 21 Maiden Lane. Mr. Brannen (Daniels & Brannen), Gort Mfg. Co., 21 Maiden Lane.  
BALTIMORE, MD., M. Gutman (N. Gutman Co.), Herald Sq.  
BOSTON, MASS., J. B. Humphrey (J. B. Humphrey Co.), St. Denis. T. Stewart (Shepard, Norwell Co.), Pri George.  
BUFFALO, N. Y., J. Ansteth, Victoria. T. C. Bunch (Wm. Hengerer Co.), Imperi  
CATSKILL, N. Y., J. A. Hill, Park Ave.  
CHICAGO, A. Binswanger (Siegel, Cooper & C Woodstock.  
CINCINNATI, O., C. J. Bene, Astor House. Miss J. Levi (The Fair), St. Denis.  
COLUMBUS, O., M. L. Harrington (Harrington & Nonnemacher), Grand.  
LANCASTER, PA., H. E. Landes, Grand.  
LAWRENCE, MASS., B. Abel (Disarably Abel), 1525 Madison Ave.  
NEW BEDFORD, MASS., L. A. Littlefield (L Littlefield Silver Co.), Grand.  
NEW HAVEN, CONN., Miss C. Pattee (How Stetson Co.), 75 Spring St.  
NEW ORLEANS, LA., L. Claudel (E. & Claudel), Ashland.  
PHILADELPHIA, PA., I. Bedichimer (I. Bedichimer & Co.), Imperial.  
PITTSBURG, PA., C. Meister (Pittsburg Goods Co.), Astor House. C. M. Igel (Kaufman Bros.), 648 Broadwa  
ROCHESTER, N. Y., L. E. Kirstein (E. stein Sons Co.), Imperial.  
SAN FRANCISCO, CAL., A. Feldenheimer (California Jewelry Co.), Wellington.  
ST. LOUIS, MO., M. M. Weil (Famous), 4 Wellington Pl.  
SPRINGFIELD, MASS., G. W. Chatterton. I man.  
SPRINGFIELD, O., C. R. Fried, Imperial.  
SYRACUSE, N. Y., S. H. Pond, Victoria.  
TROY, N. Y., E. A. Frear (W. H. Frear & C Imperial.  
UTICA, N. Y., Frank Morath (J. B. Well & Co.), Albert.  
WASHINGTON, D. C., Mrs. J. C. Nourse (Ward & Lothrop), Holland.

The Brazilian Diamond & Gold Digg Co., Oil City, Pa., has been incorporated under the laws of that State to prospect for minerals and mine Brazilian diamonds, with a capital of \$100,000.

Last Friday evening the members of the Buffalo (N. Y.) Optical Society made a trip to Niagara Falls in a chartered trolley car. They were the guests of C. F. Cushing at the Falls, and were banqueted by him at "The Oaks" in a most elaborate fashion. It was the last meeting of the season, the next session taking place at the Lafayette Hotel, Buffalo, in September. Frank I. Tholomew, of Buffalo, was elected a member. The names of Willis E. Cushing, Niagara Falls; Philo T. Martin, Buffalo, and Alexander Naisel, Buffalo, were presented for membership. A committee consisting of Roger Williams, Herbert Wickins and Joseph Schmidt were appointed to work up a good Buffalo crowd to attend the convention of the American Association of Opticians, to be held in Rochester, July 30.

## New York Notes.

Lachman, of the Acme Plating Works, John St., has returned from his western

judgment for \$120 against Frank Orr and in favor of the Gorham Co. was filed July 4.

Henry Fera, of Fera & Kadison, returned Sunday on the *America* after a three months' trip in Europe.

In a fire at 194 Grand St. last Thursday slight damage was caused in the jewelry stock of Joseph Vecchio.

Creditors of Bernhard Cohen, Trenton, N. J., held a meeting yesterday in the rooms of the Jewelers Board of Trade.

Sympathy of friends is extended to the members of Goodman Bros., 27 Maiden Lane, whose mother died Monday.

Wm. B. Rosenback, with Wm. I. Rosenfeld, 1 Maiden Lane, returned from Europe yesterday on the *Kaiser Wilhelm II.*

Judgment for \$43 was entered last Thursday in favor of Wm. Cardam & S.

The directors of the International Silver Co. have declared the regular quarterly dividend of 1 per cent. on the preferred stock, payable July 2.

Venanzo Mazza, jeweler and broker, 141 V Houston St., received a discharge in bankruptcy in the U. S. District Court, Monday. His liabilities were \$9,290.

Both members of Daniels & Brannen, Americus, Ga., are in the city, making headquarters at the Gorham Mfg. Co.'s downtown store, 21 Maiden Lane.

Max Seldowitz, who had been with Sophie Schwob, last week bought out the mail jewelry business of the Weinreb Co., L. I., and will conduct it under his own name.

Among those sailing for Europe yesterday on the *Kaiser Wilhelm der Grosse* were Walter N. Walker, of Hodenpyl & Walker, James P. Harper and Mark Van Wezel, of L. Van Wezel, with his wife and son.

R. Brettner, diamond setter at 65 Nassau St. has moved from the ninth to the 10th floor in the same building, where he has more spacious quarters and is in a much better position to take care of his trade.

Louis Demmert, of the Gorham Mfg. Co., read a paper on "The Commercial Automobile in Practice" at the convention which the Team Owners' Association of America have been holding in the Hotel Cadillac during the last two days.

Eduard Van Dam sailed yesterday on the *Kaiser Wilhelm der Grosse*, intending to remain in Europe until September visiting jewelry factories in Antwerp and Amsterdam.

George De Vries, of the same house, returned yesterday on the *Kaiser Wilhelm II.*

D. Atlas, of Atlas & Fisher, Philadelphia, Pa., and family, were in New York several days last week. Saturday they sailed on the *Kroonland*, intending to pass six weeks in Antwerp, Amsterdam and Paris. Mr. Atlas expects to return in the latter part of July.

The Royal Jewelry Co. was incorporated last week with a capital of \$2,500 by Herbert Gray, 2973 Third Ave., Lucie Gray, at the same number, and Carolyn R. Spies, 11 E. 138th St. The new company will

take over the business now conducted at the same number by Mr. Gray as manager.

W. D. Burd and other pearl merchants from the west have been calling on the trade in New York during the past week. They agree that the yield of gems in the Wabash and other rivers thus far this season has been disappointing, but better results are expected a little when the waters go down.

George F. Miner, Albert E. H. Ovitt and Frank H. Edmunds, all of New York, are named as the incorporators of the Newman Clock Co., which, last Saturday, filed a certificate of incorporation at Albany. The company is authorized to manufacture clocks and to issue capital stock to the amount of \$100,000.

Isadore Brooks, 69 Broadway, Brooklyn, reported to the police of the Bedford Ave. station, Monday morning, that on Saturday night, after he closed his shop, thieves entered and got away with jewelry valued at \$300. He said the thieves entered from the rear. Brooks was robbed of several diamond rings two months ago. They were valued at \$100.

Forty years ago to-day Alfred E. La Vigne began his employment with the house now known as Mathey Bros., Mathez & Co., and the relation has continued, through the several changes in the firm style until now. For the last 30 years he has traveled for his house. This is a record, equaled by few, of which he may justly be proud.

George L. Barkentin, former war correspondent of the *London Illustrated News*, who died at Camden, O., Thursday night, was formerly connected with the jewelry trade. He was 65 years old, and as an artist received the gold medal award from the London Royal Academy for his sculptural design "Remorse." For many years after the war he served as a designer for a New York jewelry house.

This evening at 8 o'clock in the optical parlors of A. Martin, 17 W. 28th St., the Optical Society of the City of New York will hold its regular meeting. As there will be no sessions in July and August the meeting is regarded as of special importance and all the members are urged by the recording secretary to be present. They are reminded that the two year optometrical course is now well under way, and that those who are careless in attending sessions will not obtain the same advantage as those who pursue the course with diligence.

Charged with fraudulently misrepresenting on a sale, two watch charms, a man, giving the name of Simon Abrahams, 63 years old, of 220 E. 104th st., New York, was arrested last week at Flushing, L. I., on complaint of Charles Lioci, a restaurateur. The complainant said that when he bought the charms they were represented as being of 14 karat gold and afterwards the articles were tested by George Trotman, a jeweler of 95 Amity St., Flushing, who reported that the material was not gold. Abrahams was held for trial in \$200 bail.

One of the most attractive displays at the annual exhibition of art work conducted in the last week of May at the Pratt Institute, Brooklyn, was the work of the classes of jewelry and metal chasing. Many

beautiful and varied designs of exquisite workmanship were shown. The collection comprised necklaces of original designs with jewel settings; also bracelets, rings, brooches, watch charms and scarf pins. In the metal chasing and art metal department were shown bowls, plates, trays, vases, lamps, lamp shades and other articles fashioned from copper, brass and composite metals.

F. W. Blum, who had a small repair shop at Sixth Ave. and 26th St., and who lived at 224 E. 85th St., has been sought for some time by those who desire to serve papers in proceedings begun by Herman G. Jansen, a jeweler at 277 Eighth Ave. Mr. Jansen says that on May 2 Blum got two diamonds weighing 1 1/4 carats, and worth \$100, on memorandum. After Blum had possession of the stones for five days Mr. Jansen tried to find him for the purpose of demanding their return, but has been unable to learn of his whereabouts. It was said in the building where Mr. Blum had his shop that he had given up his quarters there and had gone away. No information was to be obtained at his home.

A petition in involuntary bankruptcy was filed Monday against Bernard Steinfeld, 504 Sixth Ave., New York, who sold jewelry on the road, and whose creditors recently held a meeting, as related in last week's issue. The petition was filed in behalf of the following creditors, the amount of their claims being given: Frank Walker, \$2,134; Isaac Levenson, \$385, and R. L. & M. Friedlander, \$756. All of these claims are evidenced by promissory notes and are not secured. The petitioners set forth that Mr. Steinfeld, at the creditors' meeting, admitted in writing his inability to pay his debts. Hastings & Gleason, attorneys for the Jewelers Board of Trade, represent the petitioners. Mr. Steinfeld at the creditors' meeting said that his insolvency was caused by the loss of jewelry valued at \$4,000, which was stolen from him in New Haven. He offered his creditors at that time a settlement of 30 per cent., but those present at the meeting did not seem inclined to accept. The result is the filing of the bankruptcy petition. His total liabilities are supposed to be about \$7,000. The indebtedness represented by the creditors at the meeting was \$4,600.

The Alexander Optical Co., Cleveland, O., which established a branch store at 252 Main St., Buffalo, N. Y., about three months ago, was the defendant in a local court recently in a suit for non-payment of rent. A judgment was given for \$327, in favor of W. T. Conners, owner of the store the firm occupies. The judgment had not been satisfied Saturday, and ejectment proceedings were expected. Louis F. Friedman, an assistant in the Detroit branch, came to Buffalo two weeks ago as manager, but resigned soon afterward. Dr. Koster, manager, resigned three weeks ago. Mr. Friedman says the firm sent him here to "settle up the affairs." His story is: "They gave me no money with which to 'settle up' and they sent me no funds when I telegraphed for them. I have been unable to get them to answer me either by long distance 'phone or by wire. It is all a mystery to me, so much so that I have sent in my resignation."

IN THE HEART OF THE JEWELRY DISTRICT.

**Guardian Trust Company,**

170 BROADWAY, COR. MAIDEN LANE, NEW YORK.

**Capital and Surplus - Over \$1,000,000**

Equitable rates of interest allowed on surplus funds.

Collection of out-of-town items made on reciprocal basis.

FRANK W. WOOLWORTH, President.  
 GEORGE W. FAIRCHILD, Vice-President.  
 CHARLES L. ROBINSON, Vice-President.

LATHROP C. HAYNES, Secretary.  
 ALFRED M. BARRETT, Asst. Sec'y.

Prominent Jewelers }  
 Among our Directors } LUDWIG NISSEN.  
 A. K. SLOAN.  
 LEOPOLD STERN.

**THE ORIENTAL BANK.**

ESTABLISHED 1853.

**182 and 184 Broadway, <sup>Corner</sup> JOHN STREET, NEW YORK.****Capital, - - - \$750,000.00.****Surplus and Profits, 1,100,000.00.****ACCOUNTS FROM THE JEWELRY TRADE ARE SOLICITED.**

R. W. JONES, Jr., President.  
 NELSON G. AYRES, First Vice-President.  
 GEO. W. ADAMS, Cashier

LUDWIG NISSEN,  
 ERSKINE HEWITT, } Vice-Presidents.  
 CHARLES J. DAY,

R. B. ESTERBROOK, Assistant Cashier.

**The Market and Fulton National Bank of New York.**

ORGANIZED 1852

81-83 FULTON STREET.

**Capital, \$1,000,000.****Surplus, \$1,335,000.**

ALEXANDER GILBERT, President.  
 R. A. PARKER - - Vice-President.  
 T. J. STEVENS, - - - Cashier.  
 JOHN H. CARR, - Asst. Cashier.

**Invites the Accounts of Jewelers.****Will extend every facility that good banking will justify.****SAFE DEPOSIT VAULTS.****The Chatham National Bank**

Broadway and John Street, New York

H. P. DOREMUS, Cashier

GEORGE M. HARD, President

W. H. STRAWN, Ass't Cashier

**THE STATE BANK**

376-378 GRAND STREET, NEW YORK

**Capital and Earned Surplus, over \$1,100,000. Deposits over Fourteen Millions****Offers a favorable market for short and long time jewelry and diamond paper**

# *The Mercantile National Bank of the City of New York*

*Cordially invites Accounts  
from Good Merchants  
in the Jewelry Trade.*

**CONVENIENT LOCATION,  
AMPLE CAPITAL,  
LARGE SURPLUS,  
LONG EXPERIENCE.**

*FREDERICK B. SCHENCK, President.*

*MILES M. O'BRIEN, }  
WILLIAM H. TAYLOR, } Vice Presidents.*

*JAMES V. LOTT, Cashier,  
EMIL KLEIN, Asst. Cashier,  
ALFRED W. DAY, Asst. Cashier.*

<b>Capital,</b>	.	.	.	<b>\$3,000,000</b>
<b>Surplus,</b>	.	.	.	<b>\$3,000,000</b>

**Broadway, Corner of Dey Street,  
New York.**

# Bigalke & Eckert Co.

## IMPORTERS OF WATCHES,

No. 1 MAIDEN LANE, NEW YORK.

Single and Split Second Timers in Nickel and Gun Metal Cases.

Complete Assortment of Chronographs, Split Seconds and Minute Repeaters.

SOLE AGENTS FOR

### Haus, Neveux & Cie.

FINE GENEVA WATCHES.

## OHIO CUT GLASS COMPANY

FACTORY

BOWLING GREEN, OHIO

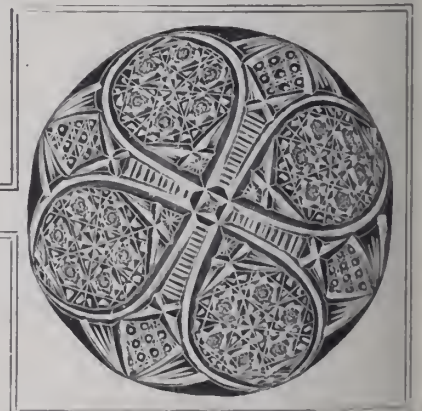

Chicago Salesroom	-	-	-	35 East Randolph Street
New York Salesroom	-	-	-	25 W. Broadway
St. Louis Salesroom	-	-	-	404 N. Fourth Street

# Our Traveling Representatives



The following traveling representatives were in the eastern Pa., recently: Frank Kennedy, Payne & Co., C. B. Bliss, Scofield & De Wyncott, Walter S. Strauss, Jacob Strauss & Sons; Adam Lehmann, Ludwig Lehmann. Among the traveling representatives recently in South Carolina, were: John W. Steele, C. G. Allen & Co., Louis Berger, A. Wittmauer Co.; A. Stevens, Fnos Richardson & Co.; Jos. P. Fin-Whiting Mfg. Co.; W. J. McKenna, Kelly & Co.; J. R. Traylor, Kremenitz & Co. Among the traveling representatives to visit New York, jewelers, last week, were: F. A. Jones, H. L. Judd Co.; Thos. D. Bailey, Robt. Matter, Mr. Harkhorn, Kremenitz & Co.; L. E. Verman, L. E. Waterman Co.; A. L. Hancock, Sydney Smith & Co.; Isador Jaskow; Theo. L. Baker, Wightman & Hough Co.

The following traveling representatives called on the trade in Kansas City, Mo., during the past week: Robert L. Clark, Towle Mfg. Co.; Wm. G. Crews, C. Sydney Smith; I. W. Friedman; N. Shan, Shunan Bros. & Co.; James J. Doll, A. Zugsmith, Thos. E. Rogers, Riker Bros.; Leo G. Smith; A. E. Baranger, Henry Polson Co.; Gus Price.

The following traveling representatives were in Ontario, Ont., last week: Geo. B. Kendrick, Reed & Barton; J. M. Wingard, R. Wallace & Sons Co.; Wm. Watts, T. G. Hawkes & Co.; James Pitts, Edward Jacot, Friedrich Speidel, Pforzheim, Germany; Jack Heller, L. Heller & Son; I. Stripp, S. & E. Trifius, London, Eng.; I. Lidman; J. De Mariano, Albert Lorsch & Co.; L. L. Nussbaum, Goldsmith Bros.

Among the traveling representatives who called on the trade in St. Louis, Mo., last week, were: J. P. Cutler, Regnell, Bigney & Co.; John A. Lee, Palmer & Capron; I. C. Nicholson, Excelsior Mfg. Co.; E. P. Tiffany, F. H. Sadler Co.; Wm. W. Henderson, Crane & Theurer; C. G. Fry, Ripley-Howland Mfg. Co.; C. L. Krugler, Medville, Carrow & Crane; Thomas E. Rogers, Riker Bros.; I. N. Fox, Fox Bros. & Co.; H. R. Lickman, Champenois & Co.; W. H. Gregory, Sobell & Crane.

Traveling representatives calling on the jewellers in Omaha, Neb., last week, were: Mr. Breck-Edge, Benj. Allen & Co.; Meyer Lehman, Ludwig Lehman; E. W. Travis, Geo. F. Brown; E. E. Mulding, Bassett Jewelry Co.; Max Huss, S. & Borgzinner; Thos. H. Ryland, American Watch Co. Co.; Thos. E. Rogers, Riker Bros.; Oscar. S. Smith, Aikin, Lambert & Co.; L. A. Blackinton, V. S. Blackinton Co.; Donald Le Stage, H. D. Britt Co.; Mr. Fisher, Furbish, Swift & Fisher; Orge C. McCormick, R. L. Griffith & Son Co.; Newhouse, Weizenegger Bros.; T. W. Friedman, Friedman & Co.; B. Wille, M. Wille; Mr. Ivard, Mason & Howard.

Traveling representatives who visited the Cincinnati, O., trade, during the past week, included: J. Price, Louis Strasburger's Son & Co.; Norbert Gutzburger, L. & M. Kahn & Co.; Leo Goldsch; Mr. Claffin, Claffin Jewelry Co.; Louis Gberg, J. Sollinger & Co.; Theodore Lyons, Ins Gem Co.; Charles B. Burgess, Frank M. Auting & Co.; Edward E. Allsopp, Wordley, Allsopp & Bloemcke Co.; H. C. Rowbotham, Schraewittstein Co.; Theodore Kuehl, Geo. Kuehl & Co.; T. S. Sturgis, Perley Bros.; L. H. Smith, Ipart, Grisco & Osborn; Louis Knobel, Louis Linger & Sons; C. H. Anderson, Ross, Saltman & Anderson; J. Thompson, J. B. Bowden & Co.; K. Benton, Geo. W. Parks Co.; Daniel Price, Vliam S. Hedges & Co.; Sam Jaskow, Boden-ner & Jaskow; Percy Lucas, Frank W. Smith accompanied by his bride.

Among the traveling representatives calling on the trade at Pittsburg, Pa., last week, were the following: Lewis L. Squire, F. H. Cutler & Co.; J. B. MacDonald, Wolcott Mfg. Co.; William Dalton, F. W. Weaver & Co.; Mr. Remington,

Carter, Qvarnstrom & Remington; Walter R. Shute, Kohn & Co.; Charles S. Untermyer, Chas. Keller & Co.; J. J. Kramer, John T. Mauran Mfg. Co.; O. G. Fehon, J. M. Fisher & Co.; W. D. Sinnock, Ehrlich & Sinnock; John S. Cunningham, E. L. Spencer Co.; Fred T. Barry, S. O. Bigney & Co.; E. A. Reed, Reed & Barton; F. J. Rider, Walter E. Hayward; George S. Melville, F. B. Rogers Silver Co.; J. Rosenberg, S. K. Grover Co.; H. A. Scofield, Scofield, Melcher & Scofield; J. H. Thompson, J. B. Bowden & Co.; John D. Dalzell, J. D. Dalzell & Co.; Walter S. Noon, Cary Bros. Co.; Ernest A. Rose, Weigle & Rose; C. A. Weidemann, Geo. Borgfeldt & Co.; C. B. Bartlett, Whiting Mfg. Co.; S. W. Abbey, E. Ira Richards & Co.; Mr. Day, Day, Clark & Co.

The trade at Pittsburg, Pa., was, last week, visited by the following traveling representatives: R. H. Brown, Chapman & Barden; Chas. S. Peckham, J. H. Peckham & Co.; G. Cheever Hudson, G. C. Hudson & Co.; H. B. Bliss, Gorham Mfg. Co.; Wade W. Williams, Warren & Williams; C. H. Davidson, Codding & Heilborn Co.; James O. Otis, Harvey & Otis; Walter R. Bristol, Wm. Rogers Mfg. Co.; Edward E. Allsopp, Wordley, Allsopp & Bloemcke Co.; S. W. Abbey, E. Ira Richards & Co.; F. W. Cullom, Sulzberger Bros.; J. T. Griffith, Jr., Carter, Howe & Co.; Lewis P. Cook, S. Sternau & Co.; W. H. Osborne, R. Wallace & Sons Mfg. Co.; R. H. Schley, Sloan & Co.; Benjamin Schloss, A. Wallach & Co.; Mr. Fisher, Furbish, Swift & Fisher; L. H. Smith, Bippart, Grisco & Osborn; Walter R. Shute, Kohn & Co.; Jules F. Schuman, Jr., William Kinscherf Co.; Edwin F. Skinner, Roy Watch Case Co.; Frederick J. Foster, Unger Bros.; T. K. Benton, G. W. Parks Co.; G. A. Schaefer, Regnell, Bigney & Co. Russel A. Talbot, Joseph Fahys & Co.; C. G. Perry, Ripley-Howland Mfg. Co.; George W. Beardsley, Allsopp & Allsopp; F. C. Winship, H. C. Fry Glass Co.; Mr. Ford, Ford & Carpenter.

Traveling salesmen visiting the Boston dealers during the week, included: William H. Sparks, Seth Thomas Clock Co.; John Mackay Parker Clock Co.; Mr. Spang, E. Ingraham Co.; Harry C. Larter and George W. Read, Larter & Sons, Matt Stratton and George Newman, Alling & Co., Archie Rutherford, H. A. Kirby Co.; George W. Hutchison, Hutchison & Huestis; R. H. Schley, Sloan & Co.; Charles T. Dougherty, William L. Sexton & Co.; Mr. Davies, Mason & Davies; Joseph V. Mayer, H. Schonkein & Sons; Mr. Staudinger, Charles Weller & Co.; Robert B. Steele, David Kaiser & Co.; Mr. Henius, Bruhl Bros. & Henius Co.; Frank Locklin, Battin & Co.; Victor Burgessor, Kremenitz & Co.; Mr. Sternburger, Stern Bros. & Co.; George Osborn, Wm. Smith & Co.; Milton H. Wallenstein, Silbermann, Kohn & Wallenstein; Mr. Sansbury, Sansbury & Nellis; "Jack" Hollister, Chapin & Hollister Co.; Douglas Tompkins, Mabie, Todd & Bard; Mr. Hicks, W. S. Hicks' Sons; L. C. Martin, Martin, Copeland & Co.; Wallace Campbell, Day, Clark & Co.; Mr. Hill, Hill & Schmidt; C. E. Mott, J. B. Bowden & Co.; J. T. Scott, Adolphe Schwob; Charles Theurer, Crane & Theurer; Harry Lisauer, Jacobson Bros.; Henry H. Holbert, Kohn & Co.; Mr. Peck, Waite, Thresher Co.; E. H. Egfeldt, Egfeldt & Ackley; Mr. Curran, A. J. Hedges & Co.; Mr. Huger, William Huger & Co.; W. W. Hurd; John Lasell, Unger & Christl; Sumner Lawson; Mr. Luthy, Luthy & Hine; Mr. Perley, Perley Bros.; Mr. Young, White & Young; Louis Kurtz, G. W. Cheever & Co.; Ed. Bliss, Bliss Bros. Co.; John A. Abel, Abel Bros. & Co.; C. E. Hancock; Louis Barrows, H. F. Barrows Co.

## Baltimore.

Welsh & Bro. Co. have moved from 323 N. Charles St. to their new home in the Professional building, 330 N. Charles St.

Most of the leading stores are practicing the early closing movement. Establishments are closed at 1 o'clock each Saturday, from June 1 to Sept. 15.

The Kann Bros. Silver Co., 303 W. Lexington St., is selling off its stock at auction preparatory to removing next door as soon as alterations are completed.

August Lemmert has succeeded in securing an absolute divorce from Barbara M. Lemmert, the case having lasted nearly two years. He alleged in his suit that his wife

abandoned him to become a follower of Dowie.

An order was signed, Thursday, by Judge Stockbridge, in the Circuit Court, requiring the Samuel Kirk & Son Co., silverware manufacturers, to show cause by June 21 why an injunction should not be issued prohibiting them from allowing any poisonous or noxious fumes, gases or vapors to escape from their premises, 106 and 108 E. Baltimore St., into the law offices of John J. Watson, 763 769 Calvert building. The bill of complaint filed by Mr. Watson, through Niles & Wolff, attorneys, states that the plaintiff's offices are in the rear of the Calvert building, which is separated from the Kirk building by Bank lane, a narrow thoroughfare. Whenever the wind comes from the south, southeast or southwest, it is alleged, corrosive and poisonous fumes, gases and vapors are carried from the Kirk factory into the open window of Mr. Watson's offices and render the offices uninhabitable.

## Canada Notes.

J. A. Young, Stettler, Alberta, has sold out.

Amos Chatfield, Macleod, Alberta, has assigned to J. E. Rogers.

J. F. Grummett, Boissevain, Man., has sold out to Mr. Stevenson.

D. I. Collis, Fendon Falls, Ont., is offering to compromise with his creditors.

Henry Ratelle, Cornwall, Ont., has assigned to D. Davis. A meeting of creditors was called for June 9.

E. F. White, Sydney, N. S., who is in financial difficulties, offers to compromise with his creditors at 25 cents on the dollar.

Miss Lilian Welch, daughter of A. H. Welch, manufacturing jeweler, Toronto, Ont., was married June 7 to Alexander A. Robertson, son of the late James Robertson, of Montreal, at Parkdale Methodist Church. The newly married couple will spend some weeks in Muskoka before taking up their residence in Montreal.

A vigorous campaign is being made by Friedrich Speidel, of Pforzheim, Germany, to capture the Canadian market for rolled gold goods. The house is represented in Toronto at present by Edward Jacot. It is claimed that though handicapped by the Canadian surtax of 10 per cent., the German house can supply the market more cheaply than the American firms, especially in the line of chains.

The sterling silver cup presented by the Earl of Durlham to the Ontario Jockey Club, to be competed for by Canadian foaled horses at the fall race meeting here, is displayed in the window of Ryrrie Bros., Toronto, Ont., and attracts much attention by its artistic design and exquisite finish. It is plated with gold and stands about 30 inches high. The bowl displays racing scenes, very elaborately worked out as to details, and is surmounted on either side by two horses in a rearing position. It is embossed with maple leaves, wheat and grain, and the whole surmounted by the national emblem of the beaver.

The retail jewelry store of L. C. Ingle, Sr., South Boston, Va., was recently destroyed by fire. The loss amounted to about \$10,000.

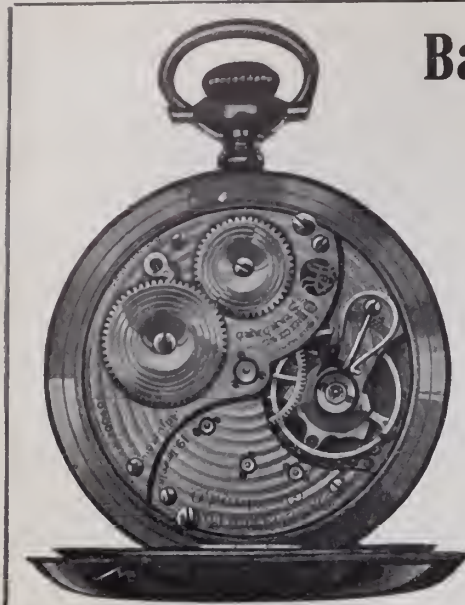

## Ball's Official Standard R.R. Watches

WHAT WOULD YOU GIVE FOR A LIFELONG CUSTOMER?

Try this plan.

Sell your next watch customer a "Ball."

Its reliable performance will convince him you are a dealer to be depended on—he'll keep coming back for other things.

The watch will win you his business and friendship for always.

*Write for booklet, and watch this space.*

We want to add a lot of new friends to the Ball family of railroad watch dealers.

### THE WEBB C. BALL WATCH CO.

CLEVELAND  
Ball Building

CHICAGO  
804-6-8 Railway Exchange

ESTABLISHED 1854.

INCORPORATED 18

JUERGENS & ANDERSEN CO.,  
DIAMONDS,  
MAKERS OF FINE JEWELRY,  
92 TO 98 STATE STREET,  
CHICAGO.

23-25 Looljersgracht, Amsterdam, Holland.

**THE HERMAN KECK MFG. CO.**  
CUTTERS OF  
**DIAMONDS.**

#### FOR SALE.

A complete diamond cutting outfit of twenty benches, European make, consisting of sawing machines, rounding machines, laps, tongues, dops, scouring stands, etc., all in first class condition. Will sell cheap, if sold in bulk at once, as we have replaced them with American tools.

MANUFACTURING JEWELERS, SILVERSMITHS

Recutting and Repairing of Diamonds.

17-19-21-23 West Fourth St.  
CINCINNATI, O.

RUDOLPH NOEL

RUDOLPH NOEL & CO.

IMPORTERS OF

## DIAMONDS

2 Tulp Straat, AMSTERDAM

'Phone 1902 John

37-39 Malden Lane, NEW YORK

PHILIP FEL





# WESTERN DEPARTMENT

Western Office:  
204 COLUMBUS MEMORIAL BUILDING,  
CHICAGO.

Telephone:  
4079 CENTRAL,  
CHICAGO.

Vol. LII.

CHICAGO, WEDNESDAY, JUNE 13, 1906.

No. 19.

## Chicago Notes.

Chas. J. Jacobs visited St. Louis last week. W. F. Mam, Iowa City, Ia., was here last week.

Herman Schultz has been succeeded by T. Austin.

Jacob Wolf recently gave a chattel mortgage for \$1,000.

E. C. Pike, Kankakee, Ill., has been seriously ill with pneumonia.

Hyman, Berg & Co. are making extensive improvements in their premises.

E. C. Lucas, representing A. H. Bliss & Co., is back from a western trip.

W. L. Mirrielees, with Manning, Bowman & Co., has returned from an eastern trip.

Jos. Brown has returned from a visit to the principal western and Pacific Coast cities.

D. A. Wilkins, with the Ostby & Barton Co., will return from the Pacific Coast about June 20.

T. F. A. Finn, of the diamond department of Loftis Bros. & Co., will visit New York next week.

The trustee in bankruptcy for the estate of T. D. Lande has declared a first dividend of 5 per cent.

A. A. Newman, of the Newman Clock Co., of Masonic Temple, will sail for Europe June 12 on the *Moltke*.

Emil Despres will go east to attend the marriage of Max Noel, which takes place in New York on June 27.

G. W. Bleecker, Chicago manager for Martin, Copeland & Co., is taking a vacation at East Orange, N. J.

The Chicago office of A. C. Messler & Co., with H. R. Herman in charge, has removed to room 1109 Heyworth building.

Mrs. Cecile Young Heyworth, daughter of Otto Young, secured a divorce from her husband, Lawrence Heyworth, last Saturday.

Alfred H. Bullion, jewelry manufacturers' agent, of San Francisco, was here last week.

Mr. Bullion has a temporary office at 1517 Laguna St.

Mr. and Mrs. Lederer stopped over here last week while on their wedding trip. Mrs. Lederer is the daughter of Sigmund Stern.

Stern Bros. & Co.

Carl Benzon was arrested here last week

for breaking into the store of Kunstader Bros., 238 Adams St. Benzon said he had crawled into the place to sleep.

Mrs. Wm. Forman died here last week and was buried at Marengo, Ill. Before her marriage she was Miss Webb, employed for a long time by Lapp & Flershem.

A meeting of the Chicago Jobbers' Association took place at the rooms of the Chicago Jewelers' Association yesterday. The plan and scope of the organization will soon be made public.

William Juergens, formerly with the Keystone Watch Case Co.'s Chicago office, was run down by an automobile one day last week. His right hand was cut and his right side bruised.

Norman McGillivray, who has been with Strelitz Bros. for the past 10 years, was united in marriage Saturday at 4 o'clock P. M. to Miss Carl Leyenberger. The couple are spending their honeymoon at Saratoga, N. Y.

Among the out-of-town visitors here last week were L. E. Garnett, Chanute, Kans.; Herbert E. Kinneer, Marion, Ind.; Mr. Anderson, Port Arthur, Ont.; Messrs. Belmer & Behner, Newton, Ia.; F. E. Potter, Corning, Ia.

Miss M. McIntyre, of the job department of Otto Young & Co., was taken to the Hahnemann Hospital, last week, to undergo a surgical operation. Miss McIntyre is doing well, and the hospital reports she will be discharged soon.

A syndicate has been formed to make a capital stock concern out of the mail order house of Sears, Roebuck & Co. The concern will be capitalized for \$40,000,000, of which \$30,000,000 will be common and \$10,000,000 preferred stock.

F. B. Tinker, representing the Quaker City Cut Glass Co., has on exhibition at his show rooms, 186 Fifth Ave., what is said to be the largest piece of cut glass of its kind in the world. This is a vase 5 feet, 7½ inches high and weighs 200 pounds.

Persistent rumors have been circulating here that Geo. B. Moore is no longer connected with Loftis Bros. & Co. To a CIRCULAR-WEEKLY reporter J. S. Loftis emphatically denied the report. He said that Mr. Moore was run down in health and was taking a vacation.

Herbert L. Joseph & Co., who recently

agreed to pay their creditors 30 per cent., are objecting to the payment of a number of claims aggregating about \$3,000. Objections are being made on the ground of difference in views regarding discounts. W. T. ApMadoc represents the creditors.

It was rumored here last week that A. C. Becken was negotiating to purchase the business of one of the most prominent tool and material houses here. As yet the deal has not been consummated. Mr. Becken has recently opened a material department, and with his customary energy is seeking to increase that branch of his business.

Chas. Moe, inventor of the diamond gauge, returned last week after an absence on the road for over four months. Mr. Moe visited all the principal cities of the west and southwest and made a trip to old Mexico. He left San Francisco before the earthquake, and stored some of his clothing and other personal property at the St. Nicholas Hotel. This property was totally destroyed. A box of jewelry stored by him in the vaults of the Pacific Coast Steamship Co., valued at \$5,000, escaped serious injury.

## Pacific Coast Notes.

Juan Escibano, Madrid, Spain, has been visiting in Mexico.

A. Tschumi's store, at Watsonville, Cal., was flooded by the recent rains. The loss was nominal.

Wm. Murphy, foreman of the W. K. Vanderslice Co., San Francisco, visited the Riley ranch, at Crockett, Cal., recently.

C. H. Wright, Eureka, Cal., will soon let the contract for the construction of a modern eight room residence at 13th and H Sts.

C. H. Blake, for many years with the S. Conradi Co., Los Angeles, announces that he has taken a position with Brock & Feagans, 4th St. and Broadway, Los Angeles.

The manufacturing jewelers of Santa Rosa, Cal., met last week to formulate a vote of thanks to the Jewelers' Board of Trade of New York, which organization furnished the Santa Rosa jewelers with complete sets of tools after the earthquake and fire.

W. E. McGill, optician, Marysville, O., moved recently into larger quarters.

# To the Jobbing Trade.



This may be a wrong way of remembering things, but it is certainly wise for you to jot it down in a convenient place, to see us when you wish to buy diamond mounted jewelry and mountings.

We are prepared to show our complete fall line and invite comparison. **Diamond Bunch Rings a Specialty.**

**IMPORTERS**

**SHIMAN BROS & CO.**

87 MAIDEN LANE, N. Y.

LONDON: 50 HOLBORN VIADUCT.      FACTORY,      MANUFACTURERS

AMSTERDAM: 2 TULIP STRAAT.      1, 3, 5 GOLD STREET.

## St. Louis.

M. M. Shinderman has returned from successful trip in Missouri and Kansas to the L. Bauman Jewelry Co.

Max Bauman, of the Bauman-Massa Jewelry Co., was on jury service last week in the Court of Criminal Correction.

W. H. Werre was in St. Louis last week on his way to Jefferson City, Mo., where he enters the employ of T. G. Burkhart a watchmaker.

V. T. Ellis, a graduate of the St. Louis Watchmaking School, has gone to Hazleton, Ind., where he will visit his relatives for a short time. He will later locate somewhere in the south.

Henry J. Dirk, who has been for many years with George R. Stumpf, 610 Frank Ave., has been receiving the best wishes of his friends on the occasion of his recent marriage with Miss C. Weitz.

The Right Rev. Daniel S. Tuttle, Bishop of the Episcopal Church, Wednesday ordained to the priesthood Rev. L. R. Vance, formerly a salesman in the silverware department of the Mermod, Jaccard & K Jewelry Co.

Max Schmidt, of the material department of the Bauman-Massa Jewelry Co. is mourning the loss of his father, F. W. Schmidt, who died in Houston, Tex., at an advanced age. Mr. Schmidt is expected back in St. Louis next week.

Among the visiting jewelers here last week were the following: A. Gerber, Jeweler, J. Wardsville, Ill.; A. S. Helber, Bonne Terre, Mo.; J. E. Doss, Carmi, Ill.; August Fischer, Whitehall, Ill.; A. R. Snodgrass, Troy, Ill.; Christ Keyler, Nashville, Tenn.; Fred Herold, Jerseyville, Ill.; M. E. Buc Paris, Mo.

Charles E. Pitcher, who is charged with the embezzlement of funds collected and jewelry belonging to J. F. Dailey & Co., 6th St. and Washington Ave., was arrested in Kansas City, Kans., according to advices received here by Ralph Wilson, manager of the Dailey store here. Officers have been sent for Pitcher.

Advices have been received here of sentencing in the United States Court at Springfield, Ill., Wednesday, of M. Skinner, Houston, Tex., president of the Keystone Commission Co., to pay a fine of \$250 and costs, upon a plea of guilty. J. Miller, an attorney of East St. Louis, was found guilty of complicity in connection with the same company and sentenced to serve 90 days in the workhouse at Peoria, Ill., where he was taken Thursday. The Keystone Commission Co. was engaged in the business of selling diamonds on a lottery plan. The plan of the company was to secure payments of \$1.25 a week on contracts, until \$110 had been paid, when the payee was to receive a \$200 diamond as soon as the contract was matured. Federal authorities have been after the company for more than a year.

Frederick S. Ayres recently opened a store in the quarters formerly occupied by the La France Jewelry Co., 100 W. Washington St., Elmira, N. Y.

Edward B. Leekey, Eagle Grove, Ia., sold out to Karl K. Keith, of that place, who will move to North Yakima, Wash., where he will succeed A. Schindeler.

**Kansas City.**

Southwestern Optical College graduated a class of 12 graduates last week.

J. S. Maulsby, of this city, has just entered as a pupil of the Kansas City Polytechnic Institute.

Edward Potts, representative of C. A. Kiger in Northern Missouri and Southern Kansas, was in this city last week.

Alfred Rowhедder, with the Edwards and Sloane Jewelry Co., has left on a vacation trip to Minneapolis and other Minneapolis points.

Edward Potts and Harry Clark, both covering Kansas territories for C. A. Kiger, were in the city last week for a stay of a few days.

Ed Mutton, formerly with the Underhill Jewelry Co. and later with the Harrington Mfg. Co., has taken a position with C. A. Kiger.

W. J. Rankin, who has been with W. Whiteside, Liberty, Mo., has taken a position in the factory of the Barr-DeVault Jewelry Co.

W. Knaul, with the Woodstock-Wheeler Watch & Jewelry Co., has gone out of the territory again, after spending part of the week in the house.

W. Barr, of the Barr-DeVault Jewelry Co., is in the German Hospital suffering from nervous prostration. According to reports he is improving.

J. R. Mercer and wife were members of a party that left here last week for Lawton Springs, Mo., to open the new house of the Monegaw Club.

W. S. Murray, who travels in Oklahoma, Indian Territory and Northern Missouri territory for C. A. Kiger, was in the city for a couple of days last week.

W. M. Scott, of the Woodstock-Hoefler Watch & Jewelry Co., left the city last week on a vacation trip of about two or three weeks. He will visit New York and other Minneapolis points.

W. E. Pitcher, Jr., a salesman for J. F. May & Co., St. Louis, was arrested a few days ago, in Kansas City, Kans., on a charge brought by his firm, and went back to St. Louis without a requisition.

W. G. Burgy, a pupil of the Kansas City Polytechnic Institute, has finished his education and gone to Brunswick, Mo., where he will open a jewelry store at once. He has unboxed his opening stock in this city.

W. H. Snow, who covers an Oklahoma and Kansas territory for the Woodstock-Wheeler Watch & Jewelry Co., has been in the city several days, and will take his vacation before again leaving for his territory.

W. I. Fluеhrer, bookkeeper for the Edwards & Sloane Jewelry Co., left last week on a vacation trip. He went direct to Marysville, Mo., to pay a short visit to his mother. From that point he will go to Muskogee, Okla., to visit other relatives.

W. W. Porter, head engraver for the Edwards & Sloane Jewelry Co., left for a vacation trip last week. He goes from the city to Detroit, then up to Toronto and returns there down to Boston by rail. From Boston he will come back to New York by boat and then home.

The following out-of-town retailers vis-

ited the Kansas City jobbers last week: S. J. Huey, Excelsior Springs, Mo.; A. Y. Boswell, Tulsa, Ind. 1.; L. S. Slocum, Cornning, Kans.; H. E. Tucker, Higginsville, Mo.; Mr. Campbell, of Campbell Bros., Oskaloosa, Kans.; Leslie White, Lees Summit, Mo.; Otto Burkland, Osawatomie, Kans.; C. J. Benson, Lees Summit, Mo.

**Omaha.**

John Crabill, Plattsmouth, Nebr., was in the city buying stock last week.

George Gerner, manager for C. Jacquemin, Council Bluffs, Ia., has returned from a trip to Colorado.

L. H. Robinson, Glenwood, Ia., has added handsome new fixtures to his store.

Albert Edholm has just installed a large size safe in his store, and has had it painted mahogany, to correspond with the store fixtures.

Axel Holmberg, watchmaker for S. W. Lindsay, with his family, is spending his vacation in Chicago. His family will remain there three months.

F. C. Churchill, of the New England Watch Co., was in this city last week, placing the western agency for their watches with the A. F. Smith Co.

Two clever confidence men, Jack Jennings and Angus Martin, were arrested last week in this city for substituting a bogus diamond for a valuable one at the jewelry store of M. D. Franks, 319 N. 16th St. Mr. Franks gave chase to Jennings and both exchanged several pistol shots. The two men entered the store late in the afternoon and asked to see a mounted diamond, which they had noticed in the show window. Mr. Frank took the gem to the show case and offered the men a magnifying glass at their request. Their actions aroused Mr. Franks' suspicions, so he walked around to the outside of the counter immediately, to notice the men had exchanged a bogus diamond for the genuine. He grabbed both men and told them to stand still. Jennings escaped, but Martin was held by a clerk, while Franks ran next door, telling them to call the police. He secured a revolver and hurried after Jennings. After a long chase Jennings was found hiding in the cellar of an old house. The gem was recovered and the thieves were taken into custody.

**Detroit.**

The Wayne Optical Co. has opened a branch store at Bay City.

N. G. Hamburg, of Wright, Kay & Co., recently returned from a trip abroad.

A large percentage of jewelers in Michigan are opticians, and a joint meeting of the Michigan Retail Jewelers' Association and Society of Optometrists will be held here July 11, 12 and 13 at the Normandie Hotel.

Charles Walker, alias Harry Williams and William Kendle, charged with stealing about \$1,500 worth of jewelry and diamonds from E. D. Trebilcock, 324 Woodward Ave., have demanded a trial, Walker having gone back on his confession. The police say they have his signature under it.

**Indianapolis.**

J. C. Sipe and Mrs. Sipe, who have been in the southwest for seven months, have returned home. Mr. Sipe is improved in health.

David S. Gribben, of Gray, Gribben & Gray, and family are now in Naples. Mr. Gribben will spend the entire Summer abroad.

The Indianapolis Technical Institute will open a school for jewelers next Fall when the school year opens. Equipment is now being ordered.

The Alexander Optical Co., which opened a store recently at 22 N. Meridian St., has left the city. The company opened a handsome suite of rooms and advertised extensively.

Out-of-town jewelers who visited the local jobbers and manufacturers last week included: Aaron Pursel, Noblesville; D. S. Whittaker, Lebanon; B. Maier, Edinburg; H. Wheeler, Dana; J. A. Pickett, New Castle; C. E. Hodge and Ross J. Haseltine, Kokomo; J. F. Harding, Brownsburg; H. A. Pauley, Bloomington, and Mr. Raber, of Clark & Raber, Anderson.

Moysig Milton Groh, son of I. Groh, of I. Groh's Jewelry Co., committed suicide in Louisville, last week, by drinking cyanide of potassium. Young Mr. Groh was formerly employed in his father's store. Domestic troubles are said to have prompted him to take his life. Burial was in this city. Several weeks ago, a salesman for the firm committed suicide by the same means, when detectives appeared at his home to arrest him for stealing from his employers.

**Minneapolis and St. Paul.**

Charles Horwitz, 303½ Washington Ave. N., Minneapolis, has sold his store to Pinck & Co.

A. E. Madsen, with Rettig, Hess & Madsen, has gone to Clear Lake, Ia., for a vacation of two or three weeks, after which he expects to go on to Chicago.

Among the recent out-of-town visitors in the Twin Cities were: Julius Schleider, St. Peter, Minn.; G. B. Ellestad, Lanesboro, Minn.; Mr. Jorgenson, Little Falls, Minn.; C. O. Querna, Madison, Minn.

Hyman Fegelson, formerly in the retail business in St. Paul, has won a suit in the district court, being awarded \$1,440 by the court on his policy in the Traders' Fire Insurance Co. Mr. Fegelson had insurance with this and three other companies on the stock in his store, which burned in February, 1904. The company contested the claim.

Fred O. Fisk, for a number of years in business in Minneapolis, 19 Washington Ave. S., Nicolle House Block, died June 4, after an illness of some time, of paralysis and complications. The funeral was held Wednesday and the interment was at the deceased's old home, Omro, Wis. A widow survives him. He had been in business under the style of Fisk Bros., but his brother who was with him died several years ago. The business is to be continued for the present at least.

## Cincinnati.

C. M. Fogg, of the Philadelphia Watch Case Co., was in this city last week.

K. Sato, Tokio, Japan, was among the recent visitors to the Sterling Glass Co.'s plant.

Ierd. Phillips, of Richter & Phillips, and family have returned from a sojourn at Mt. Clemens, Mich.

William Owen has just made his regular quarterly watch inspection trip on the Queen & Crescent Railroad.

S. Sneed has notified his Cincinnati friends of his removal from Georgetown, Ky., to Gulfport, Miss.

Joseph Phillips, manager of the Sterling Glass Co., and family have located at their Summer home at Tower Hill.

Walter Mayer and Albert Wallenstein, of the firm of Wallenstein, Mayer & Co., have left on their respective trips south.

John Reis, Vevay, Ind., was here last week with his young son for the purpose of having the latter operated upon for appendicitis.

W. W. Roberts, Nicholasville, Ky., bought fixtures here for his store, which he has just enlarged and remodeled on up-to-date lines.

Herman Smith, of G. E. Smith & Sons, Parkersburg, W. Va., with his bride, included a visit to Cincinnati in their honeymoon trip.

J. W. Jones, Mt. Sterling, Ky., has purchased fixtures here for his new store, which is located opposite the Mt. Sterling Court House.

William Schultz recently connected himself with Hahn & Oppenheimer as a traveling representative. He is now making a southern trip.

Lindenberg, Strauss & Co. have inaugurated a new department of imported brie-à-brac. This firm has also added to its office force Harry Jackson.

Wesley T. Harrison, Williamstown, Ky., is recovering from an operation. J. E. Davis, Midway, Ky., is at business again after an attack of illness.

The Gustave Fox Co. furnished the gold and silver medal fobs for the Cincinnati Turn Verein athletic meeting, to be held June 17, at the Zoological Garden.

Otto Mehmert, with Joseph Mehmert, and Miss Katherine Fisher, of Cincinnati, will be married June 21 at the home of the bride. After the ceremony a reception will be held in West Turner Hall.

The new Seth Thomas street clock just put up by George Newstedt, at the corner of 4th and Race Sts., is a great ornament as well as an improvement to that corner. It is box-shaped and mounted on a large bracket, which extends from the corner of the building. It has three transparent dials, illuminated by electricity. On the top of the clock stands a gilded lion about three feet high holding a cut glass ball in its forepaws. This and other ornamentations in iron relief work make the clock a most attractive and beautiful as well as useful ornament to the city.

Out-of-town jewelers who were here the past week buying stock included: F. G. Meyer, Dayton, O.; N. Saming, Walton, Ky.; E. Mueller and L. Bentel, Hamilton, O.; Gallipoli Novelty Co.'s buyer, Gall

polis, O.; A. J. Winters, Paris, Ky.; J. C. Fischer, Flemingsburg, Ky.; George Habermass, A. J. Jordan Cutlery Co.; Edw. McNulty, Indianapolis, Ind.; Fred Wittlinger and wife, Middletown, O.; William Lehne, Decatur, Ind.; Ashton & Baker, Middletown, O.; E. Israel, Harrison, O.; J. H. Sherwood, Brooksville, Ky.; W. H. Keller Co., Corydon, Ind.; C. F. Kappes, St. Paul, Ind.; Charles Sederberg, Milford, O.; G. H. Hansgen, Bethel, O.

## San Francisco.

### TRADE CONDITIONS.

Conditions in San Francisco are now rapidly improving and many lines of trade have fully resumed business. The banks have opened their doors, thus relieving the money stringency, and making it possible to get accounts in a measure straightened out. Events seem to show that the jewelry trade was affected more heavily by the disaster than almost any other. All the large stores were located in the burned district, and even should some retailers save a large portion of their stock, there is still a heavy loss, as these stores were as a rule fitted up in an expensive manner. Wholesalers are locating again, many of them in buildings fitted up near their old locations, while others have sought quarters near the present center of business on Fillmore St. During the confusion here the country trade has been largely diverted to Sacramento and Los Angeles and houses that have been established at Oakland. Trade is very heavy for this time of the year, for the State was never in a more prosperous condition, taking it as a whole. Many of the houses here are now issuing circulars to their customers, telling them that business has been resumed here and it will not be long before the country trade will be taken care of as before the fire.

J. Greenburg has opened a store at 1324 Buchanan St.

Albert Schohay & Son have opened an office at 1354 Ellis St.

F. R. Deremer & Co., whose store on Montgomery St. was destroyed by the fire, are now located at 217 Church St.

The Eagle Watch Repairing & Jewelry Co., of which J. Dick is manager, has opened an office at 1115 Golden Gate Ave.

The California Jewelry Co. is located in temporary quarters in rooms 70 and 71, Delger building, Broadway and 14th St., Oakland, Cal.

J. Johnson, who formerly had quarters at 1187 Market St., will soon occupy a store now being constructed for him at 1154 Golden Gate Ave.

A. Engelhardt, watchmaker and jeweler, formerly with Hammersmith & Field, has opened a shop with the Chinn-Berretta Optical Co., 1815 Fillmore St.

Ferdinand Heiduska, manufacturing jeweler, has located temporarily at 1970 Bush St., but is unable to do much yet, owing to the lack of tools and machinery.

Tuckey & Kline, jewelers and diamond setters, and Carrau & Green, wholesale jewelers, formerly located at 220 Sutter St., will soon locate in a handsome new store at 1512 Buchanan St.

T. Lundy, who had for years conducted a jewelry store on Market St., near Grant Ave., is now located at 817 Stanyon St. A temporary structure is being erected on the old Market St. site and as soon as it is finished Mr. Lundy will be back at the old stand, having secured a lease.

Mr. Alexander, jeweler and diamond dealer, formerly at 752 Market St., is now located at 1942 Fillmore St. for the time being. While the Market St. store may be

revived later, it is more than likely that a lease of three or four years will be seen on a store near the new business center.

J. B. Whitney, agent for the Holme & Edwards Silver Co., the E. Ingraham the Derby Silver Co. and the American Cuckoo Cloak Co., has offices at 1251 Valard St., and the city business is transacted there. The country business attended to at the Oakland office, Broadway.

Shreve & Co., who are located at Johnson and Fillmore Sts., are at present decided as to just what course they pursue, except that as soon as the old store can be fitted up they will return to it. The location of the new factory has not yet been decided upon, but it will probably be south of Market St., in the vicinity of the old one.

The Baldwin Jewelry Co., whose magnificent store in the James S. Flood building had been open but a comparatively short time, and which also operate a store on 3d St., near Market St., is located at 1521 Sutter St. The manager states that the concern will likely go to the store in the James S. Flood building when it is put into shape again.

Hammersmith & Field are resolved to keep near the center of the most shopping district, and have secured a lease on the property at the corner of Ness Ave. and Eddy St., just across from Tait's new cafe. Van Ness Ave. is becoming the choice retail street. Emporium is already located there, and many other large firms are putting up buildings. Carpenters are now at work on the new store of Hammersmith & Field, and it will probably be open for business some time during the present month.

The W. K. Vanderslice Co. occupies offices at the corner of Post and Devisadero Sts., and has a watchmaker and jeweler employed there. Mr. Hazel, of this firm, states that no further plans have been made for the immediate future, and that his firm will make no more until the insurance matters, which are now hanging fire, are settled. He states, however, that it is the intention of the firm to get into the downtown district as soon as the latter builds up again. Owing to the large size of the establishment and the short time and few facilities for moving, practically nothing was saved.

Radke & Co., who formerly had stores at 65 Geary and 118 Sutter Sts., but are now located at 1813 Devisadero St., have finished the equipping of their factory there. A new store is now in course of construction for this firm at Van Ness Ave. and Bush St., and this will be ready for occupation within a few weeks. The present store on Devisadero St. will also be maintained and the factory for both stores at there. This firm was very fortunate in securing a wagon on the morning of the earthquake, and much of its stock was saved from both stores. Many of the employees have been notified to return, and business will soon be running smoothly again.

J. J. Prentice has admitted a partner in his jewelry business in Brownwood, and the firm is now Prentice & Powell.

INDEX TO ADVERTISEMENTS.

Ams & Slignton	30	Forman Co.	100	Nonnenmann, A., & J. Aschenbrenner	50
A n, Lambert & Co.	100	Forsinger, J. W.	88	Noterman, Jos., & Co.	69
A pp & Allsopp	24	Poster, Theodore W., & Bro. Co.	32	Novelty Engineering Ass'n.	96
A pp Bros.	26	Four-Truck News	78	Ohan, G.	72
A n Mfg. Co.	Inside front cover	Fox, Gustave, Co.	19	Ohio Cut Glass Co.	62
Arlund, H. E., & Co.	30	Freund, Henry, & Bro.	18	Omega Watches	89
A rican Gem & Pearl Co.	52	Friedlander, R. L. & M.	Outside back cover	Oneda Community, Ltd.	12, 13
A rican Platinum Works.	104	Garraud & Griser	42	Oppenheimer Bros. & Veitu	36
A rican Waltham Watch Co.	80	Gesswein, F. W., Co.	96	Oppenheimer, H. E., & Co.	36
A o Crown Mfg. Co.	58	Goldsmith, C. L., & Co.		Oriental Bank	60
A steln Bros. & Co.	Outside back cover	Goldsmith, Leo	48	Osmann-Parker Mfg. Co.	22
A m Stamping & Mfg. Co.	31	Goodfriend Bros.	44	Ostby & Barton Co.	21
A n, John & Son	Outside back cover	Gorham Mfg. Co.	50	Patek, Philippe & Co.	90
A c Turquoise Co.		Gongelmann, Pam	14	Penfold, Wm. C., Co.	88
B z, Perle & Co.	46	Griffoul, August	96	Potter & Butinton Co.	18
B r, Geo. M.	Outside back cover	Guardian Trust Co.	60	Power, Chas. L., & Co.	44
B, Webb C., Watch Co.	64	Haagstoz, T. B., Ltd.	104	Powers & Mayer	104
B l, A. C., & Co.		Harris & Harrington	Outside back cover	Prior, Charles M.	24
B likopf, Jacob	42	Hedges, A. J., & Co.	22	Prybil, P.	104
B ett Jewelry Co.	28	Hedges, Wm. S., & Co.	44	Racine, Jules	76
B s & Bacon	21	Helitz Bros.	22	Reichhelm, E. F., & Co.	96
B near, H., & Co.	98	Heller, L., & Son	38	Reinzelhausen, W. F., Co.	104
B e, J. & H.	96	Herpers Bros.	102	Revell, A. H., & Co.	Outside back cover
B ke & Eckert Co.	62	Hirschberg, A. S.		Ries & Armstrong	76
B ey, S. O., & Co.	4	Hodenpyl & Walker	38	Rockford Watch Co.	52
B nes, Chester, & Son	42	Holtzer-Cabot Electric Co.		Roger Williams Silver Co.	27
B op, R. W.	104	Hotel St. James	100	Roseman, A.	48
B kinton, R., & Co.	30	Howard, E., Clock Co.	78	Rosenfeld, Wm. I.	40
B kinton, W. & S., Co.	54	Hruba, Louis W.	103	Roy Watch Case Co.	86
B eard & Co.		Humphrey, John B.	48	Rudolph & Snedeker	90
B e, Edward	98	Hutchison & Huestis	28	Rumpf, C. F., & Sons	100
B ell & Vitell	44	Illinois Watch Co.	8	Saart, W. H., Co.	28
B an Jewelry Co.	30	Jacot Music Box Co.	98	Saunders, Menner & Co.	44
B den, J. B., & Co.	20	Jaudhour, F., Jr.	103	Schiff, M.	25
B lley Polytechnic Institute.	104	Jeanne, Frederick A.	46	Schultz, Leiss & Co.	25
B mer, R.		Johnston, W. J., Co.	10, 11	Sessions Clock Co.	88
B ver, Maurice	50	Juergens & Andersen Co.	64	Shiman Bros. & Co.	103
B ol Bros. & Hepnis Co.		Juergens, Jules	90	Siegel, Rothschild & Co.	66
B ley, Sam'l., & Co.	26	Kahn, L. & M., & Co.	Outside back cover	Simmons, R. P., Co.	14
B le & Ipmeyer Co.	50	Kock, Hermann, Mfg. Co.	64	Smith, Alfred H., & Co.	36
B one, C. H., Co.	29	Kent & Woodland	23	Smith, E. H. H., Silver Co.	102
B onia Jewelry Co.		Ketcham & McDougall	100	Smith, Wm., & Co.	103
B ington & Co.	22	Kilpper Bros.	78	Snow & Westcott	26
B er, Howe & Co.	23	Kohlbusch, Herman, Sr.	103	Sohn & Hyman	48
B ham National Bank	60	Kohn, Alois, & Co., Sr.	25	Solidarity Watch Case Co.	44
B hard Freres	50	Kohn & Co.	74	Spencer, E. L., Co.	29
B ey & Straigt	1	Kosiland & Italle Co.	78	Sprague Law School	100
B er Diamond Co.	42	Kreimentz & Co.	25	State Bank	60
B er & Poranna		Lackner & Ohl	98	Steiner, Louis	31
B e, S., Co	26	Langendorf Watch Co.	90	Stern Bros. & Co.	48, Inside back cover
B n, M.	24	Larter & Sons	34	Sternau, S., & Co.	16
B n & Bequelin	31, 58	Lederer, S. & B., Co.	52, 78	Stiven, John S.	104
B nman Co.		Lelmann Bros.	96	Strauss, Ignaz, & Co.	Outside back cover
B ch & Fitzgerald	98	Lelong, L., & Bro.	Outside back cover	Strauss, Jacob, & Sons	48
B elbaum & Friedman		Lewy, Robt.	16	Street, Geo. O., & Sons	24
B e Clark & Co.	23	Lewy & Cohen	98	Tavannes Watch Co.	74
B on, Louis J.	10	Lissauer & Co.	38	Thomas, Seth, Clock Co.	86
B rick's Sons, James H.	13	Loeb, Wm., & Co.	31	Trenton Watch Co.	86
B esse Mfg. Co.	24	Lorsch, Albert, & Co.	Outside back cover	Trout, Charles L., & Co.	22
B elms Watch School	42	Loth, Joseph, & Co.	26	U. S. Electro-Chemical Co.	96
B ond Point Pen Co.	103	Low, Martin, & Taussig	38	Van Dam, Eduard	52
B helm, Hipp., & Bro.	90	Lowe, Edwin, & Co., Inc.	72	Wadsworth Watch Case Co.	6, 7
B holly, J. J.	103	Luthy & Hine	26	Wagner Mfg. Co.	27
B inger, C., & Sons	98	Lyons Gem Co.	42	Waite-Thresher Co.	29
B d, J. C., & Co.		Mackey Jewelry Co.	30	Washburn, C. Irving	102
B er Watch Case Mfg. Co.	17	Maebert & Reiss	72	Wells, Chester H.	20
B r, Robt.	24	Maple City Glass Co.	98	Wendell & Co.	5
B ar, Leach, Garner Co.	96	Market & Fulton National Bank	60	Western Clock Mfg. Co.	76
B a, Thomas J., & Co.	27	Mercantile National Bank	61	Wheeler, Hayden W., & Co.	36
B nd & Co.	22	Meyerowitz Bros.	42	Whiteside & Blank	23
B iber & Co.	48	Miller, Fuller & Whiting	30	Whiting & Davis	19
B l National Watch Co.	82	Moore & Sons	24	Whiting Mfg. Co.	9
B sof Bros. & Co.	50	Mount & Woodhull	46	Wightman & Hough Co.	28
B. H. Chalm Catch	76	Myers, S. F., Co.	74	Witsenhansen, L.	29
B s, Joseph, & Co.	1	Newburgh, R.	90	Wodiska, Julius	27
B hild & Co.	100	New England Watch Co.	84	Wolfsheim & Sachs	31
B e-Jacot, Georges, & Co.	89	New York Telephone Co.	103	Wood, C. F., & Co.	Outside back cover
B y, W. J., Co.	26	Noel, Rudolph, & Co.	64	Wood, J. R., & Sons	2, 3

**A. C. BARD & CO.**

IMPORTERS AND CUTTERS OF **DIAMONDS**

Loose or mounted goods on memo. to responsible dealers.

103 STATE ST., CHICAGO. COLUMBUS MEMORIAL BUILDING.

**JOS. NOTERMAN & CO. DIAMONDS**

IMPORTERS AND CUTTERS

Recutting and Repairing odd shaped and chipped stones a speciality. Manufacturers of Mountings and Fine Jewelry. Special Designs Furnished.

CINCINNATI, OHIO.

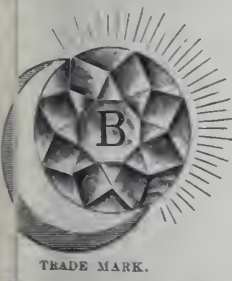

## Special Notices.

Payable invariably in advance.

Rates 75c. per insertion for notices not exceeding 25 words; additional words, 2c. each.

**SITUATIONS WANTED**, 1c. a word each insertion; minimum charge, 25c.

Heavy type, 5c. a word; minimum charge, \$1.25. Display cards, \$2.00 per inch.

In all cases, if answers are to be forwarded, 10c. extra to cover postage must be enclosed.

*All answers to advertisements addressed care The Jewelers' Circular-Weekly, should be sent to the New York Office, unless the Chicago Office is specifically mentioned.*

## Situations Wanted.

**A1 WATCHMAKER** and engraver; own tools; best references. F. Kranrad, care Diftler, 166 E. 4th St., New York.

**SITUATION WANTED** by A1 watchmaker, engraver and salesman; reference; fine tools; age 29. Geo. N. Wood, Decatur, Ill.

**SALESMAN** of experience, with trade in middle west, wants to connect with a manufacturer. "Z., 6489," care Jewelers' Circular-Weekly.

**YOUNG MAN**, 23 years old, wishes position as salesman or to work inside in wholesale house. "L., 6498," care Jewelers' Circular-Weekly.

**WANTED**, in south, situation as watchmaker, with A1 store; only with gentleman of refinement and standing. Mr. Haldeman, 106 S. 2d St., Columbia, Pa.

**YOUNG MAN**, letter and monogram engraver, wants position, with opportunity to learn watchmaking. Milton Gebhard, 735 Sansom St., Philadelphia, Pa.

**BY WATCHMAKER** and engraver; can do clock and jewelry repairing; complete tools; will go anywhere. "Willing, 6526," care Jewelers' Circular-Weekly.

**YOUNG LADY**, four years' experience in jewelry business; also full details of office work; capable of taking charge. "Capable, 6540," care Jewelers' Circular-Weekly.

**YOUNG MAN**, who thoroughly understands clock repairing and is A1 salesman, wishes position at once; best references. "M., 6582," care Jewelers' Circular-Weekly.

**WANTED**, by young man (24) position as general engraver, with opportunity to learn watchmaking; references; prefer New England. Address Box 92, Holden, Mass.

**POSITION WANTED** in a fine store, by a graduate optician; assistant watchmaker and engraver; \$10 and half the optical profits. Dr. H. M. Wood, Decatur, Ill.

**YOUNG MAN** (18) wishes position in first class jewelry shop, where there is advancement; four years' experience. Address "Apprentice, 6564," care Jewelers' Circular-Weekly.

**WANTED**; A POSITION as engraver, bookkeeper, cashier and saleslady; good references; terms reasonable. Address "Enquirer, 5877," care Jewelers' Circular-Weekly.

**WATCHMAKER**, engraver and graduate optician, wants position; can do some clock and jewelry repairing; single and no bad habits. C. H. Smith, 2637 N. 17th St., Philadelphia, Pa.

**OPTICIAN**, jewelry salesman and lens grinder, good appearance; best habits, wishes position with first class firm; best references. Address "A. S., 6575," care Jewelers' Circular-Weekly.

**EXPERIENCED TRAVELER**, with jewelry and optical trade, wants position with first class jobbing house or manufacturer, to represent them. "Represent, 6485," care Jewelers' Circular-Weekly.

**FIRST CLASS WATCHMAKER** desires position in New York City; has first class references and is thoroughly competent on fine and complicated work. "City, 6565," care Jewelers' Circular-Weekly.

**WATCHMAKER** and general repairer desires a position with a retail store; one year's experience; first class reference; age 24; German; salary, \$10 per week. Address Box 116, Algonquin, Ill.

**BY AUG. 1**, A1 watchmaker, optician, jeweler and salesman; seven years' experience; good references; age 25; position paying less than \$20 per week not considered. Box 181, Sharpsburg, Pa.

**WATCHMAKER**, having several years' experience on fine and complicated work, would like position; competent to take charge of department. Address "Waltham, 6560," care Jewelers' Circular-Weekly.

**JEWELER**; first class worker on rings, lockets, bracelets and cluster work; also first class modeler, caster and repairer, wishes steady position; city or town. "Y., 6518," care Jewelers' Circular-Weekly.

**PRACTICAL REFRACTIONIST** and watchmaker of ability; good salesman; good address and appearance; open for position at once; eastern Pennsylvania preferred. "N., 6506," care Jewelers' Circular-Weekly.

**JAPANESE**, excellent watchmaker and jeweler, or as salesman; also some experience in optical work; has had store in this country; excellent experience. Masui, care Mrs. H. Webber, 244 W. 116th St., New York.

**A FIRST CLASS German watchmaker**, 28 years old, who speaks some English, desires to obtain a permanent position; preferably in the south; answer, naming compensation. "A. B.," P. O. Box 100, Houston, Tex.

**SITUATION WANTED** by thorough, up-to-date watchmaker, jeweler and engraver; 26 years' experience; all tools and references; Illinois, Indiana or Wisconsin; now open. "N., 6536," care Jewelers' Circular-Weekly.

**YOUNG MAN**, with 10 years' experience in retail store, would like to connect with wholesale firm on Maiden Lane, New York, with opportunity to advance to road; A1 references. "H., 6581," care Jewelers' Circular-Weekly.

**HAVE PRACTICAL EXPERIENCE** in the making and repairing of hotel and other branches of silverware; would go into partnership in jobbing shop with man of capital. Address "H., 6570," care Jewelers' Circular-Weekly.

**TRAVELING SALESMAN**; A1 reference and well established trade among retail jewelers in Pennsylvania, New York and Ohio, wishes to connect with manufacturer or jobber. "M., 6567," care Jewelers' Circular-Weekly.

**WANTED**, POSITION in New York by young lady having 10 years' experience in the wholesale and retail jewelry line; best of references furnished as to character and ability; please answer at once. "L., 6522," care Jewelers' Circular-Weekly.

**BY YOUNG MAN**, 26 years, first class watchmaker, engraver and jewelry repairer; also graduate optician; wants permanent position in central or southern States; tools and best of references furnished. Address E. L. Barnard, Muscatine, Ia.

**BY YOUNG MAN**, 26 years old; A1 watchmaker and engraver; can do jewelry repairing; also graduate optician; desires permanent position in central States; Illinois preferred; can furnish best of references; own tools. Address "Watchmaker," care W. L. Wilkinson, Brooklyn, Iowa.

**POSITION WANTED**; first class jeweler desires a position; a foreman in jeweler's factory, ring shop preferred; capable of handling a large number of men; can furnish the best of reference; at present am holding a similar position but am desirous of making a change; please address. "Position, 6545," care Jewelers' Circular-Weekly.

**TO MANUFACTURERS**; salesman selling the best trade in New York City desires to make a change; high grade 14k. line preferred. Address, "W., 6578," care Jewelers' Circular-Weekly.

**POSITION WANTED** by an experienced diamond man, in wholesale house; has been buyer and traveler in loose goods business for a number of years. Address, "Diamond, 6559," care Jewelers' Circular-Weekly.

## Miscellaneous.

**SOMETHING** entirely new in the line of window decoration; send five two-cent stamps for sample and postage. Address The Window Exhibitor Co., 74 Cortlandt St., New York.

## Side Lines Wanted.

**WANTED**, agencies for lines, diamond jewelry, emblem goods and other leading jewelry; well known west of Missouri River; first class references. S. H. Friend, San Mateo, Cal.

**SALESMAN**, traveling from Chicago to west coast, desires 10-K. gold, or ring line for big trade; first class references from Chicago and the east. "Western, 6521," care Jewelers' Circular-Weekly, 103 State St., Chicago.

**WANTED**, by the undersigned, list of high grade goods or diamond goods for highest class retail trade of cago and outlying towns, on commission; will guarantee results; and commercial references. E. A. Rich, Room 803, 103 State St., Chicago, Ill.

## Help Wanted.

**JEWELER AND ENGRAVER**; easy work; good salary. Ries & Armstrong, Macon, Ga.

**WANTED**, SALESMEN for men's jewelry western territory. Flower Mfg. Co., Mt. Bldg., Chicago, Ill.

**WANT** a first class watchmaker; good wages; be a mechanic. Address "Y., 6569," care Jewelers' Circular-Weekly.

**WANTED**, first class watchmaker and engraver; \$25 weekly and permanent position to right man. E. D. Thomas, San Antonio, Texas.

**WANTED**, OPTICIAN; one who can repair eyeglasses or do plain engraving. W. H. Long, and 1627 South St., Philadelphia, Pa.

**OPTICAL CLERK** wanted by New York City; sale house; state full particulars. "Respon, 6574," care Jewelers' Circular-Weekly.

**AT ONCE**, a good engraver, clock and jewelry repairer; steady position to a good man. Address "J., 6367," care Jewelers' Circular-Weekly.

**WANTED**, first class jeweler and clock repairer; good salary to right man; references required. C. J. Hoenninger, 1466 Third Ave., New York.

**ENGRAVER**, steady position for a good letter and monogram engraver; references required. Albert Bros., Third Ave., cor. 58th St., New York.

**WANTED**, a jewelry manufacturer and repairer; permanent position for right man. Address Kleitz & Bro., 615 Market St., Wilmington, Del.

**STONE SETTER**, jewelry repairer and engraver; state wages; send references and sample of engraving in first letter. J. S. Pfeiffer, Parkersburg, W. Va.

**WANTED**, a young woman as assistant in office; retail jeweler; state experience and references. Address "Office, 6592," care Jewelers' Circular-Weekly.

**WANTED**, IMMEDIATELY, first class watchmaker; good, light, pleasant shop; fine class of work; permanent position. J. H. Sawyer, Portland Harbor, Maine.

**WANTED**, AT ONCE, a watchmaker and engraver; permanent position for a good man; send reference with application. J. W. J., Mt. Sterling, Ky.

**WANTED**, ornamental engravers; those who are accustomed to sterling silver preferred; address them with references. Albert J. Gannon, 1004 Chestnut St., Philadelphia, Pa.

**WANTED**, three experienced opticians and watchmakers; apply by letter, with references and salary required. "Castelberg's, 6568," care Jewelers' Circular-Weekly.

**JEWELER**, for repairing; must be first class workman; one who can do some clock work preferred; state salary and references. "C., 6566," care Jewelers' Circular-Weekly.

**WANTED**, assistant clock and watch repairer; good salesman; plain engraver and optician near New York; state salary wanted. "Z., 6567," care Jewelers' Circular-Weekly.

**WANTED**, WATCHMAKER, good salesman optician; capable of taking entire charge; New York City; state salary expected. "Z., 6534," care Jewelers' Circular-Weekly.

**WANTED**, a first class watchmaker; one who engraves preferred; write fully, giving age, experience, references and, if engraver, send sample. Edward Vail & Co., Wichita, Kans.

**WANTED**, young man with five or six years' experience in manufacturing jewelry shop; be good jobber and be able to do some new work. Address E. C. Harpstrite, Wichita, Kans.

**HELP WANTED.—Continued.**

**WANTED**, experienced traveler having called on jewelry trade in central west; liberal com-  
pact to Al man. Western Selling Agency,  
Jega Watches, Heyworth Bldg., Chicago, Ill.

**WANTED**, YOUNG MAN to assist on watches;  
d clock and jewelry repairer; engrave; wait  
trade; permanent position; \$15 to \$18. H.  
Wood, 35 Merrimack St., Haverhill, Mass.

**WANTED**, first class jeweler and engraver; skilful  
manufacturing, repairing and on diamond  
rk. \$25 weekly and permanent position to  
ht man. E. D. Thomas, San Antonio, Tex.

**WANTED**, jobbing jeweler, fair engraver, clock  
carrier and salesman; one who can set stones;  
age, experience and salary wanted. Address  
his. 6355," care Jewelers' Circular-Weekly.

**WANTED**, capable watchmakers who can do  
shing; those with watch factory experience  
ferred; write application at once, giving ex-  
perience, etc. Trenton Watch Co., Trenton,  
J.

**WANTED**, young watchmaker and good clock  
el, good position; state age, experience and  
ery expected; must have good reference. Ap-  
Ramsay, 1221 F St., N. W., Washington,  
C.

**WANTED**, first class engraver, optician and sales-  
man; permanent position for good man; must  
be well recommended; central New York  
e. "E., 6538," care Jewelers' Circular-  
Weekly.

**WANTED** WATCHMAKER, jeweler and salesman;  
state age, experience and salary wanted; give  
employers as reference; steady position.  
ress "Ohio, 6554," care Jewelers' Circular-  
Weekly.

**WANTED**, good watchmaker; must be capable of  
doing ordinary engraving and waiting on trade;  
permanent position to right man; good salary.  
ress Krauss & Sector, 45 N. Illinois St.,  
Indianapolis, Ind.

**WANTED** FIRST CLASS ENGRAVER; one who can do  
all kinds of lettering and monogram engraving;  
must use a good steady man at a good salary.  
Apply to A. Newsalt, Jeweler, cor. Fourth and  
Main Sts., Dayton, O.

**WANTED** FIRST CLASS watchmaker and optician wanted;  
good opportunity offered to right party; steady  
position; in one of the large cities in Pennsyl-  
vania; write at once. L. W. Rubenstein, 54  
Maden Lane, New York.

**WANTED** MANUFACTURER of high grade silver novelties  
desires the services of Al salesman to handle  
his on commission; west, middle west and  
south; give particulars. "Specialty, 6580," care  
Jewelers' Circular-Weekly.

**WANTED**, first class diamond, precious and imi-  
tation stone salesman for southern and western  
territory; right position for right man; apply by  
letter, stating experience. Address "Confidential,  
65," care Jewelers' Circular-Weekly.

**WANTED**, first class watchmaker and engraver to  
take charge of watch department; also want first  
class jobbing jeweler who understands diamond  
setting; steady work and good pay; single man  
preferred. B. Van Keuren & Co., Savannah, Ga.

**WANTED** JEWELER; permanent posi-  
tion; state reference, ability, age and  
salary in first letter. Wm. Schweig-  
ert & Co., Augusta, Ga.

**WANTED** ENGRAVER, for inscriptions and monograms on  
watch cases, jewelry and silverware; to do our  
best work; good wages; steady work; nine-hour  
day; only a first class, experienced engraver is  
needed. Wendell & Co., 105 William St., New  
York.

**WANTED**, a first class, competent, experienced  
and capable retail jewelry salesman; southern  
territory preferred; when making application please  
state experience, give reference and salary  
wanted. Apply to the J. J. Sweeney Jewelry Co.,  
Houston, Tex.

**WANTED**, first class watchmaker and engraver;  
send sample of engraving and references in first  
letter, stating salary wanted; give age and ex-  
perience; steady employment and good wages to  
right man. Address Henry Iversen & Co.,  
Ciciana, Tex.

**WANTED** FIRST CLASS WATCHMAKER and salesman;  
fair engraver; good jeweler and stone setter;  
competent to take full charge; reliable and experi-  
enced; best references; salary, \$18 to \$20 per  
week. Address "Detent, 6553," care Jewelers'  
Circular-Weekly.

**YOUNG LADY** for office of large manufacturing  
and diamond house; one with experience and  
accustomed to execution of mail orders pre-  
ferred; good salary; state references and full  
particulars. "Emerald, 6591," care Jewelers'  
Circular-Weekly.

**WANTED**, WATCHMAKER, engraver and sales-  
man; is there a good all around man ready to  
accept permanent position in southern New  
York; hours, 8 to 6; state wages, age, experi-  
ence, reference, and all particulars, etc. "D.,  
6478," care Jewelers' Circular-Weekly.

**WANTED**, AT ONCE, good young man to go to  
Dallas, Tex., to assist in our wholesale depart-  
ment; must come well recommended as well as  
be a good penman. Apply, not later than Fri-  
day, June 15, 3 P. M., to Ben Linz, care L. &  
M. Kahn & Co., 170 Broadway, New York.

**WANTED** strictly first class watch-  
maker; permanent position; state  
experience and ability and give refer-  
ences. Chas. F. Sentz, Columbia,  
S. C.

**HIGH GRADE SALESMAN** for well  
known line of mountings; eastern and  
middle states. Address, "Eastern,  
6480," care Jewelers' Circular-  
Weekly.

**SIDE LINE**; I have an entirely new article that  
sells to all jewelers and opticians; I will make  
a proposition to a few good men having good  
territory, that will pay at least \$25 per week;  
sample is small and article has merit; address at  
once, "Novel, 6519," care Jewelers' Circular-  
Weekly.

**WANTED**, a good engraver on all general work;  
must do fine script and monogram work of all  
kinds; do all hard and soft soldering and gen-  
eral jewelry work, repair clocks and do window  
trimming; don't particularly care for a watch-  
maker; correspond at once. Austin & Prescott,  
Main St., Batavia, N. Y.

**WANTED**, strictly first class combination man  
(watchmaker, jeweler and engraver); must be  
sober and well recommended; good salary and  
permanent position to good man; must be a wil-  
ling worker, rapid and very thorough; state salary  
expected and send sample engraving first letter.  
Thos. Van Auken & Co., 516 Pearl St., Beau-  
mont, Tex.

**WANTED**, young or middle aged man who has  
some acquaintance with the watch business, who  
can command from \$4,000 to \$5,000, willing to  
travel occasionally to Pittsburg, and cities in  
eastern circuit; to take half interest in a new  
office of a manufacturing company of well  
known repute in this city. Address "Opportunity,  
6520," care Jewelers' Circular-Weekly.

**REPRESENTATIVE**; an important  
Swiss watch factory wants an active,  
serious and honest representative in  
the United States. Address Offer  
with particulars to Case Postale,  
4398, Chaux de Fonds, Switzerland.

**WANTED**, a strictly first class engraver, capable  
of doing fine script and monograms of all kinds,  
for a first class house; good salary and perma-  
nent position to right party; would prefer a  
man who could also act as salesman, or who  
understands some other branch of the jewelry  
business; send samples of engraving and refer-  
ences in first letter. "X. Y. Z., 6539," care Jew-  
elers' Circular-Weekly.

**WANTED** first class letter and mono-  
gram engraver; permanent position  
to the right man; prefer one who can  
do jewelry repairing; send sample of  
engraving and references in first  
letter. Chas. F. Sentz, Columbia,  
S. C.

**WANTED** TRAVELING SALESMAN  
with established trade in diamonds,  
loose and mounted, also watches and  
jewelry, in New York City and sub-  
urbs; state full particulars. "Diamond  
Importer, 6584," care Jewelers' Cir-  
cular-Weekly.

**WANTED**, A BUYER and manager for our whole-  
sale jewelry department; one capable of taking  
entire charge; must be a man who has occupied  
a similar position before, and who can command  
a trade; must be thoroughly posted on the east-  
ern jewelry markets, and be of undoubted ability  
and integrity; to such a man we offer an unusual  
opportunity; address with particulars. Jos.  
Brown & Co., Fifth Ave. and Madison St.,  
Chicago, Ill.

**SALESMAN** for New York City and  
vicinity, wanted by well known man-  
ufacturer of 10k. gold jewelry; sample  
stock, commission basis; must have  
acquaintance with jewelry and de-  
partment stores; no objection to good  
man representing another line; all re-  
plies confidential. "Gold, 6418,"  
care Jewelers' Circular-Weekly.

**WANTED**, AUGUST 1, high grade sales-  
man for well known manufacturer's  
line, of Providence, R. I., territory  
middle and western states; must have  
acquaintance with large department  
stores and leading retailers in large  
cities; to a young man of good ad-  
dress and who is aggressive and suc-  
cessful, with unexceptional refer-  
ences, a good position is open; state  
experience, age and salary expected.  
Address, "Permanent, 6590," care  
Jewelers' Circular-Weekly.

**Business Opportunities.**

**FOR SALE**, a small, clean stock of jewelry in a  
fast growing town; plenty of money; no better  
place to be had. Box 78, Nazareth, Pa.

**FOR SALE**, old established jewelry store, in good  
railroad town in Mississippi; stock can be re-  
duced to \$5,000 or less. Address "Jay, 6525,"  
care Jewelers' Circular-Weekly.

**PARTNER WANTED**, man about 30, who is well  
acquainted with the jewelry trade and can in-  
vest about \$5,000 in an old established manu-  
facturing jewelry concern of Al reputation. Ad-  
dress "Maiden Lane, 6228," care Jewelers' Cir-  
cular-Weekly.

\$7,000 will purchase an interest in a retail jewelry  
business; established, well and favorably known;  
located in one of the most prosperous cities of  
200,000 inhabitants in the United States. Ad-  
dress "Rare Opportunity, 6341," care Jewelers'  
Circular-Weekly.

**PARTNER WANTED**; I have long lease of a  
beautiful store; best location in Norfolk, Va.,  
for jewelry and optical business; new, up-to-  
date fixtures, safe, optical stock and trade; desire  
a partner with capital or with jewelry stock. Ad-  
dress "A. V.," 524 Colley Ave., Norfolk, Va.

**QUICK ACTION** by corresponding with  
us; we buy your entire stock; or send  
us your surplus stock of watches and  
diamonds; we originated this method  
and have twenty years of quick ac-  
tion and good service to our credit.  
Joseph Brown & Co., Fifth Ave. and  
Madison St., Chicago, Ill.

**AN OLD ESTABLISHED** general jew-  
elry manufacturer desires to form  
corporation to extend its business, or  
would sell on easy terms; this plant  
is equipped with the finest kind of  
tools and dies, to manufacture jewelry  
and small novelties; this opportunity  
will stand investigation. Address  
"Jewelry, 6544," care Jewelers' Cir-  
cular-Weekly.

**DO YOU WISH TO RETIRE?** We buy  
jewelry stores to any amount; also  
entire stocks of jewelry, diamonds,  
watches, silverware, fixtures, etc.; we  
are known all over the United States  
to pay highest spot cash; notify  
us, we will call on you at once; all  
business transacted we handle strict-  
ly confidential. Address Brooklyn  
Purchasing Syndicate, 608 Broadway,  
Brooklyn, N. Y., or Tel. 2328, Wil-  
liamsburg.



**Ladies' Fancy Stone Rings  
and Stone Scarf Pins  
in 10K. that defy  
competition.**

Our reputation for making the finest and most complete line of 10-K. gold band rings is still maintained—ask your jobber.

THE  
**EDWIN LOWE & CO., Inc.**  
F. W. BODWELL, V.-Pres. and Gen. Mgr.,  
116 Chestnut St., PROVIDENCE, R. I.  
New York Representative, E. T. Wilson, 180 Bway.  
Western Representative, S. H. Brower.

**MAEBERT & REISS**

WATCHMAKERS TO THE TRADE  
Wheel Cutters and Adjusters

Accurate Work—Low Prices—Quick Returns.  
We receive parcels by mail or express from all over the United States.

71 and 73 NASSAU ST., Corner John,  
(The New "Cockcroft" Bldg.) NEW YORK.

**Expert WATCH and Chronometer REPAIRING  
FOR THE TRADE.**

When others fail you we guarantee satisfaction.  
A trial will convince. Prices very reasonable.

List will be sent on request.

G. OHAN, 37-39 Malden Lane,  
Lorsch Bldg., Room 27. NEW YORK.

**TRADE-MARKS**

OF THE

**JEWELRY and KINDRED TRADES,**

PRICE \$3.00.

PUBLISHED BY  
THE JEWELERS' CIRCULAR PUB. CO.,  
11 John St., Cor. Broadway, New York

**Special Notices.**

(Continued from page 71.)

**For Sale.**

FOR SALE, at 50 cents on the dollar, 40 ruby velvet trays, for watches, rings, chains, lockets and plain, to stack, all or part. Room 605, 92 William St., New York.

EATON & GLOVER engraving machine; latest model with all attachments and 12 sets of types; all in good condition; sell for \$65. B. Olbricht, 730 Broadway, Brooklyn, N. Y.

FOR SALE, Crouch & Fitzgerald telescope; cost \$12; sell \$8; 14 trays, cost 42c. each, sell 25c.; used one year; Kohlbusch diamond scales, cost \$9, sell \$5. Room 605, 92 William St., New York.

FOR SALE, at a bargain, 7/8-1/64 carat white stone, set in Gypsy 14-K setting, \$114; cost \$130, 30 days ago; also, a few 1/2 to 1 1/4 carat stones, set in rings, at bargains; sent on memo. to well rated jewelers with the understanding you report at once and send cash for what you keep. Dan. I. Murray, Broker, 3 Maiden Lane, New York.

**To Let.**

DESK ROOM or part of office to let. 3 Maiden Lane, Room 53, New York.

TO LET, part of an exceptionally desirable office, with fine north light; opportunity for precious stone business or manufacturer's agent. Room 48, Lorsch Bldg., 37 Maiden Lane, New York.

WILL RENT small and large offices; good north light; manufacturers' representatives or diamond dealer preferred; telephone connection and safe. Apply at once, Room 54, 7 Maiden Lane, New York.

**Wanted to Purchase.**

JEWELERS' gold scale wanted, about 30 oz. "New York, 6583," care Jewelers' Circular-Weekly.

WANTED, TO BUY, small jewelry store with good repair trade in New York or Brooklyn. Address "K., 6529," care Jewelers' Circular-Weekly.

WANTED TO BUY office fixtures, etc., on or near Maiden Lane, New York; small room where rent is reasonable and will not be advanced within a year, or would buy out small jobber or importer for spot cash; tell me in confidence what you have to offer. Address "Broker, 6449," care Jewelers' Circular-Weekly.

**TO LET.**

**Three Desirable Light Lofts**

At 31 MAIDEN LANE, N. Y.,

One door from Nassau St. Prominent location, center of jewelry district. Address F. J. Whiton, 130 Broadway, New York; or, your own broker.

**News Gleanings.**

S. E. Hall has sold out his business in Hampton, Ia.

H. H. Moses, Jefferson, O., recently sustained a loss of \$500 by fire.

Warren Lashbrook has taken a position with H. L. Chase, of Waterloo, Ia.

J. Lott Losey, South Bend, Ind., has given a chattel mortgage for \$1,600.

Frank Anshutz, Shenandoah, Ia., recently celebrated his 20th anniversary in business.

Geo. D. Kendall is selling out his jewelry and optical business in Pueblo, Col. at auction.

P. K. Wiser, Mankato, Minn., recently celebrated his 40th anniversary in business in Mankato.

Michael Tracy was recently arrested in Manchester, N. H., for selling jewelry out a license.

Carson & Smith, Hagerstown, Md. recently erected a large street clock in front of their store.

M. A. Gaskell, Rochester, Minn., has added a new wall case and otherwise improved his store.

C. E. Sargent has completed arrangements to open optical parlors at 52 1/2 Columbia St., Albany, N. Y.

Rufus M. Dempsey & Co. is the firm of the business formerly conducted by Rufus M. Dempsey, Madisonville, Ky.

J. E. Judge, Ames, Ia., recently sold stock to C. Edwards, of Watertown, Dak. The new owner will take possession June 15.

H. L. Tucker, New London, Ia., recently sold out to Adolph Leach and Harry S. Huff. Mr. Tucker will give possession June 15.

L. Oreck, Duluth, Minn., has been succeeded by the Oreck Jewelry Co. Oreck is now in the souvenir and jewelry business.

A fire originated in the store of Cleis, South Bend, Ind., several days ago but was extinguished before doing any serious damage.

The retail jewelry store of A. Briggs, Cement, Okla. T., was recently robbed of 15 watches and \$25 in silver. Thus far no arrests have been made.

J. S. Baker has resigned his position as George H. Cook, Phoenix, Ariz., and taken a position as manager of the Crescent Jewelry Co., of the same place.

C. A. Vanderburg, Superior, Wis., announces a closing out sale, and will return to San Francisco, Cal., to engage in wholesale business.

Geo. W. Hiekox, of the Hiekox May Jewelry House, Albuquerque, N. Mex., has partially recovered his health, and left California, where he will remain for some time.

Nathan F. Stedman, formerly engaged in the retail jewelry business in Mount Pleasant, Ind., is the defendant in a suit for divorce in Clinton County, brought by his wife, and requests the custody of the four children.

The first annual meeting of the Retail Jewelers' Association will be held at Des Moines, June 14 and 15. A large attendance is expected. The Iowa Optical Association meets June 12 and 13, thus making it possible to take in two conventions at the same time.

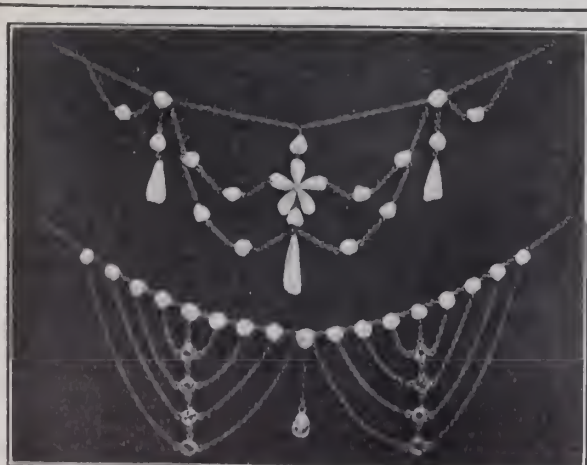

**FESTOON  
NECKLACES**

The increasing demand for high grade Festoon Necklaces has compelled us to make up a larger and more varied line of them than ever before, set in combination with Diamonds, Baroque Pearls, Aquamarine, Topaz, Peridots, Amethysts, Turquoise, fancy Sapphires, etc., etc.

CUFF BUTTONS      LOCKETS  
BROOCH PINS      SCARF PINS  
BRACELETS

**COOPER & FORMAN** OFFICE AND FACTORY  
MAKERS OF DIAMOND JEWELRY 3 MAIDEN LANE, NEW YORK



**Popular Talks on Law.**

(Copyrighted, 1906, by WILLIAM C. SPRAGUE.)

**CONTRACTS.**

(Continued from issue of May 9.)

**3. WHAT MAKES A CONTRACT?**

There are two elements that are always present in a contract, namely, an offer and acceptance. If either is lacking there is no contract. Not every offer and acceptance makes a contract for a breach of which an action will lie in the courts. If, for instance, I offer to entertain you at my house and I fail to appear at the time, this is an offer and an acceptance, but no contract. Therefore, we should understand that the offer, in order to lead to a contract, must be an offer of a certain thing, something intended to change the legal relations of the parties; so, an offer in itself, if so understood, can not give rise to a contract.

As to how the offer must be made no law can be laid down. It may be made orally or in the form of writing, by signs, advertisements, and by any number of other ways. A mere wink of the eye or a nod of the head, as in the case of bidding at an auction, may constitute an offer.

Acceptance, too, may be made in a number of many ways, there being no formalities required, unless in the case of a number of classes of contracts where the statute provides that a writing shall appear to show the terms. Of these kinds of contracts we shall speak later.

In order to make a contract, the offer must be accepted in the terms of the offer. If there is any variation between the offer and the acceptance or any conditions attending the acceptance, a contract is not made. Contracts made by correspondence are peculiarly subject to fault in this particular. In correspondence does not show that the intentions of the two parties have met upon the same proposition no contract is implied.

Offers are frequently made to be accepted within a certain time or at a certain place, and in a certain manner. The acceptor in order to bind the one making the offer must accept in the terms of the offer to form a valid contract.

A difficulty sometimes arises in cases where the time wherein which an offer may be accepted is not stated. It may be said generally that an offer may be accepted while it continues open; but, where there is no time fixed within which acceptance must be made, how long has the offeree within which to accept? The rule of law is that once an offer is made, it is presumed to continue open for a reasonable time unless it is sooner withdrawn. What is a reasonable time depends upon the circumstances of the case. It is a matter for a jury to decide in a case where it is as to whether the acceptance was made within a reasonable time.

Of course, an offer, even although made for a definite time, may be withdrawn at any time. This is not true, of course, if the person to whom the offer has been made has said or has agreed to pay something for the offer left open.

This brings up the question of option. An option has no value within the law unless something has been paid, or is agreed to be paid for it. If I voluntarily offer to

sell my horse for \$100 and give you a week in which to buy, I may withdraw the offer within the week without being liable to damages for not keeping my promise; but, if you have given me something, no matter how slight, it being of some value, or if you have agreed to give me something or render me some service in exchange for the agreement to hold the offer open, I must do so or put myself in danger of a suit for damages. After a reasonable time has elapsed, the offer not being made for a definite time, it is not necessary for one making the offer to formally withdraw it, as the law will presume it to be withdrawn. If the one offering wishes to withdraw before a reasonable time has elapsed, he must communicate the withdrawal by word or act to the offeree.

There are some things that will terminate an offer other than the voluntary act of one offering, as, for instance, his death or his insanity.

Offers are sometimes made to the general public, no particular persons being specified, as when an offer of reward is made in a newspaper or by posters. In such cases any one may accept if he does so before the offer is withdrawn; and in order for it to be withdrawn the same means must be used as was used in making it public.

In our next we shall treat of the important subject, "Contracts by Mail and Telegraph."

(To be continued.)

**Pittsburg.**

P. C. Gillespie sails the first week in July for Europe on a diamond buying trip.

M. R. Hull, who has opened a store at Salem, O., was in Pittsburg last week, buying stock for his store.

R. E. Prosser, formerly in the optical business in 6th St., has opened parlors in the Empire building, Liberty Ave. and Fifth St.

Many local jewelers last Saturday closed their stores at 1 P. M., and will observe the early closing period on Saturdays until Sept. 1.

Henry Wilkins & Co. have bought out the establishment of Simpson & Co., at 440 Wood St. The latter firm opened the store about a year ago.

The Federal Loan Co. is the name of a new concern which recently opened for business at 121 Federal St., Allegheny. The store is at the corner of Robinson St.

The Adler Optical Co., which opened for business at 216 6th St., has erected an immense electric sign, the dimensions being five by 30 feet, and the illumination at night lights the street up for a block.

S. Davis & Co., who suffered a \$15,000 loss by fire two weeks ago, have been paid in full by the insurance companies, and the firm is now doing business as usual. Mr. Davis will remodel his establishment just as soon as he can have the work done.

Lipman & Lipman last week opened "The Palace," a jewelry and novelty store, at 235 Fifth Ave., next door to the new store which E. P. Roberts & Sons will open shortly. The Lipmans were formerly in partnership with May Bros., who now have a store in Cincinnati. The Lipman brothers

also have a St. Louis store. H. M. Lipman is managing the Pittsburg house.

Among the out-of-town buyers in Pittsburg last week were the following: Frank Worrel, Cannonsburg; William Hunt, Uniontown; C. H. Bauer, Blairsville; A. Katzenmeyer, Burgettstown; S. H. Schmidt, Manor; H. R. Brown, Donora; J. P. Rosendahl Irwin, J. F. Murphy, Dawson; Frank Bloser, New Kensington.

Within the next week or 10 days, a meeting of wholesale jewelers will be arranged, the purpose being to perfect plans for giving a banquet some time early in January. W. O. Harrison, of the George B. Barrett Co., has been circulating among the dealers securing expressions, and all appear to be in favor of it. It is proposed to organize a jewelers social club in this city. The gathering together of the wholesalers is expected to promote a more kindly feeling. Some of the retailers probably will be invited to the banquet.

Huhn & Co., manufacturing jewelers, 224 Fifth Ave., last week caused the arrest of Walter Measkel, aged 14, who resides in Kirkpatrick St., on a charge of larceny. The lad confessed to Detective Aymer that he had given certain jewelry to James Boyle and George King. The police say he is charged with stealing four watches, a gold chain and a diamond from Huhn & Co., where he was employed. Measkel told the detective that the boys to whom he gave the articles agreed to sell them. Three watches and a chain were recovered from Boyle, both Boyle and King being charged with receiving stolen goods.

After a most successful five-day tour of Ohio, the members of the Merchants' & Manufacturers' Association who toured the northwestern part of the State Saturday returned to Pittsburg well satisfied with the trip. At Conneaut some of the members of the party, 100 in number, played a pleasant joke on Sam F. Sipe, by decorating his section in a Pullman car with black diamonds, the kind that are in the rough, as well as cobblestones and a few other street missiles. Mr. Sipe enjoyed it very much. He alone visited 140 jewelers during the tour. Another member of the party was Mr. Montgomery, representing M. A. Mead & Co. At Alliance, O., the merchants there met the train at the station with 54 automobiles. This was the sixth trade extension tour, the Pittsburgers everywhere being received with open arms. F. R. Babcock, president of the association, was presented with a silver loving cup at Erie last Friday night, where the journey ended.

**Contracts Awarded to Supply Treasury Department With Clocks.**

WASHINGTON, D. C., June 8.—The contract for furnishing United States public buildings under control of the Treasury Department, east of the Rocky Mountains, with clocks during the next fiscal year, has been awarded as follows: To the Seth Thomas Clock Co., 8-day pendulum clocks at \$10.10 each; to the American Clock Co., electric clocks at \$19.25 each.

A soda water fountain has been installed in the store of J. Robinson & Son, Springfield, Mass., by S. S. Sobotka, of Boston.

# The Aristocrat of all 10K. Lines.

HOW often we hear the jewelers say something like this: "You certainly do know how to make your line look like fine 14K. goods. There has been room for just such a 10K. line for a long time."

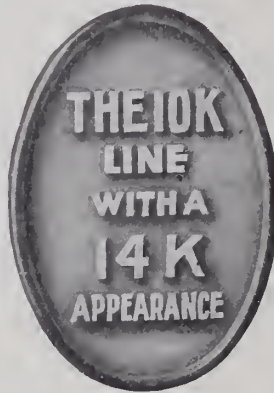

*Rohr & Co*

Camp and Orchard Streets

Newark, New Jersey



**THE TRADE**

desirous of keeping in touch with modern producing methods, should always consult the pages of

**OUR BIG CATALOGUE,**

with its 30,000 illustrations and long list of prices. We send this splendid book free on request.

*S. F. Myers & Co*

Headquarters for Dueber-Hampden Watches  
WHOLESALE JEWELERS

The New S. F. Myers Bldg. 476-49 Maiden Lane, New York.

"Cantlose"

The New Eye-glass Holder

Practical  
Simple  
Safe  
Secure



Positively prevents loss of Glasses from Hook. The feature of this Holder is a "Hump" engaged by a "Loop," making a secure connection.

For Sale by Leading Optical Dealers

Paul Gougelman, Mfr., 37-39 Maiden Lane, N. Y.

"Practical Course in Adjusting."

PRICE \$2.50.

ALL JOBBERS OR JEWELERS' CIRCULAR PUBLISHING CO.

# QUALITY COUNTS

The Increasing Sale of TAVANNES WATCHES

Proves their worth as timekeepers

FULLY GUARANTEED  
For sale through the jobbing trade



TAVANNES WATCH CO.,  
2 & 4 Maiden Lane, New York.

# PATENT DEPARTMENT

WHICH IS CONTAINED A LIST OF THE LATEST PATENTS GRANTED BY THE UNITED STATES AND GREAT BRITAIN, THE UNITED STATES PATENTS THAT HAVE BEEN REPEALED AND THE REGISTERED TRADE-MARKS.]

## UNITED STATES PATENTS.

ISSUE OF MAY 29, 1906.

**299,649. EYEGLASSES.** JOSEPH KOVACS, Newark, N. J. Filed Feb. 6, 1906. Serial No. 299,696.  
The herein-described nose-clamps for eyeglasses, nose-clamps comprising a head member pro-



vided at one end with two separate fingers which project therefrom and are curved outwardly and inwardly at an angle thereto, the end portions of the fingers being approximately parallel.

**299,678. COLLAR-SUPPORTER.** JOHN H. THEBERATH, South Orange, N. J., assignor to Bippart, Griscom & Osborn, Newark, N. J. Filed July 28, 1905. Serial No. 271,593.  
An extensible collar-supporter having members formed of skeleton frames, the outer member having side bars *a* with stud at one end, and at the other end the ties *g*, and having the notches *n*



in one of the side bars, and the inner member having side bars *b* fitted to slide within the ties *g* with transverse stud at the outer end, and a tooth carried by such inner member with means for engaging it detachably with the notches *n* within the outer member.

**299,900. MACHINE FOR COVERING EYE-GLASS-CASES.** FRANK A. TIBBALS, Weymouth Center, Mass., assignor to Wilton E. Drake, Boston, Mass. Filed June 12, 1902. Serial No. 111,431.

A covering-machine, having, in combination, a rotatably-supported member for receiving the article to be covered, a member closely embracing

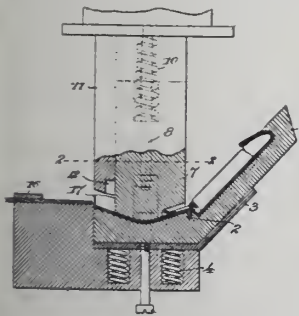

the member, a plunger adapted upon its descent to press the article and the receiving member inward below the surface of the embracing member to cause the embracing member to fold upon the edges of the covering material at the edges of the article, and means for actuating the plunger.

**299,901. MACHINE FOR LINING EYE-GLASS-CASES.** FRANK A. TIBBALS, Weymouth Center, Mass., assignor to Wilton E. Drake, Boston, Mass. Filed June 12, 1902. Serial No. 111,432.

A machine for lining articles, having, in combination, a support for the article to be lined, a

plurality of pressing members for engaging different parts of the lining and pressing it into the

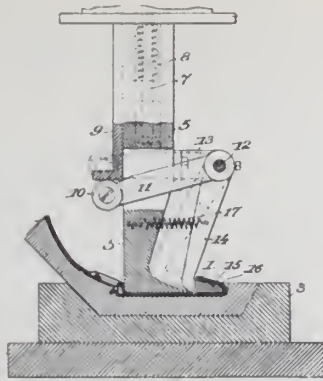

article, and means for actuating the pressing members independently during the pressing operation.

**321,912. BLOTTER-HOLDER.** ERNEST M. WHITTINGTON, Nashville, Tenn. Filed Aug. 23, 1905. Serial No. 275,419.

A blotter-holder comprising a metal plate having integral clips at each end, said clips being bent back upon the under side of the plate and adapted to hold a blotter, an upwardly-extending loop



punched from the plate adjacent one end, a finger punched from the plate adjacent the opposite end, a ring fastened upon the said loop, and an adjustable strap connected to said ring and carrying a ring at its opposite end adapted to engage said finger, all of said parts being arranged.

**321,910. FOUNTAIN-PEN.** JOHN HOLLAND, Cincinnati, O. Filed Feb. 17, 1906. Serial No. 301,551.

In combination with a fountain-pen having an opening in the side of its barrel, a sleeve sliding



on the barrel and having longitudinal notches in one end, said end being turned inward at the notched end, thus forming a contraction for gripping the barrel.

**322,011. STUD OR BUTTON.** ALFRED J. O'DONNELL, St. Louis, Mo. Filed Aug. 18, 1905. Serial No. 274,802.

A device of the class described comprising a base, a needle formed upon said base and provided with a recess formed at the rear of the point and extending around the entire periphery, a head



member having a perforation formed therein for the insertion of the needle, a pair of leaf-springs riveted within the head, the free ends curved to receive the needle to lodge within the recess and retain the same in locked position.

**322,018. STEM-WINDING WATCH.** HENRI ROSAT, Fils, Le Locle, Switzerland. Filed May 24, 1905. Serial No. 262,042.

A stem-winding mechanism for watches com-

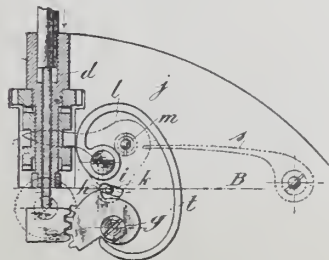

prising a winding-pinion provided with a clutch member and a projecting spindle, a setting-pinion.

an intermediate shiftable member slidably and non-rotatively mounted on said spindle and adapted for engagement with said clutch member or setting-pinion, a spring-actuated rocking lever holding said intermediate member in engagement with said clutch member, a presser-rod slidably mounted in a bore formed in said spindle, a false stem engaging said rod, a rack engaged by said rod, and a spring-actuated sector meshing with said rack and having a spring of higher tension than the lever, said sector and lever having engaging portions.

**322,029. TIME RELAY RECORDING-CLOCK AND SIGNAL MECHANISM.** GUY P. THURBER, Pittsburg, Pa. Filed May 11, 1905. Serial No. 259,921.

In a time relay recording-clock, the combination with an electrically-actuated air-brake system, and a shaft driven by a clock mechanism, of wheels mounted upon said shaft, brushes engaging two of said wheels, a dog engaging one of said wheels,

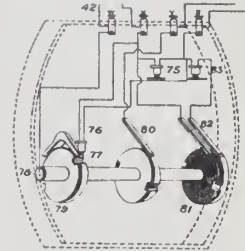

a relay operated by a track block-circuit and adapted to elevate said dog to permit of the movement of its respective wheel, the breaking of said circuit releasing said dog and stopping said wheel at a predetermined time, and breaking electrical circuit through said brushes to set said air-brakes.

**322,137. PROTECTOR FOR SPECTACLES.** CHARLES E. LINING, Peru, Ill. Filed June 8, 1905. Serial No. 264,323.

A protector-case for eyeglasses and spectacles made from a flat paper blank, said case consisting of guard-walls cut from the bottom of the blank,

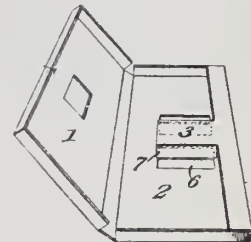

scored and bent at right angles thereto, a tail-piece having three walls bent upwardly therefrom, and a ledge forming a stop for the cover, said tail-piece and walls being secured to the guard-walls.

**322,200. COLLAR-BUTTON.** CATHERINE C. FIGGATT, New York. Filed Feb. 9, 1905. Serial No. 244,952.

A button, consisting of a stem, a head, a base and a disk mounted between the base and the head, the said base and disk each being formed



with a semi-circular-shaped portion on one side of the stem and a semi-elliptical-shaped portion on the other side of the stem, the semi-circular portion of the disk being arranged on the opposite side of the stem from the semi-circular portion of the base, and all of the parts of the button being integral.

**322,215. OPERA-GLASS.** EMIL B. MEYROWITZ, New York, assignor to the Meyrowitz Mfg. Co. Filed Nov. 7, 1904. Serial No. 231,704.

A folding opera-glass comprising a hinged casing

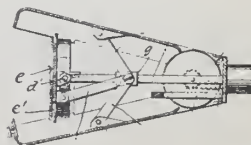

having a support therein, a lens-frame within said casing and pivoted to said support, and link con-



**"Ebonoid"**  
TRADE MARK

IS SO WELL KNOWN that it requires little comment. Neither heat nor moisture will affect it, and its beautiful ivory black finish is indestructible, making it as handsome and serviceable as ebony, at one-fifth the cost. "EBONOID" trimmed with silver creates a most striking contrast. Our trimming is of the best white metal, quadruple plate, and will wear a lifetime. Ask your jobber to

show you our new line of STEINS, LOVING CUPS, SHAVING MUGS and BRUSHES, VASES, CLARÉT PITCHERS, SMOKERS' SETS, etc., and don't fail to send to-day for our illustrated circular showing our new designs.



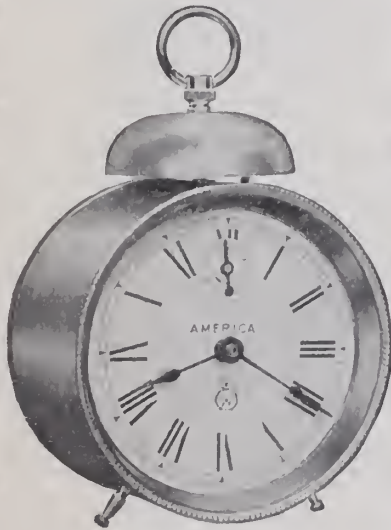

**J. C. DOWD & CO.** 524 @ 528 Broadway  
NEW YORK



A good many dealers like their own names on America Alarm dials—it's a standing "ad." that somebody else pays for.

Ask your jobber or write us about this.

The Western Clock Mfg. Co.  
LA SALLE, ILL.

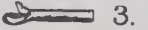
-  1. Snap complete.
-  2. Outside of Snap.
-  3. Inside of Snap.

**The E. P. H. Patent  
NON-PULL-OUT  
Neck Chain Snap**

is a patented snap that insures the wearer against loss of

**CHAIN or CHARM**  
for it positively will not pull out

Made in 10 and 14 Karat Gold and in Gold Filled.

Can be had of the following Wholesale Selling Agents:

- Messrs. W. Green & Co.,  
81 Nassau St., New York.  
M. Sickles & Sons, Philadelphia  
E. A. Cowan & Co., Boston  
E. & J. Swigart, Cincinnati  
Swartchild & Co., Chicago  
Nordman Brothers, San Francisco  
Leonard Krower, New Orleans  
Bauman-Massa Jewelry Co., St. Louis

**PRICES.**

- 14 Karat—Small, \$7 per doz. net  
Large, \$7.50 per doz. net
- 10 Karat—Small, \$6 per doz. net  
Large, \$6.50 per doz. net
- Gold Filled—Small, \$2 per doz. net  
Large, \$2.25 per doz. net

**"Perfect Yourself"**

In ENGRAVING and EXPERT WATCH WORK.  
Take a Post-Graduate Course.

**RIES & ARMSTRONG, Macon, Ga.**

**Encyclopedia-Dictionary**

and reference hand-book of the Ophthalmic Sciences.  
Price, \$2.50.

The Jewelers' Circular Pub. Co., 11 John St., N. Y.



**C. L. Guinand  
Split Chronographs  
with Minute Registers**

**The Turfman's Standard.**

Remarkable for accuracy and reliability. Are cased in Gun Metal, Silver filled and Gold. Prices reasonable.

Imported exclusively by

**Jules Racine & Co.,**

Importers of all grades of Watches and Movements.

103 State Street, Chicago. 37 Maiden Lane, New York.

**Unique Gems**

and Semi-Precious Stones

Many fine gems occur as water worn pebbles. These, when polished natural or drilled and polished as beads, form a decided novelty of great beauty and infinite variety of colors, and can be had in

- Carneian
- Chrysoptase
- Jasper
- Agate
- Topaz
- Lapis Lazuli
- Rose Quartz
- Malachite
- Amethyst

Tourmaline and many other stones. Emerald Matrix

Adapted especially for neck chains, hoop pendants, La Vallieres, scarfpins, link and buttons, and for any of the newer forms of art jewelry. Prices reasonable; no imitations.

Sample papers sent to responsible jewelers

**LOUIS J. DEACON, Atlantic City**  
During Summer Months, Cape May, N. J.

ctions between said casing and frame for swing-  
e said frame into operative position when said  
ing is opened.

DESIGNS.

4,032. BUTTON MABEL LEORA EVANS and  
PAUL H. LINDNER Chicago. Filed March 19,



1906 Serial No. 306,934. Term of patent  
14 years.

4,033. BADGE. FREDERICK BUSST New York



Filed April 16, 1906. Serial No. 312,037  
Term of patent 7 years.

4,034. CLOCK FRAME. STANLEY M. LAWSON,

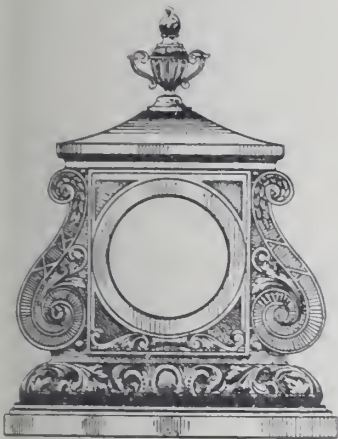

Cincinnati, O. Filed April 11, 1906. Serial  
No. 311,199. Term of patent 3½ years.

4,036. PLATE OR SIMILAR ARTICLE.  
WILLIAM H. GRINDLEY, Barlaston, England,



assignor to William S. Pitcairn, New York.  
Filed April 4, 1906. Serial No. 309,946.  
Term of patent 3½ years.

UNITED STATES PATENTS THAT  
HAVE EXPIRED.

[Reported especially for THE JEWELERS' CIR-  
CLAR-WEEKLY by R. W. Bishop, Patent Attorney,  
Washington, D. C.]

Issued June 4, 1889.

4,385. CUTLERY. RICHARD DAINE, Halifax,  
Canada.

4,406. BUCKLE. R. G. HENRY, Waterbury,  
and R. L. HENRY, Hamden, Conn.

4,539. INKSTAND. I. W. HEYSINGER, Phila-  
delphia, Pa.

4,584. TICKET AND STAMP HOLDER.  
ALFRED WILLIAMSON, Concord, N. H.

4,631. CHAIN-FASTENER. H. E. KELLEY,

Niagara Falls, N. Y., assignor to the Oneida  
Community, Ltd., Community, N. Y.

404,632. SWIVEL. H. E. KELLEY, Niagara  
Falls, N. Y., assignor to the Oneida Commu-  
nity, Ltd., Community, N. Y.

404,659. SWIVEL. J. F. SPIARS, Clifton,  
Canada, and H. E. KELLEY, Niagara Falls,  
N. Y., assignors to the Oneida Community,  
Ltd., Community, N. Y.

404,661. CURLING IRON. B. L. TOULFE, West-  
port, Conn.

404,495. UMBRELLA. F. S. EVANS, Washing-  
ton, D. C., assignor of one-fourth to A. B.  
Browne, same place.

404,707. COFFEE POT. F. A. HOVEY, Farming-  
ton Falls, assignor of one half to Herbert  
Elwell, East Wilton, Me.

404,721. POCKET-BOOK FRAME. LOUIS MES-  
SER, New York.

404,777. FORK-GUARD. R. B. B. CLAYTON,  
London, England.

404,803. TRIAL-FRAME FOR OCULISTS. A.  
L. SMITH, Geneva, N. Y., assignor to the  
Geneva Optical Co., same place.  
Design issued May 31, 1892, for 14 years.

24,589. SPONGE CUP. J. G. BAINBRIDGE Phila-  
delphia, Pa.  
Designs issued June 6, 1899, for 7 years.

30,934. EYEGLASS CASE. H. E. GUYER, Phila-  
delphia, Pa.

30,935. COMMUNION CUP FILLER. E. W.  
RYAN, Ypsilanti, Mich.

BRITISH PATENTS.

(ABRIDGMENTS OF SPECIFICATIONS, 1905, FROM THE  
Illustrated Official Journal.)

ISSUE OF MAY 16, 1906 (CONTINUED.)

1,178. SAFETY-PINS, ETC. R. L. ANTROBUS,  
Birmingham. Jan. 21.

A fastening for safety-pins and brooches con-  
sists of a hinged catch 13, which locks the pin

FIG. 2.



underneath a projecting part 12 formed on the  
coil 10 at the end of the fixer member 7. The  
catch has a circular part 13 which snaps into the  
central aperture of the coil 10.

1,179. SAFETY-PINS, ETC. R. L. ANTROBUS  
Birmingham. Jan. 21.

Fastenings for safety-pins and brooches consist  
of a circular slide 12 having a projection 13 which

FIG. 4.



locks the pin in a recess 16. The slide is operated  
by a spring contained in the circular tubular part  
10 and by a finger-piece 17.

ISSUE OF MAY 23, 1906.

1,277. WATCHES. G. HAUSLER, Hanover, Ger-  
many. Jan. 23.

Bows and Pendants. Capsules a having flanges  
b are provided for the tenons d of the bow e.  
These capsules may be pierced to pass the screw-  
pins g, or a single screw, and may screw into the  
pendant, their interiors being made square to allow

FIG. 1

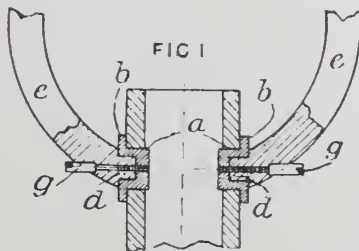

the use of a male-key, or the flanges being made  
angular to take a spanner. In a modification, the  
capsule is fluted and is forced in.

1,264. PENDANTS, LOCKETS, ETC. E. W.  
GOODE, Birmingham. Jan. 23.

A pendant intended to enclose a miniature or

the like, or to be used as a fastening for a brace-  
let, necklace, or the like, etc., consists of two sym-  
metrical parts which engage and are secured to-

FIG. 5.

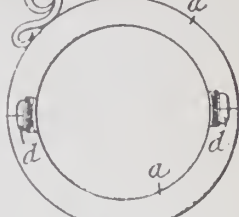

FIG. 6.

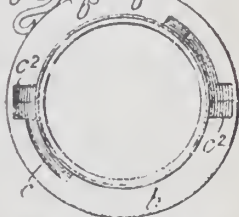

FIG. 7.

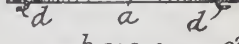

FIG. 8.

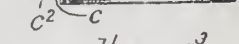
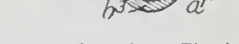

FIG. 9.



gether by means of catches. The half parts are  
shown separately as a and b, Figs. 5, 6, 7, 8. They  
are provided with flanges shown in Figs. 7, 8,  
which fit together when the parts are connected.  
The attachment is made primarily by the stops  
d, Figs. 5, 7, engaging in the slots c, c², Figs. 6,  
8, a rotary motion being given to the parts, and  
completed by the closing of the catch a³, b³, Fig.  
9, which connects the rings a¹, b¹.

1,615. BRUSHES. S. SIMON, London, E. C.  
Jan. 27.

Clothes Brushes.—The main body A of a combi-  
nation brush is formed with a recess B, which  
extends through the greater part of the brush,  
into which a second narrow brush C is arranged  
to slide. The combination may be used as a whole,  
or the narrow brush may be withdrawn for sep-

FIG. 2.



FIG. 3.



arate use. Strips B¹ are secured to the main body  
A and correspond with slots in the brush C to  
guide it and to retain it laterally. The brush  
is secured endways by a catch D² pivoted on the  
handle, which is integral with the narrow brush  
C. The two parallel arms D³ engage slots in the  
guide-strips B¹, and are normally held in en-  
gagement by a spring D⁴. The back A may be  
veneered, and a strip of velvet may be attached  
to the back C. Instead of guide-strips B¹ being  
provided, the recess B and brush C may be dove-  
tailed.

1,279. CALLIPER GAUGES. E. STUBBS, Cov-  
entry, Warwickshire. Jan. 23.

One contact of a calliper gauge is formed by a  
movable nose, connected by multiplying levers with  
a needle which indicates divergences of articles  
measured from a standard size. In one form,  
Fig. 5, the contact nose D forms part of a lever  
C², pivoted on one of two heads T, T¹, which  
slide on a graduated bar S. The lever C² is acted  
on by a spring G¹, and its long arm engages the

# Koshland & Italic Co.

702 Chestnut Street, PHILADELPHIA, PA.

¶ The BEST is none too good for you or your customers.

¶ We handle the best goods made in our line.

Diamonds, Watches and Jewelry

# LOCKETS

WE ARE  
LOCKET  
SPECIALISTS

FOR THE  
JOBING  
TRADE  
EXCLUSIVELY



THE GOLF  
GIRL

illustrates one of a hundred and more designs. Made in 3 sizes.

S. & B. L.  
★  
CO.

Every Locket stamped on inside with

Insist on this Trade-Mark

MADE IN HIGHEST GRADE GOLD FILLED ONLY

Ask your jobber, or send for a selection

Manufactured only by

## S. & B. LEDERER CO.

NEW YORK SALESROOM  
9-11 Maiden Lane

Providence, R. I.

CHICAGO  
131 Wabash Avenue

The Latest Importation in Watches is this

# Ring Watch



THE  
MOVEMENT  
IS  
Smaller Than  
a Ten-Cent  
Piece.

ONE OF THE MANY EXCLUSIVE NOVELTIES THAT WE MAKE A SPECIALTY OF.

Our reputation for carrying the most exclusive novelties in imported watches is well known to the Jewelry Trade.

Write us immediately for information if interested in the new season's offerings.

**KLIPPER BROS.,** 59 Maiden Lane, NEW YORK.

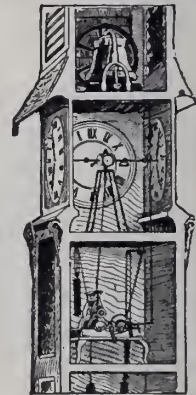

MAKERS OF

# Tower and Street Clocks

For particulars write us, mentioning The Jewelers' Circular-Week

**E. HOWARD CLOCK CO.,**  
EST. 1842. BOSTON, MASS., U. S.

## CRANBERRY LAKE REGION OF THE ADIRONDACK MOUNTAINS

a section full of large fish is described in New York Central Lines Four-Track Series No. 32, which contains a beautiful map of this region printed in four colors. Copy will be sent free, postpaid, on receipt of a two-cent stamp by George H. Daniels, Manager, General Advertising Department, Room 61-A, Grand Central Station, New York.

THE



TAKE YOU TO THIS REGION FROM EVERY DIRECTION

C. F. DALY  
Passenger Traffic Mgr.  
New York

W. J. LYNCH  
Passenger Traffic Mgr.  
CHICAGO

slit arm of a pointer E<sup>1</sup> moving over a scale B callipers, the lever C<sup>2</sup> is replaced by a lever C<sup>1</sup> to pass along the calliper leg, and having a short arm engaged by a spring plunger, which forms the contact nose. Fig. 3 is an end view of internal callipers inserted in a tube to be measured. Two contacts are formed by the ends of a cross-pin K fixed in one leg J, the third by a contact arm M of a bell-crank lever M<sup>1</sup>, pivoted to the other leg. The long arm of the bell-crank lever M<sup>1</sup> bears against an arm O, fixed to a spindle O<sup>1</sup> which passes along the calliper leg and

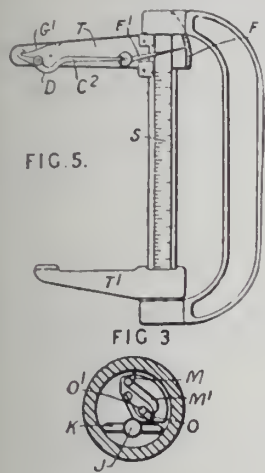

terminates at its end a pointer (not shown) moving in front of a scale. By turning the pointer the contact M is depressed and permits of the insertion of the callipers in the tube. A spring acting on the arm O causes the contact M to be pressed downwards again.

Complete specifications accepted May 16, 1906.

- 1,121. TEA OR COFFEE POT. Wood & Capper.
- 1,104. TIME-CHECK CLOCK. POPOFF & SIMONOFF.
- 1,605. MATCH BOX. HAYDOCK.
- 1,485. TIME-CHECKING APPARATUS. WES.
- 1,253. SAFETY-CATCH FOR BROOCHES. WEBER.

Applications filed May 7 to May 12, 1906.

- 1,623. COMBINED BROOCH AND WATCH SUSPENDER. ARTHUR HARROP, Birmingham.
- 1,631. ALARM CLOCK. A. V. PATTERSON, Lisbon, Portugal. Complete specification.
- 1,659. ALARM WATCH. C. L. FAIVRE, London. Complete specification.
- 1,709. HAIR-PIN. F. W. SCHMETZER, London. Complete specification.
- 1,720. HAT FASTENER. EDWIN AMIES, Chiswick, London.
- 1,787. SOLAR TIME INDICATOR. G. J. GIBBS, Liverpool.
- 1,833. PERSONAL WEAR ORNAMENT. ARTHUR BEVIS, Birmingham.
- 1,837. FORKS, SPOONS, ETC. R. F. BATEY, Manchester.
- 1,856. HAT PIN. GRACE HUTCHINSON, London.
- 1,909. TABLE KNIFE. J. E. GILLOTT, Sheffield.
- 1,944. MATCH BOX, CIGAR CASE, ETC. WILLIAM LIGHT, Birmingham.
- 1,109. CRUMB TRAY. S. M. HOLLICK, Manchester.
- 1,057. BRACELETS, ETC. ARTHUR HARROP, Birmingham.
- 1,156. TEAPOF. NILS THESTRUP, London.

Ben. F. Harless, 501½ Main St., Houston, Tex., has added a watch repairing feature to his business, with H. Seffer in charge.  
P. J. Koke, 145 Monroe St., Grand Rapids, Mich., was not in New York, as stated in a recent issue, but the visitor was his brother, J. Koke.

UNITED STATES TRADE-MARKS.

[The following trade-marks have been adjudged entitled to registration under the Act of Feb. 20, 1905, and are published by the Patent Office in compliance with Sec. 6, of said act, which provides: "Any person who believes he would be damaged by the registration of a mark may oppose the same by filing notice of opposition, stating the grounds therefor, in the Patent Office, within 30 days after the publication of the mark sought to be registered, which said notice of opposition shall be verified by the person filing the same before one of the officers mentioned in Sec. 2, of this act. If no notice of opposition is filed within said time the Commissioner shall issue a certificate of registration therefor, as hereinafter provided for."]

PUBLISHED MAY 29, 1906

SER. No. 2,322. GOLD-FILLED WATCH CASES AND WATCH MOVEMENTS. RODE WATCH Co., New York. Filed April 20, 1905.

R.W.C. Co.

The letters and character "R. W. Co."

SER. No. 7,111. SILVER HOLLOW WARE, FLAT WARE AND TABLE WARE. THE AMERICAN SILVER Co., Bristol, Conn. Filed May 31, 1905.



1857 appears at the top and "WORLD BRAND" at the bottom. Between these appear a crossed knife, fork and spoon supporting the world on which world appear the words STANDARD OF THE WORLD.  
SER. No. 11,877. FOUNTAIN-PENS. S. L. KISER & Co., Indianapolis, Ind. Filed Aug. 21, 1905.

MERIDIAN

The word "MERIDIAN."

SER. No. 13,166. WATCHES. JAMES B. ABERNETHY, Clarksdale, Miss. Filed Sept. 30, 1905.



The representation of a watch and the figure of a man standing upon the face of the same, one hand grasping the handle of a sledge or hammer, and the other being extended and supporting a watch.

SER. No. 16,443. SILVER AND SILVER-PLATED HOLLOW AND FLAT WARE. KOEHLIN & ENGELHARDT, Newark, N. J. Filed Jan. 19, 1906.



The monogram composed of the letters "K" and "E."

SER. No. 16,956. SILVER AND PLATED KNIVES, FORKS, SPOONS, CRUET-FRAMES, TEA AND OTHER LIKE POTS, JUGS, CREAM, SUGAR, AND OTHER LIKE BASINS, WAITERS, SHIELDS, AND SILVER AND PLATED WARE OF ALL KINDS. WM. HUTTON & SONS, LTD., Sheffield, England. Filed Feb. 12, 1906. Used 10 years.



The representation of eight arrows crossed.

SER. No. 17,303. ORNAMENTAL CHAINS AND PARTS THEREOF AND ATTACHMENTS THEREFOR. ANNIE M. HALE and EDWIN E. HALE, North Attleboro, Mass., executors of the estate of Oscar M. Draper. Filed Feb. 23, 1906.

O. M. D.

The letters "O. M. D."

SER. No. 17,304. PLATED CHAINS AND BRACELETS. ANNIE M. HALE and EDWIN E. HALE, North Attleboro, Mass., executors of the estate of Oscar M. Draper, deceased. Filed Feb. 23, 1906.

PREMIER

The word "PREMIER."

TRADE-MARKS REGISTERED MAY 29, 1906.

53,109. EARTHENWARE. WARWICK CHINA Co., Wheeling, W. Va.

A representation of a helmet with two crossed swords underneath, a scroll crossing the swords at the point of intersection, associated with the word "logy," the word "WARWICK" being shown upon the scroll.

Filed July 12, 1905. Serial No. 10,194. Published April 3, 1906.

53,110. SILVER TABLE-CUTLERY. CURTIN & CLARK HARDWARE Co., St. Joseph, Mo.

Four letters "C" arranged in a horizontal line, the second letter inclosing the third.

Filed May 2, 1905. Serial No. 4,030. Published April 3, 1906.

53,210. COMBS. DR. HEINRICH TRAUN & SOHNE, Hamburg, Germany.

The word "SANTAS."  
Filed July 21, 1905. Serial No. 10,676. Published April 3, 1906.

53,211. COMBS. DR. HEINRICH TRAUN & SOHNE, Hamburg, Germany.

The word "REVELATION."  
Filed July 21, 1905. Serial No. 10,679. Published April 3, 1906.

Further Information on Reducing and Raising Gold Alloys.

CHICAGO, ILL., May 30, 1906.

Editor THE JEWELERS' CIRCULAR—WEEKLY—

Referring to the question of alloys, you published a rule by D. R. D., the very best ever. To reduce, multiply the weight by the difference between present quality and desired quality and divide this sum by the karat wanted. Example:—Reduce 24 kt. to 15 kt., say 100 dwt.  $100 \times 9 = 900 \div 9 = 60$  dwts. of alloy; total, 160 dwts., 15 kt.

To raise: Multiply weight by difference in the karat, divide by difference between karat wanted and 24 kt. Example: Raise 100 dwts., 10 kt. to 18 kt. Difference  $8 \times 100 = 800 \div 6$  (difference between karat wanted and 24 kt.) = 133.33 dwts. fine gold = 233½ dwts. 18 kt.

SUBSCRIBER.

Ivan H. Gray's store in Parker's Prairie, Minn., was burned out with a loss of \$1,000 to \$1,500.

# WALTHAM WATCHES

---

We beg to announce the issuing of the following described 16 size movements

16 SIZE,  $\frac{3}{4}$  PLATE, S. W. MOVEMENTS

LEVER SETTING

OPEN FACE

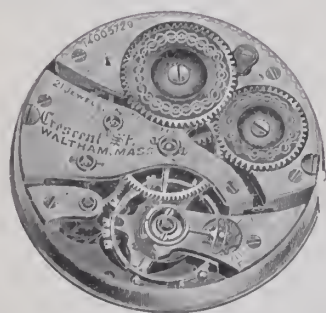

Crescent St., Nickel;

21 Fine Ruby Jewels; Raised Gold Settings; Jewel Pin Set without Shellac; Double Roller Escapement; Steel Escape Wheel; Exposed Sapphire Pallets; Compensating Balance, Adjusted to Temperature, Isochronism and Five Positions; Patent Breguet Hairspring, Hardened and Tempered in Form; Patent Micrometric Regulator; Tempered Steel Safety Barrel; Exposed Winding Wheels; Double Sunk Dial.

---

**AMERICAN WALTHAM WATCH CO.,**  
**WALTHAM, MASS.**



# THE HOROLOGICAL REVIEW.



## Ancient and Modern Time Measuring Devices.

A Lecture Delivered by C. T. HIGGINBOTHAM Before the American Horological Society, Chicago.

In that standard work of reference, "The Encyclopædia Britannica," may be found pages devoted to astronomy and several pages to the (so-called) science, astrology, the superstition with which astronomy was for so long a time encumbered—but you will look in vain for a single line on the subject of horology; yet horology has equal claims with astronomy both to antiquity and to importance. Astronomy and hor-

ology are twin sciences, the oldest in the world. They are co-eval with the advent of the human race. The cave dweller of the stone age must necessarily have observed the passage of the great orb of day across the heavens. He must have taken note of the phases of the moon; its waxing and waning at regular intervals, the constantly changing obliquity of the sun and planets to the zenith. He must have observed the varying length and direction of shadows cast by the sun from rocks and trees, and the intelligence that enabled him to fashion a stone hatchet would prompt him by these natural phenomena to divide time into the equivalents of years, months, days and shorter periods, and to this extent, at least, he came both an astronomer and horologist. These two sciences have ever been connected as closely as Siamese twins, their very existence dependent one upon the other, together they have come up through the

ages contributing their wealth of benefit to the progress of the world. Horology has ever kept pace with advancing civilization in providing time measuring instruments to meet the requirements of the age, as these requirements became

the manner determines his exact position on the broad ocean by means of his chronometer and magnetic compass, and by them is enabled to direct the course of his vessel to the desired port.

A school boy asked by his teacher to explain what salt is, said: "It is the stuff that makes potatoes taste bad if you don't put any of it on them." Following out the same course of reasoning, he might have defined a watch as a thing that made railway accidents when it went wrong, or a chronometer as an affair that made ship wrecks when it stopped. Picture to yourself what a calamity it would be to the human race if every timepiece in the world should

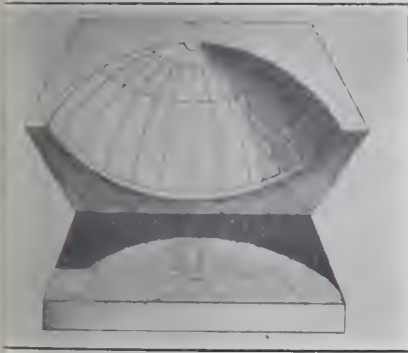

FIG. 1.

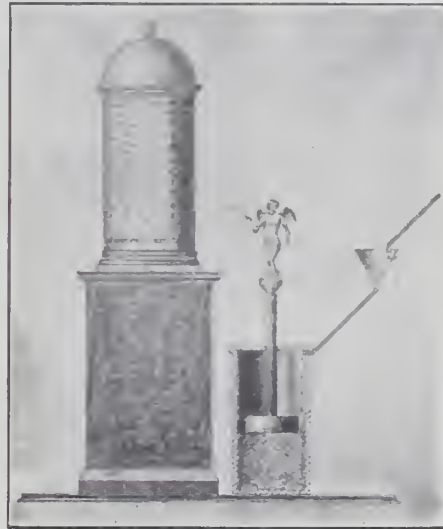

FIG. 2.

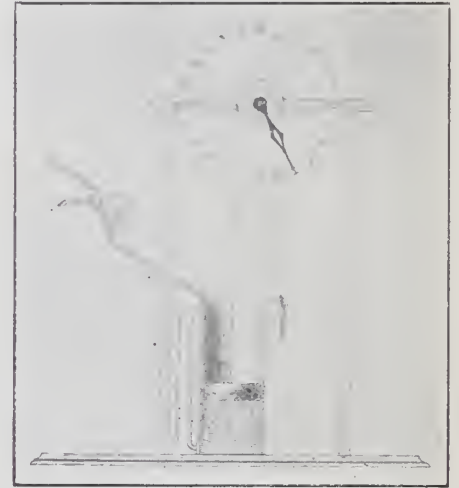

FIG. 3.

more and more exacting. To-day timepieces are a household necessity and an indispensable adjunct to every industry, business, profession and science. The astronomer finds his astronomical clock necessary to aid him in determining the distance and size of the heavenly bodies and other phenomena of the universe; the chemist, to time his delicate experiments; the physician, watch in hand, counts the pulse beats of his patient; the banker, as he closes the ponderous doors of his vault at the close of the day's business, does so in perfect confidence that the faithful time clock within will release the bolts at the proper moment for the resumption of the following day's business; the locomotive engineer regulates the speed of his train with its precious burden of human freight;

suddenly be destroyed. Business and travel would be paralyzed; chaos would reign. In following out the development of time measuring instruments I shall not attempt to place the numerous improvements and inventions in their chronological order; indeed, this would be impossible, as many of the landmarks have been lost and dates and authors of some of the most important discoveries are matters of dispute. I shall therefore mention the principal ones in their natural and probable sequence, using dates only where such dates have been indisputably established. The first device used for the division of the day into shorter periods was undoubtedly the sundial. It is reasonable to assume that the shadows cast by the sun from natural objects would suggest the placing of a post in the ground or the erection of a

suddenly be destroyed. Business and travel would be paralyzed; chaos would reign.

In following out the development of time measuring instruments I shall not attempt to place the numerous improvements and inventions in their chronological order; indeed, this would be impossible, as many of the landmarks have been lost and dates and authors of some of the most important discoveries are matters of dispute. I shall therefore mention the principal ones in their natural and probable sequence, using dates only where such dates have been indisputably established.

The first device used for the division of the day into shorter periods was undoubtedly the sundial. It is reasonable to assume that the shadows cast by the sun from natural objects would suggest the placing of a post in the ground or the erection of a

# The Balance of Business

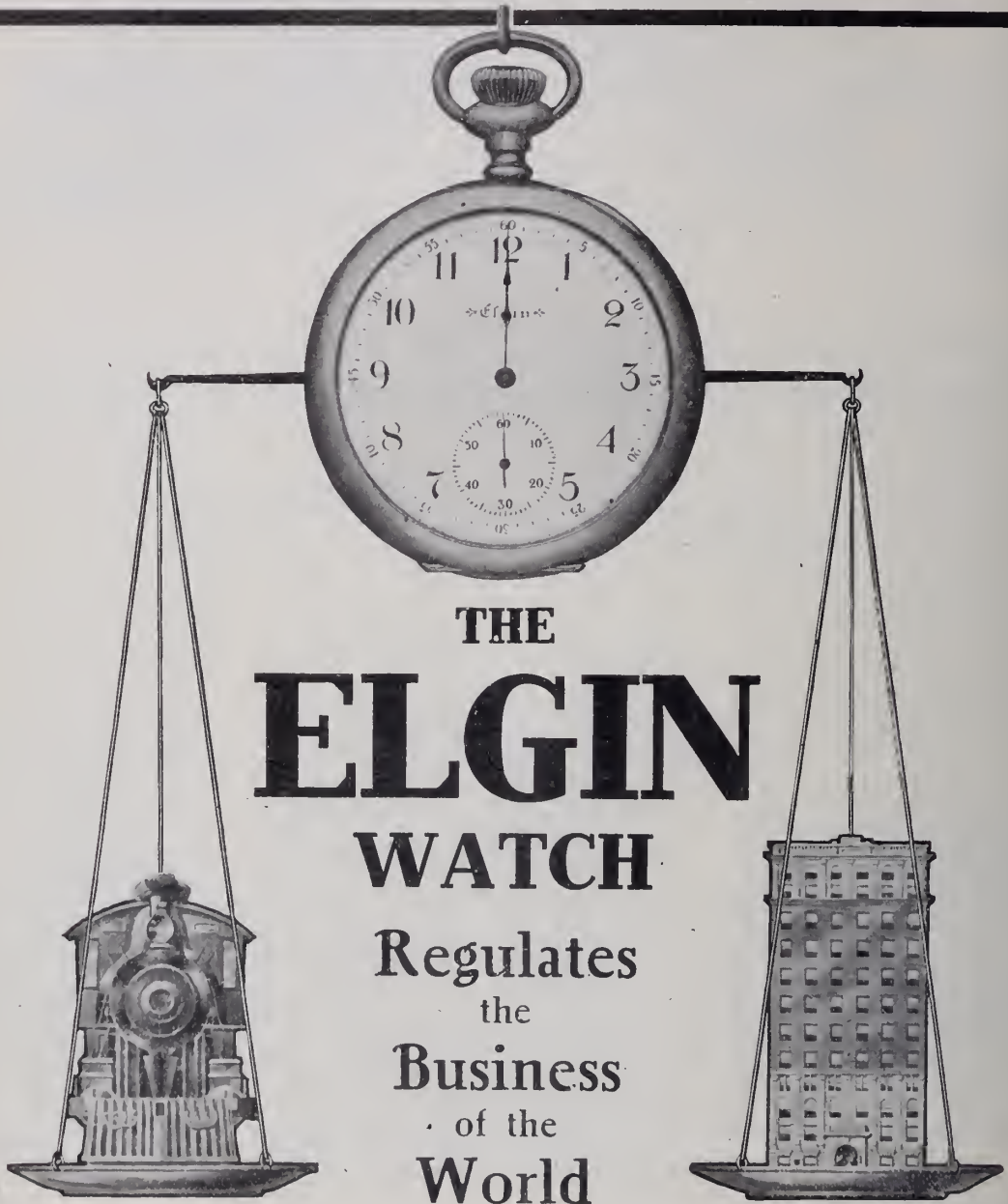

THE  
**ELGIN**  
 WATCH  
 Regulates  
 the  
 Business  
 of the  
 World

Indispensable to modern life, the Elgin Watch is ever in increasing demand—and the balance of business goes to the store that carries a full stock of Elgin Watches.

See Jobbers' list for prices or write the Company.

Every dealer is invited to send for the Elgin Art Booklet, "Timemakers and Timekeepers," illustrating the history and development of the watch.

## ELGIN NATIONAL WATCH COMPANY

Factories, Elgin, Illinois, U. S. A.  
 General Offices, 131 Wabash Ave., Chicago.

New York Office, 11 John Street.  
 San Francisco Office, 206 Kearny St.

stone pillar, and in some manner, probably by marks on the adjacent ground, provide a means of noting the passage of time with sufficient accuracy to meet the simple requirements of that age. In ancient Britain stone pillars were set up surrounded by flat stones placed at intervals in a circle, the shadow from the central pillar falling on the stones serving to mark divisions of time. The Egyptian obelisks are supposed to have been used for this purpose. These and many other ancient relics serve to bear witness to this view.

The earliest mention made of a sun dial is found in the Second Book of Kings—“And Isaiah, the prophet, cried unto the king, and he brought the shadow 10 degrees backward, by which it had gone down in the dial of Ahaz.” There is no word in the Hebrew language to express dial; the word so translated meaning steps. It is



FIG. 4.

is therefore supposed that this sun dial was a series of steps possibly having a stone pillar placed in such a position that its shadow fell upon them.

The earliest definite description we have of a sun dial is that of Berossus, a famous Chaldean astronomer, who lived about 540 years before the Christian era. A representation of this dial is found in Fig. 1.

Such sun dials were introduced in Rome about 800 years before Christ. Plautus, a famous comic dramatist of that time, refers to them in the following epigram:

When I was young, no timepiece Rome supplied,  
Every fellow had his own, inside;  
A rusty horologue, that rain or shine,  
Never failed to warn him of the time to dine.  
In sturdy Romans sauntered through the forum,  
I hale, content; for trouble ne'er came o'er 'em.  
Now these cursed dials show their faces  
Over Rome, in streets and public places;  
I men to know the hour, the cold stone question  
It has no heart, no stomach, no digestion.  
By watch the creeping shadows—daily thinner  
Show themselves, impatient for their dinner.  
Give me the good old timepiece if you please,  
I found the villain who invented these.

Such sun dials have been constructed in a great variety of forms, and are in use in some of the eastern countries even at the present day, but at best they can only be used when the sun shines. At night or in cloudy weather they are useless.

The earliest instrument of which we have any record for the measurement of time independent of the earth's motion, is the clep-

sydrae. The name is of Greek derivation and refers to the stealing away of water. In the simplest form it was a vessel having a small perforation in the bottom. This vessel was filled with water, which escaped, drop by drop, the lowering surface serving to indicate the passage of time. The Malay pirates used a very simple form, a cocoanut shell with a hole in it; this was set floating on a vessel of water, and as it filled and sank an attendant immediately set it afloat again, announcing the fact by striking a bell.

To overcome the irregularity caused by the decreasing speed of the discharge as the



FIG. 5.

water lowered, two vessels were used, one above the other. The upper vessel was kept full by a constant supply of water, the overflow being carried off by a waste-way. An aperture in the bottom of this vessel discharged the water, drop by drop, into the lower one, which was marked with graduations.

Then followed another improvement—a float bearing a figure pointing to a column was added (see Fig. 2). This column was provided with graduations encircling it; the graduations diverging from each other, the purpose being to provide a means of regulation. By turning this column the distances between the hours could be increased or diminished, as required. This was made necessary by the fact that the general practice was to divide the periods from sunrise to sunset and from sunset to sunrise, each into 12 equal parts.

This unwieldy method acted as a deterrent influence upon invention until the method of dividing into equinoctial hours, as at the present, gave a renewed stimulus to the art. Now the graduated column and the figure pointing to it were abandoned; a cord was attached to the float (see Fig. 3). This passed over a pulley, the free end of the cord being provided with a small weight. The arbor of this pulley carried a hand pointing to the hours on a circular dial. Then a means of automatically emptying the water vessel by the addition of a syphon, as shown, was added; the water rising to the top charged the syphon; the vessel quickly emptied itself, and the hand returned to the starting point. “There is nothing new under the sun” is a familiar saying. This is an exemplification. Here we have a self-winding clock; in fact, I am disposed to regard the clock more in the nature of an evolution than an invention.

The next important step was to substitute a straight toothed rack gearing into a wheel on the arbor for the cord and pulley. It now remained to replace the rising water by a descending weight and to provide a regulating device to control its motion to make the evolution of the clock complete. The first device of this kind was a wheel having pins set in its face, the pins acting on a pair of pallets, as in the verge escapement. The arbor carrying the pallets was provided with cross arms bearing small weights, the whole suspended by a cord which, twisting and untwisting, served to control its vibrations. By moving these weights to or from the center an approxi-

mation of uniformity of vibrations was secured.

The pendulum was the discovery of Galileo in 1582, but, strange to say, was not applied to clocks until half a century later. Now teeth were formed on the periphery of the escape wheel and pallets used to impart swing to the pendulum. The Graham dead-beat escapement in present use is the perfection of this device. Later, about 1700, Harrison invented the mercurial pendulum.

Portable timepieces were introduced about 400 years ago. The invention is attributed to Peter Henlein, of Nurnburg. The coiled spring as a motive power was applied and an attempt made to control its varying force by a device called the “Stack freed,” a small cam, acted upon by a spring. These watches, however, were little better than mechanical toys, incapable of more than an



FIG. 6.

approximation to correct time. The fusee was invented in 1525. This greatly improved the time keeping quality of watches, but they were still sadly deficient in this respect, there being no better means known than a piece of catgut to control the motions of the balance. An incident related of King Charles V. is an illustration of this. After abdicating his throne he retired to the monastery of St. Juste, where he spent much of his time experimenting with watches. One day, while seated in his apartment with a number on his table, a careless monk entered and awkwardly overturned it, throwing them to the floor. The abashed cleric was aghast expecting a reprimand, but the monarch good naturedly put him at his ease by saying: “There, I have been trying for months to make all these watches go together, and now you did it in an instant.”

The invention of the hairspring about 1675 was a great stride toward perfection, and now followed in rapid succession many valuable inventions: the fusee chain, dial work and minute hand, the maintaining power, the lever escapement, the chronometer escapement, the compensation balance and many others. One of the most remarkable achievements was the invention of John Harrison in 1692. The British Government offered a prize of £20,000 for a timepiece which, after a voyage to and from the West Indies, would enable longitude to be determined within half a

# THE PUBLIC IS “MUCK RAKING”

Just at present the great American people are in the “Muck-Raking” mood.

They are pondering over the trusts—busy figuring out how and why they pay too much for things.

The public is thinking this about the cost of watches, Mr. Jeweler—and, as a matter of fact, many people are every day finding out that there *is* a point in the price of watches where real watch-service—real time-keeping quality ends.

Our jewelers’ sales form a good criterion to this increasing public watch-wisdom, and they show enormous increases for the

## New England

### The Watch for the Great American People

We are helping this public awakening all we can—with *advertising*. We’re talking to the public about watch-cost and real watch-service. This Fall we will tell the New England Watch story to one-third of the entire population of the United States.

Now, Mr. Jeweler, thousands of people are going to be convinced—are now convinced that they want a New England Watch. These people are writing us by thousands. But we don’t sell to these people direct. These sales are made wholly through the nearest jeweler who sells our line.

Do you want your share of these sales? Some of your customers are writing us. Some of your competitors’ customers are writing us. May we send them into *your* store to buy?

Then write us for details of our plan. Learn how we are planning, with an enormous advertising expenditure, to create Fall and Holiday business for you.

**THE JEWELER WHO HANDLES NEW ENGLAND WATCHES  
IS GOING TO HAVE THE LEAD DURING THIS FALL AND  
THIS CHRISTMAS SEASON. OUR NATIONAL PUBLICITY  
WILL STIR UP THE TRADE.**

Let us be partners and co-operate with you. Write us now for details of how we are planning to work *with you and for you*.

Address

DEPARTMENT OF PUBLICITY

**New England Watch Company**  
**WATERBURY, CONN.**

eg. This means a variation not to exceed two minutes. Mr. Harrison took the watch apart and when we consider that the common balance had not been invented at the same time, but that he had no better means of correcting errors than a compensation spring carrying the regulator pins, the pertinence of his instrument was truly remarkable.

We will now take up the watchmaking industry in America, on what is known as the interchangeable plan. This method is little more than half a century old. Its difficulties had to be overcome; success was achieved only after a long series of failures and disasters. No company engaged in this enterprise has been exempt in its seasons of adversity, its vicissitudes. The original stockholders rarely did anything from their investment; it was only after reorganization, which often wiped out the original stock, that dividends were paid. The road to success may be paved by many a bleaching skeleton of the business concerns that have succumbed. We mention this fact because there is just a movement on foot to modify or reduce the tariff on watches. I say, without any successful contradiction, that any partial reduction of the protective tariff will bring inevitable disaster to an industry that has been of inestimable benefit to the country and would throw thousands of well-paid mechanics out of employment. In all our boasted automatic machinery and perfect system there is too wide a difference between the value of American labor and foreign labor to enable us to successfully compete with the latter.

Previous to the commencement of watchmaking on the interchangeable plan, a few watches were made to manufacture by the dry method. Luther Goddard, of Northbury, Mass., commenced their manufacture in 1809. He imported what is known as the "roughs" from England; that is, plates and trains; also the balances, and cases, devoting himself to finishing and assembling the parts. He continued the business for eight years, producing about 100 watches, when he failed from inability to compete with the imported article. The Curtis Bros., of Hartford, Conn., in 1836 commenced the manufacture of watches, using their own machinery for this purpose. The tools were very crude, as was the product. They used lantern pinions and roughly finished parts like a Yankee watch. They made about 800 and then failed for the same reason that Goddard did.

In 1851 A. L. Dennison, a Boston watchmaker, conceived the idea of making watches on the interchangeable plan. He invited Edward Howard, a clock and watchmaker, in the enterprise, and together they went in search of moneyed men willing to engage in the venture. Addressing a number of capitalists, Mr. Dennison said: "I believe, gentlemen, the time will come when a single American factory will produce 50 watches a day." This was considered so far a flight of imagination that he was afterwards dubbed "The Boston lunatic." An instance is related of P. S. Bartlett, a German long identified with the watch industry. Mr. Bartlett came from a little town in New Hampshire, where he learned the trade. After he had entered the service

of the American Watch Co. he revisited his old employer, and the following conversation in substance took place:

"Well, Bartlett, what are you doing now?"

"Oh, I'm with the American Watch Co."

"What are they doing?"

"Making watches."

"You don't say so. How many are they making?"

"About eight a day."

"Eight a day? Good heavens, man, you'll flood the country."

Flood the country with eight watches a day! The industry has grown so far beyond the wildest dreams of its originators that the combined output of American factories is now 12,000 a day. A watch is turned out every three seconds.

Wonderful changes have taken place in the manner of manufacture and the cost to customers reduced to one-fifth. By the old method, when a new model was devised, the watchmaker made it laboriously by hand. After testing and perfecting it was taken to pieces and the parts sent to the machine shop, where the measurements were taken and the tools built to reproduce them. Then a few were assembled and tried. Errors were corrected and another small lot put together; so on until pronounced correct, when the manufacture in quantities was begun. All that is changed. The construction of a watch is now a matter of mathematical calculation. Everything is determined before hand; the distances of the wheels and pinions, their size, the forms of the teeth and leaves, the shape of the cutters and other small tools, in fact, the minutest details, even to the strength of the mainspring and weight of the balance. Drawings are made on a very much enlarged scale, and all measurements not only made accurately to scale, but the figures added; the most important parts being calculated to the ten-thousandths of an inch.

Forty years ago it cost to engrave the trade-mark, the number and the scrolling about 25 cents per watch; now it is done by stamps at a fraction of that amount, and the work is much superior for the reason that the highest skill obtainable is secured to make these stamps. The painting of the dials was all done by hand, one figure at a time. Now dials are printed as a card printer does cards. The labor cost of Breguet springing a watch used to be \$2. That process is now subdivided into not less than seven distinct operations, and so on through all stages.

In an American factory nearly every employe is a specialist, performing but a single operation, of which there is a great multiplicity. The term watchmaker is rarely used; we say, balance truer, spring truer, banker, finisher and so on, each term expressing a trade by itself. We have a class of operatives known as "all-round" men whose skill covers all branches of assembling. These operatives are used for "hospital work"; that is repairs. Adjusters are also required to be adepts in all branches.

A brief review of the assembling operations may be interesting. The watch comes into the finishing room with all the parts complete, ready to assemble, the trains and escapements jeweled and the plates finished. It first goes to the steel fitter, who

fits the mainspring and barrel arbor as well as some other parts located between the plates. Then it goes to the trainer, who assembles the train; then to the stem fitter, who fits the stem work; then to the banker, who adjusts the escapement. The balance is then taken out and sent to the balance-truer, who cuts, trues and poises it. From there to the spring-truer, who trues the hairspring, which had previously been "Bregueted." The watch has in the meantime been to the dialer, who fits the dial and hands. It is now ready for the finisher, who centers, circles and levels the hairspring, seeing that the motion is up to standard. Finally it is sent to the timing room, where it is brought to time and run at least 18 hours. If it is an adjusted watch it goes to the adjuster. The first operation of adjusting is temperature—compensation.

It may not be generally understood that there is no such thing as perfect adjustment for all temperatures. The reason for this is that the weight carried by the rim does not approach or recede from the center in a radial direction, the deflection causing it to diverge more or less. As a consequence, adjustment can only be obtained for two temperatures. A reference to Fig. 5 illustrates this. The line indicates a range of temperature from 15 degrees to 115 degrees, the mean being 65. Now it is just as easy to adjust for the extremes 15 and 115 as any other temperatures, but if we do so the variation at the mean 65 will be greater than if we select two means between, 15, 65 and 115. It is obvious that these two means are 40 and 90. By adjusting to these the error is reduced at 65 or, rather, is divided between the mean and the extremes. After adjustment to temperature the balance is taken out and re-poised. The watch is then ready for position adjustment. This is the most difficult of all operations and requires the greatest skill and patience. It sometimes consumes months. No rules can be laid down for position adjustment; of course, it is understood that the isochronism of the balance and spring must be perfect. I say balance and spring advisedly, for if the balance and spring are not properly proportioned to the motive force delivered by the escapement, permanent isochronal vibrations cannot be secured. A very slight defect in the escapement may be fatal to position adjustment. The old method of making one error correct another is not permissible in these days. No permanent close rate can be secured in this manner.

There is a disturbing influence in position adjustment that is very much underrated—magnetism. This is a force that has been much studied and written of, and yet of which but little is known. We don't even know what it is. New conditions and effects are being brought to light constantly. It used to be the belief that a piece of magnetized steel had but two poles. As a matter of fact this is very far from being the case. For instance, a hairspring magnetized will have two poles in every coil. Fig. 4 will illustrate this. The north poles will ordinarily be located on a radial line from the inner to the outer coil, and the south poles opposite. This can be readily demonstrated. Wind up a mainspring in a

For *BEAUTY* of *DESIGN*, *PERFECTION* of *FINISH* and *RELIABILITY* Combined with *Moderate Price*

# TRENTON WATCHES ARE UNEQUALLED



No. 140. Bridge Model, 16 Size, 15 Jewel, Hunting and Open-Face, Pendant Setting.

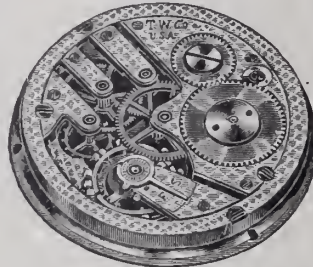

No. 320. Bridge Model, 12 Size, 7 Jewel, Hunting and Open-Face, Pendant Setting.

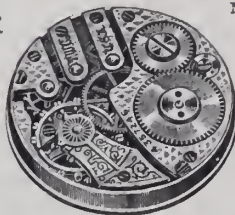

No. 100. Bridge Model, O Size, 7 Jewel, Hunting and Open-Face, Pendant Setting.

A NEAT SIGN  
OR ADVERTISING  
BOOKLET FOR  
THE ASKING

JOBBERS SELL  
TRENTONS.  
PRICE LIST ON  
APPLICATION.

Manufactured and Guaranteed by

**Trenton Watch Co., - Trenton, New Jersey.**

## SETH THOMAS CLOCK COMPANY.

Established 1813.

### EMPIRE No. 26.



Metal Case,  
GOLD PLATED  
and Lacquered.  
Beveled Plate Glass  
Front and Sides.  
Height, 14 1/4 inches.

EIGHT DAY  
HALF-HOUR STRIKE  
CATHEDRAL BELL  
4-INCH PORCELAIN  
DIAL  
List Price, \$42.50

**SETH THOMAS CLOCK COMPANY,**  
51 Maldon Lane, New York. 70 Wabash Avenue, Chicago.

IF IT'S A

# ROY

TRADE MARK  
IT'S STANDARD

ROY



ROY



ROY



O Size Bassine Engraved  
Cases, made from assayed  
Gold, quality as stamped.

**ROY WATCH CASE  
COMPANY,**

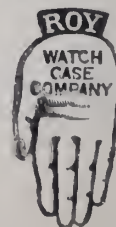

21-23 Maiden Lane  
NEW YORK.

SAN FRANCISCO  
LONDON, ENG.

be el or a wire ring, present its outer edge to strong magnet; on straightening it out al passing it before a magnetic compass d needle will be alternately attracted and rolled for every coil that it formed when magnetized. It is a well-known fact that a piece of steel once magnetized is ever after susceptible to that force. Demagnetizing by any other known means than heating it to a red heat will not remove this susceptibility.

The magnetism that causes the most trouble is not permanent magnetism, but temporary magnetism inherent in all steel. Every piece of steel, particularly if hard tempered highly, is a magnet in itself, exerting greater or less magnetic force, according to its position toward that huge magnet we inhabit—the earth. This can be readily demonstrated. Take a fair-sized piece of tempered steel (a pair of slide tongs will answer), remove the slide and bring the legs as close together

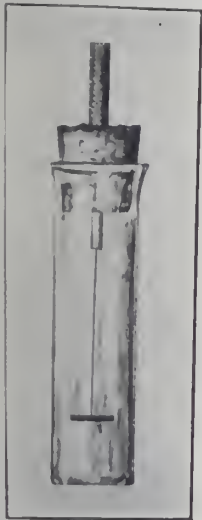

FIG. 7.

possible, securing them with brass wire string; lay it on your bench east and west, pass a compass along its side, and if it has not been permanently magnetized no perceptible influence will be manifested. Now lay it pointing north and south, and the compass will be sensibly deflected as it approaches each end. Finally set it perpendicular to the bench, and you will find the compass strongly attracted, the south pole below, the north pole above. Reverse the position of the tongs and the tongs at the poles will be as before. The south pole below, the north above. This is exactly what takes place in a watch. Its most serious effect is manifested in the escapement of a balance. (See Fig. 6.) If the watch is placed with the fork in a perpendicular position, as on the drawing, it becomes a temporary magnet; its north pole is in close proximity to the south pole of the roller. The effect of this on the vibration of the balance is precisely the same as friction—retardation. The effect it exercises on the rate of the watch will depend on the mass of the steel parts.

Before leaving the subject of magnetism I will explain how to make a very inexpensive and extremely delicate magnetic needle for detecting very slight magnetism in watches. Fig. 7 represents a small phial

about one inch long and one-fourth of an inch in diameter. Insert a brass wire through the cork, to the end attach the finest silk fiber you can obtain from floss silk, or a strand of spider web. It can be readily attached by shellac dissolved in alcohol. Let the fiber be long enough to nearly reach the bottom of the phial, and to this end attach at the middle a piece of hairspring about one-tenth of an inch long. Now magnetize it by bringing it in close proximity to a strong magnet, and you will have an extremely sensitive instrument. By holding the bottle over a balance in vibration a very slight amount of magnetism may be detected.

In concluding I desire to direct your attention for a few moments to a comparison of what has been accomplished towards the perfecting of pocket timepieces with the possibilities of the future. Let us suppose we have before us a railroad watch that has varied 30 seconds in a week and has been rejected by an inspector. Let me tell you what 30 seconds a week means. It means that out of 20,160 vibrations of the balance, it has given just one more or one less than it should. A variation of 15 seconds a month—many watches keep a closer rate—means a variation of one in every 172,800 vibrations.

This is truly a marvelous triumph of mechanical skill, but we have not reached the limit. The requirement for accuracy is becoming more and more exacting every day. Who can foretell the future? A new vehicle for the transmission of energy has been discovered. Wireless telegraphy is its demonstration. There is but little known of this mysterious agent as yet. Able minds are at work on the problem. It is slowly but surely being developed. As the clepsydrae has been superseded by the watch, so the watch may be displaced by some instrument not wholly dependent upon mechanism. It is no idle dream to anticipate that electricity may accomplish results beyond the power of mere mechanism and that the watch will be relegated to the museum as its predecessor, the clepsydrae, has been, its place being taken by a device totally different in construction and infinitely more accurate in its indications. The time may be sent continuously through the air by electric vibrations and received on a little instrument carried in the pocket which, by pressing a button, shall record it unerringly to the fraction of a second at any moment of the day or night.

#### ‘The Market for Watches in Asia.

TWO-THIRDS of all watches sold in Turkey in Asia come from Germany, but are not proving entirely satisfactory. One American firm has an agency there which orders its stock direct from the United States, thus saving the middleman's profit at Constantinople. Watches intended for that market should have the open-faced case with Arabic numerals. Alarm clocks, with the round metal case, which can be sold at from \$1 to \$2 will also find a good market there.

A German firm has succeeded in disposing of a large number of clocks having a phonograph attachment, which at certain hours plays some of the stirring Turkish airs.

#### An Interesting Clock Factory at Sanbornton, N. H., Said to be the Oldest in the State.

A LITTLE clock factory, in Sanbornton, N. H., conducted by Robert S. Johnson, stands out as a curio in the modern horological world. The building is a one-story wooden structure which has not been favored with a coat of paint for more than a generation and nestles by the side of a brook among the high hills of Sanbornton. To a stranger in this village the clock manufactory resembles an abandoned stable, while to the residents of the town and to almost every man, woman and child for miles in either direction, the old factory is something to which they point with pride and declare that this is the oldest clock factory in the Granite State.

Besides a few clocks which he made for his neighbors and one for the Quincy market, Boston, and another for the Dartmouth College observatory at Hanover, Mass., Johnson did all his business with the wholesale trade. The best clock the little factory ever turned out is one that was made many years ago and is still keeping accurate time in the office of the United States Clock Co., New York. This clock has 26 dials, each giving the time of the country which each one of the dials represents. The present annual output of this unique manufactory is about 50 grandfather clocks.

A few years ago the little stream which runs directly by the little shop, and which is known as Salmon Brook, was utilized and a small six-inch waterwheel, which is capable of supplying the plant with three horsepower, is connected with the shop's machinery, so that to-day a greater part of the work which was formerly done by hand is now done by machinery.

The shop comprises two rooms, 24 feet long and 18 feet wide. The building was formerly used as a dwelling house. It was in the room now used as a storeroom that the present owner, Robert Johnson, was born, 73 years ago.

At the recent meeting of the Astronomical Society, Toronto, Ont., R. Meldrum Stewart, M. A., read a paper on "The Time Service of the Dominion Observatory at Ottawa." The ultimate standard at the observatory is one made by Riefler, of Munich. It has a nickel-steel pendulum, is sealed up in a glass case fastened to a pillar on its own pier in a basement room, automatically regulating its temperature, and it winds itself up electrically every half minute. It keeps time with the stars, and is called a sidereal clock. The chief meantime clock, which keeps ordinary time, was also made by Riefler, and is mounted like the other. Its time is checked daily by comparison with the sidereal clock. By electrical means this clock controls a clock in each of the Government buildings, and these again actuate dials placed in each of the rooms. Four insulated wires run from the observatory to the city for this purpose. At present there are 42 dials in the Parliament building, 60 in the West block and 48 in the Langevin block. These with a few others make up a total of 214 dials. Since the first part of December a timeball has been dropped every noon on Parliament Hill, controlled automatically from the observatory.

## CONSISTENCY IN BUYING WATCHES



IT IS GOOD POLICY to buy systematically, avoiding fickleness in trade.

Find a house whose methods are in accord with your ideas and whose service is satisfactory, and then deal consistently with that house. Thus more thorough understanding is possible, mutual confidence built up, and foundation laid for ever-increasing satisfaction. Large sales of Watches are made here to Jewelers pursuing this policy.

### J. W. FORSINGER,

LEADING AMERICAN WATCHES AND MOVEMENTS

CHICAGO  
103 STATE ST.

NEW YORK  
2 MAIDEN LANE

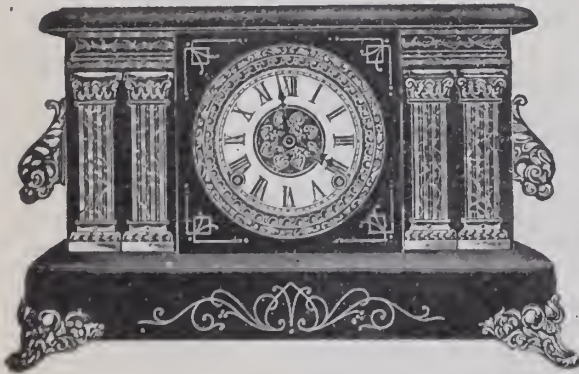

### Sessions Clocks

Superior finish. Reasonable prices.

Have you seen our

**New and Exclusive Designs**  
in Mantel and Hanging Clocks?

Write for Catalog and supplement.

**The Sessions Clock Co.**

Main Office and Factories,  
Forestville, Connecticut, U. S. A.

New York Salesrooms,  
37 Maiden Lane.



WHOLESALE

## DUEBER-HAMPDEN COMPLETE WATCHES

The conceded friend makers for the retail dealer. We are certain that we can help you make customers if you will write us for prices on Chains, Rings and all kinds of High-Grade Jewelry.

**WM. C. PENFOLD CO.**

WHOLESALE JEWELERS

AND AGENTS FOR DUEBER-HAMPDEN WATCHES

818-820 Chestnut St., Philadelphia, Pa.





# ZENITH

## MOVEMENTS

Give the

**RIGHT TIME  
EVERY TIME  
For a LIFE TIME**

**Grand Prize, Paris Exposition, 1900**

Made in O size, 12 size, 16 size, all grades  
Hunting or Open Face, Pendant Set

**INTRODUCED FOR THE FIRST TIME IN AMERICA, THOUGH ONE OF  
THE BEST KNOWN WATCHES IN EUROPE FOR GENERATIONS**

Manufactured by

**GEORGES FAVRE-JACOT & CO., Locle, Switzerland**

HIPP. DIDISHEIM & BRO., Sole Agents, } 49 MAIDEN LANE, NEW YORK.  
COLUMBUS BUILDING, CHICAGO.

# OMEGA

**MOVEMENTS ARE FINE TIME PIECES.**

All made with Lever Escapements and Double Roller.  
Pendant Set. Fitting American Cases.

**Made in 6 Different Grades.**

10 LIGNE. 11 LIGNE. 0 SIZE. 12 SIZE. 16 SIZE.  
From 7 Jewels to 21 Jewels,  
Adjusted to heat and cold and 5 positions.

*Why is it so many  
watch movements  
are sold under the  
plea that they are  
just as good as the  
Omega? There  
must be a reason.*

**PRICES NOT ADVERTISED IN ANY JOURNAL.**

SELLING AGENTS:

**EDMOND E. ROBERT, CROSS & BEGUELIN,**  
3 MAIDEN LANE, NEW YORK. 17 MAIDEN LANE, NEW YORK.

*A Trial will convince you of their merits. Send for price list.*



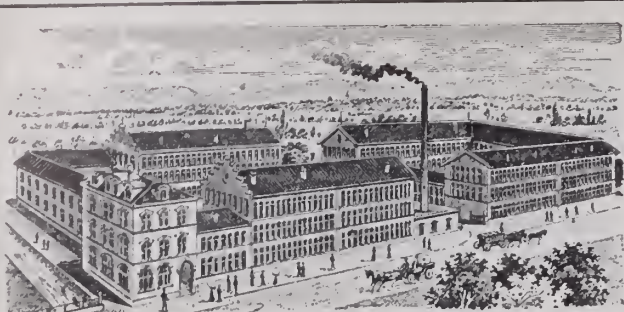

This illustration shows our main factory exactly as it exists, where 3,000 complete watches are made daily.

# LANGENDORF WATCH CO.

CHAUX-DE-FONDS, SWITZERLAND.

It will be of great interest to every jeweler to learn that we are devoting our full attention to this market. The existing conditions in the watch trade have convinced us that there is a long felt want for moderate priced, but accurate Swiss Watches.

We wish to call your attention to our LONVILLE MOVEMENT. It has a lever escapement and is being made in Os, 12s and 16s, fitting perfectly all American cases. This movement is salable and profitable. Our Watches and Movements will be introduced in this market bearing the following names:

- |          |          |
|----------|----------|
| SOLDALE  | HIGHMERE |
| BONDALE  | LONVILLE |
| CLAREFAX | NAMTOC   |
| PEARLHAM | LADY MAY |

SOLE AGENTS FOR UNITED STATES.

**BYRON L. STRASBURGER & CO.,**  
17 Maiden Lane, New York, N. Y.

A Complete Line of the Celebrated

# NARDIN WATCHES

Thin Minute Repeaters, Split Seconds, Movements fitting American Cases, Ship Chronometers and Torpedo Boat Watches can be secured through

**R. NEWBURGH**

Sole Agent

12-16 John Street NEW YORK

Manufacturer of the Current Grade Colbert Watch

## 46 out of 99 PRIZES

were awarded to

# PATEK, PHILIPPE & CO.

In the Timing Contest of the Astronomical Observatory in Geneva, for the year 1905, comprising: The only First Unique Prize for Best Average Running; 2 First Prizes out of 3; 5 Second Prizes out of 10; 8 Third Prizes out of 18; 9 Fourth Prizes out of 24; 10 Honorable Mentions out of 23; 11 Simple Mentions out of 21. 11 Manufacturers participated.

68 NASSAU ST., NEW YORK.

GENEVÁ, SWITZERLAND.

**JULES JÜRGENSEN**

**Watches and Chronometers**

PARIS—"THE GRAND PRIX"—1900

**SOLE**

**RUDOLPH & SNEDEKER,**  
65 Nassau St., New York

**AGENTS**

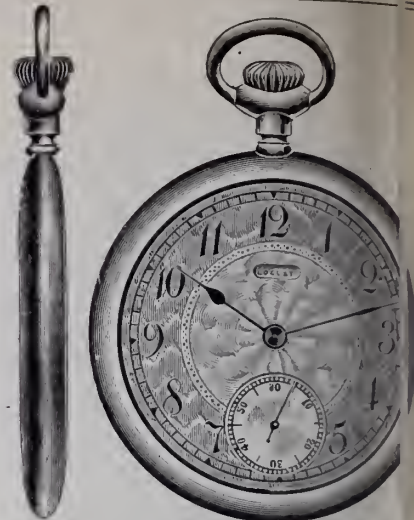

Actual Size.

# LOCUST

Extra Thin Model,

SEVEN JEWEL,  
LEVER,  
PENDANT SET,

CASED IN

## Fahys Bassine 20 Year Filled

Screw Back and Bezel,  
also in  
Silver, Gun Metal  
and  
Solid Nickel Case.

BEST VALUE EVER OFFERED

**TRY THEM.**

WE GUARANTEE EVERY  
LOCUST WATCH.

All Parts Interchangeable.  
Finished Material Always on Hand

IF YOUR JOBBER CANNOT  
SUPPLY YOU,

**WRITE US.**

**Hipp. Didisheim & Bro.**

49 Maiden Lane,  
New York.

Chicago Office, - Columbus Bldg

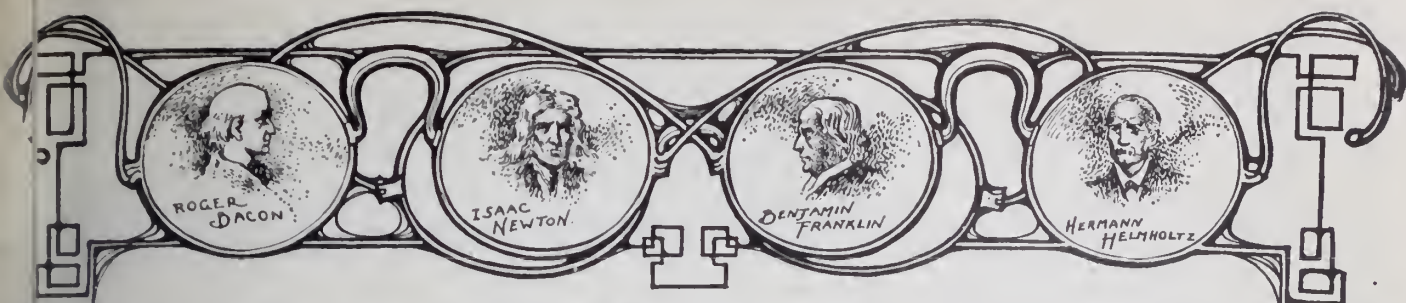

# OPTICAL DEPARTMENT

## Skiascopy.

Read by A. F. THOMPSON, Adel, Ia., before the Nebraska State Optical Society.)

THE principle of skiascopy is the finding of the point of reversal, or, in other words, the far point of a myopic eye, and, for this, if the eye is not already sufficiently myopic, it will be necessary to place in front of the eye lenses as will bring the emergent rays to a focus at a certain definite point.

So enthusiastically full of zeal for skiascopy that you can do nothing but study to make it a part of your very being, think of it all the time. Practice skiascopy. It has advantages to you if you become proficient in it that your confreres cannot possibly cope with.

First, it offers a method so simple in its essential details, and so exact in its results when skilfully employed, as to be naturally very attractive to those desiring to obtain a high proficiency in their optical work. It is chiefly valuable because it is really an objective method, and to a skilful operator is perfectly successful. But it is a method that must be worked finely, if at all. One must depend altogether on its essential details and not neglect small things, for it must be remembered that those who work it carelessly will surely fail, and that any such failure is essentially their own fault.

The essentials necessary to a successful skiascopy are: First, a dark room, one which is dark; second, a mirror, or retinoscope; third, a good lamp; fourth, a trial case; fifth, a comfortable chair for the patient; sixth, an adjustable stool for the operator; seventh, a table for trial case and prescription book.

Skiascopy is the objective method of determining the refraction of an eye by reflecting light into it and observing the character of reflected images thereby. It has been known from the remotest times that the pupils of certain animals (dogs, cats, etc.) can appear luminous. The phenomenon was thought to be analogous to the refraction of light by phosphorescence, but in reality it is due to the existence of the tapetum, a part of the choroid, the retinal surface of which is strongly reflecting and acts as a metallic reflex. Its purpose is not well elucidated. As to the human eye, it has been known for a long time that it may, in very rare cases, appear luminous after the development of an anterior chamber of the eye. Also Beer discovered the glow in certain cases of anireidia (absence of the iris).

In 1850 Cummings and Bruecke discov-

ered the method of making the pupil of the normal eye appear luminous, and in 1851 Helmholtz achieved the great invention of the ophthalmoscope, which has revolutionized ophthalmology. Like every other object, the fundus of the eye sends back light when it is illuminated; these emerging rays of light from the fundus are called the luminous cone. Generally the eye can send back light to a point which has sent light to it, and under ordinary conditions the pupil of the eye appears black. It is because the pupil of the observing eye, being black, cannot send light into the observed eye. In order that it may appear luminous, a luminous source must be placed in front of the observing eye. This is what we do by means of the retinoscope.

The skiascopist estimates a case of strong ametropia more easily than a slight error because the emerging rays from the eye soon diverge greatly, so that the skiascopist can more easily find a place in the luminous cone. If it were not for this luminous cone the skiascopist would have no field of usefulness. Therefore, in estimating errors of refraction, the skiascopist has but to catch the emergent rays in this luminous cone and in cases of astigmatism observe the rapidity of motion in the different meridians, knowing that astigmatism exists in the meridian of slowest motion. Another characteristic appearance that will be almost always noticed in astigmatism is that the fundus illumination assumes a banded appearance, which is known to all skiascopists.

### THE MIRROR.

I use the plain mirror for the following reasons: First, about 80 per cent. of your patients will have hypermetropia to a greater or less extent. And with a plain mirror, the motion in such cases is with the mirror, which seems to me to be a more natural condition than against. This, however, is not essential. The only thing to remember is that all conditions are reversed with other than a plain mirror.

To become proficient in the manipulation of the lenses, and make the changes quickly, to definitely select the kind of lens required and locate the axis of the cylinder approximately at first glance, requires patience and practice. It must be borne in mind that skiascopy is a method of ocular examination, is one that grows accurate and reliable only with experience. Practice alone makes perfect.

It should be the effort of the skiascopist to offer examinations to any who will put their time against yours, being particular and painstaking in such examinations, to try to correct any case of ametropia with that carefulness and exactness in the work as

though you know you are to sell a pair of glasses in each case. It is, and has been, my custom to invite any who accompany a patient, to the dark room, and induce them (always by moral suasion) to have their eyes examined, and in a great many instances I have been able to develop and show such an error of refraction that they knew nothing of, and ultimately to sell a pair of glasses thereby.

The practice of skiascopy is a method in which the skill of the operator counts for more than in any other method and I have known surprising results from such under the most unfavorable circumstances. But nevertheless there is no reason why the operator should not provide himself with every means necessary to make his work the most successful. While every facility will not make a good operator of one who does his work carelessly, a careful worker can do better work when surrounded by such conveniences.

The best sort of dark room is one, I should say, size 6 by 20 feet, absolutely dark, and provided with an adjustable lamp; one that can be raised and lowered, and capable of swinging around the entire circle. I have arranged such a lamp, and I use gasoline or gas, and an asbestos chimney provided with a diaphragm. All other sources of light are eliminated except such as come through the opening of said lamp flue, and regulated by the diaphragm, preferably raised a little higher than the operator's eyes and to his left, provided he uses the mirror in his right hand.

Now, with such a dark room, convenient chairs, trial case, table and stool, I seat the patient in the chair facing me at one meter distance and direct him to look at infinity or into the dark, with his left eye directed to the height of the operator's left eye, and flash the light with my right hand across the pupillary area and determine which kind of an error he possesses, knowing that if I am using a plain mirror and the motion is against the mirror, it is a minus, and if with the mirror, plus. And also judging at the same time approximately the amount of ametropia by the rapidity of motion. I then adjust the lens clip or frame, using the double cell open frame; that is, with all trial cases, and insert spheres, and stay on whichever meridian I am testing until I get a reversal of motion. I also note the amount. As quickly as I obtain such reversal I proceed to refract the opposite meridian in a like manner, and also note the result and make my subtraction and correct accordingly.

Before taking the first skiascopic view of either eye, I am particular to make my pa-

## Optical Department.

tients feel, and be, perfectly at ease and comfortable, and if they are bundled up with a superfluous amount of wraps, I have them remove them and also their hats, knowing that such uncomfortable surroundings will materially hinder effective work. I often have a suggestion from my patient, offered as to conditions Dr. So and So found, but I invariably and very respectfully refuse such voluntary information, and politely but firmly impress upon his or her mind that I desire to gain my knowledge by my own methods and ways. Under a skiascopic examination of an eye, astigmatism reveals itself unmistakably. For motion follows the rule of its meridian, and is therefore different in different meridians, the same as an examination of two eyes having ametropia of different kinds or degrees shows the difference for the two eyes, an astigmatic eye giving you the resultant of the two motions.

The pupil of the observed eye is the practical field of the skiascopist, and is confined entirely to it. In that field appears, under different skiascopic conditions, a full and complete display, answering all questions that may be propounded relative to the observed eye's dioptric condition. The skiascopist has but to provide or note the conditions and read the results in the objective pupil. But all so-called visual objective appearances are not the projection of a subjective retinal display.

Skiascopy may be termed the method of estimating the refraction of an eye by reflecting into it rays of light from a plain or concave mirror, and observing the movement which the retinal illumination makes by rotating the mirror.

### VALUE OF SKIASCOPY.

Those who would criticize skiascopy because "We see nothing and think nothing of the fundus," base their criticism apparently on a lack of knowledge rather than from any practical experience with the method. While admitting that the ophthalmoscope in front of a well trained eye can often make a close refractive estimate, yet only a few attain such proficiency, and even then there is that uncertainty which does not attach itself to the retinoscope in trained hands. The skiascopist who knows how to use the mirror accurately has the advantage of his opponents who are ignorant of the test. It gives him a position decidedly independent of his patient, and puts him above the common level of the "Great Doctor Eye" or the refracting optician, who are bound to the trial case and the patient's uncertain answers.

Furthermore, when it is remembered that from 50 to 80 per cent. of the errors of refraction presented to the optometrist are among the more difficult class and in many instances they will tell you how Dr. So and So attempted to correct their error and failed, it is well to be most capable in this important branch of the profession.

Skiascopy gives the following advantages: First, the character of refraction is quickly diagnosed; second, the exact refraction is obtained without questioning the patient; third, little time is required to make the test; fourth, no expensive apparatus is necessarily

required; fifth, its great value can never be overestimated in nystagmus, amblyopia, aphakia and, with children, illiterates and the feeble minded.

### CYCLOPLEGIC NOT NECESSARY.

In the practice of skiascopy, the accommodation of the observed eye is the handicap to the observer, and a great many without experience will tell you a cycloplegic is necessary. But in my experience of six years I have failed to find a case I could not properly diagnose without such paralysis of accommodation. I find the dark room will produce mydriasis and by directing the patient's attention to infinity a temporary suspension of accommodation will be effected.

The ciliary muscle will not be as completely suspended as under the use of a drug, but corrections made under the action of the drug are only guesswork, for usually something is subtracted from the entire amount of revealed error, and the object of using the drug is thus discredited and discounted in advance.

If it is not used at all, it will not be necessary to discount your own diagnosis, which is not an act to inspire confidence in yourself. It is practically saying that the use of the drug gives lying results, and therefore you must discount its revelations on account of their unreliability. If any one present can accurately measure the strength of the ciliary muscles of an eye by any known methods, I should be glad indeed to learn their methods.

It will hardly be expected among a body of men possessing as much intelligence as your appearances suggest to me, that I could in each and every detail explain so explicitly that one could start at the conclusion of my paper and accurately correct ametropia by skiascopy. Yet I beg your indulgence in a few words with reference to the "shadow."

### THE SHADOW.

First—The shadow is the non-illuminated area of the retina, and acts very much on the same principle as casting light into a well with a mirror. Your will find by so doing you will not be able to light up the bottom of the well equally by flashing the light across the top. You will always have a dark area or one side in which there is no light, but a shadow. Now, when light is cast into an eye through its dioptric media, it will focus, the emergent rays at some point anterior or posterior to the observer. At such focus in skiascopy it is called the area of reversal, and the distance from the observer's cornea and such area of reversal will govern the rapidity of motion. It is similar and acts very much the same in effect as passing one's hand across the field of vision.

It will be observed that the closer the hand is to the cornea the greater apparently will be the speed of the hand. In estimating a case or error of refraction, then, the skiascopist's purpose is to bring the area of reversal to his cornea, or to determine what lens would be, or is, necessary to produce that result.

When the area of reversal is at the cornea of the observer, there will be such a diffusion that it will be impossible to tell or observe any motion at all, for there is no motion if there is no image. Real reversal

of motion appears only when the observed eye is far enough back of the area of reversal to obtain something like an image upon its retina.

In working out a case by skiascopy, whenever the skiascopist has succeeded in reaching the point of reversal by adding such lenses as will cause a reversal by rotation in the different meridians, he has attained his point in view.

## Is Hypermetropia Headache Dependent Upon Age?

It has been claimed that the symptoms of asthenopia appear when the age of the patient is equal to the degree of ametropia expressed in the old system. That a child having 3.00 dioptries of hypermetropia would complain of asthenopia when 3 years old. Under 13 his accommodation would mask the ametropia. Again, a patient 18 years old says that since he was 16 he has suffered from headache when working upon near objects, we may see that he is suffering from 2.50 dioptries of hypermetropia.

The above claims are made by a correspondent in the *Dioptric Review* sign himself "K." He states further that of course he does not give this as a scientifically based law, but rather as a curious and as an empirical rule, the application of which may be found useful in practice.

The latter modification, it is feared, is sadly needed, for we can conceive no reason for assuming that a table based on the above calculations would be in any sense correct. For instance, beginning at the lower amounts of error, a person having a quarter of a dioptre of hypermetropia would not complain of headache or suffer asthenopic effects until he was 144 years old. With half a dioptre no pain would be experienced until the 80th year; at a three-quarter dioptre error would make itself felt, and a one dioptre error would cause no annoyance until the 40th year. Further examples would be superfluous unless we note that with 10 dioptries of error headache should be experienced during the fourth year.

Going over the records of about 1000 cases should afford a fair means of estimating the degree of certainty with which this rule might be applied, and a perusal of said cases show that in innumerable cases the patient with one dioptre or less of hypermetropia complained of headache long before the 40th year. In fact, if a patient with one dioptre of hypermetropia should not experience headache before the 40th year, the chances are that he never will experience headache from this cause, because by that time his accommodation will have become far less active, which reduces the liability of headache occurring.

Had this law been well grounded, Donder's renowned rule would have been eclipsed, but even Donder's is only the best kind of an approximation, and based on scientific principles, whereas the above suggested rule is merely a haphazard guess which will do no more than lead a few careless workers into error.

A. L. Neuenschwander removed from Deepwater, Mo., to Woodburn, I.

# RETAIL JEWELERS ADVERTISING

The use of this department is open to every retail jeweler and optician. Forward for criticism your newspaper ads., booklets, catalogues, novelties, circulars, etc. Ask advice and offer suggestions. Replies in these columns are unbiased. Make letters as full and particular as you desire. Every letter and ad. sent will receive full attention, though the publication of the matter may sometimes be delayed several weeks.

## The Optician as an Advertiser.\*

WHEN the secretary notified me that I was not only urged but expected to prepare a paper for this meeting, I consented before I had given it much consideration. Now the selection of a topic to read before an optical meeting is more complex than its looks, and after wrestling about two weeks with "The Spectral Radiation of Colors in An Inverted Rainbow" and "The Reflex Nervous Sympathy Incident to Hyperphoria," I came to the conclusion that you are all too well posted on questions of this nature and abandoned them both for one of which John Wana-maker says the public never tires—advertising.

"Who's the man who wins success?"

The man who early rises,  
The man who springs surprises,  
The man who advertises—  
He's the man who wins success."

—Holton's Tips.

Give the author a topic—he can write a book. Give the song writer a title—he can write a song. Give the poet a theme—he can write a poem. Give the optician a suggestion and he should be capable of writing an advertisement that will bring in business. But there are a great many of us here to-day who fail to give this matter the attention that it deserves.

Some of us jeweler-opticians see our customers going to the oculist, or trade slipping away from us to a competitor who advertises optical goods, simply because we are neglecting the most interesting and profitable part of our business. When the optician has first hung up his test-type, placed his trial case in position, framed his diploma, joined the "Missouri-or-Kansas" Optical Society, there is but one more step between him and his customers, and that is to take the best newspaper space he can get and advertise.

There is no event of importance happening now but will be known to-morrow. The destruction of a city, the declaration of war, the birth of a nation, all matters of national importance, are heralded far and wide through mediums of publicity devised for the convenience of man. Not only as a medium for public events, but often the career of a man is born and made within the columns of a newspaper. Roosevelt is one of the greatest advertisers to-day—he does things. Edison is another—he accomplishes wonders and then lets the world know. Donders and Helmholtz, two of our great scientists, to whom we are indebted for the principles of some of our optical

instruments, were exponents of publicity. They let us know. Benjamin Franklin, who is sometimes styled our first optician, was also a successful newspaper man, and his inventive turn of mind was closely related to his true sayings. In each he had a motive.

Some men fear to advertise lest their motive be misconstrued; others because they are modest. There is no sane reason why an optician should "place his own light under a half bushel" while the other fellows "stands out emblazoned like the Statue of Liberty."

If you have a theory, a system or an appliance, it is in justice to yourself and the public generally that the world become acquainted with its value. Do not quibble with small things, nor let your incentive "get the best of you." It is the man who can face adverse criticism and an approaching storm alike that meets success. There is some one always ready to criticize you, no matter what you do. As Josh Billings once said: "When you act the most sensible, you know how folks are liable to think you are a darn fool."

By an old-time custom the medical profession has held to a code of ethics that is generally observed by most doctors and surgeons, but the existence of this compact has never been comprehended by the people. There are some optometrists in cities who have adopted this same method of the profession. But we have never heard of them joining an optical society. I believe as a rule there is but little objection (and there should be none) to a campaign of optical advertising in which the public is informed as to the importance of caring for the eyes, of new optical features of manufacture, and of anything that will tend to elevate the optical profession.

The best advertisement which an optician can have to-day is a satisfied customer. That customer can do more real good, and sell more glasses for you than a page ad. in a country paper. And yet you cannot afford to leave the success of your business to the flattery of your friends any more than you could to your own personality. On the other hand the optician's name should be constantly before the people, that even this satisfied customer may know he is keeping pace with the strenuous times, ever alert for new ideas that suggest progressiveness.

An eccentric optician of the old school, who had never fitted a lens larger than a number one eye, or sold anything but a flat-rimmed spectacle, once made a serious impression on me by an amusing description of his customers. He said there are three kinds of customers—the invited, the blight-

ed and the slighted, and he described them in this manner: the invited had heard of his talent and came to be shown. The blighted customer was an ill-fitted one. The slighted customer had been unsuccessfully fitted by a rival optician.

And so it is that we can draw a similar comparison to our own customers. The invited, the blighted, the slighted—each one requiring a different mode of treatment, ever watchful of foibles and peculiarities that each may be made a permanent and satisfied customer. The same pains must be taken in our advertising. We must meet our customers in the newspapers as we do over our counters. Every line, every word must mean exactly as intended. The proper thing must be exploited at the right time; the ways and customs of a community be studied that an advertiser be familiar with the wants of his customers; for example, it would be as inappropriate to advertise automobile glasses in our town of Trenton as it would "scenery" glasses in Kansas City.

In conclusion I will say that the enthusiastic optician who is in love with his work and gives it the attention which it deserves, advertises for the business he gets—gets it; and then advertises to hold it; knows there is but one time to stop and that is when he is ready to quit business and enjoy the result of his labor.

## What Some Jewelers Say.

HIGH grade watches. We can show you the finest timepieces in the entire world, both American and Swiss manufacture. The celebrated Vacheron & Constantine, Longines, and Agassiz have taken more world's first prizes for their accuracy than any other watch made. The greatest of all American watches—the Hamilton—known favorably by all railroad men. Elgin, Waltham, Hampden, Rockford, Illinois, Howard—we have them all. Our written guarantee goes with every watch we sell. Solid 14-k. gold watches for gentlemen, with fine 17-jewel or 21-jewel movements, from \$50 to \$250; for ladies, from \$25 to \$100. Gold filled watches, warranted to wear a lifetime, from \$20 to \$75. Gold filled watches, warranted to wear 20 years, with finest 15-jewel movements, our special bargain price, \$12. Of these we have only a few left. Our \$15 watch for ladies, warranted for 20 years—they are \$20 values—while they last we will sell them for \$15. We have the largest stock of first class watches in Duluth, and will be pleased to show them to you. Our reputation for square dealing has been well established in the past 10 years and you will get our personal attention if you come to inspect our stock. Our "special price sale" will continue only one more week. Harris & Esterly, Duluth, Minn.

Tempted.—Every person who sees the \$3 candle-stick we are selling for \$1.85 is strongly tempted to buy and they do not try to resist, either. Wouldn't a heavily silver plated candle-stick bearing our guarantee tempt you? Couldn't you find a place for it in your home, especially when it is made on a sterling pattern and well finished? They are not cheap sticks, but good ones cheap. Good enough for any home, and the price is only \$1.85. R. Ashby, Colorado Springs, Colo.

\*Paper read by Claude E. Range, Trenton, Mo., before the recent meeting of the Missouri and Kansas opticians, in Kansas City, Mo.



That this department shall prove mutually beneficial to our readers, it is desirable that the members of the trade generally communicate with THE JEWELERS' CIRCULAR-WEEKLY regarding any advantageous device or plan which they are utilizing in connection with their business.

### How the Fire-proof Safe Protects—Lessons from the Experiences of San Francisco Jewelers.

“ANY variety or make of safe is fire-proof as long as there is no fire, and when tested by fire none of them are fire-proof.” That is the way the head of one of the largest jewelry concerns in San Francisco summarized the safe question, and 99 jewelers out of 100 whose safes went through the late fire in that city feel the same way about the matter.

As a matter of fact, not a single jeweler's safe came through the fire with its contents entirely uninjured, except one or two small diamond safes. Most of the safes saved loose diamonds and loose pearls; a few of them saved gold almost uninjured, but none saved watch movements entirely, and almost none saved silver. A large number of safes preserved papers and books which had been closely packed, though loose paper was very generally reduced to carbon.

As a rule, the smaller safes seemed to stand the heat better than the larger safes, though this may be due to circumstances rather than to the quality of the safes. As a general rule, all the safes in any one building of whatever make or size came through in practically the same condition, showing that the difference shown in the saving power of the safes was due rather to the varying degrees of heat to which the safes were subjected than to differences in the safes themselves. All the safes, or practically all in the Johnson Building, at 120 Sutter St., failed to save their contents, owing probably to the intense heat caused by the burning of large quantities of wooden clocks in the storerooms of the wholesale dealers and to the burning of the stock of Nathan-Dohrman Co., dealers in house furnishings, who occupied the ground floor.

Naturally the safes in the first-class office buildings which, while fire swept, were not destroyed and which kept the safes from falling, came through the fire better than those in cheaper buildings which fell one or more floors and were buried beneath several feet of red hot brick, when the building collapsed. The safes of A. I. Hall & Son, which were on the fifth floor of the Aronson Building, kept their position and the contents, while badly damaged, were better than in most other cases. All watch movements, however, were

sweated and had to be returned to the factory. Watch cases in these safes were not melted, but were oxidized, rendering repolishing necessary. Gold jewelry in the safes was in pretty good condition, although a portion will have to be repolished.

The large safe of the Bohm-Bristol Co., which was seven feet in height, tipped badly, owing to the partial giving away of the door, and the contents were badly damaged. Not a scrap of paper was saved in the safe. Out of 450 watches in the safe 150 were totally lost and the remainder had to be returned to the factory. Loose diamonds and pearls came through uninjured, but all silver in the safe was melted.

The big fire showed some peculiar phenomena on the part of safes and their contents. In the Bohm-Bristol Co.'s safe a pearl collar wrapped in many thicknesses of tissue paper, came through without any injury, while a number of pearl necklaces wrapped in silk were baked to a crisp. The large safes of A. I. Hall & Son were so badly burned that they had to be cut open to get at the contents, while a small diamond safe on the same floor and subjected to practically the same conditions, was easily opened by the combination.

The great lesson taught by the fire seems to be that vaults of the very best construction afford the only positive protection in such a fire as that which San Francisco experienced. The new vaults of Shreve & Co. gave their contents almost perfect protection. The vaults of the San Francisco banks also protected their contents in practically every case. These vaults, however, failed of their purpose where they were not built upon an absolutely solid foundation. In one case where a vault was built across steel beams, the beams settled on one side, causing the vault to crack, and thus admitting the flames to destroy the entire contents.

In justice to the safes, which failed to endure the heat of the late fire, it should be borne in mind that this was a fire practically without water, and that the heat engendered was unusually severe. Moreover, many of the safes lay in the ruins covered by hot brick and refuse for from one to three weeks before they could be taken out. One jeweler's safe was pulled out two weeks after the fire with portions of it still red hot.

W. N. Evans has moved from Minatare, Nebr., to Bayard, in the same State.

### Advertisements Worth Reviving.

MANY admirable advertising devices have their reign of useful popularity, and, as well worn factors, are placed aside and forgotten. Many of them are worth resurrecting. One very clever device of 30 years ago has passed the recollection of most and to the later generation has never been known. In fact, as a writer never saw it in use in this country, possibly England, its place of origin, and enjoyed the benefit of its being.

In those days gas was the sole illuminant for the show window, and a favorite method of increasing the light thrown upon the display without raising the temperature of the store to unbearable degrees, after lighting a certain number of gas jets, was to connect gas connection outdoors and thence receive more illumination on the goods.

These outdoor gas show window reflectors consisted of a cluster of jets, whose light was reflected by mirrors, the best metallic hood barring all light from the sidewalk. As innovations some inserted a “bull's-eye” glass in the metal sheathing, brighten up the appearance of the otherwise sombre contrivance on the outer side. Then some genius introduced this “bull's-eye” lens into the lower part of the casing, thus reflecting the lantern gleam a cone of light that lit up a circular space on the sidewalk. And, by painting his name in black, bold lettering on the lens, a brilliantly illuminated disk advertisement attractively displayed on the pavement of the sidewalk.

The jeweler who will bring into existence again this clever advertising device will be producing something which, if not all, those who pass his store at night have never seen before.

With a little ingenious manipulation, perhaps a small illuminating glass clock dial (one whose works are confined to the center of the dial), might be inserted so that, by placing a white slab in the sidewalk, the reflected time as well as firm name would be clearly readable on the pavement.

The idea is well worthy of resurrection as an attractive and inexpensive advertising novelty.

Asbury & Reavis, Lexington, Okla., have dissolved, John H. Asbury continuing.

Hibbard & Wilcox, Akron, O., have dissolved, and the business will hereafter be known as the Hibbard Jewelry Co.

**Storekeeping Department.**

**Made the Bowery the Old Retail Jewelry Center of New York.**

Speaking of the change in the retail jewelry centers of New York to J. H. Johnston, an old Bowery and Broadway dealer, who is now in business in John Street, THE ONLOOKER expressed surprise that a fashionable business center so firmly established as the Bowery should so completely lose its character in half a century. Mr. Johnston:

What made the Bowery for 40 years the principal retail artery? Well, first of all, its great width, and that it ran at right angles with the then residence streets, parallel to Broadway, and east of it, making it of the greatest convenience to the greatest number. Then, too, it was the first street to enjoy the advent of horse-drawn and then a decidedly progressive method of locomotion. For the Fourth Ave. cars, the first to get a charter, and the Third Ave. cars, below 9th St., joined, as they used to do, and ran down the Bowery, past 'Jewelers' Row.' The growth of the city finally shunted these stores from the Bowery but when the Elevated was completed it quickly ended the supremacy of that classic thoroughfare. Before the Bowery faded out, and before the East River Bridge and the Elevated combined to spoil Fulton St., the main artery from Brooklyn had quite a vogue as a retail headquarters. Notwithstanding its backsliding, the design of J. H. Johnston did not leave the Bowery till 1892, although four years previously I had opened my store in Union Square, by which time the street had entirely lost its old-time character.

I am credited, among other things, with being the first dealer in New York to take down the old wooden shutters which had always been regarded as a safeguard against burglars. You know the kind I mean, with a small hole in one shutter, to permit the watchman to peek through and so that the interior, illuminated by one small light, remained unmolested. There were 21 shutters in front of my store, and I had had several years in taking them down and putting them up again before I came 'boss.' I determined to risk the change. So without interposing a single pane, not even screens, against the protests of everybody, in 1860, I took them down forever. Nothing ever happened to cause me regret my enterprise. Later on I was to have the honor also of being the first retail jeweler to put the convenience of telephone into his store.

The great hit of my life, however, was one that I made as early as 1874. One day, during a season when trade had been very dull, I began to cudgel my brains as to what to do to revivify it. Out of that grew the business of relieving people of delicate wedding presents, and of disposing of these. The way of it was this: I inserted an advertisement in one of the daily papers, reading as follows: 'Cash paid for duplicate wedding presents. Inscriptions erased, silver refinished and sold at low manufacturer's cost.'

"What was the result? Why, in less than three months I had succeeded in revolutionizing my entire business.

During the early period when the Bowery was the best shopping district of New York, the indwellers of the city were an extremely conservative and unsophisticated lot, as compared to the great majority of folks of to-day. They lived extremely plain and simple lives, as compared with even those of the second period—how much simpler therefore than those of the cosmopolitans of whom there are now so many, an ever-growing percentage of to-day. The sum of happiness then was, I believe, greater than it is now, and happiness is, after all, according to my notions, the main thing." THE ONLOOKER.

**Suggestions for Jewelry Clerks.**

Earn more than your salary.

Don't wait for a raise in salary before working harder. If you do you will never get it.

A clerk has to do more than he is paid

**An Attractively Furnished Jewelry Store in Mobile, Ala.**

THE newly furnished store of I. Dahlheimer, 119 Dauphin St., Mobile, Ala., is shown this week. The store is 68 feet long and 19½ feet wide. The fixtures, etc., are of golden oak, and the walls are tastefully decorated with American Beauty roses on a light blue background. The floor is of cement and tessellated rubber tiling.

An attractive front entrance is flanked by two display windows of French plate glass, the sides being equipped with beveled edge mirrors. Each window is 74 inches wide, 42 inches deep and 7½ feet high. A new steel ceiling artistically tinted to harmonize with the general color scheme, has also been installed.

A fair idea of the effective lighting of this establishment can be gleaned from the photograph, which was taken at night. A feature of the store is the grill arch in the center of the room, where there are three arc sunbursts, each having seven lights. The wall cases also have each four lights, the



INTERIOR OF STORE OF I. DAHLHEIMER, MOBILE, ALA.

for before he can attract business. Then the increase of wages should come.

The least desirable of all clerks is the irresponsible one. You must make your employer understand that you have his interests at heart as much as though they were your own.

Every clerk should study his business with the intention of some day becoming a proprietor and managing a business of his own. Of course, if every man did become a proprietor there would presently be no clerks. But you needn't worry about that. There's not much danger of more than one man out of 10 making himself fit for what you intend to do.—Er.

Let your advertising wear a silk hat—arguments to the contrary notwithstanding—even when you want it to mix with the common people. There's a wonderful power in distinguishing dress. Its very respectability challenges attention and its flattery wins the hearts and—orders.

whole establishment containing in all about 200 incandescent lamps.

By specially arranged prisms and mirrors in connection with concealed electric lamps the show windows are very attractively lighted, the light being soft, yet clear and bright, without glare. The private office is located over the partition in the rear.

Recent exterior renovations have much improved the appearance of Max H. Elbe's store at Niagara Falls, N. Y.

Sam F. Sipe, Pittsburg, Pa., has sent out as an advertisement to his customers, a polished mahogany foot-rule and paper-cutter. Accompanying it is also a piece of cardboard the same length as the rule, calling attention to the fact that the jeweler is giving a 15 per cent. discount on all diamonds purchased prior to his going abroad in July. The sending out of the advertisement contains the inference that it is always Mr. Sipe's custom to carry out "a good rule."

What Tool is of More Importance to THE MAKERS OF FINE JEWELRY than

**A FIRST CLASS SAW ?**

**SHARP—TRUE—UNIFORM  
—PERFECTLY TEMPERED**

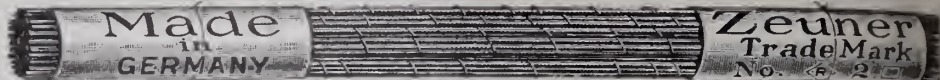

TRADE  
**ONLY  
THE BEST**  
ARE  
GOOD  
ENOUGH  
MARK



Such is the **ZEUNER SAW**

**TRY THEM**, for "Only the Best are Good Enough," and only the Best are Cheap. Trial orders promptly filled under guarantee of perfect satisfaction, which applies also to "AMERICAN SWISS FILES."

**E. P. REICHEL & CO.,** 23 JOHN STREET, NEW YORK.

**THE REMINGTON RING EXPANDER.**

The most useful implement a jeweler can own.

**PRICE \$7.00 NICKEL PLATED INCLUDING A STEP MANDREL AND EIGHT ROLLS**

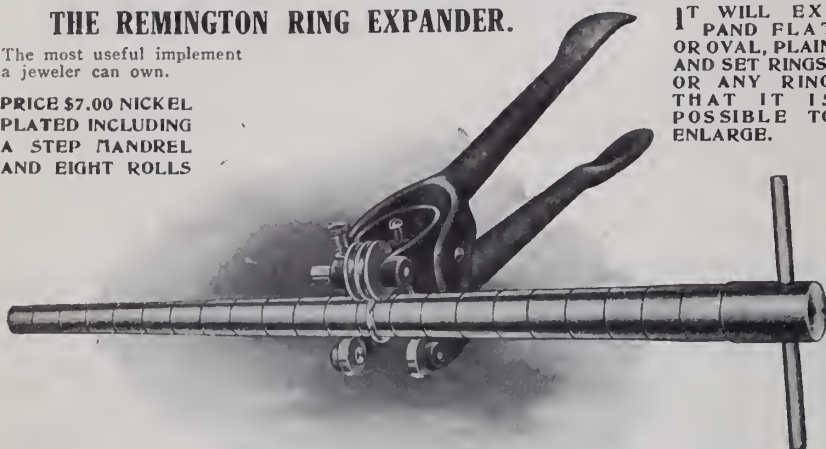

IT WILL EXPAND FLAT OR OVAL, PLAIN AND SET RINGS, OR ANY RING THAT IT IS POSSIBLE TO ENLARGE.

IF YOUR JOBBER CANNOT SUPPLY YOU WRITE TO US DIRECT.

**SPECIAL FEATURES OF THE REMINGTON RING EXPANDER.**

A MANDREL WITH STEPS SQUARED and 1/2 size variation is used to prevent tapering of the ring. THE FOUR SMALL ROLLS ON THE LOWER JAW OF THE TOOL (see cut) PREVENT FRICTION, and make it possible to use any amount of pressure WITHOUT ROUGHING THE MANDREL. THE PRESSURE IS CONTROLLED BY THE HAND and it is not necessary to use a vise or other implement when operating the REMINGTON.

Manufacturers of Patent Tools and Machinery.

**NOVELTY ENGINEERING ASSOCIATION,** FITCHBURG, MASS.

**LEIMAN'S NEW SAND BLAST.**

SIMPLE. EFFECTIVE. ECONOMICAL.

**NEW FEATURES**—Let us tell you about them.  
**RESULTS**—Let us show you samples of work done.

**Improved High Pressure Blower**

NOISELESS. INEXPENSIVE.

Delivers Greater Volume at Higher Pressure Than Any Other Made.

**LEIMAN BROS.,**

Jewelers', Silversmiths' and Metal Workers' Machinery, Tools and WORK BENCHES,

141 Centre Street, NEW YORK.

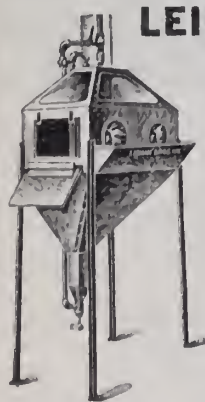

**OUR ELECTRO-PLATING SALTS**

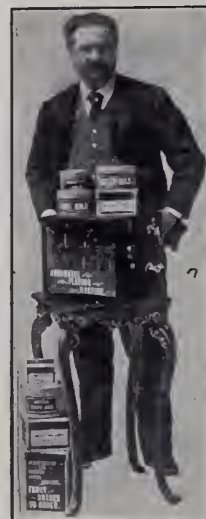

when dissolved in water make a plating solution always ready for work of always correct shade. Know that we are originators, and manufacturers of the Dark Green Gold Salt (tigue) and other Salts Green.

Likewise the Rose and Orange Rose Salts used for single double gilding, and good many other now on the market. Our Roman Gold produce an almost deposit, requiring little or no scratch brushing. French Grey, 14 Kt. gold, Old Eboniz gold, Silver Eboniz fact any shade wanted be had of us. Write circular.

Our Automatic-Electro Plating Machine specially designed for small manufacturing the retail Jeweler, of interest to them. for Pamphlet.

**U.S. ELECTRO-CHEMICAL**  
H. Hirschbach, Prop.  
80 Elm Street, New York

**GLARDONS' SWISS FILES**

are the **HIGHEST STANDARD** of Excellence.

We are Sole Agents for the United States and Canada.

**F. W. Gesswein Company**

Established 1868. Incorporated 1896.

WILLIAM DIXON, PRES.

Dealers in Fine Tools and Supplies,

39 John Street, New York

**CRUCIBLES**

Jewelers' Supplies, Etc.

Established 1850.

**J. & H. BERGE,**

95 John Street,

NEW YORK.

**CASTINGS**

Gold, Silver, Bronze, Brass, German-silver, Copper & 1/2 Supply Jewelers, Silversmiths, Die-makers, Mould-makers.

Unbreakable Bronze Forces. Hard Bronze Engraving Plates. Cast Iron Forces for making Steel Chandeller, Undercut Work, Statuary.

**AUGUST GRIFFOUL,** 313 HALEY STREET, NEWARK, N. J.

"PRACTICAL COURSE IN ADJUSTING" Price, \$2.50.

All Jobbers or Jewelers' Circular Publishing

**ROLLED GOLD PLATE SEAMLESS WIRE AND TUBING**

**DUNBAR, LEACH, CARNER CO.,**

MANUFACTURERS,

ATTLEBORO,

MASS.





[Answers are also solicited from our readers to the questions published on this page.]

**QUESTION No. 1584.—Silvering Metals without Electric Current.**—*I am manufacturing some metal objects that I want to silver, but do not wish to go to the expense of purchasing a plating dynamo. I know that certain metals are silvered by simply dipping them in some sort of a solution. You kindly give me a good formula for this purpose?* S. M. E.

**ANSWER:**—One of the latest formulas for silvering metallic objects by merely rubbing has been patented by Walter Bolstesli, Switzerland, and is said to give good satisfaction. The solution is produced by taking about 30 liters of water and dissolving 0.8 gram of silver nitrate. Precipitate this silver chloride with diluted hydrochloric acid of 20 per cent. strength. Wash this silver chloride well and dissolve the precipitate in a solution of about 30 liters of water and 3.3 kilograms of hyposulphate of soda, which solution is made up separately. Then mix with this solution, while stirring, 1 kilogram of caustic ammonia (8 per cent) and finally 8 kilograms of finely powdered Spanish whitening. Clean the articles to be silvered and rub on the silver with chamois or linen. The solution may also be rubbed in until nearly dry, then washed and rubbed up with a dry chamois or woolen rag. This is said to be especially suitable for musical instruments.

**QUESTION No. 1585.—Hot Galvanizing.**—*Kindly describe to me the process of hot galvanizing iron and other objects.* H. G.

**ANSWER:**—Galvanizing consists in dipping the articles to be galvanized in molten zinc, at a temperature of about 900° F., after scales and oxides have been removed with the usual acid dips or pickles. It is often necessary to anneal the iron before galvanizing. For cast pieces the cleaning is best done with a sand blast, but where sheet iron surfaces predominate the pickle is used. The mill scale must all be removed, and to accomplish this it is necessary to use sharp sand with which fine shot is frequently mixed. For the small castings the tumbling barrel can be used in connection with sand and water. Commercial sulphuric acid with about 10 parts of water is the usual solution used for the pickle, which is heated by steam. Pickle the iron from one to two hours and then wash in fresh running water. Place on a table and remove patches of scale with a stiff brush or scraper, and let the iron remain in water from 10 to 12 hours. Before galvanizing the pieces are immersed for a few minutes in commercial muriatic acid, which forms a thin iron chloride on the surface and prevents oxidizing before the dipping. Dry for half an hour and then the pieces are ready to be dipped in the molten metal. Muriate of ammonia is placed at one end

of the vat, and the articles are passed through before they enter the molten zinc, and may pass through sand as the piece comes out of the metal. Small quantities of tin may be added to the zinc to increase the size of the spangles.

**QUESTION No. 1586.—Pure Manganese as a Deoxidizer.**—*What can you recommend as a good deoxidizer for tin and other alloys?* P. M. A.

**ANSWER:**—One of the best deoxidizers for melting of tin and alloys is pure manganese. It is only within a very short time that pure manganese is being produced, and that through the invention of Dr. Goldschmidt, of Essen, Germany. It is beginning to be used extensively and is taking the place of ferro-manganese, which was formerly employed. Only about two pounds of the pure manganese to the ton of tin or alloy are necessary to use as a deoxidizer.

**QUESTION No. 1587.—Chloride of Silver Reduced to Granulated.**—*I have accumulated about 50 ozs. of chloride of silver that I want to reduce to granulated silver. How must I proceed?* Ch. S. R.

**ANSWER:**—For the 50 ozs. of silver it requires about 20 ozs. of pulverized charcoal and from eight to nine pounds of carbonate of soda. This is thoroughly mixed with the silver, placed in a crucible and heated until the fusion is complete. The melted silver is then poured into cold water, which causes the silver to granulate and gather at the bottom. The same method will apply to silver that is to be cast in the mould, except that the molten metal is poured into an ingot in place of the water.

**QUESTION No. 1588.—Domestic and German Sulphuret.**—*Which is the best sulphuret to use for French gray and oxidizing?* D. G. S.

**ANSWER:**—The best sulphuret of potassium to use is the imported German. This is much stronger than the domestic, and comes in very thin flakes, which allows it to dissolve very readily. The cost of the German article is about the same as the domestic, but the German gives a more adhesive deposit than the domestic.

**QUESTION No. 1589.—To Prevent Fire Coat on Silver and Gold.**—*When I solder silver or roll gold articles there is a coating over the work from the heat which I applied. How can I best prevent this?* P. F.

**ANSWER:**—This fire coating can be removed with the acid known as a pickle, but the best way to preserve the surfaces that may have been polished is to brush the surface over with a paste made of water and boracic acid. This should be done before the articles are annealed or soldered. This method may be applied to silver, gold or rolled plate.

**QUESTION No. 1590.—Transparent Cement for Glass.**—*We are often requested to mend broken pieces of glass, especially pieces belonging to clocks, for which we desire a cement that is effective and transparent. How can we make it?* T. C. Co.

**ANSWER:**—Transparent glass cement is made by digesting for a week, cold, one part, by weight, of caoutchouc, 67 parts of chloroform and 40 parts gum mastic.

**QUESTION No. 1591.—Etching Grounds.**—*Will you please give a formula for making a good etching ground, suitable for copper or silver.* E. G.

**ANSWER:**—The following, quoted from the *Scientific American*, will probably answer your question and give you the desired information: The articles to be etched must be covered with a substance which the etching acid will not affect and must be soft enough to allow the finest lines to be drawn with the needle. It should also be susceptible to complete and easy removal when the etching is finished. Varnishes which possess these properties are called etching grounds. They are made according to various formulas, but in all cases the principal ingredient is asphalt, of which only the best natural varieties are suitable for this purpose. Another common ingredient is beeswax or tallow. Etching grounds are usually made in small quantities, at a single operation, by melting and stirring the solid ingredients together and allowing the mass to cool in thin sheets, which are then dissolved in oil of turpentine. The article is coated uniformly with this varnish through which the engraver's tool readily penetrates, laying bare the metal beneath. After the lines thus drawn have been etched by immersing the plate in acid, the varnish is washed off with oil of turpentine. Formulas for etching grounds are: (1.) Yellow wax, 50 parts; Syrian asphalt, 20 parts; mastic, 25 parts. (2.) Yellow wax, 30 parts; Syrian asphalt, 20 parts; mastic, 25 parts. (3.) Yellow wax, 110 parts; Syrian asphalt, 25 parts; amber, 20 parts; mastic, 25 parts. (4.) Yellow wax, 40 parts; Syrian asphalt, 40 parts; resin, 20 parts; tallow, 2 parts; Burgundy pitch, 10 parts.

**QUESTION No. 1592.—Black Stain for Hard Wood.**—*How can I stain hard wood a nice black? I want to blacken such articles as knobs and handles for silver-ware.* B. S. H.

**ANSWER:**—The following is recommended for a black stain for hard wood: 20 parts, by weight of anilin hydrochlorate, dissolved in 300 parts of water, to which solution is added one part of copper chloride. Apply the liquid hot. When it has dried, apply a second solution, consisting of 20 parts of potassium bichromate in 400 parts of water. This stain has great power of resistance, even against acids.

**QUESTION No. 1593.—Silver Soap.**—*How can I make a silver soap? I want to use it for cleaning silverware.* S. S.

**ANSWER:**—For silver soap take 8 ozs. of hard soap, 1½ ozs. of turpentine and 4 ozs. of water. Boil until perfectly dissolved and add 3 ozs. of liquid ammonia.

The jewelry store of John F. Long, at Mackay, Idaho, was robbed recently of \$175 worth of stock. The robbers overlooked a tray containing jewelry worth \$300.

**C. DORFLINGER & SONS,**

36 MURRAY STREET, NEW YORK.

*Works, White Mills, Wayne Co., Penna.*

Manufacturers of plain and cut Table Glassware of the highest quality.



**ENGLISH :: GLASS.**

Large Assortment of  
FANCY VASES,  
GENTRE PIEGES and  
ROCK CRYSTAL STEM WARE,  
Particularly adapted for the  
Jewelry Trade.  
Write for particulars.

Sole Agent for the Celebrated CAULDON CHINA.

**EDWARD BOOTE,**  
46 West Broadway :: New York.



**Hat Pin Holders**

New, Practical, Pretty  
and Quick Sellers

No. 823.  
Hat Pin Holder.  
Ladore.

WRITE FOR PRICES.

**Maple City Glass Co.,**  
CUT GLASS TABLEWARE,  
**Hawley, Pa.**

SALESROOMS:

- New York—H. B. Stites, 253 Broadway.
- Baltimore—Green & Thomas, 33 S. Char St.
- Boston—Sweetser-Bennett Co., 101 Tremont St.
- Buffalo—J. R. Stadlinger, 685 Main St.
- Indianapolis—J. A. Dugan Co., 22 S. Capitol Ave.
- Duluth—Duluth Crocker Co., 6th Ave. W. West St.
- Denver—Western Selling Co., 1617 Lawrence St.

**FANS**

FAN SEASON is here, and we are prepared for it with the choicest line that has ever been imported from Paris. These dainty creations are appropriate for Graduation, Confirmation, Weddings, and in fact for any occasion where taste and exclusiveness are requisite.

**LEWY & COHEN**

530 Broadway, NEW YORK

Importers of Fans, Brooches, Mounted Slide and Back Combs, French Bead Necklaces in mother-of-pearl effects, and THE "MEDICI CHAIN," a new French creation in fan chains.

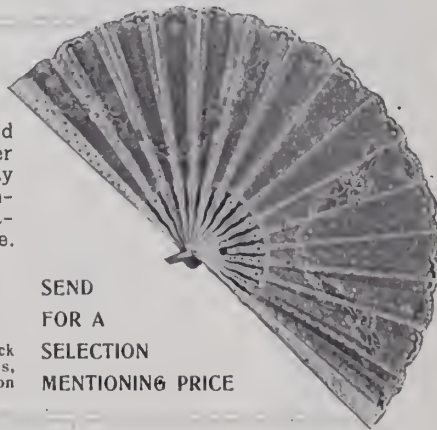

SEND FOR A SELECTION MENTIONING PRICE

**ORNAMENTAL HAT PIN HOLDERS**

A Useful and Artistic Conceit in  
SILVER DEPOSIT ON GLASS

that contributes greatly to  
the appearance of any dresser

MADE IN A VARIETY OF HIGHLY ARTISTIC DESIGNS

Splendid sellers during the vacation period

**LACKNER & OHL**

50 Columbia Street

NEWARK, N. J.



**CROUCH & FITZGERALD**



**Jewelry Trunk and Case**

177 Broadway  
Bet. Cortland  
and Dey Sts

688 Broadway  
723 6th Ave  
New York

**JACOT MUSIC BOX CO  
IMPORTERS.**

Stella and Ideal Music Boxes  
39 UNION SQUARE, N. Y.

"PRACTICAL COURSE IN ADJUSTING"  
Price, \$2.50.

All Jobbers or Jewelers' Circular Publishing

**CLOCKS, BRONZES, CUT GLASS and ART NOVELTIES.**

WHOLESALE DISTRIBUTORS **COMMUNITY SILVER** SEND FOR CATALOGUE

**H. BEALMEAR & CO., 234-236 Park Avenue, Baltimore, Md.**

# THE CONNOISSEUR

*Devoted to Art Pottery, China, Marbles, Bronzes, Cut and Decorated Glass Ware, Bric-à-Brac, Lamps, Art Metal Wares, Fancy Goods and Kindred Lines.*



## The Art School at Birmingham.

Translated especially for THE JEWELERS' CIRCULAR-WEEKLY from *Art et Décoration*.)

The annual competition organized each year between the English art schools, the great advance of that of Birmingham demands attention. The interest is great when an art school prosper in a city whence comes daily such an enormous quantity of works, of ceramics, and particularly wrought metals and jewelry. Birmingham has never passed as an intellectual center. Since it produced Shakespeare it has taken a respite in that regard and is now satisfied with its rapid industrial progress.

The conditions which gave birth to the Art School are exceedingly interesting. At the middle of the last century there was an art school at Birmingham directed by a private society, the Society of Art, and living on a narrow income from the interest of private gifts. These gifts were almost all made by industrial men who wished to elevate the standard of manufacturing production, and stamped the school at the outset with the character which its successive transformations have accentuated. On the pressing appeal from the directors in 1838 Richard Tangye and Cregoe Colmore gave £24,000 sterling on condition that in the future the municipality would assume the direction and charge of the school. The conditions were accepted, the municipality took its charge on a grand scale, which in 1885 became the first municipal art school in England.

In order to serve industry the Art School not only completely penetrates the manufacturing life of the city. Neighborhood schools were built in proximity to the working quarters and arranged so as to receive apprentices during the intervals of their working hours, and give them the same instruction as at the Central School. One of these branch schools, that which is instituted in the quarter of the jewelers and gem workers (Victoria St.), assumed at once an enormous importance, commensurate with that of the jewelry industry at Birmingham. Subsidized by the Jewelers' Association, it was comfortably settled in a building constructed especially for it, and has developed with immense rapidity, showing signs of emancipation.

The Birmingham Art School committee being also administrators of the municipal museum and its collections, is able to lend to the art scholars ancient objects for study. These are changed regularly, as well as those obtained from the South Kensington Museum, and thus one sees in the small collection all the elements necessary

for the study of ancient technique; and by the relations carried on with industrial associations (whence it recruits a part of its members), it maintains an intimate and continuous contact between manufacture and the school. The entire organization is perfect for suppleness and coherence, and this practical sense is felt in every detail.

The immediate contact of articles to be copied is insisted on; drawing is from nature. Banished are the lithographed models, the plaster casts, the stuffed animals. As soon as they know something of geometric design even the youngest scholars are put to the study of plants of simple form. Every morning armfuls of leaves and boughs are brought in and distributed for the day's work. In a small conservatory in the school room are grown many species. Instead of being guarded by solemn statues, the hall of the school room is full of flowering plants, of cut flowers.

The relics which are preserved—a tapestry which belonged to William Morris and a sketch painted by Dante Rossetti—make one understand fully that antiquities are given the cold shoulder in this place, where on top of cupboards in the hall of design one sees the busts of Achilles looking down with terrified eyes on scholars copying carvings.

In this art school there is a menagerie for the use of the students. The animation, the variety, the picturesqueness of this class is extraordinary. The animals are in cages, with wide spaces between bars, so as not to interfere with the students' sight. Golden pheasants, conscious of their beauty, allow themselves to be drawn with ease; while on the other hand a squirrel refuses to be quiet an instant for the designer's pencil. Here, white rats are incessantly looking for an outlet to their cages, and stare with uneasy eyes at the students gathered about them. Yonder a peacock, revengeful of his imprisonment, refuses to unfold his feathers. The animals, whose peaceful nature does not call for their being shut up, are simply placed on tables or pedestals. This animal study demands great effort on the part of students, but renders immense service. Better than any other thing, it forces them to see quickly, to concentrate their attention, to observe a characteristic gesture, to catch a fugitive attitude. It accustoms them to be inspired with what is alive, and to go for that always as the source of their art.

John H. Leroy, who has been engaged in the jewelry business in Fairbury, Neb., is interested in the LeRoy Cutlery Co., which has just engaged in business in Lincoln, Nebr., and which will handle silver plated flat ware.

## Some Interesting Facts About Crown Derby.

IN describing the sample recently put on display in the London show rooms of the Royal Crown Derby Porcelain Co., the *Pottery Gazette*, of that city, says: "Early 'Crown Derby' has a reputation that is now historical. There was, however, a period when the excellent workmanship and artistic taste upon which that reputation was founded was neglected, but the quality and beauties of the old Derby productions have been revived by the present company, whose enterprise has preserved to the town an artistic industry, the product of which will be known to all time simply as 'Crown Derby.' Even the word 'China' is not needed to describe it. So closely is the name of the town identified with the name of the company's industry that it is now synonymous with the name of their ware, which is spoken of as 'Derby.'

"Looking around the large assortment of purely ornamental ware, it will be seen that the Georgian period furnishes the style for the present day forms and ornamentations. The present partiality for 18th century furniture and decorations is fostered by the company's reproductions of their famous ware of that period. In many instances the exact shapes and embellishments are revived; in others new forms are treated in the old style—light, graceful decorations on light-toned and white grounds. The festoon and wreath schemes, which were so popular in the late 18th century, are in existence to-day—particularly the floral festoon primrose ground.

"There is, as usual, a brilliant show of the remarkable Japan patterns, for which the works have so long been famous. These are striking combinations of color and gold. Speaking of art forms, the figures of the best days of old Derby cannot be surpassed for fineness of modeling and beauty of finish, but it is, perhaps, not too much to say that they are equaled by the company's productions to-day."

## Relics of Viking Jewelry Work.

IN the remains of a Viking ship recently unearthed, on an island off the coast of Sweden, one of the objects found was a well-polished crystal, hemispherical in shape and nearly two inches in diameter. Near the glass was a tiny pair of pincers, similar to those used by modern goldsmiths. Several pieces of goldsmiths' work were also discovered. It would seem that, rough as the Vikings were, they made use of microscopes for delicate gold work.—*British Weekly*.



# ART Leather Goods

We now have on exhibition in our New York Salesroom a choice collection of  
**EUROPEAN NOVELTIES**

IMPORTATION ORDERS SOLICITED

**C. F. RUMPP & SONS**  
Philadelphia

New York Salesroom, 683 and 685 Broadway



## The Thimble House.



No. 149.

Thimbles are not a side line with us—They are our main business. We study Thimbles, our designers study thimbles, our workmen study thimbles—The result is the finest and largest line of Thimbles on the Market.

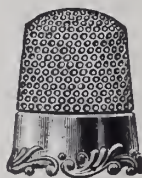

No. 136.

**KETCHAM & McDOUGALL,**

Manufacturers,

37 @ 39 Maiden Lane, New York.

Send for Catalogue.

Established 1832.

ALSO MAKERS OF THE NEW AUTOMATIC EYE-GLASS HOLDERS.

## FAIRCHILD & COMPANY

225 to 233 Fourth Ave.

NEW YORK CITY.

Manufacturers of GOLD PENS, PENCILS, PENHOLDERS, SEGAH CUTTERS, SPECIALTIES, PENCILS SET WITH JEWELS.

Style, quality and workmanship acknowledged the very best.



## SIGNS

NOTHING like metal signs for permanency and richness. The first cost is trifling. They last for years. Engraved brass and sawed metal letters are the 18 K. kind.

"No trouble to ship out of town."

**THE FORMAN CO**  
**SIX LIBERTY PLACE**  
NEAR MAIDEN LANE ··· NEW YORK

## STUDY

THE ORIGINAL SCHOOL. Instruction by mail adapted to every one. Recognized by courts and educational authorities. Experienced and competent instructors. Takes spare time only. The courses—Preparatory, Business, College. Prepares for practice. Better your condition and prospect in business. Students and graduates everywhere. Full particulars and special offer FREE.

## LAW

## AT

## HOME

THE SPRAGUE CORRESPONDENCE SCHOOL OF LAW, 733 MAJESTIC BLDG., DETROIT, MICH.



## The ST. JAMES

Corner Walnut and Thirteenth Streets  
PHILADELPHIA, PA.

The Ideal Hotel of Philadelphia  
European Plan EUGENE G. MILLER, M.

*Mercantile Fountain Pen*

## The Best Self-Filling Attachmen

made and guaranteed by

**AIKIN, LAMBERT & CO.,** 19 Malden Lane  
NEW YORK.

Retail Price:

\$3.00

\$3.50

\$4.50

Send for Price Lists and Discounts.



**European Pawnshops.**

(Continued from issue of June 6.)

**THE SYSTEM IN PARIS, FRANCE.**

Consul General Mason, of Paris, Consul General Roosevelt, of Brussels, and Vice Consul General Mueller, of St. Petersburg, have made reports concerning pawnshops in those cities. Consul General Mason says that the municipal pawnshop system of Paris is a venerable institution, having been founded in 1777. It is a distinct bureau of municipal government and includes in its control three members of the committee of public charities, three private citizens and the prefect of police. There is a main office and 21 branch offices. It is organized and administered to fulfill a distinctly philanthropic and useful purpose of enabling persons of limited means, or overtaken by misfortune, to obtain at a not excessive rate of interest money to meet pressing necessities without the sacrifice of their self-respect or the necessity of falling into the hands of extortionate usurers who in most foreign countries prey so rapaciously upon the victims of poverty and misfortune.

In the latest year for which complete statistics were obtained was 1904. During that year 1,449,168 loans on jewelry, clothing, watches, etc., were made of the average amount of \$6.46 each, and the total sum loaned was \$9,361,625. Besides these there were made during the same year 3,619 loans of \$200 or more each, the total sum of which was \$1,709,832. The rates of interest charged amounted in all to 8 per cent. on jewelry, articles of clothing, household equipments, etc., and 6 1/4 per cent. on stocks, bonds and other securities deposited as collateral. Articles forfeited by non-payment or failure of renewal are sold at auction by a class of special auctioneers, of whom there are fourteen, located in different parts of the city. If a greater sum is obtained for the article than that which was loaned thereon, the pawnshop owner may claim and recover the difference. In 1904 the profit above expenses amounted to \$992,417, which, after the deduction of various incidental obligations, is turned over to the fund for the support of municipal hospitals.

This is an official monopoly; no other pawnbroker is allowed to exist or do business within the limits of the municipality. Besides there is a class of outside operators whose traffic forms the one really sinister feature of the whole system. These are the brokers or dealers in pawn tickets, who work more or less secretly. It frequently happens that a person who has pawned an article wants more money than he has been able to obtain at the municipal pawnshop, which does not exceed one-third of the real value of the article. He goes with this pawn ticket to the broker, who lends him 2 per cent. of the face value of the ticket, but at an extortionate interest of from 3 per cent. to 7 per cent. per month. If this interest is not paid when due the broker redeems the article, which he sells at one of the auctions, and thereby reaps a large profit.

Various measures have been proposed to counteract this evil, but nothing satisfactory has yet been devised, and it is generally conceded that the only effective remedy would be for the pawnshop to lend on each

article a much larger percentage of its value and then keep the pawn ticket until the property were redeemed or forfeited by limitation. One of the obvious advantages of such a pawnshop system is that, being a Government institution, no discredit necessarily attaches to the act of making use of the facilities which it offers. People in good circumstances, who are leaving the city for the summer, not infrequently take jewelry and other valuables to the Mont de Piété, or pawnshop, borrow a nominal sum on them and thus secure their safekeeping with little expense.

**MANAGEMENT AT BRUSSELS, BELGIUM.**

Consul General Roosevelt says that the Brussels Mont de Piété was established in 1810, since which date it has exercised its functions without interruption. The legal rate of interest charged on loans is 6 per cent. per annum. It is the intention of the administration to apply for authorization to reduce this rate to 3 per cent. per annum for loans less than 5 francs (96 cents).

The administration of the pawnshop system in Brussels is somewhat similar to that in Paris. The mayor of the city is by right president of the board when he attends its meeting. The pawnshops in Belgium are organized under the direction of the communal council, which approves the budget and accounts. These shops are not allowed to receive money on deposits, or as investment, or under any form whatever from private parties. When the funds run short the administration has the right to borrow from the public charities and hospitals, or from the communal administration, paying for such loans an annual interest of 3 1/2 per cent. During the year 1905 the establishment loaned on 312,794 pledges \$1,253,173. The net profit for the year was \$6,401. The Brussels pawnshop is under the management of three appraisers and other officers. It is obligatory that one of the three appraisers must be an expert gold and silversmith. The officers are obliged to keep a daily record of the transactions of their respective departments, which are collected and compared daily before the evening closing. The records of the redemption office are constantly verified and balanced with the receiver's books in such manner as to avoid error. Sales are public and periodical, but no object can be sold until the expiration of 14 months from the time it was pawned. Surplus not claimed within two years after the sale reverts to the establishment.

**PAWNSHOPS OF ST. PETERSBURG, RUSSIA.**

Vice Consul General Mueller, of St. Petersburg, reports that there are six institutions loaning money on chattels at a rate of interest stipulated by their by-laws, as follows:

- (1) The State Loan Office (controlled by the central government). The rate of interest is 6 per cent. per annum. Only gold, silver, precious stones and valuables are accepted here. Such articles are also taken for safekeeping at a low rate of interest for storage and insurance.
- (2) Society for pawning chattels.
- (3) St. Petersburg Company, for storage and pawning chattels and goods.
- (4) St. Petersburg City Loan Office.
- (5) St. Petersburg Private Loan Office.
- (6) St. Petersburg Municipal Loan Office, organized in 1898. Paid-in capital, 2,000,000 roubles—about \$1,000,000.

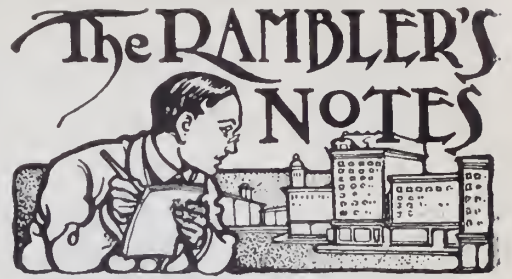

IMPORTED NOVELTIES  
IN GREAT VARIETY.

NEVER before has there been seen in the salesrooms of Schwarz Bros. & Co.,

29 Union Sq., New York, so varied and rich lines of foreign novelties, and this is saying a great deal, for the displays of past seasons have been notably attractive. The buyer's attention is caught as he enters by the sweet tones of the chimes, which are fastened to each door, thus announcing in a pleasing manner the entrance of each visitor. These harmonious tubes, which may also be used as dinner calls, come in five sizes and are themselves distinct novelties. In a collection of brass products are new shapes in desk and smoking sets, cigar holders, ash trays, paper cutters and other useful articles. These are shown in several kinds of finish, such as natural brass, dull and highly polished finish. The large pieces are ornamented with clever etchings of female heads and other pleasing subjects. The same articles have also been made up in brass in a Pompeian finish, and still another line is lacquered. To give even greater variety to this department there has also been obtained an assortment of articles in brass in a somewhat rougher finish. These specimens have been sawed by hand, producing pretty patterns. Empire shaped metal figures in iridescent colors, all small articles fashioned in amusing shapes, will appeal to a considerable part of the trade. In horn goods with glass mountings there are shown especially elaborate and beautiful specimens. Smoking sets, baskets and umbrella stands, are displayed, some showing notably large horns. Another collection recently received comprises bronze plaques in which hunting scenes are represented in high relief and in colors. There is also an excellent assortment of bronze frames for paintings.

ATTRACTIVE LINE OF  
GLASS WARE.

AN attractive line of engraved glass ware from the Seneca Glass Co.'s

works at Morgantown, W. Va., is shown in the New York salesrooms of Cox & Laferty, 32 Park Place, New York. The stems are cut on stone and the engraving is similar to rock crystal in its effects, although not cut as deeply as most lines of the latter ware. A floral design runs through the collection of samples which comprises practically everything in stemware.

THE RAMBLER.

M. Sievert, La Crosse, Wis., found a pearl in the Black river, which weighed 13 1/2 grains and was of brilliant luster. It is believed to be worth \$500, having been so valued by an expert.

# HOLTZER-CABOT JEWELERS' MOTORS

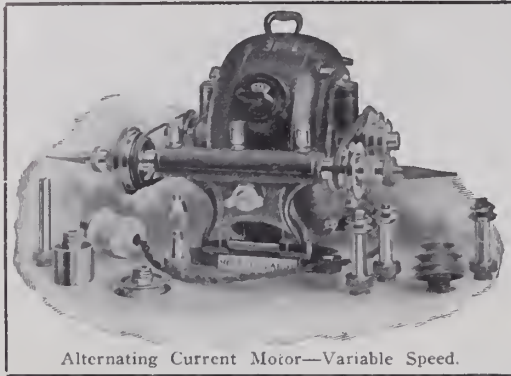

Alternating Current Motor—Variable Speed.

for *BUFFING* and *GRINDING*  
 have had a four years' trial in practically all classes of work. Made for Alternating and Direct Current Circuits, in sizes—1/5 to 1 H. P.—to carry buffing and grinding wheels up to 10 inches diameter.

A full line of chucks for all requirements.

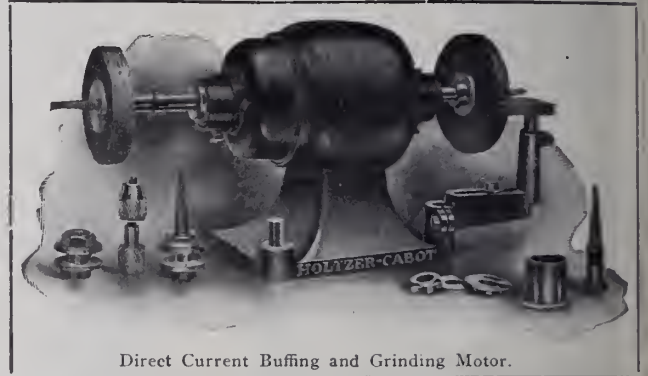

Direct Current Buffing and Grinding Motor.

All our motors are covered by a guarantee of one year.

Write and tell us what class of work you would like to do and we will send you our Form 409, "Special Announcement and Proposition to Jewelry People—

**A LATHE MOTOR ON TRIAL."**

**THE HOLTZER-CABOT ELECTRIC CO., Boston (Brookline), Mass.**

CHICAGO OFFICE, 395-7 Dearborn Street.

**HERPERS BROS..**  
 MAKERS OF  
**BRACELET**  
**SETTINGS**  
 IN 10, 14 AND 18 KARAT GOLD  
 AND IN PLATINUM.  
 ALSO A COMPLETE LINE OF  
**GALLERIES**  
 12 NEW PATTERNS  
 OFFICE AND FACTORY NEWARK, N. J., U. S. A.  
 NEW YORK BRANCH 41-43 MAIDEN LANE

**THE WASHBURN SECURITY MAGIC NUT**  
 Automatic Holder for all sizes of scarf-pin wire. Guaranteed. for ear studs, scarf pins, etc.

**EAR WIRES**  
 for unpierced ears.

**SAFETY CATCHES**  
 For brooches, etc. Can be applied to any work where pin tops are used.

Open. Closed. Open. Closed  
 Descriptive Circular on Application.  
**Pearl Drilling and Adjusting a specialty**  
 Special Order Work and Repairing.  
 C IRVING WASHBURN, 12-16 John St., N. Y.

## E. H. H. SMITH SILVER CO.

BRIDGEPORT, CONN.

Silversmiths' Building,  
 CHICAGO, ILL.

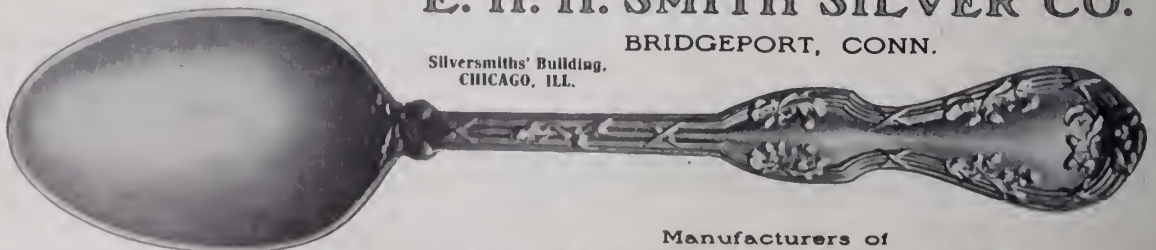

THE OAK.

Manufacturers of

**Sterling Effects in Plate**

# Reduced Rates for Telephone Service

throughout Greater New York are effective from July 1st. Contracts now being taken at new rates.

Call nearest Contract Office for full information.

## NEW YORK TELEPHONE COMPANY

<i>Contract Offices:</i>	<i>Telephone No.:</i>
15 Dey Street	9010 Cortlandt
15 West 38th Street	9040 38th
20 West 124th Street	9000 Morningside
16 East 150th Street	9020 Melrose



No Springs  
No Screws  
CAN BE PUT  
IN A TRUNK

THE PERFECT SHAPE UMBRELLA

## “MAIDEN BALTIMORE”

IT IS now nearing the time when Jewelers are looking toward purchasing their stocks for the Fall and Holiday seasons in Umbrellas and Canes. We are prepared with our line, which we have specially designed for the Jewelry Trade. It consists of rare novelties, and things entirely new and exclusive.

Our Detachable Handle Umbrella has met with great favor, and will increase your Umbrella Business, as it is the only

one on the market without levers, springs or screws.

We make Umbrellas from \$1.50, with Sterling Silver and Gold Handles, up to \$125.00 each, and Canes from 50 cents up to \$25.00 each. *Send for a Selection, Express paid.*

## SIEGEL, ROTHSCHILD & CO.

MAKERS

418-420 West Baltimore Street, BALTIMORE, MD.

NEW YORK SALESROOM  
353 Broadway

PHILADELPHIA SALESROOM  
1011 Chestnut Street

## Opportunity

knocks at everyone's door at least once. This is yours if you would realize full value on your sweeps, etc.

## CONLEY & STRAIGHT,

Gold and Silver Refiners,  
Assayers and Sweep Smelters,

36 EDDY STREET, - PROVIDENCE, R. I.

dealers in Fine Gold, Silver and Copper. All kinds of Gold and Silver Anodes.

## F. JEANDHEUR, Jr.

Bar 17 John St., N. Y. Third Floor.

Gold and Silver Plating  
SPECIAL WORK AND COLORING  
IN ALL SHADES A SPECIALTY.

Established 1868. Platina Plating.

## JAMES J. DONNELLY,

Gold and Silver Electro Plater,  
Fire Gilder and Colorer,

49 and 43 Maiden Lane, New York.  
Prompt Attention Given to Mail Orders.

## Trade-Marks of the Jewelry and Kindred Trades.

Send Edition. Price, \$3.00. The Jewelers' Circular Publishing Co., 11 John St., New York.

Frank Dederick.

Established 58 Years.

James E. Dederick.

## James H. Dederick's Sons, Assayers and Bullion Dealers.

All qualities of Gold and Silver, in Plate, Square and Round Wire, Rolled to any gauge.

ALL QUALITIES OF GOLD AND SILVER SOLDER.

16 Maiden Lane, .. .. NEW YORK.

We buy Old Gold and Silver.

Established 1879.

Manufacturer of

## LOUIS W. HRABA, Fine Leather Goods,

29 East 19th St., New York.

Exclusively for the Jewelry Trade.

## WM. SMITH & CO.,

Office, 9-13 Maiden Lane, N. Y.  
Manufactory, 61 Peck St., Providence, R. I.

Established 1854.



## GOLD AND SILVER CHAINS,

Gold, Silver and Plated Chain Trimmings,  
Also GOLD AND SILVER KEY CHAINS AND BRACELETS.



## HERMAN KOHLBUSCH, Sr.,

ESTABLISHED 1859.

Manufacturer of Fine Balances and Weights  
for every purpose where accuracy is required.

Office and Salesroom, 194 BROADWAY, NEW YORK.

Send for Price List.

Tel. 370 Cortlandt.



## DIAMOND POINT FOUNTAIN PENS



No. 2WC \$7.50 per dozen. Guarantee in every box.

Largest Manufacturers of Popular Price Fountain Pens in the United States.

Send for illustrated price list of 14-Kt. Gold Fountain Pens.

Good case assortment 1 dozen pens, \$9.00.

DIAMOND POINT PEN CO.

100-102 Beekman Street, New York

TELEPHONE 178  
38th Street

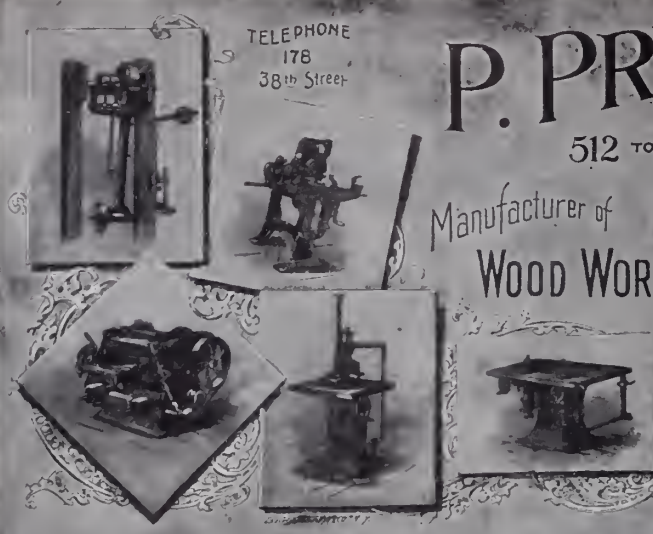

# P. PRYIBIL,

512 to 524 West 41<sup>st</sup> Street,  
NEW YORK.

Manufacturer of  
**WOOD WORKING MACHINERY.**  
BRASS, IVORY,  
HORN WORKING,  
SPECIAL MACHINERY.  
SHAFTING, PULLEYS & HANGERS.

## BLANCARD & CO.,

96 MAIDEN LANE,  
NEW YORK.

WELL MADE GOLD FINDINGS.

## WM. F. RENZIEHAUSEN CO.,

GOLD and SILVER REFINERS  
Sweep Smelters, Assayers and Analytical Chemists

Rolling of FINE AND STERLING SILVER a Specialty.

Long Distance Telephone, 3759-R. 45-49 Oliver Street, NEWARK, N. J.

### Horological Department,

**BRADLEY POLYTECHNIC INSTITUTE**  
Formerly Parsons Horological Institute  
PEORIA, ILLINOIS.

Largest and Best Watch School in America  
We teach Watch Work, Jewelry, Engraving, Clock  
Optics. Tuition reasonable. Board and rooms  
school at moderate rates Send for Catalog of Informa

## PATENTS

obtained on inventions and designs. Trade  
marks, prints and labels registered

**R. W. BISHOP,**  
ATTORNEY AT LAW,  
908 G Street N.W., Washington, D. C.

## JOHN S. STIVEN,

Gold and Silver  
Chaser.

Room 219, Electrical Exchange Building,  
136 LIBERTY STREET. NEW YORK.

### Encyclopedia-Dictionar

and reference hand-book of the Ophthalmic Sciences  
Price, \$2.50.  
The Jewelers' Circular Pub. Co., 11 John St., N. Y.

HONEST AND  
**PROMPT RETURNS FOR YOUR OLD GOLD, SILVER, FILINGS, SWEEPINGS & C.**

## WE BUY

Old Gold and Silver Filings, Polishings, Sweeps, Hand Washings, etc. We will make accurate valuations and hold consignment subject to your acceptance. If valuation is not satisfactory, we reship to you at our expense.

### WE PAY FOR OLD GOLD:

22 K. 88c. per dwt.	12 K. 48c. per dwt.
20 K. 80c. " "	10 K. 40c. " "
18 K. 72c. " "	8 K. 22c. " "
16 K. 64c. " "	6 K. 24c. " "
14 K. 56c. " "	4 K. 16c. " "

MARKET RATES FOR SILVER AND PLATINUM.

Try us and you will appreciate our Squareness, Promptness and Accuracy.

**T. B. HAGSTOZ, Ltd.,** Main Office, 709 Sansom St., Philadelphia, P  
SMELTERS, ASSAYERS, REFINERS.

## WE SELL

Gold, Silver and Platinum, various qualities, rolled flat drawn to wire of any gage.

### PRICES OF ALLOYED GOLD:

10 K. 48c. per dwt.	14 K. 64c. per dwt.
12 K. 56c. " "	16 K. 72c. " "
18 K. 80c. per dwt.	

Gold and Silver Solder, either from formulas furnished or our own, "T. B. H." Alloy, 25c. per oz. Guinea Gold 75c. per lb. Shot Copper, 40c. per lb. We will send tables for alloying without charge. They save figuring.

# PLATINUM AMERICAN PLATINUM WORKS

NEW YORK OFFICE  
41 Cortlandt Street  
NEWARK, N. J.





M2297

# FAHYS Montauk Case



M2285

The Montauk Case might well be termed the "Old Reliable" 20 year case; it has seen many 20 year cases placed on the market which have gradually been discontinued or disappeared.

The Montauk Case has withstood competition under trying conditions and has come out ahead.

Every improvement that is known to the case maker's art is embodied in the Montauk; it is a case that sells on its own personality—and on its true merit.

JOSEPH FAHYS & CO.

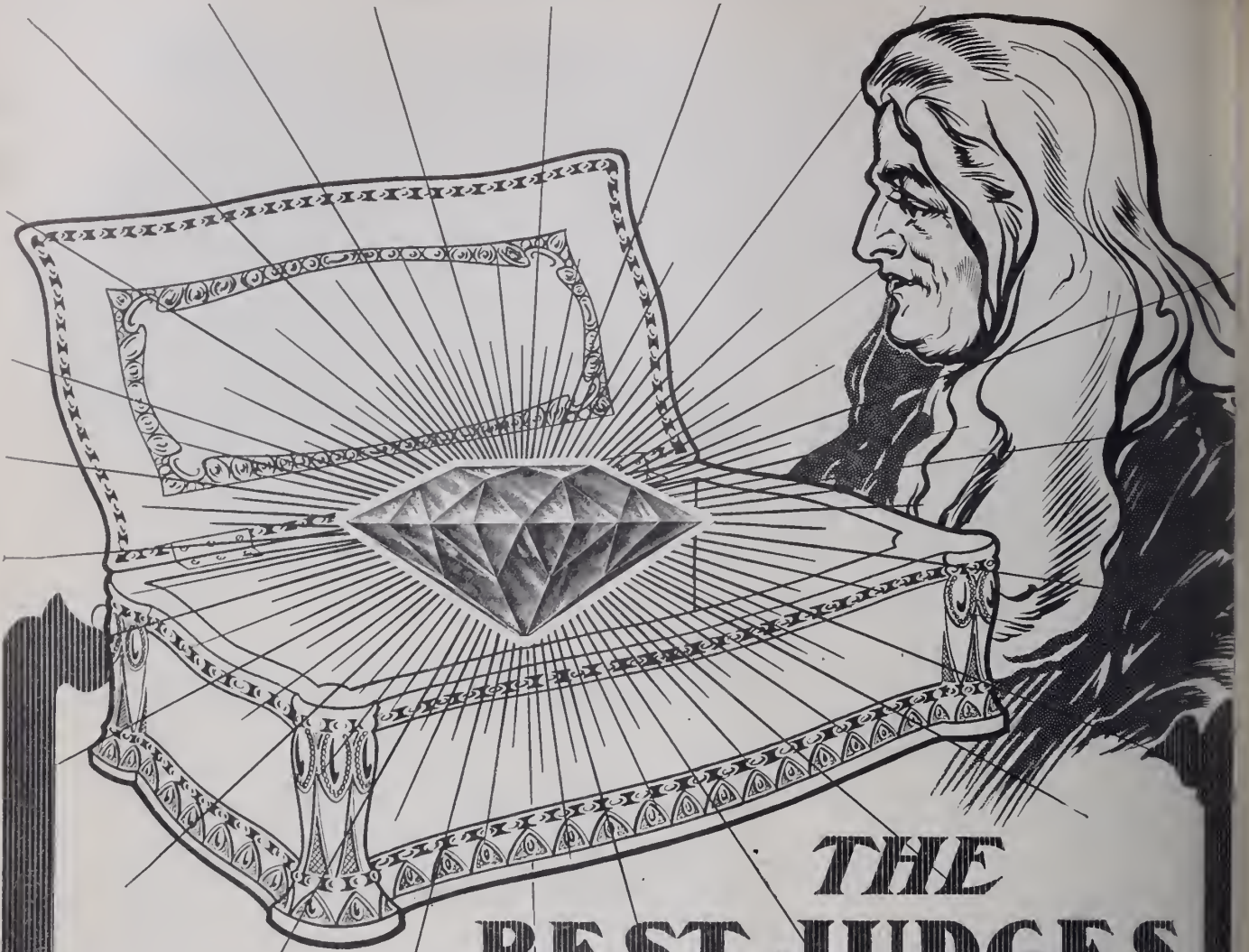

## THE BEST JUDGES

Are the most critical as to the cutting, when considering the worth of a diamond—it's the cutting that makes the diamond brilliant—it's because of its brilliancy that the diamond is so highly prized.

The diamonds we offer are cut in our own cutting works, and no effort spared to see that they are cut right. The price we ask for them—the actual cost of the rough stone, plus the workmen's wages, with our modest profit added.

---

**J. R. WOOD & SONS,**  
Diamond Cutters,

Cutting Works:  
1327-1329 Atlantic Ave., Brooklyn.

2 Maiden Lane, New York.





## We Stand Behind Everything We Sell

guaranteeing it to be exactly what it is represented to be.

You can be perfectly sure that you are getting the quality you think you are buying, and that the workmanship is the very best obtainable—while you are paying nothing extra for this, for our prices are the lowest it is possible to furnish honest goods for.

---

**J. R. Wood & Sons,**

RING MAKERS.

2 Maiden Lane,

New York.

# Design, Workmanship, Quality and Durability

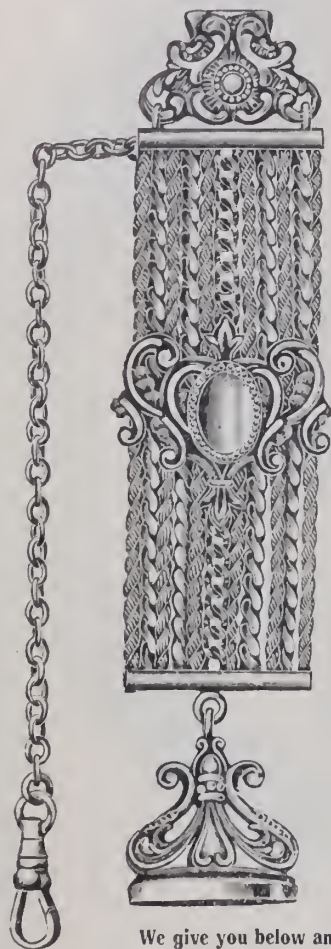

are the four factors which have made the

## BIGNEY CHAINS

the most popular in the market to-day. They are handled and worn by more people than any other make.



We give you below an exact copy of an assay of chains manufactured by the leading chain makers of the United States.

1-10 GOLD FILLED WATCH CHAINS, MINUS BAR AND SWIVEL.

Number	Gross Weight		Fineness Gold 1000ths	Value	Maker	Chain Number	Cost	
	Ounces	Dec.						
15		71	29½	\$0.43	S. O. Bigney & Co. - - - -	1155	\$2.85	
16		75	50	.775		482	3.08	
17		81	34	.57		3005	2.73	
18		76	23½	.37		9533	2.97	
19	1	00	16½	.34		83	2.14	
32		52	49½	.53		213 X	2.83	
34		73	34½	.52		733	2.41	
46				.58			5011	3.82

1-8 CHAINS, MINUS BAR AND SWIVEL.

Number	Gross Weight		Fineness Gold 1000ths	Value	Maker	Chain Number	Cost
	Ounces	Dec.					
35		57	68	\$0.80	S. O. Bigney & Co. - - - -	1604	\$3.96
36		60	65½	.81		7015	3.75
37		60	63	.78		4324	4.00
47		49	79	.80		2726	4.00

# S. O. Bigney & Co.

NEW YORK OFFICE,  
3 MAIDEN LANE.

FACTORY, Attleboro, Mass.



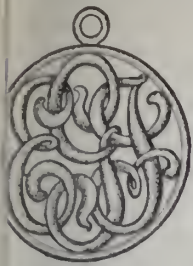

No. 301.



No. 302



No. 305.



No. 303.



No. 300.



No. 3.



No. 18.



No. 11.



No. 14.



No. 15.



No. 317.



No. 306.



No. 196.

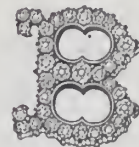

No. 307.



No. 318.



No. 209.



No. 322.



No. 208.

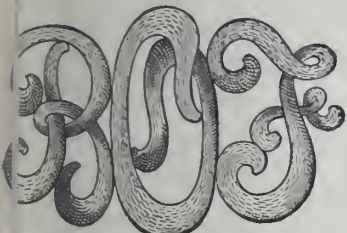

No. 316.



No. 321.



No. 320.

# Wendell & Company

MAKE

## GOLD MONOGRAM CHARMS, FOBS, SLIDES, BROOCHES AND RINGS.

SILVER MONOGRAMS for BROOCHES, BELT ORNAMENTS and CLASPS; also for LEATHER BAGS, PORTFOLIOS, MUSIC ROLLS AND ALL KINDS OF EBONY, IVORY AND TORTOISE SHELL GOODS.

ALL ORDERS PROMPTLY EXECUTED.

103 and 105 WILLIAM STREET  
NEW YORK

} 2 FACTORIES: {

57 WASHINGTON STREET  
CHICAGO

## WHY

are the **WADSWORTH WATCH CASES** the most attractive line on the market?

## BECAUSE

they are a Brand New line—new engravings, new styles, finest finish, up-to-date in every respect.

## CERTAINLY

you should familiarize yourself especially with our **PILOT** (25 year), our **TWENTY YEAR** and our **PERMANENT**.

Are you numbered among the thousands of satisfied dealers who have distributed more than one million **Wadsworth Watch Cases** in 17 years?

We are satisfied that careful investigation and a comparison with other makes will convince you that there is merit, worth and wear in **Wadsworth Solid Gold** and **Gold Filled Watch Cases**—the most profitable and best selling cases you can handle.

**I**T is the unanimous opinion of those jewelers who have examined the new O and 12 size movements of the ILLINOIS WATCH CO. that they are the best watches in these sizes ever manufactured in America.



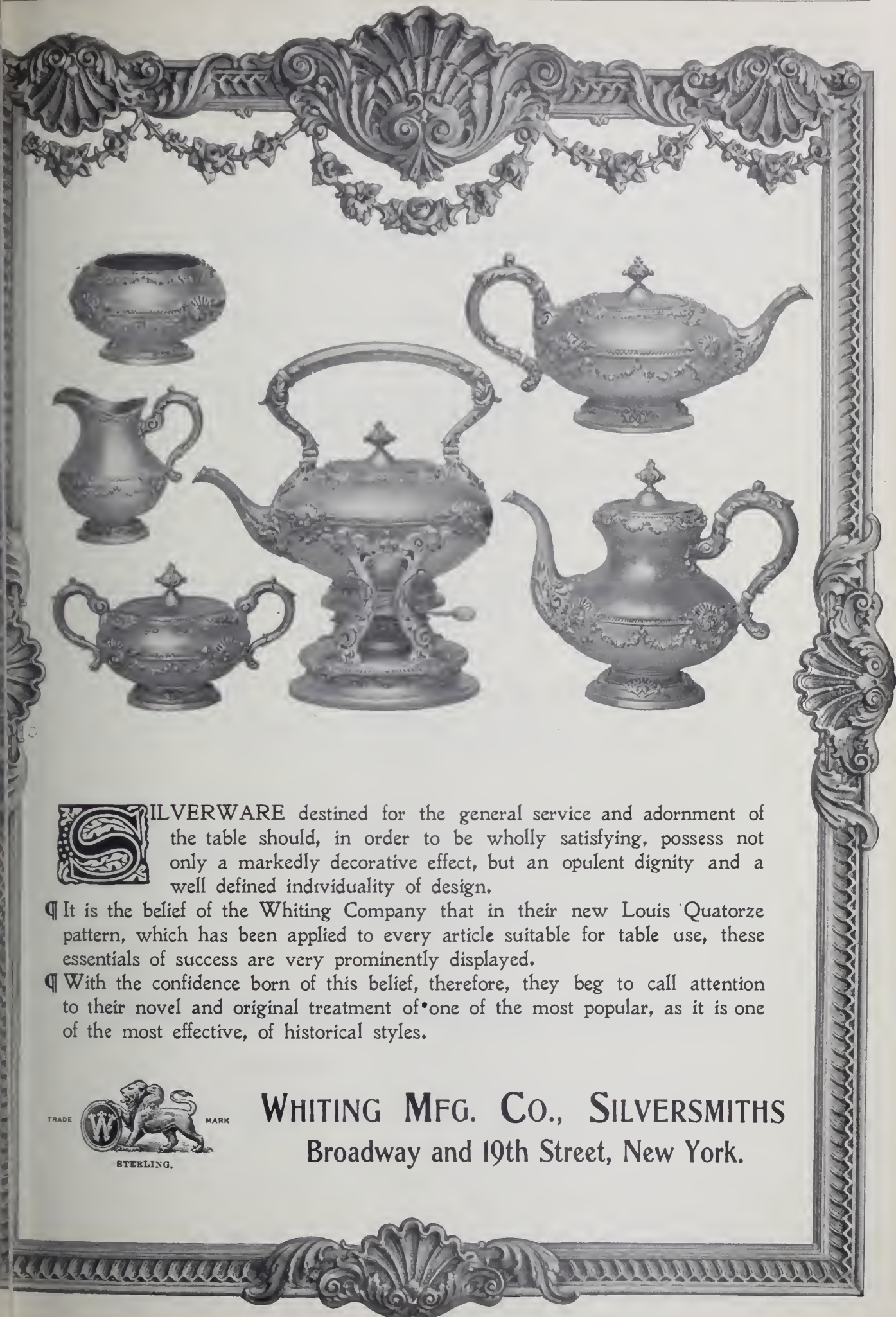

**S**ILVERWARE destined for the general service and adornment of the table should, in order to be wholly satisfying, possess not only a markedly decorative effect, but an opulent dignity and a well defined individuality of design.

¶ It is the belief of the Whiting Company that in their new Louis Quatorze pattern, which has been applied to every article suitable for table use, these essentials of success are very prominently displayed.

¶ With the confidence born of this belief, therefore, they beg to call attention to their novel and original treatment of one of the most popular, as it is one of the most effective, of historical styles.



**WHITING MFG. CO., SILVERSMITHS**  
 Broadway and 19th Street, New York.

# Progression

This word signifies the course, and

# Success

indicates the goal attained by

## Dueber-Hampden Watches

**Pre-eminently and indisputably the  
Successful American Watches**

in all sizes and grades.

Requiring no assistance but their own inherent value to find a market, and depending on no combination to bolster up weakness and lend help to force sales, they should be valued accordingly by fair-minded, independent, self-respecting Americans.

## The W. J. JOHNSTON COMPANY,

Wholesale Agents of the Leading American Watch Companies,

**Fifth Avenue and Market Street, Pittsburgh, Pa.**

# Looking Forward

is ever necessary

## To the Successful Merchant.

**What you sell to-day is responsible  
for your future Reputation  
and Prosperity**

If poor judgment is used you are entitled to no more excuse than though you had deliberately sold what you knew to be inferior goods.

There is always "**THE BEST,**" and in watches that term stands out prominently for

# Illinois Watches and Hamilton Watches

**The W. J. JOHNSTON COMPANY,**

Wholesale Agents of the Leading American Watch Companies,

**Fifth Avenue and Market Street, Pittsburgh, Pa.**



# The Sternau Traveling Companion Serviceable Indoors and Outdoors



View Ready for Use. Height, 8¾ inches.

JEWELERS can increase their sales by stocking Sternau Traveling Companions, which are the most useful articles for preparing hot luncheons when camping or yachting. ☐ For use in the nursery and the sick-room, for heating milk and broths and cooking cereals, they are of inestimable value. ☐ Being clean, neat, compact, and exceedingly convenient, they are used by tourists, travelers, sportsmen, picknickers, etc.

Made in Nickel-plate and Silverplate.

☐ Circular No. 251 of Traveling Companions, sent on request.



View Showing the Parts Inside the Cup. Height, 4½ inches.

New York Salesrooms:  
Broadway, cor. Park Place,  
Opposite Post Office.

**S. STERNAU & CO.**  
*Makers of Chafing Dishes, Coffee Machines, Fancy  
Kettles, Smoking Sets, etc.*

Office and Factory:  
195 Plymouth Street,  
Brooklyn, N. Y.



## A TEST FOR THE EYES



IF YOU CANNOT, at a distance of fourteen inches from the eyes, plainly see the benefit of looking over our line, then it is conclusive that you need your eyes examined. Our



No. 600.

Locket

Brooches

Scarf Pins

Buttons

Bracelets

Tie Clasps

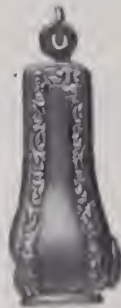

No. 602.

Match Boxes Pen Knives

Cigar Cutters Fobs

Heart Charms Bead Necks  
Etc.



No. 601.

are of that quality, design and workmanship that make them essential to a progressive jeweler's stock

**ROBT. LEVY,** Manufacturer of 10K. THAT IS 10K  
Green and Columbia Streets, Newark, N. J.

*"We never follow the Fashion, the Fashions Follow Us."*

MAURICE L. POWERS.



JOSH W. MAYER.

## IMPORTANT STONES.

THE different lots of Diamonds, Pearls, and other precious stones procured by this firm from abroad, have now been carefully assorted and most of them are being mounted for the exhibition goods.

Any jeweler in need of Diamonds, Pearls, Rubies, Emeralds, Sapphires or any other precious stones, will find our line of loose material one of the largest in this city to-day. No matter what your order may call for, either in loose or mounted goods, we have exactly what you desire.

Not alone will the Jewels to be displayed in our exhibit be the most prominent feature—it is the magnificent single pieces of loose material in Diamonds and Colored Stones of unusual merit that will bring the exhibit to the highest standard of completeness.

There is scarcely a happier interval to an up-to-date jeweler than that between a piece of distinctively exclusive jewelry and the knowledge that its counterpart does not exist. The merit of one and the anticipation and satisfaction of the other suggest our productions to those who are accustomed to, and most discriminating in, selecting fine and exquisite Diamond Jewelry.

To be fully convinced of all the details of our advertising in the past few weeks, we ask you to kindly view this remarkable display which will take place in our offices between August 13th and 18th inclusive.

Once a visit always a visit.

### POWERS and MAYER,

Makers of Diamond Mounted Jewelry THAT SELLS.

258-260 Fifth Avenue,  
NEW YORK.

We are always pleased to ship goods on memorandum when satisfactory references are given.

We Make

# BRACELETS

both in Joint and Nethersole—with and without stones.  
Call on us for the P. & B. Co. lines of

FOBS, LOCKETS,  
TIE CLASPS, BROOCHES,  
SCARF PINS,  
HAT PINS.



BABY PINS, BEAD NECK,  
CUFF BUTTONS,  
CROSSES, BRACELETS,  
AND WAIST SETS.



We are the largest  
Exclusive Makers of  
10K. Jewelry.

Potter  
&  
Buffinton  
Co.,  
Providence,  
R. I.

NEW YORK OFFICE,  
65 Nassau Street.

San Francisco Office,  
206 Kearny Street.



Our New  
ACME  
Joint.  
Pat. May 22 1906.



## THE Bracelet Hit OF THE Season.

THE illustrations, which are exact size, show two of the best selling Bracelets of a big bracelet season.

Made of Rolled Plate, Pierced, Engraved—a neat, strong joint and catch—with and without stones, from ½ to 1¼ inches wide.

Our line offers an unsurpassed range of styles.

ASK YOUR JOBBER—HE HAS THEM.

**WHITING & DAVIS, Plainville, Mass.**  
NEW YORK OFFICE, 7 MAIDEN LANE.

GOLD  
**RINGS**

BROOCHES AND MOUNTINGS

Also GOLD FILLED RINGS, including the popular THREE CROWN

Ostby & Barton Company respectfully announce to the jobbing trade that their fall line comprising many new and original designs is now ready.

**OSTBY & BARTON COMPANY**

New York, 13 Maiden Lane  
 Chicago, 103 State Street

PROVIDENCE, R. I.

**BATES & BACON,**

NEW YORK OFFICE  
 9 Maiden Lane

ATTLEBORO, MASS.

CHICAGO OFFICE  
 103 State Street

Makers of

HIGH GRADE CHAINS.

The BEST SAFETY FOB is one of our specialties; Gent's Vests, Dickens, Lorgnettes, Secret Locket Chains, Locketts, Chate-laines, and the unexcelled

**"Bates" Bracelet**

"KANT-KUM-OFF"

**Seven Sizes.**

Just the **Bracelet** to be worn over the **Long Gloves** so much in **Fashion.**

**NO HUNTING** for the Invisible Catch.  
**Just PULL and TWIST.**

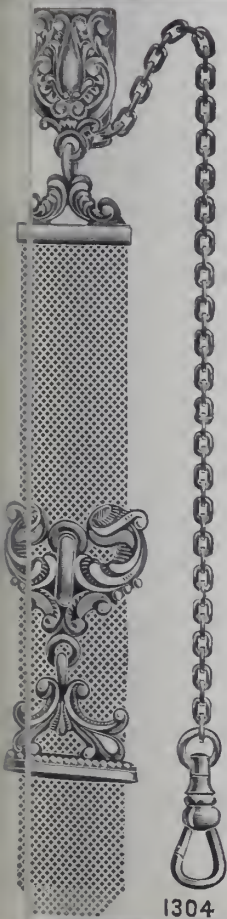
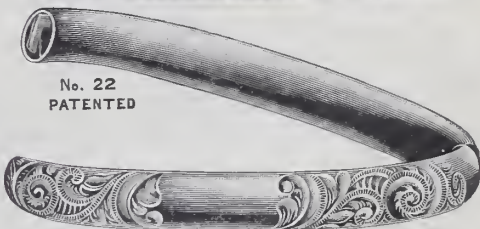

# The "Bryant" Rings.

WE have made the **Bryant Rings** for 50 years, and know how to make first class goods. The stone setting—which every retailer knows is a very important part of the work—we give special attention to. The **Bryant Rings** will help your reputation as a first class Jeweler.



TRADE-MARK.

**M. B. BRYANT & Co.,**

No. 7 MAIDEN LANE,  
NEW YORK.

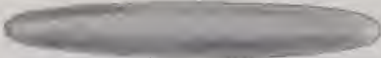

Quality and Finish Consistent  
with twenty years' experience.  
Original and Exclusive Designs.



**MOORE & SON,**

ESTABLISHED 1886. NEWARK, N. J. INCORPORATED 1903.

## SIGNET RINGS



TRADE (S) MARK

**Geo. O. Street  
& Sons**

Est. 1837

24 John St., New York.  
103 State St., Chicago.

**ROBERT DULY,**  
DESIGNER,

Etching in Gold and Silver.  
Telephone, 3960 Chelsea.

No. 70 5th Avenue, NEW YORK

# The Bowden Rings

ARE COMPLETE IN VARIETY, CORRECT IN  
QUALITY AND PERFECT IN FINISH. WE  
MAKE EVERY VARIETY OF FINGER RINGS.

**J. B. BOWDEN & CO.,**

1 Maiden Lane.

NEW YORK.



# WE DO NOT SELL DEPARTMENT STORES

We Study the Interests of the Retail Jeweler

---

At a meeting of the directors of the W. & S. Blackinton Company, held May 28, 1906, the following resolution was adopted:

“Resolved: That on and after July 1, 1906, we confine our sales strictly to the legitimate jewelry trade, through the jobber.”

**W. & S. BLACKINTON CO.**

We believe it is impossible for us to sell department stores without injury to the retail jeweler. In declining the trade of department stores we close many large accounts. However, we are convinced that the adoption of this policy of protection to the retail jeweler and jobber will work to their best interests, as well as to our own.

---

## **W. & S. Blackinton Co.**

Manufacturers of Old Reliable W. & S. B. ★ Chains and Locketts  
NEW YORK, 14 Maiden Lane      NORTH ATTLEBORO, MASS.

---

A selection package will be sent through any jobber whom the retailer may designate.

# The Reign of the Bracelet.



EXPERIENTIA  
DOCET

CONFORMING to the revival of Bracelets, this house offers an attractive line, including Bangle and Link Bracelets. Great variety, especially in Link Bracelets. Made in Gold and set with Precious and Semi-Precious Stones. Impressive.

PRICES: FROM \$12.00 to \$400.00.



EXPERIENTIA  
DOCET

Durand & Company,

49-51 Franklin Street,  
Newark, N. J.



## A COMPLETE LINE

of some of our handy pins. Made in all colors, sizes and finishes.

**A. J. HEDGES & CO.,**

Makers of Exclusive Designs in 14k. Jewelry,  
14 JOHN STREET, NEW YORK

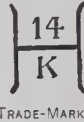

TRADE-MARK



TRADE 14 MARK

**OSMUN-PARKER MFG. CO.**

MAKERS OF

*Fine Pearl and Diamond Goods*

338 Mulberry Street  
NEWARK, N. J.



## SOLID GOLD CHAINS

OF EVERY DESCRIPTION

The selling expense of chains is an item which ordinarily affects the cost in a measure which is greatly to the disadvantage of the retail jeweler.

In the price of our chains, this selling expense does not appear. You get the benefit when you buy

## SOLID GOLD CHAINS



TRADE MARK

direct from us, as you do not have to pay the salaries and expenses of salesmen. We have no traveling salesmen and our prices are therefore very low.

For 56 years exacting jewelers have found our chains ready sellers, very profitable to handle and most durable in service.

We will be pleased to send you a selection package.

1850 1906

**ALOIS KOHN & CO.**

Makers of

**SOLID GOLD CHAINS**  
of every kind.

16-18 Maiden Lane  
New York

ESTABLISHED 1871.

Factory and Office: Newark, N. J.

INCORPORATED 1900.

## CARRINGTON & CO.,

*Patent Pocket Match Box*

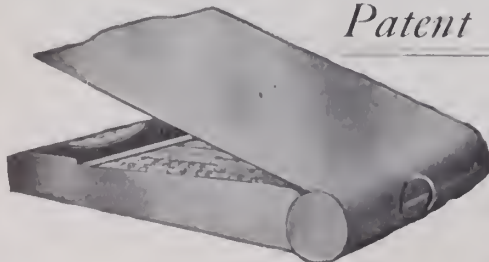

14K. ONLY IN STOCK.

Book Safety Matches with  
Steel Cigar Cutter.  
(Patented.)



Sales Agent:  
7 Maiden Lane,  
NEW YORK.



## M. SCHIFF

Established 1876

82-84 Nassau St., N. Y.

Phone 801 John.

Manufacturer of  
Diamond Mountings, Loops  
and Buttons. Patentee of

## THE NEW IMPROVED Ear Screw

The only one on the market  
of its kind, absolutely secure.  
Special attention paid to  
order work.

ALL KINDS OF BRACELETS



## Buckle-Pins for the WAIST

FEMININE ATTIRE in Summer creates a genuine demand for these goods. Lines like this make Summer business profitable to the jeweler.

Colonial Engraved, Vermicilli, Plain and Beaded Effects. Wide range of styles and sizes, all rich and artistic. Many set with Pearls, and such stones as Amethyst, Peridot, Jade, Etc.

STRICTLY WITHIN OUR LINE OF SPECIALTIES.

## Day, Clark & Company

14 KARAT ONLY

23

Maiden Lane  
New York



## WHITESIDE & BLANK SCARF PINS

NEW GRECIAN EFFECTS

Fancy Stones, Diamonds or Pearls.

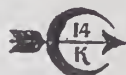

No. 4038½ Sapphire and Diamond. No. 4032 Sapphire.  
No. 4030¼ Aquamarine. No. 4040¼ Baroque and Diamond.

NEWARK, N. J.,  
Lafayette and Liberty Streets.

NEW YORK,  
14 and 16 John Street.

ESTABLISHED 1841.

## Carter, Howe & Co.

TRADE



MARK

MANUFACTURERS OF

## Gold Jewelry,

9, 11, 13 MAIDEN LANE, - NEW YORK

FACTORY, NEWARK, N. J.

A. CARTER.

G. R. HOWE.

W. T. CARTER.

W. T. GOUGH.

"THE BRACELET HOUSE."

## KENT & WOODLAND,

BRACELETS FOR EVERY WOMAN AND MISS.

16 John Street, New York.

San Francisco Office,  
Care JULIUS A. YOUNG.

"Nethersole Bangles,"  
Plain and with Stones.

"Pinhole" Secret Snap,  
with and without pre-  
cious and semi-precious  
stones.

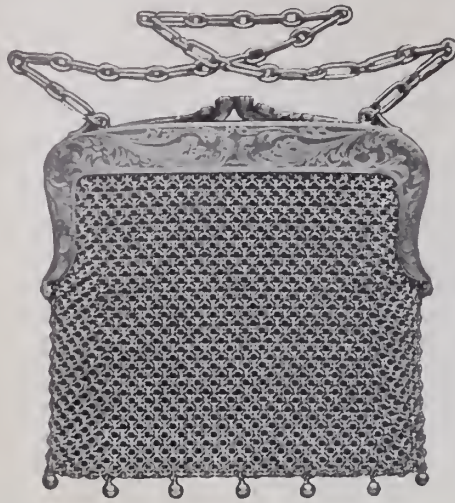

# S. Cottle Co.

are showing an entirely new and exclusive line of Gold and Silver BAGS and PURSES, also many lines of BRACELETS—all of superior workmanship and design.

31 East 17th Street,  
New York.

## Bridesmaids' and Ushers' Pins

We would suggest something with color. Brooches, Scarf Pins and Handy Pins with Amethysts, Topazes, Garnets, Peridots, Aquamarines, Jades and Baroque Pearls. We have a large variety of patterns at moderate prices.

REGARDING OUR FOBS WE HAVE NOTHING TO SAY—  
THEY SPEAK FOR THEMSELVES.

## SNOW & WESTCOTT,

Makers of Good Jewelry for Over Seventy Years,

21 MAIDEN LANE, NEW YORK.



The Rosary  
in Fine Jewels

Fine Rosaries in pure and imitation stone. Mounted in solid gold and rolled gold-plate.

A L I C O L O R

Our special illustrated catalogue will give interesting advice regarding prices and discounts.



MADE BY

## The W. J. Feeley Co.

Providence, Rhode Island,

Ecclesiastical Art Metal Worker

## SAM'L BUCKLEY & O.

English Fancy Goods.



Carry in New York a full line of

## ENGLISH PLATED WARE

118-122 Holborn, E. C.,  
London, England.

100 William St., New York

ADOLPH LUTHY.

PERCY W. HINE.

## LUTHY & HINE,

13 EAST 30TH STREET, - NEW YORK.

MANUFACTURERS OF

### Artistic Gold and Platinum Mounted Diamond Jewelry.

Odd and Exclusive Patterns in NECKLACES, BROOCHES, BRACELETS, RINGS, RIBBON COLLARETTES, Etc.

MOUNTED WITH AQUAMARINES, PERIDOTS, AMETHYSTS AND OTHER PRECIOUS STONES.

(DIAMOND MOUNTED COMBS A SPECIALTY.)

## DESIGNS For Silverware, Novelties and Jewelry . . . FINE ETCHING

All goods left with us for etching are covered by policies which fully insure our customers against loss by fire or theft.

CHARLES M. PRIOR (PHONE 1224 HARLEM) 1683 Madison Ave., New York



**Adjustable  
Glove  
Garters**  
IN  
GOLD AND SILVER.

**Gold Jewelry**

14K. in 10K.

Plain, Chased, Engraved, Diamond Set

BRACELETS, BROOCHES,  
LINKS, LOCKETS, ELK  
BUTTONS, ETC.

Chas. L. Trout & Co.,  
15 MAIDEN LANE, NEW YORK.

**Look for the Stamp**

ON BACK OF

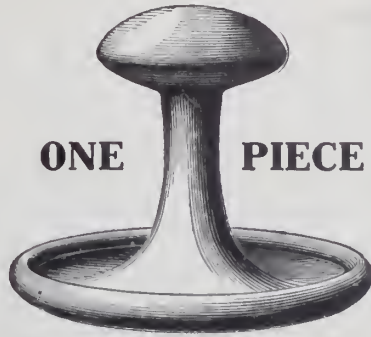

ONE PIECE

The Standard American Collar Button

**KREMENTZ**  
Collar Buttons and Studs



**Krementz Stamp**

PARKS BROS. & ROGERS  
20 Maiden Lane, New York  
Selling Agents to Jobbers

**KREMENTZ & CO.**  
Newark, N. J.

Send for booklet, "The Story of a Collar Button."—FREE



**Tortoisene  
Combs**

Mounted with 10-K. hand-work patterns. Every design is characteristic of originality and every detail is significant of superior workmanship.

*Tortoisene* is hard to detect from the real tortoise shell, having a rich effect that pleases the most skeptical in artistic hair treatment.

This cut represents a few of our patterns, actual size.

Combs will be much in demand throughout the year and orders should be in advance to insure prompt attention.

Prices on request.

**Schultz, Leiss & Co.**

OFFICES

New York, 14 John St. Chicago, 103 State St

FACTORY:

Cor. McWhorter and Oliver Sts., Newark, N. J.

# ALLSOPP & ALLSOPP'S

## HIGH CLASS

# BRACELETS

MOUNTED IN COMBINATIONS OF

Dia. and Pearl  
 Dia. " Sapphire  
 Dia. " Emer'lds  
 Dia. " Baroques

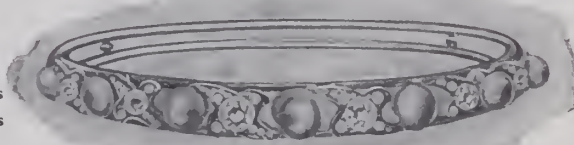

Amethysts  
 Topazes  
 Peridots  
 Aquamarines  
 Etc.

18-20 COLUMBIA ST.



NEWARK, N. J.

## Unique Silver Deposited

# WHISKEY JUG



7 Inches High.

Just one piece from one of the best selling and most attractive lines in town.

**Depasse Mfg. Co.,**

41-43 Maiden Lane, New York

Everything New Under the S

IN MODERN JEWELRY  
 OF EVERY DESCRIPTION

# Signet Ring

(OUR OWN MAKE)

A SPECIALTY.

We Solicit Memorandum Order

# L. Witsenhausen

47-49 Maiden Lane  
 New York.

Manufacturers of MODERN JEWELRY  
 Chicago, 405 Masonic Temple.  
 (L. KATLINSKY.)

THE CROWN PATENT SAFETY GUARD



For Scarf Pins Studs and L. Pina. The most practical and adjustable one invented. Price, \$1.50 per doz. For by all wholesale jewelers and material houses. Sent by mail, 25c; in 10k. gold, \$1.00; 14k., \$1.25. M. CROWL Maker and Inventor, 48 and 50 Maiden Lane, N.Y.



## FESTOON NECKLACES

The increasing demand for high grade Festoon Necklaces has compelled us to make up a larger and more varied line of them than ever before, set in combination with Diamonds, Baroque Pearls, Aquamarine, Topaz, Peridots, Amethysts, Turquoise, fancy Sapphires, etc., etc.

CUFF BUTTONS LOCKETS  
 BROOCH PINS SCARF PINS  
 BRACELETS

**COOPER & FORMAN** OFFICE AND FACTORY  
 3 MAIDEN LANE, NEW YORK  
 MAKERS OF DIAMOND JEWELRY

## ORNAMENTAL HAT PIN HOLDERS

A Useful and Artistic Conceit in  
 SILVER DEPOSIT ON GLASS

that contributes greatly to  
 the appearance of any dresser

MADE IN A VARIETY OF HIGHLY ARTISTIC DESIGNS

Splendid sellers during the vacation period



**LACKNER & OHL**

50 Columbia Street

NEWARK, N. J.

# HEINTZ BROTHERS.



We Make the Largest Line of Solid Gold Set Rings in America for the Retail Trade.

## "Perfect Yourself"

In ENGRAVING and EXPERT WATCH WORK  
 Take a Post-Graduate Course.

**RIES & ARMSTRONG, Macon, Ga.**



THIS is the season when the Sporting Crowd gets busy. The advent of the races always brings with it an increased demand for chronographs. The new "Improved Standard" supplies the want, with a cheap, yet good, movement; simple but accurate. Cased up in plain E. T. and Engraved; prices from \$5.15 up. Let us send you some;—you are sure to sell them within a short time.

**Henry Freund & Bro.**

"SELLERS OF SELLERS,"

7 Nassau St., New York.

Watches and F. O. Eagle Goods a Specialty.

# Many Leading Retailers

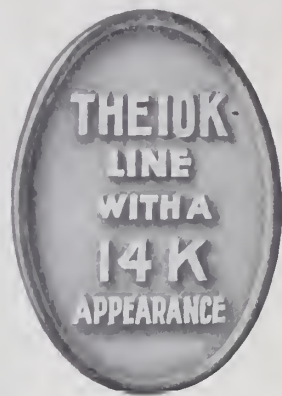

*who never before handled gold jewelry less than 14k. are among our most enthusiastic and liberal patrons.*

*Our designs, finish and workmanship have given a new dignity to the 10k. business.*



*Rohrer & Co.*

Camp and Orchard Streets  
Newark,  
New Jersey

**Roger Williams Silver Co.,**

PROVIDENCE, R. I., AND NEW YORK, 860 BROADWAY.

**Sterling Only.**

RICH DESIGNS :: :: :: Photos on Application.

# THE MOUNTING THAT SELLS

Earscrews,  
Earrings,  
Studs,  
Scarf Pins,  
and Rings  
of every description.



Made in  
Platinum,  
18K.,  
14K.,  
all sizes.

It gives light and brilliancy to the stone.

Manufacturer of a general line of Platinum,  
18K. and 14K. Mountings.  
Prompt attention given to special order work.  
Estimates and designs submitted.  
Diamonds recut and repaired.

## JULIUS WODISKA,

40 JOHN STREET,

NEW YORK.

# Koshland & Italic Co.

702 Chestnut Street,

PHILADELPHIA, PA.

¶ The BEST is none too good for you or your customers.

¶ We handle the best goods made in our line.

## Diamonds, Watches and Jewelry

- 
1. Snap complete.
  2. Outside of Snap.
  3. Inside of Snap.

## The E. P. H. Patent NON-PULL-OUT Neck Chain Snap

*is a patented snap that insures the wearer against loss of*

**CHAIN or CHARM**  
for it positively will not pull out

Made in 10 and 14 Karat Gold and  
in Gold Filled.

*Can be had of the following Wholesale  
Selling Agents:*

Messrs. W. Green & Co.,

81 Nassau St., New York.

M. Sickles & Sons, Philadelphia  
E. A. Cowan & Co., Boston  
E. & J. Swigart, Cincinnati  
Swartchild & Co., Chicago  
Nordman Brothers, San Francisco  
Leonard Krower, New Orleans  
Bauman-Massa Jewelry Co.,  
St. Louis

### PRICES.

14 Karat—Small, \$7 per doz. net  
Large, \$7.50 per doz. net  
10 Karat—Small, \$6 per doz. net  
Large, \$6.50 per doz. net  
Gold Filled—Small, \$2 per doz. net  
Large, \$2.25 per doz. net

**CASSIUS W. SEYMOUR,**  
37-39 Malden Lane, New York  
ALLOW ME TO CALL ON YOU IN THIS WAY



**Jewelers'  
Stationer and Print  
Jewelers' Cards  
Tissue Paper,  
Tags,  
Blank Books, et  
ROLL AND FLAT PAPER**

Estimates cheerfully given. Mail orders promptly attended to. Let us quote you prices on manifold books and sealing wax.

## CROUCH & FITZGERALD



**Jewelry  
Trunks  
and Cases**

177 Broadway,  
Bet. Cortlandt  
and Dey Sts.

688 Broadway,  
723 6th Ave.,  
New York.





A good many dealers  
 like their own names  
 on America Alarm  
 watches—it's a standing  
 "trad." that somebody  
 else pays for.

Ask your jobber or  
 write us about this.

The Western Clock Mfg. Co.  
 LA SALLE, ILL.

**The ST. JAMES**  
 Corner Walnut and Thirteenth Streets  
 PHILADELPHIA, PA.  
 The Ideal Hotel of Philadelphia  
 European Plan EUGENE G. MILLER, Mgr.

**Trade-Marks** of the Jewelry and  
 Kindred Trades.  
 Second Edition. Price, \$3.00. The Jewelers' Cir-  
 cular Publishing Co., 11 John St., New York.

# LOCKETS

WE ARE  
**LOCKET**  
**SPECIALISTS**  
 —  
 FOR THE  
 JOBBING  
 TRADE  
 EXCLUSIVELY



THE GOLF  
 GIRL

illustrates one  
 of a hundred  
 and more de-  
 signs. Made in  
 3 sizes.

Every Locket stamped  
 on inside with

**S. & B. L.**  
 ★  
**CO.**

Insist on this  
 Trade-Mark

MADE IN HIGHEST GRADE GOLD FILLED ONLY  
 Ask your jobber, or send for a selection

Manufactured only by

## S. & B. LEDERER CO.

NEW YORK SALESROOM  
 9-11 Maiden Lane

Providence, R. I.

CHICAGO  
 131 Wabash Avenue

## OUR EIGHT SALESMEN ARE ON THE ROAD.

It is more than likely that one of them will call upon you in the near future. Let us impress upon you here the fact that the sample line of American Watches, Diamonds and Jewelry that he carries has been selected with more than usual care.

From our  
 New York Office:  
 H. OLLENDORFF  
 T. OLLENDORFF  
 H. GOLDSTEIN

**"We cover the country."**

Special Southern Representative:  
 O. J. SOMERS

From our  
 Pittsburg Office:  
 W. S. BICKART  
 J. S. BICKART  
 W. E. PARISH  
 S. A. REUTTER

Should your wants necessitate an immediate  
 delivery before our representative's arrival,  
 either our New York or Pittsburg office will give your order by mail  
 PROMPT and CAREFUL attention.

## I. OLLENDORFF CO.

JOBBERS IN WATCHES, DIAMONDS AND JEWELRY

NEW YORK  
 54 Maiden Lane.

Established 1868.

PITTSBURG, PA.  
 Cor. Liberty Ave. & 6th St.

**Eliassof Bros. & Co.**

IMPORTERS  
 AND  
 JOBBERS OF

**DIAMONDS  
 WATCHES  
 JEWELRY**

9-11-13 MAIDEN LANE,  
 NEW YORK.  
 100 STATE STREET,  
 ALBANY, N.Y.



A LARGE ASSORTMENT OF DIAMOND  
 MOUNTED JEWELRY CARRIED IN STOCK.

# The Kenilworth Bracelet.

(Patented Jan. 2, 1906, No. 808,805.)  
No. 4086.

All of the foremost jobbing houses now carry a full line in stock, and you will miss an opportunity if you fail to see them. Ask your jobber to show you the full line.

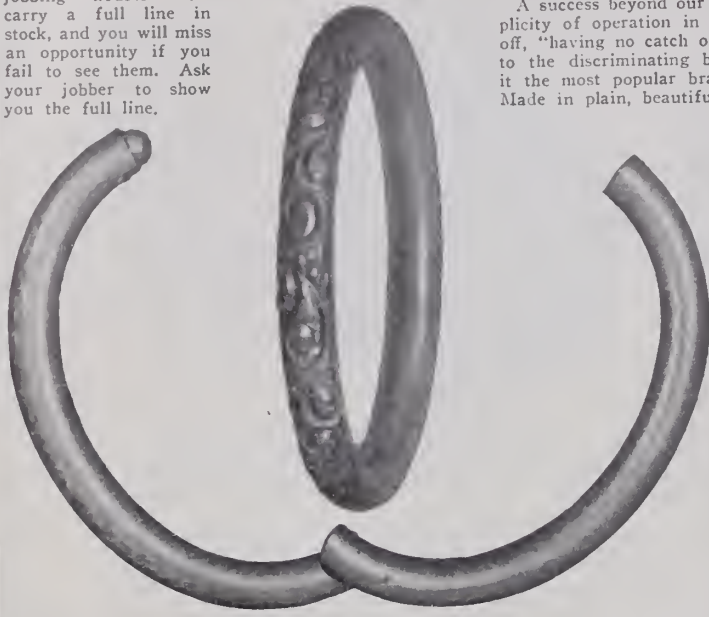

A success beyond our expectations. Its simplicity of operation in putting on or taking off, "having no catch or snap," commends it to the discriminating buyer, and has made it the most popular bracelet on the market. Made in plain, beautifully chased and stone set, plain polished, English and Roman finishes, and in gold-filled and sterling silver.

Manufactured by  
**Doran,  
Bagnall  
& Co.,**

North Attleboro,  
Mass.  
194 BROADWAY,  
NEW YORK.  
67 WABASH AVE.  
CHICAGO.  
126 KEARNY ST.,  
SAN FRANCISCO.

## Boston Jewelry Manufacturing Co.

### The Mounting and Repairing House of New England.

We eclipse all others in design, quality, promptness and finish of work.

A line of entirely new styles in mountings always on hand.

**Jewelers' Building,  
BOSTON, MASS.**

EVERYTHING IN LOCKETS AND CHAINS.

THE BASSETT JEWELRY CO.,  
PROVIDENCE, R. I.



# FANS

FAN SEASON is here, and we are prepared for it with the choicest that has ever been imported from Paris. These dainty creations are appropriate for Graduation, Confirmation, Weddings, and in fact for any occasion where taste and exclusiveness are requisite.

SEND FOR A SELECTION, MENTIONING PRICE.

**LEWY & COHEN** 530 BROADWAY, NEW YORK

Importers of Fans, Brooches, Mounted Side Back Combs, French Head Necklaces in mother pearl effects, and THE "MEDICI CHAIN," a French creation in fan chains.

## There's a Reason

for the success of our

### 20th Century Gold Shells

THE BEST MONEY CAN BUY  
unless a solid gold charm

*Insist on having them in your stock  
Made in both gold, and onyx set, fronts*

## IRONS & RUSSELL

MAKERS OF EMBLEMS

MAIN OFFICE and FACTORY: 95 CHESTNUT ST., PROVIDENCE, R. I.  
NEW YORK OFFICE: 11 MAIDEN LANE



# RINGS

**WM. LOEB & CO**

101 Sabin St.,

**Providence, R. I.**

New York Office, 37 Maiden Lane

**W**ait  
**A**nd See  
**I**n the "Celebrated Case"  
**T**his Season's New Goods.  
**E**very one a Seller

**T**here  
**H**ave always been  
**R**easons:—

**T**HESHER'S  
**G**OODS  
**S**ELL

**Vaite-Thresher  
 Company**

PECK ST., PROVIDENCE, R. I.

Maiden Lane, 1203 Heyworth Bldg.  
 NEW YORK. CHICAGO, ILL.

**FALL LOCKETS**



Trade-mark  
 stamped  
 in each  
 Locket



**W** Our **FALL LINE OF LOCKET CREATIONS** will convince the discriminating buyer of the value of W. & H. Locketts. Fifty years of successful experience justify the confidence in our line.

3 Maiden Lane **Wightman & Hough Co.** Providence, R. I.  
 New York

**EGYPTIAN  
 PEARLS**

—  
**FINEST  
 OF  
 ARTIFICIAL  
 PEARLS.**

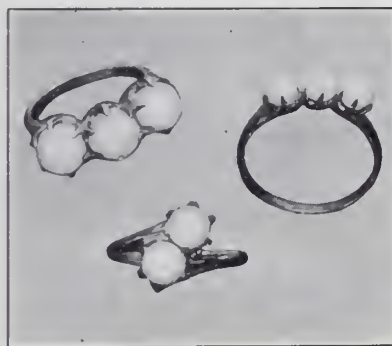

**EGYPTIAN  
 PEARLS**

—  
**MOUNTED  
 IN  
 POPULAR  
 JEWELRY.**

**T**HE PEARL has always symbolized Beauty and Value. Nature's product is most closely approximated in the handsome "EGYPTIAN" Pearls. The iridescence, weight and color of natural Pearls are retained; and inspection of the "EGYPTIAN" Pearls will demonstrate their pre-eminence. The results attained are possible only by a special process, supplemented by expert workmanship. The articles of Jewelry to which "EGYPTIAN" Pearls are applied are artistic creations meriting your attention.

**GEORGE H. CAHOONE COMPANY,**

Makers of Artistic Jewelry,

PROVIDENCE—7 Beverly Street.

NEW YORK—9 Maiden Lane.

1876

1906

# Hutchison & Huestis RING MAKERS

FACTORY, - - - PROVIDENCE, R. I.

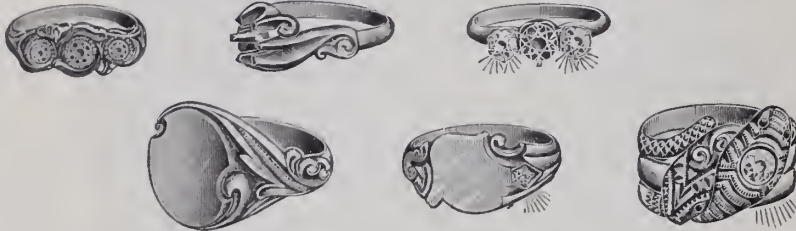

*Jade is in vogue  
See our Jade Rings*

JOBGING TRADE ONLY

NEW YORK,  
3 Maiden Lane.

CHICAGO,  
Columbus Bldg.  
Harry H. Miller.



THE TRADE

desirous of keeping in touch with modern, pro-  
ducing methods, should always consult the  
pages of

OUR BIG CATALOGUE,

with its 30,000 illustrations and long list price  
We send this splendid book free on request.

## S. F. Myers & Co.

Headquarters for Dueber-Hampden Watches.  
WHOLESALE JEWELERS.  
The New S. F. Myers Bldg. 47G-49 Maiden Lane New York.



Ladies' Fancy Stone Ring  
and Stone Scarf Pins  
in 10K. that defy  
competition.

Our reputation for making the  
finest and most complete line of  
10-K. gold band rings is still  
maintained—ask your jobber.

THE  
**EDWIN LOWE & CO., Inc.**  
F. W. BODWELL, V.-Pres. and Gen. Mgr.,  
116 Chestnut St., PROVIDENCE, R.  
New York Representative, E. T. Wilson, 180 Bwa  
Western Representative, S. H. Brower.



# BROOCHES

WE have over four hundred styles of Gold Brooches  
set with all the popular stones in vogue; not at fancy  
prices, but at figures that cause them to sell.

We have Gold Barrettes in a variety of shapes and styles.

*Insist upon seeing the designs  
of Gold Jewelry made by the*

## E. L. SPENCER COMPANY,

Makers of Gold Jewelry for the Jobbing Trade.

ORDERS PROVE OUR GOODS SELL.

95 Chestnut Street, PROVIDENCE, R. I.  
New York Office, 9-11-13 Maiden Lane.  
SAMPLES ONLY.

## ORKIN BROS.

373 WASHINGTON ST.,  
Jewelers' Bldg., BOSTON, MASS.  
Manufacturers of diamond mount-  
ings, and repairers to the trade. Im-  
porters of precious, semi-precious  
and imitation stones.

*A Full Line Always in Stock at  
Lowest Prices.*

We aim to be the foremost  
jobbing house of Boston.

Send us your repairs, or write us for  
information.

35 Years Manufacturing

# CHAINS

## S. & B. Lederer Co.

11 Maiden Lane New York      Factory: Providence, R. I.      131 Wabash Ave Chicago

**GLOSSING HAS CEASED TO BE A VIRTUE.**

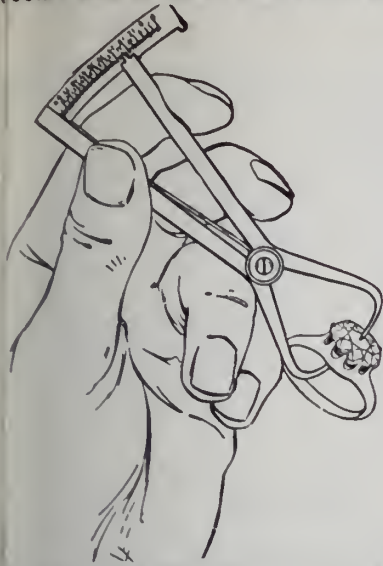

**THE MOE DIAMOND WEIGHT GAUGE**  
The only correct system for determining the weight of mounted diamonds.  
**ENDORSED BY THE LEADING JEWELERS.**  
Those who are not familiar with the device, will send for descriptive booklet.

**Charles Moe, Inventor, 80 Adams St., CHICAGO, U. S. A.**

Price for Instrument and Book, \$3.75 prepaid.

Also order from the following agents:  
D. C. PERCIVAL & CO., Boston; CROSS & BUELIN and R. L. & M. FRIEDLANDER, New York; M. SICKLES & SONS, Philadelphia; W. H. DUNN BROS., San Francisco; E. & J. S. GART, Cincinnati; LEONARD KROWER, New Orleans.  
W. H. BATES & STRAUSS, Sole Agents for Europe and India, London, E. C., 14-17 Holborn Viaduct.

**REMOVAL NOTICE!**

**THE LYONS GEM CO.,**

Have Removed to

**35 Maiden Lane, New York.**

A FULL AND COMPLETE LINE OF PRECIOUS, SEMI-PRECIOUS AND IMITATION STONES ALWAYS IN STOCK.

**Our Specialty is Scientific Rubies.**

Local and out of town jobs promptly attended to at reasonable prices. Send us your mountings to be set with matched stones. A trial order will convince you that our prices are right, and our goods select.

**Unique Gems**

and Semi-Precious Stones

Many fine gems occur as water-worn pebbles. These, when polished natural or drilled and polished as beads, form a decided novelty of great beauty and infinite variety of colors, and can be had in

- |             |                |             |
|-------------|----------------|-------------|
| Carnelian   | Agate          | Rose Quartz |
| Chrysoprase | Topaz          | Malachite   |
| Jasper      | Lapis Lazuli   | Amethyst    |
| Tourmaline  | Emerald Matrix |             |
- and many other stones.

Adapted especially for neck chains, drop pendants, La Vallieres, scarfpins, link cuff buttons, and for any of the newer forms of jewelry. Prices reasonable; no imitations.

Sample papers sent to responsible jewelers.

**LOUIS J. DEACON, Atlantic City**  
During Summer Months, Cape May, N. J.

**NORMA**  
TRADE MARK

**The New NORMA**

**Patented Adjustable Bracelets**



No. 253.



No. 265.



No. 254.



No. 271.



Examine our Popular Prices ranging from

**\$16.50 to \$36.00**  
per dozen

The illustrations represent a few of the many styles we make

**THE QUALITY OF ALL THESE GOODS IS FULLY GUARANTEED**

Send for our new illustrated booklet of patterns and prices

MADE ONLY BY

**The F. H. Sadler Co.**

80 County Street

**ATTLEBORO, MASS.**

Address all communications to Attleboro, Mass.

N. Y. Office, 180 Broadway Room 43

**NORMA**  
TRADE MARK

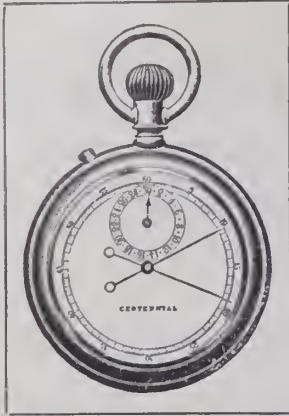
Timer is  $\frac{1}{8}$  Larger than cut

THE OLD RELIABLE  
**Centennial**

SPLIT SECOND TIMER

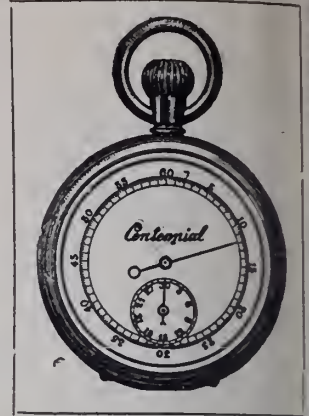
*"None better made"*Suitable for Racing and  
Mechanical Purposes.Timer is  $\frac{1}{8}$  larger than cut

**CROSS & BEGUELIN, Manufacturers, New York.**

ESTABLISHED 1861.

## R. BLACKINTON & CO.,

3 MAIDEN LANE, NEW YORK.

FACTORY, NORTH ATTLEBORO, MASS.

Manufacturing Jewelers and Silversmiths.

TRADE  MARK.

Toilet and Manicure Articles, Flatware, Sterling and German Silver Wrist Bags, Gent's and Ladies' Card Cases, Vanity Boxes, Jewel Boxes, Match Safes, Picture Frames, Belt Buckles, Cigarette Cases, Penknives and up-to-date Novelties.

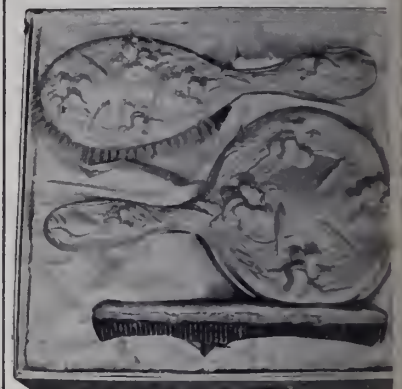

### To Jobbers Only—

When you think of Toilet Goods please remember us. Our goods are high grade and can be retail at popular prices.

Special Terms on Early Business

Art Stamping &amp; Mfg. Co.

411 Commerce Street, PHILADELPHIA, PA.

## The Comb House

We manufacture a complete line of

FINE MOUNTED COMBS

in 14 K., 10 K., Sterling Gilt and Gold Filled.

Also all kinds of PLAIN, REAL and IMITATION TORTOISE SHELL COMBS.

Wagner Manufacturing Co.

41 Union Square,

New York. Factory, Lorimer St. and Throop Ave., B'klyn, N. Y.

Repair Work  
a Specialty.

## THE WASHBURN

SECURITY MAGIC NUT

Automatic Holder for ear studs, scarf pins, etc.  
for all sizes of scarf-pin wire. Guaranteed.

EAR WIRES

for unpierced ears.



SAFETY CATCH

For brooches, etc.  
Can be applied to work where fasteners are used.

Open.



Closed.



Open.



Close

Descriptive Circular on Application.  
Pearl Drilling and Adjusting a specialty.  
Special Order Work and Repairing.

C. IRVING WASHBURN, 12-16 John St., N. Y.

**Mr. Retailer:**

The Jobbers are taxing us to our utmost capacity with orders for the best line of Gold Watch Cases we ever created.

You will be pleased with their selections, we assure you.

**“WATCH OUT”**

**SOLIDARITY**

**Watch Case Co.**

Established 1885.

3 Maiden Lane, New York.

GENERAL SELLING AGENTS

JOHN W. SHERWOOD  
FRANK E. HARMER

# WORLD BRAND SILVER



**Base Metal**

Manufactured in our own factory by workmen selected because of their knowledge and practical experience in its manufacture and use and with a view to obtaining the best possible results.

**Silver**

Not Less Than 50 per cent. heavier plate than the regular “Standard.” Made in two grades, six and fourteen ounce plate.

**Designs**

Six fancy patterns—*original* in design and unexcelled in execution. Also four plain patterns.

**Prices**

As low as consistent with quality.

*Write for catalogue and prices.*

**THE AMERICAN SILVER COMPANY**  
BRISTOL, CONN.

46 West Broadway, New York.

Silversmiths' Building, Chicago, Ill.

## Ross, Saltman & Anderson

MANUFACTURERS OF

**Rings and Diamond Mountings**

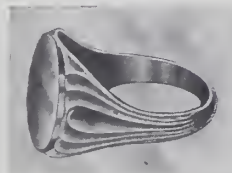

699



204

89 FULTON STREET,  
NEW YORK

Jewelers will find it desirable and profitable to keep in touch with our new and artistic monthly productions. They represent that originality and perfection upon which we propose to establish a substantial reputation.



REGISTERED

# The "ARMLET"



F. & B.  
"ARMLET"  
Secret Joint  
Pat. ~~1872~~  
Size 2 3/8 in.

- |           |                           |                                      |
|-----------|---------------------------|--------------------------------------|
| 474       | 476                       | 477                                  |
| 474 POL.  | 476 Rose Gold Half Chased | 477 Rose Gold, Half Chased, 5 Stones |
| 475 ROM.  | 507 O. E. " "             | 522 O. E. " " 5                      |
| 506 O. E. | 530 Rose Gold Full " "    | 546 Rose Gold " " 6 Brillants        |
|           | 538 O. E. " "             |                                      |

Color of stones as ordered, Amethyst, Ruby, Sapphire, Olivene, Topaz, Aquamarine, Almondine, Turquoise and Rose Stones.  
Bracelets made with secret joint and push catch. High-grade Seamless Gold-filled Stock. Each bracelet in fine leatherette covered box.



### BRACELET 473 ROSE.

COLOR OF STONES AS ORDERED.

Amethyst, Ruby, Sapphire, Olivene, Topaz, Aquamarine and Turquoise.

Two of the above Bracelets snapped together, makes a nice dog collar 14 in. long.



Locket  
2825  
Rose



Pin  
3632  
Rose and Green  
Brilliants



Pin  
3647 Pearls  
3648 Brilliants  
3649 Turquoise



Pin  
3629  
Baroque Pearls  
and Brilliants

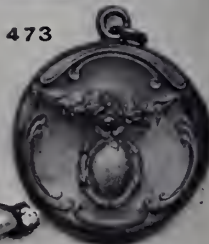

Locket  
2826  
Rose



Hair Barrette  
3660 Pearls  
3659 Brills.



Cuff Pin  
3624  
Roman



Cuff Pin  
3622  
Roman



Hair Barrette  
3652 Pearls  
3651 Brills.

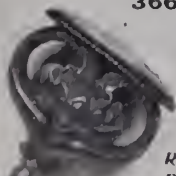

Hat Pin  
710  
Rose and Green  
Polish Signet

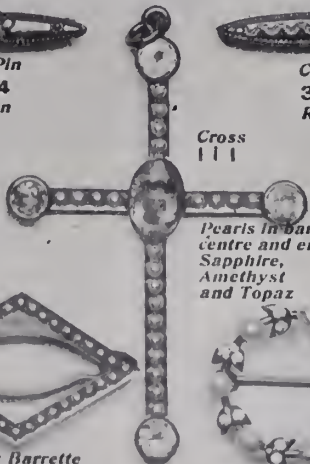

Cross  
111

Pearls in bars,  
centre and ends.  
Sapphire,  
Amethyst  
and Topaz



Hat Pin  
705  
Rose  
Polish Signet



Links  
751 Rose

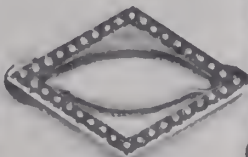

Hair Barrette  
3658 Pearls  
3657 Brilliants



Pin  
3603 Baroque Pearls  
and Brilliants



Links  
758 Green  
757 Rose

These are only a few examples of our new goods; see our complete lines.

**Theodore W. Foster & Bro. Co.**  
MANUFACTURING JEWELERS AND SILVERSMITHS,  
100 Richmond Street, Providence, R. I.

Established 1873

See our Line  
of Goods for  
Article: suitable for  
able for

A full  
PHOTO. F  
both Sterl  
and 14 K. G  
CROSSES,  
ANTS,  
CHAINS  
GNETTE  
LOCKETS,  
VEST, D  
and FOB  
BRACELE  
BROOCHE  
RINGS, LI  
TONS, SCA  
HAT PIN  
RETTE  
WAIST SE  
CHAIN P  
INGS, DO  
LARS and B  
BUCKLES,  
BOOK-MAI  
large variet

Sterling

Silver

Novelty

MANICU  
TOILET S  
pieces, also  
DESK F  
SEWING  
TRAVELIN  
SHAVIN  
SMOKIN  
FLASKS a  
goods su  
gentlemen's

Do not  
order a  
our new  
lets,

"The Armlet"



**List of the Jewelry Stolen from Atlantic City, N. J., Store.**

ATLANTIC CITY, N. J., June 13.—A full list of the jewelry, which, as told in the last issue of THE CIRCULAR-WEEKLY, was recently stolen from the store of Mrs. J. A. Z. 731 Boardwalk, June 3, has been prepared and sent out by the police. The articles, which are worth about \$3,000, include the following:

- Italian opal ball necklace, with crystal pearls.
- Turquoise ball necklace, with gold filigree balls between.
- Turquoise matrix necklace, with gold tassel on end.
- English gold filigree bracelet, gold in different parts; incomplete.
- Amethyst heart necklace, with baroque pearl and 14-K. gold, 14-K. different stones collar, tal effect.
- Scarab necklace, scarabei varied in color and size.
- Match safe, penknife, cigar cutter set with rubies.
- 1 pearl necklace, worked with horsehair on brooch to match.
- Twenty-four loose fresh water pearls, particularly quality, assorted in colors.
- 1 ring, 8 grs.
- 1 button, 20½ grs.
- 1 ring shape, 3½ grs.
- 1 eubud, 40½ grs., smaller pearls weighing from 15 grs. each.
- 1 ivory scarab, gemme. Kartoush proves it to be B. C.
- 18 old gold coins, early Christian and Kufic.
- 1 small seed pearl brooches.
- 1 short ropes of seed pearls, one three strands, and tight; one four strands, loose.
- 1 ring enameled collar, ivy leaves and pearls.
- 1 ring, silver white enameled.
- 1 ring cushion shaped matrix stones, set in a ring with baroque pearls as fringe, 14-K. gold.
- 1 ring full festoon necklace, square turquoise stones, gold.
- 1 ring large Barberic turquoise necklace, set in silver, silver filigree squares set between and irregular shaped turquoise tassels; drilled in the middle.
- 1 ring English 14-K. gold chain, with white baroque, finished with an antique tassel, set with pearls.
- 1 ring thirteen-K. gold tassel, with coral at the end and old fashioned enamel top.
- 1 ring set bracelet with three diamonds at the snap.
- 1 ring are stones turquoise bracelet, with two rows of turquoise pearls, 14-K. gold.
- 1 ring turquoise bracelet with lentils and baroque pearls, 14-K. gold.
- 1 ring lapis lazuli collar, silver gilt, large stones.
- 1 ring lapis lazuli ball necklace, Swiss lapis, very large.
- 1 ring lapis lazuli small shirt waist piece, oxidized.
- 1 ring silver filigree collarette, with large turquoise stones, set in center of square gallery set around stones.
- 1 ring ribbon shape dark turquoise necklace, silver arranged in points.
- 1 ring opaz bracelet, stones set between silver gilt, rubies.
- 1 ring all diamond dinner ring, with yellow pearls.
- 1 ring gentleman's antique emerald ring, cabochon, set on engraved on shank.
- 1 ring antique ring, snapped together as fob, light emerald on top.
- 1 ring three medium quality Alexandrites, weighing 2-K. and 4-K. each.
- 1 ring pear-shaped Siberian amethyst.
- 1 ring large silver amethyst collar, huge stones.
- 1 ring 18 karats clear turquoise lace pin, 14-K. gold.
- 1 ring antique plated chain, 14-K.
- 1 ring antique old English black slide, 14-K. gold.
- 1 ring exceptionally good (Rococo) enameled necklace.
- 1 ring diamond enameled necklace, St. George and dragon on pendant.
- 1 ring antique seed pearl drop earrings, worked on pearlless screws attached.
- 1 ring twelve half-inch long Spains paste earrings.
- 1 ring silver reconstructed rubies.
- 1 ring antique silver gilt purse, with baroque pearl tassels.
- 1 ring tree-stone turquoise pendant, large stones set in silver, small pendant turquoise drop set in 14-K. gold.
- 1 ring an assorted scarab pins in 14-K. gold.

Four lapis lazuli turquoise and amethyst rings, 14-K. gold, sizes 3 and 3½.  
 Long oxidized silver chain with baroque pearls and various colored scarabs.  
 Rose quartz necklace, very large stones set in silver.  
 Rose quartz pendant.  
 Rose quartz ball necklace.  
 Sixty ounces of filigree silver, mainly in daisy necklaces and oval-shaped ornament bracelets (innumerable brooches, dipped in various color gold).  
 Angel pink coral cameo, very large.  
 Antique silver chain with old locke hand chased.  
 Antique silver gilt bracelets, set with baroque pearls and small amethyst.  
 Two Chinese filigree silver bangles, set in baroque pearls and large turquoise, gilt.  
 The character of the jewelry is Oriental, antique and all are very fine reproductions. A reward of \$500 will be given for a clue that would lead to the recovery of the goods.

**Dealers Asked to Watch Out for Jewelry Stolen from Traveling Salesman.**

A circular was sent out last week by Pinkerton's National Detective Agency, notifying the trade of the loss of a quantity of jewelry taken on the evening of May 23 from the sleeping room in the Savoy Hotel, Kansas City, Mo., during the absence of the occupant, J. L. Holland, a traveling salesman for L. H. Schaffer & Co., Chicago. The jewelry was in a trunk which Mr. Holland had in his room.

Following is a list of the missing articles:  
 Complete, 16 size, Champion, open face, engraved 20-year case, No. 2061616, movement No. 6392749; complete, 16 size, Wm. McKinley, hunting, 20-year case, No. 1984856, movement No. 6296973; complete, 16 size, Wm. McKinley, open face, 20-year case, No. 1989782, movement No. 6297024; complete, 16 size, 109 Hampton, engraved 20-year case, No. 1951868, movement No. 6389891; complete, 16 size, General Stark, engraved 20-year case, No. 1796658, movement No. 6392788; complete, 12 size, Dueber Grand, open face, 20-year case, No. 1732741; movement No. 6450561; complete, 16 size, 109, open face, 20-year case, No. 1093789, movement No. 6392571; complete, 12 size, Dueber Grand, hunting, 20-year case, No. 1730784, movement No. 6388806; complete, 6 size, 213, hunting, 20-year case, No. 196047, movement No. 6365424; two, complete, 12 size, 213, hunting, 20-year case, No. 1960141, movement No. 6452367; complete, 12 size, General Stark, 20-year hunting case, No. 1982048, movement No. 6296978; complete, 12 size, General Stark, 20-year hunting case, No. 1855177, movement No. 6450575; complete, 12 size, 300, 20-year case, No. 2101684; movement No. 6388811; complete, 12 size, Champion, 20-year hunting case, No. 1964734, movement No. 6452366; complete, 6 size, Champion, 20-year hunting case, No. 1964740, movement No. 6297610; eight or 10 Molly Stark watches, in addition to above, of which we have no numbers at present; 11 flower signet rings (ladies); one Norma bracelet; three Dickens watch chains; three enamel Swiss chate-laine watches.

**Magnificent Pearl Necklace Sold at London for £10,000.**

A dispatch to New York Wednesday stated that 120 lots of jewelry were sold at auction that day in London at the auction rooms of Christie, Manson & Woods, 8 King St., St. James Sq., realizing in all \$50,629.

The principal piece of the sale was a magnificent pearl necklace, formerly the property of a lady of title, composed of five rows of beautiful pearls, 285 in all, and the pearls being unusually fine, Oriental, well matched and graduated. The necklace contained a sapphire and brilliant clasp.

The bidding on this piece began at £5,000 and advanced rapidly to £10,000, at which price it was knocked down. The name of the buyer is not mentioned in the dispatch.

**Court Hears Charges of Many Complainants Before Sentencing Morris and Joseph Klein.**

Part III. of the Court of General Sessions in Manhattan Thursday looked as if a convention of the wholesale jewelers of Maiden Lane was being held when the time came for the sentence of Morris and Joseph Klein, who, as told in the last issue of THE CIRCULAR-WEEKLY, had previously pleaded guilty to a charge of grand larceny in the second degree.

The brothers were former members of the firm of Klein Bros. & Co., manufacturing jewelers, 51 Maiden Lane, and against them seven indictments have been found by the Grand Jury, two of which charge them with failing to return goods on memorandum, and five charge that they obtained merchandise on credit on the strength of false representations as to their financial standing.

The specific indictment in which the plea of guilty had been entered was that of failing to account for unset diamonds valued at \$560 obtained from H. A. Groen & Bro. This and a similar indictment on a charge of obtaining diamonds from Eduard Van Dam were obtained by George M. Simpson and Abraham Levy, as counsel for the creditors, while the other indictments were obtained by the Jewelers Board of Trade through their counsel, Hastings & Gleason.

On the chance that Judge Rosalsky might not be aware of the more serious charges against the prisoners, and give them a mild or inadequate sentence on their plea of grand larceny in the second degree, Mr. Gleason appeared before the court, Wednesday, accompanied by a large representation from diamond and jewelry firms, who claim they have been swindled by the Kleins. In addition, a number of other jewelers interested in the failure were present—altogether about 40 members of the trade appearing in the court room.

When the case came up the Kleins were represented by Attorney Louis Vorhaus, of House, Grossman & Vorhaus; the complainants, Van Dam and Groen, by George Simpson and Abraham Levy, and the other complainants by Albert Gleason, who was accompanied by C. N. Gray, of the Jewelers' Board of Trade.

Mr. Gleason explained the situation to Judge Rosalsky, and acquiesced in the suggestion of the defendants' attorney that sentence be postponed until Friday next. Judge Rosalsky agreed to hear statements from the other complainants, and in turn the various members of the trade were called up to the Judge and a stenographic report made of their statements. Among those who appeared were Charles F. Wood, of Charles F. Wood & Co.; Harry Oppenheimer, of H. Z. & H. Oppenheimer; David C. Townsend, of D. C. Townsend & Co.; A. Roseman; M. H. Shiman, of Shiman Bros. & Co.; Mr. Mayer, of Dreyfus & Mayer; Mr. Groen and George Jordan, of H. A. Groen & Bro.; Abraham Sluizer, of Eduard Van Dam, and Charles Jung, of Jung, Staiger & Klitz.

It was reported that a petition asking clemency for the Kleins was being circulated by their friends, and that another petition to counteract the effect of the former would be circulated in the jewelry trade.

# ACTIVITY

## The Keynote of Our Progress

A series of pictures showing various forms of active life.



THE INDOMITABLE TUG.

The puffing tug-boat typifies Strength, Energy and Perseverance, qualities which have helped build up our business to its present large proportions.

Our Strength is expressed in our lines of Rings, Locketts, Sleeve Buttons, Larter Shirt Studs and Larter Vest Buttons.

Our Energy is devoted to increasing these lines and widening our market.

Our Perseverance in applying high grade art work to gold jewelry of unquestioned quality and workmanship is being rewarded by a constantly increasing business.

An inspection of our goods will demonstrate these facts.

May we prove our statement?

4  
over  
40  
years  
Ring Makers

Larter & Sons  
21-23  
Maiden Lane  
New York



Trophy Presented by Sir Thomas Lipton  
for Brooklyn Yacht Club's Ocean Race

As an example of English taste and skill in silversmithing, the trophy illustrated on the front cover of this issue, which was offered by Sir Thomas Lipton, through Thomas Fleming Day, the editor of the *Rudder*, of New York, as a prize for the racing yachts contesting in an ocean race, will be studied with interest by the designers and silversmiths on this side of the Atlantic. The race started from Gravesend Bay, May 26 and the course ended at Bermuda. Victory was won by Frank Maier's boat *Tamerlane*.

The silver trophy cost the donor \$1,000. The design is allegorical, the principal feature being a representation of an antique galley, having a winged female figure at the stern, indicating speed, one hand resting upon the tiller, and the other holding a Mercurial staff. At the prow there is a figure of a Triton blowing a trumpet in the form of a shell, to herald the race.

The galley is decorated with conventional waves, and has on either side an ornamental shield, one bearing the burgee of the Brooklyn Yacht Club and the other the burgee of the Bermuda Yacht Club, enamelled in colors. It is supported by the wings of a sea horse, resting upon an ornamental base, having four scrolls with two medallions introduced, one bearing the American flag and the Union Jack entwined, and the other the following inscription:

"Presented by Sir Thomas J. Lipton as a trophy for an ocean race from New York to Bermuda for cruising boats under the flag of the Brooklyn and Royal Bermuda Yacht Clubs, May 26, 1906."

The cup was designed and manufactured by the Goldsmiths & Silversmiths Co., Ltd. of London.

James C. Buchanan Files Answers to  
Suit Brought by the McKay Co.  
Washington, D. C.

WASHINGTON, D. C., June 13.—James C. Buchanan recently made answer to an equity suit filed against him by the McKay Co., on May 7, referred to in *THE JEWELERS' CIRCULAR—WEEKLY*, May 16. He claims that he had no inducement to the McKay Co. that was going to sell out as alleged at any particular time other than his explanation of the bill of sale referred to. He further claims that he did not in any manner influence Louis Costaggini in his actions as an officer of the McKay Co., but that the bill filed by said Costaggini was upon his own motion.

The answer also sets forth that Buchanan did not do any malicious or wrongful act and that the claims that he did so are without foundation. Anything he did on premises 1115 F St. were acts of his as landlord.

Instead of interfering with the McKay Co., the answer sets up a counter claim that the McKay Co. interfered with Buchanan moving certain of his goods.

The store of Ivan J. Gray, Park Prairie, Minn., was practically destroyed by fire recently. The loss on the stock is estimated at between \$1,000 and \$1,500.

**Shipments of Clocks, Watches, Jewelry, etc., to Alaska, Hawaii, Porto Rico and the Philippines.**

WASHINGTON, D. C., June 14.—Details of the commerce of the United States with the non-contiguous territories in clocks, watches, jewelry, etc., during certain periods have just become available, and are now presented:

**ALASKA.**—Shipments of clocks to Alaska during the 10 months ending April, 1906, were valued at \$4,472, as against a value of \$11 for the same period last year. The shipments of watches during these periods were valued at \$1,377 and \$591, respectively. Jewelry shipments to Alaska show a large increase. During April last the value was \$13, as compared with a value of \$545 for the same month last year. During the 10 months' periods the shipments of jewelry increased in value from \$25,599 in 1905 to \$1,994 this year. Plated ware shipments increased from \$4,630 during the 10 months of 1905 to \$6,685 during the same period this year.

**HAWAII.**—Clocks to the value of \$7,431 were shipped to Hawaii during the 10 months of 1905, increasing to \$10,177 this year, while watch shipments increased from \$85 to \$2,196 during the same periods. There was a tremendous falling off in the shipments of jewelry, both during the 10 months' period and during the 10 months' period; the value of these shipments in April a year ago was \$190, declining to \$500 in April last, while during the 10 months ending April, 1905, shipments were valued at \$144,384, decreasing to \$82,071 during the corresponding period of this year. Plated ware shipments likewise declined in value from \$51 in April a year ago to \$50 in April last, and from \$51,309 during the 10 months of 1905 to \$24,489 this year.

**PORTO RICO.**—During April, 1905, clocks to the value of \$312 were shipped to Porto Rico, increasing to \$457 in April last. During the 10 months' periods the shipments increased in value from \$2,282 in 1905 to \$13 this year. Watch shipments likewise increased from \$88 to \$671 during the 10 months' period and from 2,159 to \$3,300 during the 10 months' period. During these same periods jewelry shipments increased from \$561 to \$603 and from \$7,696 to \$13,310 and plated ware shipments from \$535 to \$592 and from \$5,373 to \$7,755.

**PHILIPPINE ISLANDS.**—Shipments of clocks to the Philippines declined in value from \$926 in April, 1905, to \$435 in April last, but increased from \$2,403 to \$3,405 during the 10 months' periods. There were no shipments of watches either in April, a year ago or in April last, while during the 10 months' period the shipments fell from \$34 in 1905 to \$924 this year. Likewise there were no shipments of jewelry in April a year ago or in April this year, but during the 10 months' shipments increased from \$57 in 1905 to \$2,146 this year. Plated ware shipments increased from \$1,624 last year to \$14,328 this year.

**New Tariff of British India.**

WASHINGTON, D. C., June 13.—The new British India tariff contains the following schedules:

German silver, 5 per cent. ad valorem.  
Gold bullion and coin, free.

Silver bullion or coin, 5 per cent. ad valorem.  
Works of art, except for the public benefit, 5 per cent. ad valorem; when for the benefit of the public, free.  
Clocks, watches and other timekeepers, 5 per cent. ad valorem.  
Optical instruments, 5 per cent. ad valorem.  
Silverware, plain, other than European, 5 per cent. ad valorem on a valuation of 32c. per tola.  
Silverware, embossed or chased, other than European, 5 per cent. ad valorem on a valuation of 34c. per tola.  
All other sorts of jewelry, 5 per cent. ad valorem.  
Precious stones and pearls, unset, free.

**The Production of American Precious Stones in 1905.**

WASHINGTON, D. C., June 18.—While the United States may never lead the world in the production of gems, the value of its output of precious stones in 1905 reached the very respectable figure of \$326,350.

The largest output is from the sapphires,

**Alleged Diamond Thieves Held for Trial at Binghamton, N. Y.**

BINGHAMTON, N. Y., June 13.—Frank Kelly and Mary Hennessey, or Mary Mack, the alleged diamond thieves who were arrested in Judson S. Newing's store at Court and Collier Sts., some time ago, continue to interest the police. Kelly was recently held for the Grand Jury by Recorder Watson E. Roberts, who discharged the woman. However, she was immediately rearrested on a warrant charging her with stealing a diamond from J. A. Merrill & Co., Portland, Me., the warrant having been sworn out by Albion Keith, manager of Mr. Merrill's store. Mr. Keith claimed he identified the ring worn by the woman at the time of her arrest as one which had been stolen from his house. When Miss Hennessey was arraigned before the court her attorney



FRANK KELLEY AND MARY HENNESSEY, ALIAS MARY MACK.

mines, the yield of which amounted to \$125,000. Next in value are the turquoise, quoted at \$65,000. Then come the tourmalines, worth \$50,000. Peridots, crystal quartzes, and miscellaneous stones are accredited with a value of \$10,000 each. The production of aquamarines is valued at \$6,000; of kunzite, gold quartz, chrysoptase, silicified wood and garnet at \$5,000 each, of smoky quartz and chlorastrolite at \$3,000 each, of amethyst, agate, pyrite, malachite, anthracite and catlinite at \$2,000 each; of moss agate at \$1,500; of beryl, rose quartz, amazon stone and arrow points at \$1,000 each; of topaz, utah-lite and mesolite at \$500 each; of fossil coral at \$250, and of dumortierite in quartz at \$100.

The southern counties of California bid fair to rival the Ural Mountains in the production of tourmaline, beryl, topaz and the other precious stone which have been the pride of that region for the last half century. The Palo region in San Diego County has become especially notable in gem production. A number of adjacent localities give indication of yielding the same minerals.

Dr. George F. Kunz, who has prepared his report, entitled, "The Production of Precious Stones in 1905," which will soon be published by the United States Geological Survey, is authority for these figures.

waived examination, and she was held for the Grand Jury.

The article which the woman is alleged to have stolen from Merrill is a ring containing diamonds weighing 1-16 and 1-32 carat, valued at \$250, and the strange part of the complaint lies in the fact that Mr. Keith alleges that the larceny was committed in Binghamton. It is claimed that under the Penal Code of New York the conversion of the property can be considered as having taken place here, and the authorities intend to try her on that charge.

Kelly, who is about 38 years old, is 5 feet 4 1/2 inches high, weighs 120 pounds, has brown hair, blue eyes, and a sandy mustache, good teeth, small ears and a ruddy complexion. It is alleged that he had been previously arrested in Chicago and in Syracuse.

Mary Hennessey is 28 years old, 5 feet 3 inches high, weighs about 130 pounds, has brown hair and blue eyes. She formerly resided at Kankakee, Ill. The photographs published above were taken by the police of this city.

The attorney for Kelly and his companion recently filed with the county clerk a bill of sale given him by the prisoners of a quantity of jewelry, in which is enumerated the ring believed to be the property of J. A. Merrill & Co.

# HAYDEN W. WHEELER & CO.

## MOUNTED DIAMONDS



Our stock of Mounted Diamonds includes the newest and best ideas for the approaching June Weddings. We are also splendidly equipped to furnish special designs.



NECKLACES, BRACELETS AND LA VALLIERES ARE AMONG THE PREVAILING FADS AT PRESENT.

AMSTERDAM  
2 TULP STRAAT

LONDON  
50 HOLBORN VIAD

2 MAIDEN LANE, NEW YORK

TELEPHONE  
7365 CORTLANDT

ORDER

# DIAMONDS

ON MEMORANDUM FROM

## ALFRED H. SMITH & CO.

170 BROADWAY, NEW YORK.  
Corner Maiden Lane.

London.  
6 Holborn Viaduct.

Chicago,  
103 State Street.

## Oppenheimer Bros. & Veith, Cutters of Diamonds,

65 NASSAU ST. (PRESCOTT BUILDING), NEW YORK.

AMSTERDAM,  
2 Tulp Street.

LONDON,  
40 Holborn Viaduct.

CUTTING WORKS,  
Cor. Union & Nevins Sts., Brooklyn.

## HENRY E. OPPENHEIMER & CO.,

51 Holborn Viaduct, London.  
50 Rue de Chataudun, Paris.  
7 Place Loos, Antwerp.

Tel. 621 Cortlandt.

3 MAIDEN LANE, NEW YORK.

DIAMONDS, PEARLS AND PRECIOUS STONES.

MEMORANDUM ORDERS SOLICITED.

National Monthly Import and Export Statistics.

WASHINGTON, D. C., June 8.—The records of the Treasury Department contain the following comparative statistics of interest to the jewelry trade for April, 1905, and 1906, and for the 10 months ending April, 1906.

IMPORTS.

	April, 1905.	April, 1906.	—10 Months Ending—	
			April, 1905.	April, 1906.
Clocks and parts of.....	\$28,596	\$37,301	\$123,701	\$175,567
Watches, materials and movements.....	183,121	234,967	2,058,829	2,187,404
Diamonds, uncut, including miners', glaziers' and engravers', not set (free).....	\$91,979	913,847	8,633,872	8,601,489
Diamond dust or bort (free).....	1,250	9,682	341,844	106,337
Diamonds, cut but not set (dutiable).....	973,181	2,363,026	13,645,601	19,976,147
Precious stones, rough or uncut (free).....	2,759	9,378	274,667	114,769
Precious stones and pearls, not set.....	776,269	677,237	4,309,330	4,449,990
Jewelry and manufactures of gold and silver.....	68,771	115,101	1,131,214	1,531,542

IMPORTS OF DOMESTIC MERCHANDISE.

Clocks and parts.....	\$129,361	\$116,610	\$999,718	\$1,088,897
Watches and parts.....	93,058	88,992	905,004	1,041,319
Jewelry and manufactures of gold and silver.....	148,595	149,883	1,182,757	1,492,278
Plated ware.....	67,153	89,662	589,898	710,701

EXPORTS OF FOREIGN MERCHANDISE

Clocks and parts.....	\$13	\$146	\$1,795	\$732
Watches, materials and movements.....	10	162	14,100	3,916
Diamonds, rough, including miners', glaziers', etc.,.....	185	.....	185	2,954
Diamonds, n e s (dutiable).....	.....	282	1,282	21,266
Other precious stones, rough or uncut (free).....	.....	.....	.....	217
Jewelry and manufactures of gold and silver.....	746	3,194	30,255	5,712

Eleventh Annual Convention of National Association of Credit Men.

O. G. Fessenden, of Hayden W. Wheeler & Co., New York, as the president of the National Association of Credit Men, opened last Wednesday the 11th annual convention of the organization in Baltimore, Md. The reports from that city agree that this was the most largely attended and most successful of any meeting yet held by the association.

President Fessenden in his annual address spoke of the growth of the association since the first annual meeting in Toledo, O. Out of the movement he showed that results of the most beneficial character to the commerce of the country have come. Between the wholesaler and his customers closer relations have been effected, and the mutual confidence, which is a most valuable asset, has been established.

Before the association was formed, he said, many business houses had no real system of credits. Information when most needed by a credit man from his fellow credit men was slow in coming, and when received was often useless. Continuing, Mr. Fessenden said:

A distrust based on lack of acquaintance, or fear of each other existed in the minds of many of the credit men of the country. How great the difficulty of getting creditors to act in concert in a case of fraudulent failure those of us who unfortunately were interested know full well. The cases of creditors combining to help an honest but unfortunate debtor to get upon his feet were few and far between. The great merit of adjustment bureaus was not generally recognized and while some lines of business had organizations the work of many that existed was necessarily limited in scope.

The laws of many of the States in matters pertaining to creditor and debtor were unjust to both and a constant source of delay and loss. The conditions mentioned are but a few of those which confronted the credit man in 1896. Our work is by no means finished. Those who come after us must take it up where we leave off and labor as we have with disinterestedness for the general good of all. The records show the work we have done and its results. We have ample cause for congratulation.

No one who has followed the history of the national and local association can for a single moment doubt the absolute necessity for such organizations, if we desire to accomplish results beneficial to credit men and the business commu-

nity. Without local associations the national association could have accomplished little. With their watchful, zealous and enthusiastic support, we are invincible. I am equally sure that without a national association the work of the local associations would be confined to limits so narrow that no real benefit to the commercial world would result.

Massachusetts Jeweler Causes Return of Brooch Lost a Year Ago.

SPRINGFIELD, Mass., June 13.—Through the astuteness of E. Penny, 417 Main St., this city, a brooch belonging to a lady of Manchester, Conn., which had been missed for nearly a year, was restored to its owner last week. The loss was advertised for many months and a reward offered, but nothing was heard of the property until it was recovered by the jeweler. The brooch in question was sold by Mr. Penny five years ago.

About two weeks ago a man walked into Mr. Penny's store and offered to dispose of a brooch. The stranger was well dressed, of prepossessing appearance, and there was nothing about him to excite the least suspicion; yet as soon as Mr. Penny took hold of the article he recognized it as the piece he had sold to the Manchester lady five years before, and also remembered that it had been advertised for as lost. Examining the article, he found the sales mark, and, referring to his record, he convinced himself that he was right.

He then informed the stranger that the brooch did not belong to him, and the man became indignant and demanded his property; but Mr. Penny told him to return in a few days, giving him a receipt for the article. Thursday morning last he came back to the jewelry store just in time to meet the owner of the brooch, who had been notified by Mr. Penny of its recovery.

The man had found the article, and when it was proven to him that it belonged to the lady in question he claimed the reward offered for its return. Inasmuch as he had held the brooch for a long time and attempted to dispose of it, the question was left to the Chief of Police of Manchester to decide.

Jewelry, Clocks, Optical Goods and Indred Lines Exported from New York.

WASHINGTON, D. C., June 13.—The following were the exports of jewelry, silverware, and optical goods, clocks, watches and indred lines from the Port of New York for the week just ended:

Albany: 2 packages silverware, \$111; 1 package watches, \$1,000.  
 Albany: 3 packages plated ware, \$578; 268 packages clocks, \$4,283; 1 package clocks, \$299; 12 packages jewelry, \$2,498; 5 packages watches, \$1,000.  
 Albany: 23 packages clocks, \$305.  
 Albany: 1 package clocks, \$125; 7 packages watches and views, \$700.  
 Albany: 21 packages clocks, \$1,372; 2 packages silverware, \$253; 7 packages freezers, \$178; 1 package plated ware, \$253; 1 package watches, \$1,000.  
 Albany: 3 packages plated ware, \$525; 1 package plated ware, \$225; 3 packages optical goods, 1 package jewelry, \$500.  
 Albany: 11 packages plated ware, \$1,489; 1 package optical goods, \$272.  
 Albany: 2 packages watches, \$250; 32 packages jewelry, \$550.  
 Albany: 57 packages clocks, \$978; 1 package optical goods, \$166; 6 packages plated ware, \$177.  
 Albany: 38 packages clocks, \$712.  
 Albany: 12 packages clocks, \$207.  
 Albany: 1 package jewelry, \$565.  
 Albany: 1 package jewelry, \$700; 1 package watches, \$350.  
 Albany: 1 package optical goods, \$110; 2 packages optical goods, \$201; 11 packages clocks, \$410; 1 package scopes, \$200.  
 Albany: 20 packages clocks, \$173; 35 packages jewelry, \$409; 124 packages clocks, \$1,319; 1 package silverware, \$113; 1 package plated ware, \$100; 1 package jewelry, \$130.  
 Albany: 5 packages watches, \$542; 1 package jewelry, \$2,631; 4 packages scopes and views, \$100.  
 Albany: 48 packages clocks, \$840.  
 Albany: 1 package watches, \$129.  
 Albany: 2 packages optical goods, \$110; 30 packages jewelers' ashes, \$18,500; 47 packages jewelry, \$998; 2 packages jewelry, \$1,005; 5 packages thermometers, \$205; 4 packages jewelers' tools, \$500; 1 package optical goods, \$500; 1 package jewelry, \$500; 2 packages plated ware, \$1,900.  
 Albany: 55 packages clocks, \$1,645; 14 packages plated ware, \$694; 8 packages clocks, \$380; 1 package optical goods, \$252; 3 packages scopes and views, \$514.  
 Albany: 156 packages clocks, \$2,887; 2 packages jewelry, \$221; 26 packages plated ware, \$1,000.  
 Albany: 1 package jewelry, \$380.  
 Albany: 4 packages scopes and views, \$100.  
 Albany: 1 package watches, \$150; 8 packages jewelry, \$133.  
 Albany: 4 packages watches, \$1,370; 8 packages optical goods, \$1,545; 39 packages watches, \$4,477.  
 Albany: 3 packages plated ware, \$112.  
 Albany: 123 packages clocks, \$1,220.  
 Albany: 1 package watches, \$624; 31 packages clocks, \$253; 14 packages plated ware, \$1,765; 1 package silverware, \$400; 4 packages watches, \$1,000.  
 Albany: 2 packages plated ware, \$164.  
 Albany: 315 packages clocks, \$4,645; 4 packages watches, \$442.

Recent Changes in Tariff of French Oceania.

WASHINGTON, D. C., June 13.—The following tariff changes have recently been made in French Oceania:

Jewelry of gold, silver, plated, with precious stones, pearls, imitation pearls, etc., 13 per cent. ad valorem.  
 Jewelry, neckled, imitation, 13 per cent. ad valorem.  
 Gold and silversmiths' ware, 13 per cent. ad valorem.  
 Clocks and watches, 15 per cent. ad valorem.  
 Instruments, photographic, 8 per cent. ad valorem.  
 Sewing machines, sculptured and engraved, lusters and articles, 10 per cent. ad valorem.  
 Glass and crystal wares of all kinds, 15 per cent. ad valorem.

**Mr. ABE A. HELLER**  
 is now in charge of our European offices. with headquarters at  
**39 Rue de Chateaudun, PARIS.**



BIRDSEYE VIEW OF PARIS.

Many years of studying the Jewelry trade here have given our Mr. Abe A. Heller an intimate knowledge of the wants of the American Manufacturer, which will be of great advantage in selecting the right goods for the American Market.

***L. Heller & Son***

Importers of Precious and Imitation Stones.

New York, 51 Maiden Lane      Providence, 212 Union Street  
 Paris, 39 Rue de Chateaudun      Idar, 14 Hauptstrasse  
 TELEPHONE 219 JOHN.

GEORGE H. HODENPYL.

WALTER N. WALKER

**DIAMONDS**  
 AND  
 DIAMOND JEWELRY  
**HODENPYL & WALKER**

Unique  
 and  
 Staple Patterns

**170 Broadway, New York**  
 Corner of Maiden Lane  
**TELEPHONE, 1898 CORTLAND**

Repairing and Recutting  
 Diamonds  
 a Specialty

OUR  
**40th**  
**YEAR**

IN  
 BUSINESS

1866-1906

**DIAMONDS**  
 LOOSE AND MOUNTED

**CASES and MOVEMENTS**  
 ALL MAKES AND GRADES

**JEWELRY**  
 GOLD AND PLATED

ORDERS SOLICITED FROM RESPONSIBLE JEWELERS.      GOODS SENT ON SELECTION.

All our goods are either direct importations, our own manufacture or bought for cash enabling us to offer special inducements in prices and terms.



EST. 1866.  
*Lissauer & Company*  
 Importers.  
 2 TULPSTRAAT,  
 AMSTERDAM.

12 MAIDEN LANE.  
 (ONE FLIGHT UP)  
 P. O. Box, 1525,  
**NEW YORK.**

**PEARLS**      **ROUND, BUTTON**  
 ———— **AND HALF.**

Selection Papers Sent on Request

**MARTIN LOW & TAUSSIG,**

51 Maiden Lane, New York.  
 Telephone, 2817-John.

139 Mathewson St., Providence, R. I.  
 Telephone, 3037-Union.

**Decisions by United States Courts on Jewelry, Gems and Kindred Lines.**

Decisions by the United States Circuit Courts in cases involving duties on jewelry and kindred lines were announced last week as follows:

**CLOCKS AND DETECTORS.**—C. D. Stone & Co. vs. United States. United States Circuit Court, Northern District of Illinois, eastern division, May 2, 1906. No. 27817. On application for review of a decision of the Board of United States General Appraisers. Before Betha, District Judge. Decision *affirmed* without prejudice, by consent. The importers contended that time detectors held by the Board to be dutiable as clocks under Par. 191, tariff act of 1897, should have been classified as watch movements under the same Par. For decision under review see Abstract 7206 (T. D. 26659). Appeal.

**FINISHED JEWELRY.**—Albert Lorsch & Co. vs. United States. United States Circuit Court, Southern District of New York, May 28, 1906. On application for review of a decision of the Board of United States General Appraisers. Before Platt, District Judge. Decision *affirmed* by consent, without opinion. The importers contended that finished watch fobs classified as parts of jewelry, unfinished, under Par. 434, tariff act of 1897, were dutiable as manufactures of metal under Par. 193. For decisions under review see Abstracts 7511-5 (T. D. 26637).

**PINS—JEWELRY.**—United States vs. Veit & Co. (2 cases). United States Circuit Court, Southern District of New York, May 12, 1906. On application for review of decisions of the Board of United States General Appraisers. Before Platt, District Judge. Decisions *affirmed* by consent, without opinion. The merchandise consisted of wax pins, pearl pins, wax pins, or jet pins, and plain heads of glass or paste. They were held by the Board to be dutiable as manufactures of the component material of chief value, and the Government contended (T. D. 26686) that they were properly classified as jewelry under Par. 434, tariff act of 1897. For decision below see Abstracts 7831 and 7869 (T. D. 26682).

**PINS—JEWELRY.**—United States vs. Sams & Hilder Bros. United States Circuit Court, Southern District of New York, May 9, 1906. On application for review of a decision of the Board of United States General Appraisers. Decision *affirmed* by consent, without opinion. The merchandise consisted of lace or belt pins, held by the Board to be dutiable as manufactures of the component material of chief value, with the Government contended (T. D. 26633) were properly classified as jewelry under Par. 434, tariff act of 1897. For decision under review see Abstract 7874 (T. D. 26682).

**PINS—JEWELRY.**—United States vs. Dieckhoff, Raffloer & Co. (4099) and United States vs. Veit, Son & Co. (2 cases, 4100-1). United States Circuit Court, Southern District of New York, May 12, 1906. On application for review of decisions of the Board of United States General Appraisers. Decisions *affirmed* by consent, without opinion. The articles in dispute consisted of wax pins, pearl pins, wax pins, or jet pins having plain heads of glass or paste; and of small belt or veil pins. They are

held by the Board to be dutiable as manufactures of the component material of chief value, and the Government contended (T. D. 26686) that they were properly classified as jewelry under Par. 434, tariff act of 1897. For decisions below see Abstract 7926 (T. D. 26691) and Abstracts 7868 and 7870 (T. D. 26682).

**PINS—JEWELRY.**—United States vs. I. Emrich & Co. United States Circuit Court, Southern District of New York, May 11, 1906. On application for review of a decision of the Board of United States General Appraisers. Decision *affirmed* by consent, without opinion. The articles in dispute consisted of hat, shawl, belt, or toilet pins, which were held by the Board to be dutiable as manufactures of the component material of chief value. The Government contended (T. D. 26686) that they were properly classified as jewelry under Par. 434, tariff act of 1897. For decision below see G. A. 6139 (T. D. 26679).

**PINS—JEWELRY.**—United States vs. A. & H. Veith. United States Circuit Court, Southern District of New York, May 16, 1906. On application for review of a decision of the Board of United States General Appraisers. Decision *affirmed* by consent, without opinion. The merchandise consisted of pins which were held by the Board to be dutiable as manufactures of the component material of chief value. The Government contended (T. D. 26686) that they were properly classified as jewelry under Par. 434, tariff act of 1897. For decision below see G. A. 6139 (T. D. 26679).

**PINS—JEWELRY.**—United States vs. Leon Rheims Co. (1104) and United States vs. George Borgfeldt & Co. (4105). United States Circuit Court, Southern District of New York, May 9, 1906. On application for review of a decision of the Board of United States General Appraisers. Decision *affirmed* by consent, without opinion. The articles in dispute were described in the Government's petitions as consisting of hat, shawl, belt, toilet or lace pins, with black heads, faceted or otherwise, or with so-called plain wax paste or glass heads, or with beads imitating round or baroque pearls. The Board held them dutiable as manufactures of the component material of chief value, and the Government contended (T. D. 26686) that they had been properly classified as jewelry under Par. 434, tariff act of 1897. For decision below see G. A. 6139 (T. D. 26679).

**PINS—JEWELRY.**—United States vs. Dieckhoff, Raffloer & Co. United States Circuit Court, Southern District of New York, May 12, 1906. On application for review of a decision of the Board of United States General Appraisers. Decision *affirmed* by consent, without opinion. The articles in dispute consisted of hat, shawl, belt, toilet, or lace pins. They were held by the Board to be dutiable as manufactures of the component material of chief value, and the Government contended (T. D. 26686) that they were properly classified as jewelry under Par. 434, tariff act of 1897. For decision below see G. A. 6139 (T. D. 26679).

**PINS—JEWELRY.**—Leon Rheims Co. vs. United States. United States Circuit Court, Southern District of New York, May 11, 1906. On application for review of a decision of the Board of United States General

Appraisers. Decision *affirmed* by consent, without opinion. The goods in question consisted of hat, bonnet, or shawl pins, made entirely of metal in imitation of gold or silver, having heads enameled or otherwise ornamented, or made of metal set with imitation precious stones faceted, or set with pearl, ivory, paste, or other materials, the mountings ornamented with metal bands, scroll work, or other ornamental designs. The Board held them to have been properly classified as jewelry under Par. 434, tariff act of 1897. The importers contended that they should have been classified as manufactures of the component material of chief value. For decision below see G. A. 6139 (T. D. 26679).

**BELT BUCKLES AND CLASPS—JEWELRY.**—Blumenthal & Co. vs. United States. United States Circuit Court, Southern District of New York, May 9, 1906. On application for review of a decision of the Board of United States General Appraisers. Decision *reversed* by consent, without opinion. The articles in controversy are described in the opinion of the Board (1) as metal belt knuckles and clasps, substantially constructed to stand constant use, made respectively of steel, base metal made to imitate gold or silver, and steel and imitation gold or silver more or less elaborately enameled, and (2) as belt buckles elaborately ornamented, composed of base metal made to imitate gold and oxidized silver, set with imitation diamonds and other precious stones. The Board held on the authority of Bader vs. United States (116 Fed. Rep., 541) that they had been properly classified as jewelry under Par. 434, tariff act of 1897. The importers contended that they were dutiable as manufactures of the component materials of chief value. For decision under review see G. A. 6141 (T. D. 26681).

**PINS—JEWELRY.**—United States vs. I. Emrich & Co. (4110) and I. Emrich & Co. vs. United States (4111). United States Circuit Court, Southern District of New York, May 14, 1906. On application for review of a decision of the Board of United States General Appraisers. Decision *affirmed* by consent, without opinion. The articles in dispute consisted of hat or bonnet pins, some held dutiable by the Board as manufactures of the component material of chief value as claimed by the importers, and some to have been properly classified as jewelry under Par. 434. Each side appealed from the decision of the Board in the respects in which it was adverse. For decision below see Abstract 7927 (T. D. 26694).

**PINS—JEWELRY.**—United States vs. Worthington Smith & Co. United States Circuit Court, Southern District of New York, May 9, 1906. On application for review of a decision of the Board of United States General Appraisers. Decision *affirmed* by consent, without opinion. The merchandise consisted of pins composed of metal or horn, with plain round heads, held by the Board to be dutiable as manufactures of the component material of chief value, which the Government contended (T. D. 26686) were properly classified as jewelry under Par. 434, tariff act of 1897. For decision under review see Abstract 8026 (T. D. 26708).

DIAMONDS

DIAMONDS

OUR  
MR. ROSENBACK  
HAS JUST RETURNED  
ON THE KAISER WILHELM II  
FROM OUR  
FOREIGN OFFICE  
No. 2 TULP STRAAT  
AMSTERDAM  
HOLLAND

# DIAMONDS

COMPLETE  
STOCK  
RIGHT PRICES  
—  
YOUR  
BUSINESS  
SOLICITED

WM. I. ROSENFELD

19 MAIDEN LANE, NEW YORK

DIAMONDS

DIAMONDS



**Ninth Annual Convention of Iowa State Association of Opticians.**

DES MOINES, Ia., June 14.—The ninth annual convention of the Iowa State Association of Opticians, held here Tuesday and Wednesday, was favored with the largest attendance in the history of the organization, and the proceedings were of much interest and value. The large attendance and enthusiasm of the members placed the association on a firmer footing than ever before. Kansas City was chosen as the next meeting place for the reason that the national association will hold its convention there, and the Iowa men will meet at the same time.

The following officers were elected: president, A. F. Thompson, Adel; vice-president, B. M. Bills, Vinton; treasurer, C. Nuckolls, Eldora; secretary, George Feige, Des Moines. Directors: B. M. Bills, A. F. Thompson, H. W. Krotzer, Osceola, G. L. Goodale, Lenox, and M. Hurlburt.

Mr. F. Renaud, Keokuk, refused re-election for the presidency for a second term, so that there was a promotion of the old officers, George Feige being the new member of the executive staff. The association presented Mr. Renaud with a silver loving cup in recognition of his services.

There was a pleasant surprise in store for the opticians, and they were not slow to take advantage of the opportunities for social enjoyment that it afforded. The date of their annual meeting coincided—quite unintentionally, it is said—with the annual meeting of the Iowa Graduate Nurses' Association, and on the evening of the closing day the opticians officially became the guests of the Graduate Nurses' Association. The evening was spent at the pleasant open-air vaudeville theatre at Ingersoll Park, the popular summer amusement resort of Des Moines.

The opticians determined to continue their efforts for a State examining board, and fully attended their efforts in this direction at the last session of the Iowa Legislature, and a great deal of disappointment was expressed. Karl D. Fisk, West Union, legislative agent of the association, expressed dissatisfaction with the action of the legislature, which he declared did not give full demands of the opticians a fair hearing. The effort will be renewed at the legislative session next winter.

The paper of A. F. Thompson on "Skiascopy" was a scientific and able presentation of that interesting subject. The illustrated address of Dr. Arthur C. Campbell, Topeka, Mo., on "Light, Health and Lenses," was another very interesting feature of the programme. Other subjects treated were: "Special Lenses as Therapeutics," by J. C. Turk, Sioux City, Ia.; "Energy, Its Distribution to the Eye," G. J. Feige; "What's Wrong?" William E. Huston, Kansas City; "Accommodation," H. P. Holmes, Des Moines; "Legislation," Karl D. Fisk, West Union; "Here and There," W. B. Ankeny, Keokuk.

Dr. Arthur Campbell, who spoke in favor of the use of health lenses, described the action of the ultra-violet or "health" rays on the tissues of the eye. He dealt with the health-giving influence of the violet rays and their action on the blood, and discussed

various makes of lenses as regards their value in transmitting the rays.

Speaking of the distribution of energy to the eye, Mr. Feige said in part: "Many attempts have been made with mechanical apparatus to thoroughly control energy, and the results are well known. The eye being the most active function that the brain has to deal with, it necessarily demands a larger amount of energy, and, like any delicate or complicated piece of machinery, every detail of its requirements must be accurately looked after."

He referred to the success in making lenses which insured a perfect distribution of energy and the prevention of waste.

H. W. Krotzer, Osceola, made a plea for the continued use of the trial case.

**Second Annual Convention of the Iowa Retail Jewelers' Association.**

DES MOINES, Ia., June 16.—A movement designed to bring about fixed selling prices for watches in all parts of the country was launched at the annual meeting of the Iowa Retail Jewelers' Association in this city, Thursday and Friday. There was a strong sentiment at this meeting in favor



J. M. NABSTEDT, PRESIDENT.

of restricted prices. In the meantime, the members of the Iowa association were urged to adhere to uniform prices as nearly as possible.

The convention was the second which the Iowa jewelers have held. The association has manifested a very encouraging growth since its organization, Feb. 13 last. The attendance was large, as the meeting followed the next day after the close of the opticians' State convention, and a large number of jeweler-opticians remained for both meetings. As showing the interest taken in the new organization, it may be mentioned that of the jewelers who attended the gathering, only one went home without subscribing his name to the membership list.

The best means to overcome the competition of the mail order houses and department stores formed an important part of the discussion. In the speeches made

on this subject the members were urged to patronize only those manufacturers and jobbers who declined to supply mail order houses. The convention did not adopt resolutions on the catalogue question, but the sentiment in favor of showing the fullest appreciation of the manufacturers who refused to sell to mail order firms found emphatic expression on the floor.

J. M. Nabstedt, Davenport, who had been vice-president of the association, was elected president of the association; M. A. Hurlburt, Fort Dodge, was elected vice-president, and J. H. Lepper, Mason City, was re-elected secretary-treasurer. Mr. Lepper has been most enthusiastic in the work of organization, and the association was only too glad to recognize his services by unanimously re-electing him. The three foregoing officers, together with N. Nielson, Harlan, and L. E. Smith, Oskaloosa, constitute the new executive committee. The association adopted an official emblem, consisting of a watch dial, on the rim of which appear the words, "Iowa Retail Jewelers' Association."

The following papers were read: "Value of Organization," J. H. Lepper, Mason City; "The Optical Business as a Side Line for Jewelers," W. H. Ankeny, Corning; "Advertising, Good and Bad," M. A. Hurlburt, Ft. Dodge; "Work Shop Notes," J. M. Nabstedt, Davenport; "Advertising Value of Jewelers' Show Windows," L. E. Smith, Oskaloosa; "The Little Things That Stop Watches," Charles Peck, Ottumwa; "Side Lines for Jewelers," N. Nielson, Harlan; "Value of a Fixed Selling Price," J. J. Dalgleish, Grundy Center; "Mail Order Competition and How to Meet It," W. J. Pilkington, Des Moines.

A humorous incident of the convention was the presentation to Gov. A. B. Cumins of a "jumbo" display watch, as a souvenir of a visit paid by the jewelers to the State capitol.

On Thursday evening, June 14, the members of the association were tendered a banquet by the following Des Moines firms: M. A. Lumbard Co., Guinand-Jones Co., Herman Kirch, Frank Schlamp, R. N. Bromley & Sons and J. C. Robinson.

**Authorities of Denver, Colo., Seek Whereabouts of George Freeman.**

DENVER, Colo., June 18.—Alexander Nisbet, sheriff of this city, has issued a circular containing a full description of George Freeman, alias Isaac Freeman, who is wanted for swindling jewelers throughout Colorado and other places. Many local dealers have fallen victims to the culprit.

He is an Englishman, 29 years of age, with blue eyes and distinctly bad teeth. He is 5 feet 3½ inches in height, weighs 159 pounds, and has a peculiar habit of carrying his head on the right side. The initials, "F. K. R. E.," appear in India ink on the left arm, just above the wrist. He was apprehended in 1904, but then jumped his bond.

David S. Wolfkill, a retail jeweler, of Tacoma, Wash., recently sustained serious injuries. While at work in his store an alcohol lamp exploded and the blazing contents was hurled over Wolfkill's face and head, painfully burning his scalp and face.

# Chester Billings & Son

1840

Successors to  
Kandel, Barmore & Billings

1906

Importers of Diamonds  
Other Precious Stones, and  
Pearls, Diamond Jewelry

1840, Kandel & Barmore; 1866, Kandel, Barmore & Co.; 1880, Kandel, Barmore & Billings; 1897, Chester Billings & Son

New York, 58 Nassau Street, 29 Maiden Lane  
London: 22 Holborn Viaduct, E. C. Paris: 53 Rue de Chateaudun  
Amsterdam: 2 Culp Straat

## Death of Andrew J. Lloyd.

Boston, Mass., June 16.—Andrew J. Lloyd, senior partner of the prominent Boston firm of Andrew J. Lloyd & Co., jewelers, of which he was the founder, died at his home on Bay State Road, this morning on the morning of June 14. He was 58 years. He left a widow.

Mr. Lloyd had been ill but a few days. He was at his office on the previous Saturday, apparently in excellent health, and attended to routine affairs in which he was interested. During the past two or three years he had not devoted so much time in previous years to business, taking recreation, and leaving details to the active partners. On Sunday he went to Brookline, visiting the beautiful estate of the Sargents, known as Holmead, and while there was stricken with apoplexy. He was conveyed to his home, and did not regain consciousness.

Mr. Lloyd was a native of Nova Scotia, his birthplace being Lockport, whence he came to Boston in 1866 at the age of 17. He served an apprenticeship with the time house of William Bond & Son, maker of clocks, chronometers and nautical instruments. In 1870 he started the business in which he has been steadily built up under his own direction, and the firm ranks among the leading concerns in the city, conducting large stores, one at 315 Washington St., the other at 310 Boylston St. The former establishment occupies several floors of a building, housing various departments of manufacturing and retailing branches of business that comprises all kinds of optical goods, photographic supplies and kindred stock.

Deceased was personally the inventor of several improvements in glasses and spectacles, and had done much to advance the optical profession, of which he was an exceedingly skilful exponent. His proficiency in his chosen life work brought him in contact with experts in the use of microscopes, lenses, cameras and scientific instruments of similar nature. He was also a member of several scientific societies, took an interest in the optical associations and their conventions, and developed within himself a spirit of true scientific investigation, especially in the world of nature, which afforded him unfeeling delight. Natural history, botany, geology and the animal kingdom were all embraced to a marked degree in his book of knowledge, and the circumstances attending the beginning of an illness which proved fatal were such as to attest to the habitual trend of his character and ideals.

Funeral services were held at Mr. Lloyd's residence, Bay State Road, this afternoon at 2 o'clock, and were attended by a large number of representative members of the optical and jewelry trades, among which had a host of friends.

The British Consul at Alexandria, Egypt, finds many commercial opportunities for the sale of foreign manufactures. A reliable watch retailing from \$5 to \$10, says, will find a ready market among the natives if properly advertised. It should be plainly stamped with the name of the country where manufactured.



## COOPER'S SUN RAY DIAMOND

HAS 100 per cent. more brilliancy  
than any other style of cutting.

**We Challenge the World.**

Send your old mine and yellow  
diamonds to be recut; if the effect  
is not 100 per cent. better, NO  
CHARGE.

**COOPER DIAMOND**  
Cutting and Polishing Industry of America  
49 MAIDEN LANE, NEW YORK.

Factories, 8th Ave. & 18th St., Brooklyn.



TRADE MARK.

## AZTEC TURQUOISES

Mines: MINERAL PARK, ARIZONA.



TRADE-MARK.

Of true CERULEAN BLUE, the rarest and most fashionable shade. Turquoises bearing Company's trade-mark are GUARANTEED. A new Turquoise will be given without question to replace any that discolors. The leading Jewelers of the World sell AZTEC TURQUOISES.

**THE AZTEC TURQUOISE COMPANY,**  
12-16 JOHN STREET, NEW YORK.

## AMERICAN PEARLS

From Ten to Ten Thousand Dollars Each

MAURICE BROWER, 16 John St., New York.

## National Gold and Silver Stamping Law Enacted.

**B** Started by Circular-Weekly and Introduced by Representative Vreeland signed by President Roosevelt—A Brief History of the Measure, and the Full Text of the Law.

WASHINGTON, D. C., June 14.—President Roosevelt has signed the Jewelry Trade's Gold and Silver Stamping Bill, introduced by Representative Vreeland, and the measure is now a law, though its provisions do not take effect until one year from this date. The bill had previously been signed by Representative Fairbanks and Mr. Cannon and had been passed by the Senate and House respectively and was sent to the President who turned it over to Attorney-General Moody to pass upon its constitutionality, etc.; the attorney-general's report was most favorable and the President then signed his signature.

The bill, which was inaugurated by THE CIRCULAR-WEEKLY shortly more than a year ago, established a record for the rapidity with which it passed both houses of Congress, that astonished legislators and the public alike as it was introduced into the House of Congress for the first time, less than five months ago (Jan. 31). It given careful consideration by the interstate commerce committees of both Houses, was subjected to no delay whatsoever and passed in practically the same form as introduced, being amended in only a few slight particulars in a way that was generally agreed to by the interests behind the bill before the measure was offered to Congress for its consideration.

What is especially remarkable is the fact that so much consideration was given to this bill of this kind at one of the most important sessions of Congress held for many years, when the calendars of both Houses were practically choked with measures of most vital interest to the country at large.

### HISTORY OF THE BILL.

The passing of the Jewelry Trade Gold and Silver Stamping Law, to a certain extent, ends one of the most important fights to enforce honest business methods that has ever been made in the jewelry trade and the victory is one of which all members of the jewelry, gold, silver and kindred industries may feel justly proud, as it is to a great extent due to the harmony of feeling and the absolutely united support given to the measure by all branches in the jewelry industry.

The desire for national legislation on this subject goes back almost as far as the oldest jeweler of the country can remember, although one or two attempts to obtain such a bill were made in former years, no definite movement of the kind was inaugurated until little more than a year ago, and it was not until THE CIRCULAR-WEEKLY pressed before the trade the bill, of which the present law is the outgrowth, that a measure, constitutional in all its features and one capable of being passed by our national legislature, was put forth in a way that made victory possible.

Shortly after the agitation for regulation of the marking of silver in various States began in 1893, a movement for a national law was proposed. The idea of having such a law apply to gold was finally

abandoned, but a bill to regulate the stamping of silver alone was introduced in the United States Congress by Representative Amos Cummings, of New York, in May, 1894. The jewelry trade, particularly the retailers and the silversmiths, almost as a whole were in favor of this measure, but unfortunately doubt as to its constitutionality was immediately expressed, and this doubt was confirmed through interviews given to the editor of this journal by many of the most prominent constitutional lawyers of the country, among which were the late F. R. Coudert, the late Austin Abbott, the late James C. Carter, and a number of others whose authority to speak on such subjects was generally recognized by the bench and bar.

It was on the advice of Austin Abbott that this journal then bent all its energies to obtain State legislation, and also on his advice that we watched for the opportunity to propose a measure covering interstate traffic in such articles, the moment that the marking and stamping of gold and silver were regulated by the State in which the greatest business in these lines is done, namely, New York. For some years little hope of obtaining any relief from Congress was entertained and the subject was dropped by this journal, but not abandoned while attempts to obtain a gold law in New York were made.

In the meantime a careful perusal of the anti-lottery law and some of the more recent decisions of the Supreme Court, in relation to the Interstate Commerce Law, convinced the management of this journal that an act could be drawn that would supplement State laws in a way that would practically and constitutionally put a stop to the selling of spuriously marked goods; provided one or two States, such as New York, Massachusetts, or Illinois, would legislate on the subject. The question arose, however, as to whether the subject still held the keen interest for the jewelry trade that it did a decade ago, but this was quickly answered in the affirmative when the wholesalers and retailers had a chance to express themselves on an amendment introduced to a bill in Congress in January, 1905.

The subject of false marking was no new one to Congressman Vreeland, as in the latter part of 1904 he introduced into the House of Representatives a bill forbidding the stamping upon precious metals of any words or phrases that would indicate that the government in any way certified as to the fineness of the metal; which bill was effectually passed and is now on the statute books. When the measure was in the Senate, an attempt was made to amend it by adding a new section that would apply to false marking of gold and silver of all descriptions, and though this amendment was crudely drawn and of decidedly doubtful constitutionality, nevertheless, the expressions in favor of such a law that were heard from all parts of the jewelry trade were sufficient to show that such a meas-

ure was not only wanted, but was needed as badly, if not more than ever before.

Members of the trade in all parts of the country were then interviewed by THE CIRCULAR-WEEKLY and the sentiment in favor of such a law was so unanimous that it was decided to take up the subject immediately after Congress had finished with Mr. Vreeland's bill as to marks that related to government certification. Circulars were also sent to retail jewelers throughout the country by the Ducler Watch Case Mfg. Co., and the answers received were exactly to the same effect; i. e., as received by THE CIRCULAR-WEEKLY, that the trade as a whole was strongly in favor of such a measure.

In January, 1905, THE CIRCULAR-WEEKLY began work upon its bill and as the result of the study of the question which the management had made for eight years, it decided upon a measure which would be in line with the anti-lottery law and interstate commerce decisions, and would forbid interstate traffic in products of the precious metals that were improperly marked as to quality.

While work was going on in this way, a bill to regulate the marking on goldware was introduced for the third time in the legislature of New York which had already passed laws for silver, and the gold bill made such great progress that it was decided to wait until after this was enacted before pushing the movement for a national law. Mr. Vreeland's first bill became a law in the latter part of February, 1905, and it was then so late in the session that little or nothing could be done on the subject of a general stamping bill until Congress met in the following December; but the moment that the gold law was passed in New York, and signed by Gov. Higgins (April 24, of last year), the campaign for the national law was begun by this journal in earnest. Frank L. Crawford, of New York, the attorney, who had had charge of the gold legislation before the New York legislature and had successfully carried it to victory, was engaged by THE CIRCULAR-WEEKLY to draw up a national law on the lines mentioned above, and after he completed his work, the bill was submitted to the members of the trade in all branches for expressions of opinion, suggestions and comments; after these were received, the measure was finally placed before the members of the trade at large and was printed in full in the issue of THE CIRCULAR-WEEKLY, July 5, 1905.

The Ducler Watch Case Mfg. Co. also had had a bill drawn, but on entirely different lines, and copies of this were sent to the retail jewelry trade in all sections of the country. This bill the company had placed in the hands of Congressman Vreeland to introduce, Mr. Vreeland having practically stated to the members of Congress when his former bill was being considered, that he would introduce a general stamping bill at the next session.

The unanimity with which the retail trade supported the stamping movement was remarkable, thousands of comments in favor of such legislation being received by Congressman Vreeland and by THE CIRCULAR-WEEKLY from the retail jewelers of every State in the Union, many of which com-

# WM S. HEDGES & CO.,

IMPORTERS AND CUTTERS OF

## DIAMONDS.

Precious Stones and Pearls.

170 Broadway, Corner Maiden Lane, New York.

27 Holborn Viaduct, London.

Saunders, Meurer & Co. Cutters and Importers of

## DIAMONDS AND OTHER PRECIOUS STONES

FINE PEARLS A SPECIALTY.

65 Nassau St., cor. John St., Prescott Building, Telephone, 1613 Cortland, NEW YORK.

Chas. L. Power & Co., Cutters and Importers,

## DIAMONDS

AND OTHER PRECIOUS STONES,

170 Broadway, corner Maiden Lane, NEW YORK.

27 Holborn Viaduct, London.

## GOODFRIEND BROS.,

IMPORTERS AND CUTTERS OF PRECIOUS AND IMITATION STONES.

Pearls

Rubies

Sapphires

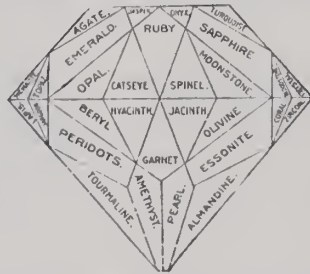

Tourmalines

Gem Corals

Opals

Emeralds

COPYRIGHT, 1895, BY GOODFRIEND BROS.

256 Westminster St., Providence, R. I.  
10 Rue Cadet, Paris.

Tel. No. 662 Cortland.

9-11-13 Maiden Lane, New York.

## CORAL

BORRELLI & VITELLI,

CORAL MANUFACTURING COMPANY,

All kinds of Coral—DROPS, BUTTONS, LENTILLES.

CORAL NECKLACES, Graduated and Uniform.

PINK AND WHITE CORAL A SPECIALTY.

GOLD MEDAL, ST. LOUIS, 1904.

GRAND PRIX, LIEGE, 1905.

3 Via Amedeo, Torre del Greco, Italy.

32 Rue d'Hauteville, Paris, France.

401 Broadway, New York.

Telephone, 5412 Franklin.

CORAL

CORAL

ments were published in this journal last summer. Although the two bills were distinctly unlike, one being a drastic measure providing for heavy penalties, forfeiture and compulsory stamping of quality of articles, and the other (THE CIRCULAR WEEKLY'S bill), being in substance the same as that has just been passed. Nevertheless, both were praised and endorsed, showing that as far as the retail trade was concerned the substance of the bill did not count. It is believed that it accomplished the object. All we can do is to leave the text to those who are willing to consider it competent to pass a law for the movement.

This journal was committed to no course, not even its own, and was willing to endorse and support any bill which it believed would accomplish the object desired, was constitutional in its provisions and was likely to be passed by Congress. A careful consideration of the subject, and the bills had been submitted to expert authorities, convinced the management of THE CIRCULAR WEEKLY that its measure, though not as strong and drastic as was desired, was the one drawn on the best and most likely to obtain the approval of Congress. Copies of the bill were sent to the manufacturing jewelers' associations in New York, New England, Newark, and other centers, as well as to leading manufacturers of the trade.

The New England Jewelers' and Silversmiths' Association, whose members have become interested in the subject, and have been visited by Congressman Vreeland, has appointed a committee to express their views in a bill. This committee, after due deliberation, reported a measure which was thought was in the best interests of the association, and which bill followed the provisions of THE CIRCULAR WEEKLY'S bill, with a few slight amendments, and contained additional paragraphs that would cover the subject of rolled gold and electroplating, subject which had not been touched upon until then.

In December of last year, a conference was held between the editor of this paper and Congressman Vreeland, after which Mr. Vreeland stated that he had decided not to introduce a bill such as had been handed to him by the Dueber Watch Company, but instead would draw a measure on the lines of THE CIRCULAR WEEKLY'S act. At the same time there was submitted to Mr. Vreeland a copy of the New England manufacturing jewelers' measure so that all interests became in accord.

There were still some differences of opinion as to minor points between jewelers in various sections, such as the proper amount of leeway (or variation from quality) to be allowed, and to settle this and make the trade unanimous on every point of the bill, a movement was begun to obtain joint action by representatives of manufacturers in various sections. A meeting of the manufacturing jewelers of New York was called Jan. 8 last, to take action on the stamping bill before it was finally introduced; at this meeting a committee, to act for the trade in New York, was appointed consisting of a number of the leading members of the craft, including the presidents of practically every association in the trade, who were empowered

## FULL TEXT OF THE NATIONAL STAMPING LAW.

## AN ACT

FORBIDDING THE IMPORTATION, EXPORTATION, OR CARRIAGE IN INTERSTATE COMMERCE OF FALSELY OR SPURIOUSLY STAMPED ARTICLES OF MERCHANDISE MADE OF GOLD OR SILVER OR THEIR ALLOYS, AND FOR OTHER PURPOSES.

Be it enacted by the Senate and House of Representatives of the United States of America in Congress assembled, That it shall be unlawful for any person, firm, corporation, or association, being a manufacturer of or wholesale or retail dealer in gold or silver jewelry or gold ware, silver goods or silverware, or for any officer, manager, director, or agent of such firm, corporation, or association to import or cause to be imported into or exported from the United States for the purpose of selling or disposing of the same, or to deposit or cause to be deposited in the United States mails for transmission thereby, or to deliver or cause to be delivered to any common carrier for transportation from one State, Territory, or possession of the United States, or from the District of Columbia, to any other State, Territory, or possession of the United States, or to said District, in interstate commerce, or to transport or cause to be transported from one State, Territory, or possession of the United States, or from the District of Columbia, to any other State, Territory, or possession of the United States, or to said District, in interstate commerce, any article of merchandise manufactured after the date when this act takes effect and made in whole or in part of gold or silver, or any alloy of either of said metals, and having stamped, branded, engraved, or printed thereon, or upon any tag, card, or label attached thereto, or upon any box, package, cover, or wrapper in which said article is incased or inclosed, any mark or word indicating or designed or intended to indicate that the gold or silver or alloy of either of said metals in such article is of a greater degree of fineness than the actual fineness or quality of such gold, silver, or alloy, according to the standards and subject to the qualifications set forth in Sections 2 and 3 of this act.

Section 2. That in the case of articles of merchandise made in whole or in part of gold or of any of its alloys so imported into or exported from the United States, or so deposited in the United States mails for transmission, or so delivered for transportation to any common carrier, or so transported or caused to be transported as specified in the first section of this act, the actual fineness of such gold or alloy shall not be less by more than one-half of one karat than the fineness indicated by the mark stamped, branded, engraved, or printed upon any part of such article, or upon any tag, card, or label attached thereto, or upon any box, package, cover, or wrapper in which such article is incased or inclosed; except that in the case of watch cases and flat ware, so made of gold or of any of its alloys, the actual fineness of such gold or alloy shall not be less by more than 3-1,000 parts than the fineness indicated by the mark stamped, branded, engraved or printed upon such article, or upon any tag, card, or label attached thereto, or upon any box, package, cover, or wrapper in which such article is incased or inclosed; *Provided*, That in any test for the ascertainment of the fineness of any article mentioned in this section, according to the foregoing standards, the part of the article taken for the test, analysis, or assay shall be such part or portion as does not contain or have attached thereto any solder or alloy of inferior fineness used for brazing or uniting the parts of said article; *Provided further*, That in the case of any article mentioned in this section, in addition to the foregoing tests and standards, the actual fineness of the entire quantity of gold or of its alloys contained in such article, including all solder and alloy of inferior fineness used for brazing or uniting the parts of such article (all such gold, alloys, and solder being assayed as one piece), shall not be less by more than one karat than the fineness indicated by the mark stamped, branded, engraved, or imprinted upon such article, or upon any tag, card, or label attached thereto, or upon any box, package, cover, or wrapper in which such article is incased or inclosed, it being intended that the standards of fineness and the tests or methods for ascertaining the same provided in this section for articles mentioned therein shall be concurrent and not alternative.

Section 3. That in the case of articles of merchandise made in whole or in part of silver or any of its alloys so imported into or exported from the United States, or so deposited in the United States mails for transmission, or so delivered for transportation to any common carrier, or so trans-

ported or caused to be transported as specified in the first section of this act, the actual fineness of the silver or alloy thereof of which such article is wholly or partly composed shall not be less by more than 4-1,000 parts than the actual fineness indicated by any mark (other than the word "sterling" or the word "coin") stamped, branded, engraved, or printed upon any part of such article, or upon any tag, card, or label attached thereto, or upon any box, package, cover, or wrapper in which such article is incased or inclosed; and that no such article or tag, card, or label attached thereto, or box, package, cover, or wrapper in which such article is incased or inclosed shall be marked, stamped, branded, engraved, or printed with the word "sterling" or "sterling silver" or any colorable imitation thereof, unless such article or parts thereof purporting to be silver contains 925-1,000 parts pure silver; and that no such article, tag, card, label, box, package, cover or wrapper shall be marked, stamped, branded, engraved, or printed with the words "coin" or "coin silver" or colorable imitation thereof unless such article or parts thereof purporting to be silver contains 900-1,000 parts pure silver; *Provided*, That in the case of all such articles whose fineness is indicated by the word "sterling" or the word "coin" there shall be allowed a divergence in the fineness of 1-1,000 parts from the foregoing standards; *Provided*, That in any test for the ascertainment of the fineness of any such article mentioned in this section according to the foregoing standards the part of the article taken for the test, analysis, or assay shall be such part or portion as does not contain or have attached thereto any solder or alloy of inferior fineness used for brazing or uniting the parts of such article; *Provided further*, That in the case of any article mentioned in this section, in addition to the foregoing tests and standards, the actual fineness of the entire quantity of silver or of its alloys contained in such article, including all solder and alloy of inferior fineness used for brazing or uniting the parts of such article (all such silver, alloys, and solder being assayed as one piece), shall not be less by more than 10-1,000 parts than the fineness indicated by the mark stamped, branded, engraved, or imprinted upon such article, or upon any tag, card, or label attached thereto, or upon any box, package, cover, or wrapper in which such article is incased or inclosed, it being intended that the standards of fineness and the tests or methods for ascertaining the same provided in this section for articles mentioned therein shall be concurrent and not alternative.

Section 4. That in the case of articles of merchandise made in whole or in part of an inferior metal, having deposited or plated thereon or brazed or otherwise affixed thereto a plating, covering, or sheet composed of gold or silver, or of an alloy of either of said metals, and known in the market as rolled gold plate, gold filled, silver plate, or gold or silver electroplate, or by any similar designation, so imported into or exported from the United States, or so deposited in the United States mails for transmission, or so delivered to any common carrier, or so transported or caused to be transported as specified in the first section of this act, no such article, nor any tag, card, or label attached thereto, nor any box, package, cover, or wrapper in which such article is incased or inclosed, shall be stamped, branded, engraved, or imprinted with any word or mark usually employed to indicate the fineness of gold, unless such word or mark be accompanied by other words plainly indicating that such article or part thereof is made of rolled gold plate, gold plate, or gold electroplate, or is gold filled, as the case may be, and no such article, nor any tag, card, or label attached thereto, nor any box, package, cover, or wrapper in which such article is incased or inclosed, shall be stamped, branded, engraved, or imprinted with the word "sterling" or the word "coin," either alone or in conjunction with other words or marks.

Section 5. That each and every person, firm, corporation, or association, being a manufacturer of or a wholesale or retail dealer in gold or silver jewelry, gold ware, silver goods, or silverware, who or which shall knowingly violate any of the provisions of this act, and every officer, manager, director, or managing agent of any such corporation or association having knowledge of such violation and directly participating in such violation or consenting thereto, shall be deemed guilty of a misdemeanor, and upon conviction thereof in any court of the United States having jurisdiction of crimes within the district in which such violation was committed or through which has been conducted the transportation of the article in respect

decide upon the form of the bill and arrange for concerted action with committees of jewelers in other sections.

The committee endorsed THE CIRCULAR-WEEKLY'S stamping act with some amendments that had been made to it, and invited committees from the New England Jewelers' and Silversmiths' Association and the Newark Jewelers' Association to act with it. Many conferences were held in New York, and Frank L. Crawford, who drew THE CIRCULAR-WEEKLY'S bill, appointed counsel for the joint committee. In this committee the bill was rejected and conferences were held between Mr. Vreeland and Mr. Crawford with the result that the bill, as it finally came from the hands of the joint committee, expressed the views of, and was accepted in, by every section of the jewelry trade.

The bill was introduced into the House by Mr. Vreeland, Jan. 31, and re-introduced on Feb. 12 last, it was immediately referred to the Committee on Interstate and Foreign Commerce which held a hearing on the bill, Feb. 9; at this hearing appeared Mr. Vreeland, Mr. Crawford, and committees from the associations in New York, Newark, New England, and after giving the matter careful consideration the House committee finally reported it to the House with unanimous approval.

With little delay, and at the first opportunity the bill came before the House of Representatives, and was passed April 16, without amendment, by a vote of 138 to 35; then went to the Senate and was referred to the Committee on Interstate Commerce of that body and was reported favorably by that committee, May 8, 1906, with two slight amendments, one reducing the penalty from \$1,000 fine and six months imprisonment to \$500 fine and three months imprisonment and the other extending the time in which the bill should go into effect from six months to one year after its passage. As soon as the rate bill had been disposed of in the Senate, the Stamping Bill was immediately considered and was finally passed and approved May 22, and returned to the House. The House concurred in the two slight amendments made and the bill was sent to the President and approved.

## THE COMMITTEE.

The joint committee of the jewelry trade which had charge of the bill consisted of: NEW YORK—A. K. Sloan, of Sloan & Co.; H. Bliss, of the Gorham Mfg. Co.; Oliver G. Isenden, of Hayden W. Wheeler & Co.; George E. Fahys, of Joseph Fahys & Co.; Francis R. Appleton, of Robbins & Appleton; F. H. Larter, of Larter & Son; Col. J. L. Shepherd, of the Keystone Watch Co. Co.; Leo Wormser, of the Julius King Co.; George W. Street, of Geo. O. Street & Sons, and T. Edgar Willson, editor of THE JEWELERS' CIRCULAR-WEEKLY. NEW ENGLAND—William A. Copeland, of Martin Copeland & Co.; Henry B. Thresher, of the Vite, Thresher Co., and G. K. Webster, of Webster & Co. NEWARK—Samuel Clark, of Day, Clark & Co.; Mr. Schuetz, of C. Schuetz & Sons; Mr. Angell, of Link & Angell Co., and Thomas W. Adams, of T. W. Adams & Co.

ADDISON W. WOODHULL, President.  
FRANK K. HUFF, Vice-President.

GILBERT T. WOODHULL, Treasurer.  
WILLIAM J. McQUILLIN, Secretary.

# MOUNT & WOODHULL,

IMPORTERS OF

**DIAMONDS,  
OTHER PRECIOUS STONES,  
PEARLS, ETC.**

MAKERS OF

**FINE  
DIAMOND  
JEWELRY.**

26 Maiden Lane,  
(Southwest Corner Nassau Street)

**NEW YORK.**

**PARIS ADDRESS:  
5 SQUARE DE L'OPERA.**

**BAGG, PERINE & CO.,**  
RARE SPECIMENS OF  
DIAMONDS AND OTHER  
PRECIOUS STONES,  
21 & 23 MAIDEN LANE, NEW YORK.  
Tel. No. 6226 Cortlandt.

**EMERALDS,  
DIAMONDS  
AND  
PEARLS.**

**RUBIES AND  
SAPPHIRES.**

**CABLE ADDRESS:  
MILBAGG.**

**Pearl Necklaces  
and Collarettes.**

**Mounted  
Diamond  
Jewelry**  
of every  
description.



**Large  
assortment  
of all kinds of  
very fine, fancy  
and rare gems,  
including Pearls,  
Diamonds, Rubies,  
Emeralds and Sapphires.**

182 & 184 BROADWAY  
NEW YORK

**Particularly Fancy  
Colored and Fancy  
Shaped Diamonds.**

to which such violation has been committed shall be punished by a fine, of not more than \$1000, or imprisonment for not more than six months, or both, at the discretion of the court. Whenever the offense is begun in one jurisdiction and completed in another it may be dealt with as if committed in either, and punishment may be imposed in either jurisdiction in the same manner, as if the offense had been actually and wholly committed therein.

Section 6. That the expression "article of merchandise" as used in this act shall signify goods, wares, works of art, commodity, or thing which may be lawfully kept or offered for sale.

Section 7. That all articles of merchandise which this act applies which shall have been imported into any State, Territory, District, or possession of the United States, and shall be therefor use, sale, or storage, shall, upon importation into such State, Territory, District, or possession, be subject to the operation of all laws of such State, Territory, District, or possession of the United States to the same extent and in the same manner as though such articles of merchandise had been produced in such State, Territory, District, or possession, and shall not be exempt therefrom by reason of being introduced therein in packages or otherwise.

Section 8. That this act shall take effect on the date of its passage.

LETTERS OF CONGRATULATION

NEW YORK, June 15, 1906

Editor THE JEWELERS' CIRCULAR-WEEKLY  
Manufacturers and dealers in jewelry goods in the jewelry trade are to be gratulated in that the National Stamping Bill has become a law, having received the signature of the President to the THE JEWELERS' CIRCULAR-WEEKLY is fully to be commended for the part taken in bringing about this most desirable enactment.

Yours respectfully,  
FREDK. H. LARTEK

President of the Jewelers Board of Trade

NEW YORK, June 18, 1906

Editor THE JEWELERS' CIRCULAR-WEEKLY

We are gratified to learn that the National Silver Stamping Bill, called the Land Bill, has become a law. We are aware of the valuable services which THE JEWELERS' CIRCULAR-WEEKLY has rendered in having this bill promoted. We believe the law to be a very desirable one, and the jewelry and sterling silver interests be very much benefited by its passage. We congratulate THE CIRCULAR-WEEKLY and take this opportunity of expressing our thorough appreciation of its able service in this work.

Very truly yours,  
GORHAM MANUFACTURING CO.  
H. A. Bly

NEW YORK, June 14, 1906

Editor THE JEWELERS' CIRCULAR-WEEKLY

We note with pleasure that President Roosevelt has signed the gold and silver stamping bill. This is a signal victory for THE JEWELERS' CIRCULAR-WEEKLY and those men who have fought so hard and earnestly for a standard of value, and to create a condition whereby honest merchants would be protected against unscrupulous competition in the manufacture and sale of gold goods. This is a most important move in the right direction.

Very truly yours,  
SOLIDARITY WATCH CASE CO.

PITTSBURG, Pa., June 16, 1906

Editor THE JEWELERS' CIRCULAR-WEEKLY

We congratulate you on the passage of the bill for the proper stamping of gold. It is the first valuable recognition the jewelry

... have ever received at the hands of the Government. It will certainly please the jewelry trade and place it on a higher plane than the question of manufacturing and merchandising. It will be a great assistance to the retail jewelry trade throughout the country. It marks an epoch in the history of the jewelry business, and the trade can thank THE JEWELERS' CIRCULAR-WEEKLY for bringing it to pass.

Very truly,  
 STEELE F. ROBERTS,  
 of E. P. Roberts & Sons.

New York, June 19, 1906.

FOR THE JEWELERS' CIRCULAR-WEEKLY: The good news that President Roosevelt signed the Gold and Silver Stamping bill undoubtedly give great pleasure to the trade who have supported the bill so ardently since the movement began. I want to express my appreciation of the work done by THE CIRCULAR-WEEKLY in this good cause, and congratulate you that your bill has finally found its way into the statute books.

Very truly yours,  
 LEO WORMSER

North Attleboro, Mass., June 16, 1906.

FOR THE JEWELERS' CIRCULAR-WEEKLY: It is a pleasure to express our pleasure and appreciation over the passage of the National Stamping Act, and to thank you for the work you have performed in connection with it.

The worst competition we have had to encounter has been the dishonest kind; the dealer that put out merchandise purporting to be 10 karat or 11 karat when it was only six or eight, or 10 or 12, and we naturally approve any measure that checks this.

Respectfully yours,  
 BUGBEE & NILES Co.

Pittsburg, Pa., June 16, 1906.

FOR THE JEWELERS' CIRCULAR-WEEKLY: The bill is admirable because, first, it imposes no hardship to the honest manufacturer, and, second, because it is a protection to all buyers of jewelry, silverware, etc. Accept our congratulations.

E. W. HILL,  
 of Goddard, Hill & Co.

June 16, 1906.

FOR THE JEWELERS' CIRCULAR-WEEKLY: We are very much gratified to hear that the President has signed the national law regarding the stamping of gold and silver articles.

Over 20 years ago Joseph Fahys, of our firm, went to Washington with other members of the trade and endeavored to secure legislation on this very subject, but his efforts were futile, and the reason was that such legislation did not fall within the scope of the Federal Government.

We feel that all manufacturers in our line of goods are to be congratulated that the Federal Government has seen the necessity of adopting laws to take care of matters of this nature which are of national importance, and cannot be successfully confined to State legislation.

Very truly yours,  
 JOSEPH FAHYS & Co.,  
 GEORGE E. FAHYS.

CONGRATULATIONS FROM PROVIDENCE.

A number of Providence jewelers were heard to comment most favorably on the bill and the activity and keen interest which THE CIRCULAR-WEEKLY has shown in pushing it forward.

President William A. Copeland, of the New England Manufacturing Jewelers' and Silversmiths' Association, said: "The jewelers are certainly to be congratulated that they had such good friends in their effort to get this bill. We naturally feel here in Providence as if we had helped all we could and had something to do with the final framing of the bill. It is a good measure and THE CIRCULAR-WEEKLY is to be congratulated on the support it has given it. I have caused to be written a letter of thanks in behalf of the association to Congressmen Vreeland, of New York; Aldrich and Wetmore, of Rhode Island, for the interest they have taken in pushing the bill."

Former President Henry G. Thresher said: "There is every reason to feel extremely good over the passage of this bill. THE CIRCULAR-WEEKLY and all others who have helped in getting it through are deserving of the thanks of the jewelers throughout the country who are interested in seeing such a law on the statute books. Congressman Vreeland did some good work on this bill and so did Senator Aldrich, and the almost record-breaking way in which it went through without a hitch, shows what powerful influences were back of the bill."

COMMENTS BY BOSTON JEWELERS.

"The stamping bill just signed by the President is certainly a good thing, both for the protection of the dealer who wishes to sell reliable goods and of the public, who should receive nothing but reliable goods in return for their money. THE CIRCULAR-WEEKLY should be congratulated and its efforts very much appreciated by both the dealers and the public. I wish we could get more good laws passed for the protection of the public."—J. C. Sawyer.

"There can be but one sentiment among all jewelers who want to sell honest goods, and that is, to heartily endorse a bill that favors keeping up the standard of quality, and to appreciate the interest shown in the matter by THE CIRCULAR-WEEKLY."—C. W. Davidson, of Thomas Long Co.

"The passage of this bill is one of the best things that ever happened for the jewelry business. It will drive out lots of the unscrupulous manufacturers who make and sell spurious goods. It secures universal conformity in this country to recognized standards, and should compel the manufacturer to keep his goods up to the quality that he represents them to be. THE CIRCULAR-WEEKLY has done good work in urging the adoption of this measure."—Carl D. Smith, of Smith, Patterson Co., 52 Summer St.

"All jewelers of high standing and honest intentions throughout the country have been in favor of the bill, and acknowledge the value of the efforts of THE CIRCULAR-WEEKLY. A special feature with us is the furnishing of prize and presentation silverware, medals and such goods. We have encountered competition which could only be successful by means of estimates based upon the furnishing of goods of inferior quality. The stamping law should put an end to that sort of business, and we welcome it most heartily."—Fred M. Wood, of N. G. Wood & Sons, 128 Tremont St.

"The law is an excellent one, and THE CIRCULAR-WEEKLY deserves credit for its part in securing the passage of such a good bill. I believe that goods should be stamped with their quality, and I would also like to have manufacturers compelled to stamp their trade-mark or some mark that would identify the maker upon their products."—George E. Homer.

Jewelers' Gold Bars Withdrawn and Exchanged at New York.

Week Ended June 16, 1906.

The U. S. Assay Office reports:  
 Gold bars exchanged for gold coin.....\$424,043.81  
 Gold bars paid depositors..... 88,837.11

Total .....\$512,880.92  
 Of this the gold bars exchanged for gold coin are reported as follows:

June 11.....	\$109,041.72
" 12.....	123,058.81
" 13.....	71,855.69
" 14.....	62,370.45
" 15.....	32,420.91
" 16.....	25,796.32

Total .....\$424,043.81

Death of Max J. Lissauer.

The trade in New York was shocked yesterday to hear that Max J. Lissauer, head of the firm of Lissauer & Co., one of the most prominent wholesale jewelers in the trade, had died suddenly at Amsterdam, Monday, whether he had gone, accompanied by his wife, a short time before. Word of Mr. Lissauer's death was received at the office of his firm, 12 Maiden Lane, in a cablegram from Mrs. Lissauer Monday morning. No details were given except that Mr. Lissauer had been in the best of health up until his death. Deceased sailed for Europe from this country on May 30, and had just finished making purchases of diamonds in the diamond markets when he was gathered in by the Grim Reaper.

Few men in the entire jewelry trade were better known or more generally liked, hon-



THE LATE MAX J. LISSAUER.

ored and respected than was Max J. Lissauer. He was a native of Wurtemberg, Germany, having been born in the city of Stuttgart, Oct. 21, 1841. He learned the jewelry trade in the town of his birth, and came to this country in 1860, settling in New York, and entered the jewelry trade here with a watchmaker in 86th St.

In 1866 he formed the firm of Lissauer & Co., which was later succeeded by the firm of Lissauer & Sondheim, and soon began to build up a large and extensive business as jobbers in watches and jewelry and importers of diamonds. To this firm Samuel Joel was subsequently admitted, and the style continued until 1892, when the partnership dissolved and was succeeded by Lissauer & Co., composed of the deceased and his nephew, Max Kallman. Later another nephew, Macel M. Mirabeau, was taken into the concern, the firm being composed of these three at the time of Mr. Lissauer's death.

Mr. Lissauer was president of the Jewelers Relief Association, a director of the Jewelers Board of Trade, vice-president of the Jewelers League and chairman of the executive committee of that organization, ex-president of the Verein Freundschaft and the chairman of the jewelers' committee of the recent Russian Relief Association, a director in the Hudson County Realty Co. and of the Columbia Bank, and in addition was prominently identified with many charitable organizations.

Mr. Lissauer is survived by his widow, a

# EICHBERG & CO.,

IMPORTERS AND CUTTERS OF

## DIAMONDS,

65 NASSAU STREET, (Prescott Building.) NEW YORK.

# STERN BROS. & CO.,

IMPORTERS AND CUTTERS OF

## DIAMONDS,

CUTTING WORKS: 68 Nassau St., NEW YORK.  
138-142 West 14th St., N. Y.  
CHICAGO, LONDON,  
103 State St. 29 Ely Place.

WITH the growing scarcity of fine Sapphires and the increased demand, the upward tendency of prices will continue, emphasizing the necessity of constant watchfulness, accurate knowledge of values, and quick action to secure advantageous bargains, and also demonstrating the necessity of a "GEMFINDER" on the spot to care for the interests of American buyers.

FREDERICK A. JEANNE,  
"Gemfinder,"  
5, Square de l'Opéra. PARIS, FRANCE.

London: Chancery Lane Safe Deposits. New York: Maiden Lane Safe Deposit Co.

## A. ROSEMAN, 9-11-13 Maiden Lane, New York

IMPORTER OF

# DIAMONDS

Maker of Diamond Jewelry



Established 1872

HEADQUARTERS FOR

# AMERICAN WATCHES

IMPORTERS

## DIAMONDS

CUTTERS

# Jacob Strauss & Sons

14 MAIDEN LANE

NEW YORK

## LEO GOLDSMITH, IMPORTER OF DIAMONDS

TELEPHONE: 4115 CORTLAND.

and Precious Stones. Headquarters for Reconstructed Rubies and Sapphires. All sizes and forms.

9-13 MAIDEN LANE,

NEW YORK.

daughter (the wife of Dr. L. M. A... and a grandson. No definite arrangements for the funeral have yet been made.

A full sketch of the career of Mr. ... sauer will appear in the next issue of CIRCULAR-WEEKLY.

### Gold and Silver Stamping Bill Considered by Canadian Parliament.

OTTAWA, June 14.—In the Banking and Commerce Committee of the Senate a bill was considered respecting the sale and manufacture of gold and silver. It provides that gold, silver and plated ware shall be of the quality indicated by the marks on them. A manufacturer may make gold, silver and plate without marks, but if a mark is put on, it must be the name or trade mark, a date mark and a quality mark as prescribed by the act. Articles of less than 10 karat shall not be sold as gold. The word "sterling" shall mean .925 pure silver.

In the case of gold-filled, rolled plate or silver, the actual fineness and weight of the gold and silver in or on the article shall be indicated on the box or article. Imported goods have to correspond to their marks. A maximum penalty of \$100 is provided for each article improperly marked.

W. K. McNaught, of the American Watch Case Co., who appeared for the jewelry section of the Canadian Manufacturers' Association and the Canadian jewelry manufacturing trade in general, said that the present great fraud was practised by manufacturers marking 10-karat gold, 14-karat gold, or 16-karat gold, and marking such articles as sterling, when they were below those grades, and guaranteeing plated goods to wear 10, 15 or 20 years which would not wear anything like the time specified. He explained that the bill was for the protection of the public.

This bill, which is held for further consideration, is the result of a combined effort on the part of Canadian manufacturers put an end to a condition of things which has reflected disgrace on the trade. Jewelers belonging to the Canadian Manufacturers' Association met some months ago at the Windsor Hotel in Montreal and agreed upon the present action.

Arrangements have been completed for the 27th annual outing of the New England Manufacturing Jewelers' & Silversmiths' Association Friday of this week. At 10 o'clock the members and guests will assemble at Free Masons' Hall, Providence, R. I., and at 11:30 the line will be formed and will proceed, headed by Reeves' American Band, over a brief line of march to the steamer which will then be boarded and the company will proceed to Field's Point, where a shore dinner will be served. At 2:15 the boat will leave for a sail down the coast. A baseball game between nines, representing Attleboro and Providence, will be played at some suitable spot "down the river" and at 5 o'clock the party will again board the boat for a continuation of the outing. Lunch will be served during this trip. At 7 o'clock the party expects to be in Providence. The Executive Committee, consisting of Frank B. Reynolds, Chairman, M. Robbins and Harry Cutler, are in charge of the affair, assisted by the officers.



### Trade Conditions in San Francisco Improving Daily—Many Firms to Resume Business on Van Ness Ave.

SAN FRANCISCO, Cal., June 13.—The situation in San Francisco is improving every day. The amount of work now going on is almost past belief, although, of course, much of it is of a temporary character. Today you may see lines of wagons holding debris from a lot, the next day any of carpenters are busy, and if you come back in a week's time you may see a wooden building with an up-to-date store front and a full stock of goods for inside. The steam railways are now hauling debris out of the city as fast as insurance companies will allow the lots to be cleared.

Plans for dozens of large structures are being drawn, and in some cases actual construction work has been commenced. For a time the outlook seemed dubious, but now that minds have become concentrated on business affairs once more, every one is forging ahead with a better feeling. The retail jewelry trade a great amount of business is not being done, because people are not buying much in that line just now and tourists are not numerous.

One of the great drawbacks to the local rail trade is the lack of hotels here now. Thousands of sightseers throng the streets each day, but as their stay is limited, owing to the utter lack of accommodations here, they make no pretense of shopping, as they would were time no object to them. The new retail center now located on Fillmore St. promises to be supplanted to a great degree within the next month by the new Van Ness Ave. section, which is rapidly being built up. Here are to be had many of the advantages that Fillmore St. lacks. It is nearer the old business district by many blocks, is a beautiful wide street with handsome residences on one side and the ground on the other, so that stores may be put up to suit tenants and not have to be altered from old buildings.

Shreve & Co. have decided to locate in the Van Ness Ave. district pending the pairing of their building at Grant Ave. and Post St., and have secured a three years' lease on a lot at Van Ness Ave. and Sacramento St., adjoining the ruined mansion of Claus Spreckles. A handsome one-story building will be erected there as soon as possible.

Hammersmith & Field will locate at the corner of Van Ness Aves., and carpenters are now at work on the store, which is expected to be open Wednesday, June 20.

The Bohm-Bristol Co. has secured a lot on Van Ness Ave., just across from Shreve & Co., and expects to be located there within two months. The Baldwin Jewelry Co. has also decided to locate on Van Ness Ave. until the downtown section is ready for retail trade again, and has secured a site for a store near the corner of Sutter St. The Berteling Optician Co. will locate on Bush St., near Van Ness Ave., and install a complete plant.

Market St., however, is not being entirely neglected in the rush of resuming business. T. Lundy is putting up a store at its old location on Market St., near Grant Ave. Adjoining this will be the new store of the L. E. Waterman Co., whose hand-me home at 18 Geary St. was destroyed

shortly after being newly fitted up. Across the street from here the J. A. Sorensen Co., for many years located on 6th St., near Mission St., will occupy a store in the Kamm building.

### Woman Employed in Buffalo Jewelry Store Arrested and Charged With Many Thefts.

BUFFALO, N. Y., June 16.—By the arrest of Mrs. Carrie Schlenker, saleswoman in the retail department of the Freeman Jewelry Co., 84 Seneca St., Manager Pickert claims to have ended a systematic and baffling scheme of robbery. Mrs. Schlenker's arrest occurred on Monday, and yesterday she was held to await the action of the Erie County Grand Jury on a charge of grand larceny, first degree. Manager Pickert says the woman has taken in cash and jewelry, principally watches, a total of something more than \$1,200.

Mrs. Schlenker is about 42 years of age. She came to Buffalo from Batavia, in which place she was implicated in a forgery case, but the evidence was insufficient to warrant her arrest. She had been employed in the Freeman Jewelry Co.'s store here more than a year.

Watches and money had been disappearing most mysteriously. Mr. Pickert made up the cash deficit in the money drawers. Even then the cash would be short at the close of business every day. On the day of the arrest Mrs. Schlenker left the store ostensibly on an errand. Mr. Pickert had missed a watch that day, and had strongly commented on the fact. He therefore followed Mrs. Schlenker. She entered the Forster pawnshop, at Seneca and Washington Sts. Mr. Pickert, after a few minutes, followed her and saw her redeem a watch. Mrs. Schlenker arrived at the store just ahead of the manager, but not in time to replace the watch in the show case. Mr. Pickert said nothing about the watch, but sent her on an errand. In her absence he searched her coat and found, he says, 38 pawn tickets for watches and other jewelry.

In the meantime the police had been notified. Mr. Pickert and a detective followed Mrs. Schlenker, found her on the street and confronted her, demanding the watch she had redeemed from the pawnshop. She denied having it at first, but finally took the watch from the bosom of her dress and admitted the theft. She was then locked up.

The prisoner's plea is insanity. She declares she has not been right in her mind for a long time.

### Two Clever Women Thieves Visit Jewelers of Alton, Ill.

ST. LOUIS, Mo., June 14.—J. H. Booth and Joseph Bauer, retail jewelers of Alton, Ill., reported to the police here that they were robbed of six diamond rings by two women, who worked a confidence game. Two of the rings came from Mr. Bauer's store and four from Mr. Booth's. Mrs. Annie Lohr, a young woman, living on Missouri Ave., near Collinsville Ave., in East St. Louis, Ill., was arrested by detectives Hurley and Nevills of the East St. Louis police department as a suspect.

One of the women was large and well dressed; the other, a blonde, was smaller and not so well dressed. They asked to see diamond rings, also other articles to

get which the clerk would have to turn his back. The large woman carried a handkerchief, with which she managed to cover up some of the jewelry that was spread before her, and when Bauer picked up the handkerchief four rings fell from it, but he failed to recover two others. The women pursued the same tactics at Mr. Booth's store, and also tried to get other diamond rings from C. L. Goulding, but failed because they aroused suspicion.

Mrs. Lohr was arrested on the streets of East St. Louis. She had two valuable diamond rings on her fingers and in her possession were also found pawn tickets for earrings, a watch, a brooch and several rings. She denies the charge, declaring that her husband, who is now in the Louisiana State Penitentiary, gave her diamonds and jewelry. The jewelry was identified by the jewelers and the woman was held.

### Son of Philadelphia Jeweler, Kidnapped a Week Ago, Rescued by Police.

PHILADELPHIA, Pa., June 18.—The most sensational case of kidnapping in which any jeweler in the trade has ever been involved was solved to-day when Freddie Muth, the seven-year-old son of Charles Muth, was restored to his father in the office of Mayor Weaver, and the kidnapper, the first to risk a life sentence in this State, was also brought before the Mayor and finally committed to jail.

While the public and trade wondered and became skeptical the detectives, always sure their man had not left town, waited their opportunity to seize their criminal prey. This opportunity came to-day. The boy and the man who kidnapped him were found in a newly built but yet unoccupied house at 63d and Vine Sts. The little lad was asleep, making a pillow of the school books which he had with him when the man took him from his school under pretense of taking him to his mother, whom he said had been seriously injured. All sorts of clues were followed out, and though the detectives were assured that they had the right man, they were careful to mislead the public and the newspapers as far as possible that the suspect might not make his escape. It was known that the man's first intention was to kidnap the child for a handsome ransom, and much anonymous correspondence passed between him and the officials and members of the Muth family.

The man arrested is John Joseph Keane, a former well known real estate agent and broker, but now in a position of little consequence in connection with a West Philadelphia building operation. He had hidden the Muth lad in one of the untenanted houses in an operation of which he had charge. When trapped he attempted an escape, which was cut off by a show of weapons. The boy was found safe and sound. The prisoner is a married man with three children, which fact makes his crime all the more incomprehensible. In the week in which the Muth child has been away his mother has been bordering on the verge of nervous prostration.

Mr. Muth has occupied the store at 1632 Columbia Ave. for about seven years. He has been widely known and much esteemed in the local trade for more than 10 years. His Columbia Ave. store is one of the hand-somest and finest in that section of the city.

SEND TO US ANY QUANTITY OF

# AMERICAN PEARLS

WE BUY FOR CASH.

Send by registered mail or express; we will make an offer  
by return mail. We will also buy any quantity of

**BAROQUE PEARLS (SLUGS).**

## BUNDE & UPMAYER CO.,

Mack Block,

MILWAUKEE, WIS.



### A STRING PEARL SPECIAL

EXTRA QUALITY

\$3.60 Per Dozen Strings Net

Selection package sent on request.

## CHOPARD FRÈRES

MAKERS OF ART JEWELRY NOVELTIES.

49 Maiden Lane - - - NEW YORK

FACTORY: 35 Rue Des Trois Bornes, PARIS, FRANCE.

London, E. C., Holborn Viaduct 17.  
G. MARCUS.

ESTABLISHED 1860.  
L. O. LEVISON.

Amsterdam, Tulpstraat 2.  
ALEX. FELDENHEIMER.

# CALIFORNIA JEWELRY COMPANY

IMPORTERS OF

## DIAMONDS and PRECIOUS STONES

SAN FRANCISCO, Temporary Office, Oakland, Delger Building

YOUR MEMO, ORDERS ARE SOLICITED

NEW YORK, 41 Maiden Lane

**Conrad Schickerling Arrested on Complaint of Gustave Edelhoff—Indignant at the Charge.**

Conrad Schickerling, who was president Schickerling Bros. & Co., bankrupt jewelry manufacturers at 28 W. 22d St., New York, was placed under arrest on Thursday last week on a warrant obtained by Gustave A. Edelhoff, the president of Edelhoff Bros. & Co., who were retailers at 574 Fifth Ave., and who, also, are in bankruptcy. The warrant charged that the defendant counted a quantity of diamonds, valued at a little more than \$6,000, that were entrusted him on memorandum.

It is learned that the proceedings were instituted in a convenient manner to bring before the court several disputed matters which have grown out of the failures of the two corporations. The expectation is that Mr. Schickerling is held for the Grand Jury when the prosecution will present to the body testimony in relation to other charges of a somewhat similar character.

It will be recalled that when the Edelhoff corporation failed charges were made that Schickerling was responsible for the embarrassment. It was said that he had organized the corporation, and had used it as a dummy to obtain stock and credit, which he could no longer obtain on the credit of Schickerling Bros. & Co., who were then insolvent. When the Edelhoff directors met, Abe Gruber, as counsel for the officers of that corporation, made a statement in their behalf which reflected seriously on Mr. Schickerling. The lawyer said that the Edelhoff brothers were boys, who had been led into the business without experience, relying entirely upon Mr. Schickerling, who was their father's friend. According to the story, as then told, the organization of the Edelhoff corporation was a sham from the beginning. Mr. Schickerling, it was said, ostensibly put in \$8,000 in merchandise for the company's stock, but immediately took away the merchandise, substituting notes for it. Thereafter it was said he induced the Edelhoffs to go down to the Maiden Lane district and buy diamonds and other stock, which he was to make up into jewelry. For some of this jewelry, it is said, he said that orders had already been received and other jewelry was to be made for the retail store. Instead of filling orders and stocking the store, it was asserted that a large quantity of the diamonds were taken to the pawnshops by Mr. Schickerling, who in this way raised cash, which he put to his own immediate uses.

The charge in the present case is based on one of these transactions. Edelhoff, in his affidavit, says that on Jan. 24, 1906, his firm received a memorandum order from Schickerling saying that he would like to have diamonds purchased for him to fill an order for a lorgnette chain given him by Oscar L. Richards, president of the State Bank. He wished to see if he could match what diamonds he had already.

Edelhoff affirms that he went to Henry C. Oppenheimer, 3 Maiden Lane, and obtained 19 diamonds of about 19 carats weight, valued at \$175 each, and 20 diamonds of about 19 carats weight, valued at \$147 each, and delivered them to Schickerling.

When he demanded the return of the diamonds or payment for them, he says he was delayed until Feb. 7, when Schickerling confessed that he had pawned them at William Simpson's pawnshop, 155 Bowery. The tickets for the pawned gems were handed over to Edelhoff in Lawyer Abe Gruber's office, on Feb. 19. Then, the complainant alleges, he had to borrow \$6,732 from his father, part of which he used in redeeming the diamonds, upon which Schickerling had realized \$1,000.

After Mr. Schickerling was brought into the Tombs Police Court last Thursday he gave bail for \$3,000, and his examination was set for Friday of this week. Mr. Schickerling has frequently denied all the charges against him as far as they involved any criminal conduct. In the case of the Oppenheimer diamonds he denies that the transaction was of a memorandum character. According to his statement the diamonds were sold to him the same as other stock. Mr. Schickerling adds that he turned over two-thirds of the money obtained from the pawnbroker to the Edelhoffs for use in their business, retaining one-third for use in his own business.

It is claimed by Mr. Schickerling that the Edelhoffs were all of the time cognizant of what was going on in the business, and that he did not mislead them in any respect. He says that they hold pawn tickets for \$36,000 as security for the \$6,000 paid in redeeming the Oppenheimer diamonds. If they will return the pawn tickets held as security, he says, it will be easy enough for him to refund the \$6,000. His friends say that an effort is being made to use him as the scapegoat.

Mr. Schickerling says that he has acknowledged the Edelhoffs in writing to show that he personally bought much jewelry from them, paying partly in cash and partly with his personal notes. He says that such evidence will refute the charge that these transactions were of a memorandum character. He adds that to the extent of his ability he will meet these personal notes as they fall due, and if he cannot pay them on maturity he intends to pay them all in time.

Leonard Bronner represents Mr. Schickerling. The Edelhoffs are represented by Col. Gruber and C. A. McKenzie, the latter being counsel for the receiver of Edelhoff Bros. & Co. It is expected that the proceedings in court will throw considerable light on the affairs of the two corporations, which have been so interwoven that the exact nature of some of the transactions has not yet become fully understood.

In the daily papers the reports of the arrest of Mr. Schickerling were given an exaggerated turn. It was said that the case had something to do with that of the two officers of the Klein Bros. Co., who recently pleaded guilty of grand larceny. The attorneys in both cases say that there is no connection of one with the other. Many other statements in the daily papers are also said to be absolutely without any foundation in fact.

Edward Clouser, for many years in the employ of J. W. H. Mortimer, Pottsville, Pa., died recently, aged 48 years. He is survived by his widow and four children.

**C. P. Goldsmith & Co. Win Suit Against Hammel, Riglander & Co.—Appeal to be Taken.**

The case of C. P. Goldsmith & Co. against Hammel, Riglander & Co., an action for an alleged breach of contract, was tried before Justice Dowling and a jury in the Supreme Court, last Friday, and a verdict of \$1,688 was awarded to the plaintiff. The testimony indicated that in May, 1904, the defendants ordered a quantity of manufactured articles from the plaintiffs. A part of the order was thereafter delivered and was returned by the defendants on the ground that the gold plating of articles was not up to the guarantee. It was claimed that the plaintiffs had agreed that the goods should be "14 karat filled, acid-proof stock."

The plaintiffs denied that such a representation of quality had been made, but set forth that in fact the articles were plated with 14 karat gold, and could stand any reasonable acid test that should be applied to articles of that character.

At the trial some of the articles in controversy and others were actually tested before the jury. The issue seemed to turn on the character of the test. The plaintiffs claimed that plated ware of this character should not be submitted to the test of chemically pure nitric acid. It was claimed that so severe a test, especially if the articles were allowed to remain a considerable time in the acid, would not give a satisfactory result, and that in fact the acid would eat through the plating and reach the filling. According to the usage of the trade, the plaintiff claimed articles of this kind, selling at 12 cents each, are subject only to milder acid tests which they would meet satisfactorily.

The jury agreed with the plaintiff, awarding a verdict for the full amount of damages claimed for the breach of contract. Afterward the defendants served notices of an intention to appeal. Wm. Victor Goldberg represented the plaintiffs as attorney. Einstein, Townsend & Guiterman appeared for the defendants.

**Nels Frandsen Asks to be Declared a Voluntary Bankrupt.**

OMAHA, Nebr., June 16.—Nels F. Frandsen, a jeweler at 109 S. 16th St., has filed a voluntary petition in bankruptcy in the United States Court. He states that he owes \$8,439.01 and has property amounting to only \$9,105, including that which is exempt.

Mr. Frandsen originally started in business in 1899, and later formed the firm of Frandsen & Abel. The partnership was later dissolved, and he succeeded to the business, continuing it alone until the early part of the year, when he admitted as a partner Edward J. Andersen, who had been with him for some years as clerk, the style becoming Frandsen & Andersen. He has been prominent in the trade, well regarded and was believed to have a capital of about \$5,000.

Thieves recently broke into the store of Lee Thompson, Andrews, Ind., and stole \$200 worth of jewelry. The safe, which contained a large amount of valuable stock, was not molested.

# BRAZILIAN EMERALDS

GREEN TOURMALINES ARE SOMETIMES KNOWN AS BRAZILIAN EMERALDS. THE COLORS SHADE FROM A LIGHT APPLE GREEN TO A DARK BLUISH BOTTLE GREEN. WE HAVE A GOOD STOCK OF THE ROUGH WHICH WE ARE CUTTING IN VARIOUS SIZES AND SHAPES.

## BUY FROM THE CUTTERS

### AMERICAN GEM & PEARL CO.

14 & 16 Church St., NEW YORK

LONDON: 16 Holborn Viaduct

PARIS: 39 Rue de Chateaudun

## FROM MINES TO MARKET

# MONTANA SAPPHIRES

## IN FANCY COLORS

PERHAPS no finer or larger assortment of these Stones has ever before been shown. We are prepared to furnish you with a selection at once, and solicit your order on memorandum.

### UNIQUE STONES ARE OUR SPECIALTY.

Send for our new booklet containing a list of over 100 precious stones, their distinguishing features and colors, also articles on "THE INFLUENCE OF GEMS ON CERTAIN DAYS" and "THE SIGNIFICANCE OF GEMS," a handy book of reference that will assist you in selling.

**The PASSMORE GEM CO.,** 373 WASHINGTON ST., BOSTON, MASS.

**SOHN and HYMAN**  
IMPORTERS OF PRECIOUS AND IMITATION STONES  
Crystals Engraved and Painted from Photo. Crests and Coats of Arms Engraved. Stone Seal Engravers and Incrusters. Lapidary Work a Speciality.  
**JOBGING STONES A SPECIALTY**  
47 and 49 Maiden Lane, NEW YORK

Cutters of  
DIAMONDS

THE BOSTON DIAMOND HOUSE

## JOHN B. HUMPHREY CO.

387 Washington St., Boston, Mass.

We are receiving Monthly Shipments of Diamonds from our Brazilian Mines, which are on exhibition at our Boston Office.

Cutters of  
DIAMOND

## New Stores and Enterpris.

Emil Walters is a new jeweler in Wood, Wis.

W. E. Hotchkiss has opened a store in Canton, S. Dak.

James Medley recently started in business in Wausau, Wis.

A. S. T. Mahnberg has begun business in Chicago City, Minn.

J. A. Robinson is now engaged in business in Lyndon, Kans.

Henry Birkestrand will shortly engage in business in Huxley, Ia.

J. Walker commenced business in Leavenworth, Kans., a short time ago.

Fincher & Osment will shortly open a tail jewelry store on Greensboro Ave., Caloosa, Ala.

A. J. Calkin, Ione, Ore., has moved to Lexington, where he has secured room and will open a store very soon.

A. U. Schleudecker & Son are new jewelers in Erie, Pa., where they have opened a store at 1027 State St.

Chas. V. Keeling and Chas. Allen recently started a wholesale jewelry business in Montreal, under the name of C. A. Reardon.

Martin & Co. have opened an attractive furnished store at 211 Main St., Evansville, Ind. Sol Martin, Jr., is the manager of the concern.

R. F. Newman has leased one of Mr. Stewart's buildings at North Yale Wash., and intends opening a jewelry store at that place.

The Cousins-Carroll Jewelry Co. is the name of a new concern which recently began business in Bessemer, Ala. The incorporators were: J. M. Cousins, Mrs. A. J. Cousins, and A. S. Carroll, Jr.

The Larney-Barr Jewelry Co. is a new concern which was incorporated last year in Camden, N. J., to deal in jewelry, clocks, watches, etc., with a capital of \$75,000. The incorporators were: A. Larney, E. C. Barr, and H. A. Davis.

The Logan-Shipley Silver & Clock Co. has been incorporated, with a capital of \$15,000, fully paid, to manufacture and sell clocks, silverware and novelties. Logan and R. P. Shipley have 65 shares each, and J. C. McCoy 20 shares. The store is located in the Star building, 12th and Olive Sts., St. Louis, Mo.

## Columbus, O.

D. S. Miller and his bride will return to New York, Philadelphia and other points in the east.

R. N. Whitford, of the Hofman Jewelry Co., has returned from Los Angeles, where he went to inspect claims of so-called precious stones. The firm acquired during his stay there, and he brings encouraging reports as to its possibilities.

Jesse E. North and Miss Flora Braum, daughter of Leo Braun, a jeweler in Springfield, O., were married in Columbus, June 12. There was no objection to the match, but the young people disliked the idea of a formal wedding and came to Columbus and were married without notifying any of their friends, until the event was over.

**The Diamond Markets.**

BRIDGEPORT, June 7.—The month of May closed without any change in the business situation. The diamond trade is quiet, except for mellee, which are in good demand, prices of which are continually rising. Foreign buyers who have been here have been particularly desirous of obtaining very small brilliants of good quality, especially small roses. There is no demand for faces or brown roses. Rough goods and small brilliants and mellee are not much in demand. Several rough series of Western, Kimberley, Jagersfontein and Bulwer were bought in London by our large manufacturers.

The following foreign buyers have been active during the past fortnight: Messrs. Adler, Jacobson, Oppenheimer, Lieberman, New York; Messrs. Gross, Weinman, Metzka, Steiner, Vienna; Mr. Martino, Naples; Messrs. Splyer, Slabotzky, Curjel, B. Rapoport, D. Van Praag, Weissberg, André Levie, Lambert, Gounet, Paris; Messrs. Stodt, Kroll, Elfeld, Messrs. H. Strauss, Vichman, London; Mr. Benhaim, Constantinople; Messrs. L. Van Moppes, Mendelsohn, Khorst, Kauffmann, London; Mr. Zipf, Lemberg; Mr. de Botton, Salonique; Mr. Oakley, Birmingham; Mr. Myers, Boston; Mr. Bianowici, Czernowitz.

BRIDGEPORT, June 6.—The end of May has shown activity in the precious stone trade, and business has been done especially with diamonds. Large lots of brilliants and pearls have been sold to firms of Barcelona and Madrid. The marriage of the King of Spain has been the cause of the activity in the jewelry trade there.

Roses have not been very much in demand during this fortnight, but June is generally a good month for their sale, and merchants hope that this year will not mark the rule. Very small roses of 300 to 400 pieces per carat are in demand, for which about 100 francs per carat is paid. Several lots of mixed roses of 100 to 150 pieces per carat were also sold.

The following firms have been declared bankrupt: J. O. Ohanian, a pearl merchant, living at 45 Rue Laffitte, and André Stabe, 53 Galerie, Montpensier, at the Palais Royal.

The marriage is announced of Mr. Aron, a diamond merchant, to Miss Davis, of London.

A new firm has been established here under the style of Marquand & César, 12 Rue Lafayette, with a capital of 140,000 francs.

AMSTERDAM, June 7.—The presence of several American buyers brought activity to the market at the end of the last month. The goods chiefly sold consisted of mellee of two, three and four stones per carat. Several lots were sold to firms of London. Representatives of the following American buyers have been here: S. Lindenborn, Klijn, Frank & Shire, Zimmern, Rees & C. L. & M. Kahn & Co., Fox, Bros. & Co., Tomar, Goldsmith & Co., Laubheim & Co., William I. Rosenfeld, Oppenheim & Stuss, Levey Bros. Among the European buyers were: Y. B. Kaufmann, London; Mr. Oakley, Birmingham; Messrs.

Lambert Freres & Co., L. Prager and A. & E. Worms, Paris.

The firm of Peter Abas & Co. has changed its style to Abas & Furth.

Series of rough are bought at London now to a great extent, but the competition is always brisk. For a single lot there are often 25 buyers. Mr. Ehrman, of the firm of Ehrman & Balshen, is now the London agent of the Premier Mine Co. Max Friedlander, who was the agent of the company since its foundation, has left the concern, but the reason is not known.

**Death of Chas. Rubens.**

Word was received in New York Monday of the death at Paris, France, about June 1, of Charles Rubens, who was for many years engaged in the Swiss watch importing business at New York.

Mr. Rubens was 87 years old at the time of his death. When he came to New York

**Medal and Silverware Presented to Baron Rosen Upon His Visit to Bridgeport, Conn.**

BRIDGEPORT, Conn., June 16.—One of the most pleasant features of the visit of Baron Rosen, the Russian Ambassador, to this city, last week, was the presentation of a number of souvenirs which were made in the factories of this city. One of the most conspicuous of these was the medal, in silver, which was given during the dinner tendered by the Board of Trade Friday night. This medal, which was from a special design, was two inches in diameter and was designed and made by the E. H. H. Smith Silver Co. It was intended to be emblematic of the diversified industries of this city.

On the obverse, in the center, was a facsimile of the seal of the city, and surrounding this upon a raised ribbon were the words "Seal of Board of Trade, 1876,"



OBVERSE AND REVERSE OF MEDAL PRESENTED TO BARON ROSEN.

as a young man he engaged in the watch business, and was one of the first to import Swiss watches for the trade in this country. He built up a large and prosperous business, which in the early 60s was at its height. He was at that time one of the largest watch importers in New York, having his offices at 21 Maiden Lane. In the early 80s, after a successful career of a quarter of a century in New York, he decided to retire, having accumulated a sufficient fortune on which to take things easy for the remainder of his life. He went to Paris, where he had since resided. About four years ago Mr. Rubens was bereft of his wife.

Many old members of the trade will recall Mr. Rubens as a man of amiable disposition, a sturdy friend and a straightforward merchant. He was held in the highest esteem in the trade during all the years of his active business life, and in his retirement enjoyed the continued friendship of his old associates.

**Market Price of Silver Bars.**

The following are the quotations of silver bars in London and New York, as reported by Zimmerman & Forshay:

	New York.	London.
June 12.....	\$.64 3/4	29 13-16d.
" 13.....	.64 1/4	29 7-8d.
" 14.....	.64 1/4	29 11-16d.
" 15.....	.64 1/4	29 9-16d.
" 16.....	.65 1/4	30 1-8d.
" 18.....	.65 3/4	30 1-4d.

Bridgeport, Conn." Surrounding this were emblems of the leading industries of the city. These included a full-rigged ship, an automobile, typewriter, silverware, cart-ridges, artillery guns, sewing machine and an electric motor. Surrounding these were two inscriptions, the upper one being, "Dinner to Ambassador Baron Rosen" and the words "Made in Bridgeport." On the reverse were the coats of arms of Russia and the United States, with the words, "130 Years of Friendship."

Besides the medal the Baron was presented with a set of gold plated silver knives and forks by the E. H. H. Smith Silver Co. These were of the American Beauty pattern and were from the regular stock of the company. The International Silver Co. presented him with a gold meat fork, and the American & British Co. gave a toilet set of unique pattern made from brass shells.

John A. Diem, Jefferson, Ore., has moved to Mt. Angel, Ore.

Contrary to a previously published report, the Kann Bros. Silver Co., Baltimore, Md., is not moving into quarters adjoining its present location at 303 W. Lexington St., but is retiring from the retail jewelry business in order to devote its entire time to the manufacture of silverware, replating and repairing. The concern has leased its present building, and will move its factory and salesroom, Aug. 1, to 525 N. Eutaw St.

# LATEST JEWELRY FOR SUMMER

CORRECT STYLES — SUPERIOR FINISH  
ARTISTIC DESIGNS

Embodied in Our

BRACELETS  
BACK COMBS  
LOCKETS

BUCKLES  
NECK CHAINS  
BROOCHES, Etc.

## DIAMONDS

Full Assortments in the Various  
Grades and Sizes

We strictly refuse to sell at retail, thus eliminating every  
element of possible competition with our customers

**D. C. PERCIVAL & CO., Inc.**

373 Washington Street  
BOSTON, MASS.

IMPORTERS OF DIAMONDS

MANUFACTURERS AND JOBBERS OF WATCHES, SILVERWARE  
CUT GLASS, ETC. COMPLETE MATERIAL DEPARTMENT

# EDUARD VAN DAM

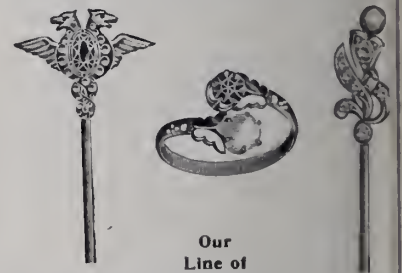

Our  
Line of

Rings, Scarf Pins,  
Ear Screws, Brooches,  
Crosses, Etc

is the kind that sells

Insist on seeing the designs of Gold  
Jewelry manufactured by the

**AMERICAN RING CO.,**

94 Point St., Providence, R. I.

Makers of Gold Jewelry that is sold to the  
Jobbing Trade.

**JULES JÜRGENSEN**  
Watches and Chronometers

PARIS — "THE GRAND PRIX" — 1900

**SOLE**

RUDOLPH & SNEDEKER,  
65 Nassau St., New York

**AGENTS**

**GARREAU & GRISE**  
68 & 70 Nassau St., New York.  
**LAPIDARIES.** PRECIOUS STONES  
EMS in Unique Cutting

# MEYEROWITZ BROS.,

IMPORTERS OF **DIAMONDS,**

37-39 MAIDEN LANE,  
NEW YORK CITY

A Complete Line of Precious, Semi-Precious and Imitation Stones. Mail orders promptly attended to.

**Rochester.**

Humburch Bros., 182 Main St. E., are conducting their annual inventory sale. Judge Hazel, of Buffalo, has announced the reappointment of Quincy Van Voorhis referee in bankruptcy for the Monroe county district.

M. B. Rosenthal, with Philip Present, turned from the road a few days ago, and will not go out again until August. Philip Present, who was selected as one of the delegates of the Rochester Credit Men's Association, to attend the meeting of the National Association at Baltimore last week, has returned home.

Alfred Kaplan, formerly at 301 Hudson St., has removed to 418 Clinton Ave. The reason among others that the relocation seemed to be an operating district for all the thieves and swindlers who come to Rochester. Mr. Kaplan has been a victim of crooks four or five times during the past year. Mr. Kaplan will engage his stock, and his new quarters being commodious, he will have a better and drier store than before.

Justice Chadsey a few days ago refused to issue a warrant for the arrest of John Nudd, who conducts a jewelry establishment on East Ave., on information sworn out by K. Wassenski, in which it was charged that the jeweler had defrauded John Nudd teaches apprentices the watchmaking and engraving trade, and the complainant claims that he paid Nudd \$100, which was to be refunded in 30 days if everything was not satisfactory. He claims that demands for the money did not produce it. The warrant was refused on the ground that it was a controversy for civil court action. Nudd denied that he had failed to live up to the contract made with his pupils, and attributed the whole matter to spite work on the part of a rival jeweler, so he claims visited his shops recently and threatened his pupils and himself with arrest. He claims that the man induced several of his pupils to leave, but he denies that Wassenski paid him more than \$50, or that he ever demanded the return of his money at the end of 30 days. Nudd says that he will begin an action to recover damages from the jeweler who is at the bottom of the whole affair.

**Buffalo, N. Y.**

Mrs. C. F. Chouffet is home from an extended visit in New York.

S. L. Levy, 483 Main St., will spend part of the summer at the Thousand Islands. Fred C. Smith goes on the road next week for Chas. F. Damm. It is Mr. Smith's initial trip.

The Beck Mfg. Co., 113 Clinton St., jewelers, has added a safe department to the establishment.

Hugo Kuster, Main and Genesee Sts., goes next week to the St. Clair Flats, a fishing resort on Lake Erie, near Detroit, Mich.

T. & E. Dickinson & Co.'s tower clock over the old store at 252 Main St. has been taken down, thus removing a sort of landmark from that section of the city. The clock had for many years been one of the most familiar objects in Main St. It will be mounted on a handsome post at the edge

of the sidewalk in front of the new Dickinson store, 432-434 Main St.

Walter Harrington, who pleaded guilty to the theft of \$3,000 worth of diamonds from the store of Paul Foerster, 134 Seneca St., has been released from the county jail on \$1,000 bail. The authorities expect to use him in an effort to connect Eugene Lobel and Peter Regan with the robbery. Lobel and Regan, however, are still at large.

Buffalo jewelers, especially those who deal in souvenirs, were benefited by the convention of the National Jewelers' Protective Association here last week. In the way of souvenirs this city is especially fortunate. Pictures of Niagara Falls on silverware are an especial valuable asset in many of the jewelry store. Traveling representatives of jewelry houses, by reason of the convention, had difficulty in securing hotel accommodations, as a result of which most of them departed on the same day they arrived.

**Connecticut.**

L. V. B. Hubbard, Shelton, on Sunday of last week distributed over 300 roses to persons who passed his place on their way to and from church.

Otto Hauschild and wife, Meriden, celebrated their golden wedding, Friday. Mr. Hauschild has been in the employ of the Bradley & Hubbard Mfg. Co. many years.

The Seth Thomas Clock Co., Thomaston, is about to install a new tower clock in the town hall of Stamford. S. Kronholtz will have charge of the winding and cleaning of the clock for the first year.

Considerable attention is being directed to the show window of C. Howard Daley & Co., Danbury, by several mounted quail which are placed on exhibition there. The birds were mounted by Geo. Beeker, of Bristol.

The fire department was called out about seven o'clock Tuesday morning, of last week, to extinguish the blaze in the blasting room of the Morgan Silver Plate Co., Winsted, but the services of the firemen were not needed.

A. L. Atwood, Bristol, on Tuesday of last week, celebrated his 90th birthday, and a large number of friends called to pay their respects and offer congratulations. Mr. Atwood is a veteran clock maker. He retired from active business 30 years ago.

Exhibited in the library of the Connecticut Historical Society, in Hartford, are three tools which were used by Alexander Anderson, the first American wood engraver. Mr. Anderson was born in New York, in 1775, and died in 1870.

An addition will shortly be built to the plant of the Wallace-Barnes Co., Bristol, which manufactures steel clock springs, etc. The structure will be of brick and steel construction, 40 by 140 feet and four stories high.

The case of John Rolston, alias Barney Haines, who was arrested a short time ago on a charge of being implicated in the theft of a diamond pin from the store of the Davis & Hawley Co., Bridgeport, has been continued, and the accused is held in \$500 bonds. Rolston has also been identified as the man who stole a diamond ring from a New Haven jeweler.

**Boston.**

Charles A. Easton, salesman for N. G. Wood & Son, is ill at his home in Hyde Park.

E. A. Bigelow, treasurer of the E. Howard Clock Co., is in New York on a business trip.

Charles W. Smith, formerly with Harwood Bros., has taken a position with the Globe Optical Co.

Frank H. Gale, of the Gale Jewelry Co., Norfolk, Va., was among the visitors in town during the week.

The New England Association of Opticians held its regular monthly meeting last evening at Young's Hotel.

D. C. Percival, Jr., has gone to the Rangeley Lakes for the remainder of the month, being in camp at Barker, Me.

H. W. Patterson, of the Smith-Patterson Co., was in Baltimore last week attending the National Association of Credit Men's convention.

I. Charles Nye, clerk for William A. Thompson, was united in marriage with Miss Bailey, of Malden, Tuesday evening, June 12, in that city.

R. J. Taylor, heretofore with R. H. Ingersoll & Bro., has taken a position with E. A. Cowan, and will travel in the west for the Boston concern after July 1.

The magnificent chime clock on the new Christian Science Church in Boston was built by the E. Howard Clock Co. It has a 4,000-pound bell for the striking of the hour and a full set of chime bells.

Emma A. Sylvester, dealer in beaded and art work jewelry, at 3 Winter St., has taken the "Maplewood Shop," at Maplewood, N. H., and will have a branch store there during the Summer season at the mountains.

The New England Watchmakers' Club was pleasantly entertained at the American House in Boston last evening, having been tendered a banquet by the Waltham Watch Co., whose representative of the manufacturing department in the Boston office, F. W. Ruggles, is president of the organization. A full report of the meeting will appear in the next issue of the CIRCULAR-WEEKLY.

At the midsummer meeting and banquet of the Boston Jewelers' Club at Point Shirley last week six new members were admitted, namely: Herbert A. Sawyer, Boston representative of the Gorham Mfg. Co.; Richard T. Supple, representative of William B. Durgin Co.; G. A. Henckel, New York; A. Connett, New York; Edward K. Colby, Newburyport, and Newton B. Eltinge, New York. Among those present at the dinner were: Charles O. Lawton, D. C. Percival, H. W. Patterson, Charles F. Morrill, H. E. Slater, E. H. Ensign, F. R. Hollister, Col. John L. Shepherd, W. W. Williams, E. Cooper Stone, Benjamin F. Griscom, Charles H. Singleton, Edwin S. Simmons, E. R. Crippen, Harry F. Hayes, A. S. Cook, Jr., John B. Humphrey, M. N. Smith, "Jack" Townsend, Emery Clement, G. A. Henckel, Newton B. Eltinge, Ray Randall, W. L. Washbourne, Mr. Graff, Charles Cook, Oscar C. Lane, J. T. O'Connell, Frank H. Elliott, Fred E. Chick, Carl D. Smith, J. C. Bachelder.

# GORHAM LEATHER GOODS

## A SEASONABLE SUGGESTION

¶ June, July and August are undeniably the "Travel Months" of the year, a fact which further suggests the increasing attention that is paid by people of refinement to the appearance and quality of their traveling equipments.

¶ For this reason the Gorham Manufacturing Co. desire to call attention to the high character of workmanship, originality of design and the admirable quality of material displayed by the products of their Leather Goods Department.

¶ Especially notable is the assortment of Travelers' necessities, including Kit and Club Bags, and Dress Suit Cases for both Ladies' and Gentlemen's use, either plain or fitted with a complete set of toilet and traveling conveniences in Gorham Silver, Ivory, Tortoise Shell and Turtle Ebony.

## GORHAM M'F'G CO.



CHICAGO,  
137 Wabash Ave.

Silversmiths and Goldsmiths

Fifth Avenue and 36th Street, New York.

BRANCHES:

NEW YORK,  
23 Maiden Lane.

SAN FRANCISCO,  
120 Sutter St.

LONDON,  
Ely Place.



WORKS: Providence and New York.



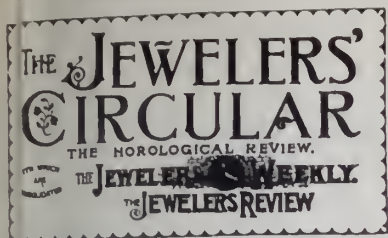

PUBLISHED EVERY WEDNESDAY BY THE JEWELERS' CIRCULAR PUB'G CO., JOHN ST. COR. BROADWAY, NEW YORK. PHONE: CABLE ADDRESS: JEWELAR NEW YORK

LII JUNE 20, 1906. No. 20.

Subscription in U. S., Canada and Mexico, \$2.00  
 Countries in Postal Union, \$5.00  
 Single Copies, .10  
 Payment by check or money order. Remittances in money are at sender's risk.

Changes of standing advertisements will be received one week in advance; new matter will be received up to Monday.

Attention paid to communications unless accompanied by full name and address of the writer. It is asked not necessarily for publication, but as evidence of good faith.

**Index to Special Articles.**

	Page.
Presented by Sir Thos. Lipton for the Ocean Yacht Race. Illustrated on front cover; text on page.....	34
List of Jewelry Stolen from Atlantic City Store.....	33
Stolen from Traveling Salesman.....	33
Hears Many Complainers Before Sentencing Morris and Joseph Klein.....	33
Mr. C. Buchanan's Answer to McKay Co.'s Suit.....	34
Imports of Jewelry, etc., to American Possessions.....	35
Alleged Diamond Thieves Held at Binghamton, N. Y.....	35
Jewelry, etc., Exported from New York.....	37
Imports and Export Statistics for 10 Months.....	37
National Convention of Credit Men.....	37
Massachusetts Jeweler Causes Return of Lost Watch.....	37
Recent Decisions of United States Courts on Jewelry and Kindred Lines.....	39
Ninth Annual Convention of Iowa Opticians.....	41
Tenth Annual Convention of Iowa Jewelers.....	41
Dier Police Seek Geo. Freeman.....	41
Death of Andrew J. Lloyd.....	42
National Gold and Silver Stamping Law Signed by President Roosevelt—A History of the Present Bill.....	43, 47
Death of Max J. Lissauer.....	47
Canadian Parliament Considers a Stamping Law.....	48
The Conditions in San Francisco Improving, When Employed by Buffalo Jeweler Charged With Larceny.....	49
When Rob Jewelers of Alton, Ill.....	49
How a Rescue Kidnaped Son of Philadelphia Jeweler.....	49
Ad Schickerling Denies Charge Made by Gustave Edelhoff.....	51
N. Frandsen in Bankruptcy.....	51
C. Goldsmith & Co. Sue Hammel, Riglander & Co.....	51
Death of Charles Rubens.....	53
T. Diamond Markets.....	53
M. Mal Presented to Baron Rosen.....	53
M. Arrested in New York on Charge of Robbing Virginia Jeweler.....	63
A. N. Y., Jeweler Robbed by Woman.....	63
E. Bee's Fashions.....	68d
Port Department.....	77
A. Exhibition of Jewelry.....	79
I. Big Clocks That Give Time to New Yorkers in Manhattan, Brooklyn and the Bronx—Miscellaneous Clocks.....	81
D. My Clock Hands.....	87
T. Optometrist's Catechism.—(Continued).....	90
A. Study of the Nervous System—(Continued).....	92
T. Health Ray Lenses—(Conclusion).....	93
M. Significant Jewelry Establishment of W. W. Vattles & Sons.....	94
H. The Retail Jeweler Can Combat the Trading Stamp Nuisance.....	95
T. Enameling of Jewelry—(Continued).....	97
B. Beautiful Bronze Group in the Metropolitan Museum of Art.....	99
S. R. Necklaces by Navajo Jewelers.....	101
M. Eden Lane (a Poem).....	101

ACCORDING to dispatches from Springfield, Ill., last week, the German Baptist Brethren at their annual conference adopted a report prohibiting members from engaging in the sale of diamonds, gold rings, gold watches, dominos, dice, playing cards and from articles for games of chance or display. And this was done in the United States of America in the year of our Lord 1906. Does the world move?

**A National Stamping Law at Last.** PROBABLY the most important piece of legislation ever enacted in behalf of the jewelry trade in the United States is the bill which became a law last week when President Theodore Roosevelt affixed his signature to the Jewelry Trade's Gold and Silver Stamping Bill, introduced by Representative Vreeland, of New York, and inaugurated by THE CIRCULAR-WEEKLY. This measure, which becomes a law after a short campaign in which it received the ardent and unanimous support of all branches of the jewelry trade from every section of the country, is a bill that has practically been desired by the workers of gold and silver from the time of the beginning of the republic. That it could be obtained in a single session of Congress at a time when the calendars of both houses were choked with general legislation of the greatest political and economic importance effecting the welfare of the people of the whole country, is a surprise as delightful as it was unexpected.

The success of the movement for this bill, whose history is briefly traced on another page of this issue, is due in great part to four factors: (1) It was purely a bill made to promote honesty and to protect the public; (2) it sought to exploit and give advantage to no individual interest, industry or geographical locality; (3) it had the united and unqualified support of every one engaged in the trades and industries to which it applied, and (4) it was given strenuous and able backing by its friends in Congress and the trade. To Hon. E. B. Vreeland, who introduced the measure, first of all, the gratitude of the jewelry trade is due, not only for his indefatigable energy and work in and out of the halls of Congress in favor of the measure, but also for his broadmindedness and the deep interest which he took in the subject from the beginning, which helped to make possible the introduction of a single measure on the subject, expressing the views of and endorsed by all sections of the trade. Second only to the work done by Mr. Vreeland in the House was that of Congressman Sherman, who was temporary chairman of the committee of Congress which considered the measure; quick to appreciate the merits of the bill and the necessity of its passing, Mr. Sherman lent his every aid in not only getting votes for the measure, but in facilitating the work of getting it through the House. In the Senate the measure had many friends, but for its success credit is in great part due to Senators representing three States having large jewelry industries; namely, Senator Aldrich, of Rhode Island; Senator Kane, of New Jersey, and Senator Crane, of Massachusetts. All three not only favored the measure, but did everything in their power in its behalf.

For the work outside of the halls of Congress thanks of the trade are largely due to counsel who drew the bill and who has watched over it during its career, and to the members of the joint committee of the jewelers from New England, New York and New Jersey, to whose ability and disinterestedness in the work of perfecting it the unanimous support of the trade was in great part due.

THE CIRCULAR-WEEKLY, while congratulating the trade as a whole at the end of this memorable campaign, is especially proud that it has been able to be an agent in such a noble cause, and is gratified that its work in drafting the initial act, supporting the movement and helping to harmonize the various interests in the trade that might otherwise have worked on different lines to the same end, contributed so much to accomplishing that which the trade has so long desired. To the readers of this journal whose hearty support and co-operation has made it possible for us to be a factor in this great work, we extend our heartfelt thanks and express our sincere appreciation.

**Death of Elizabeth Schaible.**

TROY, O., June 14.—Elizabeth Schaible, widow of the late John Schaible, and senior member of the firm of Schaible Bros., of this place, having retained her husband's interest in the business, died at her home in this city Monday, aged 70 years.

The deceased was a native of Heiterbach, Germany, where she was born March 25, 1836.

Mrs. Schaible came to this country with her parents in 1849, and the family settled in Greenville, where, on Aug. 31, 1858, she was married to Mr. Schaible. The couple moved to Troy in 1873 and Mr. Schaible died in 1890.

The deceased is survived by six children. The remains were buried from her late home at 2 o'clock Wednesday afternoon.

**Importations at the Port of New York.**

<i>Weeks Ended June 16, 1905, and June 15, 1906.</i>		
China, Glass and Earthen Ware:	1905.	1906.
China.....	\$63,247	\$77,617
Earthen ware.....	11,305	21,253
Glass ware.....	14,799	26,986
Optical glass.....	4,233	.....
Instruments:		
Musical.....	15,985	22,364
Optical.....	6,722	5,628
Philosophical.....	1,775	1,543
Jewelry, etc.:		
Jewelry.....	7,202	4,658
Precious stones.....	524,022	888,831
Watches.....	37,331	20,083
Metals, etc.:		
Bronzes.....	1,526	63
Cutlery.....	36,386	43,439
Dutch metal.....	1,192	2,983
Platina.....	47,229	24,879
Plated ware.....	.....	.....
Silverware.....	209	1,030
Miscellaneous:		
Alabaster ornaments.....	225	319
Amber.....	.....	9,806
Beads.....	3,944	3,341
Clocks.....	5,410	7,566
Fans.....	6,482	7,387
Fancy goods.....	10,566	9,865
Ivory.....	839	26
Ivory, manufactures of.....	2,968	105
Marble, manufactures of.....	32,414	3,494
Statuary.....	12,424	8,406

S. W. Thompson, Sr., Monticello, Ind., is about to move into new quarters where he will have more space for his increasing business.

# JUNE WEDDINGS

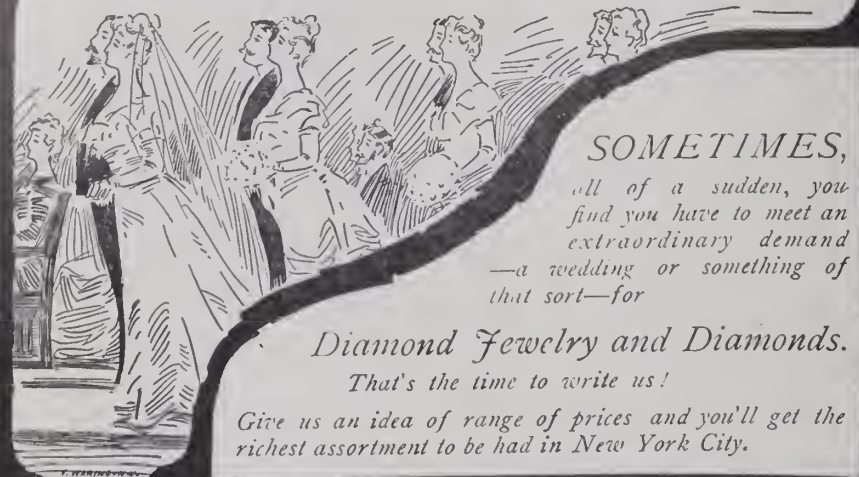

SOMETIMES,  
all of a sudden, you  
find you have to meet an  
extraordinary demand  
—a wedding or something of  
that sort—for

*Diamond Jewelry and Diamonds.*

*That's the time to write us!*

*Give us an idea of range of prices and you'll get the  
richest assortment to be had in New York City.*

## CROSS & BEGUELIN

Importers and Cutters of Diamonds and Precious Stones

43 Rue de Meslay, PARIS Telephone, 2188 Cortlandt 17 Maiden Lane, NEW YORK

## ARCH CROWN MOUNTINGS IMPROVE DIAMONDS

*Why not set  
your diamonds  
in the mounting  
that displays  
them best?*

*Send for samples.*

Arch Crown Mfg. Co 26 Camp Street  
Newark, N. J.

## Last Week's New York Arrivals

THE CIRCULAR-WEEKLY each day from its office a bulletin of the latest buyers in New York, which every member of the trade is cordially invited to copy.

- AKRON, N. Y., F. B. Goodman (The M. Co.), Cadillac.
- BALTIMORE, MD., J. Engel (J. Engel Herald Sq.  
G. Freundlich (J. Epstein), Grand.  
E. B. Hutzler (Hutzler Bros.), Grand.  
E. Kohner, Astor House.  
M. Schneberger (Goldenberg Bros.),
- BATON ROUGE, LA., J. K. Rouman House.
- BOSTON, MASS., N. H. Gardiner (Jordan Co.), 8 Greene St.  
S. Ginsberg (B. Ginsberg & Co.), Ashla  
H. T. Maynard (Maynard & Potter) Ir
- CHICAGO, A. Binswanger (Siegel, Cooper Woodstock.
- CINCINNATI, O., E. J. Fox (Lindenberg & Martineque.  
J. Wolf (H. Wolf & Sons), Marie Ann
- CLEVELAND, O., C. I. Goldsmith (Gold Bros.), St. Denis.  
W. P. Deutseh (Deutsch Jewelry Co.), Sq.  
H. L. Goldsmith (Goldsmith Bros.), St.
- GLOUCESTER, MASS., A. W. Lane, Costan.
- MEMPHIS, TENN., C. T. Brodnax, Astor
- PITTSBURG, PA., B. Neuman, Herald Sq
- READING, PA., C. D. Laubach (C. K. W & Co.), Grand.  
Miss Leyden (C. K. Whitner & Co. Broadway.
- SYRACUSE, N. Y., S. A. Liberman (M. Liberman), St. Denis.  
M. L. Mantell, Herald Sq.
- WORCESTER, MASS., J. Hogan (Denhe McKay Co.), 2 Walker St.
- YOUNGSTOWN, O., E. H. Rolf (G. M. Rovey & Co.), 320 Church St.

## Trans-Atlantic Voyagers

### TO EUROPE.

I. H. Weinberg, New York, sailed Sunday on the *Zealand*.

W. S. Manheimer, of Louis Manheimer & Bro., Chicago, will sail to-morrow.

Leo Goldsmith, New York, will sail today on the *Kaiserin Auguste Victoria*.

W. A. Moore, Jr., of Alfred H. Smith & Co., New York, will sail June 23 on the *Deutschland*.

George M. Van Deventer, of the Wrenbury Clock Co., New York, and wife sailed last week on the *Moltke*.

L. A. Breiting, president of the American Cuckoo Clock Co., Philadelphia, will sail Saturday on the *New York*.

Richard Friedlander, of R. L. & I. Friedlander, New York, will sail to-day on the *Oceanic*. On the same boat will sail Herbert W. Allen, of Herbert W. Allen & Co., Chicago; Frank K. Huff, vice-president of Mount & Woodhull, and Mrs. Huff, New York.

### FROM EUROPE.

Irving Levinson, president of the S. L. Co., New York, returned last week. Charles N. Hancher, Wheeling, W. Va., arrived last Wednesday on the *Kaiser Wilhelm II*.

Wm. G. Pollack, of W. G. Pollack & New York, returned recently on the *Amerika*.

Joseph E. Whitten, Ripley, Miss., is now at Ensley, Ala.

**New York Notes.**

Charles E. Tripp, 411 Amsterdam Ave., took week end out of business.

L. Goldsmith, 9 Maiden Lane, will sail for Europe on the *Kaiserin Augusta* via.

Job J. Schmuckler, jeweler at 131 Canal, and Miss Lazette Cohen, 113 Second were married June 10.

J. Weinberg, 14 Maiden Lane, sailed today on the steamship *Zeeland* to visit diamond markets of Antwerp and Amsterdam.

Ernest Friedlander, of R. L. & M. Friedlander, 80 Maiden Lane, will sail to-day on the *Oceanic* to purchase diamonds in European markets.

W. Huggins, the president of A. I. & Son, San Francisco, Cal., has returned to the city for sometime making his headquarters with Larter & Sons, 21 Maiden Lane.

Frank K. Huff, the vice-president of J. & Woodhull, New York, accompanied by Mrs. Huff, will sail to-day on the *Oceanic* to spend two months in the European markets.

Charles Jackle, 806 3d Ave., who some time ago obtained an injunction to prevent the Interborough Co. from constructing a third track through the street, has withdrawn his opposition, it is said.

Leopold S. Sussbaum & Hunold last week moved their New York office from room 1503 to room 506 in the building at 9 Maiden Lane. Their new quarters provide increased facilities for displaying the firm's sterling silver wares.

The second annual convention was opened today by the National Association of Jewelers and Manufacturers in the Hotel Marlborough. Delegates from associations in all large cities of the country were present. Sessions will continue until to-morrow.

Under an order of United States District Court, the business of Barney Steinfeld, 100 Sixth Ave., was given last Wednesday in charge of William F. Allen as receiver. A petition in bankruptcy against Mr. Steinfeld was filed as related in last week's issue.

Eugene S. Toner, formerly of the Eugene S. Toner Co., has recently opened an office at 14 Maiden Lane as manufacturer's agent, representing Fessenden & Co., and the Hancocks & Follis Co., both of Providence, R. I., and the Silver City Cut Glass Co., Meriden, Conn.

A jewelry workman, named Isaac Beschi, 40 years old, of 854 Myrtle Ave., Brooklyn, was arrested last Thursday, after he had attracted a crowd on the street, it is said, by making a speech and acting in a disorderly manner. He was held the next day on \$100 bail for examination by Magistrate Frong.

Four new members of the Jewelers Board of Trade were admitted at a regular monthly meeting held last Thursday by the Board of Directors: Bigalke & Eckert Co., New York; Block, Berthold & Co., Buffalo, N. Y.; H. Kroll & Co., New York; Holsman & Ritter, Chicago; Western Selling Agency Omega Watches, Chicago.

In the current number of *Printers' Ink* is an article of several pages devoted to the business of R. H. Ingersoll & Bro. The writer describes the growth of the

"dollar watch" business, and explains the advertising methods that have been used. On the first page are excellent pictures of Robert H. and C. H. Ingersoll.

Frank M. Mulreim, who was for 36 years with the Whiting Mfg. Co., and John C. Cook, who was for 22 years in the silver business, the last nine years with Redlich & Co., as manager of their factory, recently formed a co-partnership and bought out the Central Plating Co., 34 E. 29th St. The new firm has a fully equipped plant for repairing, replating and regilding all kinds of metals.

Creditors of Bernhard Cohen, Trenton, N. J., met Tuesday of last week in the rooms of the Jewelers' Board of Trade, and requested the Board to send a representative to Trenton for the purpose of looking into his affairs. C. N. Gray, representing the board, visited Trenton during the week and conferred with Mr. Cohen. As a result of the conference Mr. Cohen is now offering his creditors 25 per cent., 15 per cent. in cash and 10 per cent. in notes for the assignment of claims.

Reduced rates to this city for out-of-town buyers will be in effect during the Fall buying season from Trunk Line Association on territory, the dates being Aug. 18 to 22, inclusive, and Sept. 2 to 6, inclusive. The special fare will, as usual, be made under the certificate plan, the rate being one fare and one-third for the round trip. The return limit on the certificates will be 15 days. The arrangements with railroads have been made, as usual, by the Merchants' Association of New York.

L. A. Breiting, the president of the American Cuckoo Clock Co., Philadelphia, Pa., will sail Saturday on the *New York* for Europe, intending to visit the company's movement factories in the Black Forest. He will disembark at Cherbourg and go thence by way of Paris. His principal purpose is to see that the equipment of the shops is continued up-to-date, and that wherever possible improvements are introduced. Incidentally he will purchase such novelties as the European markets may offer at this time.

Dieges & Clust, 23 John St., sent out a letter last week, announcing to friends and customers the death on June 8, of Henry Clare, Jr., in his 36th year. Mr. Clare had been with the firm for a number of years. This tribute from his late employers shows the high regard in which he was held: "For many years our confidential friend and business associate, he won an established position in the trade by his tireless energy, strict integrity, exceptional ability, loyalty and that winning personality that always cemented ties of friendship and brotherly love."

The wife of the Gaekwar of Baroda, one day last week, called at the salesrooms of Chas. S. Crossman & Co., 3 Maiden Lane, and the presence of the East Indian princess in the jewelry district caused some excitement for a short time. The Princess wore a white robe in Oriental style. In her ears were a pair of cluster ruby ear studs. On the upper parts of both ears she wore two other earrings of large fancy pearls fastened to her ears, but not pierced. Ornaments containing three diamonds were fastened to her nose apparently with a small clamp. She had many rings on her

fingers and about her waist was a fancy gold belt about three inches wide.

Suspicion was awakened in the mind of Solomon Newman, 1952 3d Ave., last Wednesday, when a stranger offered to sell a string of pearls with a diamond locket and a diamond butterfly pin. A policeman was summoned and placed the young man under arrest. The prisoner, who at first gave his name as Harry Wilson, was taken to the East 67th St. Station. Later the jewelry was identified as part of the property stolen on June 6, from the summer home of W. S. Gould, at Port Chester, N. Y. The police say that Wilson is also known as Edward Shubert, and that he is a professional crook, who makes a business of obtaining employment as a butler in the homes of wealthy people whom he robs.

When Bernardo Settecase, a Sicilian, second cabin passenger on the *Cretic*, stepped on the White Star pier last Friday customs inspectors saw something suspicious in his appearance, and in searching his baggage found the following jewelry: Ten pairs of pearl earrings, 5 amethyst scarf pins, 11 small diamonds rings, 3 pearl necklaces, 2 gold watches with chains and charms and a quantity of cuff buttons, collar buttons, shirt studs, brooches and bracelets. The jewelry is valued at \$800. Some of the articles were sewed in the lining of his clothes, and the stick pins were imbedded in stockings. The Sicilian was arraigned before United States Commissioner Shields on the charge of smuggling, and bail was fixed at \$1,000, in default of which he was sent to the Tombs.

Articles of incorporation of the International Watch Co. were filed last week with the country clerk in Jersey City. The company will manufacture watches, clocks, chronometers, nautical instruments, mechanical toys and games. The factory will be at 9 to 21 New St., Jersey City. The capital is \$600,000, divided into 6,000 shares of the par value of \$100. Of the capital 4,000 shares will be 10 per cent. preferred stock, and the remaining 2,000 shares common. The company will start business with \$540,000. The incorporators and number of shares held by each are Ernest Bunzl, 155 W. 75th St., New York, 1,700 shares of preferred and 999 shares of common; Otto Bartel, Jersey City, two shares of common stock, and Gustave Bunzl, 14 E. 60th St., New York, 1,700 shares of preferred and 999 shares of common stock.

George Montgomery, of Montgomery Bros., Los Angeles, Cal., will arrive in New York about July 1, and will make his headquarters with the Gorham Mfg. Co.'s uptown store, 5th Ave., and 36th St. One of the objects of Mr. Montgomery's eastern visit is to obtain ideas which will help the firm in fitting the new store which his firm expects to occupy in less than two years. It is the intention of the concern to make this one of the most handsome stores in the country, and so an early start is being made in preparing the plans.

Henry C. Perley, of Perley Bros., 26 John St., is mentioned this week in the papers as among the citizens of New Rochelle, who have taken an active part in the presenting to the district attorney evidence of bribery affecting aldermen of that

IN THE HEART OF THE JEWELRY DISTRICT.

**Guardian Trust Company,**

170 BROADWAY, COR. MAIDEN LANE, NEW YORK.

Capital and Surplus - Over \$1,000,000

Equitable rates of interest allowed on surplus funds.

Collection of out-of-town items made on reciprocal basis.

FRANK W. WOOLWORTH, President.

GEORGE W. FAIRCHILD, Vice-President.

CHARLES L. ROBINSON, Vice-President.

LATHROP C. HAYNES, Secretary.

ALFRED M. BARRETT, Asst. Sec'y.

Prominent Jewelers  
Among our Directors

LUDWIG NISSEN.

A. K. SLOAN.

LEOPOLD STERN.

**THE ORIENTAL BANK.**

ESTABLISHED 1853.

182 and 184 Broadway, <sup>Corner</sup> JOHN STREET, NEW YORK.

Capital, - - - \$750,000.00.

Surplus and Profits, 1,100,000.00.

**ACCOUNTS FROM THE JEWELRY TRADE ARE SOLICITED.**

R. W. JONES, Jr., President.

NELSON G. AYRES, First Vice-President.

GEO. W. ADAMS, Cashier

LUDWIG NISSEN,

ERSKINE HEWITT,

CHARLES J. DAY,

} Vice-Presidents.

R. B. ESTERBROOK, Assistant Cashier.

**The Market and Fulton National Bank of New York.**

ORGANIZED 1852

81-83 FULTON STREET.

Capital, \$1,000,000.

Surplus, \$1,335,000.

ALEXANDER GILBERT, President.

R. A. PARKER - - Vice-President.

T. J. STEVENS, - - - Cashier.

JOHN H. CARR, - Asst. Cashier.

**Invites the Accounts of Jewelers.**

Will extend every facility that good banking will justify.

**SAFE DEPOSIT VAULTS.****The Chatham National Bank**

Broadway and John Street, New York

H. P. DOREMUS, Cashier

GEORGE M. HARD, President

W. H. STRAWN, Ass't Cashier

**THE STATE BANK**

376-378 GRAND STREET, NEW YORK

Capital and Earned Surplus, over \$1,100,000. Deposits over Fourteen Million.

Offers a favorable market for short and long time jewelry and diamond paper

# *The Mercantile National Bank of the City of New York*

*Cordially invites Accounts  
from Good Merchants  
in the Jewelry Trade.*

**CONVENIENT LOCATION,  
AMPLE CAPITAL,  
LARGE SURPLUS,  
LONG EXPERIENCE.**

*FREDERICK B. SCHENCK, President.*

*MILES M. O'BRIEN, } Vice  
WILLIAM H. TAYLOR, } Presidents.*

*JAMES V. LOTT, Cashier,  
EMIL KLEIN, Asst. Cashier,  
ALFRED W. DAY, Asst. Cashier.*

<i>Capital,</i>	<i>•</i>	<i>•</i>	<i>•</i>	<i>\$3,000,000</i>
<i>Surplus,</i>	<i>•</i>	<i>•</i>	<i>•</i>	<i>\$3,000,000</i>

*Broadway, Corner of Dey Street,  
New York.*



Bigalke & Eckert Co.

IMPORTERS OF WATCHES,

No. 1 MAIDEN LANE, NEW YORK

Single and Split Second Timers in Nickel and Gun Metal Cases

Complete Assortment of Chronographs,  
Split Seconds and Minute Repeaters.

Ladies' and Gentlemen's Flat and Ultra Flat Watches.



SOLE AGENTS FOR

Haus, Neveu & Cie.

FINE GENEVA WATCHES.



THIS IS HOW IT HAPPENED.

Some few years ago we determined that first of all we were going to make the best Cuckoo Clocks that brains and skilled craftsmanship could put together; then we were going to sell them for as little as we could.

The expected happened. Quality won out as it always does. We have a country-wide reputation for making the best Cuckoo Clocks that have ever been produced, and with that reputation has come the largest Cuckoo Clock business in the world.

Better write for our new Catalogue.

**AMERICAN CUCKOO-CLOCK COMPANY**  
Cuckoo Clocks and other Unusual Clocks  
**STATION S. PHILADELPHIA**

**HAVE YOU SEEN OUR LINE ?**

LARGEST VARIETY AND MOST COMPLETE LINE OF

**JEWELRY AND SILVERWARE CASES**

WINDOW DISPLAYS AND SHOW-CASE EFFECTS

**ABE KASSEL**

671-3-5 HUDSON ST.

NEW YORK

NEW YORK

"Cantlose"

The New Eye-glass Holder

Practical  
Simple  
Safe  
Secure

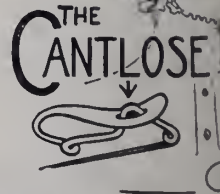

Positively prevents loss of Glasses from Hook. The feature of this Holder is a "Hump" engaged by a "Loop," making a secure connection.

For Sale by Leading Optical Dealers  
Paul Gougelman, Mfr., 37-39 Maiden Lane, N.Y.C.

Jewelers Having Tortoise Shell Goods

that have become dull or broken, can have them repaired, repolished and made as good as new, at a small expense, by sending them to the manufacturer,

POTTER SHELL WORKS, Providence, R.I.

"PRACTICAL COUSE IN ADJUSTING."

PRICE \$2.50.

ALL JOBBERS OR

JEWELERS' CIRCULAR PUBLISHING CO.

**New York Notes.**

(Continued from page 59.)

and growing out of a new telephone company's application for franchise. A suit in which many druggists and jewelers, who purchased jewelry from the American Mfg. Co., Iowa City, Ia., are interested, was decided in favor of the defendant in the Second District Court of New Jersey City, N. J., last week. The plaintiff in the action was the Johnson County of Iowa City, which sued L. E. Carver, a druggist of Jackson and Bramble Aves., Jersey City, for \$254.22 on a promissory note given in payment for jewelry. The defense contended that the stock was not what it was represented to be by the defendant.

**Arrested in New York on Charge Virginia Jeweler Pleads Mistaken Identity.**

Wheaton B. Despard, also called by the name Dean Stevens, was arraigned in the New York Police Court last Saturday, on the charge of grand larceny, in stealing a diamond ring, valued at \$175 from John F. Kohler, a jeweler, of 209 E. Broad St., Richmond, Va. Despard gave his address as 10 W. 84th St. It is charged that Despard is the man who, with an accomplice, on May 28, went into Kohler's store and stole a diamond ring, valued at \$30. The next day the man returned to look at other diamond rings, and when he left Kohler discovered that a \$175 diamond was missing.

The police were notified, and say that Despard was traced to this city. Detectives learned that he expected a package to arrive from Richmond on Friday which contained another diamond ring, valued at \$180, which he had ordered sent to him by a pawnbroker. The detectives watched the office of the Adams Express Co. at 11 W. 4th St., until Despard and his wife appeared and asked for the package. Before the package was delivered to him he was arrested. Mrs. Despard created a scene. She said that they had been married for six years, and that her husband was a traveling diamond salesman. Nine pawn tickets were found in his possession.

Mr. Kohler appeared in court and identified Despard by a deep vertical gash on his forehead. The man was held in default of \$10. He retained a lawyer, who said that he would oppose efforts to extradite his client on the ground that this is a case of mistaken identity. Despard is about 38 years old.

Wm. S. Ketchum, Imboden, Ark., has sold out to J. W. Matchell.

Montgomery Bros., Los Angeles, Cal., have leased a new store, 80 by 120 feet, which they expect to occupy in a little less than two years. The firm has obtained a lease and intends to fit up the store in a magnificent style, making it one of the most attractive in the country. In order to accomplish this result, the members of the firm are already getting information and preparing plans. Everything in the store is entirely new, and special furniture is being designed.

**Patents and Trade-Marks.**

THE difficulties that American inventors have experienced in procuring patents in Germany led a foreign patent attorney in New York to take up the subject with the German patent office. That institution gave it serious study and discussion, which resulted in a reply by President Hauss making full explanation, and granting some amelioration. The letter in part follows:

In complaining about a too severe definition of the term invention you refer especially to the fact that the proof of a "new technical effect" is more often acquired than it appears advisable according to the circumstances. This should only be regarded as an expression to the effect that in the opinion of the examiner there is lacking in the subject-matter of the application any considerable effect. Such an estimate, whether the invention, in as far as it is new, exceeds that which also an "ordinary workman" is able to do, must be left to the examiner and the departments of the patent office. It is of less importance than the expression that is used by the patent office in refusing a patent. However, I have taken care that the phrase requesting to "prove a new technical effect" is limited to those cases in which an industrial process does not come into question except from the mechanical view point, and when the stated technical effect is so improbable that a proof must be demanded.

President Hauss says that the patent office must be guided by the decisions of the German supreme court, which has laid down a series of principles covering inventions, and which cannot be left unobserved in granting patents without great injury to the interested industrial branches. He also points out the fallacy of the statement that in Germany "every invention must contain a new principle" "by the fact that about 10,000 patents are annually granted in Germany, whereas nobody will say that fundamental new inventions are remotely made in any such number."

That American applicants are not treated worse than Germans is evident, says Mr. Hauss, for 1,069 German patents were granted to Americans in 1903, or only a decrease of 2.3 per cent. from the number granted in 1901, whereas the decrease was 4.2 per cent. in the number granted to German applicants for the year 1902, as compared with 1901, the figures being 6,334 and 6,609, respectively. Also that out of every 100 applications in the German Empire an average of 34 patents were granted in the years 1901 to 1903, whereas on 100 applications from the United States an average of 59 patents were granted in the same period. The year 1904 showed a still more favorable comparison for Americans.

**TRADE-MARK DIFFICULTIES IN CUBA.**

The Merchants' Association, of New York, announces that it has recently received a number of complaints from its members concerning the confiscation, by citizens of Cuba, of trade-marks which have been established by American citizens by years of use, and have been made valuable by expensive advertising. Hence the association is seeking to secure the same degree of protection of American trade-marks in Cuba as the laws of the United States give to Cuban trade-marks. In America foreign

owners have the same right to registration of trade-marks as citizens, while in Cuba a citizen may register any well-established and valuable American trade-mark not already registered in the island, and thus become the owner of same. Then if the American goods bearing this trade-mark continue coming into Cuban custom houses they are liable to confiscation, and the Cuban who has registered the trade-mark has both a criminal and a civil action against the American owner for infringement. The Merchants' Association is seeking to remedy this trouble.

**AMERICAN TRADE-MARK AMENDMENTS.**

Some notable changes will affect trade-mark registrations in the United States after July 1. The new law provides that classifications shall be established as in foreign countries, England having 50, Germany 12, and France 74, one section reading:

That the Commissioner of Patents shall establish classes of merchandise for the purpose of trade-mark registration and shall determine the particular description of the goods comprised in each class. On a single application for registration of a trade-mark the trade-mark may be registered at the option of the applicant for any or all goods upon which the mark has actually been used comprised in a single class of merchandise, provided the particular description of the goods be stated.

The third section of the bill changes existing laws to give a citizen of a foreign country who has a manufacturing establishment within the territory of the United States the same rights and privileges "so far as the registration and protection of trade-marks used on the products of such establishments are concerned," as are enjoyed by our own citizens.

**Albany, N. Y., Jeweler Robbed of Stock Worth \$1,300 by Two Men Who Use an Old Method.**

\*ALBANY, N. Y., June 16.—Two young men this morning stole a quantity of jewelry from the store of Wm. F. Antemann & Son, 21 N. Pearl St., and escaped with articles valued at \$1,300. The men entered the store at the same time, but acted as if they were strangers to each other. One of them, after looking in the show case, asked Mr. Antemann to get something for him out of the show window. The man then walked out to the sidewalk in order to point out the article. In this way he occupied Mr. Antemann's attention, and as there was nobody else in the store at the time, the other man had an opportunity to carry out the theft.

The man inside was tall, and it is supposed that he reached across the show case and opened one of the sliding doors which was not locked. He then took a number of articles. The man on the sidewalk, apparently dissatisfied at not finding what he wanted, walked away and the tall man also left. Mr. Antemann did not discover the robbery for some time. Then he found that there were missing a diamond ring with a single stone, weighing 2 $\frac{3}{4}$  by 1-32 carats and set with smaller diamonds; four Princess diamond rings, a diamond and ruby ring, diamond and opal ring, diamond sunburst pendant, the central stone weighing 2 $\frac{1}{2}$  carats.

The tall man had light hair and wore a light suit. He looked like an Englishman. The shorter man had black hair.

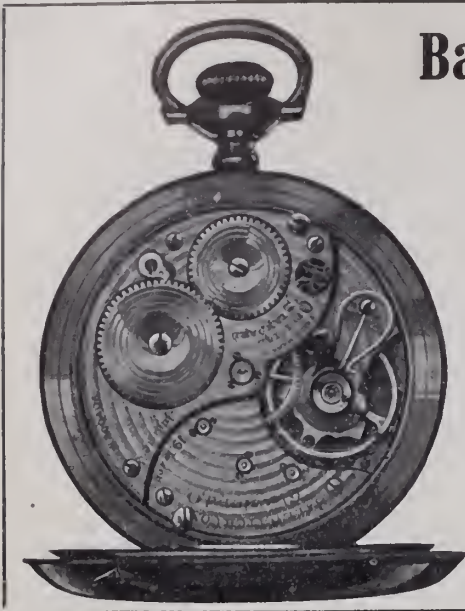

## Ball's Official Standard R.R. Watches

WHAT WOULD YOU GIVE FOR A LIFELONG CUSTOMER?

Try this plan.

Sell your next watch customer a "Ball."

Its reliable performance will convince him you are a dealer to be depended on—he'll keep coming back for other things.

The watch will win you his business and friendship for always.

*Write for booklet, and watch this space.*

We want to add a lot of new friends to the Ball family of railroad watch dealers.

### THE WEBB C. BALL WATCH CO.

CLEVELAND  
Ball Building

CHICAGO  
804-6-8 Railway Exchange

ESTABLISHED 1854.

INCORPORATED IN OHIO

## JUERGENS & ANDERSEN CO.,

DIAMONDS,

MAKERS OF FINE JEWELRY,

92 TO 98 STATE STREET,  
CHICAGO

23-25 Looljersgracht, Amsterdam, Holland.

# THE HERMAN KECK MFG. CO.

CUTTERS OF

# DIAMONDS.

### FOR SALE.

A complete diamond cutting outfit of twenty benches, European make, consisting of sawing machines, rounding machines, laps, tongues, dops, scouring stands, etc., all in first class condition. Will sell cheap, if sold in bulk at once, as we have replaced them with American tools.

MANUFACTURING JEWELERS, SILVERSMITHS

Recutting and Repairing of Diamonds.

17-19-21-23 West Fourth St.,  
CINCINNATI, O.

RUDOLPH NOEL

PHILIP O.

## RUDOLPH NOEL & CO.

IMPORTERS OF

# DIAMONDS

2 Tulp Straat, AMSTERDAM

Phone 1902 John

37-39 Malden Lane, NEW YORK





# WESTERN DEPARTMENT

Western Office:  
204 COLUMBUS MEMORIAL BUILDING,  
CHICAGO.

Telephone:  
4079 CENTRAL,  
CHICAGO.

LII.

CHICAGO, WEDNESDAY, JUNE 20, 1906.

No. 20.

## Chicago Notes.

Wedlich, St. Louis, Mo., was here last week.  
Olph Weiss, of Heinrich, Hermann & Co., is in New York.  
Mund Stern, of Stern Bros. & Co., left Chicago last week.  
Robert W. Allen and wife, sailed to Europe on the *Oceanic* for Europe.  
Harvey H. Miller, with Hutchison & Co., has returned from an Eastern trip.  
X. Parsche & Son, cut glass manufacturers, have incorporated with a capital of \$100,000.  
"Kate" Lebolt, of Lebolt & Co., sailed for Europe last week, to visit the diamond markets.  
Frank H. Challen visited the Ohio Cut Glass Co.'s factory at Bowling Green, O., last week.  
H. Van Bergh, of the Van Bergh Silver Plate Co., Rochester, N. Y., was here last week.  
Harper, with the American Silver Co., returned from a visit to the factory at Bristol, Conn.  
F. Spies, of Spies & Co., is the proud father of twins, a boy and girl, who first saw the light June 10.  
E. McCullin, Western manager for W. A. Rogers, Ltd., is on a visit to the company's factory East.  
G. H. Thomas, with the Mauser Mfg. Co., is taking a vacation with his wife and daughter at Petoskey, Mich.  
The engagement is announced of Jos. Brown, of Jos. Brown & Co., to Miss N. Phillips, of Seattle Wash.  
W. Crofts, retail jeweler of Greenland, Mich., was married last week at Ravenswood to Miss Frances Lawton.  
The meeting of the Chicago jobbers' association was held last Friday. The proceedings were not made public.  
Miss Rebecca Gelder, formerly jewelry buyer for Hillmans, will shortly sail for Europe for recreation and rest.  
Harry E. Jones, with the Wadsworth Watch Case Co., has returned from a Western and Northwestern trip.  
E. Ziehme bought real estate last week to the extent of \$95,000, giving partly in exchange real estate valued at \$77,800.  
S. Metcalf, of the Plainville Stock Co., visited this city last week as did Jos.

T. Homan, of the Homan Silver Plate Co., Cincinnati.

G. M. Landon, with the Homan Silver Plate Co., and G. S. Titus, with the Barbour Silver Co., are recreating at Eagle Springs, Wis.

Miss Rose Noel, sister of Max, Rudolph and Phil. Noel, was married yesterday at the Metropole Hotel in this city to Sam Gersten.

E. B. Hoffman, salesman for H. F. Hahn & Co., is taking a vacation at Big Rapids, Mich., where he recently became the owner of a summer hotel.

W. A. Moore, Jr., with Alfred H. Smith & Co., left here last week for New York. He sails from there on June 28 on the *Deutschland* to visit the European diamond markets.

Jacob Wolf, 116 E. 31st St., will discontinue business at that address July 16. Mr. Wolf says he is going into the jewelry business in either Spokane, Seattle, Portland, or Tacoma.

The estate of Buck & Schmitz, bankrupts, formerly in the Masonic Temple, who went under about a year ago, owing over \$7,000, has declared a first and only dividend of 3 per cent.

Adolph Kronberg, formerly with S. Lazarus & Co., has opened a jewelry repair shop at 1012 Champlain Building. Mr. Kronberg bought the plant of the Roberts Mfg. Jewelry Co.

Arthur J. Williams, of A. L. Williams & Co., was married Wednesday last to Miss Gertrude Hemmersbach. The young couple are spending a honeymoon at Niagara Falls, and the East.

Wednesday evening last, Theo. Gribi delivered a splendid lecture before the American Horological Society of this city. His subject was, "The Pyramids, the Oldest Scientific Monuments in Existence, and Their Relation to Horology."

Wm. S. Manheimer, of Louis Manheimer & Bros., left for New York last Wednesday. He sails for Europe to-morrow on the *Kaiserin Augusta Victoria*. Mr. Manheimer will be absent two months, visiting the principal cities of Europe.

Among the jewelry buyers here last week, were S. W. Crofts, Greenland, Mich.; Hermann Chas. Watts, Forrest, Ill.; Cyrus Stall, Bryan, O.; D. B. Stall, Hoopeston, Ill.; B. Ochiltree, Clarksville, Ia.; O. C. Zinn,

Hastings, Nebr.; Mr. Eyster, of the Jewelers' Supply Co., Seattle, Wash.

Miss Ada Hill, formerly assistant jewelry buyer for The Fair, has been appointed jewelry buyer for Hillmans. Miss Carrie Stern, assistant silver ware buyer for The Fair, is Miss Hill's successor. She will assist in buying for both departments.

A "to let" sign is displayed on the store of the Fidelity Trust & Receivers' Co., 88 State St. This is the concern which recently started to conduct daily auction sales of jewelry, etc. One feature of the business was that of advertising for bids by mail.

D. B. Stall, of the Stall Jewelry & Optical Co., Hoopeston, Ill., was a visitor here last week. Mr. Stall, who recently bought out J. A. Seekatz, recently sustained a loss by fire; he reports that he received \$1,800 for his loss from the insurance companies.

Louis Carter, buyer and manager for the cut glass, bronze, lamp and kindred departments of Mandel Bros., has resigned to accept the position of European buyer for L. D. Block & Co., New York. Mr. Carter will remain with Mandel Bros. until his successor is appointed.

At the recent meeting of the Elgin National Watch Co.'s stockholders, the retiring directors and officials were re-elected. President Hulburd is quoted as saying that the net earnings for the fiscal year exceeded \$700,000 or 14 per cent. on the capital. No statement has been issued.

Miss Ione Garlick, daughter of Charles A. Garlick, received a gold medal last week, for her success in oratory at the 20th annual commencement exercises of the American Conservatory of Music, held at Orchestra Hall. Miss Garlick received many floral tributes from her friends.

Judge Mack, of the Circuit Court, has granted an injunction in favor of the United Cigar Stores' Co. against a barker, employed by Doyle's jewelry store, located just west of State St., on Monroe, and next to the cigar store. The court declares that "barking" was undignified and liable to cheapen the business of the neighborhood. The nickel theatre next to C. D. Peacock will be the next to receive attention.

Auctioneers from all over the country opened the second annual convention of the International Auctioneers' association at the Sherman House last week. The principal

# To the Jobbing Trade.



with the "Busy Buyer." If time and money are both objects to you, use our line of Diamond Mounted Jewelry and Mountings when you need set or unset goods. We also make and show the most complete line of Rose, Green, and Rose and Green finish rings.

**Notwithstanding the Spring advance in diamonds, our prices remain the same.**



work of the association will be to ways and means to abolish what the neers call the "license evil"; i. e., the they have to pay in different cities in to hold sales. A resolution was allowing women to become members association.

## Indianapolis.

Edward McNulty, of this city, a Cincinnati, O., last week.

Edward Craft, of the A. P. Cra spent part of last week on the road Mrs. Wilcox, saleswoman for Reed, is spending two weeks in New and Atlantic City.

Mr. Nehf, of the Swope-Nehf J Co., Terre Haute, was in a boat a last week, and sustained severe bn his arms.

Harry J. Reed, son of J. H. Re returned from Cleveland, O., w spent the Winter taking a course struction in engraving and watch w

Harry Camp, Chicago, is head company that is to open a new store Claypool Hotel building here. In ments are now being made in the qu

The County Board of Review has the assessment of the Fidelity W. Diamond Co., 372 Massachusetts Ave \$2,370 to \$5,000. The assessment of F. Craft Co. was left unchanged.

The store of F. L. Bryant, in the son Hotel block, was closed part week because of the death of Mrs. L. Schmidt. Mr. Schmidt conducts tical department in connection wit Bryant store.

Out-of-town jewelers who visit local jobbers and manufacturers last included: J. A. Pickett, New Cast Wheeler, Dana; J. F. Harding, B burg; J. A. Meissen, Cicero; D. S taker, Lebanon, and Aaron Pursel, N ville.

The Hoosier Jewelry Co., 104 N. 1 St., has erected a large Seth Thomas clock in front of its store. The clock feet high, and the dial is illumina night by electricity. It is ornament, attractive. The concern has establish optical department in connection w jewelry store. Ernest Newlin, forme Newlin & Schmelz, 26 S. Illinois St charge of the new department Schmelz will continue the jewelry at tical business alone.

The jewelry and optical store of Cullen, who died recently in the City pital, is now being conducted under t pervision of William Fogarty, admi tor of Mr. Cullen's estate. Mr. Fog an officer of the Citizens Savings Co. Claims of two men, Kane and by name, are now being considered administrator. It is not known wha position will be made of the store, w located in the Traction Terminal bu in N. Illinois St. The stock is nev large. Mr. Cullen had no relatives b the time of his death. The admini is now trying to ascertain the where of Mrs. Cullen. She is thought to returned to St. Louis prior to her hus death. It is thought that the admi tive affairs will finally reach the c courts.

**St. Louis.**

Goldsmith, diamond importer, New Orleans, called on the retail trade here last week.

Ernest White, manager of the J. Bauman & Co. Jewelry Co., who is an enthusiastic golfer, is announced as one of the contestants in the golf tournament for the championship and the Republic cup, which began Saturday morning.

The name of the Langsdorf-Byers Jewelry Co. has been changed to the Langsdorf Jewelry Co. The firm is now occupying the ground floor and basement (6,000 square feet of floor space), formerly occupied by the Gauss-Langenberg Hat Co., at 111 Washington Ave.

Ernest Schmidt, of the material department of the Bauman-Massa Jewelry Co., has returned from Houston, Tex., where he was present at the funeral of his father. Maury Maury, of the same department and firm, has paid a visit to his old home in St. Paul, Minn.

Ernest Freund and family have left for a two months' trip. They will visit Chicago, St. Louis, Philadelphia, Detroit, Baltimore, and will spend three weeks at the City. They will visit their brothers, Jacob Freund, of Buffalo, and Max M. Freund, of Brooklyn, N. Y.

Ernest F. Dailey, of J. F. Dailey & Co., has returned to St. Louis about a week from Chicago, where he has been in charge of the new store of the firm which was opened at the corner of Ralph Wilson, manager of the store, will change places with Mr. Dailey, and go to Chicago, for a time.

Ernest Mauch, president of the Retail Jewelers' Association of Missouri, who is also president of the Public School Patrons' Association of St. Louis, addressed the graduates at the Shepard and Monroe schools recently, presenting certificates to 100 pupils from the two schools, which he represents in St. Louis.

Ernest Bauman, of the Bauman-Massa Jewelry Co., departed Saturday for a vacation to Old Point Comfort, Atlantic City and New York. In New York, July 3, he will meet his father, S. H. Bauman, president of the company, who will arrive on the *Der Wilhelm*, after an extended trip in the diamond markets abroad.

Ernest Woodman King, president of the Mermod, Ward & King Jewelry Co., is a member of the advisory board of the Millen Populace Club, which has just inaugurated a campaign in the interest of St. Louis made in the form of a directory. The club will soon place in every home in St. Louis a complete directory containing every brand and article made or sold by St. Louis firms.

Among the visiting jewelers, who transacted business in St. Louis last week, were the following: August Winkler, Poplar Bluff, Mo.; Jacob Bersche, Waterloo, Ill.; F. S. Brickey, DeSoto, Mo.; J. W. Buchan, Benton, Ill.; W. H. Wheeler, Palmyra, Ill.; Philip Levy, Henderson, Ky.; J. L. Stewart, Albion, Ill.; F. Denizet, Perryville, Mo.; L. A. Bunch, Herrin, Ill.; J. H. Koetting, Ste. Genevieve, Mo.

Elaborate preparations are being made for the outing of the employees of the Mermod, Jaccard & King Jewelry Co., which will take place at Romana Park,

Saturday, June 30. The programme includes an address of welcome by J. C. O'Brien, chairman of the committee, a game of baseball between the married and single men, athletic exercises, 3:45 to 5 o'clock, and music and dancing from 5:30 to 10:30. Handsome prizes will be awarded to the winners of the various events. The officers of the course are: Referee, J. C. O'Brien; clerk of course, N. P. Logan; starter, Charles Stephens; judges, W. A. Boehm, E. C. Eiseman and E. W. Bornmueller.

Incorporation papers have been filed for the United Dry Goods Co., which will be known as the Scruggs, Vandervoort & Barney Dry Goods Co. The new concern's capital is \$5,250,000. The company, which will include the Simmons Co., Georgia-Stinson Furniture Co. and the Scruggs, Vandervoort & Barney Co., is to occupy the \$1,800,000 department store building now being constructed on the west half of the block, bounded by 9th, 10th, Olive and Locust Sts. The building is planned to be ready in 12 months, and the new department store is designed to be one of the largest and most complete establishments of its kind in the United States. The stockholders in the company are: D. R. Calhoun, president of the Ely Walker Dry Goods Co., Hanford Crawford, D. D. Walker, Jr., Robert Johnston, W. E. Georgia, W. E. Morgan, Edward Hidden, G. H. Walker, and J. D. Perry Francis.

**Kansas City.**

The Hassig & Krieke Jewelry Co. has ordered a new furnace and machinery for its plant.

Clem B. Altman left last week for a combined business and pleasure trip to eastern points.

Noble L. Fuller, of the Edwards & Sloane Jewelry Co., has returned from an extended buying trip.

Dr. and Mrs. Lane, of the Southwestern Optical College, spent Saturday and Sunday of last week at Excelsior Springs.

Will Hoefler, a brother of C. C. Hoefler, of the Woodstock-Hoefler Watch & Jewelry Co., has taken a position with that concern.

P. J. Duke, Marceline, Mo., has returned from a visit to his home, and is again at work with the Kansas City Polytechnic Institute.

George Taylor, with the Woodstock-Hoefler Watch & Jewelry Co., has gone down to Excelsior Springs to spend a short vacation.

J. Levin, traveling representative for Kionka & Kionka, has returned from his trip through Kansas, and will soon start out on a new territory.

C. B. Norton, Ward Lewis, J. B. Robinson and Mr. Phillips, all of the C. B. Norton Jewelry Co., went up to Bean Lake last week on a fishing trip.

A. E. Howell, Excelsior Springs, Mo., passed through this city last week on his way to Phoenix, Ariz., where he will take a position in a retail jewelry store.

Charles J. Mount, Jr., of the material department of the Meyer Jewelry Co., is taking a vacation, and will probably be away several weeks, on account of ill health.

E. E. Branch, who has been taking a course with the Kansas City Polytechnic

Institute, has taken a position as watchmaker in the store of S. Swartz, 218 W. 12th St.

George Newman, with the Jaccard Jewelry Corporation, will leave to-day for a two weeks' vacation trip to his old home in Evansville, Ind. He will be accompanied by his wife.

The following out-of-town jewelers visited this market during the past week: S. Freidberg, Topeka, Kans.; Mr. Roder, Higginsville, Mo.; A. D. Ackerman, Fairbury, Nebr.; Mr. Murchison, of Murchison Jewelry Co., Cheyenne, Wyo.; A. Tittle, Choctaw, Ind. T., and B. L. Seybold, McLouth, Kans.

**Denver**

Louis Miller, Laramie, Wyo., was a recent visitor to the city.

S. C. Morgan, Longmont, Colo., was here last week looking up the trade in general.

William Oppenheim, 1231 16th St., has left on a two weeks' trip to Chicago, combining business with pleasure.

M. C. Nester, Alamosa, Colo., paid the city a visit recently, and expressed surprise at the busy atmosphere on 16th St.

S. L. Harrold, of J. C. Bloom & Co., has returned from an extended trip through Illinois and Iowa. He reports that business surpasses that of last year.

J. B. Johnson, Walsenburg, Colo., was in this city last week to attend the graduation exercises of the Walcott School, where his daughter was one of the graduates.

Boyd Park, Salt Lake City, Utah, president of the Boyd Park Jewelry Co., of this city, has returned to the Mormon State after a two weeks' visit to his store in this city.

W. C. Nelson, Omaha, Nebr., has joined the forces of the Johnson Jewelry Co., Colorado Springs. Mr. Nelson is well known as a watchmaker in the west.

A. Rapin, Central City, Colo., and Mr. Bentley, of Bentley & Craig, Boulder, Colo., visited Denver to make purchases last week, and incidentally enjoyed the attractions of the city.

W. W. Hamilton, of W. W. Hamilton & Co., has just returned from a month's sojourn in California. He visited the ruins of San Francisco, but spent most of his time in the southern part of the State.

That Sarah Bernhardt is an ardent lover of jewelry was fully demonstrated on her recent visit to this city. She was here for only a day, but in that short space found ample time to make some extensive purchases. A fine collection of pearls was purchased from Joseph L. Schwartz.

William Fleishman, traveling representative for J. C. Bloom & Co., has not been heard from in five weeks. He left on a business trip through Kansas in the latter part of April, but since has disappeared entirely, much to the annoyance of his employers, who would be glad to get any tidings of him.

A new firm was established here last week under the name of Nesor & McCausland on Stout St., near 18th. Mr. Nesor, who is a manufacturing jeweler, hails from Iowa, while his partner, Mr. McCausland, comes from Providence, R. I. Both have been in business for many years, and are confident of success in the west.

## San Francisco.

A. A. Ritter has opened a store at his residence, at Fulton and Webster Sts.

Mr. Casanova, who was burned out in the fire here, has started a store at Petaluma, Cal.

Carrau & Green, wholesalers, are now located in their new building at 1510 Buchanan St.

Henry M. Abrams, who represents C. Ray Randall & Co., is now located in the Kamm building, and has resumed business.

W. S. Fulton, who represents the Potter & Buffinton Co. and the Roy Watch Case Co. on the Pacific coast, is now in the east.

The Morgan & Allen Co., which now has a temporary office at 1867 Post St., expects to be in its offices in the Kamm building shortly.

M. L. Levy & Co., wholesale jewelers, formerly located at 115 Kearny St., are temporarily located with Voss & Rich Co., 466 13th St., Oakland.

J. Wexel, whose store in the Lick Hotel building was destroyed, is at present entirely out of business, pending the settlement of his insurance.

The Alphonse Judis Co. announces that as soon as its old quarters at 708 Market St are fitted up that it will return from Oakland, where offices have been secured.

Rothschild & Hadenfeldt, formerly at 134 Sutter St., are now at Broadway and 14th St., Oakland, but will return here as soon as suitable accommodations can be secured.

Paul V. Garin, formerly located on Sutter St., is now at 405 14th St., Oakland, where he will remain until conditions in San Francisco assume a more tangible shape.

Nordman Bros. now have several men out on the road, the northern territory being handled by Fred Davis. A. Cantoe is in the southern part of the state, and good orders are being received from both of them.

Julius A. Young, who moved to 1116 Broadway, Oakland, after the fire, has returned to his old stand in the Kamm building here. He reports that he now has a good stock of jewelry on hand and is prepared to fill orders promptly.

Nordman Bros., located before the fire at 134 Sutter St., are now settled in the Kamm building, having just moved from 2505 Clay St., where they had a temporary office. A stock of goods is now arriving, and business is being resumed once more.

M. W. Graves, who represents the Watson & Newel Co., the Pairpoint Corporation and the Chapin & Hollister Co., and who had just moved into the Kamm building at the time of the fire, occupied offices for a time at 1116 Broadway, Oakland, but has returned and fitted up his rooms here, and is now ready for business.

Fred Lezinsky is now at San Mateo, Cal., but has city offices at 2076 Bush St. A. H. Bullion, who was formerly connected with him, has entered business on his own account, and is now in the east to secure some agencies for himself.

A. I. Hall & Sons are now getting settled a little after the fire and confusion. Their Mr. Mathews states that already they have traveling men out on the road, and that highly satisfactory orders are coming

in. So heavy is business, in fact, that goods are going out about as fast as they are being received now. Owing to the fact that safes proved no protection in many cases from fire, they are having heavy vaults constructed in their show rooms. At present they are occupying only the front part of their floor in the Kamm building, the rear of it being badly wrecked, and it will be some months before it can be placed in a condition for use.

## Minneapolis and St. Paul.

Bullard Bros., St. Paul, are making alterations to their store.

C. A. Reed has taken a position with Johansen & Kohl, Minneapolis.

M. Swenson, with Kirchner & Renich, Minneapolis, was married recently.

Wm. Young is a new addition to the working force of the Paegel Jewelry Co., Minneapolis.

The Ryan block, St. Paul, was destroyed by fire Monday. Among the jewelers who lost heavily were: Sischo & Beard, Geo. W. Wooley, C. F. Yager, T. A. Shirley, W. E. Mowrey and Lewis Finkelstein.

Out-of-town jewelers in the Twin Cities recently, were: Mr. Cockburn, of J. T. Cockburn & Co., Drayton, N. D.; Julius Anderson, Mora, Minn.; E. A. Walters, Elmwood, Wis.; D. G. Gallett, Aberdeen, S. Dak.

W. R. Cooper, with S. H. Clausin & Co., Minneapolis, is away on a vacation. B. Clausin, of the Spokane office of this house, is now in the city. Elmer Anderson and B. J. Duntley, traveling representatives, have started on their vacations.

Proceedings in involuntary bankruptcy have been started against the Minneapolis School of Engraving & Watchmaking. The liabilities are about \$1,000. It is understood that arrangements are well under way for reorganizing, and the company will pay up in full.

J. B. Hudson & Son, Minneapolis, have been incorporated, with officers as follows: J. B. Hudson, president and treasurer; W. G. Hudson, vice-president; W. A. Lawhead, secretary. Mr. Lawhead, who has been with the firm for 14 years has been given an interest in the business.

## Pacific Coast Notes.

M. O. Hart, St. Louis, has been visiting the trade in New Mexico.

E. J. Mullin, Los Gatos, Cal., has gone to Eureka, Humboldt Co., on a business trip.

Fred. Lezinsky, a manufacturing jeweler of San Francisco, at present is at Los Angeles, Cal.

H. Rubenkamp, a jeweler and pawnbroker of Stockton, Cal., was swindled last week by a woman who sold him a piece of brass for gold, for which he paid \$10.

After July 1, A. A. Poole, Santa Barbara, Cal., will move to the store now occupied by L. J. Newberry, 1007 State St., Santa Barbara, Cal. This change is made necessary by Mr. Poole's growing trade.

F. M. Washburn, formerly located at 11 N. Fair Oaks Ave., Pasadena, Cal., has removed to new quarters at 388 E. Colorado St. Mr. Washburn has installed new fixtures and greatly added to his stock of jewelry.

Frank Bowman, aged 17, has been arraigned before Justice Chambers on a charge of petty larceny. He was employed by Birnbaum Bros., 457 S. Spring St., Los Angeles, Cal. Although Bowman is thought to have taken jewelry valued at \$200, it is said to have stolen at different times in small amounts, making the charge one of petty larceny.

The Mexican Onyx Co. is to make test case of the demand of the United States government of a duty of \$1.50 cubic foot for sawed onyx. The claim the company is that the duty should be 50 cents, and the case will be fought in the United States court. The basis of the suit will be laid when the next shipment of onyx is landed in San Diego, Cal., Lower California. If the government the suit the company announces that it will erect a plant at Tia Juana, Lower California, one-half of which will be in Mexico and the other half in the United States.

## Cincinnati.

Fox Bros. & Co. are making extensive improvements in their offices.

After July 1 H. J. Greenloh will travel in Arkansas for D. Jacobs & Co.

J. W. Forsinger, Chicago, was a visitor in this city during the past week.

Oscar Keck, of the Herman Keck & Co., is back from a business trip to Chicago.

Hugo Lindenberg, of Lindenberg & Co., has returned from a fishing trip at Geneva, Wis.

Alfred Cook, with Frank C. Taylor, of Isle, Ky., spent a part of last week visiting his parents.

J. W. Thornton and wife, Knox, Tenn., and J. B. Settle and wife, Ellettsville, Ky., were guests of local jewelers last week.

J. V. Thompson, a well-known watchmaker, of Tiffin, O., has become connected with the material business of Joseph J. Mertz.

The G. I. J. Club, composed of the employees of Richter & Phillips, took an annual outing in the way of a trip up the Licking river last week.

The local trade extends its sympathies to Louis Rauch in his bereavement caused by the recent death of his daughter, Neva, aged 12 years.

A. J. Thoma, of Thoma Bros., and his wife have gone on a business trip to New York. Harry Dieters, head maternal of this house, is very happy over the arrival of a baby boy at his house.

The Gustave Fox Co. employees have organized their baseball team, which is stronger than heretofore. Harry Fox, foreman of the factory, is captain, pitcher, and Leonard J. Fox, of the company, is manager and first baseman. The team is now booking games.

Out-of-town dealers who were here during the past week buying stock include: F. W. Bromberg, Birmingham, Ala.; Tiffany, Xenia, O.; R. Kirkwood and W. Scranton, Miss.; A. J. Winters, Paris, P. D. Freeman, Ashland, Ky.; W. F. Roberts, Nicholasville, Ky.; G. W. F. Ansonia, O.; Mr. Bowen, of Bowen & Son, Winchester, Ky.

C. A. Elder has purchased the jewelry business of L. C. Pedersen, in Walnut

## Omaha.

E. Flodman is spending a few days at Chicago Lakes, Minn.

H. Janssen, with the Shook Mfg. Co., just returned from a western trip.

Joseph Hartman, St. Paul, Minn., has in a position with Jacob L. Jacobson, of city.

T. Jones, of the Haigler Drug & Jewelry Co., Hagler, Nebr., was a visitor in city last week.

L. Johnson, Genoa, is rejoicing over arrival of a new baby girl at his home. Axel Holmberg, with S. W. Lindsay, has returned from Chicago, where he spent his vacation.

F. Smith and J. F. Mawhinney, will accompany the Commercial Club on its excursion this week.

Mrs. C. Johnson, mother of Mrs. Jacob L. Johnson, died last week from a paralytic stroke. She was 80 years old.

August Reichenberg, formerly of the Reichenberg-Smith Co., has moved to Chicago, where he will reside in the future.

F. Smith will leave for New York, on the 25. He will make his headquarters at L. & M. Kahn & Co. while in that city.

David Marshall, San Francisco, Cal., whose place of business was destroyed by earthquake, is in this city at present with his brother.

H. Carlson & Co., Auburn, are selling their store in that city. Mr. Ellison will leave shortly for Seattle, Wash., where he will reside permanently.

The following out-of-town jewelers were in this city last week purchasing stock: John Unger, Plymouth; E. J. Long, Eau Claire; Frank Comte, Springfield; G. Smith, Humphrey.

W. E. Burrell, Dr. H. L. Burrell, Geo. W. Burrell and J. F. Mawhinney have incorporated the company being known as W. E. Burrell & Co. A new jewelry store has been opened at Fairbury, Nebr., where W. E. Burrell has assumed the position of general manager.

Jack Jennings, alias "Kid" Clark, who is now in custody for the robbery at M. D. Links jewelry store, has been identified by J. A. Nash, western agent for C., St. P. & N. R. Railway, as the man who helped him to a ruby and diamond scarf pin, valued at \$500, several weeks ago while Mr. Nash was riding home on a street car.

Morris M. Lindsay, son of S. W. Lindsay, was the recipient recently of a beautiful sword, presented to him by the Omaha High School Cadets, Company E, of which young Lindsay was a captain during the year 1905. He has just returned home from Armour School of Technology, Chicago, and will spend the Summer with his parents.

L. Roy Penfold, son of H. J. Penfold, of the H. J. Penfold Co., of this city, died recently in St. Louis, Mo., in an ambulance en route to the city dispensary after taking poison. Letters in his pockets from relatives, written on stationery of H. J. Penfold Co., indicated that the young man had been in financial straits. Mr. and Mrs. Penfold were greatly surprised when told of their son's death, and Mrs. Penfold was prostrated. Young Mr. Penfold was about 27 years of age, and had been employed in St. Louis about two years. A

private funeral was held from the residence in Omaha.

## Canada Notes.

R. R. Dowsley, Prescott, Ont., is about to sell out.

E. L. Weiss, Bancroft, Ont., recently sustained a loss by fire.

The death is announced of D. D. Crue, Summerside, P. E. I.

W. H. Atkinson has succeeded to J. E. Atkinson, Deloraine, Man.

W. J. Markle, Rainy River, Ont., has returned home from a trip to Winnipeg.

C. Clarkson, Cypress River, Man., has assigned to D. A. Clark, Winnipeg, Man.

W. S. Bartley, Russell, Man., has given a chattel mortgage to the P. W. Ellis Co., Ltd., for \$1,047.

Edgar H. Flach, St. Thomas, Ont., has given a renewal chattel mortgage for \$1,000 to Henrietta C. Flach.

Amos Chatfield, Macleod, Alberta, has had judgment given against him for \$100 on behalf of F. W. Law & Co.

The premises of Louis Lemarbre, 3287 Notre Dame St., Montreal, were recently broken into and goods worth several hundred dollars stolen.

John J. McDougall has been found guilty of obtaining money by false pretenses from David Spencer, Montreal. The accused obtained the money by means of a bogus check.

A. C. Anderson, formerly in the wholesale jewelry business in Toronto, and more recently manager for A. Ross & Co., Port Arthur, Ont., has, together with a partner, purchased the jewelry department of the Port Arthur Bazaar Co.

The Grand Jury at the Welland County assizes, June 12, found true bills against the Ontario Silver Co. for applying and selling goods under false trade descriptions, and against George W. Clark, managing director, for conspiring to defraud.

Bell & McCaul's general store, Dominion City, Man., which carries a large stock of jewelry, was broken into recently and a quantity of valuable goods, including watches and jewelry, was stolen. Entrance was secured by breaking a pane in the front window.

Out-of-town buyers visiting Toronto, Ont., last week, included: W. R. Jackson, St. Thomas, Ont.; J. J. Johnson, Attwood, Ont.; R. F. Dale, Harriston, Ont.; John S. Barnard, London, Ont.; W. H. Hopper, Cobourg, Ont., and E. D. Wilcox, Uxbridge, Ont.

Ellis Bros., Toronto, Ont., have moved from 344 Yonge St. into their new store at 108 Yonge St., in the central business section. The establishment is neatly and handsomely fitted up with square projecting window fronts, the lower portion underneath the glass front being ornamented with mosaic work. The design is simple, but very effective.

The rapid growth of Montreal uptown continues, the latest big downtown retailer to move up being M. Cochenthaler. Mr. Cochenthaler was in business on St. James St. for 20 years. The store has been re-decorated after the manner of the Fifth Ave. jewelry stores in New York. Show cases and counters of cherry wood display

the gems, silverware and cut glass on backgrounds of dark blue. Electric light fixtures have been imported from New York. An up-to-date workshop has been installed in which the latest machinery for manufacturing and repairing has been installed.

A daring attempt at robbery was recently made at the store of W. W. Matthews, 558 Main St., Winnipeg, Man. Four stylishly dressed men asked the clerk to show them diamond engagement rings. A large number of valuable stones were submitted for their inspection. After looking at them for some time they left, saying the rings were too expensive. A. Baudry, chief clerk, picked up the tray of rings, and at once noticed that a \$250 diamond ring was missing, a ring with a glass setting having been substituted. He at once rushed out and seized the last man, who was only a few feet away from the store, saying: "I want the diamond you have in your hand." The man made no resistance, and promptly returned to the store, where he dropped the diamond with the remark: "I thought you didn't know diamonds from glass." All four then made off rapidly, and no attempt was made to pursue them. The whole affair passed off so quickly that no one outside the store knew what was happening. The clerk describes the man who took the ring as fine-looking and of prosperous appearance, about 30 years of age, and dressed in light clothes.

## Utica.

Creditors of Otto G. Fasoldt, the bankrupt jeweler in Albany, have elected James E. Earhart as trustee. He has qualified to the court in this city with a bond for \$1,200.

There is no change in the strike situation at the plant of the William A. Rogers, Ltd., in Oneida. The company is operating its plant, and Mr. Jameson, the superintendent, states that the company will not recognize the local silversmiths' union. The latter has issued a statement giving its side of the difference with the company. It is stated a strike was declared because 10 men who had joined the union formed in January were directed to leave it or lose their positions. They refused to leave the union and the strike followed.

Federal process servers have been unable to locate Samuel Orbach, the former jeweler, who disappeared after his bankruptcy case resulted in an order by Judge Ray directing him to turn over property and money aggregating \$16,000 to Charles B. Mason, his trustee in bankruptcy, or show cause why he should not be adjudged in contempt of court. Orbach's lawyers opposed the matter to the last ditch, and then Orbach went to New York and he has not been located since. Judge Holt has continued the orders against Orbach until the court term at Auburn on the second Tuesday in October, and meanwhile the hunt for Orbach will be continued.

John S. Byrd, Reardan, Wash., has been succeeded by L. W. Scheifeins.

J. G. Maurman, Tacoma, Wash., was found unconscious one morning recently at the foot of the Tacoma Eastern Walk, half buried in mud. He was taken to the county hospital in an ambulance. His condition is not serious.

## News Gleanings.

H. L. Tucker, New London, Ia., has sold out.

J. D. White, Santa Cruz, Cal., died recently.

Ernst Nickl, St. Louis, Mo., has sold out to August Banjot.

F. J. Scott has discontinued his business in Parkersburg, Ia.

Fred. Wim. Ansley, Hampton, Va., has discontinued business.

J. R. Lucas, Rockwell City, Ia., has sold out to W. R. Owells.

Charles B. Green, Marion, N. Y., has gone out of business.

Philip Klayman has succeeded E. A. Bailey, Cambridgeport, Mass.

Mat. Bruhy, Kewaskum, Wis., has been succeeded by Mrs. K. Endlich.

Thos. Miller has purchased the store of H. M. Swearingen, Altoona, Kans.

A. H. Callison & Co. are elbasing out their stock of jewelry in Auburn, Nebr.

Julius A. Sommer, Hinsdale, Ill., has been succeeded by Charles Pfeifer.

Mr. Gardner, Verona, N. Dak., is renovating a store for his jewelry business.

Walter Ware, Waverly, N. Y., has made a number of improvements in his store.

Extensive improvements are being made in the store of Arthur Bland, Greenfield, O. Moore Bros., Vandalia, Mo., have dissolved, Harvey E. Moore continuing alone.

Herbert L. Gould, Florence, Mass., has sold out to Walter E. Tetro, Waterbury, Conn.

Spurlock & McMillan, Cushing, Tex., have been succeeded by the Cushing Jewelry Co.

S. M. St. John, Calhoun, Ga., moved recently to Dallas, Ga., where he will continue business.

N. M. Porter, Longton, Kans., has admitted a partner. The firm style is now Porter & Marlow.

The store of S. H. Ledden, Sedan, Kans., has been destroyed by fire. The loss amounted to \$2,500.

C. H. Gros, Cuba, N. Y., will next month move to a larger store on Main St., which will give him more store space.

A. B. Scott, Marietta, O., has purchased the business of C. S. Beard, Fairmont, W. Va. He will take possession about July 1.

Curran Bros., Zanesville, O., are conducting an auction sale prior to making extensive improvements in the interior of their store.

F. P. McCurdy & Son, Buena Vista, Va., are enlarging their store and contemplate installing a soda fountain and a drug department.

Joseph D. Wright, Geary, Okla., has admitted his brother into the business which is being continued under the name of Wright Bros.

Thieves recently broke into the store of Frank Moore, Maquon, Ill., and escaped with \$100 worth of miscellaneous jewelry. There is no clue.

R. L. Leonard, formerly of Union, N. Y., has moved to Endicott, N. Y., where he has erected a one-story building in the center of the business district.

The meeting of the retail jewelers, which will be held in Greensboro, N. C., July 19, for the purpose of perfecting a State organization, promises to be well attended.

The questions to be discussed are of extreme importance to the retail jeweler.

Frederick Davis was recently sentenced to 18 months' imprisonment in the penitentiary at Anamosa, Ia., for breaking and entering John Hunds' jewelry store, Iowa City.

J. F. Hartwell, Oklahoma City, Okla., was recently granted permission to place a large street clock suspended on a post in front of his jewelry store. The clock will be illuminated by electricity at night.

J. J. Lohr, Hooversville, Pa., is at present a patient in the Allegheny Hospital, Allegheny, where he recently underwent an operation. Mr. Lohr expects to be able to return home about the middle of August.

In the large fire which visited Sodus, N. Y., on the 12th inst., Chas. W. Snyder sustained a loss of about \$300, most of his stock having been removed before the fire reached his building.

John W. Ware, Dunkirk, N. Y., has received the appointment of District Deputy Grand Master of the 10th Masonic District of the State of New York, which comprises the entire county of Chautauqua.

John F. Kauffman, who had been employed in the retail jewelry business at Belleville, Pa., for more than 30 years, died recently at his home at that place, aged 58 years. A widow, three sons and one daughter survive him.

Kurt Landenberger, purchasing engineer for the Hamburg-American Clock Co., of Schramburg, Germany, was a recent visitor to Oshkosh, Wis., looking over wood-working machinery which he intends to purchase for the use of the concern in the manufacture of clock cases.

S. J. Cohn, alias Dr. J. H. Boyer, alias J. H. Boyd, is under arrest at Muncie, Ind., on the charge of having obtained money under false pretenses at Eaton, Ind. Cohn posed as an oculist and itinerant vender of eyeglasses. Several charges of fraud have been preferred against him.

C. C. Carr, alias L. Gray, alias C. A. Bruce, and Adolph Beyer were arrested in St. Louis, Mo., while trying to dispose of valuable jewelry which was believed to have been stolen. The men came from Dallas, Tex. Detectives who searched the trunks of the prisoners found a lot of burglars' implements.

Some unique advertising was done a short time ago by Oscar J. Ludwig, a retail jeweler, of Waterloo, Ia., who gave away 1,000 cow bells. The event had been advertised in the local papers, and when the time came a vast throng of men, women and children was lined up in front of the store waiting to receive the odd gift.

Louis Reiter, aged 66, for over 25 years a traveling salesman for a jewelry house, died recently at New Orleans. Mr. Reiter was well known in Pittsburg, where he resided for the past 30 years. He was born in Germany in 1849 and came to America when a child. The funeral services were held Sunday afternoon at Holy Trinity Church, Pittsburg.

While arresting O. Neal and his son, Irwin Neal, one night last week, on a charge of assaulting J. C. Sharer, a jeweler of Alliance, O., Constable Dennis Smeltz, Capt. Harry Oswolt and two assistants were badly bruised in a fight which lasted half an hour. The jeweler had attempted

to pass the men in his automobile, whereupon they assaulted him.

An absent-minded jewelry salesman a satchel with a quantity of diamonds in a Boston, Mass., barroom, last week, for where the barroom was and reported to the police that he had been robbed. That drummer did not lose his property is due to the honesty of a bartender, who, on finding the gems and jewelry, turned them over to the police.

Jewelry valued at \$179 was stolen last week from Jansen & Woodruff, New York, N. Y., who conduct business under the name of "Lyon the Newburg Jeweler." A thief secured the plunder by breaking a plate glass window with a stone. Among the loot are several gold bracelets, six gold filled chain fobs, two gold locket and gold filled lockets. There is no clue to the robber.

Edward Ross, a jeweler and pawnbroker of Connellsville, Pa., was convicted of larceny by bailee, last week. Ross was prosecuted by L. A. Riordon, who alleged that he pawned a \$5 revolver at Riordon's store getting \$1.50 for it. He testified that when he offered the money and the addition of a premium, Ross refused to surrender the revolver to him.

Chas. Smith, Albany, N. Y., and M. Cosman, of Providence, R. I., who were arrested recently, in Manchester, N. H., on a charge of the larceny of three diamond nickel watches from the John B. Van Co., were arraigned before Judge Healy about a week ago, and pleaded not guilty. The case was continued for one week, and the couple were held under bail amounting to \$300 each.

A negro, who gave his name as G. B. Ertson, and who said that his age was 15 years, but who is thought to be several years older, was arrested June 10, in Norfolk, Va., after he had broken into and robbed the jewelry store of N. High, 68 Atlantic St., at that place. Two men who attempted to stop the thief, were attacked with a knife. Three watches which had been taken from the store were recovered at the police station.

In the case of the Equitable Mfg. Co. of Iowa, against H. Bailey Johnston, of Newburg, N. Y., for the recovery of \$110 in jewelry alleged to have been delivered to the defendant, Special County Judge R. recently affirmed the decision of the lower court in favor of Johnston. Johnston claimed that the jewelry had been sold to him on condition that he was to have a certain time in which to pay for it. After the delivery of the jewelry, he alleges, he was called upon to pay at once. The jury decided that there was no cause for action.

After a quarter of a century the mystery of the strange disappearance of W. Dawson, once a wealthy jeweler and prominent resident of Brookville, Ind., has been solved, the jeweler's body having been found in the debris which had filled the cellar underneath what was once the jeweler's store. The skeleton was unearthed, Friday morning, by workmen excavating for a new building. Mr. Dawson is believed to have emigrated from England in 1872. He opened a jewelry store about that time in Brookville, where his business and wealth increased. He was eccentric and reticent and made but few friends.

# Our Traveling Representatives



Among the traveling representatives to visit Buffalo, N. Y., jewelers, last week, were: F. O. Jones, H. I. Judd Co.; W. H. Osborne, R. Wall & Sons' Mfg. Co.; T. E. Delano, Day, Clark & A. J. Parker, Osmun-Parker Mfg. Co.

Newhouse, representing Schultz, Leiss & Co., O. Ketter and Weizenegger Bros., Newark, N. J., was in Denver, Colo., last week. He is on his way to Seattle, Wash., and the Puget Sound territory, after which he will proceed to San Francisco.

The following traveling representatives called on the trade in Kansas City, Mo., during the past week: R. I. Warner, Empire Jewelry Case Co.; J. H. Strassburger's Son & Co.; Mr. Maercker, C. Ray Randall & Co.; Theo. L. Lyons, Gas Gen. Co.; Max Huss, S. & A. Borgzinner. Among the traveling salesmen in Columbus, O., last week, were the following: John W. Case, H. F. Genter & Son, C. L. Hartshorn, Kremenz & F. F. Kitendaugh, Onida Community, Ltd.; H. Remington, Mainichi Bros. & Elliot; L. Donald, Robt. H. Ingersoll & Bro.; Wm. Hamer, Wm. Demuth & Co.; J. L. Gross, Knickerbocker Silver Co.

The following traveling representatives visited the trade in Lancaster, Pa., recently: Henry Hoffa, Lempl & Walker; Ludwig Lehmann; Ernest G. Kremenz & Co.; Albert F. Carter, Sloan & Ferd. Levy, Ferd. Levy & Co.; E. M. Perl, E. & Hochstet; Mr. Halbert, Kohn & Co.; Mr. Weston, Dennison Mfg. Co.; J. W. Henry, J. W. Perry & Co.

The trade at Pittsburg, Pa., was, last week, visited by the following traveling representatives: Mr. McMane, Mandeville, Carrow & Crane; Mr. Ingram, Field & DeWyngeart; Charles T. Dougherty, Liam L. Sexton & Co.; Mr. Somes, Bates & Son; W. J. Parker, Osmun-Parker Mfg. Co.; Robert B. Steele, David Kaiser & Co.; A. J. Sherrod, Enos Richardson & Co.; H. F. Tourtelot, Site, Thresher Co.

Among the traveling representatives who called on the trade in St. Louis, Mo., last week, were: Louis Knoel, Lois Etilinger & Sons; Percy D. Cas, Frank W. Smith Co.; C. B. Bartlett, Whitcomb Mfg. Co.; F. C. Allen, Sansbury & Nellis; Max Huss, S. & A. Borgzinner; I. Price, Louis Gasburger's Son & Co.; Edward E. Allsopp, Ardley, Allsopp & Bloemke Co.; W. S. Willis, Rham Mfg. Co.; J. A. Thompson, J. B. Bowden Co.

Traveling men in Boston, Mass., during the past week, included: H. C. Barnum, Shafer & Douglas; J. John L. Shepherd, Keystone Watch Case Co.; R. Crippen, Philadelphia Watch Case Co.; Mack Townsend, David C. Townsend & Co.; A. L. Shiman, Shiman Bros.; T. G. Frothingham; E. L. Spencer; Harry Lissauer, Jacobson Bros.; Frank Waite, Webster Co.; Alex. Chase; Benjamin F. Bissom, Bippart, Griscom & Osborne; E. Cooper Jones, Jones & Woodland; R. W. Simpson, Riker Bros.

Traveling representatives who visited the Cincinnati, O., trade, last week, included: W. H. Osborne, R. Wallace & Sons Mfg. Co.; Walter S. Rauss, Jacob Strauss & Sons; Wallace E. Welch, J. H. Ohrig & Geiger Co.; Fred J. Foster, Unger Bros.; John Abel and Mr. Buck, Abel Bros. & Co.; W. A. Tiffany, F. H. Sadler & Co.; R. A. Williams, A. C. Messler & Co.; Charles W. Hicoek, Rham Mfg. Co.; I. Rosenberg, I. Rosenberg & Co.; Walter S. Noon, Cory Bros. Co.; A. J. Lantierard, Enos Richardson & Co.; M. J. Lambert, H. Zimmern & Co.; Mr. Sherrill, Sinnock & Terrill.

Among the traveling representatives who called on the trade in Denver, Colo., recently, were: F. Barton, Fontneau & Cook Co.; John S. Cunningham, E. L. Spencer Co.; L. E. Fay, R. F. Mmons Co.; G. H. Howard, Mason, Howard & Co.; O. P. Bliss, Wm. C. Greene Co.; Harry E. Farquharson, E. D. Gilmore & Co. and E. A. Potter & Co.; C. E. Sutton, Flint, Blood & Co.; Mil-

ton Sandfelder, D. F. Briggs Co.; Mr. Kleckner, Theodore W. Foster & Bro. Co.; Mr. Kaufman, Eisenman, Kaiser & Co.

Traveling representatives who called on the trade in Omaha, Neb., during the past week, included: James J. Doll, A. S. Zugsmith; F. R. Horton, Carter, Howe & Co.; Max Huss, S. & A. Borgzinner; W. A. Crocker, Crystalleries De Baccarat; B. Wille, M. Wille; C. M. Newcomb, Maple City Glass Co.; Hubert Somborn, Hupp, Duldheim & Bro.; W. B. Howe, Bradley & Hubbard Mfg. Co.; N. F. Swift, Webster Co.; F. R. Krugler, H. A. Kirby Co.; F. E. Buffum, Bristol Mfg. Co.; E. W. McAlister, Irons & Russell; Izzi W. Lederer, S. & B. Lederer Co.; F. E. Hyatt and Mr. Levy, Philadelphia Watch Case Co.; E. Huebner, E. Huebner & Sons; A. M. Breckenridge, Benj. Allen & Co.; Harry E. Farquharson, E. D. Gilmore & Co.; E. A. Potter, Smith, Keller Jewelry Co.

## News in the Optical Trade.

The Elderson Optical Co. recently began business in Sandusky, O.

B. Milgrom has started in business as an optician at 1616 Atlantic Ave., Atlantic City, N. J.

The optical establishment of W. B. Allen, Marshall, Tex., was badly damaged by fire a short time ago.

The J. J. Boyd Optical Co., York, Pa., recently opened a branch office in the Nutting building, Lebanon, Pa. The concern also contemplates establishing offices in Bloomsburg, Williamsport and Carlisle, Pa.

Phillip Mallay for several years a traveling optician, died Wednesday evening, at his residence, 139 Oklahoma Ave., Youngstown, O., of liver trouble, aged 52 years. The deceased is survived by a widow and several children.

Opticians of Buffalo, N. Y., have signed an agreement whereby they close their places of business on Saturday at 1 o'clock in the afternoon during the months of July and August. The Saturday half holiday season ends Sept. 15.

The Arkansas Optical Society was organized at a recent meeting of the State opticians at the Capitol Hotel, in Little Rock. Thirty opticians from different parts of the State were present. The membership of the society is rapidly increasing.

L. M. Swikerath, of the Swikerath Bros. Optical Co., Denver, Colo., who contracted a cold while on a mining trip in March, which resulted in pneumonia, is now improving, and is expected to resume his interests in the business in a short time.

Recent graduates from the Leader Optical College, Topeka, Kans., are: Miss Helen Williams, E. Stevens, George James, Topeka; Mrs. Margaret H. Farnsworth, Drexel, Mo.; E. E. Stanton, Lusk, Wyo.; Julius M. Sides, Dobyville, Ark.; H. Grant Farmer, Nitaze, Kans.; G. J. Long, College View, Nebr.

Dr. Phillips, recently of San Francisco, Cal., has become connected with C. E. Ford, 1033 16th St., Denver, Col. Dr. Phillips was formerly with the Berkeley Optical Co., which was completely gutted by the fire. He escaped unharmed, and is none the worse for the experience, although he deemed a change of location desirable.

The meeting of the Tennessee Optical Society will be held at the Maxwell House, Nashville, Tenn., July 6 and 7. Among those who will attend are: George R. Callhoun, secretary, Nashville; H. W. Leggett, E. B. Meyer and Herman Lauffer, Memphis; J. E. J-hrke and H. W. Johnson, Chattanooga; W. O. Hoover, Cleveland;

Weakly Ruth, Shelbyville; W. T. Newton and O. C. Wiley, Knoxville; C. L. Andrews, Union City.

The regular meeting of the Rochester Optical Society was held Tuesday evening, of last week, with 15 members present. Chas. Buskirk, Corning, N. Y., Julius L. Miller and E. P. Lenscott, Rochester, applied for membership and their applications were referred to the executive committee. H. M. Bestor, president of the society, suggested that the society have a booth in the Assembly Hall during the convention at Rochester and have representatives to give information to members of the American Society, in regard to the workings of the minimum price list as well as general information to visiting opticians. It was decided that the society wear badges during the convention in order that the members might be distinguished from those of other societies.

## Lancaster, Pa.

L. C. Reisner is home from an extended trip through eastern Pennsylvania, New Jersey and Washington, D. C.

J. M. Kreider, Denver, Pa., has taken the position with W. W. Appel left vacant by the recent sudden death of Edwin L. Snyder.

Among the few out-of-town jewelers in Lancaster lately were C. E. Hinkle, Elizabethtown; J. H. Sensesin, New Holland, and W. J. Frazer, Lincoln.

Oscar M. Lowrie, late of Norfolk, Va., and formerly of the jewelry firm of Keller & Lowrie, Lancaster, has taken a position with E. J. Faust, Allentown.

A Tonopah, Nev., paper received here gives a flattering account of a concert given there recently by James A. Ziegler, jeweler, formerly with John B. Roth, Jr., but now with George F. Blakeslee, Tonopah.

The Homely Camping Club has been organized by Hamilton Watch Co.'s factory employes, with Edward Zahn as president, and the members will camp along the Susquehanna River the first part of July.

Marcus Edelstein, who came to Lancaster a few months ago from New York and opened a jewelry store on N. Queen St., was married last week to Miss Fannie Cohen, daughter of Max B. Cohen, of this city. The ceremony was performed in Philadelphia by Rev. Dr. Leventhal.

William M. Fraker, the railroad engineer who robbed L. C. Reisner on a railroad train, April 11, of a satchel containing jewels worth \$3,500, was sentenced to prison last week in Carlisle for two years. Having been instrumental in restoring some of the stolen property, so that Mr. Reisner is only out \$800, the latter appealed personally to the court for mercy for the prisoner.

H. H. Blase opened a branch store at 64 S. Main St., Wilkesbarre, Pa., about a week ago.

A valuable diamond ring, which was stolen some time ago from James H. Feaster, a jeweler, of Piedmont, W. Va., was recovered recently from Al. Carter, a colored man. Carter had been arrested for the theft, but vigorously protested his innocence until the stone was finally found in his possession.

## ELSIE BEE'S FASHIONS.

NOVELTIES SEEN IN A LADY'S RAMBLES AMONG THE JEWELERS.

HAIR barrettes or slides divide favor with the back comb for keeping unruly locks in order. The handsomest of these are of narrow diamond bands interwoven in some very open loop or scroll patterns.

\*

Some heavy chain bracelets have the top only of elaborate diamond scroll work.

\*

Many new pendants or brooches dispense with the little chains in the use of drop stones.

\*

A diamond buffalo head and a diamond and pearl bee are among rather odd fancies in scarf pins.

\*

A cut glass bucket for cracked ice has a solid silver rim and handle with fancy silver ladle or helper.

\*

Magnificent diamond brooches are mostly in the pendant style with drop stone somewhat closely attached.

\*

Conventional designs of unusual grace and beauty are very much to the fore in choice designs, although natural forms still furnish inspiration for many taking ornaments.

\*

Something new in the line of collar supporters are those finished with diamond studs, where a little diamond spray falls from the upper stud to rest on the lace collar beneath.

\*

A charming little watch in pavé diamond work is inset with a design in green tourmalines, and the same design is carried out on the chatelaine pin to match, which is of fancy triangular shape.

\*

Bracelets will doubtless remain in high favor for some time to come, and one really should have a diversity of styles to keep in touch with fashion as to appropriateness in jewels as well as in dress.

\*

As a variation on the perfectly flat gold mesh purse, some of large size are shown with the top slightly fuller than the flat frame, simulating a gathering which makes the bottom wider than the top of the bag.

\*

A new brooch has a ruby about half an inch in diameter as a central stone, framed in diamonds and set about with a wide border beautifully manipulated in diamonds. The drop stone is a large ruby with a little ornamental cap of diamond leaves.

\*

Very wide gold bracelets are of filigree set with green tourmalines and diamonds or with other colored stones, while heavy, half round bands are ornamented in like manner. The ends of bracelets that do not clasp are finished with dragon, dog or lion head, with half inch space between the ends.

\*

A style shown in some costly brooch designs, where choice stones are employed,

has a single large stone or ornamental form surrounded, as far as may be, by comparatively large open space and enclosed in a band or border of diamonds forming the outline. A charming little pendant of this order is of triangular shape with three large diamonds in three separate openings, across the top, and finished with an ornamental base and a beautiful drop stone without chain.

## Trade Gossip.

Perhaps one of the most novel imported watches now shown is a ring watch, worn on the finger, and resembling a heavy signet in appearance. The rim of gold surrounding the crystal is studded with diamonds, and the movement is one of the smallest made. Klipper Bros., 59 Maiden lane, New York, are the importers of this novel creation.

Bingaman & Co., Cincinnati, O., have designed and made to order a flexible "La Valliere" diamond cross. The centerpiece is entirely flexible, the cross arms being solid. It is entirely an innovation in the way of a cross and is something that has long been desired. Mr. Bingaman is making for himself quite a reputation as a designer in novel goods.

The W. & S. Blackinton Co., North Attleboro, Mass., at a recent meeting of the Board of Directors, decided that in the future the company would cater to the jewelry jobbing trade exclusively. The argument was presented that the retail jewelry trade could be better cared for if the efforts of the concern were centered in their interests entirely.

Bertram Bernard, who was for some time in the collection department of the Jewelers Board of Trade, New York, is distributing among his friends in the trade an interesting booklet containing a compilation of the collection laws of the various States, in convenient and condensed form, published by Adolph M. Schwarz. Mr. Bernard is now managing the Chicago office of Mr. Schwarz at 115 Dearborn St. Those who have not received a copy of the booklet may obtain same by addressing him there or applying at the New York office, 299 Broadway.

The Holtzer-Cabot Electric Co., Brookline, Mass., has recently mailed its customers, and the jewelry trade in general, a comprehensive booklet which deals with many new creations in annunciators and burglar alarms, numbers of which are at present in use throughout the trade. The booklet, known as bulletin No. 150A, contains 21 pages of illustrations of annunciators and safety devices with their cost prices, handsomely arranged. It is the intention of the concern to mail one of these bulletins to any jeweler from whom a request is received.

The magnificent statue of M. W. Baldwin, founder of the famous Baldwin Locomotive Works, who in early life was a manufacturing jeweler, was unveiled in Philadelphia recently. Few people seem to have been aware that Mr. Baldwin's early career was in the jewelry trade, in which line he first displayed his inventive genius. It was while in this business he designed and built an upright engine for himself, after he found

he was unable to buy one in the market. He built his first locomotive in 1832, and laid the foundation of the great works which bear his name. Mr. Baldwin died Sept. 7, 1866.

## A Strange Order.

"SOME men," said a local jeweler yesterday, "have mighty queer notions. The other day, for instance, a man came into my place and said he had a little for me.

"'But first,' he explained, 'I want to know you something: Do you believe that prayers are answered?'

"'Certainly I do,' I declared.

"'Well,' he said, 'maybe you are right and maybe you are wrong. I don't know, but I'd like to, and now—now I want you what I do. When I pray I toss a coin to see whether the prayer will be answered or not. I figure that if it comes down head the prayer will be answered, and if it comes down tail it won't get what I pray for. You see in my way I always get sort of a positive decision one way or another, and that's what's bothering me now. Once in a while I'd like to be left in doubt, you know, and that's why I've come here.

"'What I would like to have you do is to continue, in deadly earnest, 'is to give me some sort of a three-faced coin, a triangular silver block or something, so when I toss it up I won't know what will come down "yes" or "no" or "no-sion."'

"That," went on the jeweler, "struck me as being gambling with a vengeance, and I couldn't make this man see it in that way, and not wanting to be a party to anything that came so near being sacrilegious, I refused him that we couldn't fill his order. He seemed to mind that, but when he went away he declared that he would see what other jeweler could do for him. Queer order of a chap, eh?"—*Newark Evening News*.

## The Sancy Diamond.

WITH regard to the Sancy diamond presented by William Waldorf Astor to his daughter-in-law on the occasion of her wedding, says the *Marquise de Tenin*, it is undoubtedly one of the most famous precious stones in the world. Its history can be traced back for nearly 500 years. In the middle of the 15th century it was worn at the Battle of Nancy by Charles the Bold, Duke of Burgundy, and was found set in his helmet when his body was discovered in a ditch by a Swiss soldier, who, knowing nothing of the value of the stone, sold it for about a shilling to a priest.

Since then the Sancy diamond has passed through many vicissitudes. It has been in the possession of Queen Elizabeth, of King James I., and to Queen Henrietta Maria of England; to Cardinal Mazarin, the celebrated French statesman and prelate, to Queen Marie Leczinska, the consort of Louis XV.; to Queen Marie Antoinette; to the Russian Prince, Anatole Demidoff, and to Jamssetjee Jejeebhoy, the multi-millionaire Parsee philanthropist of Bombay, before coming into the possession of Mr. Astor.



INDEX TO ADVERTISEMENTS.

Lambert & Co.	102	Foster, Theodore W., & Bro. Co.	32	Ohan, G.	102
Loeb & Altsopp	22	Four Track News	100	Ollendorf, L. Co.	25
Mfg. Co. Inside front cover		Freund, Henry, & Bro.	23	Oppenheimer Bros. & Veith	36
N Cuckoo Clock Co.	62	Friedlander, R. L. & M. 71, Outside back cover		Oppenheimer, H. E., & Co.	36
N Gem & Pearl Co.	52	Garreand & Griser	54	Oriental Bank	60
N Platinum Works	96	Gesswein, F. W., Co.	96	Orkin Bros.	28
N Ring Co.	51	Goldsmith, Leo	48	Osmun Parker Mfg. Co.	18
N Silver Co.	31	Goodfriend Bros.	44	Ostby & Barton Co.	15
N William Watch Co.	80	Graban Mfg. Co.	56	Page-Davis Co.	90
Own Mfg Co.	58	Gougelman, Paul	62	Pairpoint Corporation	98
Ross & Co. Outside back cover		Griffoul, August	96	Passmore Gem Co.	52
Rmp & Mfg. Co.	30	Guarillon Trust Co.	60	Patek, Philippe & Co.	88
R. & Son. Outside back cover		Hagstoz, T. B., Ltd.	104	Penfold, Wm. C., Co.	89
Rose & Co.	42	Harris & Harrington. Outside back cover		Percival, D. C., & Co.	54
R. & Co.	46	Hedges, A. J., & Co.	18	Pomfret-Goldy School	103
R. Watch Co.	64	Hedges, Wm. S., & Co.	44	Potter & Bullinton Co.	14
R. Jacob	102	Heintz Bros.	22	Potter Shell Works	62
R. & Co.	26	Heller, L., & Son.	38	Power, Chas. L., & Co.	44
R. & Co.	15	Herpers Bros.	96	Powers & Mayer	13
R. H. & Co.	98	Hirsh & Hyman. Outside back cover		Prior, Charles M.	20
R. & I.	96	Hodenypl & Walker	38	Prybill, P.	104
R. & Eckert Co.	62	Honesdale Decorating Co.	98	Racine, Jules	88
R. S. O., & Co.	4	Hotel St. James	25	Reichhelm, E. P., & Co.	96
R. Chester & Son	42	Howard, E., Clock Co.	88	Renziehausen, W. F., Co.	104
R. W.	102	Hraba, Louis W.	98	Revell, A. H., & Co. Outside back cover	
R. R. & Co.	30	Humphrey, John B.	52	Ries & Armstrong	22
R. W. & S., Co.	17	Hutchison & Huestis	28	Robert, Edmond E.	86
R. & Co.	103	Hilnols Watch Co.	8	Rockford Silver Plate Co.	76
R. Edward	98	Irons & Russell	26	Rockford Watch Co.	69
R. & Virelli	44	Jacot Music Box Co.	103	Roger Williams Silver Co.	22
R. Jewelry Co.	26	Jandheur, F., Jr.	96	Roseman, A.	48
R. J. B., & Co.	16	Jeanne, Frederick A.	48	Rosenfeld, Wm. I.	40
R. Polytechnic Institute.	102	Johnston, W. J., Co.	10, 11	Ross, Saltman & Anderson	31
R. W. Maurice	42	Juergens & Andersen Co.	64	Roy Watch Case Co.	84
R. & Henius Co. Outside back cover		Juergensen, Jules	54	Rudolph & Snedeker	54
R. M. B., & Co.	16	Kahn, L. & M., & Co. Outside back cover		Rumpp, C. F., & Sons	102
R. Sam'l. & Co.	20	Kassel, Abe	62	Sadler, F. H., Co.	29
R. & Pymeyer Co.	50	Keck, Herman, Mfg. Co.	64	Saunders, Meurer & Co.	44
R. C. H., Co.	27	Kent & Woodland	19	Schiff, M.	18
R. Jewlery Co.	50	Ketcham & Melbougall	90	Schultz, Leiss & Co.	21
R. & Co.	18	Kohlbusch, Herman, Sr.	102	Sessions Clock Co.	89
R. Howe & Co.	19	Kohn, Alois, & Co.	18	Seymour, Cassius W.	24
R. National Bank	60	Kohn & Co.	23	Shiman Bros. & Co.	66
R. Freres	50	Koshland & Italie Co.	24	Smith, Alfred H., & Co.	36
R. Jewlery Supply Co.	103	Kremenz & Co.	21	Smith, E. H. H., Silver Co.	90
R. & Straight	104	Lackner & Ohl	23	Snow & Westcott	20
R. Diamond Co.	42	Langendorf Watch Co.	86	Sohn & Hyman	52
R. & Forman	22	Larter & Sons	34	Solidarity Watch Case Co.	31
R. S., Co.	20	Lederer, S. & B., Co.	25, 28	Spencer, E. L., Co.	28
R. M.	22	Lee & Sanders	104	State Bank	60
R. & Begnein	30, 58	Leimann Bros.	96	Steiner, Louis	72
R. & Fitzgerald	24	Lelong, L., & Bro. Outside back cover		Stern Bros. & Co. 48, Inside back cover	
R. C.	96	Levy, Robt.	12	Sternau, S., & Co.	12
R. Clark & Co.	19	Lewy & Cohen	26	Stiven, John S.	96
R. Louis J.	29	Libbey Glass Co.	100	Strauss, Ignaz, & Co. Outside back cover	
R. Mfg. Co.	22	Lissauer & Co.	38	Strauss, Jacob, & Sons	48
R. Wms Watch School	102	Loeb, Wm., & Co.	26	Street, Geo. O., & Sons	16
R. and Point Pen Co.	103	Lorsch, Albert, & Co. Outside back cover		Tavaunes Watch Co.	76
R. Heim, Hipp., & Bro.	86	Low, Martin, & Taussig	38	Thomas, Seth, Clock Co.	84
R. J. J.	104	Lowe, Edwin, & Co., Inc.	28	Trenton Watch Co.	84
R. Bagnall & Co.	26	Luthy & Hine	20	Trout, Charles L., & Co.	21
R. C. & Sons	98	Lyons Gem Co.	29	Van Dam, Eduard	54
R. J. C., & Co.	72	Maebert & Reiss	102	Wadsworth Watch Case Co.	6, 7
R. Robt.	16	Maple City Glass Co.	98	Wagner Mfg. Co.	30
R. Leach, Garner Co.	104	Market & Fulton National Bank	60	Waite-Thresher Co.	27
R. & Co.	18	Mathey Bros., Mathez & Co.	102	Washburn, C. Irving	30
R. C. H., Co.	103	Mercantile National Bank	61	Wells, Chester H.	90
R. & Co.	48	Meyerowitz Bros.	7	Wendell & Co.	5
R. National Watch Co.	82	Miller, Fuller & Whiting	72	Western Clock Mfg. Co.	25
R. of Bros. & Co.	25	Moe, Chas.	29	Wheeler, Hayden W., & Co.	36
R. H. Chain Catch	24	Moore & Sons	16	Whiteside & Blank	19
R. X Remedy Co.	90	Mount & Woodhull	46	Whiting & Davis	14
R. Joseph, & Co.	1	Myers, S. F., Co.	28	Whiting Mfg. Co.	9
R. Child & Co.	103	New York Telephone Co.	100	Wightman & Hough Co.	27
R. Jacot, Georges, & Co.	88	Nissen, Ludwig, & Co.	46	Witsenbausen, L.	52
R. W. J., Co.	20	Noel, Rudolph, & Co.	64	Wodiska, Julius	24
R. Co.	100	Nonnenmann, A., & J. Aschenbrenner	103	Wolfshelm & Sachs	100
R. J. W.	89	Noterman, Jos., & Co.	76	Wood, C. F., & Co. Outside back cover	
				Wood, J. R., & Sons	2, 3

Rockford Watches Speak for Themselves.

## Special Notices.

Payable invariably in advance.

Rates 75c. per insertion for notices not exceeding 25 words; additional words, 2c. each.

SITUATIONS WANTED, 1c. a word each insertion; minimum charge, 25c.

Heavy type, 5c. a word; minimum charge, \$1.25. Display cards, \$2.00 per inch.

In all cases, if answers are to be forwarded, 10c. extra to cover postage must be enclosed.

*All answers to advertisements addressed care The Jewelers' Circular-Weekly, should be sent to the New York Office, unless the Chicago Office is specifically mentioned.*

## Situations Wanted.

BY A YOUNG MAN as letter and monogram engraver. "K., 6594," care Jewelers' Circular-Weekly.

SITUATION WANTED by watchmaker, engraver and salesman; A1 reference; fine tools; age 29. Geo. N. Wood, Decatur, Ill.

LADY BOOKKEEPER in a diamond office seeks position; good reference. Address "B. K., 6608," care Jewelers' Circular-Weekly.

BY YOUNG MAN, with two years' experience; best references; in western States; have small tools. A. C. Sharbond, Edgar, Nebr.

WANTED, POSITION by young man to finish trade; 18 months' experience; age 17 years; owns lathe outfit. Clarence R. Lytle, Ravenna, O.

WANTED, at once, by a young man, engraver's position; can do some jewelry repairing. Address "E., 6629," care Jewelers' Circular-Weekly.

WANTED, permanent position by A1 watchmaker; 13 years' experience; best of references. Address "Watchmaker," 1131 E. Jersey St., Elizabeth, N. J.

FIRST CLASS letter and monogram engraver; good experience; open for position at once. Address "C. A. N., 6655," care Jewelers' Circular-Weekly.

YOUNG MAN, letter and monogram engraver, wants position, with opportunity to learn watchmaking. Milton Gebhard, 735 Sansom St., Philadelphia, Pa.

YOUNG MAN (19) would like to finish watchmaking trade; 1½ years' experience; best reference. Address "Y., 6620," care Jewelers' Circular-Weekly.

FIRST CLASS German watchmaker, with complete tools, wishes position; will go anywhere. Address Fred Kronrad, care Dittler, 166 E. 4th St., New York.

A YOUNG MAN, who has been with diamond importers for five years, wishes a good position; best references. "Willing, 6617," care Jewelers' Circular-Weekly.

FIRST CLASS engraver and jeweler wants position with retail store in a good northern city; Great Lakes preferred. Address "C., 6657," care Jewelers' Circular-Weekly.

SALESMAN is open for manufacturer's line, for retail jewelers; New York City and vicinity. Salary or commission basis. "L. N., 6647," care Jewelers' Circular-Weekly.

WANTED, A POSITION as engraver, bookkeeper, cashier and saleslady; good references; terms reasonable. Address "Enquirer, 5877," care Jewelers' Circular-Weekly.

SALESMAN, with eight years' experience, selling department and jewelry stores in east and middle west, is open for a position. "Successful, 6659," care Jewelers' Circular-Weekly.

CLOCKMAKER, 20, married; a hustler and can prove it, wishes to change; Philadelphia and Washington; references. Address "W., 6656," care Jewelers' Circular-Weekly.

YOUNG MAN (18) desires position as stock clerk with manufacturer of gold goods, with chance for advancement, three years' experience. "A., 6650," care Jewelers' Circular-Weekly.

OPTICIAN, jewelry salesman and lens grinder, good appearance; best habits, wishes position with first class firm; best references. Address "A. S., 6575," care Jewelers' Circular-Weekly.

FIRST CLASS WATCHMAKER desires position in New York City; has first class references and is thoroughly competent on fine and complicated work. "City, 6565," care Jewelers' Circular-Weekly.

ENGRAVER, young man, desires position to finish trade; good letterer on flat ware; also have some knowledge of script copper plate engraving; samples on request. "Script, 6642," care Jewelers' Circular-Weekly.

A FIRST CLASS German watchmaker, 28 years old, who speaks some English, desires to obtain a permanent position; preferably in the south; answer, naming compensation. "A. B.," P. O. Box 100, Houston, Tex.

FIRST CLASS WATCHMAKER; 12 years' experience; competent on the most difficult and finest grade of watchwork would like permanent position; best of references. "G., 6601," care Jewelers' Circular-Weekly.

WATCHMAKER, manager of watch department; competent to do fine and complicated work; railroad watches a specialty; take in, deliver work and set prices; is open for engagement. "Veritas, 6646," care Jewelers' Circular-Weekly.

YOUNG LADY, seven years' experience with large manufacturing and diamond house, desires position; thoroughly conversant in all its branches; capable of taking full charge of office. "Capable, 6632," care Jewelers' Circular-Weekly.

YOUNG MAN (18), with four years' experience in retail jewelry business; good clock repairer; little knowledge of watch and jewelry repairing; best references; small salary to start. Address "Alexander, 6615," care Jewelers' Circular-Weekly.

BY YOUNG MAN, 26 years, first class watchmaker, engraver and jewelry repairer; also graduate optician; wants permanent position in central or southern States; tools and best of references furnished. Address E. L. Barnard, Muscatine, Ia.

TRAVELING SALESMAN, with years of experience in the jewelry and optical trade, wants to represent first class jobbing house or manufacturer; A1 reference; south and southwest territory preferred. "Represent, 6630," care Jewelers' Circular-Weekly.

POSITION wanted by a first class watchmaker and salesman; fair engraver; good jeweler and stone setter; competent to take full charge; reliable and experienced; best references; salary, \$18 to \$20 per week. Address "Allen, 6600," care Jewelers' Circular-Weekly.

ENERGETIC retail jewelry salesman and window dresser; 15 years' association with large firms; open for position July 1; can assist in watch work and engraving; salary, \$25 a week; west preferred; satisfactory references. A. Walther, 2508 Stout St., Denver, Colo.

POSITION WANTED in large city, by Sept. 1, by competent watchmaker, jeweler, engraver, salesman and graduate optician; 25 years' experience and thoroughly competent to take entire charge of business if necessary. Address "I. O. O. F., 6626," care Jewelers' Circular-Weekly.

BY YOUNG MAN, 26 years old; A1 watchmaker and engraver; can do jewelry repairing; also graduate optician; desires permanent position in central States; Illinois preferred; can furnish best of references; own tools. Address "Watchmaker," care W. L. Wilkinson, Brooklyn, Iowa.

POSITION WANTED by an experienced diamond man, in wholesale house; has been buyer and traveler in loose goods business for a number of years. Address, "Diamond, 6559," care Jewelers' Circular-Weekly.

ADVERTISING AND CATALOGUE MAN; a thoroughly experienced man; 35 years of age, recently with one of the most prominent and successful houses in the trade is open for engagement. Address, "Cedric," 6616," care Jewelers' Circular-Weekly.

## Side Lines Wanted.

WANTED, good line for New York City, wholesale and department store trade, in connection with plated hollow ware; established office. Address "Hollow Ware, 6612," care Jewelers' Circular-Weekly.

## Help Wanted.

JEWELER AND ENGRAVER; easy work and good salary. Ries & Armstrong, Macon, Ga.

WATCHMAKER and engraver; permanent position to good man. Rundback Bros., 2196 Ave., New York.

AT ONCE, a good engraver, clock and jewelry repairer; steady position to a good man. Address "J., 6367," care Jewelers' Circular-Weekly.

ENGRAVER for letter and monogram work in first class retail jewelry store; permanent position. C. Preusser Jewelry Co., Milwaukee.

WANTED, a jewelry manufacturer and repairer; permanent position for right man. Address Kleitz & Bro., 615 Market St., Wilmington.

STONE SETTER, jewelry repairer and engraver; state wages; send references and sample graving in first letter. J. S. Pfeiffer, P. O. Kans.

WANTED, first class watchmaker, also jeweler, who could manage shop; or will sell on trial. H. Terheyden, 530 Smithfield St.,burg, Pa.

A GOOD COLORER to take charge of jewelry department; competent to make his own designs. Address "Colorer, 6662," care Jewelers' Circular-Weekly.

WANTED, a young lady who has had some experience in a jewelry factory, to take charge of account. Address "C. H., 6654," care Jewelers' Circular-Weekly.

WANTED, AT ONCE, a watchmaker and engraver; permanent position for a good man; send reference with application. J. W. Mt. Sterling, Ky.

WANTED, second watchmaker and repairer; salary, \$15 per week; steady position; send photograph and reference. Address Box Charleston, W. Va.

YOUNG MAN to do clock work, jewelry repairing, salesman, etc.; state experience and expected in first letter. "R., 6631," care Jewelers' Circular-Weekly.

WANTED, a good watchmaker and engraver to assist with selling in our jewelry department; give full references and state salary wanted. B. Loveman Co., Chattanooga, Tenn.

WANTED, a watchmaker, one who can engrave; good salary; permanent position; have good references. Address S. P. Selig, Raymond Building, Baton Rouge, La.

WANTED, competent man to take charge of department in our State St. store; state experience, age, salary and references. Lewy Co., State and Adams Sts., Chicago Ill.

WANTED, young man with five or six years' experience in manufacturing jewelry shop; be good jobber and be able to do some work. Address E. C. Harpstrite, Wichita, Kans.

WATCHMAKER and engraver, at once; competent man with tools; good references; salary, \$20 per week; at Canton, Miss. Address Richards, Bourne & Co., Greenville, Miss.

WANTED, experienced traveler having done the jewelry trade in central west, liberal tract to A1 man. Western Selling Agency, Omega Watches, Heyworth Bldg., Chicago.

WANTED jeweler and stone setter. Call room 105, 74 Cortlandt St., New York.

WANTED, capable watchmakers who can finish; those with watch factory experience preferred; write application at once, giving experience, etc. Trenton Watch Co., Trenton, N. J.

WANTED, young watchmaker and good engraver; good position; state age, experience salary expected; must have good references. Address Ramsay, 1221 F St., N. W., Washington, D. C.

WANTED, a young lady who can do good letter and monogram engraving and act as saleslady; state wages wanted, experience, and give references. Address "Engraver, 6622," care Jewelers' Circular-Weekly.

WANTED, good watchmaker; must be capable of doing ordinary engraving and waiting on the permanent position to right man. good salary. Address Krauss & Sectors, 45 N. Illinois, Indianapolis, Ind.

**HELP WANTED.—Continued.**

WANTED, a young lady to take charge of mail department in wholesale jewelry line; one thoroughly acquainted with the line; no others need apply. Fred Kaufman & Co., 365 Broadway, New York.

FIRST CLASS ENGRAVER; one who can do all kinds of lettering and monogram engraving; must use a good steady man at a good salary. Apply to A. Newsalt, Jeweler, cor. Fourth and Main Sts., Dayton, O.

BEST CLASS watchmaker and optician wanted; opportunity offered to right party; steady position, in one of the large cities in Pennsylvania; write at once. L. W. Rubenstein, 54 Maiden Lane, New York.

BEST watchmaker and engraver, or engraver Jeweler, must be a fairly good engraver, for permanent position in Ohio. Address A. B. Weaver, Marietta, O., or M. J. Averheek, 19 Maiden Lane, New York.

WANTED, first class diamond, precious and imitation stone salesman for southern and western territory, right position for right man; apply by letter, stating experience. Address "Confidential, 5," care Jewelers' Circular-Weekly.

WANTED, a young man with experience in precious and imitation stone house; must understand shipping and make himself generally useful; must come well recommended. Address "Confidential, 6625," care Jewelers' Circular-Weekly.

WANTED, first class watchmaker and engraver to take charge of watch department; also want first class jobbing jeweler who understands diamond setting; steady work and good pay; single men preferred. R. Van Keuren & Co., Savannah, Ga.

WANTED JEWELER; permanent position; state reference, ability, age and salary in first letter. Wm. Schweigert & Co., Augusta, Ga.

SETTERS WANTED; experienced pearl and doublet setters on gold rings; steady work. Louis Kaufman & Co., 2 Fulton St., New York.

WANTED, a good watchmaker with some knowledge of engraving; a young man of good habits comes well recommended can get a pleasant permanent position with us. Sarton & Kempke, 115 W Commerce St., San Antonio, Tex.

WANTED, young man as salesman and general office position, in wholesale jobbing jewelry use; experience and first class reference necessary; state particulars; confidential. Address "Permanent, 6652," care Jewelers' Circular-Weekly.

WANTED, a first class optician; one who understands edge grinding preferred; steady employment and good wages to the right man; must be well recommended. Address "Central Connecticut, 6640," care Jewelers' Circular-Weekly.

WANTED, WATCHMAKER, engraver and salesman; is there a good all around man ready to accept permanent position in southern New York; hours, 8 to 6; state wages, age, experience, reference, and all particulars, etc. "D., 78," care Jewelers' Circular-Weekly.

WANTED strictly first class watchmaker; permanent position; state experience and ability and give references. Chas. F. Sentz, Columbia, S. C.

WANTED first class watchmaker and salesman; permanent position and good salary; state experience and give references. H. P. Levy, 860 Main St., Hartford, Conn.

WANTED, a good engraver on all general work; set do fine script and monogram work of all kinds; do all hard and soft soldering and general jewelry work, repair clocks and do window painting; don't particularly care for a watchmaker; correspond at once. Austin & Prescott, in St., Batavia, N. Y.

WANTED, strictly first class combination watchmaker, jeweler and engraver; must be expert and well recommended; good salary and permanent position to good man; must be a will-worker, rapid and very thorough; state salary expected and send sample engraving first letter. Jos. Van Auken & Co., 516 Pearl St., Beaumont, Tex.

FIRST CLASS WATCHMAKER, engraver and jeweler; good salesman; some knowledge in optics; must be able to assume full charge at times; permanent position; sample of engraving; full particulars in first letter; save stamps and time if not competent; \$20 per week; own watchmaker's tools. J. W. Campbell, 906 State St., Bowling Green, Ky.

WANTED, young or middle aged man who has some acquaintance with the watch business, who can command from \$4,000 to \$5,000, willing to travel occasionally to Pittsburg, and cities in eastern circuit; to take half interest in a new office of a manufacturing company of well known repute in this city. Address "Opportunity, 6520," care Jewelers' Circular-Weekly.

WANTED WATCHMAKER; Abraham & Straus, Brooklyn, can place in a permanent position at liberal salary a competent man who thoroughly understands watch repairing in all its details. Apply to Superintendent.

WANTED first class letter and monogram engraver; permanent position to the right man; prefer one who can do jewelry repairing; send sample of engraving and references in first letter. Chas. F. Sentz, Columbia, S. C.

SALESMAN acquainted with best trade in New York City and Brooklyn to handle well known and advertised line of mountings as side line, on commission. Address, "Mountings, 6413," care Jewelers' Circular-Weekly.

THIRTY-FIVE DOLLARS (\$35.00), per week for an experienced manufacturing jeweler, engraver and diamond setter, who is capable of taking charge of our shop; permanent position. Address, Albert Pfeifer & Bro., Little Rock, Ark.

SALESMAN for New York City and vicinity, wanted by well known manufacturer of 10k. gold jewelry; sample stock, commission basis; must have acquaintance with jewelry and department stores; no objection to good man representing another line; all replies confidential. "Gold, 6418," care Jewelers' Circular-Weekly.

WANTED BY SEPT. 15, a retail salesman, who is also an optician of ability and an engraver; or assistant watchmaker; must be of good appearance and address; permanent and agreeable opening in a fine store for man who can make good; send references, photograph, and all particulars and sample of engraving. The Rushmer Jewelry Co., 319 North Main St., Pueblo, Colo.

WANTED, AUGUST 1, high grade salesman for well known manufacturer's line of Providence, R. I., territory middle and western states; must have acquaintance with large department stores and leading retailers in large cities; to a young man of good address and who is aggressive and successful, with unexceptional references, a good position is open; state experience, age and salary expected. Address, "Permanent, 6590," care Jewelers' Circular-Weekly.

**Miscellaneous.**

SOMETHING entirely new in the line of window decoration; send five two-cent stamps for sample and postage. Address The Window Exhibitor Co., 74 Cortlandt St., New York.

**Business Opportunities.**

FOR SALE, old established jewelry store, in good railroad town in Mississippi; stock can be reduced to \$5,000 or less. Address "Jay, 6525," care Jewelers' Circular-Weekly.

FOR SALE, a well equipped jewelry manufactory in Providence, R. I., owning valuable patents; reason for selling, other interests; requires about \$5,000. Address "J., 6627," care Jewelers' Circular-Weekly.

FOR SALE, well equipped manufacturing jewelry shop, in rapidly growing western city of 40,000; good machinery; old established place; no competition. Address "F. G., 6651," care Jewelers' Circular-Weekly.

AGENCY WANTED; energetic man; 33; good salesman, practical silversmith and plater, desires agency for plater's supplies or jeweler's galleries in New York and Brooklyn. Address "Agency, 6633," care Jewelers' Circular-Weekly.

PARTNER WANTED, man about 30, who is well acquainted with the jewelry trade and can invest about \$5,000 in an old established manufacturing jewelry concern of A1 reputation. Address "Maiden Lane, 6228," care Jewelers' Circular-Weekly.

FOR SALE, stock and fixtures of old established business in a New Hampshire city of about 25,000 population; owner deceased; price low; only cash considered; store will be let or leased as desired. Address E. J. Johnson, Executor, Nashua, N. H.

\$1,500 BUYS a paying watch repairing and jewelry business; established two years; stock and fixtures new, bought since Jan. 1; best town in the State; just the thing for a hustling young man. Address "Jeweler," 337 South Elm St., Greensboro, N. C.

PARTNER WANTED; I have long lease of a beautiful store; best location in Norfolk, Va., for jewelry and optical business; new, up-to-date fixtures, safe, optical stock and trade; desire a partner with capital or with jewelry stock. Address "A. V.," 524 Colley Ave., Norfolk, Va.

CASH FOR WATCHES and diamonds; send them at once and get your money by return mail. Joseph Brown & Co., Fifth Ave. and Madison St., Chicago, Ill.

FIRST CLASS jewelry store, stock and fixtures; stock will inventory about \$4,000; nice, up-to-date Virginia town 60 miles from Richmond; good run of repair work, with two large colleges; easy competition; reasons for selling, going out of business; wish to close by Sept. 1; population of town, 2,500, with good surrounding country; write for particulars. Address Wm. J. Harris, Blackstone, Va.

PARTNER WANTED; active interest given to party with \$5,000, in established watch business (wholesale district); additional capital desired for the importation of a line of rare watch and clock material; specialties not to be found in any of the material houses; big profits assured. Address "Importer, 6636," care Jewelers' Circular-Weekly.

DO YOU WISH TO RETIRE? We buy jewelry stores to any amount; also entire stocks of jewelry, diamonds, watches, silverware, fixtures, etc.; we are known all over the United States to pay highest spot cash; notify us, we will call on you at once; all business transacted we handle strictly confidential. Address Brooklyn Purchasing Syndicate, 608 Broadway, Brooklyn, N. Y., or Tel. 2328, Williamsburg.

**To Let.**

DESK ROOM or part of office to let. 3 Maiden Lane, Room 53, New York.

TO SUBLET in Prescott Building, 65 Nassau St., New York, exceptionally light and desirable office; windows on three sides; very moderate rental. Apply Room No. 55.

(Special Notices continued on page 72.)

# FANS

Headquarters for the most exclusive line in this country  
SPECIALLY DESIGNED FOR THE FINE JEWELRY TRADE

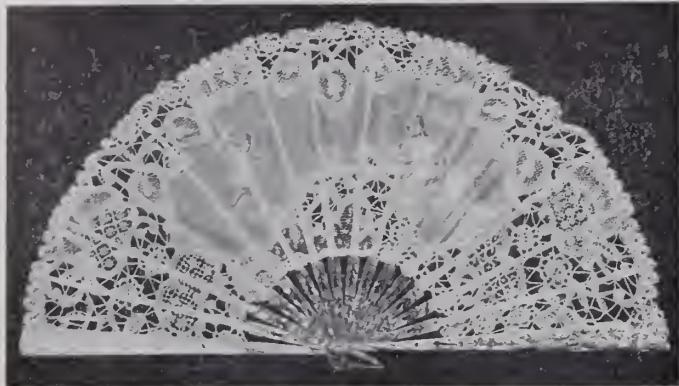

# NECKLACES

Imitation Pearl and Fancy Pearl, in all newest shades and exquisite colorings. Write for Samples, mentioning price

**LOUIS STEINER, Importer, 520 & 522 Broadway NEW YORK**



# COMBS

OUR new line shows many designs, highly artistic and attractive, that will prove rapid sellers.

The highest class of workmanship is characteristic of all our lines.

- |            |                  |
|------------|------------------|
| Combs      | Baby Pins        |
| Brooches   | Crosses          |
| Scarf Pins | Waist Sets       |
| Bracelets  | Hat Pins         |
| Barrettes  | Collarettes      |
| Buttons    | Silver Novelties |



TRADE MARK  
**ALWAYS ON THE GO**

LOOK FOR THE TRADE-MARK

**MILLER, FULLER & WHITING, MANUFACTURING JEWELERS**  
N. Y. Office, 9-11 Maiden Lane NORTH ATTLEBORO, MASS.



## Well Made Quadruple Plate Toilet Ware

Is the most satisfactory to handle if you carry new and up-to-date designs. We are showing an extensive line of the newest goods.

The line that sells easiest and wears longest, is our line.

A heavy quadruple plate on best Britannia metal is our guarantee. Ask your jobber to show you these new creations and send to-day for our new illustrated circular describing these new goods.

Illustration shows No. 814.

**J. C. DOWD & CO., 524 and 528 Broadway NEW YORK**

## Special Notices.

(Continued from page 71.)

### TO LET.—Continued.

TO RENT, in jewelry district of New York City, light office, 8 x 14, as salesroom to jewelry manufacturer or jobber. Call on or address W. H. I. Room 44, 7 Maiden Lane, New York.

TO LET, part of an exceptionally desirable office with fine north light; opportunity for precision stone business or manufacturer's agent. Room 48, Lorsch Bldg., 37 Maiden Lane, New York.

WILL RENT to desirable party, desk and office privileges, in light attractive office, manufacturer's representative or diamond dealer preferred. "Maiden Lane, 6643," care Jeweler's Circular-Weekly.

FOR A MANUFACTURING JEWELER, a desirable new brick building; one or two stories with or without office; power, etc., at high northern light, airy and perfect in every respect; really worth while investigating in any way as well located as Tiffany's in Forest Hill, the next station on the same road; take Greenwood Lake Division, Erie Railroad, to Newark, N. J. Verona Chemical Co., Newark, N. J.

### For Sale.

DIEBOLD burglar proof safe, patent cut-off spindle, inside 24 x 41 inches, outside 37 x 60; perfect condition, \$260. Smith & Delano, New London, Wis.

\$60, MARINE CHRONOMETER; four-inch diameter, made by Lewis Wolf, Liverpool, England; fine condition. Inquire at jewelry store, Sixth Ave., near 48th St., New York.

FOR SALE, at 50 cents on the dollar, 30 velvet trays, plain, to stack, all or part, at Crouch & Fitzgerald telescope, cost \$12, sell \$14 trays, cost 42 cents each, sell 25 cents, us one year. Room 605, 92 William St., New York.

### Wanted to Purchase.

WANTED TO PURCHASE, a chronometer, must be in first class condition and at reasonable price. Address "Z., 6623," care Jeweler's Circular-Weekly.

WANTED TO BUY, at once, an established jewelry business in one of the following States: Missouri, Kansas, Colorado, Texas or Indian Territory; city not to be under 5,000 or 10,000 population. "T., 6599," care Jeweler's Circular-Weekly.

June 16th, 1906.

## IMPORTANT

We beg to notify the trade that A. H. Schutrum is no longer in our employ.

Respectfully,  
**LOUIS KAUFMAN & CO.**

### TO LET.

## Three Desirable Light Loft

At 31 MAIDEN LANE, N. Y.,

One door from Nassau St. Prominent location, center of jewelry district. Address F. J. Whitely, 130 Broadway, New York; or, your own broker.

### Encyclopedia-Dictionary

and reference hand-book of the Ophthalmic Science  
Price, \$2.50.

The Jewelers' Circular Pub. Co., 11 John St., N. Y.

**Philadelphia.**

Paul Bracher is closing out his business as wholesale jeweler at 292 Chestnut St. M. Tucker, watchmaker, with William Sons, 40th and Market Sts., spent a few days last week at Atlantic City, recuperating after a seven weeks' trip through the State.

Fred Barry, of S. O. Bigney & Co., reunited with his family in this city last week.

Anton Reed, a prominent retailer of jewelry in this city last week, attending the Consistory of the Masonic Lodge.

Spoerhase has advised friends in the city of his safe arrival at the homestead in the Fatherland, where he remains until September.

Sickles, of M. Sickles & Sons, has returned from a trip through the eastern States. Louis Sickles, of the same firm, spent a few days last week in New York, getting up his goods.

A prominent silver plater is reported to be soon to remove to a building which he has purchased and which he will fit up for his trade in general on Sansom St., between 5th and 6th Sts.

The jewelers in town during the week included: John Merz, Hopewell, N. J.; S. Kratz, Souderton; D. H. Krause, Philadelphia; F. Gilpin Massey, Wilmington, Del.; J. W. Parrish, Newark, Del.

Another baseball game was played between nine representing wholesale jewelers in this city last week when on Saturday teams were sent from the employes of I. Bedich & Co., played the M. Sickles & Sons.

Joseph Fussman, watchmaker, formerly of the Philadelphia Watch Case Co.'s factory, Riverside, N. J., opened a store of his own last week at 118 W. Main St., in Westtown, N. J. He has made the new store attractive in many ways and a prosperous career is looked for from him by the Philadelphia trade.

Robert Russell, who is associated in the management of M. Sickles & Sons' jewelry store, is expected to return this week after an extended honeymoon trip. He is married to a Miss Hoeflich recently. Charles Bohrer, of the shipping department of M. Sickles & Sons, was ill all of last week with gastritis.

Following upon a formal application, the State authorities granted Monday a charter for the incorporation of the business of Koshland & Italie as the Koshland & Italie Manufacturing and Wholesale Jewelers of Philadelphia and Chestnut Sts. The incorporators are Charles Koshland, Bernard Italie and George E. Donaldson.

Governor Pennypacker last week assented to the incorporation of the Ford Leather Goods Co. to manufacture among other things jewelry novelties for the trade. The incorporators are John E. Kleinhorst, Joseph H. Ward, M. R. Ward, J. Deal, Jr., F. K. Miller, Oscar D. Loeb, David Millar, Elmer E. Fricke and Arthur Fricke.

The local trade generally is awaiting with great expectation the summer outing of the Jewelers' Club which is this year to be given June 26 in the nature of a baseball game between Philadelphia and New

York members of the club and to be followed in the evening by a spirited vaudeville entertainment at an athletic club at 11th and Catharine Sts. A large attendance is already assured.

Charged with robbing the J. Castelberg Jewery Co.'s store, 11th and Market Sts., and other stores, of trinkets while pretending to make purchases, two girls were arrested last week. In their possession were found valuable goods apparently taken from other stores. They admitted their guilt, but declared that these are their first offenses. They gave their names as Bessie and Edna Vochell of Wilmington. They are being held pending an investigation by the detective department.

T. Zurbrugg, president of the Keystone Watch Case Co. and the Philadelphia Watch Case Co., was given the privilege last week to elect whether he would pay \$25,000 to a blackmailer, or be killed and have his home dynamited and his entire family killed. He took a chance and is today alive and well, enjoying domestic happiness and business prosperity. It happened this way, according to the most reliable accounts: Mr. Zurbrugg's wife found a letter addressed to her husband on the lawn of their handsome residence at Riverside, N. J. Mrs. Zurbrugg read it with difficulty, for it was little else than a scrawl, but she deciphered this much—that it threatened her husband's life, his business prosperity and everything else which was dear to him. Mr. Zurbrugg laughed when the letter was handed to him by his wife. But Mrs. Zurbrugg became apprehensive. She finally prevailed upon Mr. Zurbrugg to notify the police, believing it the wisest way to prevent harm coming to him. This was done and thus the threatening letter became public property. It is believed that the letter was written by a discharged employe.

**Providence.**

Frank B. Reynolds, well known in jewelry circles, has been named by chairman Fitzsimmons of the Democratic State Central Committee a member of the campaign committee to boom Col. R. H. I. Goddard for United States Senator from Rhode Island.

Among the jewelry buyers in town last week were J. E. Bamburger, of Philadelphia; B. Wolf, St. Paul; T. R. Allen, Denver; H. Cert and M. Bonn, Pittsburg; Goldsmith Bros., Cleveland; Gilbert Friendly, Baltimore; P. Hermes, Chicago; H. T. Poindexter, Kansas City, Mo.

Articles of incorporation of the Brown & Dean Co. have been filed at the office of the Secretary of State. According to the articles the company is formed for the purpose of engaging in the business of refining and for the transaction of such other business as may arise in connection therewith or is incidental thereto. The incorporators are Samuel Brown, Robert W. Dean, and Herbert A. Capron, and the amount of capital stock is \$25,000.

John H. Le Roy, Fairbury, Nebr., has disposed of his interest at that place to Harry J. Engels, formerly of Red Cloud, Nebr.

**Pittsburg.**

**TRADE CONDITIONS.**

A marked improvement in the tone of business has taken place during the last two or three weeks, and a healthy demand for diamonds and the better grade of goods is reported. There has also been a splendid business in presents, as an unusual number of weddings have marked the present month. A number of jewelers also have conducted special discount sales and this has attracted business.

W. S. Bickert, manager for the I. Ollendorff Co., left, Friday night, for New York on a two weeks' vacation.

E. H. Hill and his family will leave in a few days for Europe. Mr. Hill will not return to Pittsburg until September.

E. P. Roberts & Sons are preparing to move into their new building in Fifth Ave., a few doors east of the present establishment.

Henry A. Barrett, whose health has been such that he has not been able to be at the store this year, contemplates taking a trip to Europe.

The following out-of-town merchants last week visited this city: E. A. Bloser, New Kensington; J. Linnenbrink, Rochester; W. H. Hill, Fayette City; Frank Bloser, New Kensington; E. L. Young, Latrobe; J. F. Murphy, Dawson.

Greater Pittsburg is now an accomplished fact, the court having signed the decree Saturday, consolidating the cities of Pittsburg and Allegheny, and the latter now becomes the North Side. An appeal by the anti-annexationists has been taken, which probably will delay actual consolidation for a short time. Some of the Allegheny jewelers were opposed to consolidation, the city voting against it three to one, but Pittsburg voted for it five to one, and as the count was by joint vote, Pittsburg voted Allegheny in with a total of 20,000 majority for consolidation.

A charter was granted Saturday by the State department at Harrisburg, Pa., to E. P. Roberts & Sons, Inc. The paid up capital is \$160,000, with the privilege of increasing the capital to \$200,000. The officers of the company are Steele F. Roberts, president; Elizabeth P. Roberts, vice-president; Charles W. Roberts, secretary and treasurer. The Roberts house is preparing to move into its new store at 233 Fifth Ave., July 1, having spent \$50,000 in placing the building in repair and installing new fixtures. The house is one of the oldest in Pittsburg, enjoys a fine trade and has a high class patronage.

C. Wiley, secretary of the proposed Pennsylvania Retail Jewelers' Association, last week sent out notices to all of the jewelers of the State, announcing the call for the convention to organize the society in this city July 10. Hotel Henry, which will be the headquarters, has announced a rate of \$1.50 a day, European plan. The convention is not expected to be in session more than one day. Mr. Wiley during the last week has received assurances from a number of additional jewelers that they will take part in the movement, and the association from present indications will organize with at least 125 members, and perhaps more. Mr. Wiley requests prompt replies to his circular, so that he can make the necessary arrangements for the entertainment of the visitors.

# R., L. & M. Friedlander

IMPORTERS OF  
**DIAMONDS**

JOBBER IN  
**American Watches**  
**Wholesale Jewelers**

30 Maiden Lane  
NEW YORK CITY

97 Hatton Garden, London, Eng.

---

## SUMMER NOVELTIES

Advance Styles in

### COMBS

We are fully prepared with a large variety of

#### COMBS

GOLD MOUNTINGS, with or without Diamonds, from \$2.00 to \$250.00 each.

GOLD FILLED, with or without Stones, from 75c. to \$4.00 each.

We herewith illustrate a few designs and quote lowest cash prices that speak for themselves. Freshen your stock by sending for some without delay. These goods afford a generous profit to the dealer and make new and pleased customers

No. 5,000	- -	\$1.80
No. 5,001	- -	1.80
No. 5,002	- -	1.80
No. 5,003	- -	1.80
No. 5,004	- -	1.60
No. 5,005	- -	2.40

LESS 6% FOR CASH

No Combs sent on Memorandum



*Our Mr. Richard Friedlander sails to-day on the Oceanic. The DIAMONDS selected by our Mr. Louis Friedlander, who has recently returned, have arrived and are now on sale.*

## New Orleans, La.

onard Krower, the well-known wholesaler, will leave to-day for New York on his usual business trip.

m Cohen, for many years a jeweler on Pdras St., is now seriously ill at the Infirmary.

A. Walter contemplates enlarging his establishment and making it one of the finest in the French quarter of the city.

Goodman, of Leonard Krower, was married yesterday to Miss Celeste Levy, with the firm for many years.

very handsome watch and chain, presented to George Vandervoort, secretary of the bank, by the attaches of the central office, supplied by T. Hausmann & Sons. The watch was ordered especially for the occasion by the firm.

An exceptionally fine display has always been seen in the windows of Coleman E. Adams, where taste of design and arrangement have always predominated. Jos. Lipschitz, with Mr. Adler, is now on a pleasure trip to the northern cities.

Fischel has decided to open a new branch and has given the contract for new premises. The new establishment, which will be one of the handsomest in the city, will be in the heart of the banking district, which has become quite a center for the jewelry trade.

the annual orphans' excursion given on the steamer *St. James* to 1,000 asylum children. J. J. Weinfurter was one of the chief directors, and himself led the children in sports of sports and games. Mr. Weinfurter is on the Board of the St. Joseph's Orphan Asylum.

Tom Ging, a Chinese jeweler and watchmaker, whose place of business was destroyed by fire and earthquake at San Francisco, is in New Orleans, the guest of the late Mr. Wung Wei. Wom saved a few cases of his most valuable wares, but it is not probable that he will open up a shop here, where there are only 700 Chinese.

J. Vorhaben & Bro., 809 Baronne St., are unfortunate in being made the victims of robber schemes quite frequently. Twice within a year have Messrs. Vorhaben been robbed, and on the second occasion they lost over \$1,000 worth of diamonds. Last week a negro boy employed about the place as porter, stole a tray of rings. The thief was captured, however, and sent to jail, and much of the booty was recovered.

O. Thompson, manager of the optical department of Leonard Krower, is in New York on a business trip. J. T. Kirkland, representing the firm in Louisiana, Mississippi, Tennessee and Arkansas, and E. J. Gsias, who covers Alabama, Georgia, Florida and the Carolinas, are now on their vacation, taking in St. Louis, Chicago and New York. William E. Taylor, formerly of Boston, Mass., now in charge of the material department, will leave shortly on a pleasure trip. E. Mangus and V. Wisch, of the firm, will leave to-day on their regular business trips.

The country parishes are responding generously to the appeal of the committee appointed to solicit funds for the silver service to be presented to the battleship *Louisiana*, and already several thousand dollars has been collected. The parishes are favoring the plan of being taxed \$100 each. Local

jewelers are thoroughly alive to the possibility of procuring the contract for furnishing the silver service, and all firms of any note will send in their estimates. A committee on the design has been appointed as follows: Hon. M. Berhman, Mayor of the city; Page M. Baker, T. O. Rapier, R. A. Blakely, Leonard Krower, Sam Weiss and J. T. Dencchaux. Designs are to be submitted to-day, and it is evident that there will be considerable competition.

## North Attleboro.

Artner Chace, of F. S. Gilbert, is home from the west.

George Whiting and Roswell Blackinton are home from a fishing trip to Rainbow Lake, Me.

Donald LeStage, of the H. D. Merritt Co., and G. Cheever Hudson returned Thursday from the west.

Fred Paye was operated upon Thursday at the Emerson Hospital, Boston, for appendicitis. Reports from the hospital say he is steadily improving.

William H. Riley, whose injury was noted in the last issue of THE CIRCULAR-WEEKLY, is now able to be out, although he is still obliged to have the assistance of a crutch.

The factory of G. K. Webster & Co. was struck by lightning during an electrical storm last week. The bolt hit the flagstaff on the shop and broke it in two, but fortunately did no other damage.

Local jewelers are very much pleased with the enactment of the National Stamping Act, and many words of commendation have been given THE CIRCULAR-WEEKLY for draughting the law as well as its aid in helping in the passage of the bill.

## Brockton.

Sanford K. Gurney, of Gurney Bros., has opened a new Summer home at Monument Beach, Mass., for the rest of the season.

Edward Haase, an alleged eye specialist, who was arrested in New Jersey recently after a long and profitable tour through southeastern Massachusetts, was last week sentenced to five months in the House of Correction. The court said a longer sentence was only prevented by his making restitution to some of his dupes.

Attorney H. F. Parker, acting in behalf of Samuel J. Vucker, of Providence, against the Davis Optical Co., Ward and Main Sts., Friday placed a keeper in the store, and since that time John Davis, proprietor, has not been seen, counsel states. Should he not return after the claim of Mr. Vucker for about \$300 is satisfied, it is understood the property in the store will be sold under the usual process. There are no goods in the showcases and windows, and several parties who left articles of value there to be repaired regret that Mr. Davis is not about, that they may receive their goods.

A unique exhibition consisting of father and three juvenile watch repairers at work in the show window in full view of passers-by is to be seen at the store of Cohen Bros., Reading, Pa.

## Attleboro.

Frederick G. Mason, a banker, has succeeded the late Louis J. Lamb, of C. H. Allen & Co., as one of the town's Sinking Fund Commissioners. A tribute was paid Sunday to Mr. Lamb, when all the children of the Universalist Sunday-school, of which he was long superintendent, marched to his grave with flowers.

Mrs. Charles W. Blackinton passed away at her home on N. Main St., Saturday, leaving an aged husband and several sons. Her husband was one of the pioneer jewelry manufacturers in his younger days, and still owns the so-called "old shuttle shop," near his home, which has been the cradle of a score of the most flourishing jewelry concerns of the present day.

The Selectmen of Attleboro last week granted to the Interstate St. Railway Co. the right to operate a trolley freight line through the western part of the town. This will give greatly improved shipping facilities to the manufacturing jewelers of North Attleboro and South Attleboro, both of which sections have long labored under the handicap of having to depend on their shipments being taken several miles over the road in wagons.

Hon. Sidney O. Bigney was accorded a unique distinction last week. As a member of the Governor's Executive Council he attended the celebration of the 250th anniversary of Dorchester, going as the personal representative of Governor Guild. Owing to a slight resemblance he was mistaken for Governor Guild by cheering thousands, and presented with a bouquet by a chosen delegate for that purpose. He bore the part with dignity and explained away the error, promising the flowers should be sent to the Governor.

Few weddings in Attleboro have been more brilliant in their appointments or more happy in their spirit than that last week which made Miss Ethel R. Wolfenden, the bride of Frank E. Guild, formerly a partner in Peacock & Guild, Providence manufacturing jewelers, but now sole owner of the concern. Merry friends frustrated every attempt to start on their honeymoon the night of the wedding, and they were obliged to spend the time until morning at the home of the groom's father, Emmons D. Guild, of the W. H. Wilmarth Co.

Diligent inquiry among the manufacturing jewelers fails to bring to light one who believes he will be directly affected by the joint action of the western jobbers, against all manufacturing houses which sell direct to the retail trade. Only a few of the minor concerns in this town sell to any but jobbers. Several of the Attleboro manufacturers stimulate the sale of their goods after they have reached the retailer through jobbing houses, by prizes for best window displays, by wide advertising and other devices, but few sell their goods to the retailer without an intermediary. Some of the manufacturers of the older generation say they can remember several such movements in the past as that recently made in Chicago, but none recalls any tangible results that ever came from it.

The Dean-Herbert Co., Manchester, N. H., has been succeeded by W. D. Herbert & Co.

# ROCKFORD SILVER PLATE COMPANY ROCKFORD, ILL.

*Only  
Retail  
Jewelers  
Can  
Buy  
It*

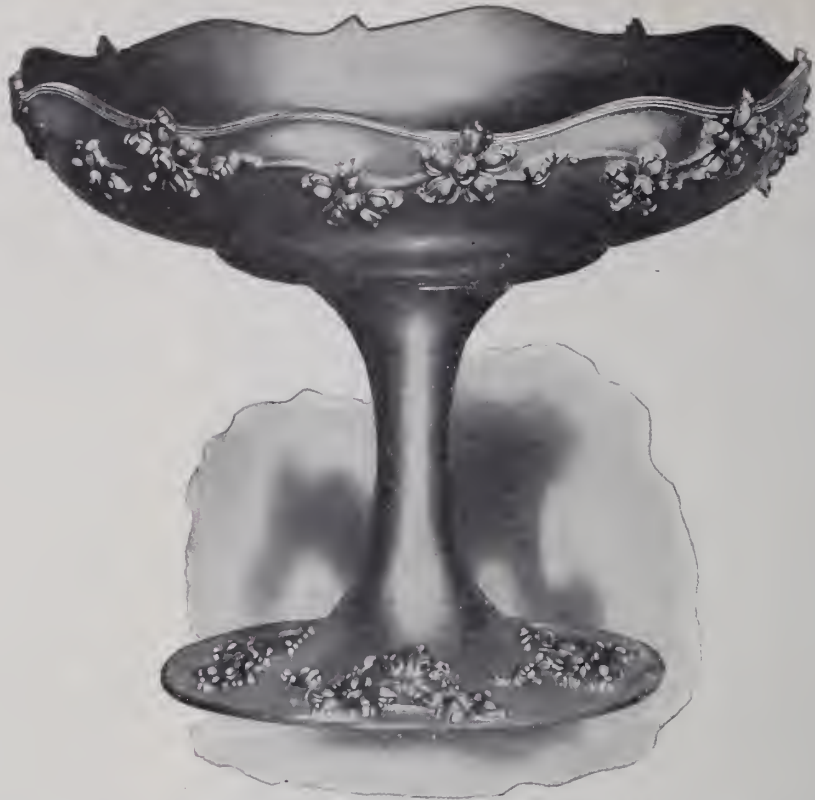

*Rockford  
Silver  
Plate  
Co.  
Made  
It*

Watchword of the Craft—"Stand By Those Who Stand By You"

## JOS. NOTERMAN & CO. DIAMONDS

IMPORTERS AND CUTTERS

Recutting and Repairing odd shaped and chipped stones a specialty. Manufacturers of Mountings and Fine Jewelry. Special Designs Furnished.

CINCINNATI, OHIO.

## QUALITY COUNTS

The Increasing Sale of = = = = TAVANNES WATCHES

Proves their worth as timekeepers

FULLY GUARANTEED

For sale through the jobbing trade

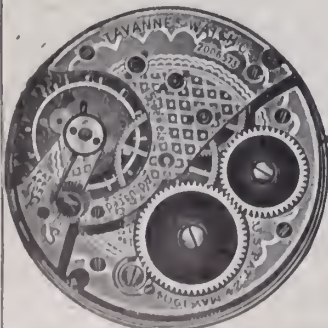

**TAVANNES WATCH CO.,**  
2 & 4 Maiden Lane, New York.



# PATENT DEPARTMENT

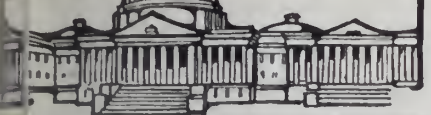

WHICH IS CONTAINED A LIST OF THE LATEST PATENTS GRANTED BY THE UNITED STATES AND GREAT BRITAIN, THE UNITED STATES PATENTS THAT HAVE BEEN AND THE REGISTERED TRADE-MARKS.]

## UNITED STATES PATENTS.

ISSUE OF JUNE 5, 1906.

**822,313. FASTENING DEVICE.** SERIAH STEVENS, Boston, Mass. Filed Dec. 28, 1905. Serial No. 293,602.

a fastening device, a socket member, shank and retaining parts combined therewith, and a pen

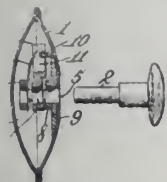

locking-arm the free end of which is disengaged between said restraining parts and provided with diagonally opposite shank-engaging portions.

**822,393. WATCH COVER AND HOLDER.** ALEXANDER L. SHONFIELD, Muncie, Ind. Filed March 7, 1905. Serial No. 248,910.

protector for watches comprising a soft highly-flexible bag adapted to readily conform to the shape of a watch, therein having an opening at one edge for the introduction of the watch and a light-opening in one of its sides of less diameter



to said other opening through which the face of the watch may be seen, a reinforcing-frame bordering the sight-opening and secured to the interior edge of the flexible material of the bag to prevent distortion thereof and enlargement of the sight-opening, and means for closing and maintaining in closed position the opening at the edge of the bag including a two-part hinged reinforcing-frame having oppositely-disposed outwardly-projecting portions to form when the parts are closed together an inclosed opening for the reception of the watch-stem whereby the latter may project through the bag and the watch be held in place independently of the reinforcing-frame of the sight-opening, and means for locking the parts of the last-mentioned reinforcing-frame in said closed position.

**822,555. SPRING BOX-HINGE.** EDWARD L. ROGERS, Boston, Mass. Filed Oct. 24, 1904. Serial No. 224,735.

a box, a body, a lid, a hinge member secured to the body, a complementary hinge part secured

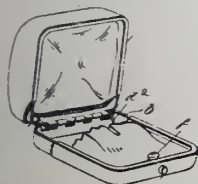

to the lid, and a wire pintle pivotally connecting the parts, said pintle having its two ends bent parallel with each other to present offset portions

to engage the inner wall of the lid and having intermediate of its ends a portion bent laterally in the opposite direction to engage the inner wall of the body of the box whereby when the lid is closed the pin is put under torsional strain.

**822,598. CLOCK.** EDWIN M. GOLDSMITH, Philadelphia, Pa. Filed July 21, 1903. Serial No. 166,432.

A clock, a coin-receiver permanently secured to said clock and having a closed coin-exit aperture closure therefor, a guard movably secured to said coin-receiver and normally obstructing access

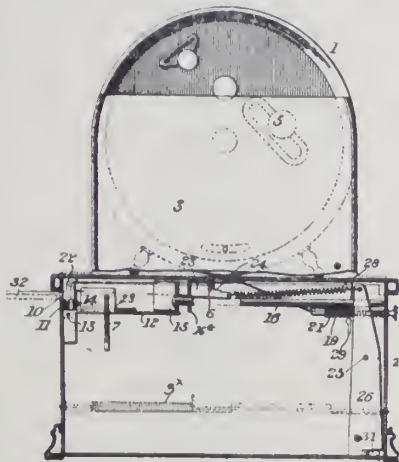

to the winding mechanism of said clock and to the locking means of said closure of said exit-aperture locking means for said closure, and coin-controlled means in said receiver for releasing said guard.

**822,638. SALT-SHAKER.** GUSTAVE J. VESTER, Providence, R. I. Filed Sept. 11, 1905. Serial No. 277,920.

In a salt-shaker, a receptacle, a rod projecting within said receptacle and formed with a threaded lower end, a collar on said rod spaced from said lower end, a box having an opening in its bottom

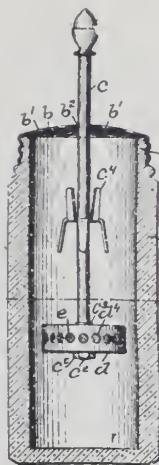

to receive said rod, said box having perforations in its sides, compressible absorbent material in said box, a cover formed with an opening receiving said rod and shutting said collar, and extending within said box to engage said compressible material, and a nut on said threaded end of the rod to engage and support said box and to enable adjustment of the degree of compressibility of said absorbent material.

**822,728. BODKIN.** LEWIS F. EARL, Philadelphia, Pa. Filed Nov. 3, 1905. Serial No. 285,769.

In a device of the character described, a flat body, a flexible tongue movable transversely thereof, said tongue being normally in the same plane

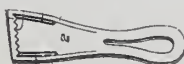

as the body, serrations on the free end of said tongue, a stationary bar forming part of said body and opposing said free end, serrations on the said

bar adapted to co-operate with the serrations on the said tongue.

**822,729. COMBINED BUTTON AND PIN FASTENER.** ROBERT ELLIS, Niagara Falls, N. Y. Filed Nov. 29, 1905. Serial No. 289,651.

A combined button and pin fastener, consisting of a bar having a centrally-located lateral extension, a button on said extension, a lateral extension at each end of the bar, one of said extensions



formed hooked transversely of the bar, a post on the extension at the other end of the bar, the post having an opening formed transversely therethrough located above the bar, and a spring-wire having one end introduced into said opening and coiled around the post, the free end of the wire being pointed and extended adapted to engage the hooked end of the bar.

**822,766. WATCH.** ARNOLD SCHWEIZER-SCHATZMANN, Chaux-de-Fonds, Switzerland. Filed July 28, 1905. Serial No. 271,595.

The combination in a watch having a pendant, of a dial provided with an hour graduation, arranged eccentrically with regard to the watch, a going-train, the seconds-wheel whereof has its axle eccentric to the watch, and outward of the said hour graduation, said dial having an aperture at a point diametrically opposed to that occupied by

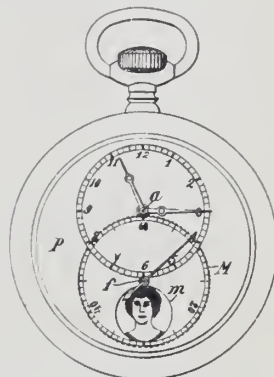

the pendant, and entirely lodged inward of the second graduation, the latter being arranged in a very large circle, a correspondingly long seconds-hand fixed to the axle of the seconds-wheel, a case having a central window at the back, and two internal disks of large diameter, each of said disks provided with a series of views on its outer face and each fixed to the axle of the seconds-hand wheel, the one beneath the watch-dial and the other beneath the back of the watch case, the views of the said disks becoming successively visible, in a continuous manner, respectively through the said dial-aperture and the said case-window, when the watch is going.

**822,806. SPECTACLES.** THOMAS A. WILLSON, Reading, Pa. Filed March 6, 1905. Serial No. 248,415.

A spectacle-temple comprising a temple wire or shaft, and a separately-formed pivot-piece having a pin-engaging ear and a shank portion inclosing said shaft, the extremity of said shaft being projected through said shank portion and shaped to

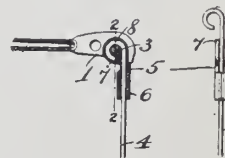

form a stop to turning movement of the pivot-piece thereon.

**822,856. TICKET STAMPING AND DELIVERING MACHINE.** HENRY H. CUMMINGS, Newton, Mass., assignor to Adams D. Clafin, Newton, Mass. Original application filed Feb. 19, 1904. Serial No. 194,334. Divided and this application filed April 15, 1905. Serial No. 255,697.

In a ticket stamping and delivering machine, the

combination of a stamping device provided with rotatable type; a watch-holder on the stamping device and means thereon to detachably secure a

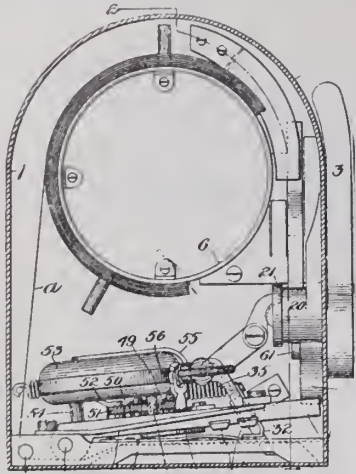

watch, and means, connected with the rotatable type, to engage the hand of the watch, whereby the driving-train between the watch mechanism and type is established.

**822,873. PROCESS OF COATING ONE METAL WITH ANOTHER AND THE RESULTING PRODUCT.** SAMUEL H. THURSTON, Newark, N. J. Filed April 1, 1905. Serial No. 253,260.

The process substantially as herein described of coating one metal with another, which consists in first forcibly beating one metal into and upon the other systematically and continuously until the

particles, or molecules, of the coating metal are driven into the metal being coated and incorporated with the particles at and beneath the surface of the same, thereby forming an adherent and coherent permanent coating irremovably united with the metal being coated, and then forming an electrodeposit of metal upon said coating.

DESIGNS.

**38,048. BADGE.** SUSIE DERRY PARKER, Macon, Ga. Filed March 5, 1906. Serial No. 304,



413. Term of patent 14 years.

**38,049. FOUNTAIN-PEN-HOLDING RECEPTACLE.** FRANK A. WEEKS, Plainfield, N. J. Filed March 10, 1906. Serial No. 305,415.

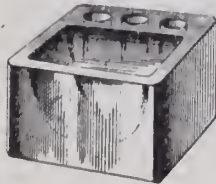

Term of patent 7 years.

**38,051. JUG OR SIMILAR ARTICLE.** CHARLES JOHN NOKE, Stoke-upon-Trent, England, assignor to William S. Pitcairn, New York.



Filed April 16, 1906. Serial No. 312,032. Term of patent 3 1/2 years.

**38,052. JUG OR SIMILAR ARTICLE.** CHARLES

JOHN NOKE, Stoke-upon-Trent, England, assignor to William S. Pitcairn, New York.



Filed April 16, 1906. Serial No. 312,033. Term of patent 3 1/2 years.

**38,053. JUG OR SIMILAR ARTICLE.** CHARLES JOHN NOKE, Stoke-upon-Trent, England, assignor to William S. Pitcairn, New York.



April 16, 1906. Serial No. 312,034. Term of patent 3 1/2 years.

**38,054. JUG OR SIMILAR ARTICLE.** JOHN SLATER, Brown Edge, Stoke-upon-Trent, England, assignor to William S. Pitcairn, New



York. Filed April 16, 1906. Serial No: 312,036. Term of patent 3 1/2 years.

UNITED STATES TRADE-MARKS.

[The following trade-marks have been adjudged entitled to registration under the Act of Feb. 20, 1905, and are published by the Patent Office in compliance with Sec. 6, of said act, which provides: "Any person who believes he would be damaged by the registration of a mark may oppose the same by filing notice of opposition, stating the grounds therefor, in the Patent Office, within 30 days after the publication of the mark sought to be registered, which said notice of opposition shall be verified by the person filing the same before one of the officers mentioned in Sec. 2, of this act. If no notice of opposition is filed within said time the Commissioner shall issue a certificate of registration therefor, as hereinafter provided for."]

PUBLISHED JUNE 5, 1906

SER. No. 5,758. SPECTACLE AND EYEGLASS FRAMES AND MOUNTINGS. MERRY OPTICAL Co., Kansas City, Mo. Filed May 15, 1905.

Iridium

The fanciful word "IRIDIUM." SER. No. 15,271. CLOCKS, CLOCK CASES, CLOCK MOVEMENTS, AND PARTS THEREOF, WITH THE EXCLUSION OF WATCHES AND PARTS THEREOF. HAMBURG AMERIKANISCHE UHRENFABRIK, Schram-



berg, Germany. Filed Dec. 8, 1905. The representation of two feathered arrows, an-

gularly crossing one another and pointing upwardly.

SER. No. 16,079. OPERA-GLASSES AND FIELD-GLASSES. SUSSFELD, LORSCH & Co. New York. Filed Sept. 21, 1903. Us 1 years.

Jena Glass

The words "JENA GLASS."

SER. No. 16,080. OPERA-GLASSES FIELD-GLASSES. SUSSFELD, LORSCH & Co. New York. Filed Sept. 21, 1903. Us 1 years.

Jena Special Glass

The words "JENA SPECIAL GLASS."

TRADE-MARKS REGISTERED JUNE 5, 1906.

**53,379. ALARM-CLOCKS.** THE WESTERN MFG. Co., La Salle, Ill.

The word "STRENUOUS."

Filed Nov. 9, 1905. Serial No. 14,443. Published April 10, 1906.

**53,382. AMERICAN TURQUOISES.** MINING Co., New York.

A geometrical ring in intaglio. Used in jewelry.

Filed Dec. 23, 1905. Serial No. 15,611. Published April 10, 1906.

**53,386. BROOCHES, SCARF PINS, CUFF-PINS.** KREMENTZ & Co., New York.

A figure having substantially the parts of a figure having a shank, stock, and two arms curving outwardly to each other.

Filed Aug. 26, 1905. Serial No. 12,021. Published April 10, 1906.

**53,526. RINGS.** ANOLPH TANZER, New York.

A representation of two bells between which is arranged a rectangular figure containing the letters "T."

Filed Dec. 28, 1905. Serial No. 15,726. Published April 10, 1906.

UNITED STATES PATENTS THAT HAVE EXPIRED.

[Reported especially for THE JEWELERS' CIRCULAR-WEEKLY by R. W. Bishop, Patent Attorney, Washington, D. C.]

Issued June 11, 1889.

**404,870. POCKET-KNIFE.** J. C. F. SCHMIDT, Moline, Ill.

**404,906. ELECTRIC ALARM-CLOCK.** W. HADLOCK, Wenham, Mass.

**404,910. THIMBLE.** CHARLES HORNOR III, England.

**404,937. WATCHMAKER'S TOOL.** A. THOMPSON, Adel, Ia.

**404,956. FINGER-RING.** L. L. BURTON, Providence, R. I.

**404,979. POCKET-BOOK FRAME.** ERNST DENBUSCH, New York, assignor to J. Schimper & Co., same place.

**404,997. PENDULUM.** JOSEPH WERNER, Eden, Germany, assignor to Arthur Debusch, same place.

**450,004. KEY FOR TIME-PIECES.** MAX BOCK, Hazleton, Pa.

**450,033. INKSTAND.** J. J. HOEY, New York.

**450,089. SELF-WINDING CLOCK.** I. GERRY, Brooklyn, N. Y., assignor to the Winding Clock Co., New York.

**450,157. MOUNTING FOR EARRINGS.** VICTOR GENTNER, JR., Buffalo, N. Y.

**450,160. CALENDAR.** C. K. HAMPTON, Brooklyn, N. Y.

**450,206. ELECTRIC ALARM-CLOCK.** BENJAMIN DUBINSKI, St. Louis, Mo., assignor to one-half to C. P. Budd, same place.

Design issued June 7, 1892, for 14 years. **21,612. JAR.** F. M. UNDERHILL, New York,

- ignor to Whittall, Tatum & Co., same place. *Signs issued June 13, 1899, for 7 years.*
- 17. PAPER-CUTTER. O. L. STORY, Somerville, Mass.
- 18. MATCH-BOX. CHARLES DOESCHER, Waterbury, Conn.
- 19. CLOCK-CASE. C. F. MOSMAN, Bridgeport, Conn., assignor to the Jennings Mfg. Co., same place.
- 20. 4 and 30,985. CLOCK-CASE. F. M. JENNINGS and C. F. MOSMAN, Bridgeport, Conn.
- 21. GONG. E. D. ROCKWELL, Providence, R. I., assignor to the Liberty Bell Co., same place. *Signs issued Dec. 9, 1902, for 3 1/2 years.*
- 22. BROOCH. W. C. BOWLEN, Providence, R. I., assignor to the Wightman & Hough Co., same place.
- 23. BUCKLE. A. J. HOULE, Manchester, N. H.

BRITISH PATENTS.

STATEMENTS OF SPECIFICATIONS, 1905, FROM *The Illustrated Official Journal.*

ISSUE OF MAY 30, 1906

- 7. BLOWPIPES FOR SOLDERING, ETC. ADAMS (trading as Burrigge & Co.), Birmingham. Jan. 28. Blowpipe apparatus for soldering and other uses consists of an oil, spirit, or like lamp with a blowpipe attached to it. An oil lamp is provided having a burner *c* with a circular wick *d* and a pointed pin or other implement in-

are formed of stamped metal, such as toilet sets, cabinet furniture, jewelry, clock fronts, and photograph frames. Sheets of contrasting material such as silver and colored celluloid are placed together, the silver one being embossed and perforated so as to expose to view through the perforations the similarly embossed back-plate of celluloid.

- 2,008. CANDELABRA. A. C. GUNTHER, New York, U. S. Feb. 1.

The body *A*, Fig. 2, is made in the form of a cross and is detachably mounted at an angle on a standard *16* by means of a head-plate *14* which engages with two converging slideways *12*. Candlesticks *C* are provided with hollow bottom sections *25*, and their bottom faces have inverted key-

consist of a flat disk and may rest on an annular rib.

*Complete specifications accepted May 23, 1906.*

- 9,781. FOUNTAIN-PEN. WEIDLICH.
- 12,390. TEAPOT. SMITH & SMITH.
- 20,887. SUSPENDERS. JENKINS. 1906.
- 4,991. STUD. KAY. *Applications filed May 14 to May 19, 1906.*
- 11,284. CLOCK. HOWARD WRIGLEY, Liverpool.
- 11,292. SPECTACLES. ALOYS RODENSTOCK, London. *Complete specification.*
- 11,322. CUFF-ADJUSTER. E. K. HEAPS, Sheffield.
- 11,455. SPOON. EMIL MARKS, London.
- 11,489. HAT-FASTENER. ROBERT YOUNG, London.
- 11,635. KEY-RING. A. H. MERRILL, London. *Complete specification.*
- 11,664. SPECTACLES. T. O. WINDSOR, London.
- 11,677. CIGAR CASE. E. L. WARREN, Liverpool.

An Exhibition of Jewelry.

DESIGNING jewelry, as it has been carried on by the professional designers, was in great need of some revolutionary stroke, to cure it of all sorts of chronic ills, and it seems likely to get this turn from amateur competition. The story is like to that of photography, which, under professional handling, was sunk in ruts, and as far as art was concerned, seemed likely to become a byword; but the fearless amateur, rushing in, with nothing to lose, and no precedent to restrain, soon transformed the situation into a most optimistic phase, and we are now obliged, willy nilly, to recognize that there is a man behind the camera, or a woman, and that the personal equation may be made to count in anything.

The exhibition of handwrought jewelry designed by Mrs. May Mott Smith Cunningham, of San Francisco, which has been in progress at the O'Hara & Livermore studios of applied art, 2 Arlington St., Boston, was very well worth seeing, and to the visitor who took the pains to look over the numerous articles with some care it brought conviction of the truth of the postulate above set forth. Mrs. Cunningham has been at this work for five or six years, and has won the unqualified commendation of experts at the St. Louis Exposition of 1904 and at the last Paris Salon, where she exhibited no less than 27 pieces of jewelry.

Her designs are in the mode of the period in which we live, that is to say they are on a rather bold and big scale, as if intended to carry at some little distance, and many of them are distinguished by a sort of barbaric magnificence, which is, we take it, an effect often aimed at in the jewelry of the day. The precious stones utilized, whether of great value intrinsically or not, are employed as the central motifs of harmonizing designs, built up, as it were, around them, so that each gem has the setting which best becomes it.

Mrs. Cunningham's studio in San Francisco was destroyed by the fire, but a number of her jewelry designs rescued from a safe, in a curiously discolored condition, show many curious freaks of the action of heat on metals and gems.—*Boston Transcript.*

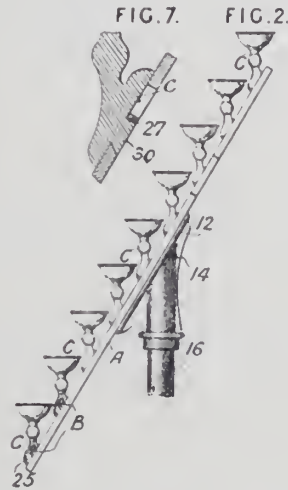

hole slots to engage with headed projections *B* on the face of the cross. Some of the candlesticks can when desired be removed to make space for a figure of Christ. In a modification, the candlesticks are fixed by means of a projecting tongue *30*, Fig. 7, which fits in a slot *c*, the lower part *27* of which is dovetailed.

- 2,145. COFFEE-MAKING APPARATUS. J. S. CAMPBELL, London. Feb. 3.

The apparatus shown in Fig. 1 is used in conjunction with a pot *a*, and consists of a tubular holder *b*, divided into two compartments by a perforated conical partition *d* which is kept in position by frictional contact of the lower ring portion *d*<sup>1</sup> with the holder *b*. A perforated bottom *e* is kept in position by an annular rib *d*<sup>2</sup> and lugs

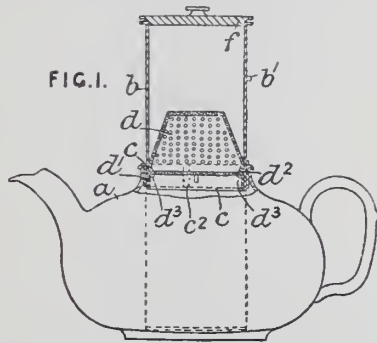

*d*<sup>3</sup>, and it can be removed by rotating it so that notches in its periphery enable it to pass the lugs. The holder *b* fits loosely in a flanged ring *c*, fixed on the top of the pot, and by means of pins *b*<sup>1</sup>, which can be caused either to rest on the flange or to pass through a groove *c*<sup>2</sup> therein, the holder can be retained at various heights. The lid *f* may be doubly flanged so that it fits both pot and infuser. In use, fine coffee is placed above the partition *d*, and coarser coffee, which may be of a different blend, is placed beneath the partition *d* and retained by the bottom *e*. Sufficient hot water is then poured into the holder. By this means, the fine coffee is prevented from stopping percolation and the coarse coffee from rising to the top. In a modification, for a jug, the ring *c* is provided with a hinged flap, which covers the lip during percolation but when the infuser is removed may act as a protector for the thumb. The partition *d* may

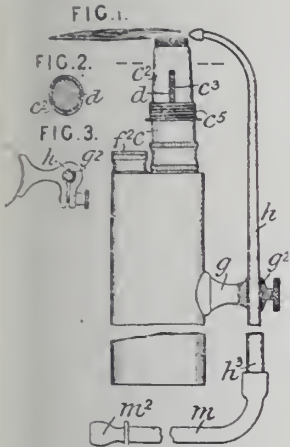

through a slot *c*<sup>2</sup> in a nozzle *c*<sup>2</sup> which can be covered by a screw cap engaging a screw-threaded part *c*<sup>5</sup>. A filling-opening on the reservoir is closed by a screw stopper *f*<sup>2</sup>. The lamp carrier *g* has a bracket *g* having a hole *g*<sup>2</sup> in which the blowpipe *h* can be slid and turned before being secured by the screw arranged on either of the ends as shown in Figs. 1 and 3. A piece of flexible tubing *m* connects the end *h*<sup>3</sup> of the blowpipe with the mouthpiece *m*<sup>2</sup>.

- 11. KEY HOLDERS. H. TUPPEN, New Cross, London, S. E. Jan. 31.

A key holder consists of a plate *a* provided with a notch *b*, and a chain *d*, one end of which is secured to the plate, while the other is fastened to a pin *e* provided with a ball head *f*. The

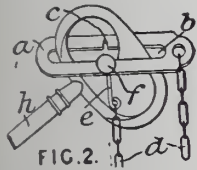

plate *a* is provided with notches *c*, and the slot *b* is smaller in diameter than the ball *f*. In use, the bow of a key *h* is passed through the slot in the notch, while the pin *e* rests in one side notch; when the key is then transferred through the bow of the key to the other side notch. The key will then be secured on the chain.

- 11,1. ORNAMENTS METALWORK. C. M. SMITH, Birmingham. Jan. 31. *Drawings to specification.*

relates to the ornamentation of articles which

# WALTHAM WATCHES

---

We beg to announce the issuing of the following described 16 size movement :

16 SIZE,  $\frac{3}{4}$  PLATE, S. W. MOVEMENTS

LEVER SETTING

OPEN FACE

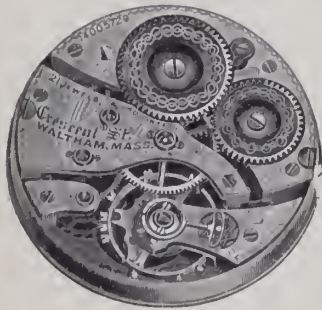

Crescent St., Nickel ;

21 Fine Ruby Jewels; Raised Gold Settings; Jewel Pin Set without Shellac; Double Roller Escapement; Steel Escape Wheel; Exposed Sapphire Pallets; Compensating Balance, Adjusted to Temperature, Isochronism and Five Positions; Patent Breguet Hairspring, Hardened and Tempered in Form; Patent Micrometric Regulator; Tempered Steel Safety Barrel; Exposed Winding Wheels; Double Sunk Dial.

---

AMERICAN WALTHAM WATCH CO.,

WALTHAM. MASS.

# THE HOROLOGICAL REVIEW.



## How Father Knickerbocker Marks *the* Hours

Prominent Clocks That Give the Time to New Yorkers in Manhattan, Brooklyn and the Bronx.

(Continued from issue of June 6.)

### MISCELLANEOUS CLOCKS.

The aim of this series of articles on the clocks of Manhattan doing general pub-  
 service is not an attempt to bewilder THE  
 STAR WEEKLY's readers with a full list  
 of such timepieces. Their bare enumer-  
 ation would fill a large number of pages  
 giving their location alone. The aim is to  
 set only those that come to mind as of

is due to their position and, by implication,  
 should be of interest to the reader.

In order to inject some sort of system  
 into this final enumeration, suppose the  
 start to be made from the extreme North.

St. and Madison Ave. Perched high and  
 overlooking a very wide section of the land-  
 scape is this brewery clock on top of a  
 four story tower. And the tower starts  
 from the roof of the six story building.  
 The great dial sets the time o' day for a big  
 neighborhood and its bell, heard all over  
 Harlem, reminds many thousands that "life  
 is not all beer and skittles," as Dick  
 Swiveller discovered and imparted to the  
 light-hearted generation.

This brings the story down to that chil-  
 dren's play ground Mount Morris Park,  
 with its green sward and wooded hill.  
 Who, of Manhattan's denizens, has not  
 climbed "Mount" Morris and, resting on  
 one of the many seats, has not recalled the



CLOCK IN CATHOLIC PROTECTORY TOWER.



FIRE TOWER, WHOSE BELL NOW RINGS CURFEW IN MT. MORRIS PARK.



CLOCK TOWER AND BELL ON TOP OF JAMES EVERARD'S BREWERY.

mentous value to a very large mass of  
 things, either on account of their location  
 or some other peculiar condition, rendering  
 their service of extreme utility.  
 But, having this selective mission in view,  
 though the series has already carried the  
 reader through nearly every section of this  
 great Cosmopolis, a casual survey of the  
 ground covered lays bare the fact that many  
 out-door timekeepers serving equally large  
 masses of travelers, have been omitted. A  
 final "round-up" of at least a few more of  
 the important ones not already mentioned

In the tower of the Catholic Protectory a  
 most useful instrument for the traveling  
 public adorns the religious edifice. And the  
 Westchester contingent of New York's  
 workers very largely place their faith in the  
 accuracy of this dial.

Traveling southward brings one in sight  
 of James Everard's great brewery on 133d

the historic origin of the bell hanging within  
 the trestled structure. Placed on its ele-  
 vated position when fields separated the  
 dwellers of this part of town, the warning  
 notes of this big bell called citizen volun-

Where  
Time is Money



Every-  
where

that accurate time is valued the Elgin Watch is needed. Every man who requires exact time in the execution of his business is a prospective customer for the dealer who carries

# ELGIN WATCHES

Every Elgin Watch is fully guaranteed against original defect, insuring satisfaction to both buyer and seller.

See Jobber's list for prices, or write the Company.

Every dealer is invited to send for the Elgin Art Booklet, "Timemakers and Timekeepers," illustrating the history and development of the watch.

## ELGIN NATIONAL WATCH CO.

Factories, ELGIN, Illinois, U. S. A.  
General Offices, 131 Wabash Ave., Chicago.

NEW YORK OFFICE,  
11 John St.

SAN FRANCISCO OFFICE,  
206 Kearny St.

Where  
Time is Life



from their home to fight the flames, whenever the watchman on the top of the tower saw, during daylight the tell-tale smoke ascend, or the gleam of conflagration at night. Electric notification to the best disciplined force on earth makes such primitive means of alarm unnecessary. But Mount Morris bell's occupation is, unlike Othello's, not by any means "gone." Former usage is antiquated, its present utility is one of the greatest antiquity consists of ringing the "curfew." At 8 P. M. the tired little tots go out to rest by their nurses. When the mellow notes of that bell give forth the evening hour, adolescent gamblers of a certain degree also leave the open to their infant brethren in trips through the park, and the bushy paths return to solitude.

It is, indeed, to review the evolution brought about such conditions that this clock is erected to warn of fire should warn of the likelihood of bedtime; that these hours of 8 P. M. and 9 P. M. should be the ancient

dials, the hands of each controlled by a secondary electric movement.

The Hotel Netherland's clock, facing the entrance to Central Park, is a temporal guide to the thousands going into and returning from a walk or a drive through the park's serpentine roadways.

Wandering eastward the footsore searcher in quest of outdoor clock knowledge meets with refreshing visions when he reaches 54th St. and Ave. A. The hands of the eight-foot dial in the tower of the big Consumers' Brewery (the clock is by Charles Korflager) here meets his gaze, and being an illuminated dial is accessible, like the amber beverages issuing from the vats within, "any old time" night or day.

Between 4th and 45th Sts., on Eighth Ave., one comes across a sidewalk clock that is much consulted by nearby dwellers.



ILLUMINATED CLOCK IN CONSUMERS' BREWERY TOWER.

few hours coming to Great Britain as an institution from France; the hours when William the Conqueror (1066) enforced by sound of bell the extinguishing of all lights and fires (*couvre feu*—cover fire), curfew is mentioned now the bed-time for babyhood and youth.

On Columbus Ave. and 93d St. the "Elevated" passengers find a useful record of time on the dial in front of the Schumacher jewelry store, a photographic reproduction of which is given herewith.

To people passing downtown on the Sixth and Ninth Ave. elevated railroads the Tiffany clock in the 22d Regiment's armory, on 4th St., affords a very useful dial.

But perhaps the latest and greatest in horological perfection is the beautiful sidewalk clock recently erected by the E. Howard Clock Co. in front of the property of the Northern Trust Co., on 60th St. and 10th Ave. This is a most imposing and decorative timepiece of "marquis" style, and is controlled by a master clock located within the trust company's building. It has four



A CONSPICUOUS CLOCK ON BROADWAY.

It is in front of the jewelry store of Meiners & Schutte.

Truly the life of a sidewalk clock, like that of the policeman's, "is not a happy one," as before stated, especially considering New York's distressing extremes of temperature and the stormy inclemencies that lay siege to the healthful pulsations of the outdoor timepiece. But Aaron Cohn's sidewalk clock on 42d St., between Lexington and Third Aves., sustained a shock which caused its absolute prostration when the disastrous explosion of recent memory took place on that thoroughfare. And the timepiece at present standing on that site is a surgical resuscitation of some of the original members with a predominant blending of new parts in its present renovated condition.

In the "shopping district" section of this series, mention was made of Union Square's denudation on removal of the artistic Tiffany clock, but omission was made in not recording the fact that Jeweler



SCHUMACHER'S STREET CLOCK, COLUMBUS AVE. AND 93D ST.

Frederick Kanter's two-dial timepiece still maintains its ancient guard on the sidewalk in front of 88 Union Square.

Dodging a little eastward again brings to sight a useful clock projecting out from the



CLOCK SEEN FROM FRANKLIN ST. STATION OF SIXTH AVE. "L."

corner of the drug store of Schlesinger & Benninger on Third Ave. and 10th St.

Passing down Broadway one meets a much consulted dial facing Grace Church's

For *BEAUTY* of DESIGN, *PERFECTION* of FINISH and *RELIABILITY* Combined with Moderate Price

# TRENTON WATCHES ARE UNEQUALLED



No. 140. Bridge Model, 16 Size, 15 Jewel, Hunting and Open-Face, Pendant Setting.

A sample line is convincing. They are pendant setting in all sizes, fitting regular pendant setting cases, decorated dials and Louis XV hands.

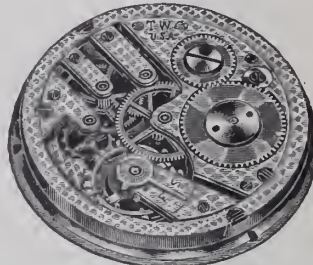

No. 320. Bridge Model, 12 Size, 7 Jewel, Hunting and Open-Face, Pendant Setting.

A NEAT SIGN  
OR ADVERTISING  
BOOKLET FOR  
THE ASKING



No. 100. Bridge Model, O Size, 7 Jewel, Hunting and Open-Face, Pendant Setting.

JOBBER'S SELL  
TRENTONS.

PRICE LIST ON  
APPLICATION.

Manufactured and Guaranteed by

Trenton Watch Co., - Trenton, New Jersey.

## SETH THOMAS CLOCK COMPANY.

Established 1813.

### EMPIRE No. 26.



Metal Case,  
GOLD PLATED  
and Lacquered.  
Beveled Plate Glass  
Front and Sides.  
Height, 14 $\frac{1}{4}$  inches.

EIGHT DAY  
HALF-HOUR STRIKE  
CATHEDRAL BELL  
4-INCH PORCELAIN  
DIAL

List Price, \$42.50

## SETH THOMAS CLOCK COMPANY,

51 Maiden Lane, New York.

70 Wabash Avenue, Chicago.

IF IT'S A

# ROY

TRADE MARK  
IT'S STANDARD



O Size Bassine Engraved  
Cases, made from assayed  
Gold, quality as stamped.

## ROY WATCH CASE COMPANY,



21-23 Maiden Lane  
NEW YORK.

SAN FRANCISCO.  
LONDON, ENG.



city building. And just a little further down town brings one to the characteristic of Berliner, Strauss & Meyer, 737 Broadway. Its dial lettering, N, E, C, K, A, R, attracts attention and creates an interest, which no doubt is the benevolent intent of its owners. The sidewalk opposite 46 Eighth Ave. Schumacher has a timepiece consulted by many pedestrians.

to the commuters going and coming to and from the North river ferries. Taken as a whole Greater New York undoubtedly receives a very liberal allotment of outdoor clocks, but an exception exists, and this in the section containing the densest population. The home of the tenement dweller—the factory toiler—that seething hive of humanity where the proverbial sardine compactness rules in notorious “double-

accurate information as to the hour—the minute—is too painfully clear. Of jewelers and clock repairers this so-called “East Side” section shows no lack. But the dials that hang outside the store are almost all of the soulless effigy variety, whose only movement is the swinging on their hinges as they hang dull-faced from their brackets; the only sound given forth is the rusty creaking of wind action.

Exceptions there are, of course, but usually in the wider thoroughfares or in the churches, several of which have been already mentioned in the section dedicated to those sacred edifices. On Ave. A, for instance, in front of the jewelry store of J. Brüll & Son, near 3d St., stands a sidewalk clock of full standard proportions. And the mechanical arrangement of its movement is worth further notice. Stepping to the rear of the jewelry store you will find the movement in active operation and in full view of the store’s customers under a glass case. And over the doorway, on the outside, you can spy a gong on which every quarter hour is struck. The ingenious arrangement and also the works are from Charles Korfhage’s hands.

But perhaps the meagerness of public time information in this section is best evident in and around Tompkin’s Park. With its throngs of nurse girls and infant charges, the absence of large dials becomes acute when warnings of mealtime and the hour for the sleep of infancy arrives. St. Bridgid’s Church looks patronizingly over the green space, and its two towers, just adapted by location and style for a pair of handsome, truth-telling dials, make a frigid blank appearance for lack of this needed adornment. Visitors to this spacious park, if sans pocket timepiece, have perforce to rely on the little dial of a kitchen clock placed on the blank sidewalk of a drug store, corner of 7th St. and Ave. A, by the aforementioned jeweler, J. Brüll & Son. And that diminutive clock has to do valiant service to an immense crowd of citizens as it looks down ironically from its humble wooden boxing.

It would be a pity to close this horological series without a few words of generalization. In considering the comparative usefulness of these timepieces exposed for the public’s benefit, one has to acknowledge that the later built timepieces, having electric control and synchronous adjustment from the Washington, D. C., meridian, are the ones to which the people’s faith must be pinned. Therefrom we are assured of learning absolutely accurate time. While the church steeple clocks in their hoary age and historic memories engender poetic idealization, this intensely practical body of burghers must be forgiven if they irreverently throw their preferences in favor of Washington Observatory electric connection with the accuracy of old Sol and his regular habits as a daily time adjuster.

A 20th century sidewalk clock synchronized electrically may be “cheap and nasty” when thrown into the ideal scale alongside one of those ancient yet vigorous pendulum regulated steeple clocks that ticked out time to our forefathers when synchronization was not yet invented and the electric current was still an unharnessed giant of the cloud only. But *O tempora, O mores!* we have



LARGE CLOCKS IN THE TOWERS OF THE GRAND CENTRAL STATION.

and even while these notes are being compiled another useful dial is born. In the high office building just erected on the northwest corner of Fulton and Greenwich St. has blossomed out under the hammer and chisel of the sculptor our latest and probably a unique time dial in the corner of the Calkner building. Cut from the material of the structure itself, with its artistically executed ornate stone girdling, this clock must prove from its position a useful factor

decker” habitations—a sad dearth of outdoor clocks becomes conspicuous as reward for one’s searches. And in what class of our social cosmos is the accurate knowledge of time more important than among the factory workers? Long working hours extending to 12 or even 14 per day wins them merely a bare living, and unpunctuality at the workshop spells abuse verbal as well by pecuniary curtailment. To such the necessity of

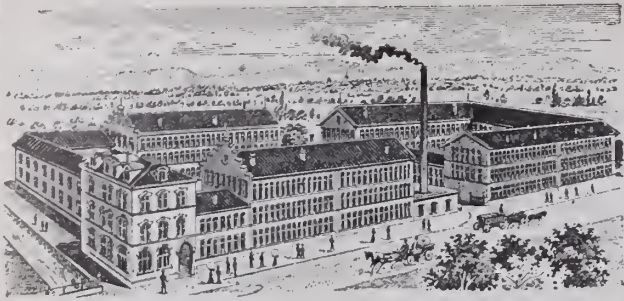

This illustration shows our main factory exactly as it exists, where 3,000 complete watches are made daily.

# LANGENDORF WATCH CO.

CHAUX-DE-FONDS, SWITZERLAND.

It will be of great interest to every jeweler to learn that we are devoting our full attention to this market. The existing conditions in the watch trade have convinced us that there is a long felt want for moderate priced, but accurate Swiss Watches.

We wish to call your attention to our LONVILLE MOVEMENT. It has a lever escapement and is being made in Os, 12s and 16s, fitting perfectly all American cases. This movement is salable and profitable. Our Watches and Movements will be introduced in this market bearing the following names:

- |          |          |
|----------|----------|
| SOLDALE  | HIGHMERE |
| BONDALE  | LONVILLE |
| CLAREFAX | NAMTOC   |
| PEARLHAM | LADY MAY |

SOLE AGENTS FOR UNITED STATES.

**BYRON L. STRASBURGER & CO.,**  
17 Maiden Lane, New York, N. Y.

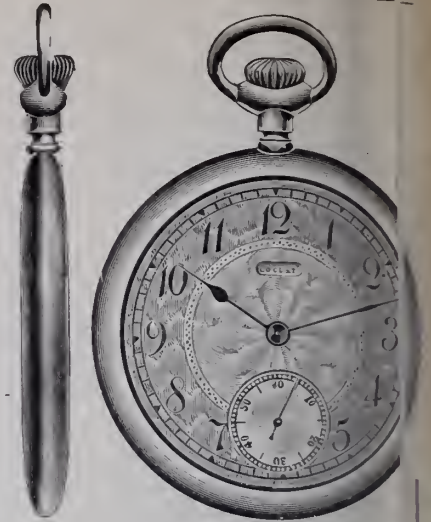

Actual Size.

# LOCUST

Extra Thin Model,

SEVEN JEWEL,  
LEVER,  
PENDANT SET,

CASED IN

## Fahys Bassine 20 Year Filled

Screw Back and Bezel,  
also in  
Silver, Gun Metal  
and  
Solid Nickel Case.

BEST VALUE EVER OFFERED

**TRY THEM.**

WE GUARANTEE EVERY  
LOCUST WATCH.

All Parts Interchangeable.  
Finished Material Always on Hand

IF YOUR JOBBER CANNOT  
SUPPLY YOU,  
**WRITE US.**

**Hipp. Didisheim & Bro.,**

49 Maiden Lane,  
New York.

Chicago Office, - Columbus Bldg.

# Vacheron & Constantin,

GENEVA,  SWITZERLAND.  
TRADE-MARK.

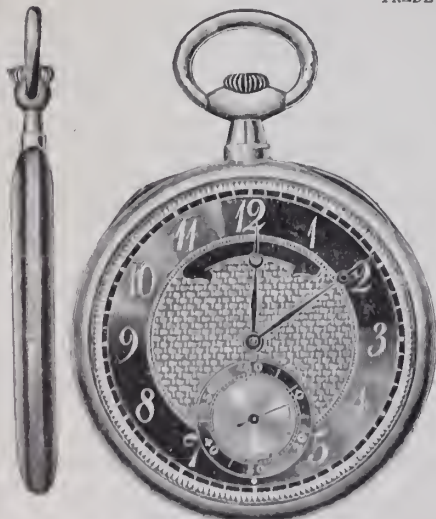

MAKERS OF EVERY VARIETY OF

High-Class  
Adjusted Watches,  
Complicated Watches,  
Extra Flat and  
Ultra Flat Watches,  
Enameled, Carved and  
Jeweled Watches.

**EDMOND E. ROBERT, SOLE AGENT,**

3 MAIDEN LANE,

NEW YORK.

stick on other days, and with the simple li transformed to strenuous struggle for e-ence the city's human units must hush and count out the fleeting minutes like ples of precious gold or drops of life's bod For "time is money," and it is ney alone in the densely crowded city t purchases the wherewithal to keep the h within us, and makes the very heart

to the commuter living north of the city uses the New York Central or its al- lines the first and last of the great ks within the municipal boundary that es each day are those in and on the nd Central Station, 42d St. and Fourth

On arriving in the morning the clocks en strike his eye first are the two big pices at the south end of the receiv- station and just above the center of t is known as the "concourse," and the r away at the top of the extreme south o building.

the homegoing passenger in the after- and evening rushing to the trains that e this great terminal, the clocks in the



CLOCK IN CONCOURSE OF GRAND CENTRAL STATION.

vers of the buildings hold his anxious e until the waiting room is reached. The ost important of these are the two which e the west and south in the tower at the rner of Vanderbilt Ave. and 42d St. By ise the anxious traveler may gauge his e for catching convenient trains for ny blocks away.

In the waiting-room, which is one of the ost beautiful as well as the most commodi- s within the United States, the clock in e easternly wall above the stairs communi- ting with the elevated road, is truly a osure of all eyes, and the beautiful sim- city of its lines and its accurate time- eping qualities merit the important posi- on which it holds with the traveling ble.

[THE END.]

Dummy Clock Hands.

IT seems to be a general impression, says the *Scientific American*, that the exact minute when Lincoln was shot is marked by the hands of every jeweler's sign-watch—an impression which seems to have been given by jewelers themselves.

The baselessness of this yarn, which has gone all over the country, is to be seen at once from the fact that President Lincoln was shot by Booth at about 9 o'clock in

we do not know, unless it was the offspring of some reporter's imagination. It has undoubtedly been kept alive for business as well as sentimental reasons.

A certain dummy-clock maker in New York has obtained considerable advertising on several occasions by telling a story to reporters about a jeweler rushing into his father's place after Lincoln was shot, and asking him to paint the face on the dummy clock he had ordered at 18 minutes past 8 to represent the hour that Lincoln had died;



CLOCK IN WAITING ROOM OF THE GRAND CENTRAL STATION.

the evening, and died about 10 o'clock the following morning. Therefore the clocks do not represent the time of the event. That they were not intended to represent such time is proved by the fact that jewelers' dummy clocks have shown that time since the early part of the century.

All the clocks prior to 1861 did not show that time any more than they do to-day. Some of them show 5 minutes to 1, some 14 minutes to 9 and other positions, but in nearly all the hands are equidistant from the figure 12. As far as 18 minutes after 8 or 18 minutes of 4 is concerned, this is probably used because in this position the hands are most symmetrical, the first being one-third the distance from 12, and the second two-thirds. In this position they leave a long sweep above the imprint of the jeweler's name and address, and do not interfere with the diagram of the seconds' dial when such is used.

How the Lincoln story got into circulation

that his father liked the position of the hands in that way and used it on subsequent clocks, making a stencil from which all markings were done.

The story, as it goes round, in most cases is to the effect that after Lincoln was shot, a meeting of the National Jewelers Association being then in session, the jewelers resolved to perpetuate the time on their signs, and the resolution was adopted to this effect; but inasmuch as there was no National Jewelers Association at that time—in fact, there was no meeting of jewelers of which we have any record—the story is a yarn on its face, even if the proof was not clear that such a position of the hands had been common prior to 1861.

John Collins was taken into custody in Mobile, Ala., a short time ago, on a charge of larceny preferred against him by H. G. Sandoz, of the E. O. Zadek Jewelry Co., of that place.



# ZENITH

## MOVEMENTS

Give the

**RIGHT TIME  
EVERY TIME  
For a LIFE TIME**

**Grand Prize, Paris Exposition, 1900**

Made in O size, 12 size, 16 size, all grades  
Hunting or Open Face, Pendant Set

INTRODUCED FOR THE FIRST TIME IN AMERICA, THOUGH ONE OF  
THE BEST KNOWN WATCHES IN EUROPE FOR GENERATIONS

Manufactured by

**GEORGES FAVRE-JACOT & CO., Locle, Switzerland**

HIPP. DIDISHEIM & BRO., Sole Agents, { 49 MAIDEN LANE, NEW YORK.  
COLUMBUS BUILDING, CHICAGO.

## The Lady Racine

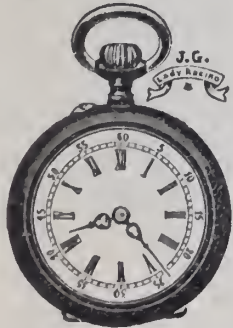

Positively the BEST  
chatelaine watch in  
the market.

**Machine Made**

10, 11, 12 and 13 Line; Cylinders  
and Levers; cased in Nickel, Gun  
Metal, Silver and Gold.

**Material on Hand.**

Write for prices.

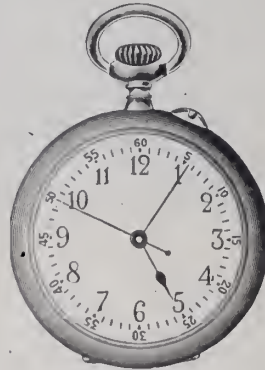

Lady Racine  
Nurse Watch.

**JULES RACINE & CO.,**  
103 STATE ST., CHICAGO. SOLE AGENTS 37 MAIDEN LANE NEW YORK.

For Sale by all Jobbers

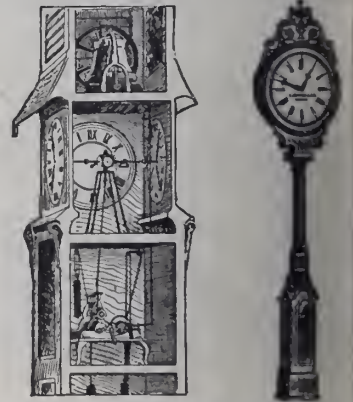

MAKERS OF  
**Tower and Street Clock**

For particulars write us, mentioning The Jewelers' Circular-Wholesale  
**E. HOWARD CLOCK CO.,**  
EST. 1842. BOSTON, MASS., U. S.

**46 out of 99 PRIZES**

were awarded to

**PATEK, PHILIPPE & CO.**

In the Timing Contest of the Astronomical Observatory in Geneva, for the year 1905, comprising: The only First Unique Prize for Best Average Running; 2 First Prizes out of 3; 5 Second Prizes out of 10; 8 Third Prizes out of 18; 9 Fourth Prizes out of 23; 10 Honorable Mentions out of 23; 11 Simple Mentions out of 21. 11 Manufacturers participated.

68 NASSAU ST., NEW YORK.

GENEVA, SWITZERLAND.

**"PRACTICAL COURSE  
IN  
ADJUSTING."**

PRICE \$2.50.

ALL JOBBERS OR

JEWELERS' CIRCULAR PUBLISHING CO.

# CONSISTENCY IN BUYING WATCHES

**I**T IS GOOD POLICY to buy systematically, avoiding fickleness in trade. Find a house whose methods are in accord with your ideas and whose service is satisfactory, and then deal consistently with that house. Thus more thorough understanding is possible, mutual confidence built up, and foundation laid for ever-increasing satisfaction. Large sales of Watches are made here to Jewelers pursuing this policy.

## J. W. FORSINGER,

LEADING AMERICAN WATCHES AND MOVEMENTS

CHICAGO  
103 STATE ST.

NEW YORK  
2 MAIDEN LANE

## Sessions Clocks

Superior finish. Reasonable prices.

Have you seen our

**New and Exclusive Designs**  
in Mantel and Hanging Clocks?

Write for Catalog and supplement.

**The Sessions Clock Co.**

Main Office and Factories,

Forestville, Connecticut, U. S. A.

New York Salesrooms,  
37 Maiden Lane.



WHOLESALE

# DUEBER-HAMPDEN COMPLETE WATCHES

The conceded friend makers for the retail dealer. We are certain that we can help you make customers if you will write us for prices on Chains, Rings and all kinds of High-Grade Jewelry.



**WM. C. PENFOLD CO.**

WHOLESALE JEWELERS

AND AGENTS FOR DUEBER-HAMPDEN WATCHES

818-820 Chestnut St., Philadelphia, Pa.

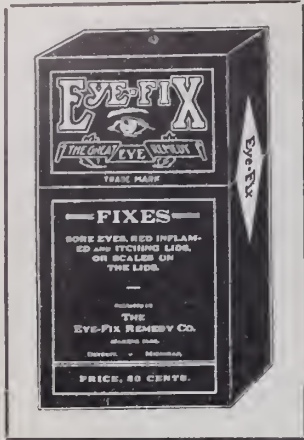

# Who Sells Eye-Fix?

**N**EARLY everybody in the trade. In less time than any other eye remedy on the market accomplished the same end, EYE-FIX has demonstrated its worth to jobbers, retailers and consumers. There is no just reason for prejudice against this article. Every dealer who wishes to best serve his own interests can handle EYE-FIX successfully. It sells on merit, invariably gives satisfaction and allows a big profit. Sales are going ahead by leaps and bounds. Why not share in this substantial prosperity? Get on the winning side of the eye remedy proposition. If you haven't already stocked EYE-FIX will you please tell us why?

**EYE-FIX REMEDY COMPANY, DETROIT, MICH. DEPT. 17.**



## It's the Little Things that count.

The dainty little things that appeal at once to the casual observer. If it's useful, as well as ornamental, so much the better. Here is a LITTLE THING, so very useful and so pretty in design and finish, that you have but to show one to make a sale, and it yields a BIG PROFIT. It is called

## The Automatic Eye-Glass Holder

Can be used as well for a Pencil Holder. It is made in Enamel, Gold, Silver and Rolled Plate, in a variety of artistic designs. We fully guarantee every Holder. We mean it, and will replace any Holder that fails to satisfy. Samples sent upon request. Send for catalogue.

Est. 1832. **Ketcham & McDougall, Manufacturers,**  
37-39 MAIDEN LANE, NEW YORK.  
ALSO MAKERS OF THE LEADING LINE OF THIMBLES.



## LEARN JEWELERS ENGRAVING

"The Engraving School that Graduates Experts."  
A fascinating, high-salaried and easily learned trade, taught thoroughly and practically by correspondence. Your instructor is the foremost authority and master workman in the world. We will teach the beginner better engraving by correspondence than he can gain in years of rigid apprenticeship. We will improve the skill of an engraver one hundred per cent. and make him master of the trade. The demand for competent engravers far exceeds the supply.  
Send for handsome, illustrated prospectus.  
**PAGE-DAVIS COMPANY, CHICAGO**  
Suite 10, 90 Wabash Avenue.



**Try Wells' Perfect Ring Adjuster**  
1 doz. asst. sizes 10k gold filled (goes front twice as thick as on back)  
1 doz. asst. sizes solid 10k gold.  
1 doz. asst. sizes metal. 50c. Ask your jobber for them, or I will send, prepaid at once (only on receipt of price samples)—one small and one medium large gold filled and one metal adjuster for 50c. Address

**CHESTER H. WELLS, Jeweler Meshoppen**

## E. H. H. SMITH SILVER CO. BRIDGEPORT, CONN.

Silversmiths' Building, CHICAGO, ILL.

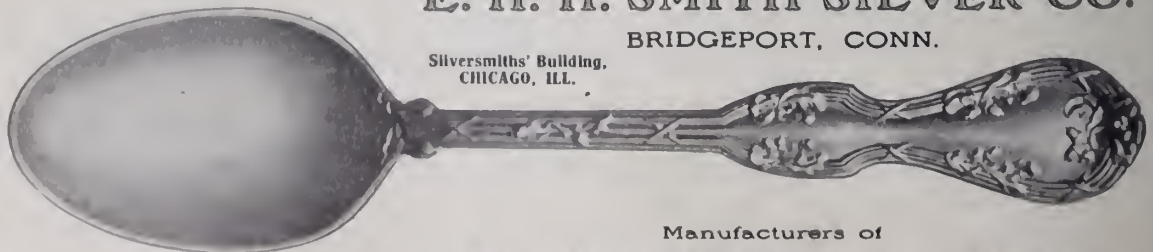

THE OAK

Manufacturers of

**Sterling Effects in Plate**

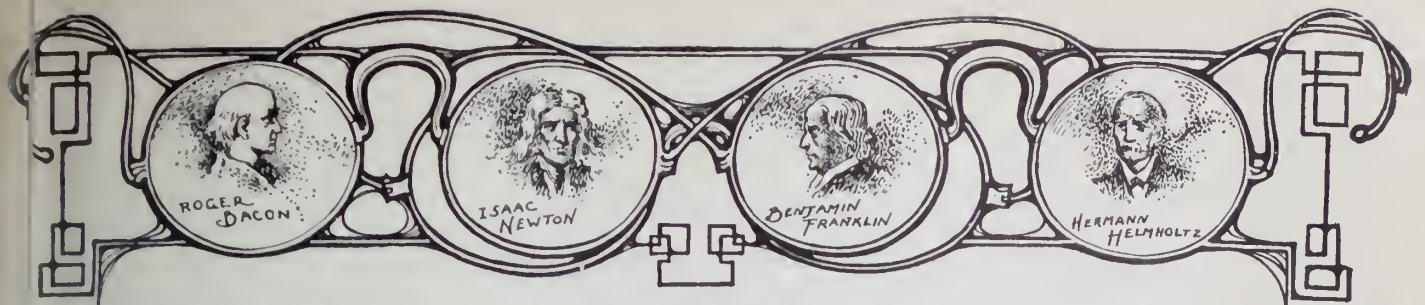

# OPTICAL DEPARTMENT

## The Optometrist's Catechism.

SERIES OF QUESTIONS AND ANSWERS ON ELEMENTARY OPTICS, IN CATECHETICAL FORM.

By E. Le Roy Ryer.

Copyright, 1903, by THE JEWELERS' CIRCULAR PUBLISHING CO

(Continued from issue of May 16.)

Q.—(655.) What systems are used in numbering the lenses employed in optical practice?  
 A.—There are two systems of numbering lenses. One is called the old or "inch," and the other the new or "dioptric" system.  
 Q.—(656.) What are the chief characteristics of the old and new systems? What

hardness) of the glass employed. It is the refractive index as well as the curvature that regulates the power of any lens. For instance, we might take two lenses having exactly similar curves; according to the "inch" system these lenses would be numbered the same, but had one lens been made of a piece of glass twice as hard as the other it would be twice as powerful and should be so numbered. This one instance shows how unreliable the old system is, because as a matter of fact the focal distance equals the radius of curvature of a bispherical lens only when the index of refraction of the glass used is 1.5 and the refractive index of the glass used for optical purposes is always greater than 1.5, being, on an average, 1.53. Hence the focal distance of a No. 36 lens of 1.53 refractive index, is not 36 but 34 inches, and the lens is therefore stronger than the old system supposes it to be. The following table affords further evidence of the inaccuracy of the old inch system:

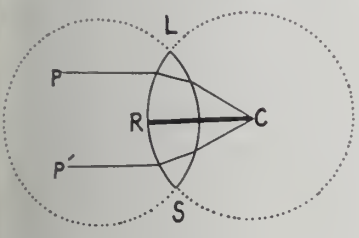

FIG. 85.

meters; the Prussian inch, 26.15 millimeters; the Austrian inch, 26.34 millimeters; the Paris inch, 27.07 millimeters. There are at least 30 different lengths for inches of different standards.

The old inch system has still another fault. The optometrist, in his regular practice, has much more to do with the refractive powers of his lenses than with their focal distances, and the radius of curvature is seldom of any direct importance. In using lenses we are continually forced to add and subtract their refractive values and if we attempt to combine values as designated by the "inch" system we are obliged to deal with vulgar (common)

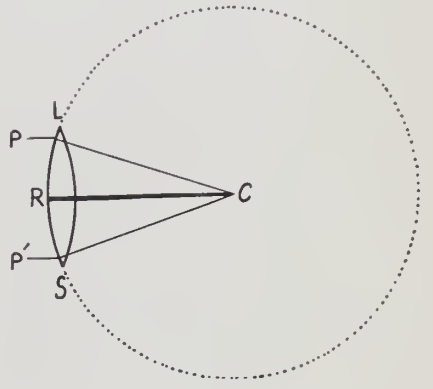

FIG. 86.

their relative values? Which is the better system to employ and why?  
 A.—THE OLD OR "INCH" SYSTEM.—In the old system the numbers indicate, in inches, the radius of curvature of the surface of the lens. In former days the double or spherical forms of lenses were used almost entirely, and consequently these formed the basis of calculation; when other forms of lenses were employed they would, in this method, be known by different numbers although they might in other respects be such as to produce the same optical effect. On this account convex and concave lenses of other forms came to be known by the number of the equivalent convex or biconcave lens, this number being the number of inches in the radius of curvature of the equally curved surfaces. This method, though inaccurate, was of great convenience to the manufacturer of lenses, inasmuch as he simply had to work on the lens the number of the tool with which he ground it, without taking into consideration the strength or refracting power of the lens. Tools, we all know, are found to become worn and calculations made solely upon their assumed curves could not possibly be trustworthy.  
 A still more noteworthy defect of the old system is that no account is herein taken of the refractive index (density or

Substance.	Index.	Radius of Focal curvature, distance.	
		mm.	mm.
Flint glass .....	1.6	1,000	833
Rock crystal .....	1.56	1,000	893
Ordinary spectacle glass.	1.53	1,000	943
Crown glass .....	1.5	1,000	1,000

It will be noticed from the above table that the radius of curvature is the same (1,000 mm.), in each instance; according to the old system, lenses made of these different materials, one of flint glass, one of rock crystal, one of spectacle glass and one of crown glass, would be marked the same; in other words, any lens having a radius of curvature of 1,000 mm. would have formerly been marked No. 40. The truth is, however, that even though all four lenses had the same curves their optical effects would be entirely different; the flint glass lens would cause parallel light to focus at a point of 167 mm. (over 6½ inches) nearer than the point of focus of the crown glass lens, the former being one-fifth more powerful than the latter, though ground with the same tool.

Besides these inaccuracies we encounter the disturbing fact that the inch is not an invariable unit of measure but differs considerably in different countries: For instance, the English inch equals 25.40 milli-

fractions which frequently have to be reduced to a common denominator and even when this has been accomplished our results are not clearly explanatory. For instance, let us endeavor to add a No. 10 inch to a No. 3 inch lens and we will find it no easy matter and seldom can we do it mentally. It has been found that the strength of a lens is the reciprocal of its focal distance. If the focal distance be expressed in a whole number its strength is expressed by a fraction—one divided by that number. Therefore, in the above example 10 represents the focal distance and the strength would be expressed by the fraction  $\frac{1}{10}$ ; in like manner the strength of the No. 3 inch lens would be represented by the fraction  $\frac{1}{3}$ ; to add these two fractions we must first reduce them to a common denominator. In this case the lowest common denominator is 30, and  $\frac{1}{10} = \frac{3}{30}$  and  $\frac{1}{3} = \frac{10}{30}$  and together they aggregate  $\frac{13}{30}$ . The fraction  $\frac{13}{30}$  now represents the combined strength of the two lenses; dividing 30 by 13 gives us the focal distance of the combination, namely, 2.3 inches. Thus a 10-inch added to a 3-inch lens gives us a 2½-inch lens, but one can

## Optical Department.

readily perceive that to add or subtract even the commonest lens values necessitates complicated calculations, if the inch system be employed.

Figs. 85 and 86 are introduced to show how lenses were numbered according to the old system. In Fig. 85, LS represents a biconvex lens; the center of curvature is at C and the radius of curvature is therefore RC. It can readily be perceived that the surfaces are segments of circles whose radii equal RC. If this radius of curvature be one-half an inch long the lens would have formerly been numbered a No. 1/2-inch lens (80.00 dioptry, new method).

Fig. 86 shows a lens LS, whose surfaces correspond to segments of a circle whose radius equals RC. This radius RC, in Fig. 86, being twice as long as the radius RC in Fig. 85, makes the lens LS, Fig. 86, only half as powerful as the lens LS, Fig. 85. In other words lens LS, Fig. 85, would refract the parallel rays PP<sup>1</sup> twice as much as would the lens in Fig. 86. In both cases, however, the old system assumes that the rays would come to a focus at the center of curvature. This is only true when the refractive index of the glass used is 1.5; so when we recollect that the refractive index of ordinary optical lens glass is 1.53 we see that the focus will not coincide with the center of curvature but will be somewhat nearer the lens.

Again had the lens in Fig. 86 been made of diamond while that in Fig. 85 had been made of crown glass the former, while having only half the curve, would have been almost as powerful in optical effect as the latter on account of its higher refractive index and consequent greater bending or refracting power.

This subject has been given detailed attention with the hope of laying all its many faults bare and convincing all that the old or inch system of numbering lenses should be discarded by those dealing with optical problems.

(To be continued.)

## Optical Notes and Briefs

A. L. Freed, general manager of the Consolidated Optical Mfg. Co.'s stores, will have charge of a branch store which that concern will open this Summer at 306 Brooklyn Ave., Asbury Park, N. J.

J. W. Jarvis, optician, Buffalo, N. Y., had a most attractive window display on Memorial Day, the exhibit being thoroughly appropriate. The window was neatly draped with American flags, the golds encasing oil paintings of Abraham Lincoln, William McKinley and Gen. U. S. Grant. Much attention was drawn to the window by the artistic scheme in the decorative arrangement.

The California Optical Co., San Francisco, Cal., which secured a two years' lease on the store at 2109 Fillmore St., immediately after the fire, was the first optical concern in that city to get a plant in operation after the disaster. Mr. Davis, of the company, states that the house is now running full blast, and is prepared to take care of all orders. The retail prescriptions, a gathering of 18 years, were all saved.

## Anatomy of the Nervous System.

(Lecture recently delivered before the Rochester Optical Society by DR. RALPH H. WILLIAMS.)

(Continued from issue of June 6.)

THE ophthalmic is divided into three divisions—the lachrymal, frontal and nasal—which are distributed to the forehead and scalp back to the crown, the eyelids, lachrymal gland, conjunctiva, iris, ciliary muscle, the nasal cavity and the nose.

The superior maxillary division of the fifth is divided into the orbital, palatine, posterior and anterior dental and the infra-orbital. It supplies the temple, cheek, lower eyelid, nose, lip, palate, upper teeth and sends a branch to Meckel's ganglion. Meckel's ganglion is the controlling center of the nose, palate, and the roof of the mouth. It is composed of trunks from the facial motor, fifth, and the sympathetic. It is the operation of the ganglion which is principally affected in catarrhal conditions.

The inferior maxillary division of the fifth, which contains the motor root, is both sensory and motor, and is divided into seven greater divisions as follows: The recurrent, pterygoid, deep temporal, buccal, auriculo temporal, lingual and inf. dental. Its motor root supplies all of the muscles of mastication, and its sensory root supplies the auditory meatus, the anterior part of the tongue, the cheek, lower teeth, the sensation of the lingualis muscle, and sends communicating branches to the optic and sub-maxillary ganglion.

The sixth nerve, or abducens, is a motor nerve of the eye. It arises deeply from the floor of the fourth ventricle. It makes its exit to the orbit through the sphenoidal fissures and is distributed to the external rectus muscle of the eye.

The seventh nerve, or facial, is the great motor nerve of the face, ear, palate and tongue. It arises from the floor of the fourth ventricle and makes its exit from the skull just behind and below the ear. It passes forward across the ramus of the jaw, supplies all of the muscles of expression in the face and upper part of the neck, the tongue, the muscles of the ear and palate, and furnishes the motor root to Meckel's and the otic ganglion, and communicates with the auditor, great auricular, pneumogastric, gloss-pharyngeal and fifth nerves. It also communicates with various plexuses of the sympathetic. The facial nerve is the one involved in facial paralysis, which is so common, and in spasms or twitchings of the muscles of the face.

The eighth nerve, or auditory, is the special nerve of the sense of hearing and is distributed exclusively to the internal ear. It arises from the floor of the fourth ventricle and is distributed to the vestibule and cochlea of the internal ear.

The ninth nerve, or glosso-pharyngeal, a nerve of sensation and taste, arises from the floor of the fourth ventricle, makes its exit through the jugular foramen and is distributed to the back of the tongue (giving the sense of taste), the middle ear, tympanum, eustachian tube, tonsils and pharynx. It is this nerve and its distributions which are principally affected in pharyngitis, or tonsillitis.

The 10th nerve, or pneumogastric, otherwise known as the vagus, vagrant or wandering nerve, is accurately described by

the name which has been given to it, the auriculo-laryngo-pharyngo-oesoph-tracheo-pulmono-cardio-gastro-hepatic nerve. It is a nerve of motion and sensation and arises from a nucleus in the floor of the fourth ventricle. It makes its exit through the skull by the jugular foramen. It supplies sensation to the external ear and larynx and motion to the other parts. Its distribution is well indicated by the phonious name given it. This nerve probably receives its motor root from the spinal accessory. It communicates in a number of places with the sympathetic. It communicates with the hypoglossal, glossopharyngeal, facial and first and second cervical nerves.

The spinal accessory nerve arises from a double root. One from the floor of the fourth ventricle and the other from the lateral columns of the cord and gray matter in the anterior horns as low as the sixth cervical nerve. The accessory function is that which arises from the floor of the fourth ventricle and is the portion which passes into the vagus or pneumogastric.

The nerve makes its exit from the jugular foramen, supplies the sterno-cleidomastoid, trapezius muscles, communicates with the pneumogastric and also with the second, third, fourth and fifth cervical nerves and is continued with them in their distribution.

The 12th nerve, or the hypo-glossal, is the motor nerve of the tongue. It arises from the floor of the fourth ventricle, exits by the ant. condyloid foramen, passes downward and supplies all the muscles attached to the hyoid bone, and to the sterno-thyroid. It communicates with the pneumogastric, first and second cervical nerves and with the lingual branch of the fifth nerve.

## PHYSIOLOGY OF THE NERVOUS SYSTEM

Having considered the general features of the anatomy of the nervous system we will now take up its functions and its reflexes. In considering nervous tissue in general, which includes special organs, medulated and non-medulated nerves, ganglia, nerve centers and granular nerve tissue which makes up a portion of the spinal cord and brain, we should say that the function of this tissue is to receive, transmit, register, reorganize and forward nervous impulses.

In other words, the impulse, of whatever nature it may be, must be received by a nerve terminal, either in a special end organ or in the ordinary terminal plexus of a sensory nerve. It must be transmitted along the course of the nerve to the organ of that nerve either in the sensory ganglion on the sensory root of the spinal nerve or in the sympathetic ganglia, there to be received and either forwarded to the brain for reorganization or reorganized there and returned along other fibres in the shape of an afferent or centrifugal impulse.

In the discussion of nerve fibres we find there are three different classes of fibres regards function. There are the afferent fibres carrying impulses to the center of the nervous system from the periphery, the efferent fibres carrying impulses from the center to the periphery, and intercommunicating fibres, or those which connect together nerve centers; either connecting centers in the brain together or centers



## Optical Department.

cord together, it being the connecting link between centers in the cord and brain. Their arrangement is most complex, too rich so for discussion in more than a superficial manner in a lecture of this kind. The afferent fibres conduct sensations which can, in the broad use of the term, be called sensory, such as the touch of the finger to some substance. The sensory or afferent nerves of the finger carry that impulse to the cord and thence to the brain, where the impression is registered. This registration or mental process constitutes a sensation. These nerves have, however, a higher function than carrying sensations, which there is a mental registration.

For instance, in many of the automatic reflex actions the afferent impulse is one of which we are not conscious, nor are we more than indirectly conscious of the reflex. Small particles of dust may accumulate on the eyeball. While not of sufficient moment to cause the slightest sensation or discomfort, yet there is registered on the nerve that impression which is carried to the brain where an impulse is organized and sent out along the nerve to the muscles of the eye, causing the closing of the lid and the consequent removal of the offending substance or the lubrication of the eye to such an extent that its effect is counteracted.

The reflex, by which the increase of saliva is produced by the smell or presence of food, may be an absolutely unconscious operation, and yet an afferent impulse will be involved. There are, of course, all of the special senses, sight, hearing, taste, smell and touch. These are all special end organs sending to the center special impressions. There are the nerves of general sensibility which are not referable to any of the special senses. These nerves are capable of producing a feeling of general discomfort. Pain is a sensation which can be created by the excessive stimulation of any sensory nerve.

The afferent nerves are more complex in their function and embrace five separate and distinct varieties of nerves as follows: motor, accelerator, inhibitory, secretory and sympathetic. These nerves are separate and distinct fibres as near as we know and each carries its special function. One nerve trunk may carry all of these functions, but it will be due to the different nerve fibres, each having its special function.

The motor nerves cause muscular contractions in either voluntary or involuntary muscles. The voluntary muscles are such as those in the arm or trunk, while the involuntary are represented by the vaso-motor nerve in the blood vessels or the fibres of the intestines and stomach.

Accelerator nerves are those which produce an increase in the rate of rhythmic action. This is seen in the sympathetic nerves which supply the heart. Derived from the upper dorsal and cervical sympathetic ganglia, their stimulation will cause quickening of the heart beat.

Inhibitory nerves are those which cause slowing of rhythmic action. There are so many nerves to the heart which are derived from the pneumogastric or vagus, the stimu-

lation of which will cause a very material slowing of the heart action.

These accelerator and inhibitory nerves are found in the walls of the blood vessels and are part and parcel of the vaso-motor nervous system of the entire body. In fact, the vaso-motor system of nerves, while primarily motor in function, are also either accelerator or inhibitory. It is through these nerves that some of the most important effects are secured in the handling of the human body in pathological conditions. It is only within the last few years that the subject has been even vaguely understood.

(To be continued.)

### The Health Ray Lenses.

(Lecture by DR. ARTHUR C. CAMPBELL, Topeka, Kans., before the convention of the New England Association of Opticians, May 16, 1906.)

(Continued from issue of May 30.)

PEBBLES were used more or less for many years, but have been discontinued by most oculists and opticians for several reasons. First, it is a well-known fact in science that this material, like Iceland spar, fluorspar and similar substances, possesses a double refractive power which makes it impossible for use in any perfect lens. That this is well understood is shown by the following from "Manuel de L'Etudiant Oculiste," par Arthur Chevalier.

"The double refraction of rock crystals renders them useless for optical purposes, and especially for the manufacture of spectacle lenses, and although the images do not appear double across such lenses in consequence of their thinness, and the manner in which they are used, it is, nevertheless, true that double refraction exists, and that it can cause considerable trouble to vision by weakening the retina, and producing fatigue of the accommodation, or even a kind of amblyopia."

Second, to make anything like a perfect lens it is absolutely essential that the material be "axis cut"—that is, cut crosswise to the axis of the pebble and so finished that the axis of its crystallization is directly in the pupillary center. Rohne, after making a careful examination of pebble lenses, says that in his opinion of the regular stock of "pebble lenses," not more than two pair out of a thousand properly axis cut could be found.

Third, photography has known for years that pebble lenses would transmit a great amount of chemical light, and it has been the dream of the camera maker to utilize this material in order to make a more rapid and clear-cut photograph, but, owing to its double refractive power, it could not be used. Manufacturers in Europe have spent thousands of dollars in melting rock crystal with the idea of doing away with this double refraction, but after a long series of experiments find it impossible to obtain a piece of any practical size possessing a single refractive power.

Fourth, pebble lenses absorb a large amount of the red, orange and yellow, which is believed to be a serious objection; all rays are needed, as Nature sends them to us in order to insure the best possible results.

In all the literature consulted I have failed to find any reason given why one kind of glass is not as good as another for making lenses, provided it will take a good

polish, will not corrode, is white, free from streaks, etc. "Lenses of the first quality always contain more or less lead, the larger the quantity (to almost half its volume) the finer its luster and beautiful sparkling. This kind is known to the trade as extra white, and cannot be distinguished from pebbles by simply comparing them together by look." This is quoted from one of the best authorities.

As a matter of fact, lead, which is the ingredient here mentioned as making the best glass, and which imparts its brilliancy to cut glass, is the one thing which absorbs more health rays than any other ingredient used in glass-making. It is true it makes a white brilliant glass, and the more injurious it is to the eye.

If the heat, light and health rays come from heaven in their proper proportions, as they surely do, then it must follow that the best material for lenses through which the light passes to the eye is that medium which will transmit the greatest possible number of all these rays.

But, says a critic, all the rays lost in either case are not lost by absorption; some of them are lost by reflection from the surface of the glass itself. True, the lead is used in the cut glass to increase the number of reflected rays in order that the eye receiving them may be dazzled. For the purpose of this discussion it is not important to determine whether the loss is due to absorption, to reflection or to both.

The important thing is the loss of these rays so priceless to the eye and to its proper use and health. Herein lies the inestimable advantage of health ray glass—it transmits more of all the vibrations or wave lengths with less diminution of energy than any other lens material known to man.

I am not going to tell you what is in the health-ray glass or how it is made. I offer you the simple proof of its merits, the proof that it will and does transmit heaven's light just as it leaves the sun more nearly than does any other material known to man. If you are convinced that that is the way the eye needs it, if you are wise in business methods, if you are true to sufferers, if you are loyal to your profession of healing, you will adopt the only means to secure that need, namely, prescribe and furnish to your patients, who rely upon your judgment and advice, health-ray glasses.

[THE END.]

The San Francisco opticians are recovering rapidly from the effect of the recent fire and have already commenced to resume business to a greater or less extent. The demand for optical goods in the new retail district is good and considerable business could be done were it not for the shortage of stock and for the lack of the necessary machinery. A number of the larger establishments saved all their prescriptions and are already at work to a limited extent. The larger optical establishments all along the coast have been exceedingly generous in offering their facilities to their burned-out competitors in San Francisco. From Los Angeles, Seattle, Portland, Oakland, San Jose and other cities have come offers of assistance in a business way, and in some cases the San Francisco trade has been glad to avail itself of these kind offers.



That this department shall prove mutually beneficial to our readers, it is desirable that the members of the trade generally communicate with THE JEWELERS' CIRCULAR-WEEKLY regarding any advantageous device or plan which they are utilizing in connection with their business.

**A Palatial Retail Jewelry Establishment.**

IN this issue of THE CIRCULAR-WEEKLY are shown views of W. W. Wattles & Sons, new quarters, Pittsburg, Pa. After 47 years on Fifth Ave. they determined to

The diamond office at once arrests the attention of those who enter. It is made of plate glass and mahogany and adorned with blue raw silk curtains which match the paper. The general offices, which are spacious and handsomely equipped are situated

are arranged around the room for the play of cut glass, rock crystal, etc., etc.

The second floor is finished in dark beautifully grained, and blends well with the gray-blue paper, which also forms a part of the decoration. On this floor the partition of dark oak with rich green hangings between the arches, which separate the silver from the Tiffany room. The tables here are covered with antique velvety, displaying to advantage Tiffany lamps, electroliers, which are also suspended from the ceiling. The windows have blue shades and the walls are stippled in blue-green, while the woodwork is of green oak, the general effect tending to enhance the beauty of the Tiffany products.

The front of the store is of Green marble, and was imported by the company from Switzerland. It is plain, but substantial, being devoid of carving, save the capitals of the Ionic pillars. Under mezzanine there are seven large electroliers besides several brackets and water



DIAMOND AND JEWELRY ROOM

take a new and much better building on Wood St., between Fifth and Oliver Aves., which has been magnificently fitted up.

There are three floors in the establishment, each 20 by 80 feet, the ceiling being 15 feet high. Wooden beams cross the ceiling on the first floor, where on the left, as one enters, is seen a beautiful arch, in which stands the firm's regulator for timing watches. The vestibule and main floor are beautified by large squares of Tennessee gray marble, with a light green marble border and base to the counters.

The entire left side of the store is paneled with dark, beautifully grained mahogany of the finest quality. This paneling extends upward seven feet, above which is a gray blue Ingram paper which makes a pleasing contrast with the dark wood. All the woodwork throughout the store, including the paneling wall and counter cases, diamond office, general offices and even the door leading to the lavatory and bathroom is mahogany.



SILVERWARE ROOM.

in the rear of the store under the mezzanine.

All the furnishings of the mezzanine are none the less attractive. Persian rugs adorn the floor, and mirror-covered tables

lights. The lighting facilities on each floor are fully adequate for the proper display of the rich stock.

The show window is five feet six inches deep, 10 feet six inches high and about

### Storekeeping Department.

width. It has plate glass back and iron. The ceiling of the show window is of full gold. The bottom of the window is 25 inches from the pavement and is mounted on a mahogany and marble base. The stock on display is illuminated by a 100 c. p. electric globe of high efficiency. The concern has its own electric motor and is protected by the Holmes and the Protective Service.

### What Some Jewelers Say.

**DIAMOND** Locketts.—Round Roman finish gold lockets, set with one or any desired number of diamonds formed into art designs. They are rarely beautiful, prices are lower than you are asked to elsewhere, and bear in mind that the

in the south, and ask the most reasonable prices for them.—Albert Piefer & Bro., Little Rock, Ark.

### How the Retail Jeweler Can Combat the Trading Stamp Nuisance.

**T**HE cost of using trading stamps averages about five per cent. of the retailer's gross business. Therefore the merchant who does a gross business of \$20,000 a year pays the trading stamp concern about \$1,000. This without any benefit to himself because his competitors are able to secure exactly the same inducement, and the profits of all are reduced proportionately. The only ones benefited are the promoters of the scheme.

Granted that the retailer pays out this \$1,000, for which he secures no adequate return, what can he do to overcome this drain on his resources?

Let us look into the matter. The trading

papers, whose combined circulation will reach 8,000 families. To insert a four-inch single column advertisement with two changes of copy a week in both papers would cost just \$240.32. In addition the retailer could use the street cars, which in a town of the above size would number 25, for about \$10 a month, or \$120 a year. For \$360.32 the retailer could present his story to the people for a whole year, and if his appropriation was two and one-half per cent. of his gross sales, he still would have \$140 remaining, which he could use for cutting prices on certain goods to be used as leaders. The retail jeweler has a wonderful opportunity along these lines, and if he will supplement these efforts with good, appropriate window displays and mailing lists, he will not lose any sleep over the trading stamp nuisance.

But a word of caution. Do not use stereotyped advertising copy. Put yourself



TIFFANY ROOM OF THE ESTABLISHMENT OF W. W. WATTLES & SONS, PITTSBURG, PA. W. W. WATTLES, FOUNDER OF THE BUSINESS AND THE OLDEST JEWELER IN ACTIVE BUSINESS IN THAT CITY, IS SEATED AT THE LEFT.

goods are honest. Ed. N. Rose, Butte, Mont.  
**Diamonds.**—Invest in a diamond; it is safer than banking your money. There is a time when nobody but the rich thought of buying diamonds, when they were bought for their prettiness and the play in dress that they created. Now diamonds are a good poor man's proposition. For, we might say, a man in moderate circumstances, because they're a safer investment than placing money in a bank, and a better paying one, too, as they're constantly increasing in value. This is especially applicable to those that find it difficult to keep money in the bank. Money on diamonds is easily realized—when the necessity arises, it is easy to keep until that time arrives. You can carry the largest collection of diamonds

stamp inducement is expensive and is destructive of reputation, profit and business. Something then must be found to be constructive which will build up the reputation, business and profits. The same antidote for this very condition has been offered the retailer time and time again, but in every instance, with few exceptions, the opportunity has been allowed to go by.

Suppose, for instance, a jeweler in a town of 40,000 people does a gross business of \$20,000 per year. How much does that merchant invest for advertising in that year? As a rule, if it exceeds \$100 the merchant thinks he is extravagant and throwing money away.

But let us study the matter closely. In that town there are at least two good news-

into your advertisements. Make them breathe your own individuality and take as much if not more thought concerning them than you do of the other parts of your business.

It may be of interest to retailers to know that there are some retail merchants who pay men from \$1,500 to \$10,000 a year to prepare their advertisements for their local papers. An instance comes to my mind of one firm that pays an advertising man \$4,000 a year to write a different advertisement measuring 10 to 12 inches single column daily. This firm and every other that goes about it systematically finds that they can get more results out of their five per cent. if they expend it constructively.

Try this plan for a year and you will be surprised at the results. J. G. K.

What Tool is of More Importance to THE MAKERS OF FINE JEWELRY than

# A FIRST CLASS SAW ?

**SHARP—TRUE—UNIFORM  
—PERFECTLY TEMPERED**



TRADE MARK  
**ONLY THE BEST**  
ARE GOOD ENOUGH  
MARK



Such is the **ZEUNER SAW**

**TRY THEM**, for "Only the Best are Good Enough," and only the Best are Cheap. Trial orders promptly filled under guarantee of perfect satisfaction, which applies also to "AMERICAN SWISS FILES."

**E. P. REICHELME & CO.,** 23 JOHN STREET, NEW YORK.

**HERPERS BROS.,**  
MAKERS OF

**BRACELET**      **SETTINGS**

IN 10, 14 AND 18 KARAT GOLD AND IN PLATINUM.

ALSO A COMPLETE LINE OF GALLERIES AND FINDINGS.

**GALLERIES**

12 NEW PATTERNS

OFFICE AND FACTORY: NEWARK, N. J. U. S. A.  
NEW YORK BRANCH: 41-43 MAIDEN LANE

**GLARDONS' SWISS FILES**  
are the **HIGHEST STANDARD** of Excellence.

We are Sole Agents for the United States and Canada.

**F. W. Gesswein Company**  
Established 1868. Incorporated 1896.  
WILLIAM DIXON, PRES.  
Dealers in Fine Tools and Supplies,  
39 John Street, New York

**CRUCIBLES**  
Jewelers' Supplies, Etc.  
Established 1850.  
**J. & H. BERGE,**  
98 John Street, NEW YORK.

**LEIMAN'S NEW SAND BLAST.**  
SIMPLE. EFFECTIVE. ECONOMICAL.

**NEW FEATURES**—Let us tell you about them.  
**RESULTS**—Let us show you samples of work done.

**Improved High Pressure Blower**  
NOISELESS. INEXPENSIVE.  
Delivers Greater Volume at Higher Pressure Than any Other Made.

**LEIMAN BROS.,**  
Jewelers', Silversmiths' and Metal Workers' Machinery, Tools and WORK BENCHES,  
141 Centre Street, NEW YORK.

PATENTED.

**F. JEANDHEUR, Jr.**  
Rear 17 John St., N. Y. Third Floor.  
**Gold and Silver Plating**  
SPECIAL WORK AND COLORING  
IN ALL SHADES A SPECIALTY.  
Established 1863.      Platina Plat.

**CASTINGS** Gold, Silver, Bronze, Brass, German-silver, Copper & Iron. Supply Jewelers, Silversmiths, Die-makers, Mould-makers, Unbreakable Bronze Forces, Hard Bronze Engraving Plates, Cast Iron Forces for making Steel, Chandelier, Undercut Work, Statuary.  
**AUGUST GRIFFOUL,** 313 HALSEY STREET, NEWARK, N. J.

**JOHN S. STIVEN**  
Gold and Silver Chaser.  
Room 219, Electrical Exchange Building,  
136 LIBERTY STREET. NEW YORK.

**CULMAN BALANCE CHUCK**

For Refinishing Balance Pivots, without removing the Hair-spring or Roller, and protecting them while the pivots are being polished. ONCE TRIED, ALWAYS USED. FREE ON 10 DAYS' TRIAL.  
OVER 1000 SOLD THE FIRST YEAR. PRICE, \$3.50.  
**C. CULMAN, 316 N. Sixth Street, ST. LOUIS, MO.**

"PRACTICAL COURSE IN ADJUSTING" Price, \$2.50.  
All Jobbers or Jewelers' Circular Publishing Co.

**PLATINUM**      **AMERICAN PLATINUM WORKS**  
NEW YORK OFFICE: 41 Cortlandt Street      **NEWARK, N. J.**



Answers are also solicited from our readers to the questions published on this page.]

QUESTION No. 1594.—**Verde Antique.**—*Use tell me how to produce on brass or copper the green color known as "verde antique"; also how to produce on brass the "black finish"?* C. F. W.

ANSWER:—Verde antique bronze is represented by two shades of green—a light one for the recessed spaces, which are generally rough and unfinished, and an olive or dark green for the smooth and polished surfaces. The ingredients for the solution to produce the light green shade are: Strong vinegar, 200 drs.; carbonate of ammonia, 30 drs.; common salt, 10 drs.; cream of tartar, 10 drs.; acetate of copper, 10 drs. These ingredients are placed in a strong, tightly corked bottle, which should be kept in a warm place and shaken at intervals until the ingredients are dissolved. The articles to be bronzed, either brass or copper, must be scrupulously clean, exposing a porous metallic surface. Paint them quickly with a camel's hair brush, and do not pass over the space the second time. When the colors begin to dry, take a soft brush with long silky hair and pass it over the object to equalize and smooth the covering. As soon as this brush begins to get damp, wring it for a dry one. You may repeat these operations two or three times, but be careful to let the preceding covering be thoroughly dry. The recessed and rough places are then considered finished with a light green color, but the smooth parts need be varnished to protect them when being touched. This varnish is impregnated with fine lampblack, sparingly, which will change the light green into a handsome olive green. For this operation the articles should be warmed in a suitable oven. The varnish used is generally of French make and may be known by the strong smell of lavender spirits, when this varnish is thoroughly dry, after, say, about a day or two. To procure a black finish on brass, coat with a diluted solution of mercurous nitrate. The result is a quick silver layer, which, by repeated applications of potassium sulphide solution, is changed into mercuric sulphide. The coating thus formed presents a lustrous black. A brilliant blue-black is formed by immersing the polished brass objects in blue vitriol solution. The proportions of the solution are governed by the composition of the brass.

QUESTION No. 1595.—**Etching on Glass.**—*Can you inform us how we can engrave or etch on glass?* M. L. M.

ANSWER:—Coat the glass with asphaltum and scratch the names in it so that the glass will be bared where the name is to be. Then pour two parts of sulphuric acid over the part of pulverized fluorspar in a lead basin, and dip the glass into this mixture. In an hour or two the name will be etched

into the glass and the asphaltum can be removed with oil of turpentine. A simple method is to apply an aqueous solution of hydrofluoric acid to the names with a soft brush. This should be done several times to insure a successful result. You should be very careful with the hydrofluoric acid, as it and its fumes are very injurious to the eyes.

### The Enameling of Jewelry.

By CECIL H. SHERMAN.

(Copyright, 1906, by The Jewelers' Circular Publishing Co.)

(Continued from issue of May 23.)

A NUMBER of articles require lapping after the last firing. There are different opinions as to which method is the best. Lapping is the process of smoothing or polishing the surface of an enameled article by means of a revolving wheel and a paste made of water and some one of the polishing mediums, such as rouge, tripoli, pumice, putty, powder, etc. Some use a wheel of soft wood; others, hard wood, leather, tin or felt.

In a shop where there are 80 persons employed as enamellers all the year round (the largest in this country), the following method is used:

A polishing lathe head, with a spindle on either side, is belted up so that the outside of a wheel, six inches in diameter, will run a little faster than the outside of a power grindstone. On one of the spindles is placed a six-inch white wood disk, one inch thick; on the other is placed a wooden disk, faced by closer pitch or fish glue with the hardest kind of felt, one-fourth to one-half an inch thick, and white and smooth. It is trimmed even with the wood and fixed on the opposite spindle, felt side out. The lathe head or polishing head, is arranged so that the light is in front of the operator, and high enough for one to stand up when using it. It is just about as high as an old fashioned power polishing lathe; in fact, you can use one of these if the drive wheel is heavy enough to run the lap at a slow rate of speed.

Make a thin paste of finely pulverized pumice (the kind that is not gritty) and water, about the consistency of thick cream. A bowl half full will be enough at a time. Place the bowl under the wooden wheel, scoop up with your hand the pumice and water and literally plaster the wheel with it. Hold the piece to be lapped for a second or two against the wheel with a pretty good pressure, either against the side or the edge, to suit the surface. Look at surface to see what progress you have made, then scoop up more pumice and water and repeat until you have a perfectly smooth

surface, finished on the felt wheel, using just enough pumice, called "slush," to keep the piece from getting hot.

If you cannot get hard felt wash the wooden wheel clean and proceed in the same manner, using water instead of slush. Do just enough of this lapping to remove the greasy appearance from the article.

If you are generous with the slush, have a soft pine or white wood wheel (poplar or bass wood are equally good), and pumice of the finest kind, free from dirt or grit, the results will be satisfactory. Dirt or grit will make scratches on the surface, and a little pimple or bump on the enameled surface before you start to lap will leave a ridge, etc.

Usually a piece of jewelry that is decorated by the process of enamel painting is first prepared for enameling in the regular way, and then given one or two coatings of white enamel, each of which is charged on very smooth and even and not fired too smoothly. On this white surface one can proceed to paint as though it were china, using the same colors. La Croix tube paints for china give very good results, but the better work is accomplished by using dry colors that you yourself grind in lavender oil. Instruction in China painting would enable one interested in this work to accomplish very good results.

There is, however, quite a difference in the mode of firing an enamel painting; also in colors after firing.

If one desires to make a test plate of oxide on silver which has been given two coats of white, take the enamel paints (or china paint) and make a blend of each color on the plate; then place it on top of the furnace or in some very warm place, and when the paint is thoroughly dry, fire it the same as you would an enameled article which has been stoned off and cleaned; then cool and note the results, bearing in mind when you proceed to make some design or tint the way the paint appears after firing.

Should you find it difficult to paint on such a smooth surface the plate can be dipped in hydrofluoric acid, wet brushed and rinsed in clean water. It would be better, in making this test, to make, say two blends of each color, to fire, and, when cool, to give each of them a second coat of the paint; fire again and, when cool, charge an even coat of fondant (or flux) for painting over all of the painted surface, and fire it the same as you would a coat of enamel. A great many colors disappear on enamel; some will stand a number of firings and others only a few. When you know your color, the rest depends upon your artistic ability.

The most common enamel paintings are violets and pansies. In order to get the deep colors on these some are fired eight or 10 times, and are then given two coats of flux. The dead finish on the flowers comes from dipping them in white acid (hydrofluoric) and rinsing them in clean water, some preferring warm water. This is usually done after the work is polished, gilded or finished in whatever way desired.

(To be continued.)

M. Sidwell, Elwood, Ind., has taken his son into partnership and the firm style is now M. Sidwell & Son.

**C. DORFLINGER & SONS,**

36 MURRAY STREET, NEW YORK.

*Works, White Mills, Wayne Co., Penna.*

Manufacturers of plain and cut Table Glassware of the highest quality.



**ENGLISH :: GLASS.**

Large Assortment of FANCY VASES, GENTRE PIEGES and ROGK CRYSTAL STEM WARE,

Particularly adapted for the Jewelry Trade.  
Write for particulars.

Sole Agent for the Celebrated CAULDON CHINA.

**EDWARD BOOTE,**  
46 West Broadway :: New York.

**Have You  
Received Our  
New Catalog?**

**Maple City Glass Co.,**  
CUT GLASS TABLEWARE,  
**Hawley, Pa.**

SALESROOMS:

- New York—H. B. Stites, 253 Broadway.
- Baltimore—Green & Thomas, 33 S. Chart St.
- Boston—Sweetser-Bennett Co., 101 Tremont St.
- Buffalo—J. R. Stadlinger, 685 Main St.
- Indianapolis—J. A. Dugan Co., 22 S. Capitol Ave.
- Duluth—Duluth Crockery Co., 6th Ave. at West St.
- Denver—Western Selling Co., 1617 Larimer St.



No. 3399.—Loving Cup. Height, 10 inches.

**The Pairpoint Corporation.**

Send for Catalogue showing our complete line of

**Prize Cups and Trophies.**

BRANCHES:

- 38 Murray Street, New York City
- 36 St. Antoine Street, Montreal, P. Q.
- 717 Market Street, San Francisco, Cal.

FACTORY: NEW BEDFORD, MASS.

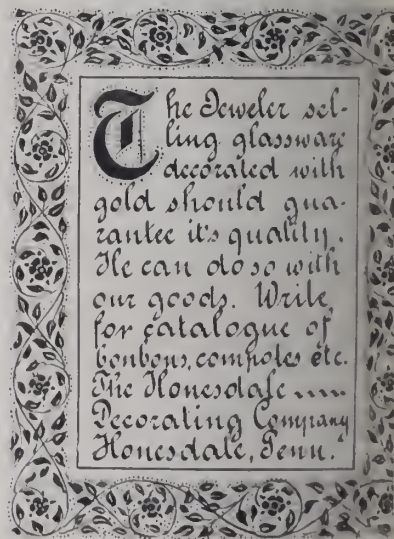

The Jeweler selling glassware decorated with gold should guarantee its quality. He can do so with our goods. Write for catalogue of London, combs etc. The Honesdale Decorating Company Honesdale, Penna.

Established 1870.

Manufacturer of

**LOUIS W. HRABA, Fine Leather Goods,**

29 East 19th St., New York.

Exclusively for the Jewelry Trade.

**CLOCKS, BRONZES, CUT GLASS and ART NOVELTIES.**

WHOLESALE DISTRIBUTORS **COMMUNITY SILVER** SEND FOR CATALOGUE

**H. BEALMEAR & CO., 234-236 Park Avenue, Baltimore, Md.**

# THE CONNOISSEUR

*Devoted to Art Pottery, China, Marbles, Bronzes, Cut and Decorated Glass Ware, Bric-à-Brac, Lamps, Art Metal Wares, Fancy Goods and Kindred Lines.*



## A Fine Bronze Group Recently Presented to the Metropolitan Museum of Art.

The Mares of Diomedes, by Gutzon Borglum, presented to the Metropolitan Museum of Art by James Stillman, is given its place in the Court of Sculpture, and forms a most beautiful and significant addition to the museum's collection of

sculpture. It sprang upon one of the animals and led them in a wild stampede to the coast. Overtaken on the way by the Bistones, Hercules gave the mares into the keeping of his friend, Abderus, whom they promptly devoured. Finally succeeding in killing Diomedes, Hercules threw his body to the mares, who became tame upon partaking of the flesh of their master.

It bears Hercules has already gained the level. This device in the conception serves admirably to hold the composition together. There is none of the unpleasant stringing out of attenuated figures which so often takes place when the object of the sculptor is to give the sense of motion. The eye readily seizes the group as a whole and receives the impress of a beautiful silhouette.



THE MARES OF DIOMEDES, BY GUTZON BORGLUM, IN THE METROPOLITAN MUSEUM OF ART.

The sculptor has seized upon the moment of stampede—the horses dash forth at headlong speed close upon the heels of their leader, upon whose back clings Hercules urging them on. They have encountered a slight rise, one is in the act of dashing breathlessly up, others stumble as they encounter the obstacles to their mad flight, one crowns the summit, another slides down on its haunches, while the horse that

Furthermore, the sense of the slight elevation encountered accentuates the powerful onrush of the horses. It would seem almost as if something of the increased impetus that seeks to overcome the barrier is communicated to the spectator. While the spirit of panic is caught most wonderfully by the sculptor—the high-strung steeds fairly quivering in their frantic desire to escape from some unknown terror—yet

American sculpture, says Annie Nathan Meyer in a second number of the museum's *Bulletin*. The motive of the group is taken from the eighth task of Hercules, which was to bring to his master, Eurystheus, the man-eating mares of Diomedes, King of the Bistones in Thrace. Hercules made an unexpected attack upon those who guarded the stables where the mares were kept,

# LIBBEY

THE WORLD'S BEST.  
CUT GLASS

It is admitted, isn't it, that all other makers try earnestly and eagerly to reach the Libbey standard?

It is the type, the pattern, the model for the whole world, isn't it?

Well—doesn't that begin and end the cut glass story?



The Libbey Glass Co.  
TOLEDO, OHIO  
New York Salesroom, No. 57  
Park Place.

# Libbey

"THE WORLD'S BEST."

## LOOKING FOR THE NAME



### CRANBERRY LAKE REGION OF THE ADIRONDACK MOUNTAINS

a section full of large fish is described in New York Central Lines Four-Track Series No. 32 which contains a beautiful map of this region printed in four colors. Copy will be sent free, postpaid, on receipt of a two-cent stamp by George H. Daniels, Manager, General Advertising Department, Room 61-A, Grand Central Station, New York.

THE



TAKE YOU TO THIS REGION  
FROM EVERY DIRECTION

C. F. DALY                      W. J. LYNCH  
Passenger Traffic Mgr.      Passenger Traffic  
NEW YORK                      CHICAGO

## Telephone Call

only 5c. each

## Extension Stations

only \$6 per year

These are only two of the many attractive features of the new telephone rates, effective July 1st.

Contracts now being taken

Call nearest Contract Office for full information.

### NEW YORK TELEPHONE COMPANY

Contract Offices:	Telephone No.
15 Dey Street	9010 Cortlandt
115 West 38th Street	9040 38th
220 West 124th Street	9000 Morningside
616 East 150th Street	9020 Melrose

## REMOVAL NOTICE

We now occupy the new store of

The Lorsch Building, 35 Maiden Lane, N. Y.

# WOLFSHEIM & SACHS

MAKERS OF

Fine Boxes, Trays and Novelties for Jewelers and Silversmiths

35 MAIDEN LANE, N. Y.

Telephone, 3518 John.

Factory, 10 Gold Street.

## SIGNS

WE make all kinds from the smallest card for your window to the mammoth display for your factory roof. Have made signs you could read a mile.

"No trouble to ship out of town."

THE FORMAN CO  
SIX LIBERTY PLACE  
NEAR MAIDEN LANE · NEW YORK



is not the slightest confusion. The  
of the utterance has not been made  
use for incoherence.

There is in the group the exquisite feel-  
ing or mass which is like the unison of  
a perfectly controlled orchestra, through  
the most impassioned performance is  
the restraining touch of the baton.  
Though the subject of the group is that  
of flight under the disintegrating in-  
fluence of terror, the striking note of the  
composition is repose. To produce an  
impression of repose by a reliance solely  
on the subject, is a matter of compara-  
tiveness; to produce it by a reliance solely  
on artistic treatment, indeed in this  
actually in spite of the subject, is to  
be at a bound to an exceptional mastery  
of sculptural expression.

It is certainly easier to record results  
than to point out their source, yet it is  
very clear that in this group the sculp-  
tor triumphantly solved several of the  
most difficult sculptural problems. Note,  
for instance, how he treats the subtle prob-  
lem of suppression. Note the backs of the  
figures, every muscle is not insisted upon,  
there is no sense of bareness, every  
part has its due interest. The result of this  
delicate suppression is that the spectator's  
eye does not painfully bump along the  
line as in the case of so many modern  
sculptors, but is encouraged to follow the  
sweeps of significant and beautiful  
lines. Again, see how the chief elaboration  
of the man is upon the long strained heads of  
the animals, with their wide nostrils, their  
wild, savage mouths, which express  
so much of the spirit of the myth.  
With what skill our interest is really  
kept up and centered upon the point  
which the sculptor has selected, yet nothing  
easier than by too great a neglect of  
the spots to fasten our attention on pres-  
ents that which the sculptor would have  
missed by. The manes are treated, not  
merely, but sculpturally, the 28 legs are  
modelled under the influence of in-  
stantaneous photography, but the instanta-  
neous impress of the brain, which records,  
the confused jumble of minute contra-  
dictory contortion, but the co-ordinated  
portion of rapid motion.

**Recent Decisions by General Appraisers on  
Terra-Cotta, Statuary, Earthen Ware, Etc.**

**Terra-Cotta Statuary.**—Protest of Mrs. E. H. G.  
against the assessment of duty by the Col-  
lector of Customs at Washington. Certain terra-  
cotta statuary was held to have been properly  
classified under Par. 96, Tariff Act of 1897, re-  
sulting in undecorated earthen ware, the Board  
reversing the contention that it should have been  
classified as works of art.

**Statuary, Medallion.**—Protest of John Wana-  
maker against the assessment of duty by the Col-  
lector of Customs at Philadelphia. A statue and  
medallion, classified under Par. 115, Tariff Act  
of 1897, as manufactures of marble, were claimed  
dutiable as statuary as defined in Par. 454,  
Act of 1897. The protest was sustained as to  
the statue and overruled as to the medallion.  
5501 (T. D. 24822) and G. A. 5225 (T. D.  
10) followed.

**Decorated Steins.**—Protest of Moses Norris  
against the assessment of duty by the Collector of  
Customs at Baltimore, G. A. 5948 (T. D. 26095)  
referred, relating to decorated steins.

The Gotthelf Jewelry Co., Vicksburg,  
Miss., has moved its stock into larger quar-  
ters directly opposite the old location.

**Odd Silver Necklaces Made by Skillful  
Navajo Jewelers.**

There arrived at B's big curio store  
something that there has been a good  
deal of inquiry for by collectors of curios—  
silver necklaces of the Navajos. They are  
exceedingly rare. Mr. B. has been trying  
for a long time to get some of them, but  
never until yesterday did he succeed. He  
has now only three. One is known as the  
chief's necklace, another as the necklace of  
the medicine man, and the third is a simple  
necklace.

The necklaces are made of coin silver.  
The beads are hollow globes of silver of  
varying sizes. The pendent is the sign of  
authority, and in both the chief's and the  
medicine man's necklace it is a sort of  
crescent, the horns of which nearly meet.  
Within the pendent of the chief there is  
a smaller pendent set in turquoise. The  
medicine man's necklace is without this in-  
ner pendent and is also less highly orna-  
mented.

The origin of this sign of the crescent is  
lost in antiquity. It is only known that it  
prevailed among the prehistoric races, for  
in the ruins of the cave dwellers' abodes are  
found the shell necklaces in which the same  
form of pendent figured. There is one of  
these prehistoric necklaces on exhibition.

Besides these necklaces there are many  
other articles of Navajo jewelry. There  
is the chief's belt, formed of several shields  
of silver, each shield being made of ten  
silver dollars. Then there are the silver  
bracelets of various widths and designs;  
there are the souvenir spoons, no two alike;  
in fact, the Indians never made two spoons  
of precisely the same design. There are  
buttons made of silver coins. On the inner  
side of some of them the stamp on the coin  
is yet visible. There is a very large variety  
of Indian rings, some of them set with  
turquoise and other native stones.—Phoenix  
(Ariz.) *Republican*.

**Maiden Lane.\***

DOWN Maiden Lane, where clover grew,  
Sweet-scented in the early air,  
Where sparkling rills went shining through  
Their grassy banks so green, so fair,  
Blithe little maids from Holland land  
Went tripping, laughing each to each,  
To bathe the flax or spread a band  
Of linen in the sun to bleach.

More than two centuries ago  
They wore this path—a maiden's lane—  
Where now such waves of commerce flow  
As never dazed a burgher's brain.  
Two hundred years ago and more  
Those thrifty damsels, one by one,  
With plump round arms their linen bore  
To dry in Mana-ha-ta's-sun.

But now! Behold the altered view;  
No tender sward, no bubbling stream,  
No laughter—was it really true  
Or but the fancy of a dream?  
Were these harsh walls a by-way sweet  
This floor of stone a grassy plain?  
Pray vanish modern city street  
And let us stroll down Maiden Lane!

\*From "In Sun or Shade," by Louise Morgan  
Sill. Published by Harpers.

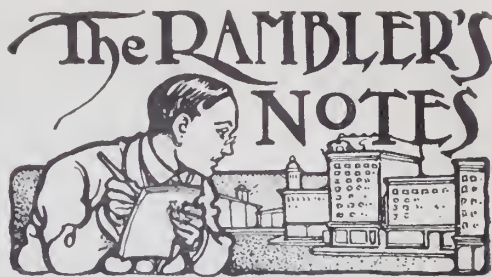

THE CUT GLASS  
TRADE IN SUMMER.

A FEW samples of  
cut glass are  
making their appear-  
ance in some of the

New York salesrooms, and they will keep  
coming for another month or six weeks.  
Some of the salesmen will soon start on  
their Summer trips, and the ranks of the  
men in the field will be enlarged each week  
until all the territory will be covered by the  
middle of August. In the warm months of  
the year the salesmen are generally the only  
busy men connected with the glass making  
and glass cutting industries. The glass  
works are now running quite light, and, as  
is usual, most of them will shut down for a  
considerable part of the next two months.  
Glass cutting factories, it is understood, are  
quite well provided with blanks to turn out  
any urgent orders during the Summer, but  
in these works also the two warm months  
of the year are mostly given up to vaca-  
tions, the making of necessary repairs,  
cleaning up the machinery and things of that  
kind. By September everything will be in  
readiness at the factories, so that work may  
be started with a rush. By that time the  
salesmen will naturally have sent in a suf-  
ficient quantity of orders to make the wheels  
hum for a time. It is generally remarked,  
too, that after the Summer lassitude every-  
body gets extremely busy, all at once. Buy-  
ers who had been indifferent for weeks be-  
gin to inquire about deliveries. The deliv-  
eries for the Fall trade begin in earnest  
early in October, especially for freight ship-  
ment from the eastern factories to far  
western points. For nearby shipment No-  
vember is sufficiently early as a rule. All  
the prominent cutters will offer as usual a  
considerable number of new designs which  
have been prepared in the course of the last  
year. The staple lines are generally made  
up in stock of sufficient quantities, so that  
orders may be delivered at any time. In the  
new designs the quantity to be made up will  
generally await the judgment of the trade,  
as shown by the early orders.

RICHLY DECORATED  
DOMESTIC CHINA.

IN the factory  
show rooms of  
Lenox, Inc., Trenton,  
N. J., a new line is  
now on exhibition, including acid gold bor-  
ders, on fish, game and service plates, tea  
sets, carving sets and fruit sets. This com-  
pany is inviting a discriminating class of  
trade by making a feature of individual  
services with monograms and family crests.  
The confidence of this domestic manufac-  
turing house in the output is indicated by  
the fact that the management urges the trade  
to call and inspect the samples in order  
to make comparisons with the china pro-  
duced in other countries.

THE RAMBLER.

# SPECIAL NOTICE

Our line of samples of European Novelties will be withdrawn on July 1st.

Jewelers seeking a collection of choice pieces should not fail to inspect this display. *~ ~ ~ ~ ~*

## C. F. RUMPP & SONS Fine Leather Goods

NEW YORK SALESROOMS  
683 and 685 Broadway

PHILADELPHIA



These well-known Razors, the quality of which is warranted, possess this great advantage, that they may be used for ten years before they require actual sharpening. Before using them it is necessary to rub them on good leather strop. Le Coultre's Strops (to be had with the Razors) should be used in preference to others.

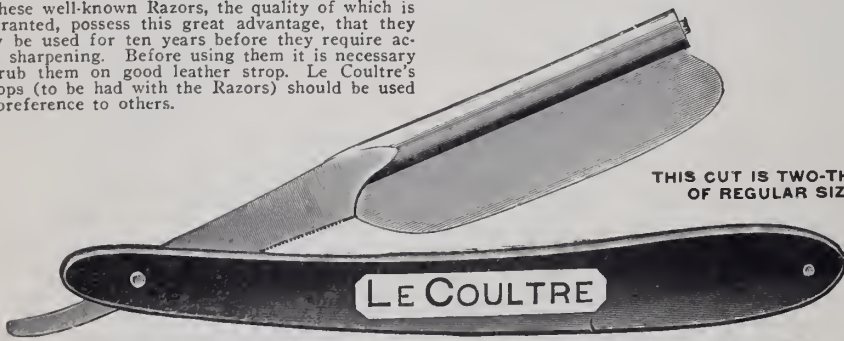

THIS CUT IS TWO-THIRDS OF REGULAR SIZE.

"SPECIAL"—Single Razors for Jewelers' Travelers at trade price.

**MATHEY BROS., MATHEZ & CO.**  
Send for Price-list. Sole Agents, 21 & 23 MAIDEN LANE, N. Y.



**HERMAN KOHLBUSCH, Sr.,**

ESTABLISHED 1859.

Manufacturer of Fine Balances and Weights for every purpose where accuracy is required.

Office and Salesroom, 194 BROADWAY, NEW YORK.

Send for Price List.

Tel. 370 Cortlandt.



**Horological Department,  
BRADLEY POLYTECHNIC INSTITUTE,  
Formerly Parsons Horological Institute,  
PEORIA, ILLINOIS.**

Largest and Best Watch School in America. We teach Watch Work, Jewelry, Engraving, Clock Work, Optics. Tuition reasonable. Board and rooms near school at moderate rates. Send for Catalog of Information.

## PATENTS

obtained on inventions and designs. Trade-marks, prints and labels registered.

**R. W. BISHOP,**  
ATTORNEY AT LAW,

908 C Street N.W., Washington, D. C.

**JACOB BASCHKOPF,  
DIAMONDSETTER,  
LETTER AND MONOGRAM  
ENGRAVER,  
9-13 MAIDEN LANE,  
Room 701  
Jewelers' Bldg. NEW YORK.**

### LEARN WATCHMAKING AT HOME

by THE De SELMS CHART SYSTEM, copyrighted and patented most simple, practical and up to the minute method of learning. Saves you time and money while learning and puts you in a position more than double your income. 50 million timepieces to be repaired. Accurate time is a necessary business world. When time is money the watchmaker gets the profit. Position for graduates. Booklet free. Write to-day.

The De SELMS WATCH SCHOOL,  
109 Perry Street, ATTICA, IND.

**MAEBERT & REIS  
WATCHMAKERS TO THE TRADE  
Wheel Cutters and Adjusters**

Accurate Work—Low Prices—Quick Repairs. We receive parcels by mail or express from all over the United States.

71 and 73 NASSAU ST., Corner Jobbers' Bldg.  
(The New "Cockcroft" Bldg.) NEW YORK

**Expert WATCH and Chronometer REPAIRING  
FOR THE TRADE.**

When others fail you we guarantee satisfaction. A trial will convince. Prices very reasonable. List will be sent on request.

**G. OHAN, 37-39 Maiden Lane,  
Lorsch Bldg., Room 27. NEW YORK.**

### "PRACTICAL COURSE IN ADJUSTING"

Price, \$2.50.

All Jobbers or Jewelers' Circular Publishers

*Mercantile Fountain Pen*

## The Best Self-Filling Attachments

made and guaranteed by

**AIKIN, LAMBERT & CO.,** 19 Maiden Lane, NEW YORK.

Retail Price:  
**\$3.00**  
**\$3.50**  
**\$4.50**

Send for Price Lists and Discounts.





**Price  
\$3.00**

(Pat. Feb. 7, 1905.)

The LATEST, the BEST and  
the ONLY ACCURATE

# Pallet Stone Setting Tool

on the market, used in connection with the Depthing Tool. With this tool you can set a pallet stone in fifteen minutes, in place of from one to four hours at guess work. With the above instrument there's no guess work. In less than fifteen minutes your pallet is set correctly.

FOR SALE BY

**The Columbian  
Jewelry Supply Co.**

22 West 2nd Street, Central Block, 1st Floor  
PUEBLO, COLO.

Send for descriptive circular  
Write us for prices on Clock Tools and Materials  
JOHN A. BLAIR, Manager

**A \$15**

**Assortment**

OF

**BRACELETS**

OR A

**\$25**

**Assortment**

OF

**COMBS**

will be sent to your store on approval by prepaid express. If, on examination, they do not prove satisfactory in all respects you may return them at our expense. These assortments are made up of the latest designs and make a large and beautiful display. Something to satisfy everyone. Write to-day for one and see for yourself.

## C. H. EDEN COMPANY

**NEW YORK OFFICE**  
699 Broadway

**ATTLEBORO,**  
MASS.

# BLANCARD & CO.,

96 MAIDEN LANE,  
NEW YORK.

**WELL MADE GOLD FINDINGS.**

**ACOT MUSIC BOX CO.,  
IMPORTERS.**

Cellula and Ideal Music Boxes,  
39 UNION SQUARE, N. Y.

**L. Nonnenmann & J. Aschenbrenner,**  
114-118 East 23d St., New York.

**Original Designers** for Platinum,  
Gold and Silver  
Jewelry. Artistic  
Designs for Silverware and Novelties fur-  
ished at shortest notice.

**Trade-Marks** of the Jewelry and  
Kindred Trades.  
Second Edition. Price, \$3.00. The Jewelers' Cir-  
cular Publishing Co., 11 John St., New York.

# FAIRCHILD & COMPANY

225 to 233 Fourth Ave.

NEW YORK CITY.

Manufacturers of GOLD PENS, PENCILS,  
PENHOLDERS, SEGAR CUTTERS, SPE-  
CIALTIES, PENCILS SET WITH JEWELS.

*Style, quality and workmanship acknowledged  
the very best.*



DAY  
CLASS

## ENGRAVING

NIGHT  
CLASS

THE SCHOOL FOR THOSE WITH MODERATE MEANS  
**POMFRET-GOLDY SCHOOL OF JEWELRY ENGRAVING**  
SEND FOR PROSPECTUS 319 HEED BUILDING, PHILADELPHIA, PA.

# DIAMOND POINT FOUNTAIN PENS



No. 2WC \$7.50 per dozen. Guarantee in every box.

Largest Manufacturers of Popular Price Fountain Pens in the United States.

Send for illustrated price list of 14-Kt. Gold Fountain Pens.

Good case assortment 1 dozen pens, \$9.00.

**DIAMOND POINT PEN CO.**

100-102 Beckman Street, New York

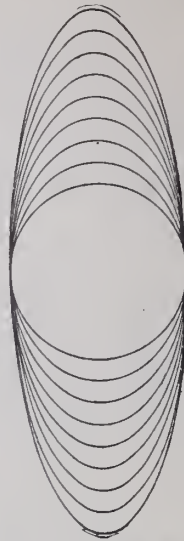
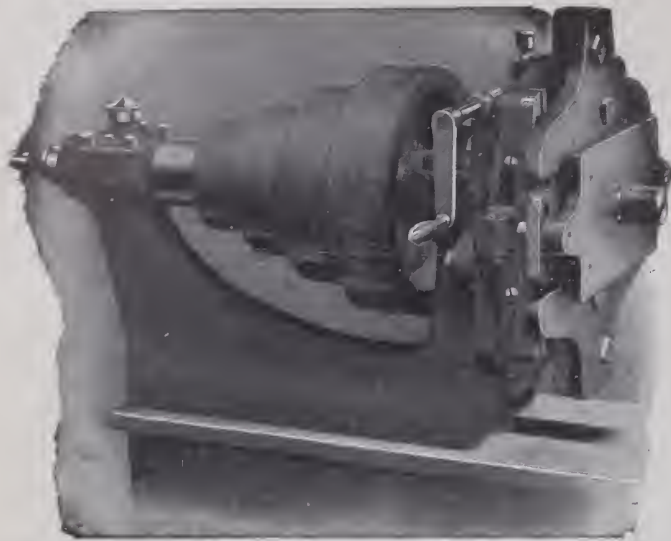

## Our Oval Spinning and Turning Lathe.

Our cuts show headstock Lathe and variety of ellipt produced on same, retaining minor axis.

Write for our Catalogue Spinning Lathes.

**P. PRYIBIL,**  
520 W. 41st Street, New York

### ROLLED GOLD PLATE **SEAMLESS WIRE AND TUBING**

**DUNBAR, LEACH, GARNER CO.,**  
MANUFACTURERS,

ATTLEBORO,

MASS.

### Opportunity

Knocks at everyone's door at least once. This is yours if you would realize full value on your sweeps, etc.

### CONLEY & STRAIGHT,

Gold and Silver Refiners,  
Assayers and Sweep Smelters,

236 EDDY STREET, - PROVIDENCE, R. I.

Dealers in Fine Gold,  
Silver and Copper.

All kinds of Gold  
and Silver Anodes

### WM. F. RENZIEHAUSEN CO., GOLD and SILVER REFINERS

Sweep Smelters, Assayers and Analytical Chemists

Rolling of FINE AND STERLING SILVER a Specialty.

Long Distance Telephone, 3759-R.

45-49 Oliver Street, NEWARK, N. J.

### JAMES J. DONNELLY,

Gold and Silver Electro Plater,  
Fire Gilder and Colorer,

41 and 43 Maiden Lane, New York

Prompt Attention Given to Mail Orders.

WHY NOT SEND YOUR SWEEPS DIRECT TO THE SMELTERS

# LEES & SANDERS, BIRMINGHAM, ENG.

Our plant is right up-to-date and specially arranged for smelting jewelers' sweepings.

SEND ON AN ENQUIRY FOR REFERENCES ON YOUR SIDE.

ESTABLISHED IN 1870.



### WE BUY

Old Gold and Silver Filings, Polishings, Sweeps, Hand Washings, etc. We will make accurate valuations and hold consignment subject to your acceptance. If valuation is not satisfactory, we reship to you at our expense.

#### WE PAY FOR OLD GOLD:

22 K. 88c. per dwt.	12 K. 48c. per dwt.
20 K. 80c. " "	10 K. 40c. " "
18 K. 72c. " "	8 K. 32c. " "
16 K. 64c. " "	6 K. 24c. " "
14 K. 56c. " "	4 K. 16c. " "

MARKET RATES FOR SILVER AND PLATINUM.

Try us and you will appreciate our Squareness, Promptness and Accuracy.

**T. B. HAGSTOZ, Ltd.,** Main Office, 709 Sansom St., Philadelphia, Pa  
SMELTERS, ASSAYERS, REFINERS.

### WE SELL

Gold, Silver and Platinum, various qualities, rolled flat or drawn to wire of any gage.

#### PRICES OF ALLOYED GOLD:

10 K. 48c. per dwt.	14 K. 64c. per dwt.
12 K. 56c. " "	16 K. 72c. " "
18 K. 80c. per dwt.	

Gold and Silver Solder, either from formulas furnished or our own. "T. B. H." Alloy, 25c. per oz. Guinea Gold 75c. per lb. Shot Copper, 40c. per lb. We will send table for alloying without charge. They save figuring.



M2426

# FAHYS

## Montauk Cases

---



M2290

They wear—

That's why they are such stars. For no matter how good a case may look when it's new, what counts most is the way it looks when it's old.

And though we're proud of the new looks of the Montauk, it's their old looks that keep the business growing.

The Montauk has always been a successful case, the price and quality have never been juggled with. The sale this year is far in excess of any previous year, a feature that speaks volumes.

• JOSEPH FAHYS & CO.

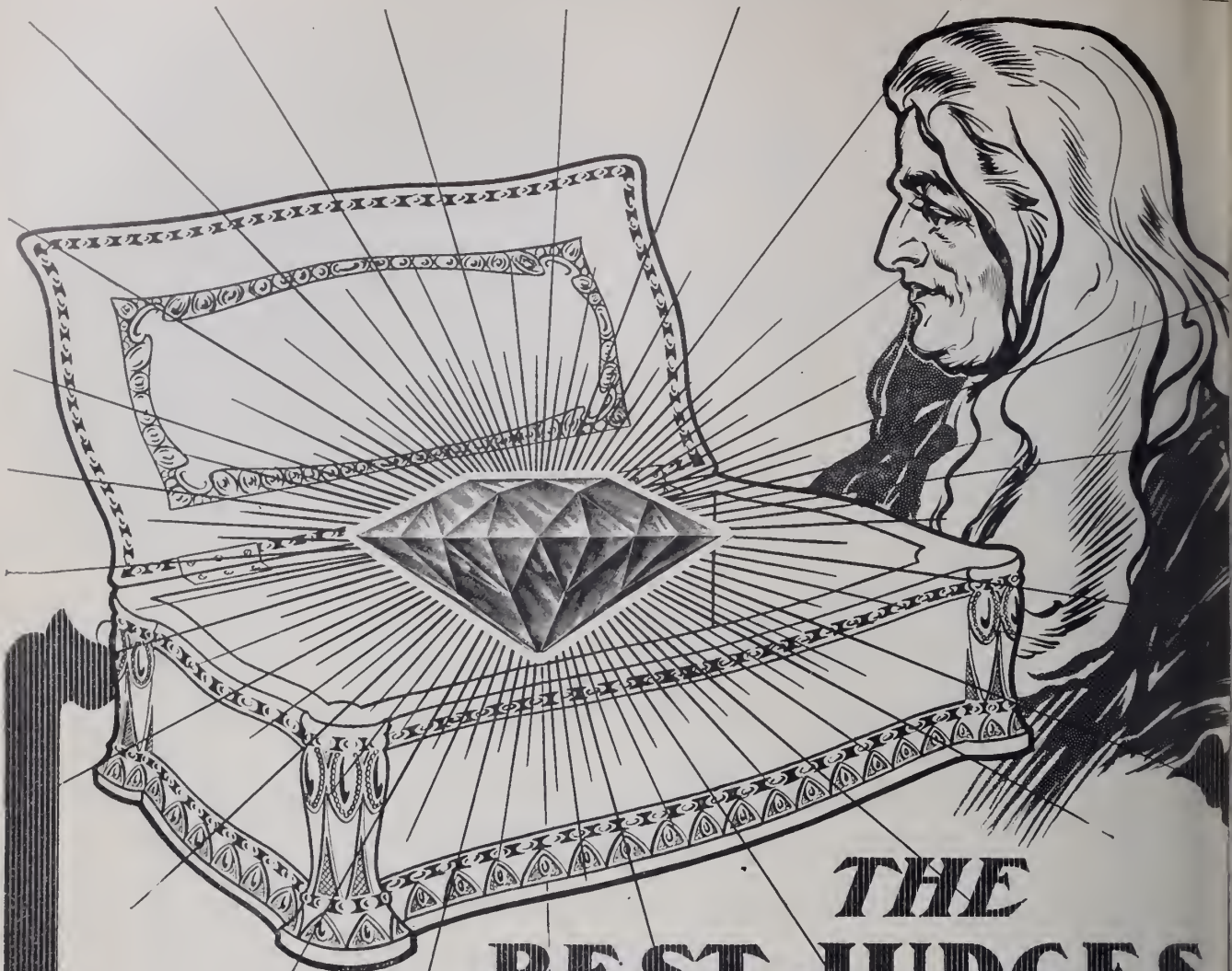

## THE BEST JUDGES

Are the most critical as to the cutting, when considering the worth of a diamond—it's the cutting that makes the diamond brilliant—it's because of its brilliancy that the diamond is so highly prized.

The diamonds we offer are cut in our own cutting works, and no effort spared to see that they are cut right. The price we ask for them—the actual cost of the rough stone, plus the workmen's wages, with our modest profit added.

---

**J. R. WOOD & SONS,**  
Diamond Cutters,

Cutting Works:  
1327-1329 Atlantic Ave., Brooklyn.

2 Maiden Lane, New York.



## We Stand Behind Everything We Sell

guaranteeing it to be exactly what it is represented to be.

You can be perfectly sure that you are getting the quality you think you are buying, and that the workmanship is the very best obtainable—while you are paying nothing extra for this, for our prices are the lowest it is possible to furnish honest goods for.

---

**J. R. Wood & Sons,**  
RING MAKERS,  
2 Maiden Lane, New York.

# Design, Workmanship, Quality and Durability

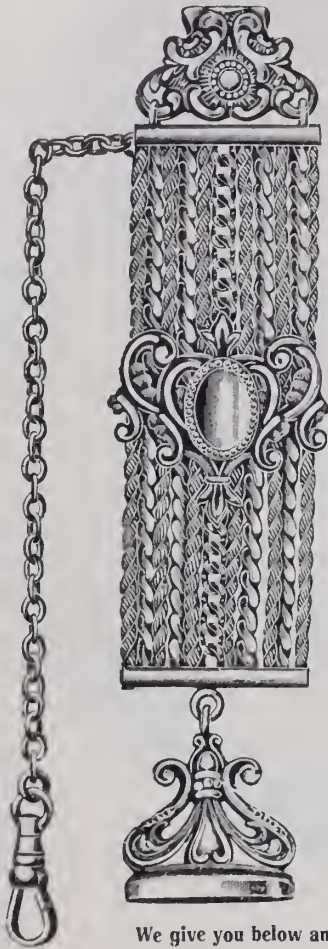

are the four factors which have made the

## BIGNEY CHAINS

the most popular in the market to-day. They are handled and worn by more people than any other make.



We give you below an exact copy of an assay of chains manufactured by the leading chain makers of the United States.

1-10 GOLD FILLED WATCH CHAINS, MINUS BAR AND SWIVEL.

Number	Gross Weight Ounces	Dec.	Finess Gold 1000ths	Value	Maker	Chain Number	Cost
15		71	29½	\$0.43	S. O. Bigney & Co. - - - -	1155	\$2.85
16		75	50	.775		482	3.08
17		81	34	.57		3005	2.73
18		76	23½	.37		9533	2.97
19	1	00	16½	.31		83	2.14
32		52	49½	.53		213 X	2.83
34		73	34½	.52		733	2.41
46				.58		5011	3.82

1-8 CHAINS, MINUS BAR AND SWIVEL.

Number	Gross Weight Ounces	Dec.	Finess Gold 1000ths	Value	Maker	Chain Number	Cost
35		57	68	\$0.80	S. O. Bigney & Co. - - - -	1604	\$3.96
36		60	65½	.81		7015	3.75
37		60	63	.78		4324	4.00
47		49	79	.80		2726	4.00

# S. O. Bigney & Co.

NEW YORK OFFICE,  
3 MAIDEN LANE.

FACTORY, Attleboro, Mass.

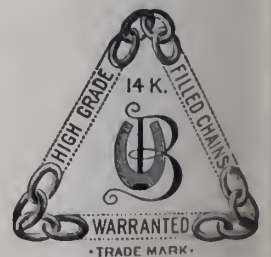
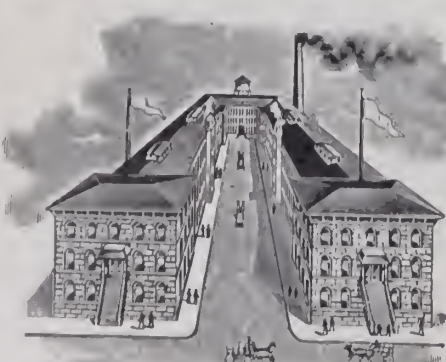



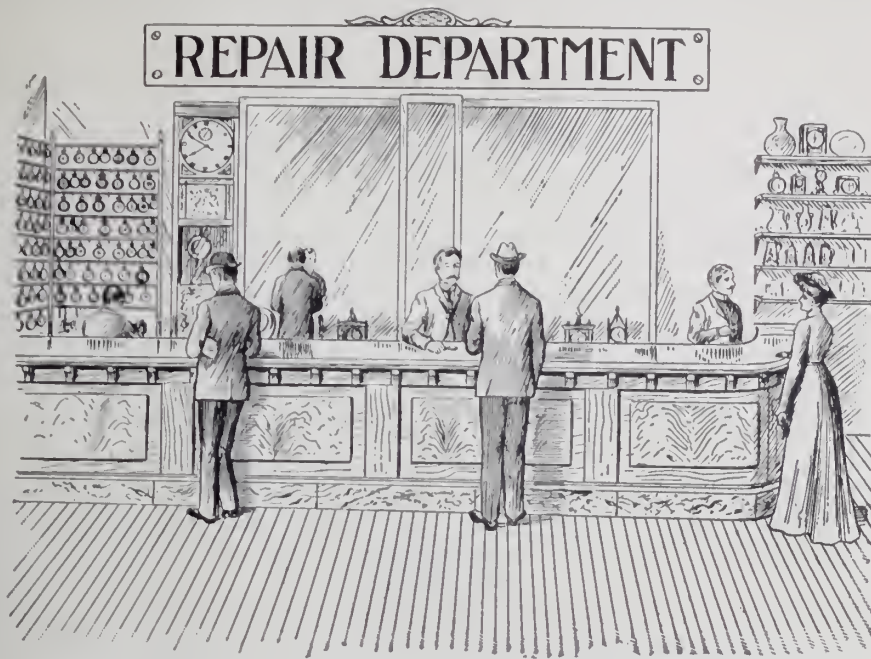

# The REPAIRING

**END OF YOUR BUSINESS IS THE MOST IMPORTANT PART OF IT**

More people come into your store to leave work than to purchase goods.

Almost every one of your good customers became so through your repair department.

Progressive jewelers know this and concentrate their efforts on the repair department of their business. They give it the most prominent place in their stores; they emphasize it in all their advertisements; they keep themselves and their employes thoroughly informed of the costs of all kinds of work, new ideas and methods; they are courteous and accommodating to repair customers; have all work ready when promised; and do only such work at home as they can do well.

They send all the rest to us.

We devote our entire time, energy, capital, and twenty-five years' experience to this important branch of the jewelry business; employ and educate the best help that can be obtained; systematize and inspect the work, and use every modern method to produce the best work promptly at reasonable prices.

It is to your interest to do business with us, it is to our interest to have you.

Let us work together.

## WENDELL & COMPANY

**The Special Manufacturers for the Retail Jewelry Trade  
Do a larger variety of work than any other firm in the country**

**TWO WONDERFUL SHOPS:**

**103 and 105 William Street**  
Near Maiden Lane  
**NEW YORK**

**57 Washington Street**  
Near State Street  
**CHICAGO**

## WHY

are the **WADSWORTH WATCH CASES** the most attractive line on the market?

## BECAUSE

they are a Brand New line—new engravings, new styles, finest finish, up-to-date in every respect..

## CERTAINLY

you should familiarize yourself especially with our **PILOT** (25 year), our **TWENTY YEAR** and our **PERMANENT**.

Are you numbered among the thousands of satisfied dealers who have distributed more than one million **Wadsworth Watch Cases** in 17 years?

We are satisfied that careful investigation and a comparison with other makes will convince you that there is merit, worth and wear in **Wadsworth Solid Gold** and **Gold Filled Watch Cases**—the most profitable and best selling cases you can handle.

**I**T is the unanimous opinion of those jewelers who have examined the new O and 12 size movements of the ILLINOIS WATCH CO. that they are the best watches in these sizes ever manufactured in America.



**S**ILVERWARE destined for the general service and adornment of the table should, in order to be wholly satisfying, possess not only a markedly decorative effect, but an opulent dignity and a well defined individuality of design.

¶ It is the belief of the Whiting Company that in their new Louis Quatorze pattern, which has been applied to every article suitable for table use, these essentials of success are very prominently displayed.

¶ With the confidence born of this belief, therefore, they beg to call attention to their novel and original treatment of one of the most popular, as it is one of the most effective, of historical styles.



**WHITING MFG. CO., SILVERSMITHS**  
 Broadway and 19th Street, New York.

# Progression

This word signifies the course, and

# Success

indicates the goal attained by

## Dueber-Hampden Watches

**Pre-eminently and indisputably the  
Successful American Watches**

in all sizes and grades.

Requiring no assistance but their own inherent value to find a market, and depending on no combination to bolster up weakness and lend help to force sales, they should be valued accordingly by fair-minded, independent, self-respecting Americans.

## **The W. J. JOHNSTON COMPANY,**

Wholesale Agents of the Leading American Watch Companies,

**Fifth Avenue and Market Street, Pittsburgh, Pa.**

# Looking Forward

is ever necessary

## To the Successful Merchant.

**What you sell to-day is responsible  
for your future Reputation  
and Prosperity**

If poor judgment is used you are entitled to no more excuse than though you had deliberately sold what you knew to be inferior goods.

There is always "**THE BEST,**" and in watches that term stands out prominently for

# Illinois Watches and Hamilton Watches

**The W. J. JOHNSTON COMPANY,**

Wholesale Agents of the Leading American Watch Companies,

**Fifth Avenue and Market Street, Pittsburgh, Pa.**

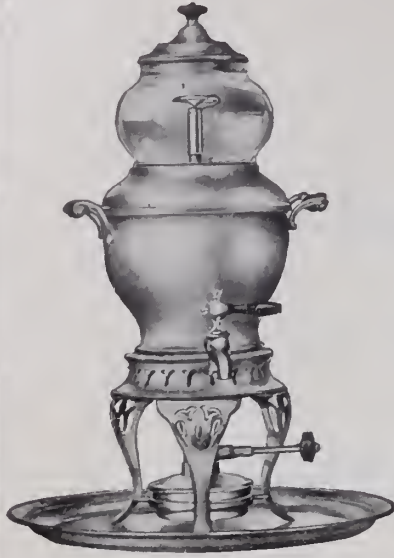

# DO YOU realize that most of your customers drink Coffee?

They are doubtless interested in the best methods of making coffee. Nothing is so difficult to obtain as a cup of really good coffee, not because of the poor quality of the bean itself, but because few people really understand how to prepare it as a beverage. The injurious effects from the use of coffee are due to boiling, and the consequent extraction of caffeine and other deleterious substances.

In the Sternau Coffee Machine the coffee is distilled, not boiled, and thus only the wholesome properties are extracted.

The Sternau Coffee Machine is invaluable on the yacht or at the summer house.

Jewelers should see that they are well stocked with Sternau Coffee Machines, for they are in constant demand. Made in copper, nickel-plate, and silver-plate.

Let us furnish you with illustrations and quotations.

New York Salesrooms:  
Broadway, cor. Park Place,  
Opposite Post Office.

**S. STERNAU & CO.**  
*Makers of Chafing Dishes and their Accessories,  
Fancy Kettles, Smoking Sets, etc.*

Office and Factory:  
195 Plymouth Street,  
Brooklyn, N. Y.

# BATES & BACON,

NEW YORK OFFICE  
9 Maiden Lane

ATTLEBORO, MASS.

CHICAGO OFFICE  
103 State Street

Makers of:

## HIGH GRADE CHAINS.

The BEST SAFETY FOB is one of our specialties; Gent's Vests, Dickens, Lorgnettes, Secret Locket Chains, Locketts, Chate-laines, and the unexcelled

## "Bates" Bracelet

"KANT-KUM-OFF"

## Seven Sizes.

Just the Bracelet to be worn over the Long Gloves so much in Fashion.

**NO HUNTING** for the Invisible Catch.  
**Just PULL and TWIST.**

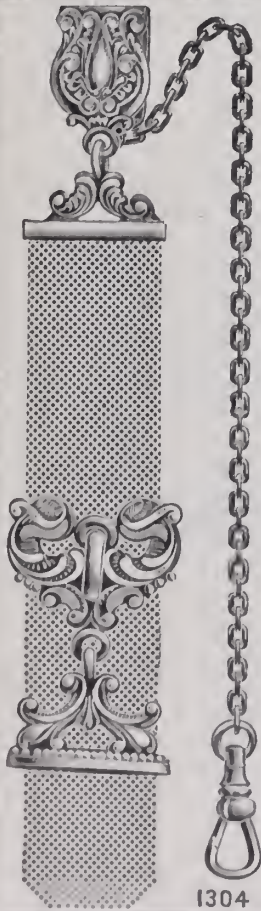
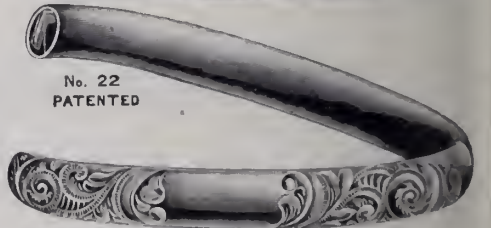

1304



*"We never follow the Fashion, the Fashions Follow Us."*

MAURICE L. POWERS.



JOSH W. MAYER.

## NEW DEPARTURE.

THE chief motif of our special designing for our exhibit is essentially conservative decoration for the wearer. To meet the demand of a growing artistic taste for jewels of this character and quality is uppermost in our mind in creating it. In all respects this jewelry differs materially in construction from others; a difference that makes it distinctive, not altogether unconventional, and, withal, in no sense irrational. It is practical and effective where elegance is required and possesses to a marked degree all the charm of individuality. In the hands of clever and ingenious artists, much may be done with it.

What we call "The New Departure" is a pronounced innovation, and while it is anticipated that this is likely to be regarded by old-fashioned makers as "freakish" and provoke much adverse criticism, yet this is one of its most distinguishing features and lends to the face a style peculiar to itself.

So far as we have gone with our new effects, we are especially well pleased with the manner in which our designers and workmen have carried out our original ideas; these will be shown at our fourth exhibition to be held in our offices from August 13th to 18th inclusive.

Once a visit always a visit.

### POWERS and MAYER,

Makers of Diamond Mounted Jewelry THAT SELLS.

258-260 Fifth Avenue,  
NEW YORK.

We are always pleased to ship goods on memorandum when satisfactory references are given.



# THE Bracelet Hit OF THE Season.

THE illustrations, which are exact size, show two of the best selling Bracelets of a big bracelet season

Made of Rolled Plate, Pierced, Engraved—a neat, strong joint and catch—with and without stones, from ½ to 1¼ inches wide.

Our line offers an unsurpassed range of styles.

ASK YOUR JOBBER—HE HAS THEM.

**WHITING & DAVIS, Plainville, Mass.**  
NEW YORK OFFICE, 7 MAIDEN LANE.

We Make

## BRACELETS

both in Joint and Nethersole—with and without stones.  
Call on us for the P. & B. Co. lines of

FOBS, LOCKETS,  
TIE CLASPS, BROOCHES,  
SCARF PINS,  
HAT PINS.

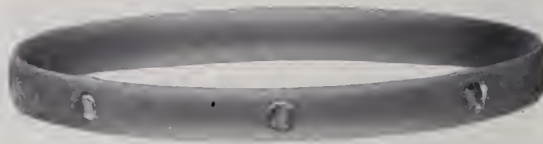

BABY PINS, BEAD NECKS  
CUFF BUTTONS,  
CROSSES, BRACELETS,  
AND WAIST SETS.



We are the largest  
Exclusive Makers of  
10K. Jewelry.

Potter  
&  
Buffinton  
Co.,  
Providence,  
R. I.

NEW YORK OFFICE,  
65 Nassau Street.

San Francisco Office,  
206 Kearny Street.



Our New  
ACME  
Joint.  
Pat. May 22 1906.

# WE DO NOT SELL DEPARTMENT STORES

We Study the Interests of the Retail Jeweler

---

At a meeting of the directors of the W. & S. Blackinton Company, held May 28, 1906, the following resolution was adopted:

“Resolved: That on and after July 1, 1906, we confine our sales strictly to the legitimate jewelry trade, through the jobber.”

W. & S. BLACKINTON CO.

We believe it is impossible for us to sell department stores without injury to the retail jeweler. In declining the trade of department stores we close many large accounts. However, we are convinced that the adoption of this policy of protection to the retail jeweler and jobber will work to their best interests, as well as to our own.

---

## W. & S. Blackinton Co.

Manufacturers of Old Reliable W. & S. B. ★ Chains and Locketts  
NEW YORK, 14 Maiden Lane      NORTH ATTLEBORO, MASS.

---

A selection package will be sent through any jobber whom the retailer may designate.

# The Allsopp Rings

THE UP-TO-DATE LINE OF  
**SIGNET AND SET RINGS**



In twenty years we have built up a business second to none in Rings exclusively. ALLSOPP QUALITY, DESIGN and WORKMANSHIP appeal to the most fastidious. It will pay you to examine a selection package.

**A ★**  
TRADE-MARK.

**ALLSOPP BROS.,** ALLSOPP BUILDING, Newark, N. J.

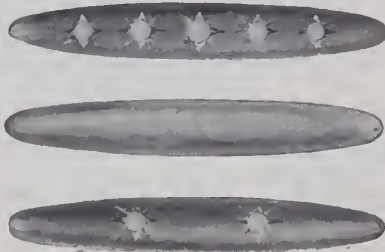

Quality and Finish Consistent  
with twenty years' experience.  
Original and Exclusive Designs.

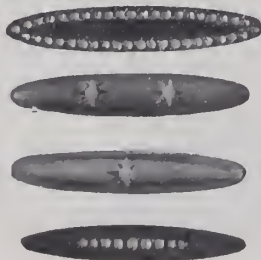

**MOORE & SON,**

ESTABLISHED 1886. NEWARK, N. J. INCORPORATED 1903.

## SIGNET RINGS



TRADE  MARK

**Geo. O. Street & Sons**

Est. 1837

24 John St., New York.  
103 State St., Chicago.

**ROBERT DULL,**  
DESIGNER,

Etching in Gold and Silver,  
Telephone, 3980 Chelsea.

No. 70 5th Avenue, NEW YORK

# The Bowden Rings

ARE COMPLETE IN VARIETY, CORRECT IN  
QUALITY AND PERFECT IN FINISH. WE  
MAKE EVERY VARIETY OF FINGER RINGS.

**J. B. BOWDEN & CO.,**

1 Maiden Lane.

NEW YORK.

# R., L. & M. Friedlander

IMPORTERS OF  
**DIAMONDS**

JOBBERS IN  
**American Watches**

**Wholesale Jewelers**

30 Maiden Lane  
NEW YORK CITY

97 Hatton Garden, London, Eng.

---

**SUMMER NOVELTIES**

Advance Styles in

## COMBS

We are fully prepared with a large variety of

### COMBS

GOLD MOUNTINGS, with or without Diamonds, from \$2.00 to \$250.00 each.

GOLD FILLED, with or without Stones, from 75c. to \$4.00 each.

We herewith illustrate a few designs and quote lowest cash prices that speak for themselves. Freshen your stock by sending for some without delay. These goods afford a generous profit to the dealer and make new and pleased customers

No. 5,000	- -	\$1.80
No. 5,001	- -	1.80
No. 5,002	- -	1.80
No. 5,003	- -	1.80
No. 5,004	- -	1.60
No. 5,005	- -	2.40

LESS 6% FOR CASH

No Combs sent on Memorandum



*Our Mr. Richard Friedlander sailed last week on the Oceanic. The DIAMONDS selected by our Mr. Louis Friedlander, who has recently returned, have arrived and are now on sale.*

GOLD  
RINGS

BROOCHES AND MOUNTINGS

Also GOLD FILLED RINGS, including the popular THREE CROWN

Ostby & Barton Company respectfully announce to the jobbing trade that their fall line comprising many new and original designs is now ready.

OSTBY & BARTON COMPANY

New York, 13 Maiden Lane  
Chicago, 103 State Street

PROVIDENCE, R. I.



Tortoisene  
Combs

Mounted with 10-K. hand-work patterns. Every design is characteristic of originality and every detail is significant of superior workmanship.

*Tortoisene* is hard to detect from the real tortoise shell, having a rich effect that pleases the most skeptical in artistic hair treatment.

This cut represents a few of our patterns, actual size.

Combs will be much in demand throughout the year and orders should be in advance to insure prompt attention.

Prices on request.

Schultz, Leiss & Co.

OFFICES

New York, 14 John St. Chicago, 103 State St.

FACTORY

Cor. McWhorter and Oliver Sts., Newark, N. J.

# ZIMMERMAN'S ELK MASTERPIECE

Ever on the alert to improve our already most popular line of Elk emblems, we have added what we consider the

## Most Wonderful Reproduction of an ELK Head

in gold ever attempted. This is known as the Zimmerman Masterpiece of an Elk.



This Elk head is an exact reproduction in gold of Zimmerman's Masterpiece, "The Elk," which is world famous, receiving

## Prizes at Every Exhibition Where Shown

Every line in the painting has been faithfully reproduced by us in the emblem.

We are making this head in 3 sizes (medium, small and midget) in both gold and silver, and in various finishes, also combining it with the dial, with and without diamonds and other precious stones. If your jobber does not handle our line, send for a selection package. Our phenomenal success has inspired many imitators. There is but one line of FOX Emblems, and all goods of our make are stamped with this trade-mark  A quantity or low price may sell the first bill, but quality as well is required to get succeeding orders. Our goods are of the highest standard of quality.

# THE GUSTAVE FOX CO.

Branches in Antwerp, and Oakland, Cal. (temporarily)

14-16 E. Fourth Street, CINCINNATI, OHIO

# ROBERT LEVY'S

THE NAME THAT

STANDS FOR QUALITY

*Catchy ads. are good to read  
Catchy jewelry is good to sell*

Our **LOCKETS**  
**BUTTONS**  
**BROOCHES**  
**PENKNIVES**

**CIGAR CUTTERS**  
**MATCH BOXES**  
**BRACELETS**  
**FOBS**

**BEAD NECKS**  
**HEART CHARMS**  
**SCARF PINS**  
**TIE CLASPS, Etc.**

are the catchiest of the catchy.

Designs exclusive; workmanship par excellence.

Send for selection package and compare prices with other 10K. lines.

**10K. that is 10K.**

# ROBT. LEVY,

Manufacturing Jeweler

Green and Columbia Sts., Newark, N. J.

# Bangle and Link Bracelets.



EXPERIENTIA  
DOCET

ELEMENTS of distinction are characteristic of all Durand creations, and these new Bracelets do not fail to maintain the established standard. Link Bracelets in great variety. Gems add impressive effects.

PRICES: FROM \$12.00 to \$400.00.



EXPERIENTIA  
DOCET

Durand & Company,

49-51 Franklin Street,  
Newark, N. J.



## EVERYTHING IN MOURNING JEWELRY.

A. J. HEDGES & CO.,

Makers of Exclusive Designs in 14k. Jewelry.  
14 JOHN STREET, NEW YORK.

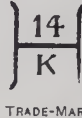

## Adjustable Glove Garters

IN  
GOLD AND SILVER

### Gold Jewelry

14K. in 10K.

Plain, Chased, Engraved, Diamond Set  
BRACELETS, BROOCHES,  
LINKS, LOCKETS, ELK  
BUTTONS, ETC.

Chas. L. Trout & Co.  
15 MAIDEN LANE, NEW YORK.

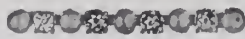

TRADE 14 MARK

## OSMUN-PARKER MFG. CO.

MAKERS OF

*Fine Pearl and Diamond Goods*

338 Mulberry Street  
NEWARK, N. J.

ESTABLISHED  
1871

Factory and Office: Newark, N. J.

INCORPORATED  
1900.

## CARRINGTON & CO., Patent Pocket Match Box

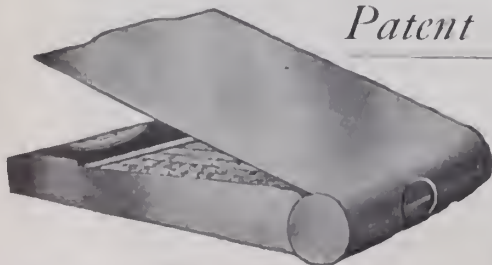

14K. ONLY IN STOCK.

Book Safety Matches with  
Steel Cigar Cutter.  
(Patented.)

Sales Agent:  
7 Maiden Lane,  
NEW YORK.



## Unique Silver Deposited WHISKEY JUG



7 Inches High.

Just one piece from one of  
the best selling and most  
attractive lines in town

Depasse Mfg. Co.,  
41-43 Maiden Lane, New York

## The ST. JAMES

Corner Walnut and Thirteenth Streets  
PHILADELPHIA, PA.

The Ideal Hotel of Philadelphia  
European Plan EUGENE G. MILLER, Mgr.





## Buckle-Pins for the WAIST

FEMININE ATTIRE in Summer creates a genuine demand for these goods. Lines like this make Summer business profitable to the jeweler.

Colonial Engraved, Vermicilli, Plain and Beaded Effects. Wide range of styles and sizes, all rich and artistic. Many set with Pearls, and such stones as Amethyst, Peridot, Jade, Etc.

STRICTLY WITHIN OUR LINE OF SPECIALTIES.

## Day, Clark & Company

14 KARAT ONLY

23

Maiden Lane  
New York



## WHITESIDE & BLANK June Bride's-Rose

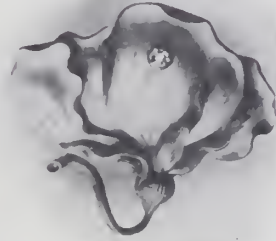

BROOCH No. 1685

*Pink Enamel  
and Green Gold*

NEWARK, N. J.,  
Lafayette and Liberty Streets.

NEW YORK,  
14 and 16 John Street.

ESTABLISHED 1841.

## Carter, Howe & Co.

TRADE MARK



MANUFACTURERS OF

## Gold Jewelry,

9, 11, 13 MAIDEN LANE, - NEW YORK.  
FACTORY, NEWARK, N. J.

A. CARTER.

G. R. HOWE.

W. T. CARTER.

W. T. GOUGH.

"THE BRACELET HOUSE."

## KENT & WOODLAND,

BRACELETS FOR EVERY WOMAN AND MISS.

16 John Street, New York.

San Francisco Office,  
Care JULIUS A. YOUNG.

"Nethersole Bangles,"  
Plain and with Stones.

"Pinhole" Secret Snap,  
with and without pre-  
cious and semi-precious  
stones.

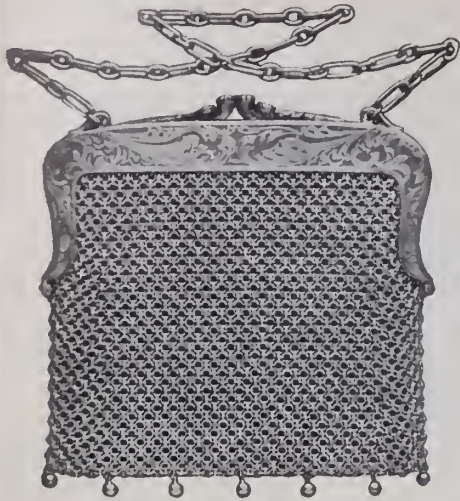

# S. Cottle Co.

are showing an entirely new and exclusive line of Gold and Silver BAGS and PURSES, also many lines of BRACELETS—all of superior workmanship and design.

31 East 17th Street,  
New York.



The Rosary  
in Fine Jewels

Fine Rosaries in pure and imitation stone. Mounted in solid gold and rolled gold-plate

ALL COLORS

Our special illustrated catalogue will give interesting advice regarding prices and discounts.



MADE BY

The **W. J. Feeley Co**

Providence, Rhode Island,  
Ecclesiastical Art Metal Workers.

## Bridesmaids' and Ushers' Pins

We would suggest something with color. Brooches, Scarf Pins and Handy Pins with Amethysts, Topazes, Garnets, Peridots, Aquamarines, Jades and Baroque Pearls. We have a large variety of patterns at moderate prices.

REGARDING OUR FOBS WE HAVE NOTHING TO SAY—  
THEY SPEAK FOR THEMSELVES.

# SNOW & WESTCOTT,

Makers of Good Jewelry for Over Seventy Years.

21 MAIDEN LANE, NEW YORK.

## SAM'L BUCKLEY & CO.

English Fancy Goods.



Carry in New York a full line of  
**ENGLISH PLATED WAITER**

118-122 Holborn, E. C.,  
London, England.

100 William St., New York

ADOLPH LUTHY.

PERCY W. HINE.

## LUTHY & HINE,

13 EAST 30TH STREET, NEW YORK.

MANUFACTURERS OF

### Artistic Gold and Platinum Mounted Diamond Jewelry.

Odd and Exclusive Patterns in NECKLACES, BROOCHES, BRACELETS,  
RINGS, RIBBON COLLARETTES, Etc.

MOUNTED WITH AQUAMARINES, PERIDOTS, AMETHYSTS  
AND OTHER PRECIOUS STONES.

(DIAMOND MOUNTED COMBS A SPECIALTY.)

## DESIGNS For Silverware, Novelties and Jewelry . . . FINE ETCHING

All goods left with us for etching are covered by policies which fully insure our customers against loss by fire or theft.

CHARLES M. PRIOR (PHONE 1224 HARLEM) 1683 Madison Ave., New York



**SOLID GOLD CHAINS**

OF EVERY DESCRIPTION

The selling expense of chains is an item which ordinarily affects the cost in a measure which is greatly to the disadvantage of the retail jeweler.

In the price of our chains, this selling expense does not appear. You get this benefit when you buy

**SOLID GOLD CHAINS**



direct from us, as you do not have to help pay the salaries and expenses of salesmen. We have no traveling salesmen and our prices are therefore very low.

For 56 years exacting jewelers have found our chains ready sellers, very profitable to handle and most durable in service.

We will be pleased to send you a selection package

1850 1906

**ALOIS KOHN & CO.**

Makers of

**SOLID GOLD CHAINS**  
of every kind.

16-18 Maiden Lane  
New York

**Look for the Stamp**

ON BACK OF



**ONE PIECE**

The Standard American Collar Button

**KREMENTZ**

**Collar Buttons and Studs**



**Krementz Stamp**

PARKS BROS. & ROGERS  
20 Malden Lane, New York  
Selling Agents to Jobbers

**KREMENTZ & CO.**  
Newark, N. J.

Send for booklet, "The Story of a Collar Button."—FREE

**"TOPPY AND ORIGINAL"**

Bracelets  
Barrettes  
Brooches  
Pearl Snaps



Handy Pins  
Scarf Pins  
Pendants  
Collarettes

**ALLSOPP AND ALLSOPP**

'PHONE 4075W

18 COLUMBIA ST.

NEWARK, N. J.

**M. SCHIFF**

Established 1876  
82-84 Nassau St., N. Y.  
Phone 801 John.

Manufacturer of fine  
Diamond Mountings, Locketts  
and Buttons. Patentee of

**THE NEW IMPROVED  
Ear Screw**

The only one on the market  
of its kind, absolutely secure.  
Special attention paid to all  
order work.

ALL KINDS OF BRACELETS

**HEINTZ BROTHERS.**



**• We Make the Largest Line of Solid Gold Set Rings in America for the Retail Trade •**

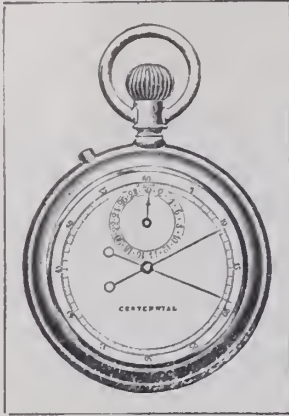

Timer is 1/8 Larger than cut

# THE OLD RELIABLE Centennial

SPLIT SECOND TIMER

*"None better made"*

Suitable for Racing and  
Mechanical Purposes.



Timer is 1/8 larger than cut

## CROSS & BEGUELIN, Manufacturers, New York.

### The Comb House

We manufacture a complete line of

#### FINE MOUNTED COMBS

in 14 K., 10 K., Sterling Gilt and Gold Filled.

Also all kinds of PLAIN, REAL and IMITATION TORTOISE  
SHELL COMBS.

#### Wagner Manufacturing Co.

41 Union Square,

Repair Work  
a Specialty.

New York. Factory, Lorimer St. and  
Throop Ave., B'klyn, N. Y.

## GARREAU & GRIS

68 & 70 Nassau St., New York

### LAPIDARIES. PRECISE CUTS in Unique Cutting

#### LEARN WATCHMAKING AT HOME

by THE De SELMS CHART SYSTEM, copyrighted and patented, is  
most simple, practical and up to the minute method of learning.  
Saves you time and money while learning and puts you in a position  
more than double your income.  
50 million timepieces to be repaired. Accurate time is a necessity in  
business world. When time is money the watchmaker gets his share of  
profit. Positions for graduates. Booklet free. Write to-day.

The De SELMS WATCH SCHOOL,  
109 Perry Street, ATTICA, IND.

## PATENTS

obtained on inventions and designs. Trade  
marks, prints and labels registered.

R. W. BISHOP,  
ATTORNEY AT LAW,

908 C Street N.W., Washington, D.C.

ESTABLISHED 1895

TELEPHONE 2920  
CORTLAND

# SOLIDARITY

WATCH CASE CO. MANUFACTURERS  
OF  
ARTISTIC GOLD WATCH CASES

GENERAL SELLING AGENTS. NO. 3 MAIDEN LANE, NEW YORK.  
JOHN W. SHERWOOD & FRANK E. HARMER.

Sold through the Jobbing Trade only.



THE Order of Elks has many members in its midst who have money to spend and are willing to use for the purpose of obtaining a fine piece of jewelry, typical of the Order. For these we have added to our ready large variety of buttons, charms, etc., a number of exquisitely made charms, consisting of fine teeth, set in mountings of beautiful designs, enriched with diamonds. The designs vary, all are artistic, the prices reasonable for an article of this high grade. Some of these in your stock will surely bring you "Elk" business. Probably you can dispose of a number to members attending the coming Convention of the Grand Lodge in Denver. Memo. package on request.

**Henry Freund & Bro.**

"SELLERS OF SELLERS,"

1 Nassau St., New York.

Elk and F. O. Eagle Goods a Specialty.

# Many Leading Retailers

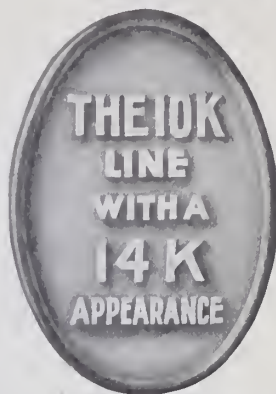

*who never before handled gold jewelry less than 14k. are among our most enthusiastic and liberal patrons.*

*Our designs, finish and workmanship have given a new dignity to the 10k. business.*



*Kohn & Co*

Camp and Orchard Streets  
Newark,  
New Jersey

**Roger Williams Silver Co.,**

PROVIDENCE, R. I., AND NEW YORK, 860 BROADWAY.

**Sterling Only.**

RICH DESIGNS :: :: :: Photos on Application.

# FALL LOCKETS



Trade-mark stamped in each Locket



Our **FALL LINE OF LOCKET CREATIONS** will convince the discriminating buyer of the value of W. & H. Locketts. Fifty years of successful experience justify the confidence in our line.

3 Maiden Lane **Wightman & Hough Co.** Providence, R. I.  
New York

## Boston Jewelry Manufacturing Co.

### The Mounting and Repairing House of New England.

We eclipse all others in design, quality, promptness and finish of work.

A line of entirely new styles in mountings always on hand.

**Jewelers' Building, BOSTON, MASS.**



14K. Gold on Sterling Silver.

In looking over your jobber's line, it is more possible that you will be shown attractive brooches, scarf pins, hair ornaments, etc., of plain design and rhinestone set. Don't purchase until you have seen our goods and prices. Our 14K. Gold on Sterling Silver, creations, as shown in season's styles, defy competition. Ask your jobber to show you these goods. You'll miss an opportunity if you don't.

**The MACKAY JEWELRY CO.,**  
235 EDDY STREET, PROVIDENCE, R. I.

## EGYPTIAN PEARLS

FINEST OF ARTIFICIAL PEARLS.

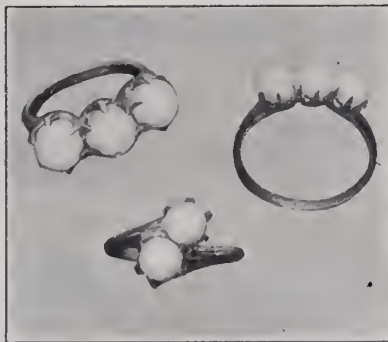

## EGYPTIAN PEARLS

MOUNTED IN POPULAR JEWELRY.

**T**HE PEARL has always symbolized Beauty and Value. Nature's product is most closely approximated in the handsome "EGYPTIAN" Pearls. The iridescence, weight and color of natural Pearls are retained; and inspection of the "EGYPTIAN" Pearls will demonstrate their pre-eminence. The results attained are possible only by a special process, supplemented by expert workmanship. The articles of Jewelry to which "EGYPTIAN" Pearls are applied are artistic creations meriting your attention.

## GEORGE H. CAHOONE COMPANY,

Makers of Artistic Jewelry,

PROVIDENCE—7 Beverly Street.

NEW YORK—9 Maiden Lane.



**Ladies' Fancy Stone Rings and Stone Scarf Pins in 10K. that defy competition.**

Our reputation for making the finest and most complete line of 10-K. gold band rings is still maintained—ask your jobber.

**The EDWIN LOWE & CO., Inc.**  
F. W. BODWELL, V.-Pres. and Gen. Mgr.,  
116 Chestnut St., PROVIDENCE, R. I.  
New York Representative, E. T. Wilson, 180 B'way  
Western Representative, S. H. Brower.

**W**ait  
**A**nd See  
**I**n the "Celebrated Case"  
**T**his Season's New Goods.  
**E**very one a Seller

**T**here  
**H**ave always been  
**R**easons:—  
**E**stablished reputation,

**S**  
**H**  
**E**  
**R**  
**'**  
**S**

**G**  
**O**  
**O**  
**D**  
**S**

**S**  
**E**  
**L**  
**L**

**Waite-Thresher  
 Company**

61 PECK ST., PROVIDENCE, R. I.

7 Maiden Lane, 1203 Heyworth Bldg.  
 NEW YORK. CHICAGO, ILL.

# LOCKETS

WE ARE  
**LOCKET  
 SPECIALISTS**

FOR THE  
 JOBBING  
 TRADE  
 EXCLUSIVELY



**THE GOLF  
 GIRL**

illustrates one  
 of a hundred  
 and more de-  
 signs. Made in  
 3 sizes.

**S. & B. L.  
 ★  
 CO.**

Every Locket stamped  
 on inside with

Insist on this  
 Trade-Mark

MADE IN HIGHEST GRADE GOLD FILLED ONLY

Ask your jobber, or send for a selection

Manufactured only by

**S. & B. LEDERER CO.**

NEW YORK SALESROOM  
 9-11 Maiden Lane

Providence, R. I.

CHICAGO  
 131 Wabash Avenue

## ORDERS PROVE OUR GOODS SELL

We make for the Jobbing Trade the following lines  
 of Solid Gold Jewelry :

*Rings, Scarf Pins, Studs, Brooches, Charms,  
 Baby Pins, Handy Pins, Chain Sets,  
 Link Buttons, Hair Barrettes,  
 Crosses, etc.*

Insist upon seeing the designs of Gold Jewelry  
 made by the

**E. L. SPENCER CO.**

95 Chestnut Street,

PROVIDENCE, R. I.

New York Office, 9-11-13 Maiden Lane.

SAMPLES ONLY.

ESTABLISHED 1861.

# R. BLACKINTON & CO.,

3 MAIDEN LANE, NEW YORK.

FACTORY, NORTH ATTLEBORO, MASS.

## Manufacturing Jewelers and Silversmiths.

TRADE  MARK.

Toilet and Manicure Articles, Flatware, Sterling and German Silver Wrist Bags, Gent's and Ladies' Card Cases, Vanity Boxes, Jewel Boxes, Match Safes, Picture Frames, Belt Buckles, Cigarette Cases, Pen-knives and up-to-date Novelties.

EVERYTHING IN LOCKETS AND CHAINS.

THE BASSETT JEWELRY CO.,

PROVIDENCE, R. I.

Established 1855.

# ADAMS & SINGLETON,

Successors to BROOKS & PIKE,

Manufacturers of

## Fine Diamond Mountings.

Special Attention Given to Order Work.

364 Washington Street, Boston, Mass.



THE TRADE

desirous of keeping in touch with modern, producing methods, should always consult the pages of

OUR BIG CATALOGUE,

with its 30,000 illustrations and long list of We send this splendid book free on request

*S. F. Myers & Co.*

Headquarters for Dueber-Hampden Watches  
WHOLESALE JEWELERS

The New S. F. Myers Bldg. 476-49 Maiden Lane New York.

### THE PREMIER REPAIRING HOUSE OF NEW ENGLAND

JEWELERS, SILVERSMITHS, STONE, METAL, SEAL ENGRAVE AND INCRUSTERS.

LAPIDARIES AND DEALERS IN PRECIOUS AND IMITATION STONES

- We Cut Stones
- We Repair Stones
- We Drill Stones
- We Engrave Stones
- We Incrust Stones
- We Set Stones

### H. E. ALSTERLUND & CO

387 WASHINGTON ST. AND 12 BROMFIELD ST. BOSTON, MASS.

All work positively Done in Our Own Factory.

Write us for terms and information.

# RINGS

## WM. LOEB & CO

101 Sabin St.,

Providence, R. I.

New York Office, 37 Maiden Lane

35 Years Manufacturing

# CHAINS

## S. & B. Lederer Co

11 Maiden Lane New York      Factory: Providence, R. I.      131 Wabash Ave Chicago





A good many dealers  
make their own names  
on America Alarm  
clocks—it's a standing  
ad." that somebody  
else pays for.

Ask your jobber or  
write us about this.

The Western Clock Mfg. Co.  
LA SALLE, ILL.

1876 **Hutchison & Huestis** 1906

RING MAKERS

**JADE**  
is in  
vogue.  
  
See our  
**JADE**  
**RINGS**



Jobbing  
Trade  
Only.

FACTORY: PROVIDENCE, R. I.

CHICAGO:  
Columbus Building, HARRY H. MILLER.

NEW YORK:  
3 MAIDEN LANE.

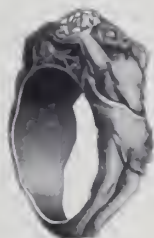

**BRACELETS**

Carved,

Engraved,

Plain or

Mounted.

**ROUCH & FITZGERALD**

**Jewelry  
Trunks  
and Cases**

177 Broadway,  
Bet. Cortlandt  
and Dey Sts.

688 Broadway,  
723 6th Ave.,  
New York.



**C. P. GOLDSMITH & CO.,**

33-43 Gold Street,

NEW YORK.



**Trade-Marks** of the Jewelry and  
Kindred Trades.  
Second Edition. Price, \$3.00. The Jewelers' Cir-  
cular Publishing Co., 11 John St., New York.

# THE MOUNTING THAT SELLS

Earscrews,  
Earrings,  
Studs,  
Scarf Pins,  
and Rings  
of every description.



Made in  
Platinum,  
18K.,  
14K.,  
all sizes.

It gives light and brilliancy to the stone.

Manufacturer of a general line of Platinum,  
18K. and 14K. Mountings.  
Prompt attention given to special order work.  
Estimates and designs submitted.  
Diamonds recut and repaired.

## JULIUS WODISKA,

40 JOHN STREET,

NEW YORK.



# Koshland & Italic Co.

702 Chestnut Street,

PHILADELPHIA, PA.

☞ We Solicit your  
business strictly on  
the merit of our  
goods.

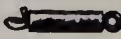
Diamonds, Watches and Jewelry

-  1. Snap complete
-  2. Outside of Snap
-  3. Inside of Snap.

## The E. P. H. Paten NON-PULL-OUT Neck Chain Snap

is a patented snap that insures  
the wearer against loss of

CHAIN or CHARM  
for it positively will not pull out

Made in 10 and 14 Karat Gold and  
in Gold Filled.

Can be had of the following Wholesale  
Selling Agents:

- Messrs. W. Green & Co.,  
81 Nassau St., New York
- |                           |                   |
|---------------------------|-------------------|
| M. Sickles & Sons,        | Philadelphia      |
| E. A. Cowan & Co.,        | Boston            |
| E. & J. Swigart,          | Cincinnati        |
| Swartchild & Co.,         | Chicago           |
| Nordman Brothers,         | San Francisco     |
| Leonard Krower,           | New Orleans       |
| A. Walker Co.,            | Providence, R. I. |
| Bauman-Massa Jewelry Co., | St. Louis         |

### PRICES.

- 14 Karat—Small, \$7 per doz. net  
Large, \$7.50 per doz. net
- 10 Karat—Small, \$6 per doz. net  
Large, \$6.50 per doz. net
- Gold Filled—Small, \$2 per doz. net  
Large, \$2.25 per doz. net

## THE WASHBURN

**SECURITY** **MAGIC NUMBER**  
Automatic Holder for ear studs, scarf pins, etc.  
for all sizes of scarf-pin wire. Guaranteed.



### EAR WIRES

for unpierced ears.



### SAFETY CATCH

For brooches, etc.  
Can be applied to work where pin threads are used.

Open.

Closed.

Open.

Closed.

Descriptive Circular on Application.

Pearl Drilling and Adjusting a specialty.

Special Order Work and Repairing.

C IRVING WASHBURN, 12-16 John St., N. Y.



### "GRIP"

The King of all card games, price  
sample pack 16c., two 3c. each.  
Sent prepaid at once (only on  
of price). See last week's issue  
circular for prices of my King Ad  
which every jeweler should have  
stock. Order 1 doz. asst. Encl.  
amount. Mention order No. J. 1  
will forward a sample pack  
extra. Order them to-day.

CHESTER H. WELLS, Jeweler, Meshoppen, Pa.

## Diamonds Set Without Cost

Means a lot of money saved during the year. This you can do very easily if you have your settings done by a first-class setter. Your diamonds will improve in value more than three times the money you pay for setting them. At the same time your mountings improve greatly. Your customers are satisfied with all the orders you turn out. You can compete with all others who are slow in grasping the importance of these facts, by giving me all your settings. I am sure you will make no mistake. I will prove these facts. I make a specialty of setting in Platinum Mountings, Watch Cases, Locketts and Gypsy Settings.

### RUDOLF BRETTNER

Nassau Street NEW YORK  
MAIL ORDERS RECEIVE PROMPT ATTENTION  
Established 1883 Telephone 2547 Cortlandt

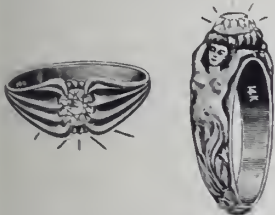

Manufacturer of  
Diamond Mountings and  
Diamond Set Jewelry  
Importer of  
Diamonds and Precious Stones

**A. S. Hirshberg,**  
373 Washington Street, Boston, Mass.  
Cable Addresses: { Ashir, Boston.  
                          { Hochschüler, Antwerp.

#### THE CROWN PATENT SAFETY GUARD.



for Scarf Pins  
is. The most  
practical and only  
one invented. Price, \$1.50 per doz. For sale  
to all wholesale jewelers and material houses. Sample  
mail, 25c; in 10k. gold, \$1.00; 14k., \$1.25. M. CROHN,  
Maker and Inventor, 45 and 50 Malden Lane, N. Y.

# WORLD BRAND SILVER

1857  
STANDARD OF THE WORLD

Nenuphar Pattern

**Base Metal**

Manufactured in our own factory by workmen selected because of their knowledge and practical experience in its manufacture and use and with a view to obtaining the best possible results.

**Silver**

Not Less Than 50 per cent. heavier plate than the regular "Standard." Made in two grades, six and fourteen ounce plate.

**Designs**

Six fancy patterns—original in design and unexcelled in execution. Also four plain patterns.

**Prices**

As low as consistent with quality.  
*Write for catalogue and price.*

**THE AMERICAN SILVER COMPANY**  
BRISTOL, CONN.  
46 West Broadway, New York. Silversmiths' Building, Chicago, Ill.

## SHAFER & DOUGLAS

Ring Makers

### HAVE REMOVED

their Office and Factory to

9 & 11 Franklin Street, Newark, N. J.

OPPOSITE NEW CITY HALL



# The "ARMLET"



**F. & B.**  
**"ARMLET"**  
 Secret Joint  
 Pat. ~~XXXX~~  
 Size 2 3/4 in.

- |                  |                                  |   |
|------------------|----------------------------------|---|
| <b>474</b>       | <b>476</b>                       | <b>477</b>                                  |
| <b>474 POL.</b>  | <b>476 Rose Gold Half Chased</b> | <b>477 Rose Gold, Half Chased, 5 Stones</b> |
| <b>475 ROM.</b>  | <b>507 O. E. " "</b>             | <b>522 O. E. " "</b>                        |
| <b>506 O. E.</b> | <b>530 Rose Gold Full " "</b>    | <b>546 Rose Gold " " 6 Brillants</b>        |
|                  | <b>538 O. E. " "</b>             |   |

Color of stones as ordered, Amethyst, Ruby, Sapphire, Olivene, Topaz, Aquamarine, Almondine, Turquoise and Rose Stones.

Bracelets made with secret joint and push catch. High-grade Seamless Gold-filled Stock. Each bracelet in fine leatherette covered box.



**BRACELET 473 ROSE.**  
 COLOR OF STONES AS ORDERED.

Amethyst, Ruby, Sapphire, Olivene, Topaz, Aquamarine and Turquoise.  
 Two of the above Bracelets snapped together, makes a nice dog collar 14 in. long.



Locket  
**2825**  
 Rose



Pin  
**3632**  
 Rose and Green  
 Brillants



Pin  
**3647 Pearls**  
**3648 Brillants**  
**3649 Turquoise**



Pin  
**3629**  
 Baroque Pearls  
 and Brillants



Locket  
**2826**  
 Rose



Hair Barrette  
**3660 Pearls**  
**3659 Brillants**



Cuff Pin  
**3624**  
 Roman



Cuff Pin  
**3622**  
 Roman



Hair Barrette  
**3652 Pearls**  
**3651 Brillants**

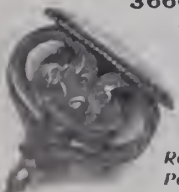

Hat Pin  
**710**  
 Rose and Green  
 Polish Signet

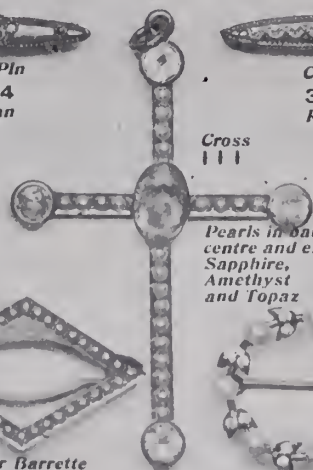

Cross  
 III  
 Pearls in bars,  
 centre and ends.  
 Sapphire,  
 Amethyst  
 and Topaz

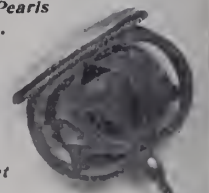

Hat Pin  
**705**  
 Rose  
 Polish Signet



Links  
**751**  
 Rose

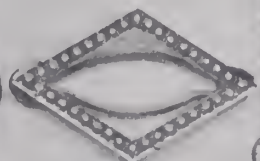

Hair Barrette  
**3658 Pearls**  
**3657 Brillants**



Pin  
**3603**  
 Baroque Pearls  
 and Brillants

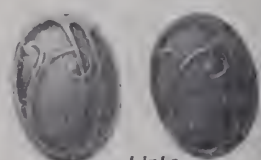

Links  
**758**  
 Green  
**757**  
 Rose

These are only a few examples of our new goods; see our complete lines.

**Theodore W. Foster & Bro. Co.**  
 MANUFACTURING JEWELERS AND SILVERSMITHS,  
 100 Richmond Street, Providence, R. I.

Established 1873.

See our lines  
 of Good for  
 Articles with  
 able for it

A full line  
 PHOTO. FRAMES  
 both Sterling  
 and 14 K. Gold  
 CROSSES, P  
 ANTS,  
 CHAINS,  
 GNETTE CA  
 LOCKETS, C  
 VEST, DIC  
 and FOB CA  
 BRACELETS P  
 BROOCHES,  
 RINGS, LIN  
 TONS, SCAR  
 HAT PINS  
 RETTE IN  
 WAIST SET  
 CHAIN MO  
 INGS, DO  
 LARS and  
 BUCKLES, J  
 BOOK-MAR  
 large variety of

Sterling  
Silver  
Novelty

MANICUR  
 TOILET SE  
 pieces, also  
 DESK SET  
 SEWING ET  
 TRAVELING  
 SHAVING  
 SMOKING  
 FLASKS and  
 goods suite  
 gentlemen's

Do not fail to  
 order a few  
 our new  
 lets,

"The Armlet"

**Well Known Toronto Manufacturers Urge Passage of Gold and Silver Stamping Bill Which Has Been Recast.**

TORONTO, Ont., June 21.—The gold and silver marking bill was again up for consideration before the Senate Committee on Banking and Commerce at Ottawa yesterday. Sir George Drummond, chairman, had a hearing was given to depositions and against the measure. The passage of the bill was urged by W. K. McNaught, V. P. of the American Watch Case Co.; K. George, Standard Silver Co.; Thomas Ren, of Roden Bros., and M. E. Ellis, of V. Elhs & Co., all of Toronto, and C. Stewart, Montreal Watch Case Co., Montreal. Opposition to some of the clauses offered by Walter J. Barr, manager of Goldsmiths' Stock Co., and Samuel G., representing H. & A. Saunders, jewelers-manufacturers.

The bill has been recast, and some modifications have been effected as the result of discussion of its provisions. The clause prohibiting the use of any trade-marks on stamped jewelry unless accompanied by a stamp of quality was amended so that a trade-mark may be used without a quality mark. It was also provided that a quality mark if used is to be accompanied by a qualifying description such as "gold plate," "plated gold plate," "electroplate," etc. The clause fixing the minimum karat stamp of gold at 10 karats was supported by the committee, but will be strongly opposed at a later stage.

A strong lobby has been working for the bill and despite the lateness of the session it is now generally believed that the Government, having adopted the measure, will put it through before prorogation.

**Jewelry, Silverware, Clocks, Watches and Kindred Lines Exported from New York.**

WASHINGTON, D. C., June 20.—The following were the exports of jewelry, silverware, optical goods, clocks, watches and kindred lines from the Port of New York for the week just ended:

- Berlin: 3 packages clocks, \$140.
- Berlin: 69 packages clocks, \$3,650.
- Bombay: 2 packages plated ware, \$310; 4 packages stereoscopic goods, \$1,100.
- Buenos Ayres: 3 packages plated ware, \$570; 6 packages clocks, \$220.
- Calcutta: 38 packages clocks, \$747; 71 packages clocks, \$871.
- Christiania: 9 packages clocks, \$375.
- Copenhagen: 1 package jewelry, \$500.
- Glasgow: 1 package optical goods, \$304; 59 packages clocks, \$1,051.
- Hamburg: 2 packages optical goods, \$363.
- Havana: 6 packages jewelry, \$1,422.
- Lyons: 3 packages jewelry, \$1,019.
- London: 2 packages plated ware, \$300.
- London: 3 packages clocks, \$111.
- La Guayra: 1 package precious stones, \$1,000.
- Lisbon: 41 packages clocks, \$436.
- Liverpool: 1 package plated ware, \$523; 65 packages clocks, \$1,189.
- London: 35 packages clocks, \$793; 2 packages plated ware, \$373; 11 packages optical goods, \$129; 3 packages scopes and views, \$420; 7 packages watches, \$1,357; 1 package plated ware, \$6; 29 packages clocks, \$731.
- Montevideo: 5 packages clocks, \$853.
- Barcelona: 3 packages jewelry, \$462; 41 packages clocks, \$604.
- San Antonio: 3 packages plated ware, \$138.
- Southampton: 1 package jewelers' findings, \$100.
- Tavenger: 5 packages clocks, \$210.
- London: 3 packages plated ware, \$165; 31 packages clocks, \$346.

Trinidad: 2 packages watches, \$228; 1 package jewelry, \$142.  
Valparaiso: 1 package jewelry, \$130.

**How Thief Who Robbed Richmond, Va., Jeweler Was Cleverly Traced to New York.**

RICHMOND, Va., June 23.—Indictments were presented several days ago against Wheaton B. Despard, alias Dan Stevens, who was arrested in New York on the charge of stealing two diamond rings from J. F. Kohler. A special Grand Jury was convened by Judge Witt as soon as word was received here of the arrest, and the indictments were promptly returned. Detective Wiltshire has already started for New York with requisition papers, intending to bring the prisoner to this city.

Charles M. Kohler, who was in the Adams Express Co.'s office at 11 W. 34th St., New York, when the arrest was made, is positive in identifying the prisoner. Mr. Kohler said that one day last week two men entered his store and looked over the diamond rings. He did not notice until after they had gone that they substituted two rings with paste stones for genuine diamonds. He said that one of the men was Despard and the other was a man named Preston, who has not yet been arrested. It is said that Despard registered as Dan Stevens, New York, when he came to this city, and he was for a week a guest of Murphy's Hotel.

In tracing the man the police had the benefit of information obtained from Samuel Steiner & Bro., of this city. On May 26 a diamond ring was pawned by Stevens at this firm's office for \$175. In pledging the ring Stevens said that he had "gone broke" playing faro, and needed the money to get back to New York. After learning of the Kohler robbery Mr. Steiner became suspicious and notified the police.

When Stevens left this ring with the pawnbroker he said that he would take it up through the Adams Express Co. He kept his word as to this. The local office of the express company paid the pawnbroker the money loaned, and took up the ring on an order from New York. The ring was then sent to the New York office for delivery to Stevens, who was arrested when he and his wife called to get the package. The ring pledged with Steiner was not one of those stolen from the Kohler store.

**California and New Mexico Turquoise.**

The turquoise mines of New Mexico and Arizona have lately not been as productive as formerly, says George F. Kunz, in the report on the production of precious stones in 1905, which the United States Geological Survey will soon publish. The turquoise properties of California and Nevada have, however, been increasing their output.

Considerable quantities of turquoise have been taken from the mines in the desert region of San Bernardino Co., Cal. Many of the stones range from 50 to several hundred carats in size. Some of them have sold as high as \$1,500 each. The color is pale, but it has gained favor, and large quantities of the stones have been sold in the form of beads for necklaces.

**Interesting Decision by United States General Appraisers as to Duty on Combs and Necklaces.**

Protests of G. W. Sheldon & Co. against assessments of duty by the Collector at Chicago on importations of back and side combs and necklaces were last week overruled by the Board of United States General Appraisers, New York. The combs are declared to be dutiable as a manufacture of celluloid, under Par. 17 of the Tariff Act of 1897, the rate being 65 cents a pound and 25 per cent. ad valorem. The collector assessed duty at 60 per cent, claiming that the articles should be classified either as jewelry or cut glass. The Board did not agree with the collector, so that the decision is not a victory for either side.

General Appraiser Sharretts, in his opinion, says:

"The articles covered by these protests are invoiced as 'combs' and 'necklaces,' assessed with duty by the collector at the rate of 60 per cent. ad valorem as jewelry under Par. 434 and claimed by the importers to be dutiable at 45 per cent. ad valorem under Par. 112 or 193 of the Tariff Act of 1897.

"Regarding the necklaces, no samples were submitted and we affirm the collector's decision relative thereto, the articles being dutiable at 60 per cent. ad valorem either as jewelry under Par. 434 or as articles composed in chief value of beads under Par. 408.

"The combs are known as back and side combs, have each 22 teeth, and are composed of celluloid made to imitate horn or tortoise shell, a row of disks or ornaments composed of imitation jet made of paste disposed in symmetrical arrangement being riveted to the top of each comb. These disks have molded faceted surfaces which have been ground and polished to add to their luster.

"In a supplementary report to the collector the appraiser expresses the opinion that the combs are dutiable at 60 per cent. ad valorem, not as jewelry but as articles of glass cut under Par. 100.

"The invoice value of these combs averages Krs. 10 per dozen, while the testimony taken by the Board shows the value of the paste ornaments to be Krs. 4 and Kr. .40 for the respective sizes per hundred dozen. Inasmuch as the cost of attaching the ornaments to the combs applies equally to both materials, it is manifest that celluloid is the component material of chief value in the completed articles, and we so find as a fact.

"The importers not having claimed redress under Par. 17, we are constrained to overrule the protest, the collector's decision standing affirmed."

The Passamore Gem Co., 373 Washington street, Boston, Mass., has greatly increased its facilities for the cutting of gems by taking large and adequate factory quarters in the home office building. The new space will be furnished with modern and up-to-date lapidary equipment, and will accommodate over 30 cutting hands, making the company the largest individual cutting concern in New England. Joseph B. Wagner and Stephen Hadley will hereafter represent the company on the road.



Trade-Mark Registered.



Trade-Mark Registered.

## THE NATIONAL STAMPING LAW

was signed by the President of the United States on June 15th, 1906.

This law does not go into effect for one year; this time is allowed so that manufacturers and dealers may readjust the quality of their goods, so that they will be up to the quality they are stamped.

There will be no readjustment in our factory, for one of our principles in business is to make goods of unquestioned quality.

As a guarantee that the quality is just as it is stamped, we place upon every article we make this registered trade-mark—



Trade-Mark Registered.

Why not begin this Fall to buy Rings, Locketts, Link and Bar Buttons, Vest Buttons and Shirt Studs bearing this mark?

### Larter & Sons

21 & 23 Maiden Lane

New York



Trade Mark Registered.



Trade-Mark Registered.

### Beautiful Silver Statue of Elk to be Awarded at Convention of B. P. O. E.

THE trade in Denver, Col., has reason to feel proud of a splendid piece of work recently turned out by the Boyd Park Jewelry Co., of that city. It is a silver elk, signed and modeled by T. C. F. Sorensen of that firm's engraving and designing department. The elk stands on a base composed of valuable gold and silver ore from mines of Colorado and is composed of ounces of native silver. It is 33 inches high and is valued at \$1,000.

The trophy was offered by Fred. G. Shaffer, a local mining man, as a prize to the lodge which sends the largest number of ladies to the convention and reunion of B. P. O. Elks, which will be held in Denver in July.

Mr. Shaffer is very enthusiastic over the skillful modeling of his gift to the Elks. The silver in its native state was placed in the hands of the designer, and under the skillful manipulation there grew out of the great bulk of silver the magnificent figure of an elk, perfectly proportioned and every way fitted to typify the state in which it was fashioned.

Mr. Sorensen, the designer, was formerly with Tiffany & Co., New York, and some of his work are to be seen at the National Museum Stockholm, Sweden, and Wind Castle, England.

### Further Litigation Between the McKay Co. and James C. Buchanan, Washington, D. C.

WASHINGTON, D. C., June 22.—A suit to recover \$5,000 damages has been filed in the District Court against the McKay Co., a corporation formed for the purpose of conducting a jewelry business at 1115 1/2 St., N. W., against James C. Buchanan and Thomas H. Hall. According to the papers filed with the District Supreme Court, the McKay Co. alleges that Buchanan and Hall conspired to oust it from the half of the store occupied by the company. In furtherance of the alleged plan it is charged that Buchanan, from whom the McKay Co. had possession of the store, defaulted the payment of rent due June 1 on the store building, which Buchanan held, it is claimed, under lease from Hall. It is further charged that Hall sued Buchanan for possession before a justice of the peace and that judgment was awarded.

The McKay Co. claims that under the proceedings it was dispossessed, notwithstanding it had performed, so it is claimed, all the terms of the agreement with Buchanan.

There seems to be no end to the suits and counter suits entered by these parties, who have been fighting each other for a number of months.

Bergeda Bros. have leased quarters at 111 Church St., Nashville, Tenn., where, September 1, they will open a first-class retail jewelry establishment. David M. Bergeda, a junior member of the firm, has returned from San Francisco, where he was connected with one of the leading houses in the recent disaster. Aaron Bergeda, a senior member of the firm, is an experienced watchmaker, having learned his trade in Austria.



## New England Watch Makers Make Merry at Banquet Held in Boston, Mass.

Boston, Mass., June 23.—The dinner of the New England Watchmakers' Club at the American House last Tuesday evening was an unqualified success. The club was the guest on this occasion of the Waltham Watch Co., and Supt. Edward A. Marsh, of the big factory, represented the company as host.

There were nearly 200 participants, and at the reception and in the banquet the scene was an exceedingly animated one with the spirit of thorough comradeship and unalloyed enjoyment pervading the entire assemblage. Songs and instrumental music enhanced the reception, and when the march for the banquet hall took place, Superintendent Marsh and President F. W. Ruggles, of the club, led the long line to the tables, where a most appetizing spread was provided.

The menu was as follows:

MENU.

- Little Neck Clams.
- Chicken Gumbo. Consomme Julienne.
- Olives. Radishes.
- Broiled Bluefish, au Beurre.
- Sliced Cucumbers. Charrau Potatoes.
- Roast Spring Lamb, Mint Sauce.
- Delmonico Potatoes. String Beans.
- Maraschino Punch.
- Lobster Cutlets, with peas.
- Banana Fritters, au Kirsch.
- Strawberry Shortcake.
- Frozen Pudding. Assorted Cake.
- Cheese. Crackers.
- Coffee.

The postprandial exercises were also of great interest, and fully a great a source

of enjoyment as the feast. President Ruggles happily introduced the various speakers, first making a brief address in which he set forth the purpose of the club, which was formed not only to gather for recreation at intervals, but to listen frequently to instructive papers and addresses on topics related to the important industry with which the members are identified.

Superintendent Marsh, of the Waltham Watch Co.'s factory, was presented as the first speaker, and received an ovation as he rose to respond for the company. He contrasted the watchmaking of modern times with that of the past most effectively, for he has been identified many years with the remarkable growth of the establishment over which he so ably exercises supervision, and his talk was listened to attentively and appreciatively by all present.

Assistant Superintendent John W. Burckes, of the Waltham factory, was also present and spoke of the advantages to be derived from such associations as the Watchmakers' Club.

A large number of the members and honorary members were also called upon and responded briefly during the next hour, which was made the occasion for a series of informal and impromptu remarks, which afforded much pleasure for the gathering. Among the participants in this feature of the after-dinner exercises were H. E. Dunbar, M. N. Smith, Mr. Bagley, Chicago; Treasurer W. E. Geyer, who reported a

fund of \$500 in the treasury; Secretary John S. Lowell, who called attention to the growing membership list, with upward of 200 names, and an honorary list of nearly 30; Charles M. Smith, who told some witty stories with excellent effect; Thomas F. Proctor, Olaf Olsson, Charles J. Olney, Jr.; F. R. Cunningham, F. J. Whitton, R. A. Lohnes, Worcester; Charles S. Robb, Maurice Conner, and others.

Regrets at the absence of Conover Fitch, who was detained by illness, were expressed by Mr. Ruggles, and a letter from James S. Blake, one of the honorary members, was read.

The exercises concluded shortly before 11 p. m., after an evening that was a red-letter event in the history of this promising new association in the trade.

The roster of the club, most of whom were present at the banquet, and of the honorary members, several of whom were at the banquet in person, or represented by proxy, is as follows:

- F. W. Ruggles, John S. Lowell, W. E. Geyer, M. H. Keyes, H. S. Reynolds, F. R. Cunningham, W. B. Garfield, P. A. Lesperance, Edgar R. Hills, Thomas F. Proctor, Alex. Fish, L. M. Watson, J. W. Smith, A. R. Stanley, J. T. Tudor, Herbert L. Gruber, D. J. Dannahy, Roy M. Nichols, George Garland, Adolph Faller, Wm. N. Loud, Conrad Erickson, Charles S. Rodd, K. E. Ohstedt, C. S. Blake, J. Emanuels, C. T. Jenkins, L. T. French, K. Luben, J. Charles Stever, Frank W. Dodge, Alfred F. Mutschman, F. W. Harness, Frank A. Gendreau, E. D. Clarke, George A. Wildon, H. D. Higgins, Charles K. Magnuson, F. R. Furbush, O. C. Dow, J. M. Bird, B. T. Parker, Samuel Baker, Louis F. LaPointe, C. S. Freeman, Charles N. Brown, C. C. Miller, Fred S. Harlow, Charles H. Swaisey, L. M. Coburn, A. F. Thurlow, C. W. Johannet, C. F. Raash, Bernard G. Hushband, Elmer C. Read, Charles Pass, George W. Hallett, A. Anderson, Albert H. Brooks, John Ferguson, F. D. Bacon, C. G. Tucker, Thomas Milner, A. Johnson, J. W. Cahill, Henry S. George, J. M. Vass, E. A. Gregor, Howard L. Margeson, Herbert N. Libbey, James F. Murphy, Dr. J. L. Basford, W. E. Stormant, L. Kibbler, C. M. Smith, Eloi Lamont, Geo. E. Homer, P. H. Whilton, L. Schworer, W. J. Anderson, P. D. Vaughn, Walter C. Jenckes, A. B. Sly, Charles M. Murphy, Pierce



MEMBERS AND GUESTS OF THE NEW ENGLAND WATCHMAKERS' CLUB AT BANQUET IN BOSTON, JUNE 19.



During the celebration of

## MERIDEN'S CENTENNIAL

June 10-16, 1906, the buildings of the city were handsomely decorated—among them the factory of

### The Meriden Britannia Co.

The electric sign shown in the center picture is a permanent institution; it is the doorplate announcing the home of

## “1847 Rogers Bros.”

“Silver Plate That Wears.” The other views show parts of the decorated factory, as seen from different positions, nearly 2,000 separate flags in all being used.



### The Meriden Britannia Co.

is not so old as Meriden, which was incorporated as a town 100 years ago, in 1806, but for over half a century it has been the leading industry of the “Silver City.” For fifty-nine years the original silver-plated spoons, forks and knives, the famous brand marked

## “1847 Rogers Bros.,”

have maintained the standard of silver-plated flatware established in 1847 by Rogers Bros., then of Hartford, whose interests later were merged with those of the Meriden Britannia Co.





R. Arker, A. F. Freeland, H. Kaufman, John A. B. W. Kattelle, L. E. Nichols, Richard Currier, M. D.; M. Moyers, H. W. Matalene, Samuel Adberg, Nathan Levin, F. L. West, F. E. Goodspeed, Albert O. Schmetzer, John H. Gilman, E. S. Robs and G. C. Netch, Boston, Mass.; B. A. Con, Everett, Mass.; F. S. Scales, Winchester, Mass.; C. J. Olney, Jr., H. E. Duncan, Bernard S. Odging, Herbert W. Chamberlain, D. Gindrat, V. S. Culbertson, T. McKenzie, Raymond Carter, Lindine, J. C. Barlow, E. V. Goodman, W. L. Lince Wilkins, Clarence E. Hamilton, J. N. Pay, R. P. Smith, O. Herz, Geo. F. Lavoic, B. Schmeck, Burnett E. Hart, Norman H. E. H. Swam, Frank Lowell, Aucil B. Albert S. Flint, Fred A. Pohn, W. H. Eaton, Edward M. Foster, H. E. Cook, Weld Smith, John D. Clement, C. H. Douglass, J. De Veuve, G. A. Mansfield, William Winter, W. R. Woods, F. E. Randolph, L. A. Wood, A. D. Wilkins, G. W. Hill, Olaf Olson, Frank L. Richardson, E. A. Safford, Olaf Ohlson, Richard M. Robbins, Waltham, Mass.; J. F. A. Golburnaud, J. W. Marsha, Cambridge, Mass.; George F. Draper, Danvers, Mass.; V. I. Heath, Braintree, Mass.; E. L. Britt, Mans Corner, Mass.; W. D. Ward, Hyde Park, Mass.; Solon Abbott, Winchendon, Mass.; W. B. and H. D. Cole, West Lynn, Mass.; P. H. and Fitchburg, Mass.; E. A. Doyle, W. H. C. S. Ramsdell and P. R. Hibbard, Lynn, Mass.; W. H. Lucas, Wakefield, Mass.; A. Rozen, Lynn, Mass.; J. R. Dean and Loring B. Wilder, Lynn, Mass.; Le Roy E. Cole and Raymond P. Natick, Mass.; Theo. P. Pratt, Newton Hills, Mass.; George H. Gutteridge, Maynard, Mass.; W. Josselyn and Howard G. Smith, Attleboro, Mass.; Lewis B. Curtiss, Newburyport, Mass.; and A. Margot, Jamaica Plain, Mass.; J. B. Merrand son, Beverly, Mass.; George S. Janr Somerville, Mass.; Henry W. Chadwick, Leicester, Mass.; H. O. Barthelmes, Marlboro, Mass.; William H. Kehew, Salem, Mass.; George Wendrick and F. W. Lovejoy, Nashua, N. H.; L. Kendrick, Lebanon, N. H.; Henry A. Seddt, Roslindale, Mass.; Cranston McIntosh, Wroxbury, Mass.; C. G. Beare and Llewellyn Rors, Jr., Gloucester, Mass.; Adolph H. Krause, Bridine, Mass.; Moulton C. Libby, West Somme, Mass.; Ernest C. Bell, Westboro, Mass.; W. Persons, Woburn, Mass.; Fred M. Weber, Dennis, Mass.; Fred W. Hill, South Lincoln, Mass.; H. S. Hewett, Brockton, Mass.; R. A. Lees, Worcester, Mass.; E. F. Welch, Westboro, Mass.; Charles Sinclair, Concord, N. H.; A. French, Hudson, Mass.; C. H. Abbott, Leinster, Mass.; Wm. H. Taylor, Providence, R. I.; F. A. Lovejoy, H. E. Bellows and R. H. Highton.

HONORARY LIFE MEMBERS.

James S. Blake, of Kettell & Blake; Henry W. Pearson and Marcell N. Smith, of Smith, Patterson Co.; D. C. Percival and Edward E. Hardy, of C. Percival Co.; Albert J. Paul and Charles W. Winley, of A. Peaul Co.; E. A. Cowan and H. y Cowan, of E. A. Cowan & Co.; M. Myers, I. beta, Maurice D. Conner, Globe Optical Co.; A. Mendelsohn & Co., A. F. Sherer, Walter B. Siv, of the Poole Silver Co.; Charles S. Cook, of S. Stowell & Co.; Ripley-Howland Mfg. Co.; W. L. Gilbert Clock Co.; Woodman, Cook Co.; F. chnetzer & Son; Charles E. Durgin, of the T. Long Co.; C. A. W. Crosby & Son; Alfred J. ll & Co.; Robbins, Appleton & Co.; Albert R. K., of Wm. Kerr & Son.

OFFICERS AND DIRECTORS.

R. Ruggles, president, with Robbins, Appleton & Co.; H. L. Reynolds, vice-president, with Smith, Patterson Co.; W. E. Geyer, treasurer, with D. C. Percival & Co.; J. S. Lowell, secretary; directors, F. R. Cunningham, with Bigelow & Kenne; F. W. Dodge, with J. C. Sawyer; Wm. B. G. eld, with Kettell & Blake; J. A. Jury, with A. towell & Co.; M. H. Keyes, with D. C. Percival & Co.; F. A. Lovejoy, with Shreve, Crump & ow Co.; L. E. Nichols, with Rand & Crane; R. A. Lohnes, Worcester, Mass.; Charles Sinclair, with N. C. Nelson & Co., Concord, N. H.; E. Swain, Waltham Horological School; Wm. H. Taylor, with G. H. Taylor & Co., Providence, R. I.

Pierced Imitation Gems Backed With Foil Declared Dutiable at Twenty Per Cent.

Imitation precious stones, backed with foil and pierced vertically, are to be assessed for duty at 20 per cent. under a decision announced last week by the Board of United States General Appraisers, sustaining a protest by B. Uhnann & Co. against an assessment by the Collector of New York.

The government contends that articles of this kind should be classified as beads dutiable at 35 per cent. The Board; in the present decision, maintains a position which it took in a similar case some time ago. The government, in preparing the present case, shows an intention of carrying the question to the courts. General Appraiser Sharretts, in his opinion, says:

"These protests relate to articles of paste, not exceeding 1 inch in dimensions, made to imitate diamonds, rubies, emeralds, opals, and other precious stones. They are pierced with two vertical holes, placed one each at opposite sides near the edge, and are backed with foil to add to their brilliancy.

"The testimony shows, and we find as a fact, that these articles are commercially known as jewels, and that they belong to the class of goods known in trade as imitations of precious stones and not as beads. Similar articles devoid of foil, as shown by the testimony of the same witnesses, are known as 'beads' and 'nailheads,' interchangeable, and not as jewels. It would therefore seem that the presence or absence of foil establishes the classification of the respective articles as imitations of precious stones, or as beads.

"In G. A. 5671 (T. D. 25267), this Board held that similar articles with foil backs were dutiable at the rate of 20 per cent. ad valorem under Par. 435 of the Tariff Act of 1897. No appeal was taken from that decision, but the Department in T. D. 25345 instructed collectors to disregard it and to continue to classify as beads such goods as those in question, with assessment of duty at the rate of 35 per cent. ad valorem under Par. 408.

"Regarding these instructions as preliminary to a review by the court, we have endeavored to make as full and complete a record as possible in the present case, having notified the attorneys for the government and the importers that evidence regarding the issue involved was required. The testimony adduced at the hearing tends to confirm the correctness of the conclusions reached in G. A. 5671 (supra).

"In again passing upon this issue we are not unmindful that by judicial determination imitation pearls pierced through are classified as beads and not as imitation precious stones. In so determining, the court affirmed a decision of this Board (see G. A. 6088—T. D. 26554). The reasons that influenced us in holding that so-called imitation pearls pierced through, which are not known in trade as imitations of precious stones but as beads, applies inversely with equal force to the jewels in question, which are not known commercially as beads, but as imitations of precious stones.

"In accordance with the views herein expressed, we sustain the protests claiming

20 per cent. ad valorem duty under Par. 435 on the merchandise, and reverse the collector's decision in assessing duty thereon at the rate of 35 per cent. ad valorem under Par. 408."

Ontario Silver Co. Convicted of Falsely Marking Its Stock and Fined \$600.

TORONTO, Ont., June 20.—The charges against the Ontario Silver Co., Niagara Falls, for the fraudulent use of the word "Sheffield" and other trade-marks on their goods, and against George W. Clark, manager of the company for conspiracy to defraud the public, came up for trial before Judge Wells at Welland, June 16. The case against the manager was withdrawn. Four separate indictments were laid against the company.

No defence was made, but J. W. Nesbitt, K. C., of Hamilton, who appeared for them, pleaded for leniency, placing the blame on the former owners of the business. The judge inflicted a fine of \$150 on each count—in all, \$600.

In pronouncing sentence, Judge Wells spoke very strongly in condemnation of the conduct of the company, comparing it to the issue of counterfeit money by a chartered bank. He expressed the opinion that the law in such cases should be altered to conform to that prevailing in some of the States of the Union, where officials of companies countenancing illegal acts such as those of which the defendants were guilty can be punished by imprisonment. In Canada no punishment other than a fine can be inflicted in such cases.

Samuel Shamberger, Butler, Pa., Convicted on Arson Charge, Will Appeal.

PITTSBURG, Pa., June 20.—Samuel Shamberger, the Butler (Pa.) jeweler, who was arrested some time ago in Georgia whither he had fled after it is alleged he set fire to his jewelry store, and who was later brought back to Butler for trial, has been convicted of arson. His attorneys have filed a motion for a new trial, alleging that the verdict was in flagrant disregard of the evidence in the case, and that a rumor that Shamberger had burned a store in Franklin, Pa., under similar circumstances prejudiced the minds of the jury.

The particulars regarding the fire and Shamberger's arrest were told in the CIRCULAR-WEEKLY at the time. A number of suits have grown out of the affair, some of which are still pending. It was alleged that Shamberger fired his store in order to get \$10,000 insurance. Shamberger has always stoutly maintained his innocence. He was a resident of Pittsburg before going to Butler.

The court is expected to pass judgment on the motion for a new trial within a few days.

The jewelry trade is among the many lines of business, heretofore exempt, which come under the new law adopted by the Legislature of Kentucky which requires license fees to be paid by merchants. The bill which became effective June 11 provides that each transient vender of spectacles or jewelry must pay \$10 license fee whether the articles are offered for sale in the store or not.

the many friends of Zachariah Booth, an old and well-known clock repairer of New Bedford, Mass., were grieved to learn that he had died suddenly of heart disease June 15 while walking along a street of that town. The deceased is survived by a widow and one son, Z. E. Booth.

# HAYDEN W. WHEELER & CO.

## MOUNTED DIAMONDS



Our stock of Mounted Diamonds includes the newest and best ideas for the approaching June Weddings. We are also splendidly equipped to furnish special designs.



AMSTERDAM  
2 TULP STRAAT

NECKLACES, BRACELETS AND LA VALLIERES ARE  
AMONG THE PREVAILING FADS AT PRESENT.

LONDON  
50 HOLBORN VIA

2 MAIDEN LANE, NEW YORK

TELEPHONE  
7365 CORTLANDT

ORDER

# DIAMONDS

ON MEMORANDUM FROM

## ALFRED H. SMITH & CO.

170 BROADWAY, NEW YORK.  
Corner Maiden Lane.

London.  
6 Holborn Viaduct.

Chicago.  
103 State Street.

## Oppenheimer Bros. & Veith, Cutters of Diamonds,

65 NASSAU ST. (PRESCOTT BUILDING), NEW YORK.

AMSTERDAM,  
2 Tulp Straat.

LONDON,  
40 Holborn Viaduct.

CUTTING WORKS,  
Cor. Union & Nevins Sts., Brooklyn

## HENRY E. OPPENHEIMER & CO.,

51 Holborn Viaduct, London.  
50 Rue de Chateaudun, Paris.  
7 Place Loos, Antwerp.

Tel. 621 Cortlandt.

3 MAIDEN LANE, NEW YORK

DIAMONDS, PEARLS AND PRECIOUS STONES.

MEMORANDUM ORDERS SOLICITED.

**Death of the Late Max J. Lissauer  
—Funeral to be Held in New York—  
Resolutions on His Death.**

The body of Max J. Lissauer, the head of the wholesale jewelry firm of Lissauer & Co., 12 Maiden Lane, New York, whose sudden death at Amsterdam, Holland, was announced in the last issue of THE CIRCULAR WEEKLY, was placed on the steamer *Sandam*, which sailed from Rotterdam on its way to New York July 3. Mrs. Lissauer is coming on the same boat. Arrangements are being made to conduct funeral services in this city.

The career of Max J. Lissauer was briefly sketched in last week's issue. In regard to a man who had been for many years as active as was Mr. Lissauer in business and in the social affairs of his community, the pen is quite inadequate to do more than merely call attention to some features in his busy life.

His birth took place in the city of Stuttgart, Wurttemberg, Germany, Oct. 21, 1811. After learning the jewelry trade in his own town he came to New York in his 19th year, and three days after landing the young man obtained work as a watch repairer in the Maiden Lane district. A proof of his business ability was not needed to work long for others, and in 1831, just six years after he arrived in the city, he engaged in business on his own account as a member of Waaser & Lissauer, the two partners having been schoolmates at Stuttgart.

In 1869, after Mr. Waaser's death, the firm style was changed to Lissauer & Co. The next change was the admission of L. F. Sondheim, who had been with Mr. Lissauer for several years, the firm style becoming Lissauer & Sondheim. The association between these two men continued for 23 years until 1893, when Mr. Sondheim withdrew to become a member of the New York Stock Exchange. The old style Lissauer & Co. was again adopted in the next year, and has been continued since. The new partners were admitted in 1893, M. S. Kallman, A. Boehme and D. H. Libman. At the same time Marcel Mirabeau obtained an interest in the business. In 1898 Mr. Lowman withdrew and Mr. Mabeau became a full partner. Mr. Boehme after having for years been confidential man and bookkeeper retired in 1901, since which time the members of the firm have been Messrs. Lissauer, Kallman and Mirabeau.

When Mr. Lissauer first engaged in business the firm sold jewelry, materials and tools. Gradually the character of the business changed until the firm came to deal in diamonds, watches and jewelry. During the existence of the old National Association of Jobbers in American Watches Mr. Lissauer was the chairman of its executive committee, and this position naturally gave him much prominence in the trade. He was a director at the time of his death in the Jewelers Board of Trade and was a member of the Jewelers Protective Union. An organization whose work appealed most strongly to him, was the Jewelers Relief Association, which he assisted in forming back in 1896, the year which has always been remembered as one of the more trials for many in the jewelry trade.

He was the first president and held the position up to the time of his death. The organization helped many worthy jewelers over a period of financial stress, and while the occasions for it to act have not been numerous in recent years, yet it has been a force for good and only a few weeks ago donated from its treasury \$500 for the California sufferers.

Another organization in which Mr. Lissauer labored with fervor, in order to give aid to others, was the Jewelers' League, of which he was first vice-president and chairman of the executive committee. As the chairman of this committee it fell to his lot to take an especially active part in putting into effect the recent changes in the constitution and by-laws, involving a new plan of assessments. He attended the meeting of the league, at which the plan was discussed and he explained to the members with clearness and frankness the reasons why the changes had become necessary. The strain proved considerable and after the meeting his friends noted that he was quite exhausted. He had, however, an engagement to attend that same evening, as a guest of honor, the annual dinner of the 21 Karat Club, and he was present. Since that time he had felt the need of rest and had hoped to obtain it on his trip to Europe, while also making purchases in the diamond markets. He sailed with Mrs. Lissauer on May 30.

Outside of the jewelry trade Mr. Lissauer took a prominent part in many enterprises and social movements. In 1890 while he was president of the Verein *Freundschaft* that organization erected its \$500,000 building at 72d St. and Park Ave. The educational and social work of this organization was especially dear to him and he continued his interest up to the end. He was a member of *Tecumseh Lodge* of Masons and of various other brotherhoods. Practically all of the Jewish philanthropic and educational organizations in New York had the benefit of his active interest and support. In politics he was a Republican, and he was a delegate to many conventions of his party. He was a member of the committee of 70 which helped to elect Mayor Strong.

Many young men went to Mr. Lissauer for advice and always found him ready to assist them. His counsels were highly valued by his business associates and friends, as he had a faculty of readily grasping the facts and searching out the vital side of any question that arose. The friends whom he chose were bound to him by the closest ties of companionship. His manner was unassuming; his ways simple and at all times he showed a genial, kindly and sympathetic side to all with whom he came in contact. His sense of justice was clear and keen and his moral standards the highest, and men who had relations with him of a business or social character soon learned to appreciate his worth. In assisting others, when he could do so, he took great pleasure.

The fact that many people continued business relations with him for long periods of time tells better than words the fact that he won and maintained the respect and confidence of all those with whom he moved and worked. A watchmaker had been in his employ from 1866

through the various changes, and is still with the firm. Several others have been associated with him for 20 years or more. Various organizations to which he was a member have passed memorial resolutions indicating the high regard in which he was held.

The body will be taken, on arrival in New York, to his home, 64 E. 83d St., where Mr. Lissauer had bought a residence a number of years ago. He is survived by a widow, one daughter and a grandson.

At a special meeting of the officers and executive committee of the Jewelers' League of New York, held in its offices June 20, the following preamble and resolutions were unanimously adopted:

The officers and executive committee of the Jewelers' League of New York, having been notified of the death of the first vice-president, their associate and fellow member, Max J. Lissauer, and desiring to give expression to the profound sorrow felt by every member of the organization, have ordered the following resolutions to be spread upon the records of the League, and instruct the secretary to transmit an engrossed copy thereof, to the family of the deceased:

*Whereas*, We deeply mourn in the death of our beloved vice-president, Max J. Lissauer, the loss of a true friend and an upright business associate of unexcelled integrity, a gentleman in all walks of life, always ready to devote his disinterested aid and counsel to the best of his great abilities to the welfare of religious, charitable, business and social affairs, but especially most energetically to the success of the Jewelers' League, which he has faithfully served as vice-president or as a member of the executive committee for nine successive years.

*Resolved*, That in the death of Max J. Lissauer, the jewelry trade of the entire country has lost one of its most eminent men. By his faithful work as vice-president of the Jewelers' League and as an officer and member of various other trade organizations, he contributed in no small degree to the welfare of these associations, and to the making of them what they are to-day, successful, co-operative trade institutions.

*Resolved*, That by his demise the League has lost an energetic officer, and a most congenial friend and loved companion.

*Resolved*, That we tender to his bereaved family our sincere sympathy in their irreparable loss.

*Resolved*, That the officers and executive committee attend the funeral service in a body, and as a further mark of respect this office remain closed on the day of the funeral, and that this meeting do now adjourn.

#### Death of Charles F. Kern.

ROCHESTER, N. Y., June 25.—Charles F. Kern, treasurer of the Rochester Spectacle Co., on Water St., died of heart disease in a Pullman berth between Baltimore and this city Saturday morning. His death was not discovered until a porter started to awaken him. Mr. Kern retired in good spirits shortly after leaving Baltimore and died while asleep. On the arrival of the train in this city Coroner Kilip was notified, and took charge of the remains. An autopsy was performed the same evening.

Mr. Kern was 24 years old and unmarried. Up to a few years ago he was an employe of the Bausch & Lomb Optical Co. He left this company to form a partnership with Frank Stortz, also of the Bausch & Lomb house, to engage in the manufacture of spectacles. Mr. Kern was popular with the trade, and the business was successful from the start. His death will be mourned by many friends in this city and among the trade in general.

Wm. E. Crellin, Chillicothe, Mo., has been succeeded by E. M. Crellin.

**Mr. ABE A. HELLER**  
 is now in charge of our European offices, with headquarters at  
**39 Rue de Chateaudun, PARIS.**



BIRDSEYE VIEW OF PARIS.

Many years of studying the Jewelry trade here have given our Mr. Abe A. Heller an intimate knowledge of the wants of the American Manufacturer, which will be of great advantage in selecting the right goods for the American Market.

***L. Heller & Son***

Importers of Precious and Imitation Stones.

New York, 51 Maiden Lane      Providence, 212 Union Street  
 Paris, 39 Rue de Chateaudun      Idar, 14 Hauptstrasse

TELEPHONE 219 JOHN.

GEORGE H. HODENPYL.

WALTER N. WALKER

**DIAMONDS**  
 AND  
 DIAMOND JEWELRY  
**HODENPYL & WALKER**

Unique  
 and  
 Staple Patterns

**170 Broadway, New York**  
 Corner of Maiden Lane  
**TELEPHONE, 1898 CORTLAND**

Repairing and Recutting  
 Diamonds  
 a Specialty

<p>OUR  <b>40th</b>  <b>YEAR</b>                    IN                  BUSINESS                    1866-1906</p>	<p><b>DIAMONDS</b>      <b>CASES and MOVEMENTS</b>      <b>JEWELRY</b>                  LOOSE AND MOUNTED      ALL MAKES AND GRADES      GOLD AND PLATED</p> <p>ORDERS SOLICITED FROM RESPONSIBLE JEWELERS.      GOODS SENT ON SELECTION.</p> <p>All our goods are either direct importations, our own manufacture or bought for cash enabling us to offer special inducements in prices and terms.</p>
	<p>EST. 1866.</p> <p><i>Lissauer &amp; Company</i>                  Importers.</p> <p>2 TULPSTRAAT,                  AMSTERDAM.</p>
	<p>12 MAIDEN LANE                  (ONE FLIGHT UP)                  P. O. Box, 1625,  <b>NEW YORK.</b></p>

**PEARLS**      **ROUND, BUTTON**  
 AND **HALF.**

Selection Papers Sent on Request

**MARTIN LOW & TAUSSIG,**

51 Maiden Lane, New York.  
 Telephone, 2817-John.

139 Mathewson St., Providence, R. I.  
 Telephone, 3037-Union.

**Death of Edwin H. Poor.**

BOSTON, Mass., June 22.—Edwin H. Poor, a prominent member of the jewelry trade in this city, and jewelry buyer for the Shreve, Crump & Low Co., died suddenly of heart failure in the concern's store, Summer St. yesterday. His death was entirely unexpected and a great shock to his friends, as he had made preparations to sail Saturday from New York on a trip to the Mediterranean to benefit his health. Though severely ill, he felt that a rest was needed, but no one had any idea that his condition was critical until he was stricken in the store. Mr. Poor, who was about 65 years old, had a career in the jewelry trade of nearly



THE LATE EDWIN H. POOR.

of a century. He first learned the watchmaker's trade as it was taught in his time and later became employed by C. A. W. Osby, leaving the latter over 30 years ago to join the forces of Shreve, Crump & Low Co., with which house he spent the remainder of his life. When the Civil War broke out he enlisted in the Fifth Massachusetts Infantry and served three years before receiving his discharge. He was a member of the G. A. R., of the Masons and also of the Odd Fellows; he had traveled extensively in this country and Europe and had a wide number of acquaintances and friends.

Mr. Poor was a perfect embodiment of the old school gentleman. There are scores of regular customers of the concern which he served so long who never dreamed of making an important purchase in the watch or jewelry line without consulting Mr. Poor regarding the matter in hand. He was courteous, accommodating, patient and well informed regarding the details of manufacture, intrinsic values and other points calculated to be of assistance to purchasers. Such a man in a concern of the standing of Shreve, Crump & Low Co. had a most uplifting influence upon the entire personnel of the sales department. That he

**Clocks, Watches, Jewelry and Gems Imported Into Canada.**

TORONTO, Can., June 21.—The monthly report of the Department of Trade and Commerce of Canada for March, just issued, gives the value of imports for home consumption in the jewelry and kindred trades as follows:

	Month of March,		9 Months Ended March 31,	
	1905.	1906.	1905.	1906.
<b>Clocks:</b>				
Great Britain .....	\$1,030	\$276	\$8,773	\$7,963
United States.....	21,183	21,170	183,267	196,390
Germany .....	2,624	3,156	31,114	29,526
Other countries .....	660	342	10,836	12,979
<b>Totals .....</b>	<b>\$25,497</b>	<b>\$25,244</b>	<b>\$233,990</b>	<b>\$246,858</b>
<b>Watches:</b>				
Great Britain .....	\$1,379	\$1,713	\$18,111	\$21,784
United States.....	46,594	55,058	497,268	530,623
Switzerland .....	10,884	12,097	146,151	128,466
Other countries .....	679	1,801	23,485	38,512
<b>Totals .....</b>	<b>\$59,535</b>	<b>\$70,669</b>	<b>\$685,015</b>	<b>\$719,385</b>
<b>Gold and silver and manufactures of:</b>				
Great Britain .....	\$8,793	\$8,508	\$82,606	\$109,922
United States.....	24,780	24,120	243,121	231,772
Other countries .....	7,678	5,242	49,253	44,366
<b>Totals .....</b>	<b>\$41,251</b>	<b>\$37,870</b>	<b>\$374,980</b>	<b>\$386,060</b>
<b>Jewelry:</b>				
Great Britain .....	\$4,321	\$11,566	\$58,423	\$59,459
United States.....	54,046	71,517	531,132	540,242
Germany .....	2,979	2,092	41,390	39,509
Other countries .....	1,516	1,109	25,361	23,346
<b>Totals .....</b>	<b>\$62,862</b>	<b>\$86,284</b>	<b>\$656,576</b>	<b>\$662,556</b>
<b>Precious stones of all kinds and imitations of (dutiable):</b>				
Great Britain .....	\$1,060	\$83	\$7,550	\$6,262
United States.....	1,433	2,038	13,454	17,848
Other countries .....	1,063	1,373	14,133	18,683
<b>Totals .....</b>	<b>\$3,561</b>	<b>\$3,494</b>	<b>\$35,137</b>	<b>\$42,793</b>
<b>Precious stones of all kinds and imitations of (free):</b>				
Great Britain .....	\$41,887	\$64,807	\$178,635	\$330,209
United States.....	5,609	64,130	81,625	132,450
Holland .....	10,917	8,074	190,080	224,290
Other countries .....	26,477	84,053	477,053	326,675
<b>Totals .....</b>	<b>\$84,890</b>	<b>\$221,064</b>	<b>\$927,393</b>	<b>\$1,013,624</b>

was thoroughly appreciated and esteemed by his employers was a matter of course. That his associates also were grieved and shocked by his sudden demise is evident from the manner in which they speak of the establishment's loss and of his long and faithful service among them. In disposition he was quiet and genial and a universal favorite of all with whom he came in contact. Modest in the extreme, even his most intimate friends seldom knew the extent of his knowledge or acquaintance on various subjects until some particular occasion would serve to draw it out.

Deceased never married. He will be buried with the rites of the Masonic order.

**Death of H. M. Carpenter.**

MINNEAPOLIS, Minn., June 20.—H. M. Carpenter, president of the Minneapolis Jewelry Mfg. Co., died Monday of heart failure, aged 78 years. He leaves a widow and one son, Henry. Mr. Carpenter was a pioneer resident of Minneapolis, having come to the city in 1854, after having learned the jewelry manufacturing business in Providence. In 1858 he engaged in the general store business, but was burned out a year later. He determined to pay all his liabilities, which he did in six years.

In 1860 deceased engaged in the general store business again, and later was a paper manufacturer. He afterward established the Minneapolis Jewelry Mfg. Co. The latter was very successful, and Mr. Carpenter gradually withdrew from many of his other interests, although he continued a warehouse and building material business, under the name of the Union Railway Storage Co.

**Thieves Who Robbed Albany Jeweler Not Yet Captured—A List of the Missing Articles.**

ALBANY, N. Y., June 25.—A detective went to Troy last week and brought back a man who was suspected of being one of the thieves who recently robbed W. F. Antemann & Son, 21 N. Pearl St., as told in the last issue of THE CIRCULAR-WEEKLY. The prisoner was taken to police headquarters, where Mr. Antemann, after examining him carefully, stated that he was not one of the men whom he believed committed the theft.

Mr. Antemann has asked THE CIRCULAR-WEEKLY to ask its subscribers to let him know if any of the stolen property is offered to them for sale. Among the missing articles are: One diamond sunburst brooch, the diamond weighing altogether 2½ carats; one diamond and ruby ring set diagonally with diamonds weighing ¾—1/32 carat, ruby weighing 7/8—1/32 carat; one four-stone pearl diamond princess ring, with pearls weighing 8 grains and diamonds weighing 1½ + 5/32 carats; diamond and opal cluster ring; one single-stone navette cut ring set in platina, with stone weighing 2¾ + 1/32 carats, and 18 diamonds on each shank weighing 1/32 carat.

C. A. Elder has purchased the business of Lewis C. Pedersen, Walnut, Ia.

A portion of the roof of the Calendar Clock Co.'s factory, in Ithaca, N. Y., was blown off during a gale which swept over that place, about a week ago. A large chimney near the rear of the building was also blown down.

# Chester Billings & Son

1840

Successors to  
Kandel, Barmore & Billings

1906

Importers of Diamonds  
Other Precious Stones, and  
Pearls, Diamond Jewelry

1840, Kandel & Barmore; 1866, Kandel, Barmore & Co.; 1880, Kandel, Barmore & Billings; 1897, Chester Billings & Son

New York, 58 Nassau Street, 29 Maiden Lane  
London: 22 Holborn Viaduct, E. C. Paris: 53 Rue de Chateaubain  
Amsterdam: 2 Tulp Straat

## Many Opticians Pay Last Tribute to the Late Andrew J. Lloyd.

Boston, Mass., June 23.—Andrew J. Lloyd, whose death was reported last week in THE CIRCULAR—WEEKLY, was highly esteemed throughout the optical trade in the country. That fact was attested in several ways during the week succeeding his death, when the firm of which he was senior member was in receipt of many expressions of sympathy.

His career had been a conspicuously successful one, marked by steady growth and expansion, until the firm of A. J. Lloyd & Co. had attained a prominent place in the



THE LATE ANDREW J. LLOYD

the foremost concerns in all lines of business in this city.

At the funeral services there were a number of exceedingly beautiful floral tributes among them being remembrances from American Optical Co., the Globe Optical Co., Sussfeld, Lorsch & Co., Martin, C. Land & Co., Bausch & Lomb Optical Co., Oelschlaeger Bros., and others of prominence. A beautiful blanket of roses, tirelessly covering the casket, came from the firm's employes, by whom Mr. Lloyd was held in high esteem.

Rev. E. A. Horton, one of the best known Unitarian ministers in Boston, and personal friend of Mr. Lloyd, was the officiating clergyman. The burial was at Mt. Auburn Cemetery in Cambridge.

The third annual conference of American Republics will open in Rio de Janeiro, Brazil, July 21, and remain in session until Sept. 1. Secretary of State Root has selected six delegates of this country who will sail from New York. The conference has been the subject of a series of articles recently in the *American Exporter*, particularly the issue of June, which is Pan-American number, a perusal of which will prove highly interesting to all manufacturers and merchants engaged in trade with South and Central America. The entire issue is profusely illustrated with portraits of South and Central American presidents and typical views of tropical scenery. The publisher, William J. Johnston, will attend the conference and make an extensive tour of South America.



## COOPER'S

### SUN RAY DIAMOND

HAS 100 per cent. more brilliancy than any other style of cutting.

*We Challenge the World.*

Send your old mine and yellow diamonds to be recut; if the effect is not 100 per cent. better, NO CHARGE.

## COOPER DIAMOND

Cutting and Polishing Industry of America

49 MAIDEN LANE, NEW YORK.

Factories, 8th Ave. & 18th St., Brooklyn.

# EDUARD VAN DAM

# DIAMOND CUTTER

# AMSTERDAM NEW YORK ANTWERP

### Outing and Clambake.

#### Manufacturing Jewelers of New England Enjoy Annual Midsummer Sail and Feast.

PROVIDENCE, R. I., June 23.—That the Providence and Attleboro jewelers can make and make a fine showing, that the Attleboro men can play rings about the local location on the ball field, and that it is an even break when it comes to taking a fall out of the Rhode Island claim served in a bake, were among the things demonstrated at the annual outing of the New England Manufacturing Jewelers' and Silversmiths' Association held Friday. The men from the Attleboros led away the scalps of the Providence delegation of ball tossers to the tune of 2-2, and the much-talked-of game has none of its verdure as a topic of conversation, although the men from up north bring most of the talking. Providence, as she is, is silent.

The festivities, as usual, began with a tea, after a brief reunion at Freemasons' on Dorrance St. Here the members and guests were decorated with a tag bearing the inscription: "When this package is returned to N. E. M. J. and S. Association, Providence, R. I." On this was also placed the name of the wearer. Each member and guest was then provided with a Japanese umbrella. On the arrival of the Attleboro and North Attleboro delegation, some 100 odd strong, preparations were at once begun for the parade. This gave the line a treat.

There were about 400 in line, and every man was equipped with a parasol, and over his shoulder was slung a canteen, a precaution against any sudden indisposition. Led by Reeves' American Band and a platoon of police skirmishers, the marchers proceeded through the down-town section of Providence to the steamer *Warwick*, which awaited the party's arrival. Field's Point was the first stopping place, and here the members disembarked and proceeded to the dining halls, where Col. Atwell served one of his best shore dinners.

After dinner was over of the way, shortly

after 2 o'clock, the boat was again boarded and the jewelers started for Rocky Point, where the ball game was to be played. But they had a part to play before reaching there. Just off Crescent Park a sister steamer of the *Warwick* was found stranded on a sand bar. This predicament of fellow pilot was too much for the captain of the *Warwick*, and he went to the craft's aid. After much difficulty and the snapping of several hawsers, to the accompani-

c f.; Crandall, r.f. The All-Attleboro aggregation sized up something like this: R. Sherman, s.s.; Maintien, 2b.; Le Stage, c.; C. Sherman, p.; Frothingham, 3b.; Bullock, 1b.; Straker, r.f.; Hodge, 1.f.; Chisholm, c.f.

With the first stage of the battle, Providence at bat, the local rooters began to open up. It was well they did, for they didn't have much opportunity afterward. Reynolds, the first man up, found the curves of the Attleboro man altogether too de-



HOW THE JEWELERS PARADED TO THE BOAT LANDING.

ment of various helpful (?) suggestions from the party aboard the *Warwick*, the distressed vessel was once more floated and the jewelers proceeded on their way in the consciousness of a duty well performed.

Rocky Point was finally reached, and the ball game was started. The Providence warriors lined up like this: Reynolds, 2d; Carpenter, p.; Almy, 1b.; Ford, s.s.; Burt, 3b.; MacDonald, 1.f.; Williams, c.; M.F.'s,

ceptive and retired to the extreme rear. Carpenter connected with a high one and sent it out toward centre field, causing the gentleman in that section of the country much unnecessary labor. Almy got in the way of an inshoot and walked, but then Ford and Burt failed to connect for a hit and there was "nothing doing."

After that Attleboro had a turn. Some say the side was never rightfully retired,



SOME OF THE MEMBERS OF THE NEW ENGLAND MANUFACTURING JEWELERS' AND SILVERSMITHS' ASSOCIATION WHO ENJOYED THE OUTING.

# WM S. HEDGES & CO.,

IMPORTERS AND CUTTERS OF

## DIAMONDS.

Precious Stones and Pearls.

170 Broadway, Corner Maiden Lane, New York.

27 Holborn Viaduct, London.

Saunders, Meurer & Co. Cutters and Importers of

## DIAMONDS AND OTHER PRECIOUS STONES

FINE PEARLS A SPECIALTY.

65 Nassau St., cor. John St., Prescott Building, Telephone, 1613 Cortland, NEW YORK.

Chas. L. Power & Co., Cutters and Importers,

## DIAMONDS

AND OTHER PRECIOUS STONES,

170 Broadway, corner Maiden Lane, NEW YORK.

27 Holborn Viaduct, London.

## GOODFRIEND BROS.,

IMPORTERS AND CUTTERS OF PRECIOUS AND IMITATION STONES.

Pearls

Rubies

Sapphires

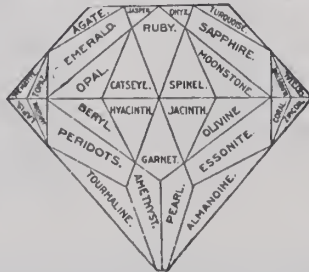

Tourmalines

Gem Corals

Opals

Emeralds

COPYRIGHT, 1895, BY GOODFRIEND BROS.

256 Westminster St., Providence, R. I.  
10 Rue Cadet, Paris.

Tel. No. 662 Cortland.

9-11-13 Maiden Lane, New York.

## CORAL

BORRELLI & VITELLI,  
CORAL MANUFACTURING COMPANY,

All kinds of Coral—DROPS, BUTTONS, LENTILLES.  
CORAL NECKLACES, Graduated and Uniform.

PINK AND WHITE CORAL A SPECIALTY.

GOLD MEDAL, ST. LOUIS, 1904.  
GRAND PRIX, LIEGE, 1905.

3 Via Amedeo, Torre del Greco, Italy. 32 Rue d'Hauteville, Paris, France.

401 Broadway, New York.

Telephone, 5412 Franklin.

CORAL

CORAL

because the scorer fainted from exhaustion and the umpires, Tom Catlow and Tomman, gave the visitors the double cross. It was more than hinted that Mills was being for his release, and the way the ind managed to keep out of the way of gro- ers and sizzlers was a sight for the g. Before the agony had been declared i- cially ended nine runs had come over rubber. Three more were annexed l- and Providence also managed to get t- history sayeth not how.

When the game was over the crowd back to the boat, having previously ha- picture taken for the enlightenm- future generations. On board the- there was more to eat and drink and sn- the band played popular and classical s- tions, George Dover sang tenor sol- a sail about the bay was enjoyed. This- brought to a conclusion sufficiently ear- allow the party to get back to this cit- time for the out-of-town members to c- the early evening trains.

The affair was under the direction of a executive committee, composed of Fran- Reynolds, Charles M. Robbins and H- Cutler, and was voted one of the most- cessful the organization has ever had.

### Creditors Ask That Severe Punishm- t- be Given Morris and Joseph Klein- Who Pleaded Guilty of Larceny.

Morris and Joseph Klein, who were- cers of Klein Bros. & Co., the bank- manufacturing corporation at 51 Ma- Lane, New York, appeared before Ju- Rozalsky in the Court of General Sess- of the Peace on Friday of last week for- purpose of receiving sentence on the ch- of grand larceny in the second degree- which they had pleaded guilty, as rel- in the issue of June 13. The case was a- postponed, this time until to-day.

The prisoners had been in court a w- before in order to get their sentence, at that time an adjournment was taken- the court desired time to consider st- ments made by creditors and complain- some of whom asked for lenient treatm- of the defendants, while others ad- that the punishment be made severe a- warning to other offenders.

When the case was called Friday, Al- H. Gleason, of Hastings & Gleason, as- torney for the Jewelers' Board of Tr- presented to the court a petition asking r- exemplary punishment. Accompanying s- petition were a number of affidavits fr- merchants who had sold merchandise to e- defendants. The petition, which was sig- by the representatives of 74 houses, set fo- that the Kleins had failed twice, the 11- time as a co-partnership and a few mos- later as a corporation. It was explai- that the practices of obtaining large cr- on false statements in writing and of e- verting merchandise obtained on memor- dum have grown to be serious evils in- wholesale jewelry district of New Yo- The petitioners said that if the Kleins- off with a nominal or light punishmen- will be an encouragement to others to i- tate them.

The acts of the Kleins in pawning la- quantities of merchandise and in refus- to answer questions in the bankruptcy co- were mentioned as additional reasons



extending clemency to them. The affidavits of John J. Hayden, the trustee in bankruptcy, said that the liabilities shown in the schedules of Klein Bros. & Co. amount to \$10,621. The total assets which have come into the trustee's hand from the receivers were \$906. At the first failure of the receivers they offered the creditors generally 10 per cent., 15 per cent. in cash and the remainder in notes, some of which are said to be still unpaid. It has also been said that several of the creditors have been paid in full.

Affidavits by members of C. F. Wood & D. C. Townsend & Co., I. Hochberger and others related to the Klein statement of their financial condition made in obtaining credit. Mr. Hochberger said that the statement to him indicated assets on August 10, 1905, upward of \$23,000, with liabilities less than \$11,000. On the strength of this showing Mr. Hochberger said he sold the Kleins diamonds costing \$675. The corporation went into bankruptcy the next month.

C. F. Wood & Co. received a similar statement from John B. Wood of that firm told, in an affidavit, of a conversation he had with the Kleins when they asked for credit. He refused to sell to them, as they had failed in his firm when they failed before. They said that their first failure was caused by the loss of a quantity of diamonds from them, but that they were then in a prosperous business. They also had a guarantee signed by a Maiden Lane merchant that notes covering the old indebtedness would be paid. Mr. Wood then advised them to run an account until they were more than \$4,000.

When the Kleins called on D. C. Townsend & Co., besides submitting a statement referred to C. F. Wood & Co. as to their standing. A representative of the latter house, when called up on the telephone, did not give them much of a recommendation. The brothers then deposited 9 shares of their capital stock with Mr. Townsend, as secretary, for an account which soon exceeded \$2,500.

Affidavits by C. N. Gray, of the Jewelers' Board of Trade, compared the indebtedness due from the Kleins on various dates with the statements which they made in getting credit. Mr. Gray said that his totals were below the actual amounts, as he had obtained a full list of the amounts owed by the brothers.

A member of the firm of Hirsh & Hyman made an affidavit in relation to a claim of \$925 against the Kleins, saying that a part of the amount was due for merchandise listed on memorandum. A similar affidavit by members of Hirsch & Flashner said that that firm had a claim of \$1,688, partly for merchandise delivered on memorandum. Affidavits also indicated that the Kleins obtained \$25,000 by pledging jewelry and diamonds with Harry Levy, and that they were in the habit of pawning stock with him.

T. P. Judd, a jeweler at East Fayette St., Syracuse, N. Y., notified the police of that city recently that he had been annoyed by the work of a swindler who had been engaging children to sell perfume under the promise that if they sold a certain amount they could obtain a gold ring by calling at Judd's store.

### Important Pearl Suit.

#### Government Brings Suit to Obtain Sixty Per Cent. Duty on Gems for Necklace Imported at Ten Per Cent.

A string of pearls imported by Bernard Citroen, of Paris and New York, has precipitated legal proceedings and a discussion as to the proper classification and duty of gems which may be used in necklaces. The pearls imported by Mr. Citroen are said to have formed the necklace described in THE JEWELERS' CIRCULAR-WEEKLY of June 13. In that issue was an interview with Maurice Brower, just back from Europe, who told of the sale by the Citroens, at Paris, of a necklace, at a price approximately \$100,000, to Mr. Leeds, of Pittsburg. Mr. Brower told a reporter of this paper that this was the necklace, well known to the trade, as the most costly creation of its kind that has been on the markets in Europe in years. Its value has sometimes been placed as high as \$600,000.

It appears that Mr. Citroen, who is in partnership at Paris with Hugo Citroen under the latter's name, brought the pearls into New York on payment of 10 per cent. ad valorem duty, the rate provided by Par. 436, of the Tariff Law for "pearls in their natural state, not strung or set." At that time there was no evidence before the authorities, it is understood, that the gems had ever formed a necklace.

The Appraiser's office, it is understood, passed the pearls at the 10 per cent. rate and Mr. Citroen took possession on paying this duty. Then there was a complaint, and Collector Stranahan liquidated the entry at 60 per cent., the rate prescribed by Par. 434 of the Tariff Law for jewelry, including "pearls set or strung." A summons was served, last Saturday, on Mr. Citroen in the office of his custom house brokers, on Beaver St., in an action begun, by the Government, in the United States Circuit Court to recover \$110,335 additional duties. This amount represents the difference between 60 and 10 per cent. of the appraised value, which was, therefore, upward of \$200,000, indicated that valuations commonly placed on the necklace were exaggerated.

Mr. Citroen was in Washington one day last week and was heard before Assistant Secretary Reynold, of the Treasury Department. The importer argued that the pearls should be admitted at the 10 per cent. rate, on the ground that they did not compose a complete necklace, as other pearls would be added by the buyer from time to time. According to the Washington dispatch Mr. Citroen said that his sale of the necklace was somewhat conditional, and he might lose the sale if the Government insisted on collecting the 60 per cent. duty.

Since the Government's successive defeats in the Tiffany, Neresheimer and Coolidge cases, all involving duties on the duty on pearls, it has made no effort until now to collect the 60 per cent. rate on gems of this kind. The customs officials had apparently reached the conclusion that under the decisions of the courts it was practically impossible to obtain the classification of pearls under the jewelry, or 60 per cent., clause. It has been said that, even if a necklace were bought in Paris for importation into this country, all that was necessary for the buyer to do in order to bring

in the gems as pearls in their natural condition was to take them off the permanent string and remove the clasp, when all evidence of a necklace would disappear. It has also been said that if this were not sufficient to get the 10 per cent. classification an importer could readily bring in the pearls in different packages, or on different ships, or mix with them other pearls.

A customs official in talking of the case said that, even if the pearls of this necklace came on a temporary string, the courts have held that this method is simply a convenience used in shipping the gems and does not make them in any sense a necklace. Still less is their reason to regard pearls as a necklace when they come in different packages, as decisions have frequently held that the customs officials can only pass on each importation when it is actually before them.

In the case of Mr. Citroen's pearls some of the importers think that this may have been an especially tempting case for the Government to make a new effort toward the collection of the necklace duty. The sale of the necklace in Paris was, of course, known to customs officers. They knew that the necklace was to be delivered in this country to Wm. B. Leeds, president of the Chicago, Rock Island & Pacific Railroad. According to the reports, he had bought the necklace in Paris after some bargaining, and obtained what was regarded as a desirable price. The pearls were intended as a present to his wife. It was a part of the agreement that one of the members of the firm should safely deliver the pearls in this country to Mr. Leeds, who came over with his wife about a week after Mr. Citroen arrived. It was said that the pearls, when entered, were a necklace in every respect, except that they were not on a permanent string and did not have a clasp.

The view taken by the law department of the Custom House seems to be that, as the decisions are conflicting, and as there is in this case direct evidence of the fact that these pearls did constitute a necklace, it is an especially fitting opportunity to obtain a definite decision on some disputed points. In the Tiffany case it was held by the United States Circuit Court of Appeals that the drilled pearls, under the similitude clause, come nearer in condition to natural pearls than to strung pearls, and the duty should be 10 per cent. In that case the pearls were not matched or selected.

In the Neresheimer case the pearls were assorted, assembled and matched as to color, size and quality. The United States Circuit Court of Appeals held, however, that the assembling as to color, size and quality was not such as to bring the collection within the jewelry clause. The court laid down the principle in the Tiffany and Neresheimer cases that when there is such a collocation of pearls that their aggregate value is greater than that of the individual pearls composing it, then the jewelry clause applies.

T. P. Judd, a jeweler at E. Fayette St., strung on cotton cords, but the evidence indicated that they had not been matched or selected, and that their value had not been increased by drilling and stringing. The Board of United States General Appraisers, therefore, held that the bunch of unselected pearls did not partake of the nature of

ADDISON W. WOODHULL, President.  
FRANK K. HUFF, Vice-President.

GILBERT T. WOODHULL, Treasurer.  
WILLIAM J. McQUILLIN, Secretary.

# MOUNT & WOODHULL,

IMPORTERS OF

**DIAMONDS,  
OTHER PRECIOUS STONES,  
PEARLS, ETC.**

MAKERS OF

**FINE  
DIAMOND  
JEWELRY.**

26 Maiden Lane,  
(Southwest Corner Nassau Street)

**NEW YORK.**

**PARIS ADDRESS:  
5 SQUARE DE L'OPERA.**

**BAGG, PERINE & CO.,**  
RARE SPECIMENS OF  
DIAMONDS AND OTHER  
PRECIOUS STONES,  
21 & 23 MAIDEN LANE, NEW YORK.  
Tel. No. 6228 Cortlandt.

**EMERALDS,  
DIAMONDS  
AND  
PEARLS.**

**RUBIES AND  
SAPPHIRES.**

**CABLE ADDRESS:  
MILBAGG.**

**M**Y interest is with the buyer. Why? He pays me 2 per cent. for my services. The seller's interest is with me. Why? He is not compelled to divide his profits with me and can afford to make the closest prices to my clients, thus reaching the best American trade on conditions that cannot fail to gain their preference.

The buyer's interest is also with me. Why? By not exacting the usual commission I make it to the seller's interest to favor my clients. Nothing is added to the price. I am content with what the buyer pays me. The buyer's advantage under such circumstances is equally as evident as the seller's. I invite investigation of that point.

**FREDERICK A. JEANNE,**  
"Gemfinder,"

5, Square de l'Opéra, PARIS, FRANCE.

London: Chancery Lane Safe Deposits.

New York: Maiden Lane Safe Deposit Co.

## The Graduation Gifts

### CROSSMAN COMPANY

Have them in their swell 14K. line of dainty Baroque Pearl Jewelry. Art Rings, Necklaces, Pendants, Collars and Ear-Screws especially.

3 Maiden Lane, - New York.

complete jewelry in any conceivable for While these cases were pending it came the practice among New York importers to bring pearls into this country before assorting, and the Government agreed to accept the 10 per cent. duty on such importations. After the victories of the importers in these suits the question was asked if it would not be safe for importers to buy the pearls after they were assorted abroad and then import them under the 10 per cent. duty. Several of the attorneys who represented the importers seemed to think that this could be done, but advised that the importers proceed cautiously.

One of the lawyers pointed out that with the importation of assorted pearls under the 10 per cent. rate was consistent with previous decisions, yet, under some circumstances a question might arise as to whether or not the assorting was of a character which would constitute a necklace or article of jewelry dutiable at 60 per cent. Examination of this question has apparently been raised in relation to the Citroen pearls.

It has been given out that Mr. Citroen, in his declaration, described the pearls as follows: One pearl, 52¾ grains; six pearls, 236¼ grains; eight pearls, 239 grains; twelve pearls, 214¾ grains.

To a reporter of THE CIRCULAR-WEEKLY Mr. Citroen expressed confidence that he has complied with the law in all respects and that the decision will be in his favor.

### Importations at the Port of New York

*Weeks Ended June 23, 1905, and June 22, 1906.*

China, Glass and Earthen ware:	1905.	1
China	\$80,307	\$11
Earthen ware	16,745	1
Glass ware	40,895	5
Optical glass		1
Instruments:		
Musical	14,785	
Optical	7,008	1
Philosophical	2,533	
Jewelry, etc.:		
Jewelry	4,316	1
Precious stones	715,267	1,29
Watches	28,336	
Metals, etc.:		
Bronzes	239	
Cutlery	19,912	
Dutch metal	2,739	
Plated ware	158	
Platina	1,287	
Silverware	4,000	
Miscellaneous:		
Alabaster ornaments	115	
Amber	16,130	
Beads	3,410	
Clocks	3,686	
Fans	2,757	
Fancy goods	7,314	
Ivory	103,878	
Ivory, manufactures of	198	
Marble, manufactures of	15,335	
Statuary		

Jewelry valued at \$500, which was taken from the store of Nathan Bachman, Chattanooga, Tenn, a short time ago, has been recovered. The stock was found in the possession of a local saloonkeeper, Louis Lyons, who was arrested on a charge of concealing stolen property. The arrest of Lyons and the recovery of the stolen property resulted from a confession made by a negro named Peak, who was convicted and sentenced to six years' imprisonment for stealing the stock from Bachman. Peak confessed that he disposed of the lot to Lyons for \$25.

**Connecticut.**

Hris Kugel has opened a new store at Temple St., New Haven.

Morris Hirsch & Son, Holyoke, Mass., recently sold out to M. W. Bassett, Hartford.

Lake & Strobel Co., Waterbury, has other concerns that decorated their shops and buildings for the Connecticut Centennial.

Arnold Gwillim, son of T. I. Gwillim, has been appointed assistant manager of the South New England Telephone Co., Stamford.

Eugene Watrus, East Hampton, for many years in the employ of the Bradley & Hubbard Mfg. Co., Meriden, died recently aged 86 years.

H. Newcomb and wife, Shelton, have returned on a month's vacation which they spent at Old Point Comfort, Washington, D. C., and Atlantic City.

John B. Bolling, with Galt & Bro., Wilmington, D. C., and Miss Viola Belden were united in marriage Wednesday evening at the home of the bride's mother.

Suydam Cornell, Jr., of Brooklyn, and Helen Lydia Merriam were united in marriage last week at the home of the bride in Middletown. Mr. Cornell is connected with the Middletown Silver Co.

John C. Clemmence, Terryville, recently celebrated his 88th birthday. Mr. Clemmence was at one time a well-known clock maker, having been associated with H. W. Brown & Co., in Terryville, in 1840.

The hammer arm of the clock in the Congregational Church, of Old Saybrook, was recently broken, preventing its striking. A new one will be put in at once. The church is one of the oldest in the State. It was organized in 1646.

Thomas L. Weidlich, for several years head of the firm of Weidlich Bros. Mfg. Co., Bridgeport, was killed last week by the overturning of a trolley car which left the track in Fairfield, near Bridgeport. The deceased is survived by a widow and one child.

Notices were posted in the Shelton factory of the International Silver Co., last week, to the effect that the annual Summer vacation will commence Saturday, June 30, and that the factory will reopen Monday, July 16. Extensive improvements will be made in the factory in the interim.

The funeral of Eliza Jaqui, wife of John Spencer, formerly a well-known jeweler of Norwalk, was held on Monday of last week in her home, 55 N. 17th St., East Orange, N. J. The interment was at Norriston. Among those who attended the funeral were Henry F. Coleburn and Frank Under, of Norwalk.

The Davis & Hawley Co. and E. W. Butler & Co., Bridgeport, on June 18 purchased real property at the corner of Main and Exchange Sts., known as Exchange Place, in that city, and have incorporated under the name of the Jewelers' Corporation. Exchange Place is one of the best business locations in that city, and the price paid is said to be about \$110,000.

John Ralston, or, as he is better known to the police, "Benny Haines," who was taken into custody a short time ago on a charge of being implicated in the theft of a

diamond pin from the store of the Davis & Hawley Co., Bridgeport, has admitted that he was implicated in the robbery, although he still denies that he actually committed the theft. The accused has promised to make restitution and has been released under \$300 bonds.

Lieut. H. A. Kippen died at the Old People's Home in Hartford last week, of heart disease, aged 79 years. The deceased was at one time engaged in the manufacture of jewelry with his father in Boston. He moved to Houston, Tex., in October, 1853, and became connected with a wholesale house. In 1856 he returned to Hartford. He was first lieutenant of Company K, 25th Volunteers, in the Civil War. Afterward he was for 19 years assistant town clerk of Hartford.

**Lancaster, Pa.**

Elmer Shertzler, with T. Wilson Dubbs, is on a trip to Maryland, his first vacation in 11 years.

Edward Rosenstein was last week elected president of the Minnehaha Social Club, a popular local organization.

Beginning the first Friday of July the Lancaster jewelers will close their stores at noon for a half holiday, continuing this during July and August.

Among the out-of-town jewelers here last week were: C. E. Hinkle, Ephrata; J. H. Sensenig, New Holland; Archie K. May, York; P. G. Diener, Harrisburg.

Walter Geist, who has been in ill health the past two years, has so far recovered that he has been enabled to resume work as foreman of the Lancaster Silver Plate Works.

The Hamilton Watch Co.'s factory will close from July 1 to 10 to give the employees a holiday, and some departments, now ahead with their work, will remain closed a week longer.

Jerome P. Smith, formerly of Lancaster, for the past seven years a jeweler of Louisville, Ky., died in that city Wednesday. He came to Lancaster from Buffalo, N. Y., about 10 years ago.

George R. Weber, of Louis Weber & Son, with his wife, entertained a number of friends at dinner Friday evening in honor of the coming marriage of Mrs. Weber's sister, Miss Anna L. Lintner, and Harry Martin.

D. L. Kauffman, Luray, Va., who was in Philadelphia on a business trip, stopped off in Lancaster last week on his way home to see friends at the Ezra F. Bowman Technical School, where he was once a student. John Gitt has finished a course in engraving at this school and gone to Littlestown, Pa., on a visit to his father, George Z. Gitt, before returning to Charlotte, N. C., where he is employed as a watchmaker by James C. Steer.

Walter A. Perry and Carl G. Aldrich, who recently formed a corporation under the laws of Maine as the Perry-Aldrich Co., with offices at Boston, Mass., are now carrying a full line of jewelry for the trade. Mr. Perry was located for a number of years at 44 Bedford St., and Mr. Aldrich was formerly in the retail jewelry business in Winsted, Conn.

**New Stores and Enterprises.**

M. S. Rose recently opened a store in Lone, Ore.

R. F. Newman is a new jeweler in Outlook, Wash.

J. R. Clairborne has opened a store in Lewiston, Idaho.

A. E. Shirley will shortly commence business in Myrtle Point, Ore.

Miss Addis will shortly start a retail jewelry business in Topeka, Kans.

S. McPherson will engage in business in Coupeville, Wash., in the near future.

Henry Birkestrand will soon engage in the retail jewelry business at Huxley, Ia.

J. W. McHenry recently opened a retail jewelry establishment in Trolleyway, near Lorelei St., Venice, Cal.

The Kelz-Myers Cut Glass Co. was recently incorporated in Honesdale, Pa., with a capital stock of \$15,000.

George Baer, formerly with D. H. Ahle, Lees Summit, Mo., has begun business for himself in Mound City, Mo.

J. C. LeMasters has gone in the optical business at 350 S. Broadway, Los Angeles, Cal., and has associated with him C. H. Van Breton.

Albrecht Kettnitz, watchmaker, formerly with G. W. Russell, Philadelphia, Pa., opened last week a retail store of his own at 320 W. Girard Ave., that city.

C. Mercury has established a rather unique concern at Buffalo, N. Y. It is in the nature of a combination jewelry and tailor store, probably the only institution of the kind in western New York or the entire State.

The Ives Inventions is the name of a new concern which was recently incorporated in the State of New York to deal in photographic and optical instruments. The directors are W. McLean, H. W. Hayward, New York, and B. H. Rouse, Brooklyn.

The Cambridge Novelty Co. was incorporated last week in Massachusetts with a capital of \$15,000 for the purpose of manufacturing and dealing in jewelry. The officers of the new corporation are: President, Robert Jenkins, 148 Fulton St., Brooklyn, N. Y.; treasurer, Frank J. Lightbody; clerk, Lulu Bethune, 5 Exeter Park, Cambridge, Mass.

A new optical firm under the name of the Dennison & Hallowell Optical Co. has started in business at 1649 Champa St., Denver, Colo. This is the same building which was formerly occupied by the Columbian Optical Co. Mr. Dennison has been connected with the optical business for the last 15 years, and comes from Salida, Colo. He traveled on the road for himself for many years. Mr. Hallowell has been in the optical business for the past nine years, and comes from Kansas City, Mo. The store has been equipped with the latest appliances, and a dark room has been fitted up.

W. F. A. Woodcock has closed his watchmakers' school in Winona, Minn., and left for New York. Mr. Woodcock has not yet determined upon his plans for the future. He opened his school in Winona May 1, 1887. The enterprise prospered from the start and the school was enlarged on several different occasions.

# EICHBERG & CO.,

IMPORTERS AND CUTTERS OF

## DIAMONDS,

65 NASSAU STREET, (Prescott Building.) NEW YORK.

# STERN BROS. & CO.,

IMPORTERS AND CUTTERS OF

## DIAMONDS,

CUTTING WORKS: 68 Nassau St., NEW YORK.  
138-142 West 14th St., N. Y.  
CHICAGO, LONDON,  
103 State St. 29 Ely Place.

# CHAS. S. CROSSMAN & CO.

The "Old Mine" Diamond House

Are always ready to make cash offers on Diamonds, Fine Antique Jewelry of all descriptions, Pearls and Precious Stones.

ESTABLISHED 1880 ESTATES A SPECIALTY  
3 MAIDEN LANE.

N. B.—Our Baroque Pearl Jewelry manufacturing Business has been incorporated as the CROSSMAN COMPANY

## A. ROSEMAN, 9-11-13 Maiden Lane, New York

IMPORTER OF

# DIAMONDS

Maker of Diamond Jewelry



TRADE-MARK.

Established 1872

HEADQUARTERS FOR

# AMERICAN WATCHES

IMPORTERS

## DIAMONDS

CUTTERS

# Jacob Strauss & Sons

14 MAIDEN LANE

NEW YORK

Telephone 4115 Cortland.

# LEO GOLDSMITH

IMPORTER OF

## DIAMONDS AND PRECIOUS STONES

Headquarters for RECONSTRUCTED RUBIES and SAPPHIRES. All Sizes and Forms.

9-13 MAIDEN LANE, NEW YORK

## "PRACTICAL COURSE IN ADJUSTING."

PRICE \$2.50.

ALL JOBBERS OR JEWELERS' CIRCULAR PUB. CO.

### Baltimore.

M. Kohner was in New York last week. The big City Hall clock was worked badly last week, and has been repaired. Superintendent of Public Buildings Joseph expressed the opinion that he thought it would be advisable to place an electric clock in the dome of the hall.

The last meeting of the Old Town Merchants' and Manufacturers' Association before the Summer recess was held last week, completing arrangements for its annual convention to Atlantic City, N. J., June 27, 28, 29. They will stop at the hotels Isleworth and Bothwell.

Miss Grace R. Castelberg daughter of Henry Castelberg, was married to Herbert Kraus, of New York, June 18, at the Hotel Stafford. The couple left for a wedding journey north, and will reside in New York. The bride's only ornament was a handsome diamond necklace, the present of her father.

The appointment by President Roosevelt of Gen. J. Stuart MacDonald as naval officer for the port of Baltimore, last week has met with the satisfactory approval of all those out of politics, as Gen. MacDonald's sterling qualities, both in business and political affairs, have been a foregone conclusion. The appointment came to him entirely unsolicited and is a recognition of worth.

### O. G. Fessenden Unanimously Re-elected President of the National Credit Men's Association.

BALTIMORE, June 21.—O. G. Fessenden Hayden W. Wheeler & Co., New York, president of the National Credit Men's Association, was re-elected at the annual convention held last week in this city. So enthusiastic was the feeling in favor of Mr. Fessenden's re-election that no formal vote was taken, his election being by acclamation.

The association's Committee on Investigation and Prosecution, in submitting its report on the work of last year, reviewed the case of Arthur M. Felsen, a jeweler, formerly of Gouverneur, N. Y. The committee said that in this case it had the cord support of the Jewelers Board of Trade, New York. The facts as to the indictment of Felsen and his trial, resulting in a verdict of guilty, were mentioned, and it was added that a determined effort would be made at the second trial to secure conviction.

### Jewelers' Gold Bars Withdrawn and Exchanged at New York.

Week Ended June 23, 1906.

The U. S. Assay Office reports: Gold bars exchanged for gold coin...\$507,611 Gold bars paid depositors..... 57,088

Total	\$564,699
Of this the gold bars exchanged for gold coin are reported as follows:	
June 18	\$163,100
" 19	35,800
" 20	50,800
" 21	118,400
" 22	83,100
" 23	56,100
Total	\$507,600

Edward Morris was recently taken into custody in Sedalia, Mo., on a charge of selling cheap jewelry without a license.

**Denver**

M. Bently, of Bently & Craig, was a re-  
 visitor in this city.  
 William Oppenheim has returned from a  
 business trip in Chicago.  
 Boyd E. Gardner, Longmont, Colo., was  
 a visitor in the city last week.  
 B. King, of W. W. Hamilton & Co.,  
 returned from his Summer vacation.  
 M. Ratliff has taken a position as  
 a maker with I. Zeller, Durango, Colo.  
 A. Syman, of Syman Bros., expects to  
 start on a business trip the first week in  
 July.  
 E. A. Eaves, Idaho Springs, Colo.,  
 returned upon some of her friends here last  
 week.  
 C. Bloom & Co. expect to have new  
 fixtures installed in their store by the end  
 of this week.  
 Rapin, Central City, Colo., called on  
 some of his business acquaintances here  
 during the past week.  
 L. Bentz, of W. W. Hamilton & Co.,  
 returned from a two months' trip  
 through the northwest.  
 Ador Lederer, representing S. & B. Led-  
 erer Co., stopped off in this city on his way  
 to the east last week.  
 H. F. Hanson, watchmaker for McLean  
 B. Lanier, Colo., passed through town  
 on his way home from the east last week.  
 X. Newburger, formerly watchmaker  
 of the Bohm-Allen Jewelry Co., has start-  
 ed on business for himself in Spokane,  
 Wash.  
 George Smith, with Joseph I. Schwartz,  
 returned to work again after a three weeks'  
 vacation in St. Paul. Mr. Smith visited friends  
 in Minneapolis and St. Paul.  
 H. Leppla, of the Bohm-Allen Jewelry  
 Co., with his family, enjoyed a short visit  
 in Shawnee, Colo., during the past week.  
 Leppla spent most of his time in fishing.  
 The Bohm-Allen Jewelry Co. is having  
 its store decorated. The walls are being  
 decorated with a very pretty olive green,  
 while the ceiling is being tinted with cream  
 white.  
 W. Hogan, representing Rogers & Ham-  
 ilton Co., Waterbury, Conn., called on the  
 trade last week. Mr. Hogan is in his  
 10th year, and is always glad to get back  
 to Colorado.  
 J. Miller has opened a new store at 328  
 1/2 St., and, judging from the location,  
 is fair to do a good business. Mr. Miller  
 received his preliminary training in several  
 of the leading jewelry stores here.  
 W. W. Hamilton, of W. W. Hamilton &  
 Co., with his family, has returned from a  
 trip through Los Angeles and San Fran-  
 cisco, Cal. On the way home the party  
 visited the Grand Cañon and Arizona.  
 J. Reincke, of R. Reincke & Co., who  
 has been sick with inflammatory rheumatism  
 since March, is able to be about again. He  
 made frequent visits to his store, but  
 has not been actively engaged as yet.  
 E. J. Henry, with E. W. Bailey, of  
 Rocky Ford, Colo., attended the State Sun-  
 school convention held in this city last  
 week. Mr. Bailey has moved to Swink,  
 Colo., where he has opened a new shop.  
 L. Harrod, of J. C. Bloom & Co., has  
 returned from a business trip through  
 the west and western Kansas. S. H. Shef-

fel, of the same firm, has also returned home  
 after a successful trip through Nebraska.

At a meeting of the Denver Press Club  
 last week each member was presented with  
 a gold monogram button, fashioned by the  
 Boyd Park Jewelry Co. out of a \$400 gold  
 bar donated to the club by James F. Burns,  
 Colorado Springs, Colo. The metal was  
 taken from the famous Portland mine in  
 the Cripple Creek district. The design is  
 very unique and neat. The D. P. C. is in  
 monogram, and through the center of the  
 entwined letters are a quill and a sword.

A dance was given in the Elks' rooms,  
 Mining Exchange building, last week, by  
 the Elks' escort team, and Sam Mayer, the  
 well-known 15th St. jeweler, presented three  
 beautiful gifts to the best three teams carry-  
 ing off dance-hall honors. The first prize  
 was a gold bracelet, and was won by Miss  
 Josie Wallace. The second prize, a Russian  
 leather pocketbook, was won by Mrs.  
 Granger, while the last honors were carried  
 off by Miss Wheeler, in the form of a gold  
 hatpin.

The Boyd Park Jewelry Co. last week  
 supplied a badge which was presented to  
 George W. Curfman, past department com-  
 mander of the G. A. R. of Greeley, Colo.  
 The badge was given to Mr. Curfman by  
 the comrades from Wyoming and Colorado.  
 The upper bar was of gold and contained  
 two stars set with diamonds, while the  
 lower portion was a five-pointed star, each  
 point containing a solitaire. The badge was  
 made of Roman gold and a very fine qual-  
 ity of enamel.

**Harrisburg, Pa.**

The jewelry store of Nathan Gross, in  
 Gratz, this county, was entered by burglars  
 recently and jewelry to the value of \$400  
 was carried away. Mr. Gross offers a re-  
 ward of \$25 for information that will lead  
 to the detection of the thieves.

Announcement has been made of the  
 various awards for State supplies, etc., for  
 the year ending June 6, 1907, by the Board  
 of Commissioners of Public Grounds and  
 Buildings. P. G. Diener, of this city, was  
 given the contract to care for the various  
 clocks about the capitol building, and for  
 any new clocks that may be requisitioned  
 during the year.

Policeman Charles W. Saum, of this city,  
 was acquitted in court last week of the  
 charge of involuntary manslaughter. Saum  
 shot and killed Harold Hall, a young col-  
 ored boy, Oct. 18, 1905, while the latter was  
 attempting to enter the jewelry store of  
 Charles Adelstine, 707 N. 3d St., for the  
 purpose of robbery. Saum was first in-  
 dicted for murder, but the charge was sub-  
 sequently changed to involuntary man-  
 slaughter.

The Freeman-Daughaday Co., Chartley,  
 Mass., is having erected one of the most  
 modern factories for the manufacture of  
 jewelry that has yet been built in this  
 section. The structure will have a 40-foot  
 frontage and will be 250 feet deep. The  
 framework will be of the heaviest tim-  
 bers and constructed so that a second-  
 story may be added when necessary. The  
 walls as far up as the windows will be of  
 concrete cement, and the floor is of the  
 same material covered with three inches of  
 wood.

**Rochester.**

Many New York opticians will go to  
 Rochester from the city of New York dur-  
 ing the coming convention, which will open  
 July 30, by first sailing to Albany by boat  
 and proceeding thence to Rochester by way  
 of the New York Central, Erie, West Shore  
 or Lehigh Valley railroad. The reduction  
 to the convention will be full fare one way  
 and one-third returning, on the certificate  
 plan. Opticians are advised to ask for a  
 certificate when purchasing their tickets.

When Genesee Falls Lodge 507, F. & A.  
 M., celebrated its 45th anniversary the  
 event was the occasion of much comment  
 on the activity of John T. Fox, the well-  
 known jeweler, who is the only living  
 charter member of the lodge. Mr. Fox,  
 who is 85 years of age, is said to be the  
 oldest charter Mason in the State of New  
 York, and is the only Mason outside of an  
 officer permitted to sit on the rostrum  
 with the master, for which purpose a  
 beautiful mahogany chair bearing a plate  
 inscribed with details of the occasion of  
 its presentation was given to Mr. Fox a  
 year ago. Mr. Fox has been in the jew-  
 elry business about 68 years.

Owing to the refusal of about half a  
 dozen firms to sign the agreement, Satur-  
 day afternoon closing will not be general in  
 Rochester this Summer. The committee  
 having the matter in charge worked hard  
 for the success of the movement. It is to  
 the credit of the Rochester jewelers that  
 not one of them refused to sign the agree-  
 ment—in fact, the jewelers were among the  
 strongest advocates of the closing proposi-  
 tion, and Mr. Watkins, of W. H. Glenny &  
 Co., was one of the most ardent and enthu-  
 siastic workers for the movement. Follow-  
 ing the failure of the general closing, W. H.  
 Glenny & Co. were the first among the up-  
 town merchants to publicly announce Satur-  
 day afternoon closing during July and Au-  
 gust. Other jewelers and merchants are  
 following their example.

Burglars met a warm reception when they  
 attempted to rob the jewelry store of W.  
 W. Dort, at Belfast, a small village near  
 here. Mr. Dort was awakened one night  
 last week by a noise of somebody moving  
 about the store, which is below his living  
 apartments. Arming himself with a re-  
 volver and a shotgun, Mr. Dort quietly  
 went below. He saw a man standing in the  
 entrance door and ordered him to throw up  
 his hands. The man backed away and then  
 attempted to put his hand to his hip pocket.  
 Mr. Dort fired the shotgun at him upon this  
 movement and wounded the man in the  
 hand. A second man then appeared and  
 started for Mr. Dort, who fired his revolver  
 at him. The man fell to the floor and it  
 was afterward found that he had been  
 wounded in the hip. The second burglar  
 had secured quite a little booty, which was  
 found lying beside him. The bullet was  
 removed from his body and he was taken  
 to the Belmont jail. The first burglar had,  
 meanwhile, made his escape, but was cap-  
 tured later a few miles distant. Both men  
 were sentenced to Auburn prison the next  
 day.

Chas. N. Hancher, Wheeling, W. Va., re-  
 turned recently from his annual purchasing  
 trip to Europe.

# BRAZILIAN EMERALDS

GREEN TOURMALINES ARE SOMETIMES KNOWN AS BRAZILIAN EMERALDS. THE COLORS SHADE FROM A LIGHT APPLE GREEN TO A DARK BLUISH BOTTLE GREEN. WE HAVE A GOOD STOCK OF THE ROUGH WHICH WE ARE CUTTING IN VARIOUS SIZES AND SHAPES.

## BUY FROM THE CUTTERS

**AMERICAN GEM & PEARL CO.**

14 & 16 Church St., NEW YORK

LONDON: 16 Holborn Viaduct

PARIS: 39 Rue de Chateaudun

**FROM MINES TO MARKET**

# DIAMONDS

Complete Stock—Right Prices

'NOUGH SAID

**WM. I. ROSENFELD**

19 Maiden Lane

NEW YORK



TRADE-MARK.

## AZTEC TURQUOISES

Mines: MINERAL PARK, ARIZONA.



TRADE-MARK.

Of true CERULEAN BLUE, the rarest and most fashionable shade. Turquoises bearing Company's trade-mark are GUARANTEED. A new Turquoise will be given without question to replace any that discolors. The leading Jewelers of the World sell AZTEC TURQUOISES.

**THE AZTEC TURQUOISE COMPANY,**  
12-16 JOHN STREET, NEW YORK.

## Last Week's New York Arrivals.

THE CIRCULAR-WEEKLY each day pos in its office a bulletin of the latest buyers visiting New York, which every member of the trade cordially invited to copy.

BALTIMORE, MD., G. W. Boettinger, Belvedere House.  
BATON ROUGE, LA., J. K. Roumain, House.  
BRIDGEPORT, CONN., J. C. Mizer (Hoy Dry Goods Co.), 75 Spring St.  
BUFFALO, N. Y., J. Clancy (H. A. Mel & Co.), Brozttell B. Block, Astor House.  
CHICAGO, M. Ellbogen (Stein & Ellbogen Astor House).  
CINCINNATI, O., H. W. Voss (Jos. S. V Sons), Imperial.  
CLEVELAND, O., H. W. Burdick (Bow Burdick Co.), Victoria.  
CULPEPPER, VA., H. C. Burrows, Continent.  
DENVER, COLO., B. Petherick (A. T. Le Son Dry Goods Co.), Prince George.  
DETROIT, MICH., J. W. Kay (Wright. F. Co.), Manhattan.  
HAZLETON, PA., S. Engle, Imperial.  
INDIANAPOLIS, IND., I. Grohs (I. Grohs elry Co.), Broadway Central.  
MIAMI, FLA., H. T. Whaler, Sinclair.  
MINNEAPOLIS, MINN., F. L. Bosworth (Bosworth Co.), Gilsey.  
MOBILE, ALA., I. Dahlheimer, Belvedere.  
MONTREAL, P. Q., M. Michaelson (M M son & Co.), Imperial.  
NEW HAVEN, CONN., Miss Pattee (Hos Stetson), 75 Spring St.  
PAWTUCKET, R. I., T. W. McGarry (Shberg & Robinson), 75 Spring St.  
PITTSBURG, PA., A. I. DeRoy (I. DeRoy Son), Manhattan.  
ST. JOSEPH, MO., R. Walter Powell (J. S. tain Dry Goods Co.), Holland.  
TROY, N. Y., J. W. F. Podmore (Jones & more), St. Denis.  
WATERBURY, CONN., J. L. Gaffney (G Jewelry Co.), Grand Union.  
WHITE RIVER JUNCTION, VT., B. (Bogle Bros.), Broadway Central.  
WORCESTER, MASS., C. W. Waldo (De & McKay Co.), 2 Walker St.

## Washington, D. C.

Notice has been given by A. D. P. Harry King, Hattie Harris and Leo Reizenstein, executors of the estate of late Reuben Harris, that they have obtained from the Probate Court letters testamentary on the estate. All persons having claims against the deceased are advised to call on the same, with the vouchers thereof, before June 8, 1907, otherwise they may be by law excluded from all benefit of the estate.

The restraining order recently obtained by the McKay Co. against James C. Buchanan, restraining Buchanan from interfering with the McKay Co.'s half of the store, 1115 F St., N. W., has been dissolved by the Equity Court. A rule issued requiring Mr. Buchanan to show cause why he should not be held in contempt of court for violating the court order has also been dismissed. The court held that McKay Co. did not sustain the charge. In addition to the above the injunction proceedings instituted by the McKay Co. against Buchanan were dismissed. T. H. Hall, lessee of 1115 F St., formerly occupied by the McKay Co. and James C. Buchanan, is now in possession of the premises by virtue of a writ of restitution which the marshal served last week.

**San Francisco.**

Y. Schussler & Co., who were located in the Spreckles Annex before the fire, are now in Oakland, at 8th and Franklin Sts. A previously published report that J. S. Nielspiel, 2408 Fillmore St., had opened a pawnshop has been denied by Mr. Dinkel-

the Baldwin Jewelry Co. has its store on Van Ness Ave about ready for occupancy and will be open for business about

George Greenzweig & Co., who were formerly located in the Spreckles Annex at Market St., are temporarily located at California St.

W. H. Lippman, who were formerly Hammersmith & Field, at 36 Kearny have branched out for themselves and are now located at 1790 Post St., where they carry a line of clocks, watches and jewelry.

The Bohm Bristol Co. expects to be in its store at Sacramento St and Van Ness Ave about Sept. 1. Before that time the firm does not think that much business will be done on Van Ness Ave., owing to the confusion of building operations.

The W. K. Vanderslice Co. has not decided as yet just what course it will pursue. At present it is making no attempt to re-open its business, preferring to wait and see if the insurance question is settled. The jewelry department at the office at Post and Devisadero Sts. is being kept busy.

W. J. Udke & Co. opened their new store, at Broadway and Van Ness Aves., Saturday, June 23, with a complete stock of jewelry, etc. The firm saved much of its stock from the fire and has done a good business at its Devisadero St. store, many tourists coming to select articles that were saved from the great San Francisco fire.

The store of Hammerstein & Field, at Broadway and Van Ness Ave., is now nearly in completion and will be ready for occupancy very soon. Part of the office furnishings are now in place, but the shelves and counters for the store have not yet arrived. The store is admirably located for this time of business, being on a prominent corner and just across the street from Tait's Jewelry Co.

W. H. Firsch & Kaiser announce that they have their own factory in operation now and are prepared for all optical work. They report that the sale of colored glasses and goggles of all descriptions has been heavier than ever before, and had it been possible to produce stock immediately after the fire many articles could have been disposed of. The heat and lime blown about by the wind in the burned district makes a protection for the eyes almost a necessity.

Although over 80 years old, Col. A. Andrews will enter the active business field again. His life's work, the Diamond Palace, is no more, but he plans to have it replaced on a more splendid scale than before, although it will not be the same old Diamond Palace that has for so many years been one of the sights of San Francisco. As has often been said, "to have visited San Francisco without seeing the Diamond Palace, would be like touring Europe without visiting Paris."

Quite a little colony of manufacturing

jewelers and diamond setters are now located on Buchanan St., near Ellis. Tuckey & Kline, diamond setters, are located at 1514 Buchanan St., in a store erected especially for them and they have rented room to A. L. Lott, a manufacturing jeweler and diamond setter, and to W. E. Robbins, a watchmaker. L. A. Giacobbi, a dealer in precious stones, is having an office fitted up at 1512 Buchanan St., and expects to be open for business by July 1.

**Omaha.**

H. Fuller, Chicago, has taken a position with Carson & Banks.

J. R. Clairborne, formerly of this city, has opened a store at Lewiston, Idaho.

H. H. Fuer, with the A. F. Smith Co., is spending his vacation with his parents in Chicago.

Oscar Homann, watchmaker for Brown & Borsheim, is visiting his old home in Des Moines, Ia.

Miss Mary Hurst, with Brown & Borsheim, has gone for a two months' vacation in Colorado.

C. L. Shook, of the Shook Mfg. Co., has returned home from a seven weeks' trip to the Pacific northwest.

Mr. Beck, of the Will H. Beck Co., Sioux City, Ia., was in this city attending the Trans-Mississippi Golf Tournament, last week.

There is a movement on foot to close all the leading stores, including the jewelry stores of Omaha, at 5 P. M. during July and August.

R. W. Scott, formerly with Albert Edholm, but at present located in Hot Springs, S. Dak., was called to this city, last week, by the appearance of a brand-new baby boy at his home.

James McRay was taken into custody last week in this city, having in his possession several watches and valuable rings. A search of his room in a cheap hotel disclosed an imitation of a policeman's badge and a loaded revolver.

The following out-of-town jewelers were in this city last week, replenishing their stocks: John Crabill, Plattsmouth; J. M. Graham, Valley; A. H. Lewis, Sutton; John Wehrli, Missouri Valley, Ia., and Fred Gardner, Lincoln, Nebr.

Among the members of the retail jewelry trade who accompanied the second Omaha trade excursion last Wednesday were the A. F. Smith Co., and the Mahwinney & Ryan Co. The route was through southeastern Nebraska, a part of the city which had not been visited lately by the Omaha trade.

A man who gave his name as George Hawkins was arrested in the jewelry store and pawnshop of J. H. Linsky, 1121 Douglas St., this city, last week, while attempting to sell a solid gold watch for \$2.50. The man's general appearance attracted attention and aroused the suspicions of the officers, and they took him to the police station, where, on being searched, they found in his possession six gold watches, four gold rings, a number of fobs, chains, stickpins and other jewelry, some set with diamonds and other valuable stones, also a pawn ticket for still another watch. An unused handkerchief bearing the name C. R.

Holden, and a piece of wrapping paper bearing the name of A. G. Beech, a merchant of Atlanta, Ia., were also found. Three of the watches were women's and three men's. One was engraved with the initials "M. E. A." and another "I. W. to N. R." The man refused to give any information regarding the goods.

**Pacific Coast Notes.**

W. A. Manson, of Manson & Bay, San Bernardino, Cal., is expected home, this week, from a six weeks' visit in Canada and Indiana with relatives and friends.

B. Van Vranken has purchased an interest in the business of R. Wickman, 1228 Broadway, Oakland, Cal. The firm will be known as Wickman & Van Vranken.

Hoe Minassini, formerly of Santa Barbara, Cal., who for a long time past had been connected with one of the leading San Francisco firms, is visiting in Santa Barbara for a short time.

H. Morton, successor to the A. Steffanoni Co., gold and silver smiths, announces that he is now located in his new store at 1109 Broadway, Oakland. His new goods ordered from the east have not suffered, and it is announced that his stock is complete.

The jewelry misappropriated from La Esmeralda, in the City of Mexico, by a man named Diaz, and which was recovered, has been returned by Lic. Moises Garcia, first judge of instruction. Diaz is still in prison and obstinately refuses to reveal the names of his accomplices.

A. H. Witman is preparing to open a jewelry store at the corner of 2d and Main Sts., Pomona, Cal. The storeroom will be under the process of construction for the next month. The store will be furnished with polished cherry and heavy plate glass, and the walls and ceilings are to be frescoed in delicate tints.

Capt. Frank D. Ely, San Francisco, has received a telegram from his lawyers informing him that they have secured a patent on a rubber ring which is made to fit around the edge of a watch. It is supposed to keep dust out of the watch, to relieve the jar, and to make it harder for the pickpocket to pull watches out of people's pockets.

Charging fraud in the sale of a half interest in a jewelry store at Santa Monica, Cal., D. H. Lucas has filed suit in the Superior Court against W. O. Truax for \$1,000. He formerly owned 347 acres of land in Manitoba, and declares that his former partner, Truax, by valuing the stock of the store too highly, forced him to mortgage his land and later to sell it at a loss of \$1,000.

George Romine, a laborer, was arrested, June 14, at Fresno, Cal., for forging the name of Peter Schaffner, a rancher of Clovis, to a bond that he might secure nearly \$200 worth of diamonds and jewelry from an eastern firm. According to the allegation, he practiced the signature of his master by night and finally signed the bond and sent it off to the firm. The goods arrived and were taken by Romine, who was in Fresno. Constable Parker overhauled the bedroom of Romine and found the jewelry in a bag. It is not known whether any of the articles are missing.

SEND TO US ANY QUANTITY OF

# AMERICAN PEARLS

WE BUY FOR CASH.

Send by registered mail or express; we will make an offer by return mail. We will also buy any quantity of

**BAROQUE PEARLS (SLUGS).**

## BUNDE & UPMeyer CO.,

Mack Block,

MILWAUKEE, WIS.



## CHOPARD FRÈRES

MAKERS OF FRENCH JEWELRY NOVELTIES

49 Maiden Lane

NEW YORK

The call in the United States for French Jewelry is increasing. Dealers are realizing that it is quick selling with good profits. We manufacture and carry only the finest grade in the newest creations; our stock is most complete and orders are promptly filled. Why not try our goods? Others have, with great success.

**Brooches—Bracelets—Rings—Scarf Pins—Necklaces  
—Barrettes—Collarettes**

**FINE JET GOODS A SPECIALTY**

Cutters of  
DIAMONDS

THE BOSTON DIAMOND HOUSE

**JOHN B. HUMPHREY CO.**

387 Washington St., Boston, Mass.

We are receiving Monthly Shipments of Diamonds from our Brazilian Mines, which are on exhibition at our Boston Office.

Cutters of  
DIAMONDS

**Encyclopedia-Dictionar**

and reference hand-book of the Ophthalmic Sc.

Price, \$2.50.

The Jewelers' Circular Pub. Co., 11 John St.

## MEYEROWITZ BROS.,

IMPORTERS OF

# DIAMONDS,

37-39 MAIDEN LANE,  
NEW YORK CITY

A Complete Line of Precious, Semi-Precious and Imitation Stones. Mail orders promptly attended to



# Bigalke & Eckert Co.

## IMPORTERS OF WATCHES,

No. 1 MAIDEN LANE, NEW YORK



Single and Split Second Timers in Nickel and Gun Metal Cases.

Complete Assortment of Chronographs,  
Split Seconds and Minute Repeaters.

Ladies' and Gentlemen's Flat and Ultra Flat Watches.



SOLE AGENTS FOR

### Huas, Neveux & Cie.

FINE GENEVA WATCHES.

**Horological Department,**  
**BRADLEY POLYTECHNIC INSTITUTE,**  
Formerly Parsons Horological Institute,  
PEORIA, ILLINOIS.  
Largest and Best Watch School in America.  
Watch Work, Jewelry, Engraving, Clock Work,  
Ocs. Tuition reasonable. Board and rooms near  
at moderate rates Send for Catalog of Information.

**SOHN and HYMAN**  
IMPORTERS OF PRECIOUS AND IMITATION STONES  
Crystals Engraved and Painted from Photo. Crests and Coats of Arms Engraved. Stone  
Seal Engravers and Incrusters. Lapidary Work a Specialty.  
**JOBGING STONES A SPECIALTY**  
47 and 49 Maiden Lane, NEW YORK

**AMERICAN PEARLS**  
*From Ten to Ten Thousand Dollars Each*  
**MAURICE BROWER, 16 John St., New York.**

**Encyclopedia-Dictionary**  
reference hand-book of the Ophthalmic Sciences.  
Price, \$2.50.

Jewelers' Circular Pub. Co., 11 John St., N. Y.

## BLACK LEATHER LOVING CUPS

SILVER PLATED MOUNTINGS  
GOLD LINED

(Patented Aug. 1st, 1905)



No. 636—List \$13.50



No. 631—List \$9.50



No. 635—List \$8.75

NEW IDEAS, ARTISTIC DESIGNS, SMOKING SETS, TANKARDS,  
STEINS, ETC.

**St. Louis Silver Company,**  
ST. LOUIS, U. S. A.

A COMPLETE LINE OF SAMPLES IN OUR NEW YORK  
OFFICE, 25 WEST BROADWAY.

# GORHAM WHIPS

## A TIMELY HINT

¶ During the months of Summer the demand for Lash Whips and Riding Crops is never-failing and the sagacious Jeweler will therefore see to it that his stock of these is complete and attractive.

¶ Gorham Whips and Crops present in themselves the same recognized standard of excellence as does Gorham Silver. They include Whips of the choicest Holly, with handles in silver-mounted leather or in effectively chased and ornamented silver, as well as Riding Crops of distinctively good "form," whether it be the plain, sturdy, but attractive Man's Crop or the dainty pigskin-covered and horn-handled Crop which is the horse-woman's ideal.

## THE GORHAM COMPANY,



CHICAGO,  
137 Wabash Ave.

Silversmiths and Goldsmiths

Fifth Avenue and 36th Street, New York.

BRANCHES:

NEW YORK,  
23 Maiden Lane.

SAN FRANCISCO,  
120 Sutter St.

LONDON,  
Ely Place.



WORKS: Providence and New York.

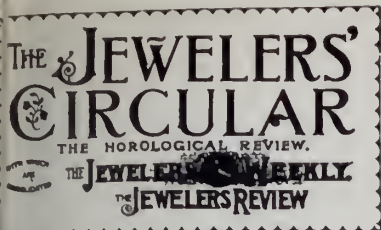

PUBLISHED EVERY WEDNESDAY BY THE JEWELERS' CIRCULAR PUB'G CO., 1 JOHN ST. COR. BROADWAY, NEW YORK. TELEPHONE: CABLE ADDRESS: JEWELAR NEW YORK

LII JUNE 27, 1906. No. 21.

Subscription in U. S., Canada and Mexico, \$2.00 For Countries in Postal Union, \$5.00 Single Copies, .10

Payment by check or money order. Remittances in money are at sender's risk.

Changes of standing advertisements may be received one week in advance; new matter may be received up to Monday.

Attention paid to communications unless accompanied by full name and address of the writer. This is asked not necessarily for publication, but as an evidence of good faith.

Index to Special Articles.

Table with 2 columns: Article Title and Page. Includes entries like 'Beautiful Silver Elk to Be Awarded at B. P. Convention', 'Fraudulent Marks', 'Business in San Francisco Increasing', etc.

Fraudulent Marks IN sentencing a Canadian silver company to pay fines of \$600 for falsely and fraudulently using the word or stamp "Sheffield" on wares which had been turned out at Niagara Falls, Judge Wells, of the General Sessions Court at St. Catharines, Can., took occasion to make some strong comments upon the practice of using false marks upon articles of merchandise and drew a parallel between such an act on the part of a manufacturing concern and the issuing of counterfeit money by a chartered bank. The concern was indicted upon four charges, one of manufacturing goods for the purpose of defrauding the general public and three of disposing of goods wrongly stamped; the concern pleaded guilty and a fine of \$150 was imposed for each offense. The case against the manager of the concern individually was dismissed.

This is but another indication of the importance to the trade and public of the question of accurate marking and branding of merchandise and will serve to call to the attention of manufacturers and dealers not only in Canada, but also in the United States, the fact that abuses of this kind are not as likely to be tolerated or leniently dealt with as they were some years ago, and that when the laws are such that a prosecution can properly be instituted, the offender cannot count on any undue leniency from judges or juries.

With the new laws protecting the stamping of quality on precious metals, the amendments to the trade-mark law recently passed increasing the penalties for infringement, and the general statutes covering the question of false branding and labeling which are now being agitated in the mercantile world, it looks as if manufacturers, merchants and the public had awakened to the necessity of eliminating this element of unfair competition that has so long existed in all trades, and the result cannot help but be beneficial to all lines of business, and especially to the jewelry and kindred industries.

A Small Form of A NEW system of Graft Among Jewelers.

raising money with which to fit up a jewelry store in a first-class style was recently called to the attention of THE CIRCULAR-WEEKLY. It was said that a jeweler has called on a number of manufacturers and jobbers informing them of the fact that he has leased a store in a highly desirable location, and that it is his intention to fit it up and furnish it handsomely and expensively. Toward the expenses of this enterprise he invited the wholesale merchants to contribute. Whether or not he promised to buy his stock from those who subscribe to his fund has not been revealed, but it would not be unreasonable for the manufacturer or jobber approached in this manner to suppose that a contribution would bring him at least a part of the retailer's business, while on the contrary, a refusal to give up money might mean the loss of such trade. According to the information that was received, a number of those approached found it convenient to contribute sums of \$50 or thereabouts.

A retail merchant who has been long in

the business, and who called attention to the subject, was emphatic in his opinion that if this case should establish a precedent or originate a practice in the trade, it would do great harm. He held that asking contributions for such a purpose is nothing more than a species of graft, and there is little doubt that such opinion will be concurred in by a large percentage of merchants and manufacturers. Manufacturers who so contribute simply assist their beneficiaries to compete with others who are now their customers, and it does not seem to be the province of manufacturer or jobber to foster competition in this way. The suggestion is made, and not without reason, that if manufacturers have any funds to give away they might as well give the benefit to their regular customers in reduced prices, treating all alike, as by giving business contributions to particular customers. THE CIRCULAR-WEEKLY would like to hear what manufacturers and importers have to say on this subject.

Business in San Francisco Increasing—Many Wholesale Firms Now Settled in the Kamm Building.

SAN FRANCISCO, Cal., June 20.—There is no complaint among San Francisco wholesale jewelers of business being dull at the present time. The fact is that they really have more trade than they can easily take care of under the chaotic conditions that still prevail here. Without an exception they have been burned out, and it necessarily takes a long time to get old accounts straightened out and new quarters established.

At present, the Kamm building, on Market St., is the center of the wholesale jewelry trade, and will likely remain so, as almost the whole building is now being devoted to this line of trade. The front part of this building was uninjured by the earthquake and fire and, although there is as yet no elevator in operation, the entire seven floors are in use. The first floor is occupied at present by the Morgan & Allen Co., which has its business in operation again and is now able to take care of all orders, both local and from the country.

The Jewelers Relief Committee is making its headquarters with this concern. The third floor will be occupied in its entirety by A. I. Hall & Son and about one-fourth of this space is now in a condition to be used. Workmen are now at work on the offices of Milton Bradley & Co. and those of H. O. Palen on the fourth floor, and business is being carried on during building operations.

Nordman Bros. are located on the fifth floor and will occupy more room when the rest of the building is repaired.

The sixth floor is at present the home of Jos. Fahys & Co., Meyer & Weinschenk, W. E. Graves and W. B. Gilbert, but some of the offices have no fittings as yet, and business is being transacted in places easier of access. The seventh floor is occupied by J. A. Young, J. Whitney, Henry Abrams, Burr W. Freer and the Cahn-Standard Optical Co.

The San Francisco office of the Elgin National Watch Co. is at 2421 Fillmore St., but a downtown location will be sought when the large buildings are ready for occupancy.

# JUNE WEDDINGS

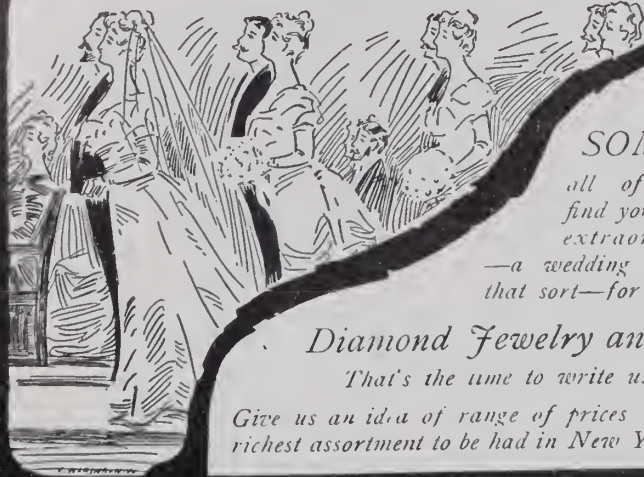

**SOMETIMES,**  
all of a sudden, you  
find you have to meet an  
extraordinary demand  
—a wedding or something of  
that sort—for

*Diamond Jewelry and Diamonds.*

*That's the time to write us!*

*Give us an idea of range of prices and you'll get the  
richest assortment to be had in New York City.*

## CROSS & BEGUELIN

*Importers and Cutters of Diamonds and Precious Stones*

43 Rue de Meslay, PARIS Telephone, 2188 Cortlandt 17 Maiden Lane, NEW YORK



### LATINUM Lined Arch Crown Mountings

(with completed bearings) improve the color of diamonds more than any other lined mounting.

#### TWO REASONS WHY:

1. The bearings and tips are lined, and none of this lining is removed in setting, because no cutting is needed.
2. More light is admitted to the under surface of the stone by the open Arch design.

You will appreciate the exclusive features when you examine the mounting and set up a stone.

If you are not already using the Arch Crown mounting, drop us a postal for a sample, on memo.

### Arch Crown Mfg. Co., 26 Camp Street, Newark, N. J.

SCHRADER WELFSTEIN CO., Chicago  
ELFENSTADT MFG. CO., St. Louis  
CROSS & BEGUELIN, New York

M. SCHUSSLER & CO., Oakland, Cal.  
LEONARD KROWER, New Orleans.  
JOS. NOTERMAN & CO., Cincinnati.  
KOSSUTH MARX JEWELRY CO., New York.

### Newark.

Employees of the New York Standard Watch Co., Jersey City, will give their fourth annual festival next Friday evening in Armbruster's Schützen Park, at Greenville. Arrangements have been made for an elaborate entertainment.

The Matthews Co., 112 Arlington street, was incorporated last week for the purpose of manufacturing silverware, with a capital stock of \$100,000. The incorporators are H. B. Matthews, O. D. M. Jamouneau, Newark, N. J.; W. B. Smith, Edgewater.

Fred T. Long, representing Allsopp & Co., underwent an operation for appendicitis Wednesday, at his home, 190 Elwood street. Dr. Goelet, of New York, performed the operation. Mr. Long is doing as well as could be expected, and his many friends hope for his speedy and complete recovery.

In the Second District Court, Jersey City, a suit was tried last Wednesday which the Puritan Mfg. Co.'s sales of jewelry to retail drug houses were involved. The evidence indicated that in October a representative of the company sold large lots of jewelry to a dozen or more druggists, who were led to believe that the pieces would be quickly sold during the summer. The druggists signed promissory notes, but said that they did not thoroughly understand their nature, and supposed if the jewelry did not prove satisfactory could be returned. The Puritan Mfg. Co. discounted the notes with the Johnson & Co. Bank, which brought the suits against the druggists. Robert Carey was retained to defend all the suits. He charged that the selling company had deceived the druggists. The jury brought in a verdict for the defendants.

### Death of William H. McCausland

PHILIPSBURG, Pa., June 20.—William H. McCausland died at his home in Philipsburg, Pa., Thursday night June 17 of a stroke of paralysis. He was the son of Thomas G. McCausland, of this town, and was years ago prominent in the jewelry trade of this section.

Deceased was born 62 years ago in Mercersburg, and as a boy moved to Philadelphia, where he learned the jewelry trade with William Boadenhamer, and later came into business for himself in that town. He moved to Philipsburg in 1866 and remained here until his death.

Mr. McCausland was a veteran of the Civil War, and had also served in the United States Secret Service. He is survived by four sons and four daughters.

It is very probable that a large delegation of Buffalo (N. Y.) opticians, including practically all members of the Buffalo Optical Society, will attend the convention of the American Association of Opticians, to be held in Rochester, N. Y., July 30. The Buffalo Optical Society has appointed a committee, composed of Roan Williams, Wickens and Joseph Schmidt, to secure attendance from Buffalo to large proportions. Mr. Williams has placed his services at the disposal of the Buffalo delegation in making the trip through the Erie Canal. His proffer may be accepted.

**New York Notes.**

Mrs. Rose Corn, 941 Third Ave., has gone out of business.

Albert H. Gleason, of Hastings & Gleason, attorney for the Jewelers Board of Trade, will sail to-morrow on *La Provence*, intending to pass two months abroad.

Many of the jewelry stores on Fifth Ave. and in some other parts of the city are now on their Summer time schedule, closing their doors at 5 P. M. daily and at noon on Saturday.

Many friends of General Appraiser T. S.cretts, who has had special charge of jewelry cases coming on appeal before the Board of United States General Appraisers, sympathize with him in a severe illness which has confined him for several weeks to his old home in Baltimore, Md.

Among the trophies at the annual mid-summer golf tournament in progress at Monticue City this week is a copper, gold-plated ale mug made by the Gorham Co.

The mug is known as the H. H. Mal-trophy. The N. C. Fownes trophy is a silver loving-cup, gold lined, and of unique design, also made by the Gorham Mfg. Co.

Jewelry and fixtures of Barney Steinfeld, Sixth Ave., who is in bankruptcy, are being sold by James F. Allen, the receiver, according to a notice issued by the receiver's attorneys, Hastings & Gleason. Sealed bids may be received up to July 2, at noon, and the sale will be subject to the approval of the court. The property may be inspected at the premises Friday and Saturday of next week.

Frank Scott, said by the police to be a trunk crook, was held last Wednesday in Jefferson Market Police Court in \$300 bail, charged with stealing several watches and a diamond stud valued in all at \$165, from a Sixth Ave. store. In the same court the same day Max Bellin, who said that he was a waiter, was held in \$500 bail for stealing two tie pins valued at \$30 from the same Sixth Ave. store.

An automobile has been provided by the E. Waterman Co., for W. E. Smith, a New Jersey salesman, in order that he may cover his territory quickly and more economically. It is said that because of the bad roads and other causes, the automobile may be used more profitably in going from town to town in New Jersey than in almost any other part of the country. Presently the machine saves miles of railroad travel and much time by short cuts.

Albert Edward Lee, formerly with Julius Young, San Francisco, who has been conducting the trade on the Pacific coast for a number of years, is now in New York, where he will remain until July 1, arranging for new lines to represent in his territory. Mr. Lee's temporary office in San Francisco at the present time is at 1993 Green St. He says that the trade is picking up in that city much better than was expected, and is extremely optimistic as to conditions in the future.

Besides the reduced rates to New York from points on the Trunk Lines mentioned in the last issue of THE CIRCULAR-WEEKLY, the Merchants' Association of New York has arranged for excursions from other parts of the country. From the territory the Central Passenger Agents' Associa-

tion reduced rates will be effective from July 28 to Aug. 1, inclusive, also from Aug. 18 to 22, inclusive. The rate will be one fare and one-third for a round trip, the return limit on the certificate being 30 days. The association has also been advised that various railroads in Texas have authorized merchants' rates to New York on July 21 to 25, inclusive, and Aug. 4 to 8, inclusive, via the New Orleans gateway. This special fare will also apply from Texas in connection with the water trip from New Orleans over the Southern Pacific passenger steamships.

Jules Franklin, 65 Nassau St., returned last Saturday on the *St. Louis*.

A. Sluizer, with Eduard Van Dam, 27 City Hall Pl., recently resigned, and is now preparing to engage in the diamond business for himself.

Henry Bohm, of the Bohm-Allen Jewelry Co., Denver Col., is in New York making his headquarters with Joseph Frankel's Sons Co., 68 Nassau St.

Leopold H. Herzfelder, with David Mayer, 14 Maiden Lane, will sail Saturday on the *St. Louis* on a five weeks' trip to the diamond markets.

After being with Frederick Kaufman, jobber, at 565 Broadway, for 12 years, Albert Holzinger was recently admitted into partnership, and the firm style is now Frederick Kaufman & Co.

Ashahel Knowlton Eaton, an optician and chemist, died last Thursday at his home in Brooklyn. He was at one time engaged with Charles C. Spencer, of Canastota, in the manufacture of telescopes.

Thomas Kirkpatrick, Fifth Ave. and 33d St., is advertising for a bracelet lost by one of his customers at Coney Island recently. The bracelet is set with one diamond, two emeralds, a topaz, a sapphire and a ruby. A suitable reward will be given to the finder.

An addition to the firm of H. C. Kionka & Bro., precious stone dealers, at 51 Maiden Lane, will be made July 1, when Theodore Wagner, who was for 24 years with F. A. Breidenbach, will be admitted into partnership. The style will be changed to Kionka & Wagner.

Tiffany & Co. last week advertised a reward of \$1,000 for the return of a missing diamond ring. No name was mentioned, but it was learned later that the ring had been found on the lawn of the owner, Mrs. Harry Payne Whitney, near Westbury, L. I., and was returned to her.

A man giving his name as Daniel Tobin, and who said he was a diamond salesman, living at 277 Ave. B, reported to the police of the Tenderloin station last Saturday that diamond pins, brooches and other jewelry to the value of \$1,200 had been stolen from him in Union Sq. Park.

Leon J. Van Gelder, of Van Gelder, Kahn & Co., 170 Broadway, sailed Saturday on the *Finland*, accompanied by his wife and daughter, for a Summer tour to Europe. The trip will be of a social and business character. While abroad Mr. Van Gelder will visit the diamond markets of Antwerp, Amsterdam and Paris.

According to remarks made recently by Magistrate Finn in the Yorkville police court, some of the men who act as professional bondsmen for women of the street also sell jewelry on instalments. It was said that female prisoners are not only

driven into paying high prices for bonds, but also into buying jewelry.

During the convention of the Stationers' and Manufacturers' Association, held in this city last week, the L. E. Waterman Co., 173 Broadway, opened its doors to visitors from all parts of the country. Frank D. Waterman, the president of the company, and the salesmen who had been called in, assisted in entertaining the visitors.

The case of Conrad Schickerling, the president of Schickerling Bros. & Co., the bankrupt jewelry manufacturers, at 21 E. 28th St., who is accused of grand larceny, was called in the Tombs Police Court last Thursday, and was adjourned until July 2 at 2 P. M. The examination of Mr. Schickerling before Referee Pendleton in the bankruptcy proceedings is to begin to-morrow at 2 P. M.

Jos. H. Fink & Co., 65 Nassau St., received a telegram last Saturday from Seattle, Wash., to the effect that Herbert A. Reichman, who travels for the firm in the west, had been robbed of a quantity of diamonds, valued at \$400. A later dispatch says that most of the missing property has been recovered, and that the police have arrested G. M. Meyers, alias Kreber, charged with robbery. Herbert A. Reichman is a brother of Lee Reichman, a member of the firm.

Becker & Co., jewelry importers, at 51 Maiden Lane, will be succeeded, July 1, by Keller, Becker & Co. E. F. Keller, the new active partner, was for 15 years cashier and foreign accountant with Albert Lorseh & Co., and for the last three years has been a silent partner in Becker & Co. Owing to the increasing business of the latter firm, Mr. Keller decided to take an active part in its affairs, and accordingly he resigned his position with Albert Lorseh & Co. As Mr. Keller is slowly recovering from a severe illness, he will pass a couple of months in the Catskills, returning in September.

M. P. & S. Brann, 231½ Eighth Ave., reported to the police recently that on Saturday night, June 9, robbers entered the store and stole diamond jewelry to the value of \$10,000. Mr. Brann said that the men apparently obtained an entrance to an adjoining building, and thence got into a back yard and entered the cellar under the jewelry store. Then they made a hole in the floor, which enabled them to enter the store. Pinkerton's National Detective Agency has sent out a notice, giving a description of the stolen jewelry and announcing a reward of \$1,000 for the conviction of the thief or thieves and the recovery of the property.

A smart colored man, who dresses in style and talks with fluency, is said to have swindled a number of business men on Fulton St. and other parts of Brooklyn by selling them rings set with paste gems which the buyers supposed to be diamonds. The negro's plan is to enter a small store and display a genuine diamond ring which is said to be of considerable value. He says that he is in sad need of ready money, and, therefore, is ready to sacrifice the gem for almost any small amount, such as \$25 or \$30. If the storekeeper decides to buy, the negro cleverly substitutes the imitation diamond ring for the genuine, and later the buyer discovers that he has been deceived.

IN THE HEART OF THE JEWELRY DISTRICT.

# Guardian Trust Company,

170 BROADWAY, COR. MAIDEN LANE, NEW YORK.

Capital and Surplus - Over \$1,000,000

Equitable rates of interest allowed on surplus funds.

Collection of out-of-town items made on reciprocal basis.

FRANK W. WOOLWORTH, President.	LATHROP C. HAYNES, Secretary.	Prominent Jewelers Among our Directors	LUDWIG NISSEN.
GEORGE W. FAIRCHILD, Vice-President.	ALFRED M. BARRETT, Asst. Sec'y.		A. K. SLOAN.
CHARLES L. ROBINSON, Vice-President.			LEOPOLD STERN.

## THE ORIENTAL BANK.

ESTABLISHED 1853.

182 and 184 Broadway, <sup>Corner</sup> JOHN STREET, NEW YORK.

Capital, - - - \$750,000.00.

Surplus and Profits, 1,100,000.00.

*ACCOUNTS FROM THE JEWELRY TRADE ARE SOLICITED.*

R. W. JONES, Jr., President.	LUDWIG NISSEN,	} Vice-Presidents.
NELSON G. AYRES, First Vice-President.	ERSKINE HEWITT,	
GEO. W. ADAMS, Cashier	CHARLES J. DAY,	
R. B. ESTERBROOK, Assistant Cashier.		

## The Market and Fulton National Bank of New York.

ORGANIZED 1852.

81-83 FULTON STREET.

Capital, \$1,000,000.

Surplus, \$1,335,000.

ALEXANDER GILBERT, President.  
R. A. PARKER, - - Vice-President.  
T. J. STEVENS, - - - Cashier.  
JOHN H. CARR, - Asst. Cashier.

**Invites the Accounts of Jewelers.**  
Will extend every facility that good banking will justify.

**SAFE DEPOSIT VAULTS.**

## The Chatham National Bank

Broadway and John Street, New York

H. P. DOREMUS, Cashier

GEORGE M. HARD, President

W. H. STRAWN, Ass't Cashier

## THE STATE BANK

376-378 GRAND STREET, NEW YORK

Capital and Earned Surplus, over \$1,100,000. Deposits over Fourteen Million.

Offers a favorable market for short and long time jewelry and diamond paper

# The Mercantile National Bank of the City of New York

*Cordially invites Accounts  
from Good Merchants  
in the Jewelry Trade.*

**CONVENIENT LOCATION,  
AMPLE CAPITAL,  
LARGE SURPLUS,  
LONG EXPERIENCE.**

FREDERICK B. SCHENCK, *President.*

MILES M. O'BRIEN, }  
WILLIAM H. TAYLOR, } *Vice Presidents.*

JAMES U. LOTT, *Cashier,*  
EMIL KLEIN, *Asst. Cashier,*  
ALFRED W. DAY, *Asst. Cashier.*

<b>Capital,</b>	.	.	.	<b>\$3,000,000</b>
<b>Surplus,</b>	.	.	.	<b>\$3,000,000</b>

*Broadway, Corner of Dey Street,  
New York.*

# Ball's Official Standard R.R. Watches

ESTABLISHED RETAIL PRICES

PROFIT GUARANTEED

When competition grows keen, some jeweler will sell watches at jobber's list—sure as fate.

We originated "established prices for complete watches"—always could and always have maintained them.

Why not take an exclusive agency for the Ball watches?—a fair return on your time and capital guaranteed by our system of established and maintained retail prices.

*Write for booklet, and watch this space.*

We want to add a lot of new friends to the Ball family of railroad watch dealers.

## THE WEBB C. BALL WATCH CO.

CLEVELAND  
Ball Building

CHICAGO  
804-6-8 Railway Exchange

ESTABLISHED 1854.

INCORPORATED 18

JUERGENS & ANDERSEN CO.,  
DIAMONDS,  
MAKERS OF FINE JEWELRY,  
92 TO 98 STATE STREET,  
CHICAGO.

23-25 Looljersgracht, Amsterdam, Holland.

# THE HERMAN KECK MFG. CO.

## CUTTERS OF

# DIAMONDS.

### FOR SALE.

A complete diamond cutting outfit of twenty benches, European make, consisting of sawing machines, rounding machines, laps, tongues, dops, scouring stands, etc., all in first class condition. Will sell cheap, if sold in bulk at once, as we have replaced them with American tools.

MANUFACTURING JEWELERS, SILVERSMITHS  
Recutting and Repairing of Diamonds.

17-19-21-23 West Fourth St.  
CINCINNATI, O.

RUDOLPH NOEL

RUDOLPH NOEL & CO.

IMPORTERS OF

# DIAMONDS

2 Tulp Straat, AMSTERDAM

Phone 1902 John

37-39 Malden Lane, NEW YORK





# WESTERN DEPARTMENT

Western Office:  
204 COLUMBUS MEMORIAL BUILDING,  
CHICAGO.

Telephone:  
4079 CENTRAL,  
CHICAGO.

V. LII.

CHICAGO, WEDNESDAY, JUNE 27, 1906.

No. 21.

## Chicago Notes.

Charles A. Garlick is in New York.  
Charles Kolb is on a trip through Wisconsin.  
Robert Kehl, with F. H. Noble & Co., is on a western trip.  
T. E. Smith, with Reed & Barton, is on a vacation at Atlantic City.  
Fred H. Carpenter, with the W. & S. Brinton Co., is here from the coast.  
E. Gepp, watchmaker for the Jeffery Jewelry Co., has accepted a position in Laque, Ia.  
John A. Rimkus, 4644 S. Ashland Ave., announces his intention of sailing for Europe in July.  
"Black" Ryan, with the Stein & Ellbogen Co., is taking a vacation at his native town, Zanesville, O.  
Mr. Wietz, jewelry buyer for the Marshall Field Co., has returned from a lengthy European trip.  
Maximilian Ellbogen, of the Stein & Ellbogen Co., arrived from Europe last week on the *St. Louis*.  
Max Noel, of Despres, Bridges & Noel, is to be married to-day in New York to Miss Ellen Kaufman.  
W. J. Willer with William A. Rogers, Ill., was recently married at Quincy, Ill., to Miss Edith Bernbrock.  
Zuri Lederer, of the S. & B. Lederer Co., passed through Chicago last week on his way home from the coast.  
Gene Goldsoll, daughter of L. C. Goldsoll, is to be married to-day to L. L. Sachs, proprietor of "Lucios," 213 State St.  
Robert W. Barlow, with C. H. Knights & Co., is spending his vacation with his wife and daughter, near Biddeford, Me.  
W. Nichols is an enthusiastic fisherman, 35 pounds of black bass taken from Lake being his record last Saturday.  
After a successful career of over 32 years in the retail jewelry trade N. V. Cole, Chicagoan City, Ind., has retired from business.  
A. Chouffet, with Heintz Bros., of Buffalo, has added Illinois to his territory.  
Max Gunzburger is no longer with Heintz Bros.  
Dave Marshall, of the Fleissner-Marshall Co., San Francisco, Cal., was here last week. The concern now handles men's finishing goods.

Fred A. Ferdinandsen, for nearly seven years with the L. Manasse Co., has opened an optical business at room 602, Columbus Memorial building.

Mr. Schramm, Pacific coast salesman for the Stein & Ellbogen Co., was operated upon last week. He has been suffering with severe neck boils.

The Capital Jewelry Co., consisting of Victor and I. S. Schoenfield, have removed from 41 Maiden Lane, N. Y., to room 74, 163 E. Randolph St., this city.

Richard O. Kandler, accompanied by his wife and two children, sailed for Europe Thursday on the *Kaiserin Auguste Victoria*. They will return about Sept. 1.

All members of Sproehne & Co.'s road force are in from their respective territories. They are P. H. Winterberg, C. L. Caliger, J. H. Donnelly and A. Ellbogen.

W. K. Sandbery, president-elect of the Mazdaznan Temple Association, delivered an address before that society last Friday. The subject was "The God of the Living."

Walter King, of the Julius King Optical Co., was here all of last week. Mr. King was the guest of Mr. and Mrs. J. T. Brayton at their Summer cottage at Burlington, Wis.

All members of L. H. Schafer & Co.'s road force, which includes E. A. Kelly, of the firm, and G. P. Robinson, F. C. Strang, Sam Amberg, J. L. Holland and A. Elsner, are at home.

R. L. Clark, O. F. Samuelson, C. F. Haber, A. L. Fuller and E. R. Lusk, of the western traveling force of the Towle Mfg. Co., are on a 10 days' visit to the factory at Newburyport, Mass.

William Dorer, Jr., son of William Dorer, Bellaire, O., and a recent graduate in optics, has taken charge of the optical department of the Victor Jewelry Co.'s new store, 66 State St.

Creditors of Charles A. Port, Portage, Wis., have received a first and final dividend of 76 1-10 per cent. Port mysteriously disappeared. All his creditors would be willing to start him in business again.

Mrs. Mills, formerly jewelry buyer for Hale Bros.' department store, San Francisco, was here last week looking over the market. If conditions are favorable Mrs. Mills will open a jewelry store on her own account in San Francisco.

H. L. Whitmore, formerly at 556 W.

Madison St., has removed to the large double store at 550 in the same street, which was formerly occupied by W. T. Austin. Mr. Whitmore is well pleased with his new store, and reports business as good.

Ed. Alberti, retail jeweler, at 900 Milwaukee Ave., will sail for Europe July 10, accompanied by his wife, on the *Kaiser Wilhelm der Grosse*, and will be absent four months. Ed. Alberti, Jr., will manage the business during the absence of his father, assisted by Alvin Alberti, his brother, who recently graduated from the law school of the University of Michigan.

Sproehne & Co. have purchased a gasoline runabout for the use of their city salesman, Homer Bouchard. This is the first automobile to be used in this manner in the Chicago trade, and it is claimed that the rapidity with which customers can be visited more than pays for the expense attached to running it. Three other representatives of Chicago jobbers visit their trade in horse-drawn buggies.

The Sears-Roebuck Co. has been capitalized at \$40,000,000, of which \$10,000,000 is preferred stock and \$30,000,000 common stock. With every 100 shares of preferred stock there was given 50 shares of common stock. Last year's business totaled \$38,000,000, and there was a net profit of \$2,800,000. The preferred shares carry a guarantee of 7 per cent. dividend. Of the profits \$900,000 must be set aside as a surplus fund before anything can be paid on the common shares. If the sales reach \$50,000,000 it is figured that the common stock will pay 6 per cent.

Paul Lackritz, president of the Retail Jewelers Association of Cook Co., will address the Rochester convention. Very many prominent jewelers have signified their intention to go if they can spare the time. A. W. Johanson, Olaf Pearson, B. T. Hoffman, William Lambrecht and W. D. Turner will also go. All of the above, together with many more Chicago jewelers, will go to Springfield to attend the meeting of the Illinois Retail Jewelers' Association, which takes place July 9. From advance information in regard to the question to be discussed the meeting promises to be an interesting one. All Illinois jewelers who can spare the time should attend this meeting. The president, Stanley M. Strain, Nokomis, Ill., or Herman Charles

# To the Jobbing Trade.



## HOW WE SELL Diamond Bunch Rings.

Diamonds at importers' prices,  
Mountings at our usual prices.

Staple Diamond Mountings of  
Every Description

**IMPORTERS**

**SHIMAN BROS & CO.**

87 MAIDEN LANE, N. Y.

LONDON: 50 HOLBORN VIADUCT.  
AMSTERDAM: 2 TULP STRAAT.

**MANUFACTURERS**

FACTORY,  
1, 3, 5 GOLD STREET.

Watts, the secretary, Forrest, Ill., in correspondence from all Illinois jewelers who intend going.

A. Hess, retail jeweler, 84 W. Madison St., sails for Europe to-day on the *Neddaam*. He will be gone three months, will visit Germany and Switzerland.

Fifty members of the Texas Business Men's Association were here three or four last week. They spent an afternoon at the Elgin National Watch Co.'s plant at Elgin, Ill.

Among the retail jewelers who visited Chicago last week were: Fred Overstreet, Paxton, Ill., accompanied by his son Gordon; Harry Greenblatt, of Harry Greenblatt & Co., Omaha, Nebr.; Charles Hess, Blunt, S. Dak.; Frank Le Bron, Frank, Ia.; Perry Jackson, St. Charles, Mo.; Will Chapman, Benton Harbor, Mich.; I. Orr, Rochester, Minn.; A. H. Mark, of St. Louis Clock & Silverware Co., St. Louis, Mo.; A. J. Glaser, Spring Valley, Ill.; H. E. Baughman, of Baughman & Kinsinger, Roswell, N. M.; Henry J. Linton, Ind.

### Minneapolis and St. Paul

W. L. Pettit, of W. L. Pettit & Son, Minneapolis, has been ill for several weeks.

Richard Watson, an aged watchmaker and jeweler at Fifth Ave., S., and 6th St., Minneapolis, died last week of old age, was about 82 years of age.

O. F. Rohwedder has sold his business at Sherburne, Minn., and has begun an engraving business for the trade in Minneapolis, at 1115 Lumber Exchange.

J. B. Hudson & Son have incorporated and admitted W. A. Lawhead as a partner. Mr. Lawhead has been associated with concern in Minneapolis for several years.

John B. Bodfors, Minneapolis, has offered an elaborate silver cup for the best collection of roses presented to the forthcoming meeting of the Minnesota Rose Society.

The E. A. Brown Co., 110 E. 6th St., St. Paul, is preparing to move into new, larger quarters a few doors above its present location, near the corner of Minnesota St., where a room 40x80 feet in size will be fitted up. The change will be completed about Sept. 1.

The fire in the Ryan annex, St. Paul, damaged a number of jewelry houses. Lewis Finkelstein, wholesaler, estimates his loss at \$20,000, the insurance aggregate at \$24,000. He has secured new quarters at 521-537 Endicott building, and will fill orders from a new stock. C. F. Yarr, manufacturing jeweler, located on the 11th floor, estimates his loss at \$200, with insurance of \$1,000. W. E. Mowrey, watchmaker for the trade, and goldsmith and engraver, sustained a loss of \$800, insurance amounting to \$1,100. George W. Wood, manufacturer and engraver, had a loss of about \$300, and carried insurance to the amount of \$3,500. Sisco & Beard's estimate of loss on their wholesale manufacturing stock is \$15,000, but this may be cut materially, as their apartments were on the side which escaped the fire. Their insurance is \$44,500. Thomas A. Shirley, manufacturing jeweler, had a loss of \$700, insurance of \$1,500.

L. L. Hinkley, Lake City, Ia., has given bill of sale for \$1,000.

**Kansas City.**

Ward & Crellin Jewelry Co. has secured the agency for the Dueber Watch Co.

L. Turley, Centralia, Mo., is now a student with the Kansas City Polytechnic Institute.

F. Fasammyer has taken a position as watchmaker with Frank Garnier, Kansas City.

Montague, traveling for H. F. Hahn, who makes his home here, is in for a summer vacation.

M. Scott, of the Woodstock-Hoefler Watch & Jewelry Co., has just returned from a trip to New York.

H. Snow, traveler for the Woodstock-Hoefler Watch & Jewelry Co., will start on the road next week.

Meyer, president of the Meyer Jewelry Co., spent several days at Excelsior Springs last week, owing to ill health.

N. Murehison, Cheyenne, Wyo., returned to this city last week, and became a student at the Southwestern Optical College.

H. Hassig & Krieke Jewelry Co. and Meyer Jewelry Co. have both decided to give a Saturday half-holiday during the summer months.

George Edwards, of the Edwards & Sloane Jewelry Co., has gone to Alma, Kans., with his boys, who will spend their vacation on a trip near that point.

Ms. Charles Harsch, wife of the manager of the jewelry store of Oppenstein Bros., in this city, left last week for a visit to her mother in Seymour, Ind.

Ms. James, who has been a pawnbroker in this city for a number of years, has been invited to the bar, and will discontinue his pawnbroking business.

Ms. C. C. Hoefler, wife of C. C. Hoefler, of the Woodstock-Hoefler Watch & Jewelry Co. and daughter, have just returned from a three weeks' visit in the east.

Mr. Ludwig, manager of the material department of the Edwards & Sloane Jewelry Co. has just returned from a combined business and pleasure trip to eastern points.

Ms. Burkland, with the Meyer Jewelry Co. was the victim of a hold-up at Swope Park recently. He received a flesh wound on his hand from a revolver shot, and lost \$100 in cash.

P. Kionka, of Kionka & Kionka, has just returned from a three months' trip. He started in the south, and went north as far as Wisconsin. He will be in the house again after July 4.

Ms. Potts, a well-known jewelry auctioneer of this city, has taken a position as traveling salesman with the Edwards & Sloane Jewelry Co., and will cover a territory in northern Missouri and Iowa.

Ms. Potts, a well-known jewelry auctioneer of this city, has taken a position as traveling salesman with the Edwards & Sloane Jewelry Co., and will cover a territory in northern Missouri and Iowa.

Ms. Potts, a well-known jewelry auctioneer of this city, has taken a position as traveling salesman with the Edwards & Sloane Jewelry Co., and will cover a territory in northern Missouri and Iowa.

Ms. Potts, a well-known jewelry auctioneer of this city, has taken a position as traveling salesman with the Edwards & Sloane Jewelry Co., and will cover a territory in northern Missouri and Iowa.

Ms. Potts, a well-known jewelry auctioneer of this city, has taken a position as traveling salesman with the Edwards & Sloane Jewelry Co., and will cover a territory in northern Missouri and Iowa.

Ms. Potts, a well-known jewelry auctioneer of this city, has taken a position as traveling salesman with the Edwards & Sloane Jewelry Co., and will cover a territory in northern Missouri and Iowa.

Ms. Potts, a well-known jewelry auctioneer of this city, has taken a position as traveling salesman with the Edwards & Sloane Jewelry Co., and will cover a territory in northern Missouri and Iowa.

Ms. Potts, a well-known jewelry auctioneer of this city, has taken a position as traveling salesman with the Edwards & Sloane Jewelry Co., and will cover a territory in northern Missouri and Iowa.

Ms. Potts, a well-known jewelry auctioneer of this city, has taken a position as traveling salesman with the Edwards & Sloane Jewelry Co., and will cover a territory in northern Missouri and Iowa.

Ms. Potts, a well-known jewelry auctioneer of this city, has taken a position as traveling salesman with the Edwards & Sloane Jewelry Co., and will cover a territory in northern Missouri and Iowa.

Ms. Potts, a well-known jewelry auctioneer of this city, has taken a position as traveling salesman with the Edwards & Sloane Jewelry Co., and will cover a territory in northern Missouri and Iowa.

Merry, of the C. L. Merry Optical Co., the other night, and the following articles were among the loot: Lady's watch, engraved L. C. M.; lapel watch; lady's watch chain; bonbon box, engraved L. C. M.; lady's bracelet, set with amethysts; locket, engraved L. C. M.; belt buckle; pearl stick-pin; Smith & Wesson 38-calibre revolver, and \$23 in cash.

Tom L. Davies, of Davies & Owen, Falls City, Nebr., was here last week. He began a course in watchmaking at the Kansas City Polytechnic Institute, where he finished a course in engraving some time ago. He has also begun a course at the Southwestern Optical College. He says that his firm is doing a good business, and that the store in Auburn is to be discontinued and the stock consolidated with that in Falls City.

The following out-of-town jewelers were in this market during the past week: E. R. Moses, of the Moses Mercantile Co., Great Bend, Kans.; S. J. Huey, Excelsior Springs, Mo.; J. H. Whiteside, Liberty, Mo.; Otto Burkland, Osawatomic, Kans.; A. D. Ackerman, Fairbury, Nebr.; Roy Smithers, Cameron, Mo.; W. F. Kirkpatrick, St. Joseph, Mo.; F. W. Galer, Nowata, Ind. 1.; J. M. Coffman, Salisbury, Mo.; C. J. Keil, Clinton, Mo.; E. T. Merriman, Guide Rock, Nebr.; Ed Armel, of Armel Bros., Holton, Kans.; Harry Kelly, Erie, Kans.; Isador Eller, Richmond, Mo.

**St. Louis.**

A. H. Aylesworth, Chicago, president of J. F. Dailey & Co., paid a visit to the store of that firm here, last week.

C. S. Ahle, of the Whelan-Aehle-Hutchinson Jewelry Co., is on a two weeks' fishing trip on the Gascogne River.

Moses Strauss, veteran salesman with the L. Bauman Jewelry Co., made a short trip into southeast Missouri last week.

Sam H. Bauman, president of the Bauman-Massa Jewelry Co., will sail to-day from Europe for New York on the *Kaiser Wilhelm*.

M. Schinderman, of the L. Bauman Jewelry Co., has gone to Chicago to meet his brother and sister, who have just come from Europe.

Edwin Blosser, for 13 years with J. W. Cary & Co., is now connected with the Reeves Co., the new material house in the Star building.

Charles Ens, 2330 Montgomery St., manager for William Weidlich & Bro., is a father now, a son having been born to Mrs. Ens last week.

J. W. Cary, of J. W. Cary & Co., has gone to Harbor Beach, Mich., where he has a Summer home, to spend the remainder of the heated term.

Meyer Bauman, of the L. Bauman Jewelry Co., with Mrs. Bauman and Miss Bauman, have gone to French Lick Springs, Ind., for a visit of 10 days.

The visiting jewelers here last week were: J. Harvell, Litchfield, Ill.; J. F. Stewart, Albion, Ill.; W. S. Guthrie, Terrell, Tex.; Philip Levy, Henderson, Ky.

L. J. Wick and family, Highland, Ill., were in St. Louis on their way to Iowa last week for an extensive trip made in the interest of Mr. Wick's health.

Goodman King, president of the Mer-

mod, Jaccard & King Jewelry Co., has just returned from his annual Spring buying trip to Europe. He visited Amsterdam, Berlin and Paris.

T. A. Nelsch, 1125 N. Vandeventer Ave., reported to the police Friday that some time Thursday night his place of business was entered and a gold ring and watch valued at \$75 were taken.

Herman Mauch, 507 Franklin Ave., president of the Retail Jewelers' Association of Missouri, spent the latter part of the week on a fishing trip with a party of friends at the Montezuma Hunting and Fishing Club.

L. W. Waldecker, manager of the silverware department of the F. W. Drosten Jewelry Co., goes east next week on a trip which will combine business and pleasure. He will visit New York, Providence, Attleboro and other points.

The Whelan-Aehle-Hutchinson Jewelry Co. is now closing its store at 1 o'clock on Saturdays, and 5 o'clock on week days in the Summer months. The Mermod, Jaccard & King Jewelry Co. begins the early Saturday closing June 30.

F. K. Hatch, of the Mermod, Jaccard & King Jewelry Co., goes July 1 on an extended vacation trip. Lee Schum, Walter Lauman, Jos. Rogers and Henry Eckerman, of this firm, made a week-end fishing trip to Stone-wall, Ark., and made quite a record, bringing back 140 fish.

William Weidlich and E. C. Weidlich, of William Weidlich & Bro., and Frank Weidlich, 1022 Hodiadmont Ave., were called to Bridgeport, Conn., last week, by the death of their brother, C. E. Weidlich, treasurer of the Weidlich Bros. Mfg. Co., of that place. Mr. Weidlich was killed in a street car accident, the coach having jumped the track and mangled him in a frightful manner, causing instant death.

**Columbus, O.**

Frank Bonnet and family will go to his Summer cottage at Columbus Beach, Mich., next Sunday. Mr. Bonnet will remain but a week or so, while his family will remain all Summer.

Davidson Bros., who recently bought out the business of T. J. O'Daniels, reported to the police Thursday that a red-headed man with one eye had beaten them out of a glass eye. The man took the eye and promised to pay, but never did so.

A Chicago publishing house with whom the convention committee of the Columbus Board of Trade is co-operating, is back of a movement to organize a State association of jewelers in Ohio, and a meeting has been called, to be held in Columbus, July 17. It is proposed to effect a permanent organization and elect delegates to the national meeting to be held at Rochester later in the Summer.

The Eagle Loan Co., Arkansas City, Kans., is moving to a new location further downtown, next door to the jewelry store of Ralph Wickliffe.

About two weeks ago a severe rainstorm visited Marion, Kans., and the stores of Butcher & Butcher and E. F. Sheldon were both flooded to a depth of two feet. Owing, however, to the fact that they had received warning of the flood their losses were slight.

## Cincinnati.

A. M. Plant, Arcade, has greatly improved his store by adding new wall cases.

J. Becker, formerly with the Philadelphia Watch Case Co., is back from a visit in Missouri.

A. W. Wahl, watchmaker for George Newstedt, is making an extended stay at the lakes.

The Gustave Fox Co. has secured the contract for all the gold badges of the Order of Owls.

Mr. and Mrs. Albert Sauer, Newport, Ky., are home from a trip to New York and Washington.

Edward Mittendorf, manager for E. & J. Swigert, with his wife, recently toured the eastern cities.

Henry Fox and I. N. Fox, of Fox Bros. & Co., after several weeks at Mt. Clemens, Mich., are home again.

A. J. Thoma, of Thoma Bros., with his wife, has returned from New York and gone to Bowling Green, Ky.

Will Irion and bride, Louisville, Ky., passed through this city last week en route to Niagara Falls and Buffalo.

Herman Keck, of the Herman Keck Mfg. Co., has returned from a long visit to European diamond markets.

E. & J. Swigert have purchased the stock of Joseph Hornback, who recently discontinued his material business in this city.

J. B. Osthoff, of Joseph Noterman & Co., will leave June 29 for Hendersonville, N. C., where he will spend July and August.

Jacob Frohman, of Frohman & Co., and D. Gradison, 29 Emery Arcade, are both again at business after a stay at French Lick Springs.

Ben Kruckemeyer, of Kruckemeyer & Cohn, Evansville, Ind., with his bride, passed through here last week en route to Dawson, Ky.

The daughter of Andrew Alich was recently married to Mr. Toohey, Walnut Hills. The couple have gone to the lakes on their honeymoon.

S. Lindenberg, of Lindenberg, Strauss & Co., is again at his desk, after a rest at Atlantic City. Sig Strauss, of this firm, is on a business trip north.

The marriage of Miss Emma Cannon, with Herman E. Promnitz, to Percy Brunner, of Joseph Noterman & Co., is announced to take place to-day.

The Miller Jewelry Co. was awarded the contract for the 75 gold and silver medals given at the open athletic meet of the Cincinnati Gymnasium held at the East End athletic grounds Saturday.

A. Herman, of Herman & Loeb, left Europe yesterday on the *Kaiser Wilhelm II* for home. Clarence Loeb, of this house, was presented last week with a beautiful silver loving cup by his friends in honor of his 21st birthday.

The marriage of Miss Lillian Fox, daughter of Henry Fox, of Fox Bros. & Co., and Sol Wetzstein, of Cincinnati, which took place Monday, was a most brilliant event. Mr. and Mrs. Wetzstein are spending their honeymoon in the east.

Out-of-town dealers who were here during the past week buying stock included: Frank Carey, Lebanon, O.; Charles Schamber, of Meyer & Schamber, Meridian, Miss.; Burgess Bros., Florala, Ala.; F. J. H. Schell, Xenia, O.; J. N. Embrey, North Lewisburg, O.; D. A. Sewall, Wilmington, O.; J. E. Zimmerman, New Holland, O.

The marriage of Otto Mehmert, son of Joseph Mehmert, and Miss Katherine Fisher took place Thursday morning in St. Henry's Church. On the following evening a reception was held in West Turner Hall, which was attended by about 300 guests. The gifts to the bride and groom were numerous and valuable. Out-of-town guests included Henry Mehmert, an uncle of the groom, a jeweler at Olney, Ill., and his wife, and Vol Lloyd, of St. Louis, Mo. The Cincinnati trade was largely represented. The bride and groom have left for Atlantic City.

## Pacific Northwest.

A. E. Shirley has rented the office vacated by Guerin Bros., Myrtle Point, Ore., and will soon open a store with a complete line of jewelry.

W. L. Coppernoll, with J. O. Watts, Eugene, Ore., has gone to Illinois to attend the funeral of his father, who died at Warren, aged 73 years.

Joseph Mayer & Bros., Seattle, Wash., designed and made the handsome gold medal which the business and professional men of Seattle, Wash., have presented to Chief of Police Wappenstein as a mark of appreciation of his well-directed efforts to make Seattle a better and a cleaner town.

## Indianapolis.

Gale Burlingame, jeweler and engraver for J. H. Reed, is spending two weeks in northern Michigan.

David S. Gribben, of Gray, Gribben & Gray, is now in Switzerland. He will turn from abroad, with his family, in Fall.

Horace A. Comstock, as an officer of the Indianapolis Gun Club, was prominent in the annual meeting of the Great American Handicap, held here last week.

Local jewelers have received announcements of the opening of Martin & Co.'s store, at Evansville. Sol Martin, Jr., manager.

S. W. Thompson, Sr., Monticello, is making arrangements to move into more commodious quarters.

Among the out-of-town jewelers who visited the local jobbers and manufacturers last week, were: Sol Pennington, King town; J. A. Meissen, Cicero; D. S. W. taker, Lebanon; J. A. Pickett, New Cass; H. Wheeler, Dana; J. F. Harding, Brownburg, and Aaron Pursel, Noblesville.

Local jewelers rejoice that the new trade's Gold and Silver Stamping bill will become a law. They give unstinted praise to THE CIRCULAR-WEEKLY for inaugurating the movement in favor of the bill and urging its passage by Congress. Merchants here believe that the law will safeguard interests of legitimate jewelers and manufacturers everywhere.

Local detectives have established the fact that William Dawson, of Brooklyn, whose skeleton was found recently, had been murdered. The skull is crushed and the authorities say that the man was killed by a blow on the head. He owned considerable property and was considered wealthy. One morning he did not appear at his store. Search was made, but his whereabouts were never discovered until the recent find.



# A. C. BARD & CO.

IMPORTERS AND  
CUTTERS OF

## DIAMONDS

Loose or mounted goods on memo. to responsible dealers.

103 STATE ST., CHICAGO. COLUMBUS MEMORIAL BUILDING.

# JOS. NOTERMAN & CO. DIAMONDS

IMPORTERS AND CUTTERS

Recutting and Repairing odd shaped and chipped stones a specialty. Manufacturers of Mountings and Fine Jewelry. Special Designs Furnished.

CINCINNATI, OHIO.

INDEX TO ADVERTISEMENTS.

Asis & Singleton	28	Fox, Gustave, Co.	19	Nonnenmann, A., & J. Aschenbrenner	104
At, Lambert & Co.	103	Freund, Henry, & Bro.	25	Noterman, Jos., & Co.	68
Atpp & Adsoop	23	Friedlander, R. L. & M.	17, Outside back cover	Novelty Engineering Ass'n	96
Atpp Bros.	16	Garraud & Griser	24	Ohan, G.	102
At Mfg. Co.	Inside front cover	Gesswein, F. W., Co.	96	Oppenheimer Bros. & Veith	38
Atlund, H. E., & Co.	28	Goldsmith, C. P., & Co.	29	Oppenheimer, H. E., & Co.	38
American Gem & Pearl Co.	50	Goldsmith, Leo	48	Oriental Bank	58
American Platinum Works	104	Goodfriend Bros.	44	Osmun Parker Mfg. Co.	20
American Silver Co.	31	Gorham Mfg. Co.	54	Ostby & Barton Co.	18
American Waltham Watch Co.	80	Gougelman, Paul	98	Patek, Philippe & Co.	87
At Crown Mfg. Co.	56	Griffoul, August	96	Penfold, Wm. C., Co.	80
Atlein Bros. & Co.	Outside back cover	Guardian Trust Co.	58	Potter & Bullington Co.	14
Atn, John, & Son	Outside back cover	Hagstoz, T. B., Ltd.	104	Power, Chas. L., & Co.	44
At Turquoise Co.	50	Harris & Harrington	Outside back cover	Powers & Mayer	13
At Peine & Co.	46	Hedges, A. J., & Co.	20	Prior, Charles M.	22
At Webb C. Watch Co.	60	Hedges, Wm. S., & Co.	44	Prybil, P.	103
At Geo. M.	Outside back cover	Helutz Bros.	23	Rachne, Jules	86
At A. C., & Co.	68	Heller, L., & Son	40	Reichhelm, E. P., & Co.	96
Atkopf, Jacob	87	Herpers Bros.	104	Renzihausen, W. F., Co.	104
Ats & Bacon	12	Hleshberg, A. S.	31	Revell, A. H., & Co.	Outside back cover
Atnear, H., & Co.	98	Hodenypl & Walker	40	Rles & Armstrong	103
At J. & H.	96	Hoe's Sons, James C.	102	Rockford Watch Co.	90
Atke & Eckert Co.	53	Hotel, St. James	20	Roger Williams Silver Co.	25
Atky, S. O., & Co.	4	Howard, E., Clock Co.	87	Roseman, A.	48
Atlags, Chester, & Son	42	Hraba, Louis W.	98	Rosefeld, Wm. I.	50
Atop, R. W.	24	Humphrey, John B.	52	Roy Watch Case Co.	88
Atkinton, R., & Co.	28	Hutchison & Huestls	29	Rudolph & Snedeker	87
Atkinton, W. & S., Co.	15	Illinois Watch Co.	8	Rumpp, C. F., & Sons	102
Atcard & Co.	90	International Silver Co.	36	Saart, W. H., Co.	74
At E. Edward	98	Irons & Russell	76	Salman, J. A., & Co.	74
Atelli & Vitelli	44	Jacot Music Box Co.	98	Saunders, Meurer & Co.	44
Aton Jewelry Co.	26	Jeandheur, F., Jr.	104	Schiff, M.	23
Atlen, J. B., & Co.	16	Jeanue, Frederick A.	46	Schultz, Leiss & Co.	18
Atley Polytechnic Institute	53	Johnston, W. J., Co.	10, 11	Sessions Clock Co.	89
Atner, R.	31	Juergens & Andersen Co.	60	Shafer & Douglas	31
Atver, Maurice	53	Juergens, Jules	87	Shiman Bros. & Co.	66
At J. Bros. & Henlus Co.	Outside back cover	Kahn, L. & M., & Co.	Outside back cover	Siegel, Rothschild & Co.	100
Atley, Sam'l. & Co.	22	Keck, Herman, Mfg. Co.	60	Smith, Alfred H., & Co.	38
Atde & Uymeyer Co.	52	Kent & Woodland	21	Smith, E. H. H., Silver Co.	100
Atone, Geo. H., Co.	26	Ketcham & McDougall	102	Smith, Wm. & Co.	72
Atington & Co.	20	Klipper Bros.	90	Snow & Westcott	22
Atler, Howe & Co.	21	Kohlbusch, Herman, Sr.	104	Sohn & Hyman	53
Atiglioni & Capaldi Co.	72	Kohn, Alois, & Co.	23	Solidarity Watch Case Co.	24
Attham National Bank	58	Kohu & Co.	25	Spencer, E. L., Co.	27
Atpard Frères	52	Koshland & Italle Co.	30	State Bank	58
Atley & Straight	104	Kremetz & Co.	23	Steiner, Louis	100
Atper Diamond Co.	42	Lackner & Ohl	98	Stern Bros. & Co.	48, Inside back cover
Atper & Forman	76	Langendorf Watch Co.	88	Sternau, S., & Co.	12
Atle, S., Co.	22	Larter & Sons	34	Stiven, John S.	104
Atn, M.	31	Lederer, S. & B., Co.	27, 28	St. Louis Silver Co.	53
Ats & Beguelin	24, 56	Leimann Bros.	96	Strauss, Ignaz, & Co.	Outside back cover
Atssman, Chas. S., & Co.	48	Lelong, L., & Bro.	Outside back cover	Strauss, Jacob, & Sons	48
Atssman Co.	46	Levy, Robt.	19	Street, Geo. O., & Sons	16
Atuch & Fitzgerald	29	Lewy & Cohen	100	Tavannes Watch Co.	76
Atelbaum & Friedman	72	Lissauer & Co.	40	Thomas, Seth, Clock Co.	83
Atl, Clark & Co.	21	Loeb, Wm., & Co.	28	Tivoli Art Glass Co.	72
Atcon, Louis J.	76	Lorsch, Albert, & Co.	Outside back cover	Trenton Watch Co.	86
Atlerick's Sons, James H.	104	Loth, Joseph, & Co.	98	Trout, Charles L., & Co.	20
Atasse Mfg. Co.	20	Low, Martin, & Taussig	40	T. S. Electro-Chemical Co.	96
At Selms Watch School	24	Lowe, Edwin, & Co., Inc.	26	Van Dam, Eduard	42
Atmond Point Pen Co.	102	Luthy & Hine	22	Wadsworth Watch Case Co.	6, 7
Atsheim, Hipp., & Bro.	88	Lyons Gem Co.	76	Wagner Mfg. Co.	24
Atnelly, J. J.	104	Mackey Jewelry Co.	26	Waite-Thresher Co.	27
Atfinger, C., & Sons	98	Maeber & Reiss	104	Washburn, C. Irving	30
Atk, Robt.	16	Maple City Glass Co.	98	Wells, Chester H.	30
Atbar, Leach, Garner Co.	96	Market & Fulton National Bank	58	Wendell & Co.	5
Atand & Co.	20	Mendes Cutting Factories	90	Western Clock Mfg. Co.	29
Atnberg & Co.	48	Mercantile National Bank	59	Wheeler, Hayden W., & Co.	38
Atin National Watch Co.	82	Meriden Britannia Co.	36	Whiteside & Blank	21
Atssof Bros. & Co.	102	Meyerowitz Bros.	52	Whiting & Davis	14
At P. H. Chain Catch	30	Miller, Fuller & Whiting	74	Whiting Mfg. Co.	9
Atys, Joseph, & Co.	1	Moore & Sons	16	Wightman & Hough Co.	26
Atrehild & Co.	102	Mount & Woodhull	46	Witsenhausen, L.	100
Atre-Jacot, Georges, & Co.	87	Myers, S. F., Co.	28	Wittnauer, A., Co.	87
Atrey, W. J., Co.	22	Newburgh, R.	90	Wodiska, Julius	30
Atman Co.	103	New England Watch Co.	84	Wolfsheim & Sachs	103
Atsinger, J. W.	89	New York Telephone Co.	103	Wood, C. F., & Co.	Outside back cover
Atter, Theodore W., & Bro. Co.	32	Noel, Rudolph, & Co.	60	Wood, J. R., & Sons	2, 3
AtTrack News	86				

## Special Notices.

Payable invariably in advance.

Rates 75c. per insertion for notices not exceeding 25 words; additional words, 2c. each.

SITUATIONS WANTED, 1c. a word each insertion; minimum charge, 25c.

Heavy type, 5c. a word; minimum charge, \$1.25. Display cards, \$2.00 per inch.

In all cases, if answers are to be forwarded, 10c. extra to cover postage must be enclosed.

*All answers to advertisements addressed care The Jewelers' Circular-Weekly, should be sent to the New York Office, unless the Chicago Office is specifically mentioned.*

## Situations Wanted.

SITUATION WANTED by watchmaker, engraver and salesman; A1 reference; fine tools; age 29. Geo. N. Wood, Decatur, Ill.

YOUNG MAN, 23 years, wishes position as salesman or to work inside in wholesale house. "I., 6741," care Jewelers' Circular-Weekly.

WANTED, POSITION as salesman, optician and assistant watchmaker; can do lens grinding; married. Address "Optician," 14 Church St., Hartford, Conn.

FIRST CLASS watchmaker, jeweler and fair engraver; all tools; no bad habits; industrious; go to any State. Conrad Kohler, 722 Kanahwa St., Charleston, W. Va.

WANTED, A POSITION as engraver, book-keeper, cashier and saleslady; good references; terms reasonable. Address "Enquirer, 5877," care Jewelers' Circular-Weekly.

YOUNG MAN (23) wishes position in jewelry house or store, three years' experience; A1 reference. New York preferred. "Jewelry, 6723," care Jewelers' Circular-Weekly.

SALESMAN, with eight years' experience, selling department and jewelry stores in east and middle west, is open for a position. "Successful, 6659," care Jewelers' Circular-Weekly.

YOUNG MAN (18) desires position as shipping or stock clerk, three years' experience in watch business; first class references furnished. "Stock, 6730," care Jewelers' Circular-Weekly.

FIRST CLASS OPTICIAN and good watchmaker of thorough experience; sober and reliable, age 27, desires position at once, reference from last employer. H. N. Fegley, Sunbury, Pa.

BY FIRST CLASS manufacturing jeweler and diamond setter; 18 years' experience; have had charge of shop for last six years. Address "A. B., 6692," care Jewelers' Circular-Weekly.

A STRICTLY first class watchmaker, salesman and optician desires to make a change; New York or vicinity; good appearance; best of references. "Exceptional, 6731," care Jewelers' Circular-Weekly.

FIRST CLASS WATCHMAKER desires position in New York City; has first class references and is thoroughly competent on fine and complicated work. "City, 6565," care Jewelers' Circular-Weekly.

YOUNG MAN, possessing long experience in the wholesale jewelry business, desires position where hard, conscientious work will be appreciated. "Conscientious, 6701," care Jewelers' Circular-Weekly.

DESIGNER and practical jeweler, platinum diamond mountings a specialty, can furnish artistic original designs for fraternity presentation jewels. Address "E. Beach, 6694," care Jewelers' Circular-Weekly.

ENGRAVER, young man, desires position to finish trade, good letterer on flat ware; also have some knowledge of script copper plate engraving; samples on request. "Script, 6642," care Jewelers' Circular-Weekly.

FIRST CLASS WATCHMAKER, desiring to change, would like position at once; Massachusetts preferred; competent to handle railroad work. Address "I. H. B.," 45 Charles St., Springfield, Mass.

WATCHMAKER and engraver, qualified to take charge; accustomed to complicated work; experienced in the position and also on fine adjustments; best references. "C., 6687," care Jewelers' Circular-Weekly.

SILVERSMITHS or others wanting a first class modeler; original ideas; figure or ornamental; anything that can be done in wax, metal or plaster; moderate. Address A. Power, 1318 Brook Ave., Bronx, N. Y.

YOUNG MAN, familiar with the watch and jewelry business, wants a line of goods to sell to the retail trade on commission; in and near Philadelphia; best of reference. "Phila., 6703," care Jewelers' Circular-Weekly.

FOREMAN, DESIGNER and thoroughly experienced, practical jeweler; platinum diamond mountings especially; can do all kinds of alloying, melting and enameling. Address "Foreman, 6695," care Jewelers' Circular-Weekly.

WATCHMAKER, manager of watch department; competent to do fine and complicated work; railroad watches a specialty; take in, deliver work and set prices; is open for engagement. "Breguet, 6736," care Jewelers' Circular-Weekly.

FIRST CLASS watchmaker wants permanent position with reliable house; competent to take full charge; large experience on fine and complicated work; fine tools and best of references. Address "Time, 6712," care Jewelers' Circular-Weekly.

PERMANENT POSITION wanted by an expert, first class watchmaker; thoroughly competent on all grades of watch and clock work; single; own full set of tools; well recommended. Address "Permanent, 6700," care Jewelers' Circular-Weekly.

YOUNG MAN, Protestant, plain engraver, good jewelry and clock repairer; good salesman; send sample of engraving; fine references; go anywhere; prefer New York; \$15; inquiries answered. "T., 6738," care Jewelers' Circular-Weekly.

POSITION WANTED by first class watchmaker; 25 years' experience; fine set of tools; equally good on American or Swiss watches; fine pivoter; salary, \$25 per week; western States preferred; no objection to small town. "R., 6666," care Jewelers' Circular-Weekly.

MANUFACTURING JEWELER and diamond setter desires position in retail store, somewhere in the south; would prefer San Antonio, Tex.; only those who can offer permanent position to a good workman will be considered; sober and good reference. Address "Sober, 6673," care Jewelers' Circular-Weekly.

POSITION WANTED by an experienced diamond man, in wholesale house; has been buyer and traveler in loose goods business for a number of years. Address, "Diamond, 6559," care Jewelers' Circular-Weekly.

## Side Lines Wanted.

WANTED AT ONCE, one or two first class manufacturer's lines on commission or salary; New York city or traveling. "S. W., 6728," care Jewelers' Circular-Weekly.

## Wanted to Purchase.

WANTED TO BUY second hand die cutting machine that reduces; state make; must be in good condition. Address "D. C., 6698," care Jewelers' Circular-Weekly.

WANTED TO PURCHASE, in New Jersey, Pennsylvania or New York, an established jewelry business; town of 5,000 to 10,000 inhabitants. "W., 6719," care Jewelers' Circular-Weekly.

ANTIQUÉ JEWELRY WANTED; we are always ready to make cash offers on any antique jewelry containing mosaics, cameos, seed pearls, etc.; also ligree, enameled or etruscan jewelry, either all gold or set with diamonds or other stones. Chas. S. Crossman & Co., The "Old Mine" Diamond House, established 1880, 3 Maiden Lane, New York.

## Help Wanted.

FIRST CLASS watch and clockmaker; steady position to right man. D. Bick, 360 Third St., New York.

FINE ENGRAVER and jewelry repairer. work; good salary; permanent position. W. Mortimer, Pottsville, Pa.

WANTED, first class jeweler and engraver; position to the right man. P. J. Koke, jew. 145 Monroe St., Grand Rapids, Mich.

WANTED, a young man who understands kinds of gilding and coloring. Address "6742," care Jewelers' Circular-Weekly.

WATCHMAKER and engraver; wages, \$15 per week; permanent position for right man. Hack Bros., 2196 Third Ave., New York.

AT ONCE, a good engraver, clock and jewelry repairer; steady position to a good man. Ad. "J., 6367," care Jewelers' Circular-Weekly.

WANTED, first class manufacturing jeweler; good position to the right man. P. J. Koke, Jeweler, 145 Monroe St., Grand Rapids, Mich.

ENGRAVER for letter and monogram work; first class retail jewelry store; permanent position. C. Preusser Jewelry Co., Milwaukee, Wis.

EXPERIENCED young man as jeweler, clock repairer and engraver; steady position, state or west. Address "Hawkins, 727 Eighth Ave., New York.

WATCHMAKER WANTED, at once; permanent job and liberal wages to a first class man or write. Wm. B. Byrner, 177 Broadway, New York.

WANTED, a good watchmaker who can engrave; good position for a first class man; address references. Sylvester Engle, 16 West Broad St., Hazleton, Pa.

WANTED, diamond mounters and setters; jobbing jewelers; permanent position; good wages. E. Maritz Jewelry Mfg. Co., 217 N. St., St. Louis, Mo.

WANTED, second watchmaker and repairer; salary, \$15 per week; steady position, send photograph and reference. Address B. x Charleston, W. Va.

DESIGNER, one experienced in silver best on hollow ware; state experience, salary expected, etc. T. F. Tuttle Silver Co., 587 Washington St., Boston, Mass.

WANTED, a jewelry salesman, one acquainted with the jobbing trade in Philadelphia, Baltimore and New York State. Address "P. B.," care Jewelers' Circular-Weekly.

WANTED, a watchmaker, one who can engrave preferred; good salary; permanent position; have good references. Address S. P. Soule Raymond Building, Baton Rouge, La.

WATCHMAKER, who is an expert on all watches, with some knowledge of other work; permanent position for good man. Address "6708," care Jewelers' Circular-Weekly.

WANTED, a good letter engraver who understands repairing watches and clocks; permanent position to first class man. Address "6672," care Jewelers' Circular-Weekly.

WANTED, AT ONCE, two first class manufacturing watchmaker, engraver and optician; engraver, salesman; permanent position. B. Gates, 809 Second Ave., Seattle, Wash.

WATCHMAKER and engraver, at once; competent man with tools; good reference, salary \$20 per week; at Canton, Miss. Address "Richards, Bourne & Co., Greenville, Miss."

WATCHMAKER, salesman, engraver; good appearance; state experience, reference full description, with wages expected in letter. Standard Jewelry Co., Pittsburgh, Pa.

WANTED, WATCHMAKER, must be good man; experienced; salary based on work; Jules Ascheim, 37 Maiden Lane, New York Southern Loan and Jewelry Co., Tampa, Fla.

WANTED, experienced traveler having called the jewelry trade in central west, liberal tract to A1 man. Western Selling Agency Omega Watches, Heyworth Bldg., Chicago, Ill.

WANTED, WATCHMAKER, good engraver; salesman; send sample of engraving state years of store experience and salary expected. Ed. J. Niewolner, Columbus, Ohio.

**HELP WANTED.—Continued.**

WANTED, good combination watchmaker, engraver and salesman; wages \$22 weekly; permanent, hours, 8 to 6; all particulars and references in first letter. T. W. Morrison, Newburgh, N. Y.

EXPERIENCED OPTICIAN, who can do engravings and jewelry repairing; none but first class and experienced men need apply; send pictures and references. J. B. Cook & Co., Bismarck, Dak.

WANTED, a good repair man; must be sober and good engraver and optician; on wages or commission, or rent free and be a salesman; steady position. "E., 6711," care Jewelers' Circular-Weekly.

WANTED, first class watchmaker of good address, who can assist as salesman; New York experience; permanent position to right man; reference required. "New York, 6665," care Jewelers' Circular-Weekly.

WANTED, AT ONCE, a good watchmaker and engraver, or a good jeweler and engraver; permanent position; good salary; references required; send sample of engraving. E. F. Jake, Norfolk, Va.

FIRST CLASS ENGRAVER; one who can do all kinds of lettering and monogram engraving; use a good steady man at a good salary; apply to A. Newsalt, Jeweler, cor. Fourth and 11th Sts., Dayton, O.

FIRST CLASS watchmaker and optician wanted; good opportunity offered to right party; steady position; in one of the large cities in Pennsylvania; write at once. L. W. Rubenstein, 54 Linden Lane, New York.

WANTED, a first class watchmaker and a good around man for retail store, at once; first class job for good man; send reference; job will pay \$18 to \$20 per week to start. Meyer & Hamber, Meridian, Miss.

WANTED, first class diamond, precious and imitation stone salesman for southern and western territory; right position for right man; apply by letter, stating experience. Address "Confidential, 65," care Jewelers' Circular-Weekly.

WANTED, first class watchmaker and engraver to be in charge of watch department; also want first class jobbing jeweler who understands diamond setting; steady work and good pay; single men preferred. R. Van Keuren & Co., Savannah, Ga.

WANTED JEWELER; permanent position; state reference, ability, age and salary in first letter. Wm. Schweigert & Co., Augusta, Ga.

WANTED, a first class optician; one who understands edge grinding preferred; steady employment and good wages to the right man; must be well recommended. Address "Central Connecticut, 6640," care Jewelers' Circular-Weekly.

WANTED, a first class clock and jewelry repairer; one who can engrave preferred; must understand bench clocks and be good at hard soldering; good, steady position to the right man; give full particulars in first letter. J. M. Bigwood, Terre Haute, Ind.

RESPONSIBLE TRAVELERS to take our line, consisting of fine elk and gold jewelry; south and Pacific coast and small eastern and western territories as a side line on a commission basis; state territory. Schiecklerling Mfg. Co., 31 W. 31st St., New York.

AGENTS WANTED; capable and responsible specialty men, selling direct to consumers, for a well known article of great merit, having ready help; liberal arrangements to those who can get results. Address "A. B. C., 6677," care Jewelers' Circular-Weekly.

AT ONCE, A1 watchmaker; one who is capable of being in charge of railroad watches; also must do engraving; none but first class men need apply; reference with first letter; will pay \$20 per week to the right man. Address Gorman & Green, Salisbury, N. C.

WANTED, first class optician and watchmaker; steady position; \$35 per week and will increase as they get competent; send reference, age, etc.; dwarfs need apply; have dark room and latest proved optical instruments. Geo. F. Blakeslee, Tonopah, Nev.

A GOOD jewelry repairer, clockmaker and salesman; one who is not afraid of work and can make himself generally useful in store; good wages and permanent position to right man; state wages and experience in first letter. J. D. Taylor, Logansport, Ind.

WANTED, JULY 1, salesman and office assistant in large wholesale house; inside position; young man preferred; chance for advancement; must have experience; state reference and full particulars; replies confidential. Address "Permanent, 6696," care Jewelers' Circular-Weekly.

MOUNTING SALESMAN for well known 14k. and 18k. specialty line; eastern and middle states; salary and commission. Address, "Line, 6689," care Jewelers' Circular-Weekly.

WANTED, WATCHMAKER immediately; permanent position; good salesman; one who knows something about refraction preferred; capable of taking sole charge; great opportunity for advancement; state age, experience and wages expected in first letter. Freeman Jewelry Co., 84 Seneca St., Buffalo, N. Y.

WANTED, young man with several years' experience in a wholesale jobbing jewelry house; a splendid opportunity for a young man who is bright, active and desires advancement; permanent position; all replies considered confidential; address with full particulars. "Jobber, 6697," care Jewelers' Circular-Weekly.

WANTED, strictly first class combination man (watchmaker, jeweler and engraver); must be sober and well recommended; good salary and permanent position to good man; must be a willing worker, rapid and very thorough; state salary expected and send sample engraving in first letter. Thos. Van Auken & Co., 516 Pearl St., Beaumont, Tex.

WANTED WATCHMAKER; Abraham & Straus, Brooklyn, can place in a permanent position at liberal salary a competent man who thoroughly understands watch repairing in all its details. Apply to Superintendent.

WANTED, on commission basis, specialty salesmen of proved ability, pleasant address and good appearance, for a high class article of great merit, with wide reputation, selling to stationery, drug and jewelry trades; no objection to salesmen with one or two other non-conflicting lines, providing each town is thoroughly worked; permanent territory to the right man; address with full particulars. "M., 6678," care Jewelers' Circular-Weekly.

A VALUABLE OPPORTUNITY is offered to a good salesman acquainted with best trade in New York City and Brooklyn, to handle a well known 14k. and 18k. specialty line; might be handled in conjunction with one other line. Address "Trade, 6688," care Jewelers' Circular-Weekly.

WANTED first class diamond and precious stone salesman, one who has experience with southern and western trade; excellent opportunity for a hustler; good salary and commission; answer by letter, stating experience, etc.; communications confidential. "C., 6690," care Jewelers' Circular-Weekly.

SALESMAN for New York City and vicinity, wanted by well known manufacturer of 10k. gold jewelry; sample stock, commission basis; must have acquaintance with jewelry and department stores; no objection to good man representing another line; all replies confidential. "Gold, 6418," care Jewelers' Circular-Weekly.

WANTED AN ARTIST with expert knowledge of enameling to take full charge of small plant, for special work, in artistically designed enameled jewelry and hollowware; address stating qualifications and particulars as to experience and ability; terms made satisfactory to right party. "W. E. T., 6724," care Jewelers' Circular-Weekly.

WANTED, AUGUST 1, high grade salesman for well known manufacturer's line, of Providence, R. I., territory middle and western states; must have acquaintance with large department stores and leading retailers in large cities; to a young man of good address and who is aggressive and successful, with unexceptional references, a good position is open; state experience, age and salary expected. Address, "Permanent, 6590," care Jewelers' Circular-Weekly.

**Business Opportunities.**

ARTIST, modeler, chaser, enameler and extra fine die sinker, wishes man with capital to form partnership; the best in his line in the United States. "Artist, 6667," care Jewelers' Circular-Weekly.

FOR SALE, in town of 25,000, 45 minutes from New York, jewelry business with fine repair trade; railroad watch inspection; stock low; \$1,500 buys it. "Quick, 6717," care Jewelers' Circular-Weekly.

A WELL ESTABLISHED jewelry store; owner must retire, due to ill health; good sales and a fine run of bench work; will reduce stock to any amount desired. Ed. Lorentzen, 69 Amsterdam Ave., New York.

FOR SALE, well equipped manufacturing jewelry shop, in rapidly growing western city of 40,000; good machinery; old established place; no competition. Address "F. G., 6651," care Jewelers' Circular-Weekly.

\$500 JEWELRY STORE; watch and clock repairing; not fixed up for sale, but where I have supported myself and family for 40 years; reason, old age. E. H. Fairbanks, 713 Centre St., Jamaica Plain, Boston, Mass.

\$450 BUYS jewelry store; best manufacturing town in State of New York; stock new and staple; best location; repair trade pays all expenses; up-to-date fixtures. Address "F., 6671," care Jewelers' Circular-Weekly.

GOOD OPENING; a watch and jewelry business, fair run of good custom in prosperous country town of about 1,800 population; on a main railroad line; for sale on account of personal circumstances; fine chance for a professional man. Address G. A. Freund, Hermann, Mo.

YOUNG MAN (35), for seven years highly successful manager of high class retail business, would invest \$15,000 to \$20,000 in prosperous business in city of not less than 75,000 population; prefer to purchase outright, but might consider an interest in large concern and assume management; highest trade connections and credit. "Boston, 6716," care Jewelers' Circular-Weekly.

CASH PAID for entire jewelry stores and stocks; send us your surplus stock, and we will send you a check by return mail; if our offer is unsatisfactory we return your goods; we act quickly and strictly confidential. Jos. Brown & Co., Fifth Ave. and Madison St., Chicago, Ill.

DO YOU WISH TO RETIRE? We buy jewelry stores to any amount; also entire stocks of jewelry, diamonds, watches, silverware, fixtures, etc.; we are known all over the United States to pay highest spot cash; notify us, we will call on you at once; all business transacted we handle strictly confidential. Address Brooklyn Purchasing Syndicate, 608 Broadway, Brooklyn, N. Y., or Tel. 2328, Williamsburg.

**Lost.**

WANTED, INFORMATION, leading to location of open face Elgin, gold watch, monogram H. L. T. on back; probably left for repairs about November, 1905. J. F. Newman, 11 John St., New York.

(Special Notices continued on page 72.)



## Glassware

showing "The Colors of the Rainbow." Our line is complete with Vases, Fancy Bowls, Novelties, etc., that range in price from \$1.00 to \$50.00 each.

SEND FOR A SELECTION,

or call at our show rooms. The selling quality is in the sheen and colors; cuts cannot show its beauty.

### Tivoli Art Glass Co.

Makers of High Art Iridescent and Decorated Glassware

87 MAIDEN LANE NEW YORK  
Telephone 2054 John.

#### "PRACTICAL COURSE IN ADJUSTING."

Price, \$2.50.

All Jobbers or Jewelers' Circular Publishing Co.

## Special Notices.

(Continued from page 71.)

### For Sale.

JEWELER'S SAFE for sale; inside measures 49" x 36", double doors; cheap. Engelfried & Weidmann, 12 Dutch St., New York.

\$60. MARINE CHRONOMETER; four-inch dial; made by Lewis Woolf, Liverpool, England; in fine condition. Inquire at jewelry store, 845 Sixth Ave., near 48th St., New York.

JEWELERS' TOOLS, full set, including chest, black walnut lathe and work bench; will sell at sacrifice; call Monday, Tuesday or Wednesday evening. Luken, 259 Baldwin Ave., Jersey City Heights, N. J. Ring bell twice.

FOR SALE. 50 cents on the dollar, 15 ruby velvet trays, plain, to stack; Crouch & Fitzgerald telescope, cost \$12. sell \$7; 14 trays, cost 42 cents, sell for 25 cents; used one year. Room 605, 92 William St., New York.

### To Let.

DESK ROOM or part of office to let. 3 Maiden Lane, Room 53, New York.

DESK or bench room to let; best light on "Lane;" 12th floor. Isidor Stern, Diamond Setter, 53 Maiden Lane, New York.

FOR A MANUFACTURING JEWELER, in most desirable new brick building; one or two floors, with or without office; power, etc., at hand; fine northern light, airy and perfect in every respect; really worth while investigating; in every way as well located as Tiffany's in Forest Hills, the next station on the same road; take Greenwood Lake Division, Erie Railroad, to North Newark, N. J. Verona Chemical Co., Newark, N. J.

**GREAT OPPORTUNITY, Fifth ave. N. Y.** New York, to lease for a long term a new seven story store and basement building, on Fifth Ave.; the best location for wholesale and retail jewelry firm. For full particulars address, "Attorney, 6722," care of Jewelers' Circular-Weekly.

### Miscellaneous.

WATCH REPAIRING for the trade; low prices. Paul Friedman, Room 120, 51-53 Maiden Lane, New York.

SOMETHING entirely new in the line of window decoration; send five two-cent stamps for sample and postage. Address The Window Decorator Co., 74 Cortlandt St., New York.

## TO LET.

### Three Desirable Light Locations

At 31 MAIDEN LANE, N. Y.,

One door from Nassau St. Prominent location in center of jewelry district. Address F. J. W. 130 Broadway, New York; or, your own broker.

### News Gleanings.

Carl T. Gansel, Independence, Kan. convalescent after a very severe illness.

Milton Gardner is about to open a store on McCarroll Ave., Washington

N. V. Cole has sold his store at Franklin St., Michigan City, Ind., to Dresser, of Lafayette. Mr. Cole will retire from the business which he has conducted for the past 32 years.

W. E. Mount has purchased an interest in the business of Geo. D. Kendall, Pueblo, Colo., and the firm style hereafter will be Geo. D. Kendall & Co. Mr. Mount will have active charge of the management of the business.

Lewis Callisher, Washington, D. C. is about to erect a new building for his jewelry business, at a cost of \$13,000. The structure will be three stories high and located on Pennsylvania Ave., between 10th and 10th Sts., N. W.

The Reineman-Blose Co. was recently incorporated in McKeesport, Pa., by Henry A. Reineman, G. R. Blose and Burton Reineman. The new firm will absorb the interests of Henry A. Reineman, at 100 Fifth Ave., one of the oldest establishments of its kind in the city.

James P. Ryan, trustee in bankruptcy of Mrs. Pauline L. Lowenthal, Bradford, Pa. will sell at public auction, Monday, July 2, the premises of the bankrupt, 28 Maiden Lane, the entire stock, consisting of diamond watches, jewelry, silverware, cut glass and kindred lines, together with the show cases and other furniture and book accounts. Notice to this effect has been sent to Mrs. Lowenthal's creditors. The sale begins at 10 A. M.

#### Market Price of Silver Bars.

The following are the quotations for silver bars in London and New York, reported by Zimmerman & Forshay:

	New York.	London.
June 19.....	\$.65 1/2	30 3/4
" 20.....	.65 1/2	30 3/4
" 21.....	.65 1/2	30 3/4
" 22.....	.65 1/2	30 3/4
" 23.....	.65 1/2	30 3/4
" 25.....	.65	30 1/4



## The "Opera"

works with a spring and gracefully fits any wrist. Invisible joint, and the peer of all. The best seller of the season.

Made of gold plate, in all the popular finishes and sizes, with and without stones.

Ask your jobber to show you this new creation, or write us for details of construction and price.

MANUFACTURED BY

## CASTIGLIONI & CAPALDI CO.

Successors to T. F. GREENWOOD CO.

9 Callender St. Providence, R. I.

Manufacturers of Novelties in Bracelets, Brooches, Hat Pins, Scarf Pins, Barrettes, etc., of highest grade, that defy competition

## WM. SMITH & CO., Office, 9-13 Maiden Lane, N. Y. Manufacturing, 61 Peck St., Providence, R. I.

Established 1854.

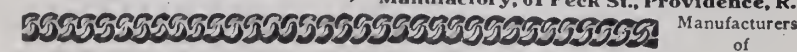

## GOLD AND SILVER CHAINS,

Gold, Silver and Plated Chain Trimmings,  
Also GOLD AND SILVER KEY CHAINS AND BRACELETS.



## DATTELBAUM & FRIEDMAN,

Makers of Gold Rings of All Descriptions.  
45 John Street, New York.

Our Trade-Mark "D. F." in all our Rings is the guarantee of quality.  
Send for Catalogue.



**Pittsburg.**

W. Berkley is in Toronto, Can., enjoying a short vacation.  
 S. F. Sipe will sail July 17 for America to buy diamonds.  
 S. Cerf, of Sol Cerf & Co., will leave next week for Narragansett Pier, Providence and New York on a business and pleasure trip.  
 August Loch, Allegheny, has subscribed to the Fourth of July fund on that side of the river. The usual celebration will also be held in Pittsburg.  
 Morris Kingsbacher, of Kingsbacher, leaves this week for Narragansett Pier and from there will visit New York on business. He will be gone for several weeks.  
 It will be a week or two before Roberts & Sons will be able to move their new store, already the place is attracting much attention, because of the new fixtures being installed. The store will be unquestionably the largest and finest in Pittsburg.  
 A jewelry salesman named Thorp and going for a Pittsburg house reported to the police that he had been offered a \$200 diamond ring by a man in a house where he boards. Thorp had the ring on the dresser in his room, when he awoke the next morning the ring was gone, and he has not yet recovered it.  
 An itemized account is attached as follows: Ten diamond studs valued at \$35, \$25, 10 at \$15 and 10 at \$10. The plaintiff avers that the account has been long overdue, and that the defendants refused to pay any part thereof, before the suit is brought. Munn avers that the jewelry was delivered as ordered upon and he wants his money.  
 A window thief is again getting busy in Pittsburg. Last week some one threw a brick through the show window of the jewelry store of Biggard & Wolf, 5 Smith Street, and then reached in and stole a pair of gold-plated chains and other articles. The store is in a populous section but no one appears to have heard the sound of glass. The first to discover the break was Robert Biggard when he arrived at the store at 7:30 A. M. The policeman on the beat had not noticed it. Biggard says his loss does not exceed \$75.  
 Alexander D. Munn, a jeweler at 4409 North Street, in the Lawrenceville district, has entered suit against Mayor Hays, former Director Bigelow of the Department of Public Works; Assistant City Clerk and others to recover \$850 with interest, which he alleges is due to him for diamond studs sold by him to the men named in the suit, to be given away as prizes in the athletic events held in Schenley Park by the city July 4, 1904. In his complaint filed in court yesterday Munn avers that it has been the custom of the city for a number of years to hold these celebrations, and that it has been the custom of the Mayor and others to have a share of the celebration. The defendants are the managers of the sporting events which were scheduled at the park.  
 S. Wiley, secretary of the Pennsylvania Retail Jewelers' Association, has

mailed between 3,000 and 4,000 circulars to the trade in this State, for the call of the convention to organize a State association in this city, July 10. The circular contains the names of 80 jewelers in the State outside of Pittsburg who have signified their intention of joining in the movement. Mr. Wiley said Saturday that replies are coming in and that he had received a dozen from jewelers in McKeesport, Blairsville, Washington, Pa., and other places in Western Pennsylvania, assuring him that they will be in Pittsburg to join in the movement. Replies from the eastern part of the State are expected this week. Mr. Wiley said that practically all of the Pittsburg jewelers had given him assurance that they will become members of the association, and it begins to look as though the organization will be a success.

**Providence.**

**TRADE CONDITIONS.**

Although with the advent of the Summer season the jewelers will soon begin their annual exodus to the shore or country, nevertheless business is much brisker than is usual at this time of year, and any number of houses are carrying about all that they can conveniently handle.

C. W. Kelly is now representing Charles Ball on the road. Mr. Kelly was formerly a jeweler in this city, and Mr. Ball is a manufacturer of art metal goods.

The W. J. Feeley Co. has been awarded the contract for providing the tablet to be placed in the State House to the memory of Gen. Sullivan, of Revolutionary fame.

Harvey Huestis, of Huchison & Huestis, decided recently that a trip "across the pond" would do him good, and left last week for a visit to various points of interest in Europe.

William H. Luther has been visiting his son in Norton, having taken a rest after his confining duties as chairman of the Police Commission during the recent Chief of Police investigation.

Jewelers and buyers visiting the city and stopping at the Crown Hotel will hereafter be greeted by Fred Mansfield, as manager, he having been given the position made vacant by the death of F. L. Porter.

Local jewelers were much interested in the rumors regarding the consolidation of the Union Trust Co. and the Manufacturers' Trust Co., two of the well-known banking institutions of the city. Not only are jewelry interests represented on the board of directors, but many are depositors in the two companies.

A Portuguese salesman named Augusto Cerar left a grip containing a quantity of watches, rings and other jewelry in the care of a friend in Bristol one day last week. The friend tucked it away in what he thought was a secure place. Later he found that it had disappeared. He had a suspicion that an Italian who had been hanging about the place could tell something about the sudden removal of the property. An investigation led to the arrest of the Italian and the swearing out of a warrant for larceny against him. Later the property was found in the home of the prisoner's brother.

C. Van Der Elsen, Centerville, Ia., has sold out to F. F. Wollert.

**Boston.**

**TRADE CONDITIONS.**

As the first half of the year draws to a close the jewelers here are disposed to be retrospective, and some of them have good reason to be gratified with the results as they review the situation. Most of the Boston jobbers report that business for the past six months has been excellent. A number of them have surpassed the exceedingly good record made in the first part of 1905. Retailers also report a good run of trade at the outset of the year, and fair business since, with June above the normal in line of gifts and prizes for the midsummer wedding, graduation and outing season. Prospects for the balance of the year everywhere in this vicinity are regarded as promising.

E. W. Stone, salesman for John B. Humphrey, has returned from an outing and business trip to New York.

E. A. Bigelow, treasurer of the E. Howard Clock Co., has gone to Lake Winnepesaukee for a week of rest and recreation.

The funeral of Michael J. Mahoney, formerly engraver for A. Stowell & Co., whose death occurred on the 17th inst., took place on Wednesday last from his residence at 21 Bailey St., Dorchester.

William J. Anderson, of the clock repairing department of the E. Howard Clock Co.'s Boston office, was married June 20, in Newton, to Miss Franklin, of that city.

George E. Fahys, of Joseph Fahys & Co., was in Boston last week, running over from New York in his automobile and arriving here on Thursday. He remained in town over Friday, visiting the Boston office of the firm, and returning in his touring car Saturday afternoon.

Boston retailers began their Saturday early closing season. It will continue three months. The wholesalers now extend their early closing period over a stretch of practically six months, and some of the most important houses have adopted the 1 o'clock closing rule for Saturday the year round.

The Shreve, Crump & Low Co. has arranged an exhibit of Tiffany glass, which has attracted considerable attention recently. A room in the establishment was fitted up as a studio for the special display of the product, and many very beautiful examples of art work in the line of shades and other objects of home adornment have been shown.

William Metheson, former superintendent at the E. Howard factory, but more recently of the Trenton (N. J.) watch factory, has been in Boston for a short time on a business trip, and was also at Waltham, where he was interviewed by some of the watchmakers regarding the opportunities of profitable employment in the Trenton establishment.

Guy C. Stillings, former secretary and director of the Preferred Mercantile Co., of Boston, the concern that was put out of business several months ago by the United States government, after the conviction of the Stillings brothers on several charges relating to their method of conducting a diamond lottery business, is to be released on June 29, the plea of impaired health being made in his behalf. Last August he was sentenced to a year's imprisonment in the Suffolk Co. (Boston) jail as a result of contempt of court proceedings against him and his brother.

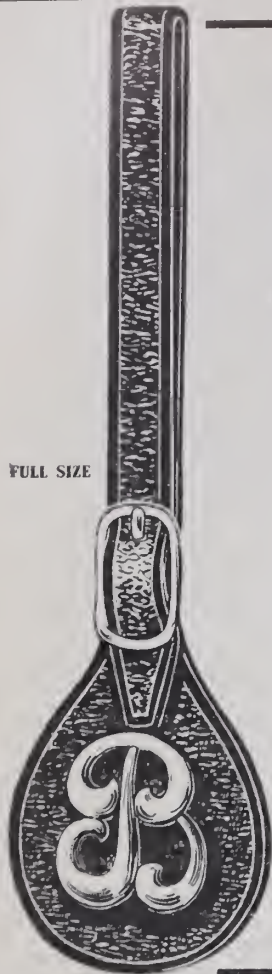

FULL SIZE

## JOHN A. SALMAN & CO.

21A Bromfield St., Boston, Mass.

We make and sell more Monogram and Initial Fobs than any other manufacturer in the country.

Now is the time to put in a stock of Initial Fobs. Here is a good seller which you can buy in one dozen lots or upwards at \$2.00 PER DOZEN. All one piece black leather lined strap, nickel buckle and rounded STERLING SILVER faced letter.

Send for a Selection.

You can choose your own letters.  
All goods guaranteed. Send for fob cuts.

TRY THEM AND YOU WILL NEED MORE

### Buffalo, N. Y.

Meyer Brown, 136 Seneca St., returned Saturday, from Angola.

One of the most attractive fronts attended by local jewelers is being put in by Hammond, 54 Seneca St.

Buffalo jewelers are, this week, having another run on souvenirs, by reason of the Knights of St. John convention, which brought 10,000 visitors to the city.

C. H. Davison, traveling for the Corbin & Heilborn Co., who makes his headquarters in Buffalo, departed, last Monday, on an extended trip up the Great Lakes.

C. J. Fisher, at 251 Main St., in his new location in the Glenny block, has made his interior one of the handsomest in Buffalo. For several months Mr. Fisher has occupied a temporary storeroom across the street, the Glenny block gutted by fire.

Mr. Dickinson, of the T. & E. Dickerson & Co.'s store, 472 Main St., is living in the Summer along the shore of Lake Erie, several miles out of Buffalo, going and coming to the city by the Lake Shore Railroad. Mrs. Dickinson has purchased one of the handsomest houses on Linwood Ave.

Frank A. Sharp, who is said to be a passenger for a Chicago jewelry house, died at a hotel at N. Division, in Oak St., last week. The deceased was 45 years old and had come from Trenton, N. J. He evidently fallen in a fit on his pillow being unable to rise, died of suffocation.

Frank Hammond, Buffalo's veteran watchmaker, in charge of the watch inspection for the Boston & Maine Railroad, and inspector for several lines, was out Thursday, after a two-weeks' illness, which confined him to his bed. Mrs. Hammond has returned from a visit to St. Louis which she was accompanied by her daughter.

Mrs. Carrie Schlenker, who has been serving for the Grand Jury on charge of \$1,000 worth of watches and jewelry from the Freeman Jewelry Co.'s store, 84 Seneca St., is preparing to make a strong defense at her trial on the plea of insanity. Her conduct since a prisoner at the County Jail is such as would tend to show that she is insane at the present time. Manager W. H. Foerster, of the Freeman Jewelry Co., says he has proof that the woman has written letters and made statements since her arrest which show conclusively that her mind and reason are in good shape.

Paul Foerster, 134 Seneca St., has received \$700 worth of the diamonds stolen from a tray several weeks ago. The value of the diamond rings stolen was \$1,000, but only a portion of them were recovered. Walter Harrington, who has been found guilty in the Supreme Court to steal jewelry, is, much to the surprise of Mr. Foerster, enjoying his liberty on a \$10,000 bail bond. Harrington is a relative of a man in the Buffalo Police Department Bureau of Identity. This fact is mentioned upon in connection with the trial of Harrington to receive his sentence. The jewelry returned to Mr. Foerster had been in the custody of the police to be used in the trial of Harrington had he not pleaded guilty.

R. Redfield has purchased the business of C. G. Collier, Tonkawa, Okla.



## BROOCHES

OUR new line shows many designs, highly artistic and attractive, that will prove rapid sellers.

The highest class of workmanship is characteristic of all our lines.

- Combs
- Brooches
- Scarf Pins
- Bracelets
- Barrettes
- Buttons
- Baby Pins
- Crosses
- Waist Sets
- Hat Pins
- Collarettes
- Silver Novelties



ALWAYS ON THE GO

LOOK FOR THE TRADE-MARK  
NORTH ATTLEBORO, MASS.

MILLER, FULLER & WHITING, MANUFACTURING JEWELERS  
N. Y. Office, 9-11 Maiden Lane



## OUR Silver GOODS

Jewelry and Novelties are Original, Artistic and Sellers. Our name stands for the best of everything in our line at our prices.

THE W. H. SAART CO., Attleboro, Mass.

OFFICES: 713 Market St., San Francisco.  
103 State St., Chicago. 204 St. James St., Montreal.  
49 Maiden Lane, New York.

- Tollet Goods
- Wrist Bags
- Buckles
- Bracelets
- Hat Pins, etc.

## Philadelphia.

Amuel Kind, head of S. Kind & Sons, left last week for Europe. He will return in the Fall.

Wol. Sickles, of M. Sickles, returned last week from an extended trip through Pennsylvania and neighboring States.

Wm. N. Todd, a watchmaker well known in this city, established himself in business last week at 36 S. 7th St., as a watchmaker in the trade.

E. Caldwell & Co. are making extensive alterations to their store, 902 Chestnut St. An extension is being made to the art galleries and other improvements are being made in the rear of the first floor.

W. H. Krehbiel, Mound Bridge, Kans., was a visitor to this city last week. He is making a vacation tour of the east and plans to spend some time at the national hotel and the Atlantic coast resorts.

Among the out-of-town retailers buying during the week were: H. B. MacLeland, East Downingtown, Pa.; George Owen, Bridgeton, N. J.; H. S. Kratz, Pottersville, Pa., and Mr. Harper, of Harper & Taylor, Saulsbury, Md.

F. Finnegan, a pawnbroker, 9th and Chestnut Sts., accused a Chinaman last week of robbing a diamond ring, valued at \$125, from his place. He says that the Chinaman intended to want to buy a ring and then take the one he misses. The Chinaman was arrested and is held awaiting trial.

The trade of this city has extended its sympathy to L. P. White, whose brother,

Dr. J. William White, one of the best known surgeons of Philadelphia, is under treatment for a serious internal trouble at a Minnesota infirmary. Mr. White's brother, Dr. White, is widely known for his activity in the advancement of college sports.

W. B. Bechtel, of J. B. Bechtel & Co., has returned from a canvass of the Schuylkill county. Business in this section is reported to him to be excellent since the mines are being worked and there is no danger of a strike or other industrial disturbance. Ed. Sickles, of the same firm, celebrated quietly last Wednesday, his 15th wedding anniversary. Mrs. Sickles has been ill, and on this account the festivities planned were postponed.

The baseball game which practically decides the championship of the jewelry business of this city, was played Saturday between teams representing M. Sickles & Sons and Simons, Bro. & Co. The former team had defeated the nine organized by the employees of H. O. Hurlburt & Sons, and in one inning ran up 11 runs against the nine of I. Bedichimer & Co., when the game was called. The game was played at Chambers Hill, N. J., and was witnessed by many in the trade.

It was reported here, Wednesday, that the Controller of the Treasury at Washington will not support the director at the Mint in Philadelphia, in the latter's attempt to manufacture cases for medals. Heretofore the medals were incased by local jewelers, but owing to the delay in obtaining money the members of the trade here refused to do the work, whereupon the director of the Mint decided to do it himself. The Controller of the Treasury holds that the appropriation for the Mint cannot be

stretched to include mounting and casing of medals.

Justice was swift and relentless in the case of the kidnapping of little Freddie Muth, the seven-year-old son of Charles Muth, retailer, 1632 Columbia Ave. After the kidnapper had been caught, as reported in THE CIRCULAR-WEEKLY last week, he was immediately placed on trial and "railroaded," in the language of the police. He was identified as John Joseph Kean, a man with a wife and three children. Twenty-four hours after his arrest he was rushed to the penitentiary to serve a 20-years' sentence. His wife and children have removed to New York, from which place they originally came.

The annual midsummer field day of the Jewelers' Club was held yesterday, when a game of baseball was played between the Philadelphia and New York members of the team club. The nines were well chosen, the candidates for the various positions being selected with a view of strengthening both teams. The game was played at the Philadelphia Ball Park, Broad and Huntingdon Sts., and was witnessed by the club members, as well as the wives and other members of the family of the members. It partook, naturally, of a social function, to which zest was added by the match game. After the game was over the members of the club adjourned to the club house at 13th and Chestnut Sts., and later in the evening were treated to a vaudeville show at the Tuxedo Club. There were some lively boxing bouts and many other interesting performances, which are to be more fully and accurately reported in the next issue of THE CIRCULAR-WEEKLY.

## North Attleboro.

George L. Paine was in New York last week.

The H. F. Barrows Co. has been obliged to operate its factory 13 hours a day.

William F. Maintien returned early last week from a fishing trip passed in Maine.

Ira McGavin, salesman for Riley & French, has been at the factory for the past few days.

George S. Semple, New York representative of the W. & S. Blackinton Co., was at the factory this week.

Richard Saunders has left for the west for Paye & Baker Mfg. Co. After a tour of the middle states he will travel through Wisconsin.

Bids for the proposed new jewelry factory have been received, but thus far no contract has been given out nor have the plans been finally adopted.

Jean Theobald, head designer at the factory of Frank M. Whiting Co., has resigned and will enter the employ of the Theo. W. Foster & Bro. Co., Providence.

Donald LeStange, western representative of H. D. Merritt Co., donned his baseball togs last Thursday, and caught for the Brown University alumni in its game with the college team.

Miss Helen M. Gilbert, daughter of F. S. Gilbert, of this town, became the wife of Chas. Fuller, Jr., of Pawtucket, yesterday. Mr. Fuller, the bridegroom, is the son of Chas. H. Fuller, of the Chas. H. Fuller Co., for many years one of the foremost finding houses of the east.

## Attleboro.

R. John Marsh, of C. A. Marsh & Co., is at home after a long trip through the west.

Earle F. Bliss, son of Frank W. Bliss, has taken employment with the Electric Chain Co.

Frank A. Chase, salesman for the Chas. M. Robbins Co., has returned from a trip of several weeks' duration.

James W. Matteson, 25 years a skilled employe of the Horton-Angell Co., died last week at his Summer home, Niantic, Conn.

Harold E. Sweet, of the R. F. Simmons Co., attended last week the inauguration of a new president at his alma mater, Tufts College.

Ralph Kingsley, of the chasing department of Reed & Barton's silver works, has become foreman of a North Attleboro jewelry factory.

Lawrence Abbott, who left the employment of the R. F. Simmons Co. to take charge of the factory of S. O. Bigney & Co., has resumed his former place.

Jesse Carpenter, seventh of the name, son of Jesse Carpenter, salesman for the Horton-Angell Co., has taken a position in the office of the D. E. Makepeace Co.

Mr. and Mrs. E. W. Rhodes are guests of their son, Egbert W. Rhodes, formerly of Rhodes Bros. & Rothschild, Attleboro, manufacturing jewelers, now in business at Seattle.

Edwin A. Fargo, of E. A. Fargo & Co., Taunton, sustained a painful laceration of his right index finger last week while experimenting with a new machine in his factory.

P. J. Cummings & Co. celebrated their 10th anniversary Saturday by giving all the employes an outing at Hodge's Grove, in the north end of the town. A clambake was the main feature, and field sports and other picnic fun served to increase the friendly feeling between firm and workers.

Only one topic of conversation prevails in Attleboro—the "Society Circus," June 27 to 30 inclusive, whereby the whole population joins in a four-day fete to raise funds for its public library. While the women of the town have been the principal managers, the business men have been generous givers. The jewelry manufacturers have donated a quantity of desirable jewelry, and it will be sold at a booth presided over by the wife of T. S. Carpenter, of the Horton-Angell Co. Serving on committees for various features are Joseph G. Hutchinson, Harold E. Sweet, Thomas C. Heywood, Fred L. Torrey and other manufacturers and popular traveling salesmen.

P. Girard, East Grand Forks, N. Dak., recently lost a considerable amount of his stock by a fire.

Charles B. Safford, Kingston, N. Y., on July 1, will celebrate the 50th anniversary of his business career in that city. Edward Mathewson has been in his employ for 40 years, and Foster Dunwoody has been associated with him for the past 20 years. Mr. Safford is also assisted by his son, who is an eye specialist. The veteran jeweler visits New York frequently, and is highly esteemed by all who come in contact with him.



## FESTOON NECKLACES

The increasing demand for high grade Festoon Necklaces has compelled us to make up a larger and more varied line of them than ever before, set in combination with Diamonds, Baroque Pearls, Aquamarine, Topaz, Peridots, Amethysts, Turquoise, fancy Sapphires, etc., etc.

CUFF BUTTONS      LOCKETS  
BROOCH PINS      SCARF PINS  
BRACELETS

**COOPER & FORMAN** OFFICE AND FACTORY  
MAKERS OF DIAMOND JEWELRY 3 MAIDEN LANE, NEW YORK

### REMOVAL NOTICE!

## THE LYONS GEM CO.,

Have Removed to

**35 Maiden Lane, New York.**

A FULL AND COMPLETE LINE OF PRECIOUS SEMI-PRECIOUS AND IMITATION STONES ALWAYS IN STOCK.

Our Specialty is Scientific Rubies.

Local and out of town jobs promptly attended to at reasonable prices. Send us your mountings to be set with matched stones. A trial order will convince you that our prices are right, and our goods select

## Unique Gems

and Semi-Precious Stone

Many fine gems occur as water-worn pebble. These, when polished natural or drilled and polished as beads, form a decided novelty of great beauty and infinite variety of color and can be had in

Carnelian	Agate	Rose Quartz
Chrysoptase	Topaz	Malachite
Jasper	Lapis Lazuli	Amethyst
Tourmaline	Emerald Matrix	

and many other stones. Adapted especially for neck chains, drop pendants, La Vallieres, scarfpins, link cuff buttons, and for any of the newer forms of art jewelry. Prices reasonable; no imitations.

Sample papers sent to responsible jewelers

**LOUIS J. DEACON, Atlantic City**  
During Summer Months, Cape May, N. J.

## There's a Reason

for the success of our

## 20th Century Gold Shell Charm

THE BEST MONEY CAN BUY  
unless a solid gold charm

Insist on having them in your stock  
Made in both gold, and onyx set, fronts

## IRONS & RUSSELL

MAKERS OF EMBLEMS

MAIN OFFICE and FACTORY: 95 CHESTNUT ST., PROVIDENCE, R. I.  
NEW YORK OFFICE: 11 MAIDEN LANE



**TRADE-MARKS** OF THE JEWELRY AND KINDRED TRADES.  
Over 4,000 Marks. Second Edition. Price, \$3.00.  
The Jewelers' Circular Pub. Co., 11 John St., N. Y.

## "PRACTICAL COURSE IN ADJUSTING."

PRICE \$2.50.

ALL JOBBERS OR

JEWELERS' CIRCULAR PUBLISHING CO.

# A NEW MOVEMENT

THE O-SIZE 7 JEWELLED PENDANT SETTING

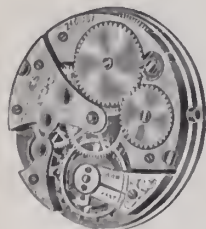

**TAVANNES** *Is*  
**Fully Guaranteed**

FOR SALE THROUGH THE JOBBING TRADE

## TAVANNES WATCH COMPANY

2 & 4 Maiden Lane, New York

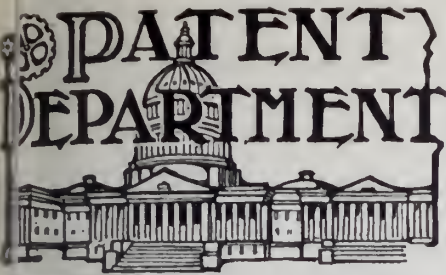

WHICH IS CONTAINED A LIST OF THE LATEST PATENTS GRANTED BY THE UNITED STATES AND GREAT BRITAIN, THE UNITED STATES PATENTS THAT HAVE EXPIRED AND THE REGISTERED TRADE-MARKS.

UNITED STATES PATENTS.

ISSUE OF JUNE 12, 1906.

**22,922. WATCH HOLDER.** HARRY CLARK, St. Paul, Minn. Filed June 7, 1904. Serial No. 211,478.

A holder of the class set forth, consisting of a telescopic inclosing sections, the end of one section being closed and arranged obliquely to its



upper and lower sides to support the holder in inclined position, and an opening passing through the upper sides of said sections.

**22,969. COMBINED BADGE AND WATCH-GUARD.** JOHN S. MARTIN and HARRY N. STOCKTON, Snohomish, Wash. Filed April 24, 1905. Serial No. 257,190.

A device of the class described comprising a body having a rearwardly-extending marginal edge provided with a transverse recess at one end therein, a bar extending through said recess

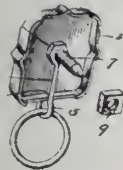

and secured to said body and with an eye at one end extending beyond the body, a threaded pin extending rearwardly of said bar at its inner end, and a clamp-nut engaging said pin.

**22,970. HANDLE.** CHARLES H. MASCHMEYER, Portland, Me. Filed Nov. 18, 1905. Serial No. 287,951.

A handle for receptacles consisting of attachment-sections, a hand-section, insulating-inserts between the adjacent ends of the sections and a

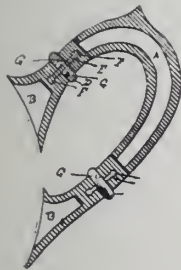

metallic bond having an attenuated body portion and enlarged ends, the body portion passing through the insert and the enlarged ends embedded in the metal of the section.

**23,024. BRACELET.** ANTHONY H. BLISS, North

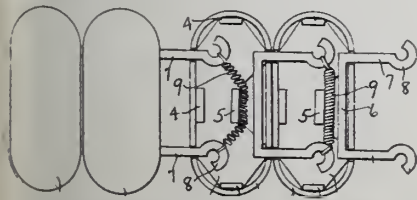

Attleboro, Mass. Filed Feb. 23, 1906. Serial No. 302,412.

In a device of the class described, the combination of adjacent hollow link members, a pair of openings in the sides of each link member, a bar in each link member having its ends bent to form coupling-rods which extend through the adjacent openings into the next link member, a spiral spring connecting the ends of said bar and means for supporting said spring centrally therebetween.

**823,050. TICKET-HOLDER.** GEORGE D. KEMMERER, Wilkes-Barre, and WHEELER B. ARMSTRONG, Plymouth, Pa. Filed Nov. 21, 1905. Serial No. 288,102.

A ticket holder comprising a plate-metal body provided with a longitudinal depression which is concave in cross-section with its side walls round-

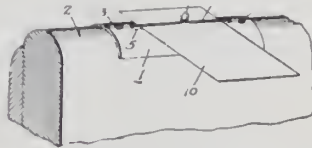

ing upwardly and outwardly merging into the top of the body, and a spring-wire having a substantially circular cross-sectional shape lying longitudinally within the open top of the depression with its ends connected to the body and its intermediate portion free from the body and out of contact therewith, the bottom and side walls of the depression being free from projections.

**823,133. EYEGLASS-HOLDER.** EMIL B. MEYROWITZ, New York, assignor to the Meyrowitz Mfg. Co. Filed Dec. 23, 1901. Serial No. 238,039.

An eyeglass-holder comprising a body portion extending downwardly and outwardly and then downwardly and inwardly, an arm shaped the reverse of the body portion, rigid with and bent over



said body portion, the bend constituting a loop for receiving the spring of a pair of eyeglasses, a pin carried by said body portion, and a keeper for said pin within said loop and constituting an abutment restricting the exit thereof for retaining said spring in place, said loop also constituting a housing for the point of said pin.

**823,135. COLLAR-BUTTON.** HAROLD T. MURPHY, Springfield, Mass. Filed Sept. 5, 1905. Serial No. 276,934.

In a collar-button, a back having an aperture, a post having a head, a pair of T-shaped levers being capable of being disposed along and at opposite sides of the post having their portions adjacent

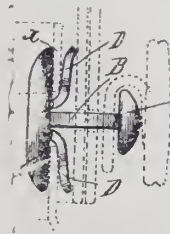

the junctions of the levers proper and their cross members extended through said aperture, and having their cross members located behind the back, and a spring reacting behind the back and said cross members, and against which said cross members press on the swinging of the levers.

**823,268. SAFETY-PIN.** CHARLES W. ENGEL, Pittsburg, Pa. Filed June 7, 1905. Serial No. 264,083.

A safety-pin formed from a single piece of wire bent to form a spring at one end and a substantial D-shaped guard at the other end, the said strand of wire being doubled to form a pin member, and an opposing arm or leg member, the guard being formed integral with said leg or arm member with a part thereof bent downwardly and then inwardly and upwardly at right angles to the pin member, and being crossed over said pin member and then bent downwardly and wrapped around

the leg or arm member, the said downwardly-bent part of said guard thus lying in advance of the

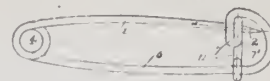

upwardly-bent part and acting as a brace for the same against strain through the pin member.

**823,277. CLASP.** FRED HIRSH, New York. Filed Aug. 21, 1905. Serial No. 275,098.

A clasp consisting of two hinged members and a spring-tongue attached to one of said members and



having at its outer end an inwardly-projecting stud, the head of which is adapted to snap past and engage with an edge of the other of said members.

**823,289. WATCH-HAND REMOVER.** ERASTUS N. PARKER, Springfield, Mass. Filed Dec. 21, 1905. Serial No. 292,801.

A watch-hand remover consisting of opposite tweezer-like members having at their free extremities thin inwardly-turned members, and said device comprising an extension which is laterally

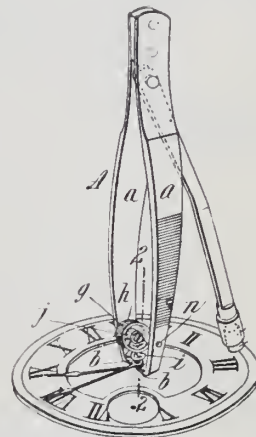

offset from the plane of approaching movements of the said members, and the lower bearing extremity of which terminates outside of and approximately level with the lower ends of the tweezer-like members, and adapted to constitute a fulcrum on a watch-dial, remote from the place of engagement of said members, on which the device may be rocked or swung.

**823,328. FOUNTAIN-PEN.** ALFRED HALL, Chicago. Filed Aug. 18, 1905. Serial No. 274,760.

In a fountain-pen, the combination of an ink-barrel, an annular member adjustably secured to



said ink-barrel, pen-nibs adjustably secured inside of said annular member, and a feeding-tube inside of said nibs.

**823,363. BRUSH.** SIMEON D. PURDY, Richmond Hill, N. Y. Filed Dec. 4, 1905. Serial No. 290,291.



The combination of a brush-ferrule having in-

ternal shoulders, bristles and plugs within the bristles above and below said shoulders and means to draw the plugs toward each other to grip the surrounding bristles against the shoulders.

**823,464. COMBINED TOILET ARTICLE.** ANTON C. EGGERS, New York, N. Y. Filed July 14, 1905. Serial No. 269,743.

In a toilet-kit, the combination of a brush provided with a handle, an independent mirror seated



upon the back of said brush and likewise provided with a handle, said mirror and its handle conforming throughout to the contour of said brush and the handle thereof, and a single independent device for detachably retaining said parts in fixed relation.

#### DESIGNS.

**38,066. BACK FOR HAND-MIRRORS, BRUSHES, AND SIMILAR ARTICLES.** HENRY B. BEACH and HENRY KAYSER, Meriden, Conn., assignors to the International

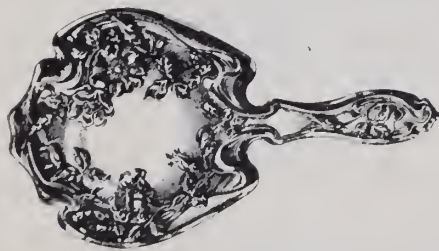

Silver Co., Meriden, Co. Filed April 27, 1906. Serial No. 314,101. Term of patent 3½ years.

**38,067. BACK FOR HAND-MIRRORS, BRUSHES, AND SIMILAR ARTICLES.** HENRY B. BEACH and HENRY KAYSER, Meriden, Conn., assignors to the International

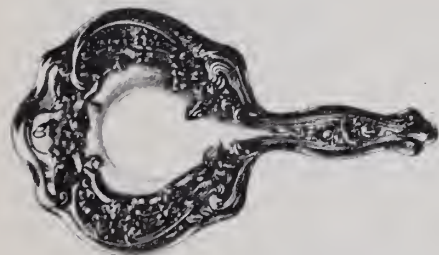

Silver Co., Meriden, Conn. Filed May 8, 1906. Serial No. 315,849. Term of Patent 3½ years.

**38,068. HANDLE OF SPOONS, FORKS OR SIMILAR ARTICLES.** FREDERICK HABEN-SACK, Sag Harbor, N. Y., assignor to the

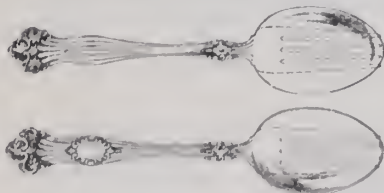

Fahys Watch Case Co., New York. Filed May 4, 1906. Serial No. 315,267. Term of patent 7 years.

**38,069. HANDLE FOR SPOONS, FORKS, OR SIMILAR ARTICLES.** HENRIK HILLBOM, Wallingford, Conn., assignor to R. Wallace



& Sons Mfg. Co., Wallingford, Conn. Filed May 7, 1906. Serial No. 315,089. Term of patent 14 years.

**38,070. TEAPOT OR SIMILAR ARTICLE.**

HENRIK HILLBOM, Wallingford, Conn., assignor to R. Wallace & Sons Mfg. Co., Wall-



ingford, Conn. Filed May 7, 1906. Serial No. 315,672. Term of patent 14 years.

**38,071. BEVERAGE-PERCOLATOR.** GEORGE E. SAVAGE, Meriden, Conn., assignor to Man-



ning, Bowman & Co., Meriden, Conn. Filed April 30, 1906. Serial No. 314,609. Term of patent 14 years.

#### UNITED STATES TRADE-MARKS.

[The following trade-marks have been adjudged entitled to registration under the Act of Feb. 20, 1905, and are published by the Patent Office in compliance with Sec. 6, of said act, which provides: "Any person who believes he would be damaged by the registration of a mark may oppose the same by filing notice of opposition, stating the grounds therefor, in the Patent Office, within 30 days after the publication of the mark sought to be registered, which said notice of opposition shall be verified by the person filing the same before one of the officers mentioned in Sec. 2, of this act. If no notice of opposition is filed within said time the Commissioner shall issue a certificate of registration therefor, as hereinafter provided for."]

PUBLISHED JUNE 12, 1906

SER. No. **12,946. FOUNTAIN-PENS AND OTHER WRITING-PENS EXCEPT GOLD PENS.** THOMAS DE LA RUE & Co., LTD., London, England. Filed, Sept. 25, 1905.



The word "ONOTO" within a border which is shown in the accompanying drawing as of approximately diamond shape with curved corners.

SER. No. **15,464. SPECTACLE AND EYE-GLASS LENSES AND FRAMES.** WILLESTON W. BISSELL, Rochester, N. Y. Filed Dec. 16, 1905.

## TOROIDS

The word "TOROIDS." SER. No. **18,577. PERCOLATORS.** LANDERS,

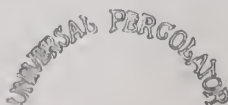

FRARY & CLARK, New Britain, Conn. Filed April 6, 1906.

The word "UNIVERSAL," followed by the word "PERCOLATOR."

SER. No. **18,604. WATCHES, WATCH CASES AND WATCH MOVEMENTS.** D. GRUEN & Sons, Cincinnati, O. Filed April 7, 1905. Used 10 years.

## GRUEN

The word "GRUEN."

TRADE-MARKS REGISTERED JUNE 12, 1906.

**53,709. POCKET-KNIVES.** SIMMONS HARDWARE Co., St. Louis, Mo.

The words "KEEN CUTTER" and a figure wedge shape having three-sided projections at side and on which said words appear. Used 10 years.

Filed Nov. 23, 1905. Serial No. 14,944. Published April 17, 1906.

**53,733. HAT-PINS.** SCOTT-BLAKE Co., Portland, Me.

The arbitrarily-chosen typenated word "CA ON" printed with quotation-marks, all in Gothic type.

Filed Oct. 2, 1905. Serial No. 13,221. Published April 17, 1906.

**53,794. TEA AND COFFEE POTS.** SILVER Co., New York.

The representation of a coffee-pot, the body of which is shown in section with the cover removed and shown in edge view beneath the spout of coffee-pot and with the representation of a nursing-cup held in a woman's hand above the top of the coffee-pot and of boiling water flowing into the said open end from the cup and arising therefrom, together with the words "MARION HARLAND COFFEE POT AND PROCESS COFFEE MAKING" to the left of the hand and Used 10 years.

Filed Jan. 6, 1906. Serial No. 15,941. Published April 17, 1906.

**53,814. TEA AND COFFEE POTS AND COFFEE-URNS.** SILVER & Co., New York.

A side-view representation of a tea and coffee-pot having in a central position the inscription "THE MARION HARLAND TEA AND COFFEE POT" surrounded by an oval border. Used 10 years.

Filed Jan. 6, 1906. Serial No. 15,942. Published April 17, 1906.

**53,817. ALARM-CLOCKS.** THE WM. L. GILBERT Clock Co., Winsted, Conn.

The letter "G," within which appears the word "BEST."

Filed July 24, 1905. Serial No. 10,754. Published April 17, 1906.

**53,819. GOLD FINGER-RINGS.** J. R. WOOD & Sons, New York.

The letter "W" laid on its side, thus "z." Filed June 20, 1905. Serial No. 8,597. Published April 17, 1906.

#### UNITED STATES PATENTS THAT HAVE EXPIRED.

[Reported especially for THE JEWELERS' CIRCULAR-WEEKLY by R. W. Bishop, Patent Attorney, Washington, D. C.]

Issued June 18, 1889.

**405,258. CLOCK-MOVEMENT HOLDER.** J. W. HARWOOD, Somerville, Mass.

**405,339. CARD-CASE.** C. J. BUFFUM, Boston, Mass.

**405,374. SUSPENDERS.** J. R. POLLOCK, Kansas City, Mo.

**405,394. ATTACHMENT FOR CLOCKS.** F. CHASE, Philadelphia, Pa.

**405,458. FOUNTAIN-PEN.** J. D. BRAY, Montreal, Canada.

**405,514. BUCKLE.** W. J. WALTERS, Providence, N. Y.

**405,524. LEAD-HOLDER.** MARCELLUS BAKER, Washington, D. C., assignor to the Federal Pencil Co., New York.

**405,529. BUTTON.** C. A. BRYANT, Wakefield, Mass.

**405,558. SAFETY-PIN.** JOEL JENKINS, Melclair, N. J.

Design issued June 14, 1892, for 14 years.

**21,620. GLASS DISH.** BENJAMIN BENNETT,

JEANNETTE and H. S. McKEE, Allegheny, Pa.  
 Design issued Dec. 16, 1902, for 3½ years.  
 70. PITCHER. J. W. COLLINS, New Martinsville, W. Va.

BRITISH PATENTS.

JUDGMENTS OF SPECIFICATIONS. 1905, FROM THE Illustrated Official Journal.)

ISSUE OF JUNE 7, 1906.

21. SLEEVE-LINKS. J. W. STOCKER, London. Feb. 6.

The buttons in a sleeve link are connected together by means of metal safety-hooks. To each of the parts is attached a metal hook as shown in FIG. IV. and V., one hook opening outwardly, the movable part being kept in position by means of a spring a, Fig. IV., or a spiral spring, Fig. V.,

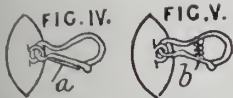

the other hook being of the ordinary inwardly-opening kind. The hooks are attached to the buttons by means of small metal loops which are secured to the bases of the former. In a modification one safety-hook and an enlarged metal loop are used in the place of two safety-hooks. Reference is made to Specifications No. 7515, A.D. 1885, and No. 7814, A.D. 1891.

257. FOUNTAIN PENS. J. Y. JOHNSON, London.—(Eagle Pencil Co., New York, U. S.) Feb. 7.

A self-filling pen, the collapsible rubber or reservoir E, Fig. 4, is fixed to the pen point and is compressed prior to filling by a presser having a shank engaging a recess j in the barrel F at the end of the tubular handle A. Sliding



longitudinally in the plug F is a plunger G with a head H; the narrowed end g of the plunger is coupled to the bar I by a pin l working in a slot i, by a link, or by other means, in such a manner that the outward movement of the plunger causes the reservoir E to be compressed.

45. CLOCKS. F. A. CHANDLER, Leamington, and B. BONNIKEN, Coventry, both in Warwickshire. Feb. 8.

The effective length of the pendulum, if fast or slow, is varied, say, once in 24 hours, by current in a master-clock. The invention is particularly applicable as a substitute for part of the apparatus described in Specification No. 22,858, A.D. 1903, in which a lever J is raised during the day by a magnet which is attracted by an electromagnet J² shortly before the moment for regulation, at which instant it is allowed to fall by cessation of the current.

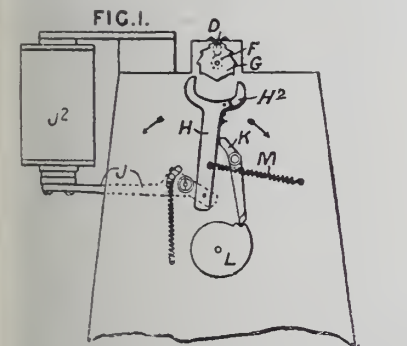

the bar D from which the pendulum is suspended, the curbing-guide below it, rests upon an eccentric F attached to a ratchet-wheel G, which has the teeth on one-half in opposite directions to those on the other. Below this, a fork H is jointed to the electromagnet lever J rests against a guiding stop-lever K, the position of which is determined by a cam L on the hour-arbor. Thus, when the electromagnet lever falls, the fork turns the ratchet-wheel in one direction or the other if the

clock is fast or slow, and so lengthens or shortens the pendulum. If the clock is correct, the fork is directed clear of both sides of the ratchet. The prong H² of the fork is pivotally and yieldingly mounted to allow of its retraction over the ratchet teeth.

2,671. FOUNTAIN PENS. F. DE LA RUE & Co. and E. DE LA RUE, London. Feb. 9.

A pen which can be filled without the use of a separate filler is provided with a piston c, which normally rests at the rear end of the barrel a but can be engaged by the end of a rod b secured to a screw cap b¹. The piston is retained in its normal position by a pin or pins on the barrel which engage hayonet slots c¹. To fill the pen, the cap

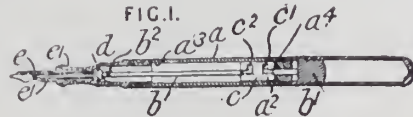

b¹ is unscrewed and the rod b drawn out until a pin b² thereon engages a bayonet slot e² in the piston. On rotation of the rod, the piston is freed from the pins a² and can then be pushed along the barrel until it meets a stop a³. On the rod b being again pulled out, ink can be drawn into the pen. A vent a⁴ in the barrel permits the escape of any ink which may pass behind the piston. The head of the rod b forms a valve which co-operates with a seat d to regulate the supply of ink. The feed e has two ink-ducts e¹, one above and one below the nib.

2,678. GOGGLES; EYE-PROTECTORS. A. E. SALT, London. Feb. 9.

To secure the ventilation of goggles, each eye-cup is made with a corrugated edge b, against which the glass c is held by a ring or flange d¹,

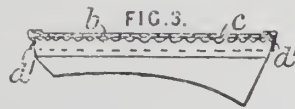

which is sprung into place, projections on the ring engaging recesses in the cup. Air passes beneath the ring and enters the cup along the surface of the glass c.

Complete specifications accepted May 30, 1906. 1905.

- 17,364. COFFEE URN. HEIBEL.
- 18,109. SETTING CLOCK-HANDS. PARKS.
- 18,370. CLASP. STANLEY.
- 19,934. CANDLESTICK. RUDD.
- 23,204. UMBRELLA-CASE. VON SCHOON-CORBITZTHAL.
- 2,416. MATCH BOX. KING.
- 2,597. FOUNTAIN PEN. MAWSON.
- 4,013. HAT-PIN. LILLEY.
- 5,525. FINGER RING. BROWN.
- 7,735. HAT-FASTENER. SEIDENTOP.
- Applications filed May 21 to May 26, 1906.
- 11,847. JEWELRY. ALFRED NOEL, London.
- 11,886. HAT-FASTENER. J. M. PORTER, MARTHA J. BULLIVANT and T. H. MUSCROFT, Cross Gates, Leeds.
- 12,021. HAIR-PIN. MAUD M. GUBBINS, Ilfracombe, Devon.
- 12,036. INKSTAND. GEORG SPELMANN, Bremen, Germany.
- 12,144. FOUNTAIN PEN. N. H. RAMSDEN, London.
- 12,197. OPERA GLASS. A. L. VINCENT, London.
- 12,202. SAFETY-PIN. B. O. BRENDDEL, London.
- 12,240. INKWELL. JAMES MARSHALL, Westminster, London.
- 12,343. ORNAMENTS METAL. GEORGE SONNENTHAL and K. B. LANDER, London.

C. R. Diaz was recently taken into custody and imprisoned in Mexico City, Mex., on a charge of misappropriating \$50,000 worth of diamonds which had been entrusted to him by his former employers, who conducted a jewelry establishment under the name of La Esmeralda.

# BUYERS' INFORMATION BUREAU

Questions as to the makers of certain lines of goods, where to buy certain lines, where certain kinds of work are done, the owners of certain trade-marks and other matters relating to the buying branch of a jewelry business will be cheerfully answered under this department. All queries are also answered promptly by mail.

WASHBURN, N. Dak., June 15, 1906.

Editor of THE JEWELERS' CIRCULAR-WEEKLY:

Who is the importer of a paper cutter heavily engraved and with a thin, flexible blade which has a magnifying glass in the top? W. A. P.

ANSWER:—John Scheidig & Co., 50 Maiden Lane, New York.

RIVERSIDE, Cal., May 24, 1906.

Editor of THE JEWELERS' CIRCULAR-WEEKLY:

Where can we procure a United Daughters of the Confederacy pin? P. B.

ANSWER:—From J. E. Caldwell & Co., 902 Chestnut St., Philadelphia, Pa., but can only be secured under authority of the officers of this organization.

COLUMBUS, O., May 29, 1906.

Editor of THE JEWELERS' CIRCULAR-WEEKLY:

I want to purchase three New York Standard electric clocks; who makes these clocks? C. E. R.

ANSWER:—New York Standard Watch Co., 193 Woodward St., Jersey City, N. J.

CHAMPAIGN, Ill., May 28, 1906.

Editor of THE JEWELERS' CIRCULAR-WEEKLY:

Who makes the Nurnberg, Germany, souvenir spoons? We want one which has the Iron Maid on the top of the handle. F. & C.

ANSWER:—A complete set of these spoons is made by the Gorham Mfg. Co., Fifth Ave. and 36th St., New York.

HOMESTEAD, Pa., June 2, 1906.

Editor of THE JEWELERS' CIRCULAR-WEEKLY:

Can you give me the address of the manufacturer of solder and flux to use in soldering aluminum articles, and the address of parties who make tempered copper or a compound for tempering such? J. N. H.

ANSWER:—Aluminum solder may be secured from the Janney Sternmetz Co., Drexel building, Philadelphia, Pa.; Edward N. Cook Plate Co., 144 Pine St., Providence, R. I.; New Jersey Aluminum Co., Springfield Ave. and 19th St., Jersey City, N. J.; Aluminum White Metal Co., 336 Broadway, New York. Tempered copper may be secured from the Eureka Tempered Copper Co., North East, Pa., and the Mansfield Tempered Copper Co., Mansfield, O.

BOOTHBAY HARBOR, Me., June 3, 1906.

Editor of THE JEWELERS' CIRCULAR-WEEKLY:

Can you tell me who puts miniature photographs on watch cases? Also the address of the manufacturers of the Imperial fountain pen and the Paul E. Wirt fountain pen? W. F. D.

ANSWER:—Goldstein Engraving Co., 45 Maiden Lane; N. J. Felix, 16 John St., and L. A. Cohen, 28 E. 22d St., all of New York, do miniature photography on watch cases. The Imperial fountain pen is made by Aiken, Lambert & Co., 19 Maiden Lane, New York and the Wirt pen by the Paul E. Wirt Fountain Pen Co., Bloomsburg, Pa.

# Mainspring Don'ts

## Simple Hints for Those Who Handle Mainsprings

---

Don't fail to provide yourself with the best mainspring winder that can be obtained. See that the hooks on all arbors of the winders are no longer than the thickness of the thinnest spring, and thus avoid kinking, and therefore unnecessary breaking of mainsprings.

Don't use a mainspring that is too long, because it fills the barrel and prevents that part, or the mainwheel, from making the required number of revolutions, with the consequence that the watch will not run as it should after each winding.

Don't use a mainspring that is too strong, because it will set, increase the percentage of breakage and injure the watch.

Don't use a mainspring that is too wide, and be sure that the tip and brace do not extend beyond the limits of the cover and barrel.

Don't forget that a mainspring should not occupy more than one-third the diameter of the barrel, thus leaving two-thirds to be divided between the arbor and winding space, to enable the watch to run about thirty-six hours.

Don't expect a mainspring to be flat if you put it in the barrel with the fingers. This method usually injures the spring, gives it a cylindrical form, and thereby increases the friction in the barrel.

Don't bend the inner or outer end of the mainspring with flat-nosed plyers, but provide yourself with specially made round-nosed plyers which will give a circular form to these parts, prevent short bends, contract the inner coil, and thus secure a closer fit to the barrel arbor without injuring the spring.

Don't expect other than a properly fitted flat mainspring with rounded edges to produce the least friction in the barrel, allow the greatest amount of power to the train, and give the best results as to time, service, etc.

Don't expect a mainspring to always endure extreme changes in temperature, or electrical disturbances, or straightening at full length, or neglect from lack of cleaning and oiling.

Don't expect a watch that needs cleaning or other repairs to run satisfactorily by merely putting in a new mainspring.

Don't expect a mainspring to plough through too much dirt.

---

## Waltham Watch Company

Waltham, Mass.



# THE HOROLOGICAL REVIEW.



## Chimes of Grace Church, New York.

By C. W. COUMBE.

"Ding a ding a dong,  
Ding a ding a dong,  
Listen to the echo of the bells,  
Listen to the chimes on Sunday morn,  
Listen to the old church bells."  
—Old Southern Refrain.

ALMOST as much prose and verse have been dedicated by literary and poetic talent among the Christian nations to the church bells as to the sacred edifice that contains them. Giving vocal utterance to the religious sentiment of the composer, they ring out to their distant surroundings full-throated melodious expression, they may justly claim all the human sentiment that attaches to the most luminous harmonies of the organ in the world below.

Proclaiming abroad their stately verses the numerous sacred events that fill the ecclesiastical calendar, the deep tones of the church bells enhance in each civilized breast a reverence and respect second only to that felt on witnessing the sacerdotal rites performed in the temple beneath. The reverence accorded these deep-voiced angels of the creed comes back through the mist of ages to those years of their original usage in sacred rights far dissimilar to the present—to a time far behind the beginning of the Christian era; to the time when in China and other eastern lands the legions of wicked spirits on this earth were driven off

from tormented souls by the resonant voice of the big bell.

And in our present day of boasted enlightenment and culture what can exorcise the perturbed spirit of man from despondent mood better than the merry chimes rung in our American churches or the glad some carillon of European ministers.

"Low at times, and loud at times,  
Changing like a poet's rhymes,  
Rang out the beautiful wild chimes

From the belfry in the market of the ancient town of Bruges."

The poetic soul of Longfellow was indeed moved to ecstasy when he heard those chimes of Bruges (probably the finest in the world), and they brought to the surface of paper words that go ringing through the years. But if America cannot boast of many perfect chimes containing numerous bells like those of Belgium, France and Germany, at least she has shown progression in equipping her steeples with some admirable representative sets of six, eight and even 10 melodious metallic songsters that are well able to command respect, even of Europeans.

Prominent, if not excelling among these, can be named the peal of 10 bells located in the steeple of New York's historic Grace Church, the beautiful sacred edifice situated on Broadway, between 10th and 11th Sts.

The centenary of the laying of the foundation stone of the first Grace Church erected on this spot is but a few months past, for that event took place on the 18th of March, 1806. The church was rebuilt and consecrated in 1846. In 1873 the beautiful chime of bells was founded that now ring out daily their lovely notes. They are the famous "Troy Bells," wrought in the Meneely Bell Foundry, of Water-vliet (formerly known as West Troy), N. Y. This maker's bells are pealing all over the United States and Canada, and in South America their melodious sound is heard. For this concern, with

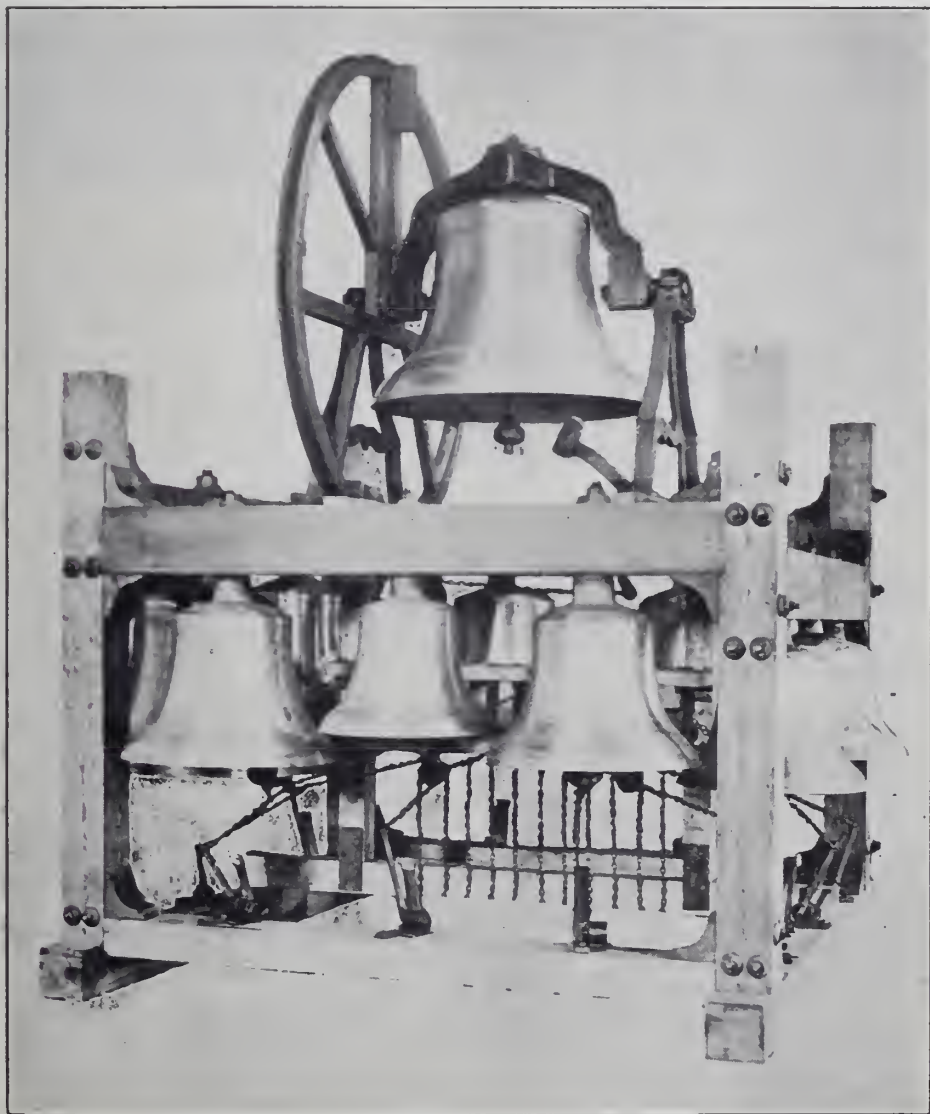

THE SONOROUS CHIMES IN GRACE CHURCH, NEW YORK.

# Wise Dealers Set Store by the ELGIN



The wide-awake dealer knows the value of a good stock of Elgin Watches. He knows that they are a good criterion by which to have the public judge his store.

He knows that Elgin customers are satisfied customers, and that satisfied customers are the very foundation of successful business. The

## ELGIN WATCH

is the World's Standard Timekeeper

See Jobbers' List for prices or write the Company.

Every dealer is invited to send for the Elgin Art Booklet, "Timemakers and Timekeepers," illustrating the history and development of the watch.

**ELGIN NATIONAL WATCH COMPANY,**

Factories, Elgin, Ill., U. S. A.

General Offices, 131 Wabash Ave., Chicago.

New York Office, 11 John Street.

San Francisco Office, 206 Kearny St.

putation second only to those of the great foundries of Europe, and itself dating back to 1826, has supplied very many of the best-toned bells in the clock towers and steeples of the New World's continent. When a child is born about the earliest time is to determine on the name it is to carry through life, and to then christen it with that name. When to a church patron the determination is born to donate a bell to add to the peal, the first thing to be thought out is the "inscription" that is to be cast on that bell. This "inscription" is to be to the founder, together with the order, the bell-founder does the rest. The custom of casting an inscription on every bell comes to us from unrecorded antiquity. And this memorial usage was always carried out in the casting of the bells that constitute the chimes of Grace Church, each bell carrying throughout its long and useful life the name of its munificent donor. Passing through the main entrance to the church, situated under the tower, to left and right, the worship-attending service will find a marble table. The inscription on our left reads:

The Bells in This Tower are Memorial.  
 No. 1.  
 The Great Bell  
 of  
 The Rev. Thomas House Taylor, D. D.,  
 sometime Rector of this Parish during whose  
 rectorship this edifice was erected  
 and consecrated.  
 A Faithful and Affectionate Pastor.  
 A Godly and Well Learned Divine.  
 A Blameless and Fearless Man.  
 The people to whom he ministered for 33 years  
 here record their grateful memory of his  
 labors and his virtues.

✠

and to the right on a similar entablature  
 read:

The Bells in This Tower  
 are  
 Memorial.  
 No. 2 of John David Wolfe, some-time Senior  
 Warden of this Church, the Gift of  
 his Daughter.  
 No. 3 of George Barclay, some time  
 a Warden of this Church, the Gift  
 of his Daughter.  
 No. 4, Edward Renshaw Jones, some time a  
 Warden of this Church, and  
 Edward Jones, some time a  
 Vestryman of this Church.  
 No. 5 of Mrs. Mary A. C. McCollum,  
 the Gift of her Husband.  
 No. 6 of Wm. Seward Roberts,  
 the Gift of his Mother.  
 No. 7 of Julian Broome Livingston,  
 the Gift of His Parents.  
 No. 8 of Hy. A. Schermerhorn,  
 the Gift of his Mother.  
 No. 9 of Alfred H. Easton,  
 the Gift of his Widow.  
 No. 10 The Children's Bell,  
 the Gift of Sarah Marsh Auchincloss.

The weight of each of these bells separately, starting from No. 1, the "Great," ending at the "Children's" bell, is: 25 pounds, 2,000 pounds, 1,398 pounds, 18 pounds, 873 pounds, 622 pounds, 528 pounds, 433 pounds, 353 pounds and 267 pounds.

Time was, and that not very far back,

when the duty of tolling a single bell fell to the sexton of the church. As the Ingholdsby Legends inform us, on the decease of a church member,

"The Parson told the Sexton  
 And the Sexton tolled the bell."

And the ringing of the chimes devolved on the "bellringers," who, each in turn, clutched and pulled his individual rope. But those bell-ringing antics, often portrayed by artists of that day on canvas and paper, have passed away except in out-of-the-world villages, where times and customs cling. These strenuous methods have given place to the mechanical devices of (1) striking the bell with a hammer, (2) chim-

Longfellow) and generally in Belgium—work from a "barrel" both in lifting and releasing. The accompanying illustration displays a Meneely chiming "stand" with its levers.

But even the age of machinery is fast passing and is giving place to electric power control. And numerous devices have been invented for the electric ringing of church bells. Experts mostly declare such methods a failure so far. That is to say, with one exception, and this is the Grace Church chime electrification by G. F. Attwood, of Orange, N. J., installed in 1892.

Speaking of electricity makes one's thoughts revert to Thomas Edison, who



A CHIMING STAND, WITH LEVERS.

ing by a carillon machine, (3) chiming through external control and timing also from a master-clock.

In nearly all the later mechanical systems the bells are stationary and struck-labor is saved, precision is gained and time-honored practices are thrown to the winds. But, as usual in such cases, these innovations are at a loss of quality, and one might say quantity, for when a bell is swung its vibrations carry somewhere about twice as far as when struck. Thus, principally on account of the mouth of the bell being directed horizontally, the sound travels uninterrupted. And again there is a richness imparted to the sound of a bell when swung that is largely lost in the striking action.

But "labor saving" is our motto, and these days we are grasping for cheap tones, whereas our ancestors were willing and ready to pay for and listen to and admire the richer melody of the swinging peal. The "carillon" machines more or less in vogue in Europe—the one at Bruges (sung of

some time after listening to the Grace Church chimes declared they were the only chimes that had ever been heard "all over the world." He had had phonography records made and had sent them all over the world to be chimed in every clime.

Miss Bertha Thomass, besides acting as the talented assistant organist of Grace Church, deftly manipulates the chimes keyboard (which is arranged exactly similar to a piano keyboard), located in the small vestibule, on the right as you go into the building through the main office.

The chimes are pitched in E flat and afford three keys to play in. Miss Thomass says she is able to play over 400 hymn tunes on those 10 bells. She rings out each season of the year, besides playing for numerous ceremonies, such as wedding bells, and each Sunday rings the "Grandsire, Triple Changes." By the bye, do you know what it is to "ring the changes" that you read about in older standard works? It is a mathematical problem, and to look over a

# THE PUBLIC IS “MUCK RAKING”

Just at present the great American people are in the “Muck-Raking” mood.

They are pondering over the trusts—busy figuring out how and why they pay too much for things.

The public is thinking this about the cost of watches, Mr. Jeweler—and, as a matter of fact, many people are every day finding out that there *is* a point in the price of watches where real watch-service—real time-keeping quality ends.

Our jewelers' sales form a good criterion to this increasing public watch-wisdom, and they show enormous increases for the

## New England

### The Watch for the Great American People

We are helping this public awakening all we can—with *advertising*. We're talking to the public about watch-cost and real watch-service. This Fall we will tell the New England Watch story to one-third of the entire population of the United States.

Now, Mr. Jeweler, thousands of people are going to be convinced—are now convinced that they want a New England Watch. These people are writing us by thousands. But we don't sell to these people direct. These sales are made wholly through the nearest jeweler who sells our line.

Do you want your share of these sales? Some of your customers are writing us. Some of your competitors' customers are writing us. May we send them into *your* store to buy?

Then write us for details of our plan. Learn how we are planning, with an enormous advertising expenditure, to create Fall and Holiday business for you.

**THE JEWELER WHO HANDLES NEW ENGLAND WATCHES  
IS GOING TO HAVE THE LEAD DURING THIS FALL AND  
THIS CHRISTMAS SEASON. OUR NATIONAL PUBLICITY  
WILL STIR UP THE TRADE.**

Let us be partners and co-operate with you. Write us now for details of how we are planning to work *with you* and *for you*.

Address

DEPARTMENT OF PUBLICITY

**New England Watch Company**  
**WATERBURY, CONN.**

When change ringing would remind you of logarithms. As a simple example take a peal of three bells, and it permits "changes" thus:

1-2-3  
2-1-3  
2-3-1  
3-2-1  
3-1-2  
1-3-2

Four bells ring 24 changes; five bells ring 120 and so on. It was calculated that it would take 91 years to ring all the changes on five bells, ringing 20 strokes to the minute. And the peculiar technical nomenclature of those changes makes quaint reading. Plain bob, grandsire, triple bob and anchor. The changes rung on five bells are called doubles; on six bells, minor; on seven bells, triples; on eight bells, major; on nine bells, caters; on 10 bells, royal; on 11 bells, cinquies, and on 12 bells maximus. Fifty years ago the entire set of Grand-riples was rung out in an English style by bellringers (not machine). It takes over three hours to peal. We presume that Thomass limits her Sunday performance to a portion of the changes, or she must suffer and cause suffering to others, probably keeping those 10,500 pounds of ringing melodious metal playing, or must at least call it working, all that time.

**Experiments Recently Made With a Seconds Pendulum.**

Read to members of the Municipal School of Technology by T. D. WRIGHT.  
(Continued from issue of May 30.)

From the beginning of 1905 a more systematic observance of the behavior of the pendulum was maintained, and an almost unbroken daily record preserved of the temperature, the barometric pressure and the arc of vibration. At this time it was noticed how consistently the rate of vibration increased with higher temperatures inside the closed clock case; and we now know that with this pendulum an increase in the temperature of 25 deg. F. is always accompanied by an increase of the total arc of from .2 deg. to .25 deg. One of my friends suggested that this might be due to changes in the oil, but I do not. I have lubricated the escape wheel with Kelly's oil, with Mobius's oil, with vaseline, with vaseline and oil mixed; I observed the arc with all, and found the same kind of change, with the lubrication fresh or stale. Reid, in his "Treatise on Clock and Watch Making," p. 132 (1875), mentions the phenomenon, and attributes it entirely to the alteration in the elastic resistance of the spring. He says: "In any changes, however small, in the length of the pendulum spring, will be easily perceived in the extent of the arcs of vibration, whether arising from different temperatures or different thicknesses." I am not sure that Reid was even partly correct in his deductions, for I find on referring to the notes of 1904, that with the same spring, which had a much greater rate of movement than the later ones, the total arc of vibration was larger than with the weaker ones. I now considered the effect of temperature on the pressure and density of the atmosphere in the case. Mrs. Baker kindly lent me two aneroids, compensated for temperature, and reliable.

One was placed inside the case, the other was placed, at the same level, outside the case.

Constant observation was taken of the readings, and the places of the two barometers were exchanged from time to time in case of any error in either, but at no time during the three weeks that were spent in this way was a difference of about 25 deg. in temperature during the whole time. The case was not really airtight, and although the heated air inside the case must surely have been less dense than the colder air outside, it registered the same pressure, and was apparently just as susceptible to external barometric changes.

I had hitherto associated pressure and density as necessarily proportional to one another, but, has pressure alone anything at all to do with resistance to the motion of the pendulum? In the experiments on the effects of altered pressures on the vibrations of balances made by Dr. Guillaume and Mr. Ditisheim, in those made by myself, and in those recently made by Dr. Chree at the Kew Observatory, the change of pressure, in every case, was produced by adding to, or subtracting from, the quantity of atmosphere in the airtight receiver. Change of density in these instances must have accompanied change of pressure. In the heated clock case where the higher temperature must drive out some of the air, and leave the remainder less dense, is it of such a nature that in spite of its lessened density it can transmit the same pressure to the same level as before? I am inclined to the opinion that change of density is the main cause of variation of arc.

Whatever the cause, or causes, there is no doubt of the considerable effect on the arc of this pendulum. With an .8 lb. driving weight on a double line, the total arc at a temperature of 63 deg. F. = 4.4 deg. at a temperature of 90 deg. it = 4.65 deg. With a 6 1/4-lb. weight the arc at 63 deg. = 4 deg. barely, at 90 deg. it = 4.2 deg. With a 3 lb. 11 oz. weight the arc at 63 deg. = 3.1 deg. barely, at 90 deg. it = 3.2 deg. fully. These are only approximate arcs, as the degree plate is only divided into tenths of a degree, and I have no telescopic or microscopic means of measuring the arcs; but the changes are so noticeable, and follow the changes of temperature so quickly, that they admit of no doubt.

During this time the temperature errors were being observed, and although the error was not now so large as at the beginning, it was still nine seconds per week faster at 90 deg. F. than at the temperature of the room. The mild steel tube was removed, a new one of half the length substituted, and an equal length of third quality nickel steel tube added. It still gained in the heat about six seconds per week, so the whole of the mild steel tube was removed, and 4.2 in. of the third grade nickel steel substituted. The gain in heat was now barely three seconds per week. On May 30, 1905, there was a storm, whether that had any influence on the pendulum is unknown, but from that time forward it began to lose on its rate in an unaccountable way. Not suspecting any change in the nickel steel we made no

further temperature tests, but kept the clock going at the normal temperature until it appeared to maintain a steady rate. On July 26 the line broke, letting the weight fall about 2 ft. to the bottom of the case. We fitted a new line and found a suddenly developed loss of eight seconds per day on the rate; this was maintained, so we had to screw the nut up nearly half a turn to bring it to time again. The movement was taken to pieces, the condition of the oil examined, and everything carefully overhauled, but nothing could be found in the clock itself to account for the altered rate.

The temperature tests were resumed, and to my astonishment the loss in the higher temperatures was now 22 seconds per week instead of the gain of three seconds. The nickel steel tube was removed, the original mild steel tube 4.2 in. long replaced, and at the present time, under exactly similar conditions to those of about a year ago, the clock is losing three seconds per week in heat, instead of gaining two seconds per day. Whether this condition will be maintained, or whether it will undergo further change, it is impossible to foresee. The observed rates at the commencement of the trials indicate an actual contraction of the nickel steel in heat; the recent ones show a decided expansion. Is there any stage of development where the co-efficient of its expansion will remain constant? If not, it is useless for our purpose.

Three features of these experiments deserve the consideration of the clockmaker. Firstly, the effects of different suspension springs on the isochronism of the vibrations. With the long thick spring we had a loss in the long arcs of six seconds per day, with the shortest of the thin springs we found a gain in the long arcs of six seconds per day. It must therefore be possible to find such a relation between the dimensions of the spring and the weight of the pendulum, as to obtain perfect isochronism for such variations of arc as a regulator pendulum is subject to. No great variation was produced by enlarging the isochronal hole in the spring, either upwards or downwards, but as we started with a large hole that allowed of little extension in either direction, our experiments are indefinite in this respect, and the question deserves further investigation. Secondly, the effect of change of temperature on the arc of vibration in the closed case, and the probable causes of these changes.

In the notes made in August, 1904, when the temperature was raised by heating the whole room, no such increase of arc took place, and I find it noted several times that there appeared to be a small diminution of arc in the higher temperature, certainly at no time during those three days did the arc increase in heat. I am puzzled to account for this curious fact. Had the change of arc been due to alteration in the oil, or in the elasticity of the spring, there appears no reason why the heating of the open room should produce any different effect to the heating of the closed case.

(To be continued.)

W. C. Godard, Dayton, Wash., has sold out to E. L. Gard.

For *BEAUTY* of *DESIGN*, *PERFECTION* of *FINISH* and *RELIABILITY* Combined with *Moderate Price*

# TRENTON WATCHES ARE UNEQUALLED



No. 140. Bridge Model, 16 Size, 15 Jewel, Hunting and Open-Face, Pendant Setting.

A sample line is convincing. They are pendant setting in all sizes, fitting regular pendant setting cases, decorated dials and Louis XV hands.

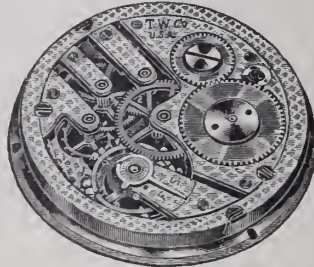

No. 320. Bridge Model, 12 Size, 7 Jewel, Hunting and Open-Face, Pendant Setting.



No. 100. Bridge Model, 0 Size, 7 Jewel, Hunting and Open-Face, Pendant Setting.

A NEAT SIGN  
OR ADVERTISING  
BOOKLET FOR  
THE ASKING

JOBBER SELL  
TRENTONS.

PRICE LIST ON  
APPLICATION.

Manufactured and Guaranteed by

**Trenton Watch Co., - Trenton, New Jersey.**

## Guinand's Reliable Split Timers and Split Chronograph Watches.

in Nickel, Gun Metal, Silver and Gold Filled Cases.

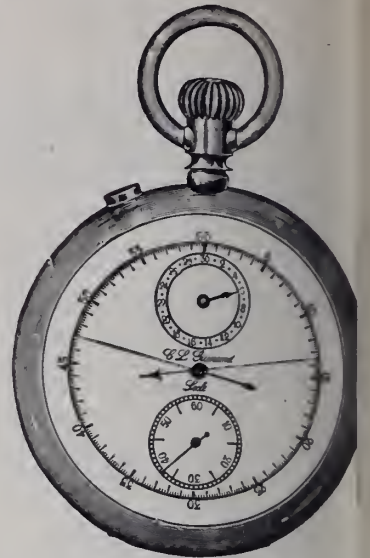

**JULES RACINE & Co.**  
EXCLUSIVE IMPORTERS.

Chicago Office,  
103 State Street.

New York Office  
37 Maiden Lane.

For Sale By All Jobbers.

## SETH THOMAS CLOCK COMPANY.

Established 1813.

### EMPIRE No. 26.



Metal Case,  
GOLD PLATED  
and Lacquered.  
Beveled Plate Glass  
Front and Sides.  
Height, 14 1/4 inches.

EIGHT DAY  
HALF-HOUR STRIKE  
CATHEDRAL BELL  
4-INCH PORCELAIN  
DIAL  
List Price, \$42.50

## SETH THOMAS CLOCK COMPANY,

51 Maiden Lane, New York.

70 Wabash Avenue, Chicago.

## CRANBERRY LAKE REGION OF THE ADIRONDACK MOUNTAINS

a section full of large fish is described in New York Central Lines Four-Track Series No. 32 which contains a beautiful map of this region printed in four colors. Copy will be sent free, postpaid, on receipt of a two-cent stamp by George H. Daniels, Manager, General Advertising Department Room 61-A, Grand Central Station, New York.



TAKE YOU TO THIS REGION FROM EVERY DIRECTION

C. F. DALY Passenger Traffic Mgr. NEW YORK  
W. J. LYNCH Passenger Traffic Mgr. CHICAGO

## "PRACTICAL COURSE IN ADJUSTING."

PRICE \$2.50.

ALL JOBBER S OR

JEWELERS' CIRCULAR PUBLISHING CO.



# ZENITH

## MOVEMENTS

Give the

**RIGHT TIME  
EVERY TIME  
LIFE TIME**

For a

**Grand Prize, Paris Exposition, 1900**

Made in O size, 12 size, 16 size, all grades  
Hunting or Open Face, Pendant Set

INTRODUCED FOR THE FIRST TIME IN AMERICA, THOUGH ONE OF THE BEST KNOWN WATCHES IN EUROPE FOR GENERATIONS

Manufactured by

**GEORGES FAVRE-JACOT & CO., Locle, Switzerland**

HIPP. DIDISHEIM & BRO., Sole Agents, { 49 MAIDEN LANE, NEW YORK.  
COLUMBUS BUILDING, CHICAGO.

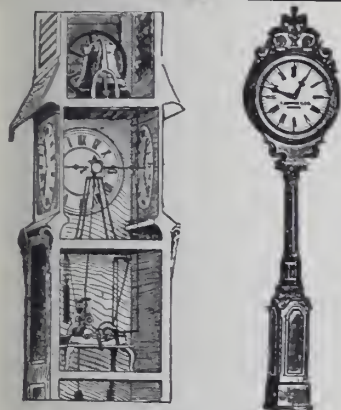

MAKERS OF

**Tower and Street Clocks**

For particulars write us, mentioning The Jewelers' Circular-Weekly.

**E. HOWARD CLOCK CO.,**

ST. 1842. BOSTON, MASS., U. S. A.

**JACOB BASCHKOPF,  
DIAMOND SETTER,**

LETTER AND MONOGRAM

**ENGRAVER,**

9-13 MAIDEN LANE,

NEW YORK

**TRADE-MARKS**

OF THE

**JEWELRY and KINDRED TRADES,  
PRICE \$3.00.**

**THE JEWELERS' CIRCULAR PUB. CO.,**  
11 John St., Cor. Broadway, New York.

## 46 out of 99 PRIZES

were awarded to

**PATEK, PHILIPPE & CO.**

In the Timing Contest of the Astronomical Observatory in Geneva, for the year 1905, comprising: The only First Unique Prize for Best Average Running; 2 First Prizes out of 3; 5 Second Prizes out of 10; 8 Third Prizes out of 18; 9 Fourth Prizes out of 24; 10 Honorable Mentions out of 23; 11 Simple Mentions out of 21. 11 Manufacturers participated.

68 NASSAU ST., NEW YORK.

GENEVA, SWITZERLAND.

**AUDEMARS, PIGUET & CO.,**  
BRASSUS and GENEVA.

Manufacturers of Superior

**Plain and Complicated Watches.**

Represented by

**A. WITTNAUER CO.,**

9-11-13 Maiden Lane,

NEW YORK.

**JULES JÜRGENSEN**

**Watches and Chronometers**

PARIS—"THE GRAND PRIX" - 1900

**SOLE**

RUDOLPH & SNEDEKER,  
65 Nassau St., New York

**AGENTS**

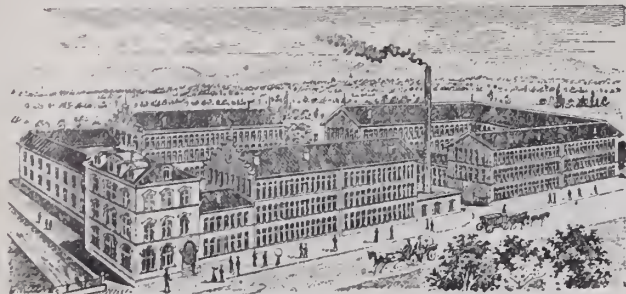

This illustration shows our main factory exactly as it exists, where 3,000 complete watches are made daily.

# LANGENDORF WATCH CO.

CHAUX-DE-FONDS, SWITZERLAND.

It will be of great interest to every jeweler to learn that we are devoting our full attention to this market. The existing conditions in the watch trade have convinced us that there is a long felt want for moderate priced, but accurate Swiss Watches.

We wish to call your attention to our LONVILLE MOVEMENT. It has a lever escapement and is being made in Os, 12s and 16s, fitting perfectly all American cases. This movement is salable and profitable. Our Watches and Movements will be introduced in this market bearing the following names:

- |          |          |
|----------|----------|
| SOLDALE  | HIGHMERE |
| BONDALE  | LONVILLE |
| CLAREFAX | NAMTOC   |
| PEARLHAM | LADY MAY |

SOLE AGENTS FOR UNITED STATES,

**BYRON L. STRASBURGER & CO.,**  
17 Maiden Lane, New York, N. Y.

## The Carmen Watch Bracelet

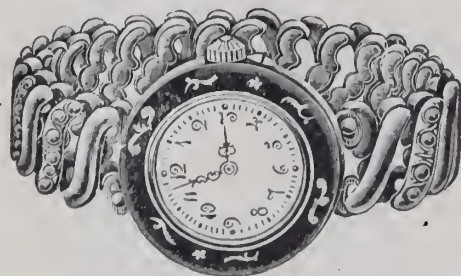

**GOLD FILLED**

WITH ENAMEL BEZEL ALL  
SHADES OR PLAIN GOLD FILLED

**BOTH BRACELET AND WATCH  
ABSOLUTELY GUARANTEED**

During the present great vogue of Bracelets, Jewelers  
will find these a profitable novelty to handle.

**HIPP. DIDISHEIM & BRO.**

Chicago Office,  
Columbus Bldg. 49 Maiden Lane, New York

IF IT'S A  
**ROY**

TRADE MARK  
IT'S STANDARD



O Size Bassine Engraved  
Cases, made from assayed  
Gold, quality as stamped.

**ROY WATCH CASE  
COMPANY,**



21-23 Maiden Lane,  
NEW YORK.

SAN FRANCISCO.  
LONDON, ENG.



# SUMMER WATCH-SELLING CAMPAIGNS

**M**IDSUMMER may witness some falling off in the sales of ordinary lines of Jewelry. Such a staple article as the Watch, however, is less affected by the changing seasons. Is not this, therefore, a good time to emphasize Watches? Opportunity is afforded to appeal, not merely to your regular constituency, but to the great army of tourists and Summer visitors. Such activity paves the way for larger business the coming season.

## J. W. FORSINGER,

LEADING AMERICAN WATCHES AND MOVEMENTS

CHICAGO  
103 STATE ST.

NEW YORK  
2 MAIDEN LANE

## Sessions Clocks

Superior finish. Reasonable prices.

Have you seen our

**New and Exclusive Designs**  
in Mantel and Hanging Clocks?

Write for Catalog and supplement.

### The Sessions Clock Co.

Main Office and Factories,  
Forestville, Connecticut, U. S. A.

New York Salesrooms,  
37 Maiden Lane.



## WHOLESALE

# DUEBER-HAMPDEN COMPLETE WATCHES

## WM. C. PENFOLD CO.

WHOLESALE JEWELERS

AND AGENTS FOR DUEBER-HAMPDEN WATCHES

818-820 Chestnut St., Philadelphia, Pa.

The conceded friend makers for the retail dealer. We are certain that we can help you make customers if you will write us for prices on Chains, Rings and all kinds of High-Grade Jewelry.



## Greatest Traveling and Desk Watch

Runs eight days with one winding.  
Anchor movement and fine timepiece.  
Back flies open and stands firm.  
Can be closed and put in pocket.  
Come cased in Gun Metal—Artistic  
German Silver and Damaskeened.

ALSO NOVELTIES IN WATCH BRACELETS  
in SILVER, GOLD FILLED and SOLID GOLD

Write us for information if interested in  
the new season's offerings.

**KLIPPER BROS.**

59 Maiden Lane - NEW YORK

A Complete Line of the Celebrated

## NARDIN WATCHES

Thin Minute Repeaters, Split Seconds, Movements fitting  
American Cases, Ship Chronometers and Torpedo Boat Watches  
can be secured through

**R. NEWBURGH**

Sole Agent

12-16 John Street

NEW YORK

Manufacturer of the Current Grade Colbert Watch

## “PERFECTION”



The diamond pointed lens drill that has proven itself,  
beyond question, the best lens drill on the market is  
patented. Made in three qualities and sizes.

X \$5.00. XX \$6.00 XXX \$7.00.

MENDES CUTTING FACTORIES

12-16 John St.

Phone 6605 Cort.

NEW YORK.

## BLANCARD & CO.,

96 MAIDEN LANE,

NEW YORK.

WELL MADE GOLD FINDINGS.

## ELSIE BEE'S FASHIONS

NOVELTIES SEEN IN A LADY'S RAMBLES AMONG THE  
JEWELERS.

A VERY unique idea for a ring is  
pressed in an open design based  
the outlines of a daisy inclosed in a circle,  
the whole being carried out in lines  
diamonds with a yellow topaz or pearl  
the center.

\*

Of very simple elegance are the  
what narrow silk ribbon fobs with  
oval or rectangular diamond buckles  
the only ornamental feature.

\*

An odd little powder box is orna-  
ment with an opal set in diamonds, the  
golden case being suspended from a  
quoinse pin framed in diamonds.

\*

Diamond-topped combs possess a  
magnetic attraction for fastidious femininity  
set of three combs with barrette to  
has a narrow diamond bow inserted in  
opening cut across the amber top.

\*

A good-sized cylinder and blocks of  
toise shell, after the style of the  
ball heads, together with tiny baskets  
jeweled flowers and butterflies, also  
set swords, daggers and arrows are  
the novelties in hat pins.

\*

Among pleasing outing designs is a  
gold watch, especially appropriate for  
lover of golf. The embellishment con-  
sists of a unique device employing the differ-  
ent golf sticks, the upper part of the handle  
being finished in diamonds.

\*

In tiaras, emeralds, pearls and also  
turquoise are incorporated with diam-  
onds in the body of some designs, as well  
alternating with diamonds to point the  
In a new design of exquisite workman-  
ship a fancy scroll pattern in diamonds is  
enriched with large, round pearls and  
diamonds and pearls are spaced along  
points. A pair of diamond birds are  
either side of a central ornament set  
a handsome emerald in a diamond tiara.

\*

Very open, close and medium styles  
a gentle rivalry for first approval in collars  
and collarettes. Individual taste has a  
choice in the many charming designs shown.  
In a collar manipulated in diamonds a  
sign of chic and telling character is  
maintained, in the open style, by oblique lines  
crossing each other. The triangular spaces  
thus formed at the top and bottom are  
filled with a conventional design, while  
diamond shapes running through the middle  
are entirely open. A design that pleases  
irresistibly for descriptive place is a  
criss-cross pattern displaying large  
diamonds with an effect of great richness  
and beauty.

ELSIE BEE

# Rockford Watches Speak for Themselves

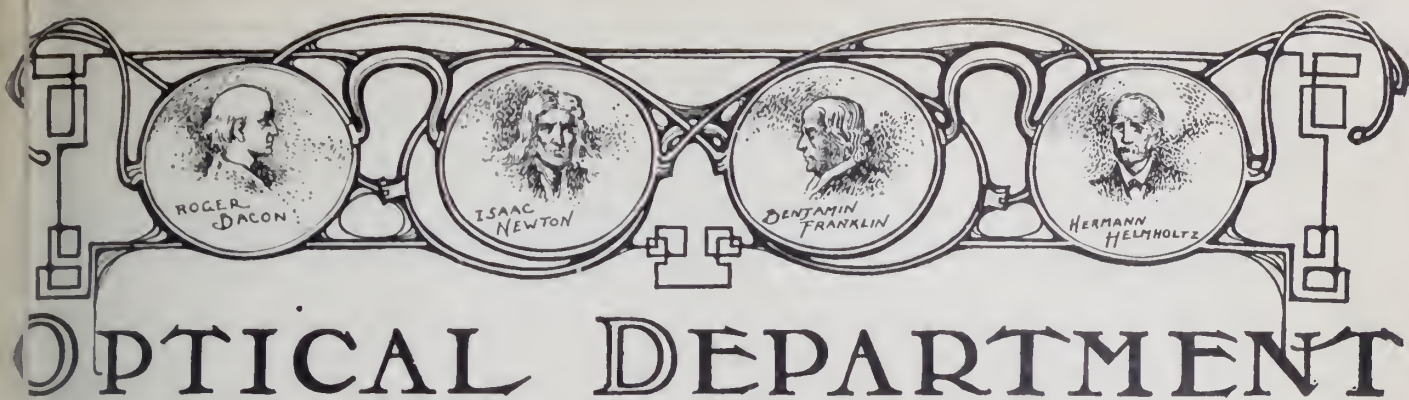

# OPTICAL DEPARTMENT

## Useful Information Regarding the Coming Convention of the A. A. O.

KANSAS CITY, Mo., June 20.—The Board of Directors of the American Association of Opticians, in view of the fact that the Physiological or Optometrical section of the Association has heretofore had but little recognition at national conventions, has authorized the officers of this section to take entire charge of the scientific and literary programme of the Rochester convention, under the following conditions:

The programme to occupy the time of three sessions as follows: Afternoon of the first day, and noon and evening of the second day, it being understood that the officers of this section take entire charge of the programme and affairs of the convention during these sessions, and that they carry out the programme in full, as recorded in the attached memorandum, signed by the officers of this section. The expense of the section programme as outlined not to exceed \$50, which the member officers of the American Association are hereby authorized to pay into the treasury of the section for use as herein provided.

### PHYSIOLOGICAL SECTION'S PROGRAMME.

The following is the programme of the Physiological Section of the A. A. O., submitted for consideration and adoption by the Executive Committee of the American Association of Opticians, to be carried out at the coming Rochester convention:

1. Session (either morning, afternoon or evening) devoted to a public clinic of practical eye-testing, including the use of optometric instruments and skiascopy in relation thereto.

2. Session (as above) devoted to a public clinic of practical muscle testing, including the use of optometric instruments in connection therewith.

3. Room properly fitted, under the charge of a recognized authority to enable visiting optometrists to elucidate any points in practical eyesight and muscle testing which may have been found puzzling in their daily refraction work.

4. Providing suitable papers of practical scientific interest for the edification of the members generally.

- (Med.) SAM'L S. GRANT, B. O. A., President.
- W. R. DONOVAN, Vice-President.
- ERNEST EIMER, Secretary and Treas.
- C. M. JENKINS, Librarian.

### RAILROAD TRANSPORTATION.

One and a third fare on the certificate has been granted over all railroads in the United States and Canada. Tickets may be bought any time after July 25, or five days earlier at more remote points. Return tickets may be bought any time within ten days after the meeting closes. Extension and stop-over privileges can also be obtained. For further information inquire of your local agent or write the secretary of the A. A. O. When buying tickets, purchase a first-class unlimited ticket to Rochester, and ask for a certificate—not a receipt—and insist upon having it. Turn the certificate in to William E. Huston, secretary of the National Society, immediately

upon arrival at convention hall, Rochester. This certificate will be returned to you, signed by the Central Passenger Association, and entitles you to a one-third return rate.

### EXHIBIT SPACE.

No charge will be made for exhibit space, but no exhibit will be allowed unless application be filed with W. W. Bissell, 91 Main St., E., Rochester, N. Y., at least 10 days prior to the convention.

### HOTEL AND LOCAL ACCOMMODATIONS.

Those who contemplate spending several days or weeks in Rochester, or who wish hotel accommodations and are not familiar with the hotels, should write to B. B. Clark, president, 5 Triangle building, Rochester, stating the rate and sort of accommodations wanted, and their letters will be turned over to the Entertainment Committee.

### DELINQUENT MEMBERS.

Members who wish to participate in the affairs of this meeting should not fail to remit their dues to the secretary before the meeting, as the present Constitution and By-Laws provide that all dues must be paid in full before the member is entitled to the privileges of the floor. And all persons intending to join the Association should send in their applications to Secretary William E. Huston, 1315 Harrison St., Kansas City, Mo., at least two weeks before the convention, as it takes about that time to act upon an application.

### SIDE TRIPS, ETC.

In addition to trolley rides to nearby resorts, trips to the lake and Niagara Falls, the R. & O. Navigation Co., operating a line of fine steamers, has planned a number of special trips on which it will make very low round trip rates. There are four trips planned—one to Toronto, one to the Thousand Islands, one to Montreal and one to Quebec.

That the exhibit feature of this eighth annual convention will far surpass that of any previous convention is already assured. Far more space has already been taken by representative firms than has been engaged for any of the former conventions.

While no "official route" has been selected, the Lake Shore & Michigan Southern offers the most advantageous arrangements from the east, west and south. Opticians coming from the west over this route will find the monotony of the trip broken by the boat ride from Cleveland to Buffalo. Stop-over privileges for Niagara Falls may also be had.

The year just drawing to a close has witnessed a wonderful revival of interest in the American Association of Opticians.

This is evidenced in the fact that more new members have joined since the Minneapolis meeting than have affiliated during the entire six previous years. Nine new states have affiliated, and over 600 new members have been added. In addition to this, nearly 100 delinquent members have again renewed their membership.

The following circular which is being sent out will be of interest to opticians visiting Rochester during the convention:

To the Members of the American Association of Opticians:

At the time of your convention in this city, July 30 to Aug. 2, we will offer for yourselves and families a number of very delightful boat trips from this city at very reasonable rates.

TORONTO, \$5.50.

The Queen City of Canada is reached by a night run from Rochester, leaving 11:45 p. m., arriving Toronto 6 a. m. Returning same afternoon boat leaves Toronto 3:30 a'clock, arriving Rochester 9:30 p. m. This trip includes berth on the going trip and dinner returning. Ticket unlimited.

PRESCOTT, \$6.50.

This trip takes in the Thousand Islands by daylight, and at this time there is no more delightful trip on earth. Boat leaves Rochester 11 p. m. arriving Kingston, Canada, 6 a. m., and until Prescott is reached at 10 a. m., passengers are treated to a panorama of beautiful islands, each the property of some American millionaire and surmounted by castles. This trip takes in Clayton, Thousand Island Park and Alexandria Bay. Returning, boat leaves Prescott 11:55 a. m., arriving Rochester 10:15 p. m. Trip includes berth and meals both ways. Ticket limited to continuous passage.

MONTREAL, \$15.

Same route as Prescott trip, thence through the St. Lawrence River Rapids, shooting the famous Lachine Rapids by daylight. This trip can be made in three days, allowing nearly a day in Montreal for sight seeing. Passengers should not fail to take the carriage drive up Mount Royal. Meals and berth included throughout. Limit, 10 days.

QUEBEC, \$22.

This trip can be made in four days, including one day in Quebec and a half day in Montreal. Meals and berth included throughout. Quebec is the oldest city in Canada and the most interesting. Points of interest are the Citadel, Plains of Abraham, old French quarter, Chateau Frontenac, Montmorency Falls, famous Shrine of St. Ann de Beaupre, and many others. Limit of ticket, 10 days.

SAGUENAY RIVER, \$32.

This is a 48-hours' trip past Quebec, and takes in some of the most beautiful and remarkable scenery in America. Passengers having a week to spend should not fail to take this trip. Meals and berth are included throughout. Limit, 10 days.

Early application should be made for staterooms. Our special representative will be in attendance at the convention to take care of your wants. The above rates are special and open to members of the association and their families only.

Yours very truly,  
THE AMSDEN STEAMSHIP TOURIST AGENCY.

Dr. Frederick Stone, formerly with the Bay State Optical Co., Attleboro, Mass., has taken charge of the optical department of the Miner store, Winter St., Boston, Mass.

## Optical Department.

### The Policy of the American Association of Opticians.

NEW YORK, June 20, 1906.

Editor THE JEWELERS' CIRCULAR—WEEKLY:

A national organization of opticians was effected, in 1898, and called, officially, the American Association of Opticians. This result was not the sudden outcome of a short-lived whim, but a satisfying of a long-felt want, and only achieved by strenuous efforts. It demonstrated that opticians had arrived at that point whence they realized that their interests could be better served by joining forces.

This principle is a sound one, but to obtain the best results from an undertaking of this character—in fact, to gain any benefit whatever—the whole body must move in unison and toward one definite point, and unless uniform action can be commanded confusion and negative results are all that can be expected. In other words, a large, diversified, unwieldy body must move, if it move at all, along the lines of a pre-conceived, definite policy.

The American Association of Opticians, after nearly a decade of existence, has no policy. That is a broad statement, but its breadth and, what is more, its undeniable correctness, should strike every well-wisher of the A. A. O. with sufficient force to wake him up to the facts as they exist, and enlist his energies in an effort to change this state of unsettledness.

Better a second-class policy than none at all, because that may lead, at least, toward a better one, whereas none means a standstill. About all that the American Association has done so far has been to undo each year the work of the previous year, and, judging from the present signs, it is still up to its old tricks, and unless care is exercised all the work that was accomplished at Boston, the banner convention, will be annulled at the coming convention in Rochester.

Two ideas predominate—or, rather, two factions dominate—the workings of the A. A. O. One insists that its aim should be to guard with equal care the interests of each and every branch of the optical industry; that is, its membership should consist of all who, in any way whatever, are interested in optics—the optometrist, the dispenser, the jobber, the wholesaler, the retailer, the manufacturer, the traveling salesman, the clerk, the shopman, the scientist, the author, the journalist, and, alas! the fakir; and, furthermore, that each class should have equal representation. The other faction contends that the interests of such a collection would be so widely diversified that it would be utterly impossible to merge them into an harmonious whole, and that, therefore, as one class of interests are more important than another, provision should be made whereby that class would be properly favored. The interests of the optometrist and the dispensing optician, for instance, are almost diametrically opposed; how, then, can even these two classes be expected to work for a common end, and will not the admittance, on an equal basis, of more classes add to the confusion and contention?

It may be a difficult choice to make, but if the officers wish to see the A. A. O. advance they must adopt some fixed policy and "work it out along those lines if it takes all Summer." "OPTICUS."

### Meeting of the Optical Society of the City of New York.

THE regular meeting of the Optical Society of the City of New York was held on Wednesday evening, June 13, 1906, in the optical parlors of A. Martin, at 17 W. 28th St., New York, at 8 p. m. The meeting was called to order by President Offenhauser. Applications for membership were received from the following: Jos. Mantell, Muskogee, Ind. T.; Wallace W. Lent, Peekskill, N. Y.; Chas. C. Kraft, Highwood Park, N. J. (proposed by Mr. Shapero); Henry C. Aurnhammer, Newark, N. J. (proposed by Prof. Lockwood); Austin Soper, Madison, N. J. (proposed by A. Frank); Homer B. Hoyt, Norwalk, Conn. (proposed by A. M. Frankel).

In accordance with the by-laws these names were laid on the table, to be acted upon at the next meeting.

The following, who were proposed at the last meeting, were elected to membership: Walter Carlin, Brooklyn; A. F. Mittacher and H. Schuman, New York.

The secretary read the correspondence, which was of a general nature. A letter was received from the Indiana Optical Society, requesting information and blanks appertaining to the New York society's two-years course.

The fourth paragraph, page 9, of the by-laws was changed to read:

"All members of this section, upon passing examination, shall be presented with a certificate, which will remain the property of this society and shall be subject to forfeiture upon the member breaking any rules of that section."

Mr. Marchant suggested slight changes as follows: "Upon taking examination" instead of "upon passing examination," and "upon demand of the society" instead of "upon breaking any rules of that section."

A lengthy discussion then followed upon the part of Mr. Yarrow, Mr. Meyer and others. Mr. Meyer then introduced Dr. Killilea, who spoke to the members on the subject. His remarks were sound and logical, and to the point, and were received with hearty applause. After the matter was debated *pro* and *con* for some time, and the subject of incorporation of the society discussed as well, Mr. Ryer withdrew his motion.

This ended the business portion of the meeting, and Prof. Lockwood began his quiz on chapters 5, 6 and 7 of Henderson's "Lessons on the Eyes." After the quiz the meeting adjourned until the second Wednesday in September.

#### QUIZ QUESTIONS.

- Describe the form of a light wave.
- What is a ray of light?
- In what medium does light travel the most rapidly?
- What is meant by the word "refraction"?
- When is light never refracted?
- Passing from an optically rare to an optically dense medium, how is light ray bent?
- Passing from an optically dense to an optically rare medium, how is light ray bent?
- When a ray of light falls perpendicularly on a denser medium, what change takes place?

Describe a prism and the course of a ray of light passing through the same.

In what direction does an object seem to be placed in looking through a prism?

Give the three modern ways of numbering prisms.

What is a lens?

What is the principal axis of a lens?

What is the principal focus of a lens?

What are conjugate foci?

What is a virtual focus?

Name three styles of lenses, all to be of equal power.

Describe a cylindrical lens as used in optometry. What two factors count ordinarily in producing strong lenses?

What is meant by a one diopter lens?

What is necessary for the formation of a clear retinal image?

What is the average width of the pupil of human eye?

Why is 20 feet considered practically the same as infinity?

To what extent is this supposition incorrect? Define the term emmetropia.

Are emmetropic eyes normal eyes, and what the reason for your belief?

Define accommodation.

Define action of the ciliary muscle in accommodation.

Define presbyopia.

Define convergence.

What is the field of vision, and what are its limits?

Describe the solar spectrum.

What are the primary colors, and why are they so called?

What is the Young-Helmholtz theory of color perception?

What is color blindness?

Name the different forms of ametropia.

What is hypermetropia and its two fundamental causes?

How is hypermetropia overcome or corrected?

What is the effect of the continued effort of ciliary muscle in hypermetropia?

What is myopia, and its two fundamental causes?

Can the possessor of a myopic eye overcome myopia? Give reason for your belief.

How do myopic eyes see for distance and near?

Define astigmatism.

What is meant by the principal meridians?

Name the five optical varieties of astigmatism.

Can astigmatism be overcome by the patient and how?

How can astigmatism be corrected?

Define isometric eyes.

What is the difference between isometric and emmetropic eyes?

Define anisometric eyes?

Define astigmatic eyes.

### The Optical Trade in San Francisco

The W. R. Johnston Optical Co. is now located at 135 Ellis St., San Francisco, Cal.

The Cahn Standard Optical Co. has opened temporary offices at 1908 Bush St., San Francisco, Cal.

Chas. Proctor and Louis Kuttner, opticians, have opened a store at 2076 O'Farrell St., San Francisco, Cal.

The San Francisco Optical Co., San Francisco, Cal., is now located at 1315 Golden Gate Ave.

Abraham & Roth, formerly with the Standard Optical Co., San Francisco, Cal., have branched out for themselves and are now located at 1002 Fillmore St.

Henry Kahn & Co., San Francisco, Cal., are carrying their usual line of goods. Their store has been leased, recently, at 1309 Van Ness Ave., and this will be ready for occupancy by July 1, at the latest. It is the intention of the firm to operate the store at 2253 Fillmore St. in conjunction with their new one.

Carl E. Strand, Park River, N. Dak., has taken charge of the optical and jewelry departments of Feckler Bros.' drug store at Wimbledon, N. Dak.

# RETAIL JEWELERS ADVERTISING

The use of this department is open to every retail jeweler and optician. Forward for criticism your newspaper ads., booklets, catalogues, novelties, circulars, etc. Ask advice and offer suggestions. Replies in these columns are unbiased. Make letters as full and particular as you desire. Every letter and ad. sent will receive full attention, though the publication of the matter may sometimes be delayed several weeks.

## How Shall I Begin to Advertise?

HERE are scores of individuals and concerns who are ready to advertise, and not to know *how*, says P. H. Merkle, in *divisive Advertising*.

They have read various articles on advertising, they have seen successes made over and over again, they know that advertising is an established principle of success. What they want to know *now* is how to begin. Beginnings in advertising, as well as in most anything, are mighty important, and decide the fate of the whole enterprise times.

A false start, a wasting of precious capital in things that don't have pulling power, is commercial suicide. One might as well under off on the road to Boston, expecting to get to Chicago, as to put the opening energy into the wrong channel. It is more an twice as hard to make a change of policy and plans after once starting—and more than twice as expensive.

Well, then, what is a good start?

A good start is nothing more than a thorough preparation, a carefully thought out campaign, and with a keen eye fixed on the goal ahead and a sufficient stock of the energy, money and brains necessary to reach at goal.

These are the general principles of the thing—now we can come down to a bill of particulars.

Always granting that you have something to sell which people will find worth while buying, the next problem is to decide upon a campaign. Now it ought to be perfectly plain to anyone that the persons who can give the most valuable information upon this matter are the persons who have had the longest and keenest experience in this sort of work; and here is where the first chance for fatal mistake comes in on the part of the smaller advertiser. He gets an idea that he can do it about as well as anybody!

The popular idea of advertising to-day surrounds the subject with mystery and strangeness. Advertising is a fairy wand which you need only wave properly and recite the lucky incantations, and lo! the gold flows into your hand! To others it is a sort of hypnotism and magnetic suggestion whereby some occult laws of mind and only by mandating that you take large enough space and shout and "suggest" loudly enough. The mere fact that you buy space seems to some people to be reason why an advertising campaign should succeed; and if it doesn't, they question the principle itself of advertising.

Bless you! A Rip Van Winkle who had awakened only yesterday wouldn't need more than a few hours to convince himself that the *principle* of advertising is as unquestionable as the principle of gravity.

Let every new advertiser comprehend that advertising success is only accomplished by analyzing and improving on experience, and he will stand big chances of success. For *then* he will see the logic of putting his advertising into the most competent hands he can find.

In a false spirit of economy, which is the most lamentable, many small advertisers write and place their own advertising, persuading themselves that they know about as much about it as anybody they can hire. Quite often, indeed they slyly get as much information as they can from advertising men and magazines; and tell themselves they are shrewd and wise beyond their generation.

But the sad truth of the matter is that advertising pages are loaded up with this kind of mediocre work, and the *really* wise advertiser's matter skims the cream off the market, and gives to the rest the leavings. While the over-cautious advertiser is engaged in saving pennies and starting with almost the least possible expenditure, the shrewd and wise man is sparing no cost to get the best of the things that are the very vitals, heart, brain and stomach, of his enterprise—a keen campaigning plan and powerful copy. Is it remarkable, then, that he succeeds?

The question of advertising service very frequently worries the beginner in advertising exceedingly. He don't know much about advertising, and he is talked to death by a score of advertising men who fire hot shot at him in rapid succession. They all seem to abound most in the same thing—namely, great willingness to take everything out of the advertiser's hands, large promises, and a great deal of superheated atmosphere in general.

After every representative has his talk all in, the array is enough to confuse the most clear-headed of business men. Each advertising man has said his say so plausibly, and, on the surface at least, all of them seem to be right; yet they all disagree more or less in all but one thing—that he should spend large amounts of money and turn it over freely to them. There is little wonder that many manufacturers and others withdraw and refrain from placing their money in such a rabble of uncertainties as advertising is made to seem to be.

It is always safest to be the guiding pilot of an advertising campaign yourself, if you are an advertiser. That is, you ought to

know whether you are drifting and why you are going and where you are headed. Advertising is not anything remote from business; and if it can't stand being judged on the same principles that apply to business in general, it isn't worth considering at all.

(To be continued.)

## What Some Jewelers Say.

NEW additions to our stock of stylish bracelets.—Anticipating the increasing demands for bracelets for Summer wear, we recently placed a large order and are now showing for the first time the most wonderful line of beautiful bracelets in miles around. The collection is extremely versatile in style, showing all of the latest engravings and carvings—many being set with diamonds and other precious stones. It is permissible, even considered correct, to wear more than one bracelet on the arm. Albert Pfeifer & Bro., Little Rock, Ark.

Diamond pride is possessed by every girl who receives an engagement ring from Sipe, because it has the beauty and artistic value not possessed by any other jeweler in Indianapolis. J. C. Sipe, Indianapolis, Ind.

Brass is gaining in popularity for wedding presents. Brass is now worked up into so many useful and artistic things at prices that are not at all high. Brass things have a substantial look to them and bear it out in wear. We have a new consignment of brass goods in the window in the latest designs and finishes. Let us show you some of the prices and surprise you with the low prices. R. Ashby, Colorado Springs, Colo.

The diamond question is easily settled at the jewelry shop of L. W. Lewis. You'll find a magnificent assortment of perfect cut, clear stones, artistically mounted and priced very reasonably for strictly high-grade guaranteed diamonds. See the new attractive pieces for brides and graduates. L. W. Lewis, Columbus, O.

Silverware, cut glass and clocks.—Nothing else seems to combine beauty and usefulness to such a remarkable degree for wedding presents. We have now ready to show you a handsome assortment of both flat and hollow silverware from the best makers and the latest designs. Also cut glass and clocks too numerous to mention. We can supply your silver, cut glass or clock wants at economical prices. Your inspection solicited. M. J. Buechler, Bridgeport, Conn.

Diamonds are the most profitable investment you can make for personal adornment. What else can you realize on at so nearly cost price as a diamond? We can save you money on purchase price, too, and find it makes diamond business, with enough profit to satisfy us. Let us figure with you on any size, best quality. A pleasure to clean your diamonds free and welcome. Morsman & Feagans, St. Paul, Minn.

A betrothal gift for your fiance, or a wedding gift for the June bride, can be selected from our superb stock of diamonds and precious stones of all kinds, watches, earrings and rings, without trouble, as we sell at as low a margin of profit as is possible to live and let live. Jesse Davidson, Montgomery, Ala.



That this department shall prove mutually beneficial to our readers, it is desirable that the members of the trade generally communicate with THE JEWELERS' CIRCULAR-WEEKLY regarding any advantageous device or plan which they are utilizing in connection with their business.

**An Original Window Display for Independence Day.**

THE window display illustrated herewith is one which can be made without any great expense, and is both attractive and timely, being commemorative of the signing of the Declaration of Independence.

**Effective Illusions in Window Dressing.**

THE window-dresser in the department store has some advantages over his brother in the more restricted lines of trade. If the former desires a pretty piece of furniture to secure a certain desired effect in setting off some dress models, he

man. It is not always sufficient that should be familiar with the blending a harmonious arrangement of color, but must be endowed with the inspiration painter, the genius of the decorator and deftness of the stage carpenter who adept at the perpetration of all kinds deceptive devices knocked together fr

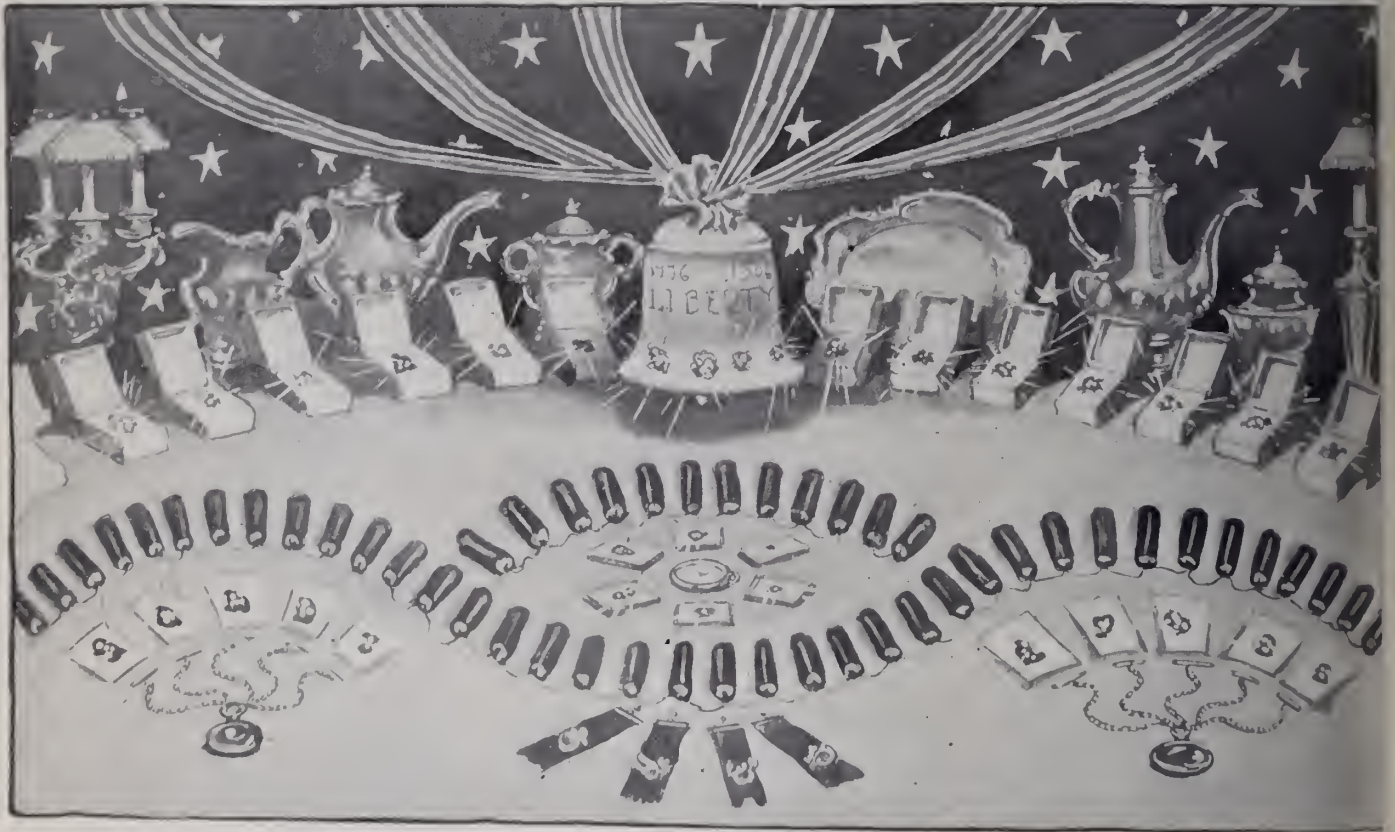

AN ATTRACTIVE FOURTH OF JULY DISPLAY FOR THE JEWELER'S SHOW WINDOW.  
(Drawn expressly for THE JEWELERS' CIRCULAR-WEEKLY.)

In the center suspended by hunting is a bell—denoting liberty—studded with jewelry. Against the dark blue star covered background and set off thereby, arrange silverware—candelabras, etc. If convenient, select pieces of Colonial design.

A firecracker border frames in a few choice pieces of jewelry and gives a touch of color to the window. Fobs, watch chains and other stock fill in the sides and back of the bell. The various kinds of decorative paper which may be obtained make the cost of producing displays of this kind very small.

simply sends to the furniture department, and after use it goes back into the stock. So the picture, lamp and other departments may be drawn upon for his materials without expense. The man who happens to be employed in the capacity of dresser for a jewelry store has not these resources at his command and must exercise his ingenuity to secure effects by which his window may be given a fresh appearance at regular intervals without incurring any great expenditure of money.

It is essential that the window-dresser should be a mechanical genius and a handy

materials at hand and which will not excite a breath of suspicion from those unskilled in the shams and deceptions of the world.

Under this head may be classed two schemes which have recently come to notice for obtaining clever effects by the exercise of a little ingenuity and the expenditure of a small amount of money. One consists in the reproduction of a stunning art glass lamp shade for a store window. Upon dissection this proves to be a tissue of fraud and impositions, but when viewed at eye level a short distance it defies scrutiny. The

**Storekeeping Department.**

**A "Realistic" Window Display.**

side is of an oblong shape with sloping ends and ends. It is hung by massive chains from the ceiling of the window and gives the glow from a group of four incandescent electric lamps. The sloping ends and sides were semi-transparent, and they were incorporated the improvised glass effect referred to above. The shade was built upon a square iron frame made by bending a length of bar iron into rectangular shape. The four sloping sides of the shade consist of pieces of wire mesh fastened at the top to a wooden panel. This panel is really the backbone of the shade and contains the hooks which engage with the supporting chains.

The cloth referred to is of a neutral color and is carried in stock only by the larger hardware dealers, as there is not a great deal of call for it. If this cannot be readily secured mosquito wire will answer for a fashion. The coloring is applied to the wire in the desired design in the shape of shellac colored with aniline dyes. Care must be exercised in following this scheme to see that the meshes of the wire are entirely filled with the coloring matter. It is not necessary to apply it with any great care, as far as the design is concerned, for the inequalities and irregularities add to the effectiveness of the design.

The effect of "leading" between the different masses of color was secured by stripping of plaster of Paris, which may be applied in the same manner as the baker puts his decoration on the top of the wedding cake. He uses a paper cone filled with the material, which is forced from the pointed end by the pressure of the hand. There are rubber bulbs which come for this purpose now, and these are extensively used in the arts and industries. The plaster may be readily colored black or made any tone by mixing a suitable quantity of lampblack or mineral black with the plaster, but the best result can be obtained by coloring the plaster while wet with powdered silver or aluminum. This gives an excellent imitation of lead.

The general effect of this lamp, as it hangs in the window is very effective. The light passing through the wire and colored shellac is just toned down sufficiently to give the desired effect. Such a shade in art glass would cost between \$20 and \$25. The imitation cost about \$1.90.

Another method of imitating stained glass is by the use of strips of paper which are prepared for the purpose and which make quite a new idea. This material can be used with excellent results where there is permanent mirror or plain glass background. The paper is cut into ovals, circles and such other shapes as is generally resorted to in stained and leaded glass signing. The gum is already on the back of the paper so that in its application it is simply necessary to go over the glass surface with a moistened sponge and then to stick on the paper strips as desired.

The attractiveness of this is heightened by the addition of an occasional "jewel" of glass, which is secured to the paper or glass background. The advantage of this method is that it is possible to make frequent changes of design.

COMMERCIALISM is rapidly diminishing the retail merchant's limitations. It is doing so partly by increasing the retail merchant's scope. A pretty contradictory pair of statements! Well, the meaning intended to be conveyed in the first sentence is that the small retailer, as such, is rapidly finding a competition that is growing so oppressive that he will soon have to give up the combat if he is determined to remain a self-respecting citizen, absolutely refusing to live or rather exist on starvation income. Department store methods are encroaching on his custom so that he is often looking prophetically on the era of his dissolution. This applies to the retail merchant who restricts himself to a certain line of wares, legitimately (he calls it) belonging to his craft or guild, and who is determined to bring about his sales on the same plane his father (not to say his grandfather) did before him. Would it be clearer if I say he can no longer run a shop and succeed?

The second sentence, which sounded paradoxical, is based on the sad fact that for the retail merchant to obtain that share of fortune that is due to energetic action, perseverance and deep study of his trade he must be at least a little bit of something else than a retailer. He must buy large lots (speculatively, may be, sometimes,) to get the low quotation needful for a living profit under present competition; and must force larger sales. That is to say, he must be something nearer a wholesale or jobbing buyer. Or he must be just a little something in the importing business. Or as a last alternative he must get out of his craft and besides being, say, a jeweler, he must be something else; anything that will increase his income.

Perhaps we might put the whole thing in a nutshell by another paradoxical sentence: The successful retailer will soon have to be a wholesaler or quit.

This evolutionary phase entails another sad condition which faces the retail merchant of the next few years. It means that you shall be a successful leader ("always room on top"), progressive, aggressive, creative, enjoying that full financial measure of remuneration that is these days called success, or you must be one of the squeezed, multitude, half suffocated peculiarly with mean, close competition.

It would not be difficult to quote individual concerns in the jewelry trade as examples of the advance towards these conditions, but personal comparisons are odious. Let us exemplify the case in some other line of trade, and you will see the analogy yourselves. Take the dry goods trade, and we find certain retailers feeling the impossibility of selling larger stocks of goods looked for increased profits elsewhere than in the enlarged retailing. A. T. Stewart, having the biggest stores he could handle and those stores well filled with customers, purchased his own Irish linen factories, then his own factories in other lines in England, in France and elsewhere. And his margin of profit included those of the wholesaler, importer and manufacturer.

Now, unfortunately, all this energetic action of these big retailers, ever increasing the number of their sales (and the list of customers of course), does not make my

lady wear more silk dresses nor increase her handkerchief consumption. It only takes away that much trade from the little retailer.

Altogether a pretty sad state of things for the retailer, you will say. Well, both yes and no. Sad for the shopkeeper who wants to drowse through life dividing his time between eating his meals and sleeping behind the counter. He has to go, but then there is Hawaii and the Philippines and other good free American territory open to his restful temperament.

But to the A. T. Stewart type of determined succeders there are openings for Stewart successes or even greater ones. The desperate conditions should surely rouse the lethargic liver and wake the dreamer to 20th century ideas. Shop methods should be bundled neck and crop from retail premises, the arts and wiles of the jeweler merchant princes followed or improved on. And presto! you climb to those same dazzling heights that those grandfathers of ours never dreamed possible in the retail world. The worthy and ambitious American's range of vision should never be short of the President's chair, or he is retrograding from his school training and is no longer the equal of his citizenship's type. He is permitting himself to drift into the cynic or the hypochondriac and is in the wrong country.

But this looks as though the writer were drifting far, far from our show window. As a matter of fact, probably the chief source of strength of the ultra-successful mammoth stores of this city lies in the method of display of their wares. The practical character ruling in these leviathan establishments aids in the resultant sales as much in their way as the graphic and potent methods of expression in their advertising lead the throngs to visit the emporium.

And the process of appeal to the purchasing power of the public is simple in its conception. To perfectly display a bedstead, a bedroom "lay out" is best adapted. To magnetize a desire for a special suit of dining-room furniture the full garniture of the room is most effective. Some plates and dishes resting on fine white napery, the groups of wine glasses posed correctly, and even a cut glass centerpiece with real flowers will bring about satisfactory conclusions quicker than any verbal argument.

Realism is what attacks most forcibly human sentiment, and the "realistic" display of merchandise is what closes the largest number of sales. Whether you claim the public's attention for the delicate flavor of a soup or the simple action of a collar button the "demonstrator's" activity is called into play, and the young ladies who "demonstrate" a hot soup are radiant in the snow white uniform of the chef, the collar stud man works frantically in shirt sleeves and displayed "galluses." Realism is aimed at and attained in most lines of salesmanship these days, but the jeweler does not appear as a very prominent disciple of these practices. With him it is probably more an excess of dignity than a lack of appreciation, but cult must give way to the dominant radicalism. Even the severe refinement of the staid retail jeweler must be torn out of the store and relegated to his domicile, as was long since the case with other trades.

(To be continued.)

What Tool is of More Importance to THE MAKERS OF FINE JEWELRY than

A FIRST CLASS SAW ?

SHARP—TRUE—UNIFORM  
—PERFECTLY TEMPERED

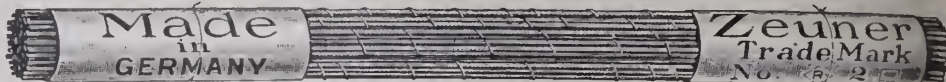

Such is the **ZEUNER SAW.**

TRY THEM, for "Only the Best are Good Enough," and only the Best are Cheap. Trial orders promptly filled under guarantee of perfect satisfaction, which applies also to our "AMERICAN SWISS FILES."

**E. P. REICHELME & CO.,** 23 JOHN STREET NEW YORK.

**THE REMINGTON RING EXPANDER.**

The most useful implement a jeweler can own.

PRICE \$7.00 NICKEL PLATED INCLUDING A STEP MANDREL AND EIGHT ROLLS

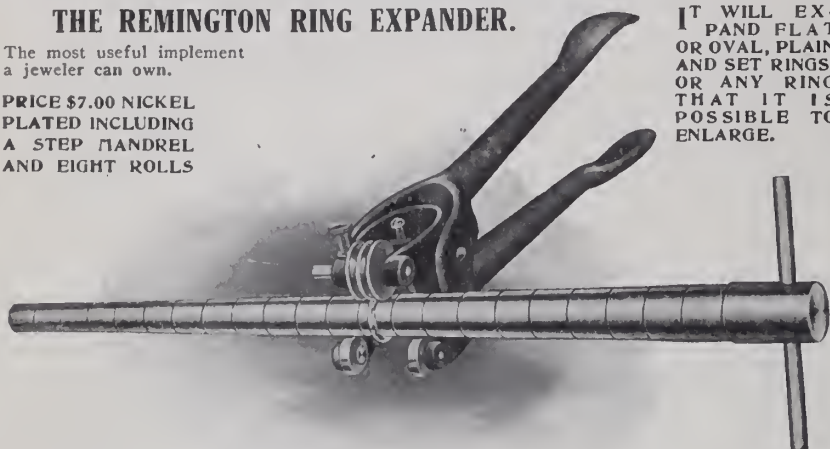

IT WILL EXPAND FLAT OR OVAL, PLAIN AND SET RINGS, OR ANY RING THAT IT IS POSSIBLE TO ENLARGE.

IF YOUR JOBBER CANNOT SUPPLY YOU WRITE TO US DIRECT.

SPECIAL FEATURES OF THE REMINGTON RING EXPANDER.

A MANDREL WITH STEPS SQUARED and 1/2 size variation is used to prevent tapering of the ring. THE FOUR SMALL ROLLS ON THE LOWER JAW OF THE TOOL (see cut) PREVENT FRICTION, and make it possible to use any amount of pressure WITHOUT ROUGHING THE MANDREL. THE PRESSURE IS CONTROLLED BY THE HAND and it is not necessary to use a vise or other implement when operating the REMINGTON.

Manufacturers of Patent Tools and Machinery.

NOVELTY ENGINEERING ASSOCIATION, FITCHBURG, MASS.

**OUR ELECTRO-PLATING SALTS**

when dissolved in water make a plating solution once ready for work of always correct shade. Know that we are originators and manufacturers of the Dark Green Gold Salts (tigue) and other Shade Green.

Likewise the Rose and Orange Rose Salts used for single double gilding, and good many other shades now on the market. Our Roman Gold Salts produce an almost brilliant deposit, requiring little or no scratch brushing.

French Grey, 11 or 12 Kt. gold, Old English gold, Silver Ebonize fact any shade wanted, be had of us. Write circular.

Our Automatic Electro-Plating Machine specially designed for small manufacturing the retail Jeweler, will be of interest to them. Write for Pamphlet.

U.S. ELECTRO-CHEMICAL Co. H. Hirschbach, Prop. 80 Elm Street, New York.



**GLARDONS' SWISS FILES**

are the HIGHEST STANDARD of Excellence.

We are Sole Agents for the United States and Canada.

**F. W. Gesswein Company,**

Established 1868. Incorporated 1890.

WILLIAM DIXON, PRES.

Dealers in Fine Tools and Supplies,

39 John Street, New York.

**CRUCIBLES**

Jewelers' Supplies, Etc.

Established 1850.

**J. & H. BERGE,**

95 John Street,

NEW YORK.



**CASTINGS**

Gold, Silver, Bronze, Brass, German-silver, Copper & Iron Supply Jewelers, Silversmith Die-makers, Mould-makers, etc.

L. D. Tel. 2072 L.

Unbreakable Bronze Forces. Hard Bronze Engraving Plates. Cast Iron Forces for making Steel Die Chandeliers, Undercut Work, Statuary.

**AUGUST GRIFFOUL,** 313 HALSEY STREET NEWARK, N. J.

"PRACTICAL COURSE IN ADJUSTING." Price, \$2.50.

All Jobbers or Jewelers' Circular Publishing

**LEIMAN'S NEW SAND BLAST.**

SIMPLE. EFFECTIVE. ECONOMICAL.

NEW FEATURES—Let us tell you about them.

RESULTS—Let us show you samples of work done.

Improved High Pressure Blower

NOISELESS. INEXPENSIVE.

Delivers Greater Volume at Higher Pressure Than Any Other Made.

**LEIMAN BROS.,**

Jewelers', Silversmiths' and Metal Workers' Machinery, Tools and WORK BENCHES,

141 Centre Street, NEW YORK.

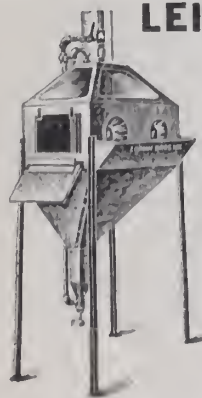

PATENTED.

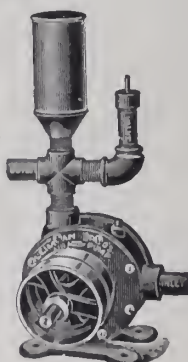

PATENTED.

**ROLLED GOLD PLATE SEAMLESS WIRE AND TUBING**

**DUNBAR, LEACH, GARNER CO.,**

MANUFACTURERS,

ATTLEBORO,

MASS.





Answers are also solicited from our readers to the questions published on this page.]

**QUESTION No. 1596.—Current for Stripping.** Please inform us how we can regulate a 110-volt current so we can use same for stripping solution and plating cases?  
H. & E.

**ANSWER.**—A current of 110 volts is too strong for either stripping or plating. But a current may be used for stripping with the assistance of a special apparatus, which will cost about \$7.50.

**QUESTION No. 1597.—Acid Burned Diamonds.**—I have made several diamond pieces in which the stones were soldered in beams of platinum, and recently burned some of the stones accidentally. I was told they were "acid burned." As we use a lead pickle for our pickle solution I would like to know whether the lead may have left a coating upon the stones which, after again going through the fire, burned itself upon them.  
F. J. M.

**ANSWER.**—When you state in your letter that you have burned some of the stones you express the thing correctly. Diamonds may be red hot in soldering, but when a certain amount of heat is exceeded the diamonds sweat and get coated, which coating can only be removed by repolishing. While there are some chemical substances which will destroy the polish of the diamond, lead is not one of these. It is not safe to mix a pickle in anything else than porcelain or earthen vessel; lead will alter the chemical constituents of gold, but will not injure genuine gems.

**QUESTION No. 1598.—Irregular Watch.**—I have a 24-jewel Rockford watch which I cleaned five months ago. The last 10 days it has lost time. I moved the regulator as far as it would go, and still it lost. When asked the customer to leave the watch, and I looked it over carefully. The jewels were all tight and well oiled, pivots were straight, the mainspring was in good order, the balance was true and in poise, the hairspring was true in flat and round. The regulating pins are the right distance apart to give hairspring the right motion between them. The train is free, for it runs on half an hour. I have tried the watch for magnetism, tightened up the balance and it is running O. K. now. I have had this trouble before and cannot solve the difficulty.  
F. B. J.

**ANSWER.**—That this 24-jewel Rockford watch should have begun to lose time in an unexplained manner about the time of a change of the season would seem to indicate that thermal changes have something to do with it. Changes from heat to great cold have a decided detrimental effect on the timekeeping qualities of any watch. As a thorough examination and overhauling of the movement has failed to show any defect in the general condition of the watch, molecular disturbances of three factors may

be accountable. These factors are the mainspring, the balance spring and the compensation balance. Admitting that the mainspring may have been made of the best of steel, its elasticity may have been impaired locally in tempering, which is often uneven, as it is generally done by manual and ocular operations. If such is the case, the gradual change in the elasticity of the mainspring in one or several places is often produced by a change of temperature; such change will affect the rate of the watch. A similar change may take place in a balance spring. The drawing of the fine steel wire for the purpose of making balance springs requires frequent annealing. By such frequent annealing the steel wire becomes decarbonized in spots, as such annealing cannot always be done equally throughout the length of the wire. Often these decarbonized spots show themselves in hardening, when some of the coils will stick together. This latter symptom does not show itself unless the spots are not extensive or of an acute nature. The mischief is great enough when of small extent, which will show itself in the running of the watch quite suddenly. Another cause of the disturbance of the erratic running of this watch may be the compensation balance. The melting of the brass on the steel disks leaves air or gas holes of diminutive size which are not closed by external pressure, and these in course of time make the expansion or the contraction of laminae subject to the most surprising changes, which cannot be guarded against, where so many watches are manufactured, as intermittent observations and adjustments would be necessary for the purpose. Marine chronometer makers perform such when rating chronometers, and new balances have often to be furnished.

**The Enameling of Jewelry.**

By CECIL H. SHERMAN.

(Copyright, 1906, by The Jewelers' Circular Publishing Co.)

(Continued from issue of June 20.)

**S**OME clover leaves are painted, others are given tints of transparent enamel and afterwards retouched with paint. Since very few kinds of gold will take transparent green enamel, these tinted clover leaves have a coat of fondant or transparent yellow next to the gold, then a coat or two of transparent enamel is painted and coated with the flux afterward. The newest things in enameling are produced along these lines—transparent and opalescent effects—and will probably be in vogue for some time, since the best work is done on the best gold. One firm, known to the writer, uses 14 karat, which is plated with fine gold (roll plate)

on the parts where these effects are desired.

Filigree or pierced work, which has the opening filled with enamel and when held to the light has a stained glass window effect, is gotten by using tinted fluxes, ground somewhat coarser than when used for regular enameling. By holding pierced articles perpendicular and charging in small portions at a time you can fill up the openings by repeated firing and charging. When too large cut a piece of sheet brass (yellow brass) and arrange brass and article to be enameled on one of your plates in such a manner that it will not have to be disturbed until after firing and so that you can proceed as though you had a piece of deeply cut work to charge; after the firing the yellow brass will spring away from the enamel.

Mourning jewelry, from an enameler's standpoint, is dead finished black work. Thin, even coats of black are charged and fired, and when cool are dropped either in white, or hydrofluoric acid, wet brushed and wiped dry with a clean linen cloth. The trouble is to get a good black for this work. Some make this finish grayish in hue and some black that looks bluish when it is being ground will be best.

The little gold ornaments seen on transparent enameled watch cases are made of gold leaf somewhat thicker than that used by sign painters. It may be bought at a first-class jewelers' supply house. This gold leaf is laid on the enameled surface, placed in the furnace and heated until it adheres. About the same amount of heat is used for firing paint; when cool it may be covered either wholly or partially with colored enamel or fondant. It must, however, have a coat of some kind of enamel over this or the paint will not stay on.

The making of enamels is a trade secret, and I have failed to find any one manufacturer who makes a line of colors, all of which are the best of their kind. As near as I can make out every lot differs a little from the other. A Frenchman who had served his apprenticeship with an enamel maker told me that they try to make enamel; if results are successful the product is sold as enamel, and if only fair the product goes for imitation stones, while if the results be bad the product is used for stained-glass windows.

However, it is possible to make a line of enamels that are very good by starting with a good flint glass as a base, first making it as soft or easy flowing as possible, and at the same time allowing it to stand the sulphuric pickle test. Make, first, a transparent flux, which will answer for all the transparent colors, and next an easy flowing white, which will be a base for most all opaque colors.

Flint glass, such as cut glass ware is made of, and sometimes the best kind of lamp chimneys, will answer the purpose. This should be pulverized so that it will sift through a 100-mesh sieve.

(To be continued.)

The clock in the courthouse in Independence, Mo., was put out of order the other day by a heavy wind, the clock tower being moved enough to dislodge one of the heavy pendulums, which fell on the stairway below, and narrowly missed the heads of several persons.

# C. DORFLINGER & SONS,

36 MURRAY STREET, NEW YORK.

Works, White Mills, Wayne Co., Penna.

Manufacturers of plain  
and cut Table Glassware  
of the highest quality.



## ENGLISH :: GLASS.

Large Assortment of  
FANCY VASES,  
GENTRE PIEGES and  
ROCK CRYSTAL STEM WARE,

Particularly adapted for the  
Jewelry Trade.  
Write for particulars.

Sole Agent for the Celebrated CAULDON CHINA.

**EDWARD BOOTE,**  
46 West Broadway :: New York.



Have You  
Received Our  
New Catalog?

**Maple City Glass Co**  
CUT GLASS TABLEWARE,  
Hawley, Pa.

SALESROOMS:

New York—H. B. Stites, 253 Broadway.  
Baltimore—Green & Thomas, 33 S. Ches-  
ter St.  
Boston—Sweetser-Bennett Co., 101 Tremont  
St.  
Buffalo—J. R. Stadlinger, 685 Main St.  
Indianapolis—J. A. Dugan Co., 22 S. C  
tol Ave.  
Duluth—Duluth Crockery Co., 6th Ave. S  
West St.  
Denver—Western Selling Co., 1617 I  
rence St.

## ORNAMENTAL HAT PIN HOLDERS

A Useful and Artistic Conceit in  
SILVER DEPOSIT ON GLASS

that contributes greatly to  
the appearance of any dresser

MADE IN A VARIETY OF HIGHLY ARTISTIC DESIGNS

Splendid sellers during the vacation period

**LACKNER & OHL**

50 Columbia Street

NEWARK, N. J.



Established 1879.

Manufacturer of

**LOUIS W. HRABA,**  **Fine Leather Goods,**

29 East 19th St., New York.

Exclusively for the Jewelry Trade.



**"Cantlose"**

THE NEW  
EYEGGLASS HOLDER

Practical Simple  
Safe Secure

Positively prevents loss of Glasses from  
Hook. The feature of this Hook is a "Hurdle"  
engaged by a "Loop," making a secure con-  
nection.

For Sale by Leading Optical Dealers  
**PAUL GOUGELMAN, N. Y.**  
37-39 Maiden Lane, New York City

# Ribbons

in stock and special designs **MADE TO ORDER,**  
in large or small quantities, to use with medals and  
for club purposes. ✂ ✂ Correspondence invited.

JOSEPH LOTH & CO., Manufacturers, 65 Greene Street, New York.

**JACOT MUSIC BOX CO.**  
IMPORTERS.

Stella and Ideal Music Boxes  
39 UNION SQUARE, N. Y.

**C**LOCKS, BRONZES  
COMMUNITY SILVER  
CUT GLASS, NOVELTIES

SEND FOR CATALOGUE

**H. BEALMEAR & CO.**  
234-236 Park Ave.  
Baltimore, Md.

# THE CONNOISSEUR



*Devoted to Art Pottery, China, Marbles, Bronzes, Cut and Decorated Glass Ware, Bric-à-Brac, Lamps, Art Metal Wares, Fancy Goods and Kindred Lines.*

## Collection of Greek and Roman Vases in the Metropolitan Museum of Art.\*

By GISELA M. A. RICHTER.

THE character of the newly acquired collection, brought together by the Messrs. A. and C. Canessa, is especially adapted to the present needs of the Museum. Hitherto the classical antiquities have been almost confined to the Cesnola collection of Cypriote sculpture and pottery, and these, from the very fact that they are all the fruit of excavations in their place, can give only a one-sided picture of Greek art. Since genuine pieces of ancient sculpture are now difficult to se-

period in the Cesnola Collection, but none that will compare with the large, two-handled cup (Fig. 1). It is a typical example of the later style (1200 B. C.). The clay is of the fine, well-sifted quality, and the shape, with the tall, narrow foot and the finely curved bowl, is a favorite type of the period. The decoration, like most Mycenaean designs, is taken from maritime life, and in this case consists of an octopus.

The Corinthian style is well represented. There are a number of small aryballoi, as well as amphorae and plates belonging to the VIII and VII centuries B. C.; also some examples of the later Corinthian style, when human and mythological sub-

vases with black figures painted on the red clay are fairly typical. The subjects represented are those characteristic of the period. Mythological scenes are common. Herakles is, as usual, the favorite hero; we have Herakles fighting the Cretan bull, Herakles and the Erymanthian boar, Herakles in contest with the Amazons. Among the vases with subjects taken from daily life is an "olpe" on which is represented a man, playing the lyre, surrounded by three female figures (Fig. 3, p. 101). Of all the black-figured vases in the collection, this is the most graceful in composition and the most careful in execution. It must have been made when this style was at its height,



FIG. 1.



FIG. 2.

it is fortunate that in Greek art the "minor antiquities" bear so much the same richness as the higher arts that original vases or coins convey the Greek spirit better than casts from more noted productions. The acquisition of this new collection is, therefore, a most valuable addition to the whole Greek department. Though it consists only of 300 pieces, its comprehensiveness is one of its chief features, and, although we have no one specimen of extraordinary interest, there are many fine examples, of value both from the artistic and the archæological point of view. As it is impossible in this short notice even to attempt to describe the collection in detail, all we can do is to give a selection of some of the best examples.

The earliest vases in the collection are of the Menaean style. There are several of this

subjects at last gained prevalence over the monotonous friezes of animals, which had hitherto been the main motif of decoration. A rare subject is depicted on a plate of this style (Fig. 2). A poet—at least so we must infer from the accompanying lyre—is lying on his death-bed. The picture is drawn in a simple, naive manner; there are no accessories, except a footstool, which is placed under the bier, and the lyre hanging against the wall. But the very simplicity of the conception offers a pleasing contrast to the later representations of a prothesis, or lying in state, where the death-bed is surrounded with a crowd of people, and where the lamenting women, hired for the purpose, tear their hair and rend their clothes to show the semblance of grief.

Almost one-half of the collection consists of vases of Athenian manufacture, of the black-figured and red-figured styles. It is in these that the chief interest lies. The

about 520 B. C., just before the new method gained ground, in which the figures, left in the red of the clay, stood out against a black background.

An interesting example of the transition period, when the first experiments in this new method were tried, is a krater or mixing-bowl, in which both styles are combined. On the front and back of the vase is painted, between two large eyes, a head of Silenus in the red-figured technique. Below the handles, however, we find winged genii, printed, as of old, in black color.

It is unfortunate that, unlike the Boston Museum of Fine Arts, the Metropolitan Museum owns no examples signed by one of the great masters of Attic vase-painting. The new collection does not supply this deficiency; the only signed vase is a kylix, without decoration, inscribed with the name of the "minor artist" Xenokles. However, in some cases, the style of a great master

\* From the Bulletin of the Metropolitan Museum of Art.



THE PERFECT SHAPE UMBRELLA

## "MAIDEN BALTIMORE"

IT IS now nearing the time when Jewelers are looking toward purchasing their stocks for the Fall and Holiday seasons in Umbrellas and Canes. We are prepared with our line, which we have specially designed for the Jewelry Trade. It consists of rare novelties, and things entirely new and exclusive.

Our Detachable Handle Umbrella has met with great favor, and will increase your Umbrella Business, as it is the only one on the market without levers, springs or screws.

We make Umbrellas from \$1.50, with Sterling Silver and Gold Handles, up to \$125.00 each, and Canes from 50 cents up to \$25.00 each. *Send for a Selection, Express paid.*

No Springs  
No Screws  
CAN BE PUT  
IN A TRUNK

## SIEGEL, ROTHSCHILD & CO.

MAKERS

418-420 West Baltimore Street, BALTIMORE, MD.

NEW YORK SALESROOM 353 Broadway      PHILADELPHIA SALESROOM 1011 Chestnut Street



# FANS

FAN SEASON is here, and we are prepared for it with the choicest that has ever been imported from Paris. These dainty creations are appropriate for Graduation, Confirmation Weddings, and in fact for any occasion where taste and exclusiveness are requisite.

SEND FOR A SELECTION, MENTIONING PRICE

## LEWY & COHEN

530 BROADWAY NEW YORK

Importers of Fans, Brooches, Mounted Side Back Combs, French Head Necklaces in mother pearl effects, and THE "MEDICI CHAIN," a French creation in fan chains.

# FANS

Headquarters for the most exclusive line in this country  
SPECIALLY DESIGNED FOR THE FINE JEWELRY TRADE



## NECKLACES

Imitation Pearl and Fancy Bead, in all newest shades and exquisite colorings. Write for Samples, mentioning price

## LOUIS STEINER, Importer,

520 & 522 Broadway  
NEW YORK

# ROSARIES



Of Foreign and our own Manufacture  
\$2.40 per Dozen up.

## SIGNET JEWELRY

Memo. Orders Solicited.

# L. Witsenhausen

47-49 Maiden Lane  
New York.

Manufacturers of MODERN JEWELRY  
Chicago, 405 Masonic Temple  
(L. KATLINSKY.)



## E. H. H. SMITH SILVER CO.

BRIDGEPORT, CONN.

Silversmiths' Building,  
CHICAGO, ILL.

Manufacturers of  
**Sterling Effects in Plate**  
Write for our new catalogue.

THE OAK.

be detected. On a cup of the red-figured style are represented two youths in kneeling posture, one holding a kylix, the other a skyphos (Fig. 4). The position suggested in the attitude of the figures, and the lithe, nimble bodies of the youths, recall the splendid compositions of Euphronios. But, though we find in our picture the rush of life and feeling for decorative grouping so characteristic of the master, the execution is too sketchy to allow us to see in it an original work. All



FIG. 3.

we can claim for it is that it came from a workshop in which the influence of Euphronios was strongly felt.

A kylix, also of the early red-figured period, but, unfortunately, much restored, reminds us of the work of another great master, the painter Duris. The interior is decorated with the figure of a youth, singing to the music of the lyre, and on the outside are represented scenes of revelry. Even in the quiet abandonment of the singer and in the somewhat studied action of the revellers, the style of Duris is apparent; but, again, the execution is careless and precludes the possibility of a master's hand.

Of the "fine period" of the red-figured style there are several good examples in the



FIG. 4.

collection. To this period belongs a large kylix of excellent preservation and very fine clay (Fig. 5). The subject consists of three Amazons setting out for battle. Each is fully armed with spear or battle-axe and a shield; one is holding her horse as the other two are advancing on foot. An enemy is in sight, but this determined group can only be directed against a foe. The scene is all the breeze of action in the figures, and this is combined with careful drawing and minute attention to detail. One feature in the drawing must be noticed—the figure of the Amazon leading her horse is represented full face. This is

rare in Greek vase-painting. As a rule, even when the body is represented front view, the face is in profile or three-quarter view, not only because to depict a face in profile is easier, but because the people represented are generally busied with some oc-



FIG. 5.

cupation which makes them turn to the fellow-actors in the scene.

A shape which was used at all times in Greek vase-painting is the rhyton, or cup terminating in the head of an animal. The purpose of this must have been that the cup should not be set down, but its contents drained at one draught. The specimen in the collection (Fig. 6) terminates in a bull's head, which is finely modeled, and of peculiarly life-like expression.

A beautiful example of the "graceful period" in the red-figured technique is a skyphos, with a toilet scene on one side and an unexplained subject on the other (Fig. 7). The drawing is of unusual refinement, and the figures so gracefully posed that the whole composition has a great charm. The subject represented on our



FIG. 6.

plate is difficult to explain, because the character and purpose of the object on the woman's lap is, as yet, unknown, and since the interest of the scene seems to be centered in it, we cannot find an explanation without it. This object occurs only on a few other vases, and in each case it is

impossible to identify its use. The possibility that it is a musical instrument is excluded by the fact that it rests on a stand and that the strings are placed cross-wise. The most probable solution is that it was used as an incense-burner in some ritual.

As the art of vase-painting declined in Athens, recourse was taken to various devices which should make up for inferior execution. White and gilt were profusely used to enliven the effect of the picture, and often a plastic figure was attached to the vase so as to dispense with painting



FIG. 7.

altogether. The Sphinx (Fig. 8) is a beautiful example of this tendency, and shows that even at the time when decadence was beginning to set in, the Greek feeling for form was slow to die. The dainty pose of the figure and the calm expression of the face still recall the best period of Greek art.

The proportion in which the different styles occur in this collection is seen by the number of cases they severally occupy. The vases of early Greek styles fill two cases out of a total of 21. Twelve cases are taken up by the Athenian black-figured and red-figured ware, including also a number of white funeral lekythoi. The seven remaining cases are occupied partly by the products of Greek colonists of South Italy, partly by Roman ware, and partly by Etruscan vases. The vases of Southern Italy (IV and III centuries B. C.) are mostly



FIG. 8.

of the Apulian style, but there are not a few examples in which figures in the round or in relief form the only decoration. Of Roman ware we have several lamps, dating from early imperial times, and bowls, imitations of the Arretine fabric. The Etruscan vases consist of specimens of the black Bucchero ware, of which the museum already owns a number, and some painted vases of the VI century B. C. These are imitations of the black-figured style, but the comparison only brings out the beauty of Greek ware.



# SPECIAL NOTICE

Our line of samples of European Novelties will be withdrawn on July 1st.

Jewelers seeking a collection of choice pieces should not fail to inspect this display. *~ ~ ~ ~ ~*

## C. F. RUMPP & SONS Fine Leather Goods

NEW YORK SALESROOMS  
683 and 685 Broadway

PHILADELPHIA

# The Thimble House.



No. 149.

Thimbles are not a side line with us—They are our main business. We study Thimbles, our designers study thimbles, our workmen study thimbles—The result is the finest and largest line of Thimbles on the Market.



No. 136.

## KETCHAM & McDOUGALL,

Manufacturers,

37 @ 39 Maiden Lane, New York.

Send for Catalogue.

Established 1832.

ALSO MAKERS OF THE NEW AUTOMATIC EYE-GLASS HOLDERS.

## FAIRCHILD & COMPANY

225 to 233 Fourth Ave.

NEW YORK CITY.

Manufacturers of GOLD PENS, PENCILS, PENHOLDERS, SEGAR CUTTERS, SPECIALTIES, PENCILS SET WITH JEWELS.

Style, quality and workmanship acknowledged the very best.



## JAS. C. HOE'S SONS

10 Liberty Place  
Near Maiden Lane  
NEW YORK

Manufacturers of High Grade Wall Show Cases and Jewelers' Fixtures

INTERIOR REFITTING of STORES and OFFICES A SPECIALTY.

Write for Estimates  
Finest references given if desired

Established 1820

## TRADE-MARKS

OF THE JEWELRY AND KINDRED TRADES.  
Over 4,000 Marks. Second Edition. Price, \$3.00.  
The Jewelers' Circular Pub. Co., 11 John St., N. Y.

## Expert WATCH and Chronometer REPAIR FOR THE TRADE.

When others fail you we guarantee satisfaction. A trial will convince. Prices very reasonable.

List will be sent on request.

G. OHAN, 37-39 Maiden Lane, Lorsch Bldg., Room 27. NEW YORK

## Fliaasof Bros. & Co.

IMPORTERS AND JOBBERS OF

## DIAMONDS WATCHES JEWELRY

9-11-13 MAIDEN LANE, NEW YORK.

100 STATE STREET, ALBANY, N. Y.



A LARGE ASSORTMENT OF DIAMOND MOUNTED JEWELRY CARRIED IN STOCK.

## DIAMOND POINT FOUNTAIN PENS



No. 2WC \$7.50 per dozen. Guarantee in every box.

Largest Manufacturers of Popular Price Fountain Pens in the United States.

Send for Illustrated price list of 14-Kt. Gold Fountain Pens.

Good case assortment 1 dozen pens, \$9.00.

DIAMOND POINT PEN CO.

100-102 Beckman Street, New York

# Reduced Rates for Telephone Service

throughout Greater New York are effective from July 1st. Contracts now being taken at new rates.

Call nearest Contract Office for full information.

## NEW YORK TELEPHONE COMPANY

<i>Contract Offices:</i>	<i>Telephone No.:</i>
15 Dey Street	9010 Cortlandt
15 West 38th Street	9040 38th
20 West 124th Street	9000 Morningside
16 East 150th Street	9020 Melrose

# SIGNS

AN attractive front is a business necessity. Artistic signs are an important adjunct. We make the right kind.

"No trouble to ship out of town."

**THE FORMAN CO.**  
SIX LIBERTY PLACE  
MARMAIDEN LANE - NEW YORK.

## "Perfect Yourself"

ENGRAVING and EXPERT WATCH WORK.

Take a Post-Graduate Course.

**RIES & ARMSTRONG, Macon, Ga.**

## Encyclopedia-Dictionary

A reference hand-book of the Ophthalmic Sciences.  
Price, \$2.50.

Jewelers' Circular Pub. Co., 11 John St., N. Y.



Above Cut Shows Our  
**METAL SPINNING LATHE**

We manufacture these lathes in sizes from 12-inch to 44-inch Swing, and can equip sizes 18-inch and larger with our Chucks for oval work.

Write for Catalogue  
**P. PRYIBIL, 512-524 W. 41st St., New York.**

## REMOVAL NOTICE

We now occupy the new store of

**The Lorsch Building, 35 Maiden Lane, N. Y.**

# WOLFSHEIM & SACHS

MAKERS OF

Fine Boxes, Trays and Novelties for Jewelers and Silversmiths

**35 MAIDEN LANE, N. Y.**

Telephone, 3518 John.

Factory, 10 Gold Street.

*Mercantile Fountain Pen*

## The Best Self-Filling Attachment

made and guaranteed by

**AIKIN, LAMBERT & CO., 19 Maiden Lane, NEW YORK.**

Retail Price:

\$3.00

\$3.50

\$4.50

Send for Price Lists and Discounts.

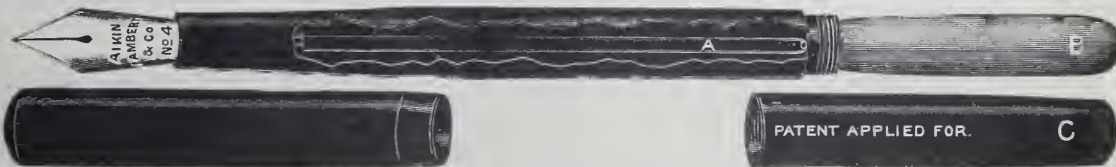



**HERPERS BROS.,**  
MAKERS OF  
**BRACELET SETTINGS**  
IN 10, 14 AND 18 KARAT GOLD  
AND IN PLATINUM.  
ALSO A COMPLETE LINE OF  
GALLERIES AND FINDINGS.

OFFICE AND FACTORY NEWARK, N. J., U. S. A.  
NEW YORK BRANCH 41-43 MAIDEN LANE

12 NEW PATTERNS

**Opportunity**  
Knocks at everyone's door at least once  
This is yours if you would realize full  
value on your sweeps, etc.

**CONLEY & STRAIGHT**  
Gold and Silver Refiners,  
Assayers and Sweep Smelters,  
236 EDDY STREET, - PROVIDENCE, R. I.  
Dealers in Fine Gold, Silver and Copper. All kinds of Gold and Silver Anodes

**JAMES J. DONNELLY,**  
Gold and Silver Electro Plater  
Fire Gilder and Colorer,  
41 and 43 Maiden Lane, New York  
Prompt Attention Given to Mail Orders.

**WM. F. RENZIEHAUSEN CO.,**  
**GOLD and SILVER REFINERS**  
Sweep Smelters, Assayers and Analytical Chemists  
Rolling of FINE AND STERLING SILVER a Specialty.  
Long Distance Telephone, 3759-R. 45-49 Oliver Street, NEWARK, N. J.

**F. JEANDHEUR, Jr.**  
Rear 17 John St., N. Y. Third Floor  
Gold and Silver Plating  
SPECIAL WORK AND COLORING  
IN ALL SHADES A SPECIALTY.  
Established 1868. Platina Plating

**JOHN S. STIVEN**  
Gold and Silver  
Chaser.  
Room 219, Electrical Exchange Building,  
156 LIBERTY STREET. NEW YORK

Frank Dederick. Established 58 Years. James E. Dederick.  
**James H. Dederick's Sons,**  
Assayers and Bullion Dealers.  
All qualities of Gold and Silver, in Plate, Square and Round Wire, Rolled  
to any gauge.  
ALL QUALITIES OF GOLD AND SILVER SOLDER.  
16 Maiden Lane, NEW YORK.  
We buy Old Gold and Silver.

**WATCH REPAIRS**  
FOR THE TRADE ONLY  
WE BEAT THEM ALL!  
in Prices and Quick Service  
**MAEBERT & REISS**  
71 and 73 Nassau Street - NEW YORK



**HERMAN KOHLBUSCH, Sr.,**  
ESTABLISHED 1859.  
Manufacturer of Fine Balances and Weights  
for every purpose where accuracy is required.  
Office and Salesroom, 194 BROADWAY, NEW YORK.  
Send for Price List. Tel. 370 Cortlandt.



**A. Nonnenmann & J. Aschenbrenner**  
114-118 East 23d St., New York.  
**Original Designers** for Platinum Gold and Silver Jewelry. Artistic Designs for Silverware and Novelties finished at shortest notice.



**HONEST AND PROMPT RETURNS FOR YOUR OLD GOLD, SILVER FILINGS, SWEEPINGS &c.**

**WE BUY**  
Old Gold and Silver Filings, Polishings, Sweeps, Hand Washings, etc. We will make accurate valuations and hold consignment subject to your acceptance. If valuation is not satisfactory, we reship to you at our expense.

**WE PAY FOR OLD GOLD:**

22 K. 88c. per dwt.	12 K. 48c. per dwt.
20 K. 80c. " "	10 K. 40c. " "
18 K. 72c. " "	8 K. 32c. " "
16 K. 64c. " "	6 K. 24c. " "
14 K. 56c. " "	4 K. 16c. " "

MARKET RATES FOR SILVER AND PLATINUM.  
Try us and you will appreciate our Squareness, Promptness and Accuracy.

**T. B. HAGSTOZ, Ltd.,** Main Office, 709 Sansom St., Philadelphia, Pa.  
SMELTERS, ASSAYERS, REFINERS.

**WE SELL**  
Gold, Silver and Platinum, various qualities, rolled flat or drawn to wire of any gage.

**PRICES OF ALLOYED GOLD:**

10 K. 48c. per dwt.	14 K. 64c. per dwt.
12 K. 56c. " "	16 K. 72c. " "
18 K. 80c. per dwt.	

Gold and Silver Solder, either from formulas furnished or our own. "T. B. H." Alloy, 25c. per oz. Gunmetal, 75c. per lb. Shot Copper, 40c. per lb. We will send tables for alloying without charge. They save figuring.

**PLATINUM AMERICAN PLATINUM WORKS**  
NEW YORK OFFICE 41 Cortlandt Street NEWARK, N. J.





B 2624



B 2815

# BROOKLYN BRISTOL CASE

*"It's the little things in life  
that count."*

We thought we had considered  
*every* feature when we put the

## *Brooklyn Bristol Case*

on the market to take its place in the  
lead of all other 25-year cases—but by  
constant study our experts have added  
a new feature—

*A Combination of Green and Yellow  
Gold Color Effects.*

Can you realize the artistic beauty  
of the engine turning all around the  
shield in case 2624, being a delicate  
green, while the rest of the case carries  
a rich yellow gold color?

The contrast is very  
marked and the effect adds  
more real beauty to the case  
than one would imagine  
possible.

JOSEPH FAHYS & CO.



B 2907



B 2779

# The Only Middlemen



KNOWN TO THE CUSTOMERS OF

## J. R. Wood & Sons,

DIAMOND CUTTERS,

2 Maiden Lane,

NEW YORK.

# PROGRESS

## New York's New Under-ground Railroad Built by "the Ring."

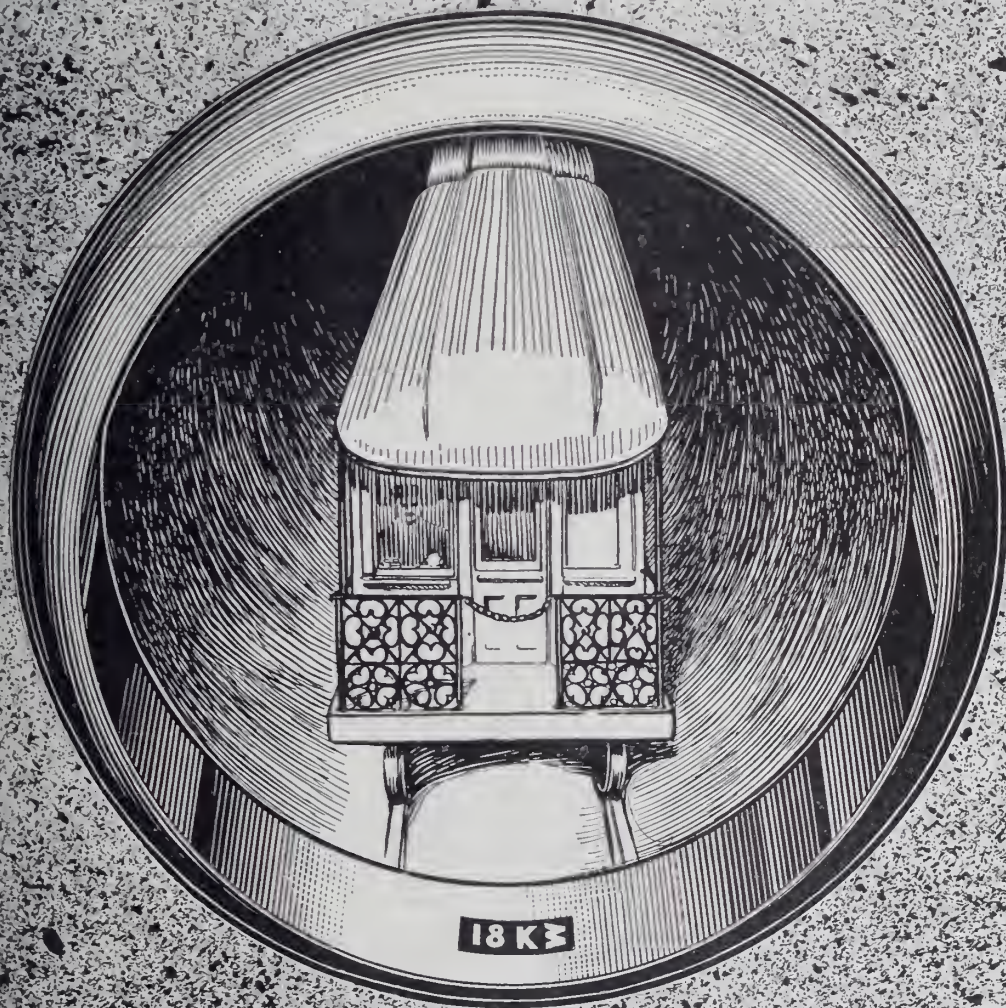

Makers of Plain Rings for Over 50 Years

Maiden Lane

NEW YORK

# Design, Workmanship, Quality and Durability

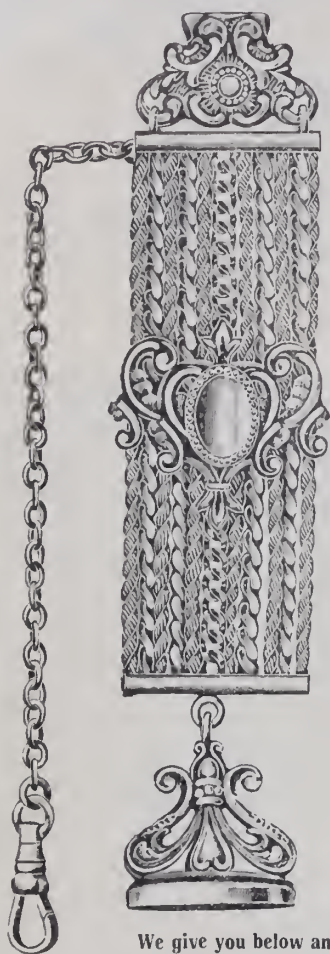

are the four factors which have made the

## BIGNEY CHAINS

the most popular in the market to-day. They are handled and worn by more people than any other make.



We give you below an exact copy of an assay of chains manufactured by the leading chain makers of the United States.

1-10 GOLD FILLED WATCH CHAINS, MINUS BAR AND SWIVEL.

Number	Gross Weight		Fineness	Value	Maker	Chain Number	Cost
	Ounces	Dec.	Gold 1000ths				
15		71	29½	\$0.43	S. O. Bigney & Co. - - - -	1155	\$2.85
16		75	50	.775		482	3.08
17		81	34	.57		3005	2.73
18		76	23½	.37		9533	2.97
19	1	00	16½	.31		83	2.14
32		52	49½	.53		213 X	2.83
34		73	34½	.52		733	2.41
46				.58		5011	3.82

1-8 CHAINS, MINUS BAR AND SWIVEL.

Number	Gross Weight		Fineness	Value	Maker	Chain Number	Cost
	Ounces	Dec.	Gold 1000ths				
35		57	68	\$0.80	S. O. Bigney & Co. - - - -	1604	\$3.96
36		60	65¼	.81		7015	3.75
37		60	63	.78		4324	4.00
47		49	79	.80		2726	4.00

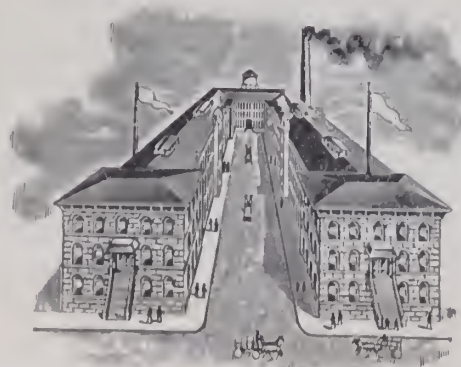

# S. O. Bigney & Co.

NEW YORK OFFICE,  
3 MAIDEN LANE.

FACTORY, Attleboro, Mass.

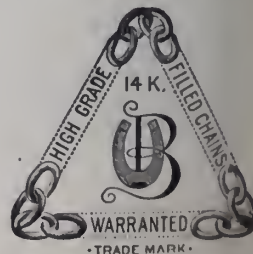

# Watch Case Makers, Remodelers and Repairers.



How an English Case Came to Us.



How it was Remodeled for Amer. S. W. Movement.

**SPECIAL CASES  
MADE TO ORDER  
FOR ENGLISH, SWISS  
AND  
AMER. MOVEMENTS.**

**MELTING OLD GOLD  
CASES AND MAKING  
OVER INTO NEW  
CASES (USING SAME  
GOLD) A SPECIALTY.**

**ENGLISH CASES  
CHANGED TO FIT  
AMERICAN S. W.  
MOVEMENTS  
WITHOUT  
ALTERING OUTSIDE  
APPEARANCE.**

**KEY WIND CASES  
CHANGED TO STEM  
WIND.**

**HUNTING CASES  
CHANGED TO  
OPEN FACE.**

**OLD WATCH CASES  
REPAIRED AND  
RENEWED.**

## Wendell & Co.,

2

**WONDERFUL SHOPS:  
103 & 105 William St.,  
NEW YORK.  
57 Washington St.,  
CHICAGO.**

# New Claws on Diamond Rings.

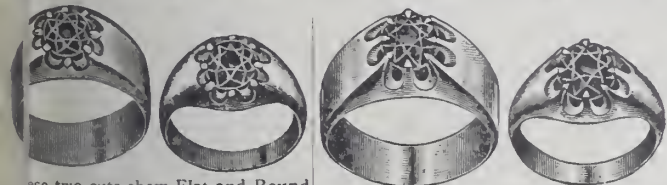

These two cuts show Flat and Round Better Rings as received, with claws worn off and too low to permit setting stones again.

These cuts show the same rings with new high claws, stones securely reset, and entire rings refinished like new.

Price for six new claws, resetting stone and refinishing ring like new .....\$1.50 to \$3.00, list.

Price for eight new claws, resetting stone and refinishing ring like new .....\$2.00 to \$4.00, list.

We retip or put new claws on diamond Tiffany, Belcher, Tooth and rings of every description, to cost from \$1.50 to \$4.00, list, according to the condition of ring and number of claws on setting.

## Wendell & Company,

103 and 105 William St., NEW YORK. 57 Washington St., CHICAGO.

For 22 years we have been doing

# Gold and Silver Plating.

Sterling and Plated Ware Repairing for the Trade.

Do we do yours?  
Our plating rooms are the best equipped in the country for job work.



How It Came In.

### WE REPAIR

any article in the silverware line; making new parts to match the old ones that have been melted or broken off, the same as new.



How It Went Out.

### WE REPLATE

any metal article in gold, silver, nickel, bronze, brass, oxidized silver, old bronze, statuary bronze, and all antique finishes.

## Wendell & Company,

Repairers and Special Manufacturers for the Retail Jewelry Trade  
**TWO WONDERFUL SHOPS:  
103 and 105 William Street, NEW YORK. 57 Washington Street, CHICAGO.**



# Stone-Setting.

We carry a most complete stock of Precious and Semi-Precious Stones for special work and replacing lost sets. We import them direct from the cutters in Europe, and furnish them to the trade in single stones at dozen and gross prices.

Have your stone-setting done in our shops and save from thirty-five to fifty per cent.

We employ first class setters, and turn out work very promptly.

No job too small to receive our careful attention.

# Gold Chains Refilled, Renewed and Repaired.

Old Chains made over into new patterns, using same gold.

**GOOD WORK. LOW PRICES. PROMPT ATTENTION.**



Sample Job as Received.



As Delivered.



Fancy Link Chain as Received for Renewing.



As Delivered.

## Wendell & Company,

The Special Manufacturers for the Retail Jewelry Trade.

**TWO WONDERFUL SHOPS:  
103 and 105 William Street, NEW YORK. 57 Washington Street, CHICAGO.**

# WADSWORTH

## 14-Karat Solid Gold Cases

THE EXCELLENCES which have given pre-eminence to **WADSWORTH WATCH CASES** reach their highest development in these Solid Gold Cases. Here the standard of the purchaser can be no higher than that of the manufacturer. A Case of Highest Quality.

THE PATTERNS and Models of the **WADSWORTH 14-KARAT SOLID GOLD WATCH CASES** are fine examples, embodying the Shapes and Designs most in line with prevailing phases of popular taste. They have strong, salable qualities, especially in view of reasonable prices.



**WADSWORTH**  
**14-Karat**  
**Solid Gold**



?

?

?

Do the retail jewelers appreciate what they were paying for 12 Size movements before our 12 Size was on the market?

Do the retail jewelers appreciate what they were paying for O Size movements before our O Size was on the market?

Do the retail jewelers stop to consider what they would be paying for movements if there was not an independent watch company manufacturing a complete line of superior watches?

ILLINOIS WATCH COMPANY  
SPRINGFIELD



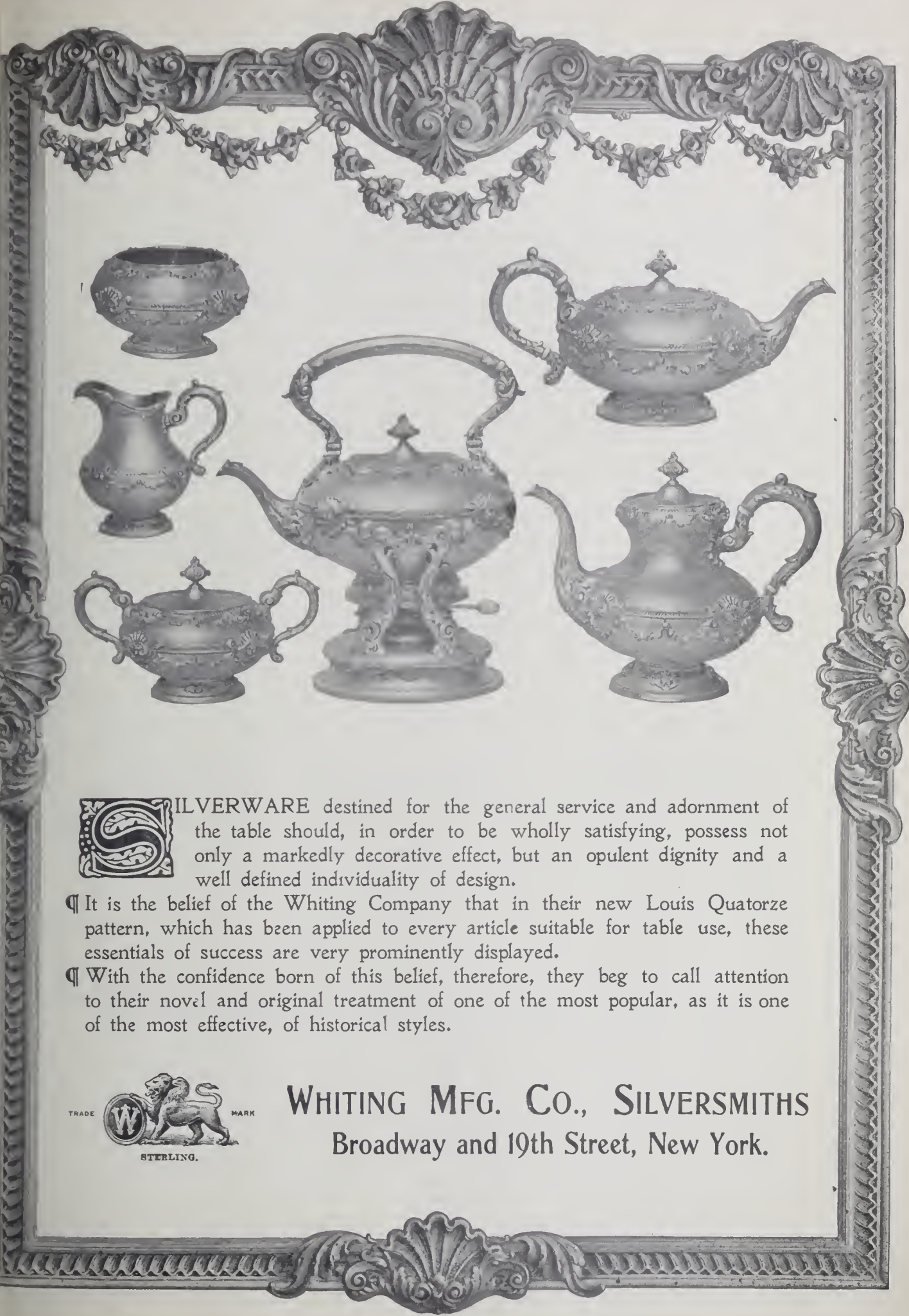

**S**ILVERWARE destined for the general service and adornment of the table should, in order to be wholly satisfying, possess not only a markedly decorative effect, but an opulent dignity and a well defined individuality of design.

¶ It is the belief of the Whiting Company that in their new Louis Quatorze pattern, which has been applied to every article suitable for table use, these essentials of success are very prominently displayed.

¶ With the confidence born of this belief, therefore, they beg to call attention to their novel and original treatment of one of the most popular, as it is one of the most effective, of historical styles.



**WHITING MFG. CO., SILVERSMITHS**  
 Broadway and 19th Street, New York.

## **Dueber Watch Cases**

## **Hampden Watch Movements**

“Dueber-Hampden” stands for honesty, integrity and consistency. Added to these qualities the talent and energy devoted to the development of

### **DUEBER-HAMPDEN WATCHES**

have earned for them the enviable reputation of

## **The**

## **Leading American Watch**

Made in all sizes and sold only as complete watches in 3/0 size and 12 size, cased in solid gold and gold filled cases of the most artistic designs.

## **The W. J. JOHNSTON COMPANY,**

Wholesale Agents of the Leading American Watch Companies,

**Fifth Avenue and Market Street, Pittsburgh, Pa.**

# **The W. J. JOHNSTON COMPANY,**

Wholesale Agents of the Leading American Watch Companies,

**Fifth Avenue and Market Street, Pittsburgh, Pa.**

---

---

## **Hamilton Watches**

## **Illinois Watches**

Made to be sold by live, progressive, American Retail Jewelers who realize the credit to be gained from selling reliable, accurate time pieces.

---

---

Protection to the Retail Jeweler is the "watchword" of The Hamilton Watch Co and The Illinois Watch Co., and every effort will be made to restrict the sale of these watches to the Legitimate Retail Jeweler.

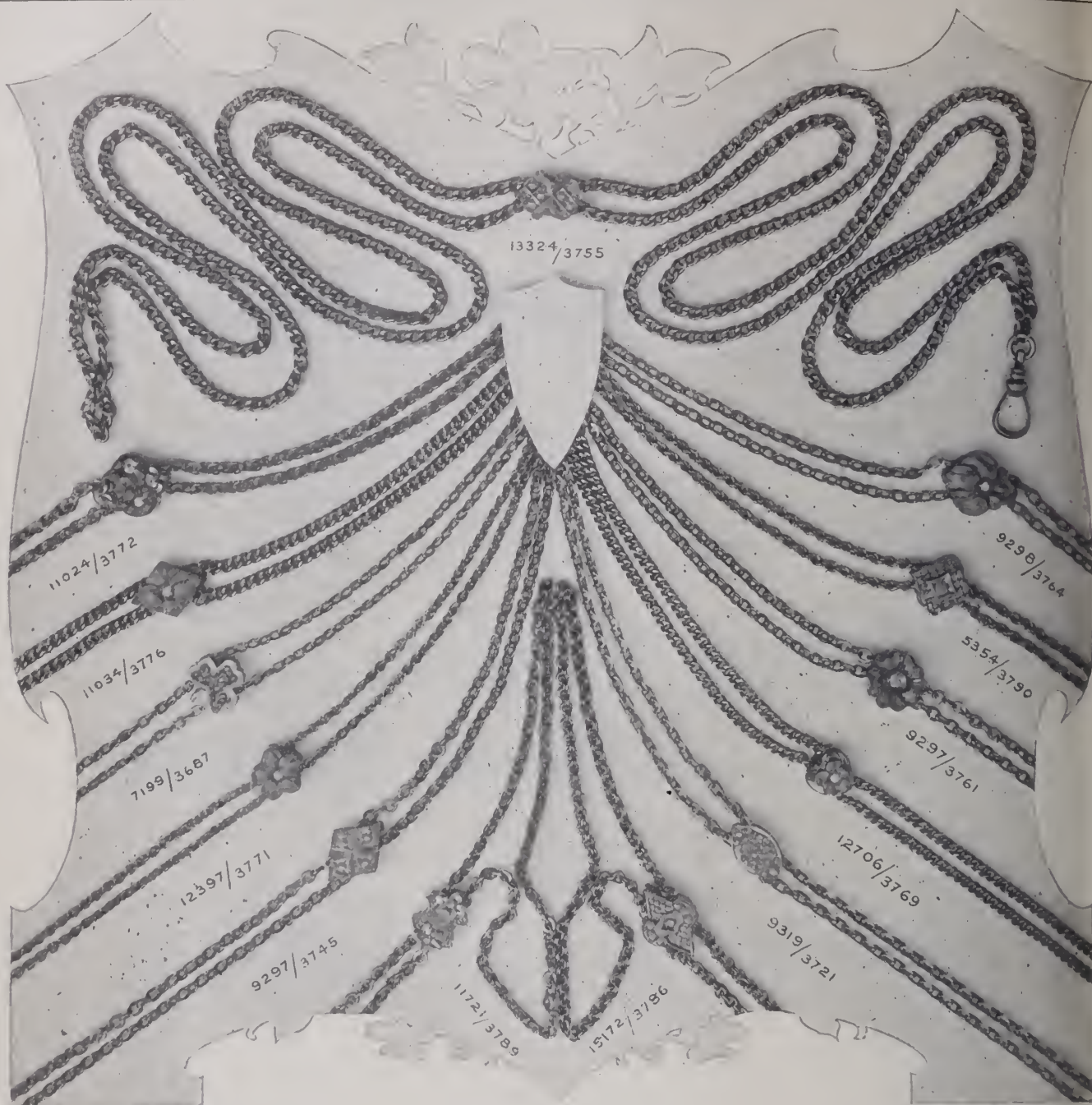

**T**HESE Simmons Chains with enameled gold slides made so distinct a hit the first of the year that there isn't any sort of doubt about their being very popular sellers this Fall. ¶ The exquisite color-beauty of the enameled slides can be realized only when you see the line at your jobber's. ¶ This idea originated with us—if you want the original enameled slide chains, be sure to get the **SIMMONS**.

R. F. SIMMONS COMPANY, Main Office and Works, ATTLEBORO, MASS.  
Salesrooms, 9-13 Maiden Lane, New York; 42 Madison St., (Heyworth Bldg.), Chicago.

*"We never follow the Fashion, the Fashions Follow Us."*

MAURICE L. POWERS.



JOSH W. MAYER.

## SATISFYING

**I**F you believe the men with the greater capacity have the power, developed by their master efforts, to insure, for the products with which they begin, benefits beyond the scope of their contemporaries, our Diamond Jewelry must satisfy your every demand. It is made by an organization that produces the highest grade of ready selling Jewelry of the lowest, medium and higher prices, to be found in this market, thus insuring a complete ensemble which is unapproachable.

Our Bracelet stock, which is nearing completion, is a marvel. It is impossible to describe this remarkable assortment and the only way to do it the fullest justice is to have you view our FOURTH ANNUAL EXHIBITION which takes place between August 13th and 18th, inclusive, when you will be fully convinced that whatever is said in these weekly announcements will be verified by what is displayed. If there is a possible chance for you to reach New York during this display, make it convenient to do so. It will repay you in many ways.

Once a visit always a visit.

## POWERS and MAYER,

Makers of Diamond Mounted Jewelry THAT SELLS.

258-260 Fifth Avenue,  
NEW YORK.

We are always pleased to ship goods on memorandum when satisfactory references are given.

# R., L. & M. Friedlander

IMPORTERS OF  
**DIAMONDS**

JOBBER IN  
**American Watches**

**Wholesale Jewelers**

30 Maiden Lane  
NEW YORK CITY

97 Hatton Garden, London, Eng.

---

## SUMMER NOVELTIES

Advance Styles in

### COMBS

We are fully prepared with a  
large variety of

#### COMBS

GOLD MOUNTINGS, with or without  
Diamonds, from \$2.00 to \$250.00 each.

GOLD FILLED, with or without Stones,  
from 75c. to \$4.00 each.

We herewith illustrate a few  
designs and quote lowest  
cash prices that speak for  
themselves. Freshen your  
stock by sending for some  
without delay. These goods  
afford a generous profit to  
the dealer and make new  
and pleased customers

No. 5,000	- -	\$1.80
No. 5,001	- -	1.80
No. 5,002	- -	1.80
No. 5,003	- -	1.80
No. 5,004	- -	1.60
No. 5,005	- -	2.40

LESS 6% FOR CASH

No Combs sent on Memorandum



*Our Mr. Richard Friedlander sailed last week on the Oceanic. The DIAMONDS selected by our Mr. Louis Friedlander, who has recently returned, have arrived and are now on sale.*

# Three New Patterns

---

---

OUR SALESMEN are starting on their display trips, and are showing a very large number of new designs in Ladies' and Gentlemen's Card Cases, Photo Frames, Baskets, Jewel Cases and other Novelties, and three new and original patterns in Toilet Sets and Manicure Articles.

For over 45 years we have enjoyed the distinction of originating the handsomest and best selling patterns in sterling toilet ware, flat ware and napkin rings, and in the present offerings we excel all our previous efforts. Our etched effects supersede anything on the market at present.

Determine now to see these new creations; it will pay you well, and an opportunity will be lost if you neglect it.

These entire lines will also be on exhibition at our New York Showrooms.

TRADE  MARK.

## R. BLACKINTON & CO.

ESTABLISHED 1861.

3 MAIDEN LANE, NEW YORK

Factory, North Attleboro, Mass.

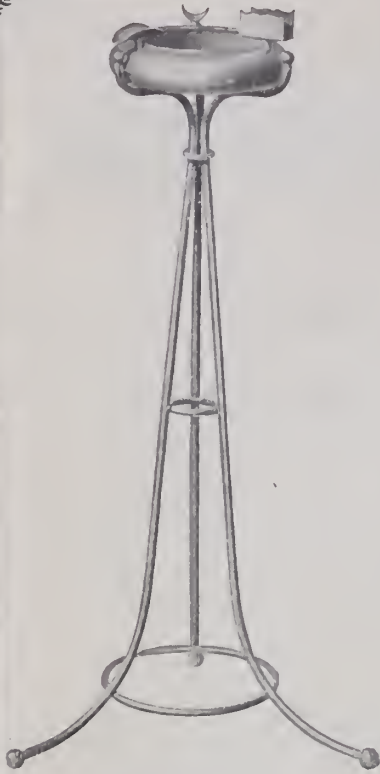

No. 927.  
24 7/8 inches high.

## FOR SMOKERS' COMFORT

☞ Many a gentleman after a hard day's work desires to enjoy himself by smoking in peace and quietude at his home.

☞ The Sternau Ash-receiver, illustrated here, facilitates the enjoyment.

☞ It is gold-lined and fitted with three rests—two for cigars and one for safety match-box.

☞ Made exceptionally well in Copper, Old and Polished Brass, Nickel and Silver Plate.

☞ Jewelers should have a stock of our ash-receivers and other smokers' articles, which are in demand, because they are both useful and ornamental.

## S. STERNAU & CO.

New York Showrooms:  
Broadway, and Park Place,  
Opposite Post Office.

Office and Factory:  
195 Plymouth Street,  
Brooklyn, N. Y.

*Makers of Coffee Machines, Chafing Dishes and their Accessories, Fancy Kettles, Trays, Etc.*

Ask Your Jobber

for the

# CLOVERETTE.



A Few Reasons Why  
**BLACKINTON CHAINS**  
are best for the Retailer:

---

Every Blackinton chain bears our trade-mark.

The quality is stamped on every chain.

Blackinton chains are finished by the "Wearbest" hardening process, which toughens and hardens the gold, greatly increasing the wearing qualities of the goods.

Blackinton chains are all soldered with gold solder, making each joint an integral part of the chain.

Retail jewelers get three Globe Filled W. & S. B. ★  $\frac{1}{8}$  chains free for every 100 Blackinton chains they buy; two for 75; one for 40.

Retail jewelers have a chance to win either a Touring Car, a Runabout, a Motorcycle or a Watchmaker's Lathe, all of which we give away next January.

We recognize the rights of the legitimate jewelry trade and we DO NOT SELL DEPARTMENT STORES.

Every innovation we have produced has been flatteringly endorsed by our competitors, who have invariably adopted our methods.

---

**W. & S. Blackinton Co.**  
NORTH ATTLEBORO, MASS.



## THE Bracelet Hit OF THE Season.

THE illustrations, which are exact size, show two of the best selling Bracelets of a big bracelet season.

Made of Rolled Plate, Pierced, Engraved—a neat, strong joint and catch—with and without stones, from  $\frac{1}{2}$  to  $1\frac{1}{4}$  inches wide.

Our line offers an unsurpassed range of styles.

ASK YOUR JOBBER—HE HAS THEM.

**WHITING & DAVIS, Plainville, Mass.**  
NEW YORK OFFICE, 7 MAIDEN LANE.

**ROCKFORD SILVER PLATE COMPANY**  
ROCKFORD, ILL.

*Only  
Retail  
Jewelers  
Can  
Buy  
It*



*Rockford  
Silver  
Plate  
Co.  
Made  
It*

Watchword of the Craft—"Stand By Those Who Stand By You"

# GOLD RINGS

## BROOCHES AND MOUNTINGS

Also GOLD FILLED RINGS, including the popular THREE CROWN

Ostby & Barton Company respectfully announce to the jobbing trade that their fall line comprising many new and original designs is now ready.

### OSTBY & BARTON COMPANY

New York, 13 Maiden Lane  
Chicago, 103 State Street

PROVIDENCE, R. I.



No. 32  
PATENTED

## BATES & BACON,

Attleboro, Mass.

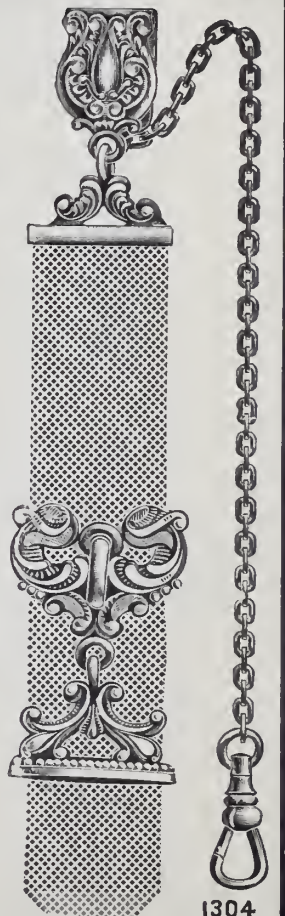

The  
New  
"Bates"  
Bracelets

"KANT-KUM-OFF"  
Made in Seven Sizes

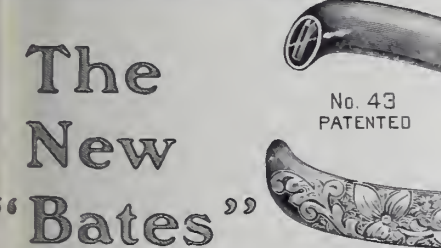

No. 43  
PATENTED

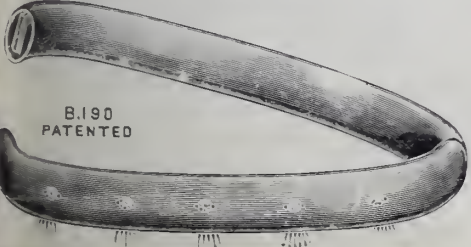

B.190  
PATENTED

OFFICES:  
NEW YORK,  
9 Maiden Lane.  
CHICAGO,  
103 State Street.

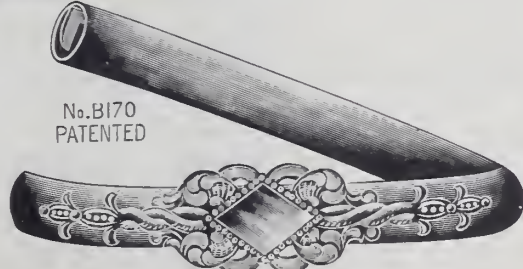

No. B.170  
PATENTED

### HIGH GRADE CHAINS.

The BEST SAFETY FOB is one of our specialties; Gent's Vests, Dickens, Lorgnettes, Secret Locket Chains, Locketts and Chatelaines.

1304

# The "Bryant" Rings.

WE have made the **Bryant Rings** for 50 years, and know how to make first class goods. The stone setting—which every retailer knows is a very important part of the work—we give special attention to. The **Bryant Rings** will help your reputation as a first class Jeweler.



TRADE-MARK.

**M. B. BRYANT & Co.,**

No. 7 MAIDEN LANE  
NEW YORK.

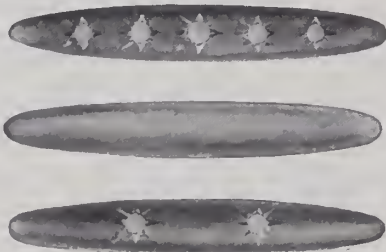

Quality and Finish Consistent  
with twenty years' experience.  
Original and Exclusive Designs.

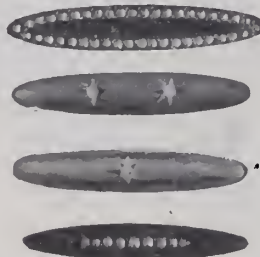

**MOORE & SON,**

ESTABLISHED  
1886.

NEWARK, N. J. INCORPORATED  
1903.

## SIGNET RINGS



**Geo. O. Street  
& Sons**

Est. 1837

24 John St., New York.  
103 State St., Chicago.

**ROBERT DULK**  
DESIGNER,

Etching in Gold and Silver  
Telephone, 3960 Chelsea.

No. 70 5th Avenue, NEW YORK.

# The Bowden Rings

ARE COMPLETE IN VARIETY, CORRECT IN  
QUALITY AND PERFECT IN FINISH. WE  
MAKE EVERY VARIETY OF FINGER RINGS.

**J. B. BOWDEN & CO.,**

1 Maiden Lane.

NEW YORK.



*Art is everything, and everything is art.*

The man who makes the jewelry is as much of an artist as the man who sells it. In our case he is more. With the class of goods our workmen turn out it is no trouble for the salesman to dispose of it. The line if seen will sell itself.

Send for selection package, either mounted or unmounted, and form your own idea of art. Address, Department C.



No. 600.

LOCKETS,  
BUTTONS,  
BRACELETS,  
BROOCHES,

CIGAR CUTTERS,  
PENKNIVES,  
MATCH BOXES,  
SCARF PINS,

FOBS,  
TIE CLASPS,  
HEART CHARMS,  
BEAD NECKS, Etc.

**In 10K. that is 10K.**



No. 603.

**ROBT. LEVY,**

**Manufacturing Jeweler**  
**Green and Columbia Sts., Newark, N. J.**



## Tortoisene Combs

Mounted with 10-K. hand-work patterns. Every design is characteristic of originality and every detail is significant of superior workmanship.

*Tortoisene* is hard to detect from the real tortoise shell, having a rich effect that pleases the most skeptical in artistic hair treatment.

This cut represents a few of our patterns, actual size.

Combs will be much in demand throughout the year and orders should be in advance to insure prompt attention.

Prices on request.

**Schultz, Leiss & Co.**

OFFICES

New York, 14 John St. Chicago, 103 State St.

FACTORY

Cor. McWhorter and Oliver Sts., Newark, N. J.

# Bangle and Link Bracelets.



EXPERIENTIA  
DOCET

ELEMENTS of distinction are characteristic of all Durand creations, and these new Bracelets do not fail to maintain the established standard. Link Bracelets in great variety. Gems add impressive effects.

PRICES: FROM \$12.00 to \$400.00.



EXPERIENTIA  
DOCET

**Durand & Company,**

49-51 Franklin Street,  
Newark, N. J.



TRADE  MARK

**OSMUN-PARKER MFG. CO.**

MAKERS OF

*Fine Pearl and Diamond Goods*

338 Mulberry Street

NEWARK, N. J.



Fancy Designs in

*Jewelry*

OF ALL  
KINDS.

Collarettes, Brooches,  
Scarf Pins, Buttons,  
Necklaces, Hatpins, Etc.

**A. J. Hedges & Co.,**

Makers of Exclusive Designs  
in 14K. Jewelry,



14 John Street, New York. TRADE-MARK

ESTABLISHED  
1871.

Factory and Office: Newark, N. J.

INCORPORATED  
1900.

# CARRINGTON & CO.,

## Patent Pocket Match Box

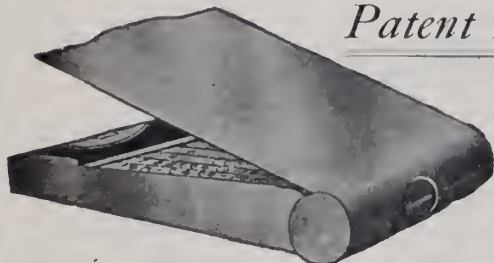

14K. ONLY IN STOCK.

Book Safety Matches with  
Steel Cigar Cutter.  
(Patented.)



Sales Agent:  
7 Maiden Lane,  
NEW YORK.



# Ross, Saltman & Anderson

MANUFACTURERS OF

## Rings and Diamond Mountings

89 FULTON STREET,  
NEW YORK



6111



204

Jewelers will find it desirable and profitable to keep in touch with our new and artistic monthly productions. They represent that originality and perfection upon which we propose to establish a substantial reputation.

# ROSARIES



Of Foreign and our own Manufacture,  
\$2.40 per Dozen up.

## SIGNET JEWELRY

A SPECIAL

Memo. Orders Solicited.

# L. Witsenhausen

47-49 Maiden Lane,  
New York.

Manufacturers MODERN JEWELRY  
of Chicago, 405 Masonic Temple.  
(L. KATLINSKY.)

### LEARN WATCHMAKING AT HOME

by THE De SELMS CHART SYSTEM, copyrighted and patented,  
most simple, practical and up to the minute method of learning.  
Saves you time and money while learning and puts you in a position  
more than double your income.  
50 million timepieces to be repaired. Accurate time is a necessity in  
business world. When time is money the watchmaker gets his share  
profit. Positions for graduates. Booklet free. Write to-day.

The De SELMS WATCH SCHOOL,

109 Perry Street, ATTICA, INDIAN



## Demand for the Barrette

**H**ATLESS WOMEN on Summer outings find it necessary to protect the hair from boisterous winds. For this the Barrette well supplements Back and Side Combs. In growing demand.

### IN GOLD

with Colonial Engraved effect. Vermicilli trim and Fancy Applied Work. Mounted with Pearls and Fancy Stones.

IN TORTOISE-SHELL gold-mounted and set with Pearls.

ALSO A SPECIALTY.

## Day, Clark & Company

14 KARAT ONLY

25

Maiden Lane  
New York



## WHITESIDE & BLANK Bride's-Rose



BROOCH No. 1685

*Pink Enamel  
and Green Gold*

NEWARK, N. J.,  
Lafayette and Liberty Streets.

NEW YORK,  
14 and 16 John Street.

ESTABLISHED 1841.

# Carter, Howe & Co.



MANUFACTURERS OF

## Gold Jewelry,

9, 11, 13 MAIDEN LANE, - NEW YORK.  
FACTORY, NEWARK, N. J.

A. CARTER.

G. R. HOWE.

W. T. CARTER.

W. T. GOUGH.

## "THE BRACELET HOUSE." KENT & WOODLAND,

BRACELETS FOR EVERY WOMAN AND MISS.

16 John Street, New York.

San Francisco Office,  
Care JULIUS A. YOUNG.

"Nethersole Bangles,"  
Plain and with Stones.

"Pinhole" Secret Snap,  
with and without pre-  
cious and semi-precious  
stones.

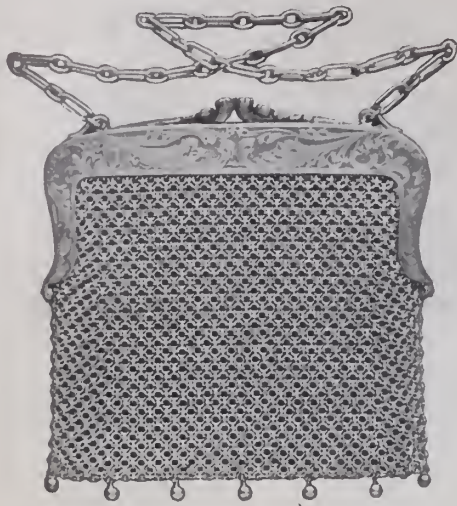

# S. Cottle Co.

are showing an entirely new and exclusive line of Gold and Silver BAGS and PURSES, also many lines of BRACELETS—all of superior workmanship and design.

31 East 17th Street,  
New York.

## Bridesmaids' and Ushers' Pins

We would suggest something with color. Brooches, Scarf Pins and Handy Pins with Amethysts, Topazes, Garnets, Peridots, Aquamarines, Jades and Baroque Pearls. We have a large variety of patterns at moderate prices.

REGARDING OUR FOBS WE HAVE NOTHING TO SAY—  
THEY SPEAK FOR THEMSELVES.

## SNOW & WESTCOTT,

Makers of Good Jewelry for Over Seventy Years,

21 MAIDEN LANE, NEW YORK.

## SAM'L BUCKLEY & Co.

100 William Street, New York.  
118-122 Holborn, E. C., London, Eng.

COMMISSION MERCHANTS.  
MANUFACTURERS' AGENTS.

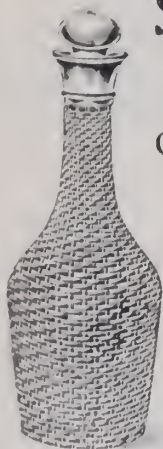

Invite visiting buyers to avail themselves of the facilities afforded by their showroom at above address in which are exhibited English novelties of SHEFFIELD PLATED TRAYS, SILVER AND SILVER PLATE, TANTALUS SETS, WICKER BOTTLES, SILVER MOUNTED GLASS, POTTERY, GLASS, ETC.

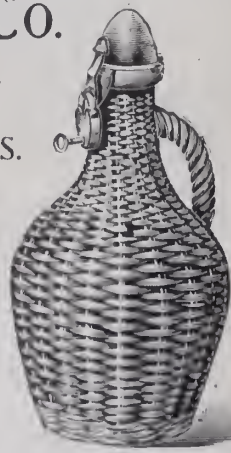

RD No 271707



## Adjustable Glove Garters

IN  
GOLD AND SILVER

### Gold Jewelry

14K. in 10K.

Plain, Chased, Engraved, Diamond Set  
BRACELETS, BROOCHES,  
LINKS, LOCKETS, ELK  
BUTTONS, ETC.

Chas. L. Trout & Co.,  
15 MAIDEN LANE, NEW YORK.

## Unique Silver Deposit WHISKEY JUG



7 Inches High.

Just one piece from one of the best selling and most attractive lines in town

Depasse Mfg. Co.,  
41-43 Maiden Lane, New York

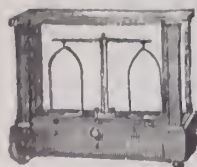

## HERMAN KOHLBUSCH, Sr.,

ESTABLISHED 1859.

Manufacturer of Fine Balances and Weights  
for every purpose where accuracy is required.

Office and Salesroom, 194 BROADWAY, NEW YORK.

Send for Price List.

Tel. 379 Cortlandt.



### THE CROWN PATENT SAFETY GUARD



For Scarf Pins The most adjustable one invented. Price, \$1.50 per doz. For Studs and practical and by all wholesale jewelers and material houses. Sold by mail, 25c; In 10k. gold, \$1.00; 14k., \$1.25. M. C. R. Maker and Inventor, 48 and 50 Maiden Lane, N.Y.





**SOLID GOLD CHAINS**

The selling price of our goods is based on the cost of honest materials, plus the cost of the very best workmanship it is possible to procure. The usual large selling cost is absolutely eliminated - we have salesmen. You get the benefit of this system of honesty in manufacture and economy in selling, when you buy our

**SOLID GOLD CHAINS**



For 56 years, exacting Jewelers have found our chains ready sellers, very profitable to handle and most durable in service. Our prices are very low. We will be pleased to send you a selection package.

1850 1906

**ALOIS KOHN & CO.**

Makers of

**SOLID GOLD CHAINS**  
of every kind.

16-18 Maiden Lane  
New York

**M. SCHIFF**

Established 1876

82-84 Nassau St., N. Y.  
Phone 801 John.

Manufacturer of fine Diamond Mountings, Locketts and Buttons. Patentee of

**THE NEW IMPROVED Ear Screw**

The only one on the market of its kind, absolutely secure. Special attention paid to all order work.

ALL KINDS OF BRACELETS



**THE LOCKET HOUSE**  
**ROTHSCHILD BROS. & CO.**  
51-53 MAIDEN LANE, N.Y.

An Unlimited Line of Patterns of

LADIES' LOCKETS  
MEN'S LOCKETS  
LOCKETS FOR EVERYBODY

UNMOUNTED  
MOUNTED WITH  
DIAMONDS  
OR ROSES

BROOCH MOUNTINGS  
LINK BUTTONS  
BRACELETS  
RIBBON FOBS

ADOLPH LUTHY.

**LUTHY & HINE,**

PERCY W. HINE.

13 EAST 30TH STREET, - NEW YORK.

MANUFACTURERS OF

**Artistic Gold and Platinum Mounted Diamond Jewelry.**

Odd and Exclusive Patterns in NECKLACES, BROOCHES, BRACELETS, RINGS, RIBBON COLLARETTES, Etc.

MOUNTED WITH AQUAMARINES, PERIDOTS, AMETHYSTS AND OTHER PRECIOUS STONES.

(DIAMOND MOUNTED COMBS A SPECIALTY.)

**The Comb House**

We manufacture a complete line of

**FINE MOUNTED COMBS**

in 14 K., 10 K., Sterling Gilt and Gold Filled.

Also all kinds of PLAIN, REAL and IMITATION TORTOISE SHELL COMBS.

Selection Packages sent to Responsible Jewelers.

**Wagner Manufacturing Co.**

41 Union Square,

New York.

Repair Work a Specialty.

Factory, Lorimer St. and Throop Ave., B'klyn, N. Y.

# Look for the Stamp

ON BACK OF



ONE PIECE

The Standard American Collar Button

## KREMENTZ Collar Buttons and Studs



Krementz Stamp

PARKS BROS. & ROGERS  
20 Malden Lane, New York  
Selling Agents to Jobbers

**KREMENTZ & CO.**  
Newark, N. J.

Send for booklet, "The Story of a Collar Button."—FREE

## "TOPPY AND ORIGINAL"

Bracelets  
Barrettes  
Brooches  
Pearl Snaps

A  
&  
V

Handy Pins  
Scarf Pins  
Pendants  
Collarettes

## ALLSOPP AND ALLSOPP

'PHONE 4075W

18 COLUMBIA ST.

NEWARK, N. J.

## Roger Williams Silver Co.,

PROVIDENCE, R. I., AND NEW YORK, 860 BROADWAY.

**Sterling Only.**

RICH DESIGNS :: :: :: Photos on Application.



Fine Rosaries in pure and imitation stone. Mounted in solid gold and rolled gold-plate

ALL COLORS.

Our special illustrated catalogue will give interesting advice regarding prices and discounts.



MADE BY

The **W. J. Feeley Co.**

Providence, Rhode Island,  
Ecclesiastical Art Metal Workers.





**FANS**

FAN SEASON is here, and we are prepared for it with the choicest line that has ever been imported from Paris. These dainty creations are appropriate for Graduation, Confirmation Weddings, and in fact for any occasion where taste and exclusiveness are requisite.

SEND FOR A SELECTION, MENTIONING PRICE

**LEWY & COHEN** 530 BROADWAY NEW YORK

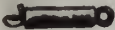
Importers of Fans, Brooches, Mounted Side and Back Combs, French Head Necklaces in mother-of-pearl effects, and THE "MEDICI CHAIN," a new French creation in fan chains.

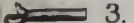
-  1. Snap complete.
-  2. Outside of Snap.
-  3. Inside of Snap.

## The E. P. H. Patent NON-PULL-OUT Neck Chain Snap

*is a patented snap that insures  
the wearer against loss of*

**CHAIN or CHARM**  
for it positively will not pull out

Made in 10 and 14 Karat Gold and  
in Gold Filled.

Can be had of the following *Whole-  
sale Selling Agents:*

- Messrs. W. Green & Co.,  
81 Nassau St., New York.
- |                           |                   |
|---------------------------|-------------------|
| M. Sickles & Sons,        | Philadelphia      |
| E. A. Cowan & Co.,        | Boston            |
| E. & J. Swigart,          | Cincinnati        |
| Swartchild & Co.,         | Chicago           |
| Nordman Brothers,         | San Francisco     |
| Leonard Krower,           | New Orleans       |
| A. Walker Co.,            | Providence, R. I. |
| Bauman-Massa Jewelry Co., | St. Louis         |

**PRICES.**

- 14 Karat—Small, \$7 per doz. net
- Large, \$7.50 per doz. net
- 10 Karat—Small, \$6 per doz. net
- Large, \$6.50 per doz. net
- Gold Filled—Small, \$2 per doz. net
- Large, \$2.25 per doz. net

## THE WASHBURN SECURITY MAGIC NUT

**Automatic Holder** for ear studs, scarf-pins,  
all sizes of scarf-wire. Guaranteed.



**SAFETY CATCH**  
For brooches, etc.  
Can be applied to any  
work where pin tongues  
are used.



Descriptive Circular on Application.  
Pearl Drilling and Adjusting a specialty.  
Special Order Work and Repairing.

IRVING WASHBURN, 12-16 John St., N. Y.

**Try Wells' Perfect Ring Adjusters**  
1 doz. asst. sizes 10k gold filled (gold on  
front twice as thick as on back), \$2.00.  
1 doz. asst. sizes solid 10k gold, \$3.75.  
1 doz. asst. sizes metal, 50c. Ask your  
jobber for them, or I will send, prepaid,  
at once (only on receipt of price), two  
samples—one small and one medium  
large gold filled and one metal adjuster  
for 50c. Address  
**WELLS' H. WELLS, Jeweler Meshoppen, Pa**

# Our Trademark is stamped on every piece that we make.



*We are not ashamed to have  
it appear on any of our designs.*

*Our quality—you all know to  
be plump 10 K.*

*Our finish—it's the best ever  
put out on any gold jewelry, short  
of high-class 14K.*

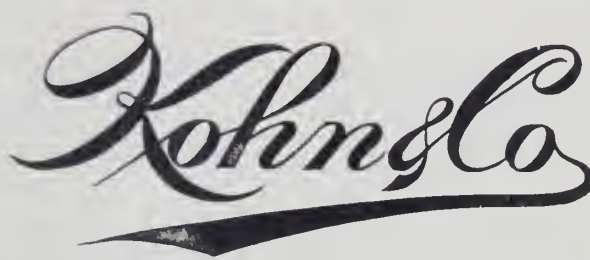

Camp and Orchard Streets, NEWARK, N. J.

## HEINTZ BROTHERS



• We Make the Largest Line of Solid Gold Set Rings in America for the Retail Trade •

## THE MOUNTING THAT SELLS

Earscrews,  
Earrings,  
Studs,  
Scarf Pins,  
and Rings  
of every description.



Made in  
Platinum,  
18K.,  
14K.,  
all sizes.

It gives light and brilliancy to the stone.

Manufacturer of a general line of Platinum,  
18K. and 14K. Mountings.  
Prompt attention given to special order work.  
Estimates and designs submitted.  
Diamonds recut and repaired.

### JULIUS WODISKA,

40 JOHN STREET,

NEW YORK.

## Koshland & Italic Co.

702 Chestnut Street,

PHILADELPHIA, PA.

¶ Not how **CHEAP**  
but how **GOOD** is the  
principle we follow  
in selecting the goods  
we offer for sale.

**Diamonds, Watches and Jewelry**

## MOST COMPACT

AND THINNEST  
DUST-PROOF

## OPEN FACE GOLD CASE

MADE IN THE WORLD  
FOR  
AMERICAN MOVEMENTS.

Made in all shapes, engine turned,  
engraved or plain.

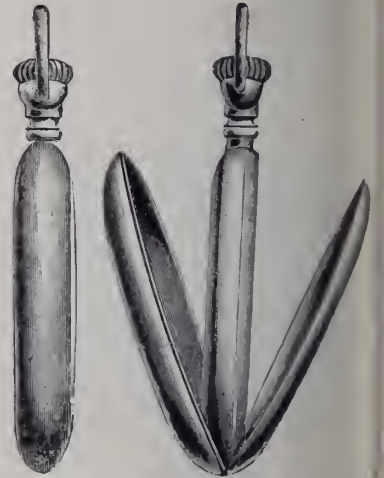

Colby Patent, April 24, 1894.

## DUBOIS WATCH CASE CO.

21 Maiden Lane, New York.

35 Years Manufacturing

## CHAINS

**S. & B. Lederer Co.**

11 Maiden Lane New York      Factory:      131 Wabash Ave  
Providence, N. L.      Chicago

### The ST. JAMES

Corner Walnut and Thirteenth Streets  
PHILADELPHIA, PA.

The Ideal Hotel of Philadelphia  
European Plan      EUGENE G. MILLER, Mgr

**A. Nonnenmann & J. Aschenbrenne**  
114-118 East 23d St., New York.

**Original Designers** for Platinum  
Gold and Silver  
Jewelry Art  
istic Designs for Silverware and Novelties fu  
nished at shortest notice.

Henry Freund.

Louis Freund.

Leo. Goldschmidt.

Chas. Danziger.

L. M. Heymann.



**T**HE little Brownies and the big Brownies work hand in hand, and with concentrated mental and physical energy, to introduce our "Sellers" to the trade. When once introduced, we have no fear of the results. We have customers who have been with us for 40 years, and the rule holds good, "Once a customer, always a customer." The right goods at the right time and at the right prices, combined with liberal treatment in every respect, make our customers our friends for all time. The list is constantly increasing. Let us add you to the number this season.

### HENRY FREUND & BRO., "Sellers of Sellers"

ELK and EAGLE GOODS & Specialty

71 Nassau Street NEW YORK



Our Line of Rings is hard to beat, as is also our line of

**SCARF PINS, EAR SCREWS, CROSSES, BROOCHES, ETC.**

They are the kind that sell. Insist on seeing the line of Gold Jewelry manufactured by

**THE AMERICAN RING CO.**  
94 Point St., PROVIDENCE, R. I.

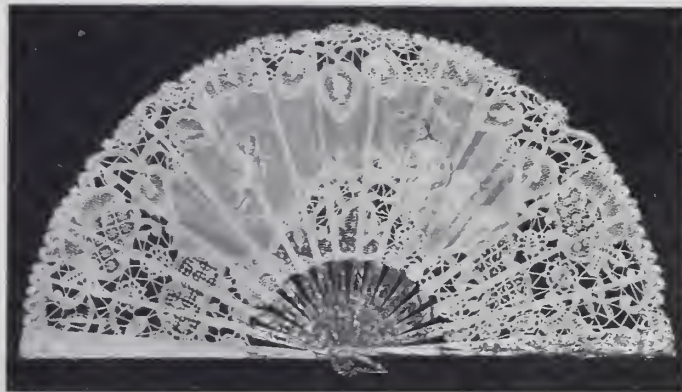

## FANS

Headquarters for the most exclusive line in this country.

**SPECIALLY DESIGNED FOR THE FINE JEWELRY TRADE**

## NECKLACES

Imitation Pearl and Fancy Bead, in all newest shades and exquisite colorings. Write for Samples, mentioning price.

**LOUIS STEINER, Importer,** 520 & 522 Broadway NEW YORK

## DESIGNS For Silverware, Novelties and Jewelry : : : FINE ETCHING

We are not manufacturers, but Designers, and we do some elegant etching.

**CHARLES M. PRIOR** (PHONE 1224 HARLEM) 1683 Madison Ave., New York

## LOCKETS ONLY

Satisfy your customers by using the recognized standard of excellence in this specialty

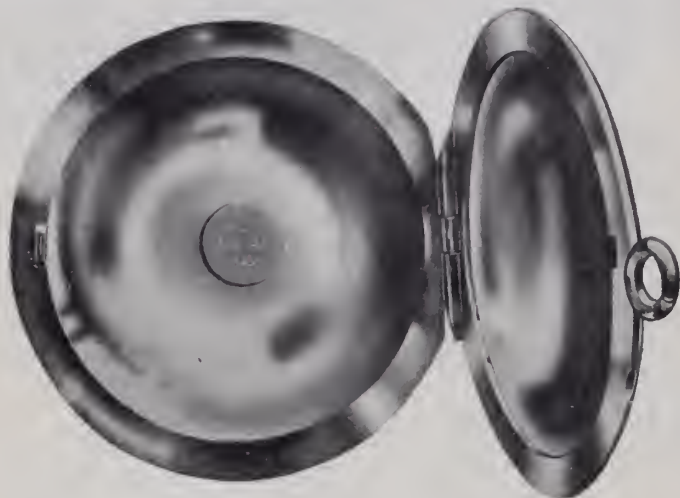

None genuine without **TRADE-MARK** stamped inside

**ESTABLISHED FIFTY YEARS**

**Wightman & Hough Co.**

New York Office  
3 Maiden Lane

Main Office and Factory | 7 Beverly Street  
Providence, R. I.

## ORDERS PROVE OUR GOODS SELL

We make for the Jobbing Trade the following lines of Solid Gold Jewelry :

*Rings, Scarf Pins, Studs, Brooches, Charms,  
Baby Pins, Handy Pins, Chain Sets,  
Link Buttons, Hair Barrettes,  
Crosses, etc.*

Insist upon seeing the designs of Gold Jewelry made by the

**E. L. SPENCER CO.**

95 Chestnut Street,

PROVIDENCE, R. I.

New York Office, 9-11-13 Maiden Lane.

SAMPLES ONLY.

**W**ait

**A**nd See

**I**n the "Celebrated Case"

**T**his Season's New Goods.

**E**very one a Seller

**T**here

**H**ave always been

**R**easons:—

**E**stablished reputation,

**S**taple Patterns,

**S**

**H**

**E**

**R**

**'**

**S**

**G**

**O**

**O**

**D**

**S**

**S**

**E**

**L**

**L**

**Waite-Thresher  
Company**

61 PECK ST., PROVIDENCE, R. I.

7 Maiden Lane,  
NEW YORK.

1203 Heyworth Bldg  
CHICAGO, ILL.

HIGH CLASS FANCY  
**Link Bracelets**  
MOUNTED WITH AND WITH-  
OUT FANCY STONES.

The Product of Many Years of Conscientious Manufacture.

We are the largest exclusive makers of 10 Karat jewelry.

Ask your Jobber for the P. & B. Co. lines of Fobs, Lockets, Tie Clasps, Brooches, Scarf Pins, Hat Pins, Baby Pins, Bead Necks, Cuff Buttons, Crosses, Bracelets and Waist Sets.

**Potter & Buffinton Co.,**  
Providence, R. I.

New York Office,  
65 Nassau St.  
San Francisco Office,  
206 Kearny St.

**NORMA**  
TRADE MARK

The New  
**NORMA**

*Patented Adjustable Bracelets.*

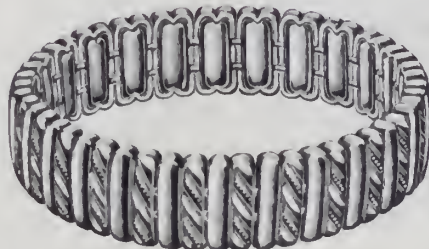

No. 253.



No. 265.



No. 254.



No. 271.

Examine our Popular Prices ranging from

**\$16.50 to \$36.00**  
per dozen

The illustrations represent a few of the many styles we make

THE QUALITY OF ALL THESE GOODS IS FULLY GUARANTEED

Send for our new illustrated booklet of patterns and prices

MADE ONLY BY

**The F. H. Sadler Co.**

80 County Street  
ATTLEBORO, MASS.

Address all communications to  
Attleboro, Mass.

N. Y. Office, 180 Broadway  
Room 43

**NORMA**  
TRADE MARK

# LOCKETS

WE ARE  
**LOCKET**  
 SPECIALISTS  
 —  
 FOR THE  
 JOBBING  
 TRADE  
 EXCLUSIVELY



THE  
**HORSE**  
**HEAD**

illustrates one  
 of a hundred  
 and more de-  
 signs. Made in  
 3 sizes.

**S. & B. L.**  
 ★  
**CO.**

Every Locket stamped  
 on inside with

Insist on this  
 Trade-Mark

MADE IN HIGHEST GRADE GOLD FILLED ONLY  
 Ask your jobber, or send for a selection

Manufactured only by

## S. & B. LEDERER CO.

NEW YORK SALESROOM  
 9-11 Maiden Lane

Providence, R. I.

CHICAGO  
 131 Wabash Avenue



**THE TRADE**

desirous of keeping in touch with modern, profit  
 producing methods, should always consult the 5  
 pages of

**OUR BIG CATALOGUE,**

with its 30,000 illustrations and long list price  
 We send this splendid book free on request.

### S. F. Myers & Co.

Headquarters for Dueber-Hampden Watches.

WHOLESALE JEWELERS

The New S. F. Myers Bldg. 476-49 Maiden Lane New York.



Ladies' Fancy Stone Rings  
 and Stone Scarf Pins  
 in 10K. that defy  
 competition.

Our reputation for making the  
 finest and most complete line of  
 10-K. gold band rings is still  
 maintained—ask your jobber.

The **EDWIN LOWE & CO., Inc.**  
 F. W. BODWELL, V.-Pres. and Gen. Mgr.

116 Chestnut St., PROVIDENCE, R. I.  
 New York Representative, E. T. Wilson, 180 Bway  
 Western Representative, S. H. Brower.

EVERYTHING IN LOCKETS AND CHAINS.

THE BASSETT JEWELRY CO.,

PROVIDENCE, R. I.

**BOSTON'S FOREMOST  
 JOBBING HOUSE.**

As manufacturers of diamond mount  
 ings, we have established a reputation  
 for giving the greatest value at the least  
 price. Being direct importers of  
 precious, semi-precious and imitation  
 stones, we can serve you as the repairer  
 of your jewelry better than any other  
 house. A full line of stones always on  
 hand.

Write us for information or send us a  
 trial order.

**ORKIN BROTHERS**  
 373 Washington Street,  
 Jewelers' Bldg., BOSTON, MASS

## E. H. H. SMITH SILVER CO.

BRIDGEPORT, CONN.

Silversmiths' Building,  
 CHICAGO, ILL.

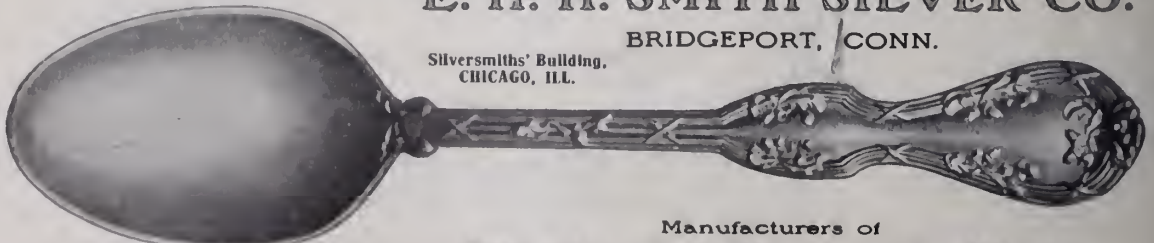

THE OAK.

Manufacturers of  
**Sterling Effects in Plate**

Write for our new catalogue.



**ESSING HAS CEASED TO BE A VIRTUE.**

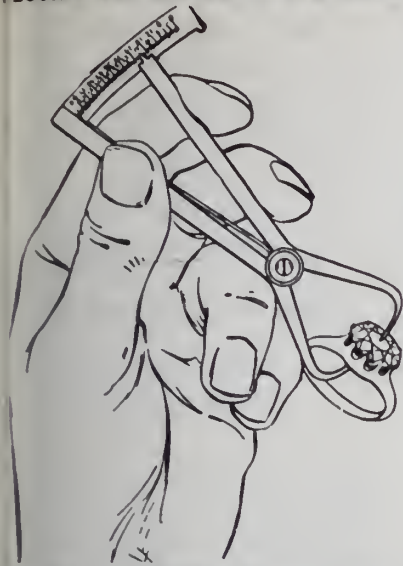

**THE MOE DIAMOND WEIGHT GAUGE**  
 the only correct system for determining the weight of mounted diamonds.  
 ENDORSED BY THE LEADING JEWELERS.  
 Those who are not familiar with the device, kindly send for descriptive booklet.

**Charles Moe, Inventor, 80 Adams St., CHICAGO, U. S. A.**  
 Price for Instrument and Book, \$3.75 prepaid.  
 You also order from the following agents:  
 C. PERCIVAL & CO., Boston; CROSS & GÜELIN and R., L. & M. FRIEDLANDER, New York; M. SICKLES & SONS, Philadelphia; RDMAN BROS., San Francisco; E. & J. IGART, Cincinnati; LEONARD KROWER, New Orleans.  
 ACKES & STRAUSS, Sole Agents for Europe India, London, E. C., 14-17 Holborn Viaduct.

**EGYPTIAN PEARLS**

—  
 FINEST OF ARTIFICIAL PEARLS.



**EGYPTIAN PEARLS**

—  
 MOUNTED IN POPULAR JEWELRY.

**T**HE PEARL has always symbolized Beauty and Value. Nature's product is most closely approximated in the handsome "EGYPTIAN" Pearls. The iridescence, weight and color of natural Pearls are retained; and inspection of the "EGYPTIAN" Pearls will demonstrate their pre-eminence. The results attained are possible only by a special process, supplemented by expert workmanship. The articles of Jewelry to which "EGYPTIAN" Pearls are applied are artistic creations meriting your attention.

**GEORGE H. CAHOONE COMPANY,**

Makers of Artistic Jewelry,  
 PROVIDENCE—7 Beverly Street. NEW YORK—9 Maiden Lane.

**Unique Gems**

and Semi-Precious Stones

Many fine gems occur as water-worn pebbles. These, when polished natural or drilled and polished as beads, form a decided novelty of great beauty and infinite variety of colors, and can be had in

Carnelian	Agate	Rose Quartz
Chrysoprase	Topaz	Malachite
Jasper	Lapis Lazuli	Amethyst
Tourmaline	Emerald Matrix	

and many other stones.

Adapted especially for neck chains, drop pendants, La Vallieres, scarfpins, link cuff buttons, and for any of the newer forms of art jewelry. Prices reasonable; no imitations.

Sample papers sent to responsible jewelers.

**LOUIS J. DEACON, Atlantic City**  
 During Summer Months, Cape May, N. J.

**The Kenilworth Bracelet.**

(Patented Jan. 2, 1906, No. 808,805.)  
 No. 4086.

All of the foremost jobbing houses now carry a full line in stock, and you will miss an opportunity if you fail to see them. Ask your jobber to show you the full line.

A success beyond our expectations. Its simplicity of operation in putting on or taking off, "having no catch or snap," commends it to the discriminating buyer, and has made it the most popular bracelet on the market. Made in plain, beautifully chased and stone set, plain polished, English and Roman finishes, and in gold-filled and sterling silver.



Manufactured by  
**Doran, Bagnall & Co.,**

North Attleboro, Mass.  
 194 BROADWAY, NEW YORK.  
 67 WABASH AVE. CHICAGO.  
 126 KEARNY ST., SAN FRANCISCO.

**ELK TEETH**

Unmounted, genuine. Bought of Indians, 10 to 300, as needed, sent on selection to responsible Jewelers at strictly wholesale prices; also

**EAGLE, MOUNTAIN LION AND LYNX CLAWS.**

**L. W. STILWELL,**  
 LEADWOOD, - SOUTH DAKOTA.  
 Wholesaler of Sioux Indian Bead-Work and Curio Supply Jobber.

**EDMUND R. NEBELING**  
**Diamond Setter**

49 Maiden Lane - NEW YORK  
 Telephone, 5039 John  
 Gold and Platinum Work a Specialty. Mail Orders promptly attended to. Write us for references

**JULES JÜRGENSEN**  
**Watches and Chronometers**

PARIS—"THE GRAND PRIX"—1900

**SOLE**

**RUDOLPH & SNEDEKER,**  
 65 Nassau St., New York

**AGENTS**



Timer is 1/8 Larger than cut

"Watch us" always for anything you wish in the "Watch" line.

# THE OLD RELIABLE Centennial

SPLIT SECOND TIMER

"None better made"

Suitable for Racing and Mechanical Purposes.



Timer is 1/8 larger than cut

**CROSS & BEGUELIN, Manufacturers, New York.**

## BRACELETS



If one will pause for a moment to consider Quality, Price and Design, the conclusion is always the same, we have the Premier Line. This applies to Bracelets, and the A. O. T. G. Lines of



ALWAYS ON THE GO.

Combs  
Brooches  
Scarf Pins

Bracelets  
Barrettes  
Buttons

Baby Pins  
Crosses  
Waist Sets

Hat Pins  
Collarettes  
Silver Novelties

LOOK FOR THE TRADE-MARK

**MILLER, FULLER & WHITING, MANUFACTURING JEWELERS**  
New York Office, 9-11 Maiden Lane. NORTH ATTLEBORO, MASS.

## L. BONET, CAMEO PORTRAITS



Importer of Precious Stones

41 Union Square, NEW YORK.

## JACOB BASCHKOFF, DIAMOND SETTER

LETTER AND MONOGRAM

ENGRAVER,

9-13 MAIDEN LANE,

Room 701  
Jewelers' Bldg.

NEW YORK



ESTABLISHED 1895

# SOLIDARITY

**WATCH CASE CO.**  
GENERAL SELLING AGENTS,  
JOHN W. SHERWOOD & FRANK E. HARMER.

MANUFACTURERS OF  
**ARTISTIC GOLD WATCH CASES**  
NO. 3 MAIDEN LANE, NEW YORK.

Sold through the Jobbing Trade only.

Now on Press

1906-1907 EDITION  
OF  
THE JEWELERS'  
CIRCULAR-WEEKLY

# Buyers' Directory

OF THE  
Manufacturers, Importers  
and Jobbers  
IN THE  
JEWELRY AND  
KINDRED TRADES

A Handy, Classified List for Desk or Pocket

Price, 50 Cents

The Jewelers' Circular  
Publishing Co.

11 JOHN ST. • NEW YORK  
(Corbin Building)

## REMOVAL NOTICE!

**THE LYONS GEM CO.,**

Have Removed to

**35 Maiden Lane, New York.**

A FULL AND COMPLETE LINE OF PRECIOUS,  
SEMI-PRECIOUS AND IMITATION  
STONES ALWAYS IN STOCK.

Our Specialty is Scientific Rubies.

Local and out of town jobs promptly  
attended to at reasonable prices.  
Send us your mountings to be set  
with matched stones. A trial order  
will convince you that our prices  
are right, and our goods select.

**ARREAUD & GRISER**

68 & 70 Nassau St., New York.

**LAPIDARIES.** PRECIOUS  
STONES

EMS in Unique Cuttings

# WORLD BRAND SILVER



### Base Metal

☞ Manufactured in our own factory by workmen selected because of their knowledge and practical experience in its manufacture and use and with a view to obtaining the best possible results.

### Silver

☞ Not Less Than 50 per cent. heavier plate than the regular "Standard." Made in two grades, six and fourteen ounce plate.

### Designs

☞ Six fancy patterns—*original* in design and unexcelled in execution. Also four plain patterns.

### Prices

As low as consistent with quality.

*Write for catalogue and prices.*

**THE AMERICAN SILVER COMPANY**

BRISTOL, CONN.

46 West Broadway, New York.

Silversmiths' Building, Chicago, Ill.

## REMOVAL NOTICE

We now occupy the new store of

**The Lorsch Building, 35 Maiden Lane, N. Y.**

# WOLFSHEIM & SACHS

MAKERS OF

Fine Boxes, Trays and Novelties for Jewelers and Silversmiths

**35 MAIDEN LANE, N. Y.**

Telephone, 3518 John.

Factory, 10 Gold Street.

F&amp;B

F&amp;B

The  
**Gypsy**

Another of our new patterns in Toilet and Manicure goods.

Take particular notice of the new shape of Bonnet Mirror, which will be appreciated by every lady who uses one, it is so convenient. The regular shape can be furnished a little later if it is desired.

Our new line of Sterling Silver silk-lined Jewel Cases is especially attractive, and we are showing a great many Novelties which we will have illustrated in our new Catalogue, H, now in the hands of the publishers.

Owing to the phenomenal demand for

**"The Armlet,"**

the F&B invisible joint

bracelet, it has been impossible to keep pace with the orders, but we now believe we shall soon be able to make prompt shipments.

See our full lines of gold-filled Locketts, Charms, Crosses, Pendants, Chains, Fobs, Neck Chains, Collarettes, Pins, Brooches, Earrings, Link Buttons, Scarf Pins, Hat Pins, Barrette Pins, Belt Pins, Waist Sets, Buckles, Hair Chain Mountings, Ribbon Buttons, Marks and a large line of Sterling Silver Novelties.



# Theodore W. Foster & Bro. Co.

Manufacturing Jewelers and Silversmiths 100 Richmond Street, Providence, R.I.

New York Salesroom  
13 Maiden Lane

Chicago Salesroom  
Heyworth Building, Wabash Avenue and Madison Street

Canadian Salesroom  
350 King Street, Kingston, Ont.

## Mid-Summer Outing

### Members of Philadelphia Jewelers' Club Enjoy Baseball Game and Entertainment.

PHILADELPHIA, Pa., June 27.—What a good time really is was shown the guests of the Philadelphia Jewelers' Club yesterday when the club gave its annual midsummer outing. More than 500 jewelers checked like boys at recess at the grounds of the Philadelphia National League baseball team, at Broad and Huntingdon Sts., in the afternoon, while nines representing local and New York members of the club played a game of baseball. Then all hands with all the recruits gathered from the trade after the close of the day's business repaired to Tuxedo Hall, 11th and Christian Sts., where they were mightily entertained with a vaudeville show and several well-fought matches between local teams.

This year the club has gone back to its original Summer festival in the nature of a baseball game, followed by a stag smoker, with what success can only well be told to those who enjoyed the club's hospitality. Nearly a thousand in the trade are ready to testify that the stag party at the downtown sporting club in the evening was more full of enjoyment than any they have attended in years. With generous hospitality the club provided so well for its guests, both as attractions for the eye and satisfaction to the "inner man," that good fellowship was promoted and sustained until long after midnight, when the remnants of the crowds which attended the baseball game, and later the vaudeville show at the Tuxedo Club, were disbanded at the clubhouse, where the festivities were ended.

"Lou" White, Warner Hutchins, "Joe" Cadwallader and William Linker are given credit for the success of the Summer festival. It was they who arranged the details, who captained and managed the baseball teams, and they also who provided the talent, much of it novel and refreshing to even the most jaded and blasé New Yorker. On the baseball grounds the guests were entirely unrestrained and abandoned themselves without thought or care to the full enjoyment of the day. Harry Oliver, wearing a fez of brightest crimson and in knickerbockers, which displayed his athletic windup to advantage, Fred Barry, W. Hopkins Iszard, Zophia Laird, Emilbacher, A. J. Le Jambre, Joe Cadwallader and Fred Yockel were here, there and everywhere around the baseball field and at the clubhouse and helped much to keep things going at a lively rate. Some of the old-time good spirits of the club were missing this year, notably "Del" Lee, who has entered another line of business in New York, and "Jake" Henderson, who, although not a member of the club, has always heretofore been one of its guests on such occasions. Mr. Henderson had succumbed to heart disease only the day previous, and his untimely death was regretfully commented upon by all who knew him.

The club's guests gathered early in the afternoon at the baseball grounds, going there in little parties formed downtown and at the club headquarters, 13th and Chestnut Sts. Here they found the members of both

teams which were to play practising and "limbering up" for the game. Much good-natured sport was had by the arrivals in guying the amateur ball players and in coaching them. Appreciating a long-winded contest, the game was started without delay, the teams representing the two elements of the club being lined up as follows:

PHILADELPHIA—Laird, c.; Riley, p.; White, 1b.; Cadwallader, 2b.; Provan, ss.; Cregar, 3b.; Coates, rf.; Penfold, lf.; Robertson, cf.

NEW YORK—Kirtland, c.; Busch, 2b.; Boyce, ss.; Evans, p.; Collard, 1b.; Spies, 3b.; Oliver, lf.; Barry, cf.; Nellis, rf.

With this line-up the two teams struggled to see who could make the most runs and, while the competition was keen, nothing but the best of feeling prevailed and the umpire, William H. Armstrong, of the "Earle and The Girl Company," and an old-time favorite of the club members, had an easy time of it. Only once was his decision questioned, and this was when Harry Oliver was presented with a base on balls. But it was generally appreciated by the spectators that, unless this decision was made, Mr. Oliver might even yet be waiting to get his eye on the ball. However, when he did reach first, he lost no time in stealing second, and was brought home by a long drive by a team mate.

Between innings there was much resorting to a cool and refreshing spot under the bleachers, where William, the club steward, presided, surrounded by sundry kegs, with big pieces of ice upon them. William had a helper and between them there was no thirst which they could not overcome. The captains of both teams were required to go to the retreat from time to time to call up the next batsman. But there were no disappointments nor long delays until finally six innings had been concluded and Mr. Eckfeldt announced that the score was 13 to 4 in favor of the Philadelphia members. The "Phillies" started out with a rush, making five runs in the first inning. Those who crossed the plate were Laird, White, Cadwallader, Provan and Cregar. In the next two innings the Philadelphia members drew blanks. In the fourth Penfold managed to get home with a long drive. In the fifth all except Riley and White crossed the plate. For the New Yorkers only Kirkland, Collard, Spies and Nellis got in home.

Harry Oliver, despite his venerable appearance, got around in a lively manner, sliding to bases, hitting the ball here and there and fielding with consummate grace and skill. With a red fez and false red whiskers he confronted the pitcher every time he came to bat, and with this outfit managed to get to first every once in a while with bases on balls.

After the game was ended in the sixth inning many of the spectators and nearly all the players went to the clubhouse, where they remained until it was time to go to the vaudeville show, which began shortly after 8 P. M. Those who went to their homes gathered at the Tuxedo Club in the evening. Here there was given an excellent entertainment, varied so as to please all tastes. There were boxing bouts and a free-for-all fight between a half-dozen colored men, who were rewarded by having coins thrown at them and for which they fought together

fiercely. A moving picture apparatus, showing especially how a beautiful woman combs her hair, the singing of ballads, especially by Signor Giannini and William H. Armstrong, and various juggling and sleight-of-hand acts made up the entertainment. Throughout the show, which lasted until after midnight, a band played lively airs.

One room was reserved for refreshments, and here again the club's stewards were kept busy. Not only liquid refreshments were to be had, but tasty sandwiches to stay appetites. It is estimated that fully 1,000 people were crowded into the hall, and by all the evening's entertainment was voted to have been a great success.

### More Corporation Reports Filed by Massachusetts Manufacturing Jewelry Concerns.

Boston, Mass., June 29.—The Cohannet Silver Co., Taunton, through Treasurer John J. Nicholas, has filed with the Secretary of the Commonwealth the following annual corporation report: Real estate, \$2,200; cash and debts receivable, \$4,859; manufactures, \$27,526; merchandise, \$2,000; capital stock, \$10,000; accounts payable, \$1,180; floating debt, \$5,955; profit and loss, \$312.

The Horton-Angell Co., Attleboro, through its treasurer, has filed the following annual corporation report: Real estate, \$31,259; machinery, \$16,657; cash and debts receivable, \$146,234; manufactures, \$40,717; merchandise, \$34,613; capital stock, \$160,000; accounts payable, \$28,295; surplus, \$68,358; profit and loss, \$2,827.

The L. A. Littlefield Silver Co., New Bedford, Mass., through Treasurer L. A. Littlefield, has filed with the Massachusetts authorities the annual corporation report: Machinery, \$10,088; cash and debts receivable, \$2,627; merchandise, \$5,630; capital stock, \$10,000; accounts payable, \$2,329; floating debt, \$4,300; profit and loss, \$716.

The W. D. Wilmarth Co., Attleboro, through Treasurer Henry P. Wilmarth, has filed the following annual corporation report: Machinery, \$3,500; cash and debts receivable, \$7,062; manufactures, \$12,954; capital stock, \$14,000; accounts payable, \$3,076; profit and loss, \$6,440.

### Recent Reappraisements of Jewelry and Kindred Lines.

Reappraisements of imitation pearl and coral beads were announced last week by the Board of United States General Appraisers, New York, as follows:

Imitation pearl beads from E. Heusch & Co., Paris, exported May 16, 1906, entered at New York (File No. 40101); findings of Lunt, G. A.: Perles, qual. 4, blanc and creme, Nos. 8, 9, 10, 11, 10½, entered at 9 francs per masse; do., Nos. 12, 13, 14, 15, 16, entered at 10 francs per masse. Discount, 30 per cent. Advanced by making discount 10 per cent. and 2 per cent.

Coral beads from Guiseppe D'Elia, Naples, exported April 27, 1906, entered at New York (File No. 40037); findings of Lunt, G. A.: Collars coral Japonnaise, entered at 26, advanced to 31 francs per 100 strings; collars, coral beads, Japonnaise, entered at 2.75, advanced to 3.50 francs per string; do., entered at 4.25, advanced to 5.50 francs per string; do., entered at 17, advanced to 25 francs per string; Collars, coral ronds, rouges, 1470, 1700, entered at 1.25, advanced to 1.75 francs per string. And similar goods.

A. E. Springborg, Redlands, Cal., has renovated and enlarged his store.



Trade-Mark Registered.



Trade-Mark Registered.

## THE NATIONAL STAMPING LAW

was signed by the President of the United States on June 15th, 1906.

This law does not go into effect for one year; this time is allowed so that manufacturers and dealers may readjust the quality of their goods, so that they will be up to the quality they are stamped.

There will be no readjustment in our factory, for one of our principles in business is to make goods of unquestioned quality.

As a guarantee that the quality is just as it is stamped, we place upon every article we make this registered trade-mark—



Trade-Mark Registered.

Why not begin this Fall to buy Rings, Locketts, Link and Bar Buttons, Vest Buttons and Shirt Studs bearing this mark?

### Larter & Sons

21 & 23 Maiden Lane  
New York



Trade-Mark Registered.



Trade-Mark Registered.

### Pittsburg Jewelers Making Preparation for Organization of Pennsylvania Retail Jewelers' Association.

PITTSBURG, Pa., June 29.—A number of prominent Pittsburg jewelers last night had a meeting at the Hotel Henry to consider arrangements for entertaining the delegates to the meeting called for July 10, at the same hotel, when the Retail Jewelers' Association of Pennsylvania will be formally organized. The meeting last night surprised the members of the Pittsburg division.

J. P. Steinmann was appointed chairman of the reception committee, and the order of the committee will be announced a few days by him. A press committee consisting of G. A. Spies, Robert Gestrich and A. C. Graul was also appointed. The committee on meetings and speakers secured the services of Congressman James F. Burke and James W. Wardrop, secretary and general manager of the Merchants Manufacturers' Association of Pittsburg, two of the city's most gifted orators, to address the convention, which is only expected to be in session one day. Another meeting of the Pittsburg division has been called for next Thursday night at the same hotel.

The Pittsburg jewelers are taking a great interest in the affair, fully 20 houses being represented at last night's gathering. William Hiner, of Philadelphia, a former president of the defunct retail jewelers' association of this state, has written to temporary Secretary C. S. Wiley, of the new organization, that he will be in Pittsburg to attend the convention. Arrangements are being perfected for the entertainment of about 125 guests. Mr. Wiley is receiving very encouraging replies to his circular sent out last week, from all parts of the state.

All retail jewelers in Pittsburg and vicinity are requested to attend next Thursday night's gathering.

### Silver Gilt Trophy for Automobile Race.

ONE of the pleasing trophies of the present automobile season was a sterling silver bowl, illustrated on the front cover, which was awarded to the winner of a two-gallon efficiency contest conducted under the auspices of the Automobile Club of America. The prize was awarded to a 22-horse-power Franklin Runabout, which traveled a distance of 87 miles. There were 65 starters.

Around the rim of the bowl are six festoons of grapes and grape leaves. Pieced and beaded work ornament the rim of the base. The outlines of the bowl and its ornamentation are simple and graceful, while the workmanship shows a rare degree of care and skill. The entire bowl is heavily and handsomely gilded.

The bowl and foot have a height of 10 inches, and the width across the top is 10 inches. In all, 146½ ounces of sterling silver were used in making the cup, which has a capacity of 18 quarts.

This trophy was designed and manufactured by Theodore B. Starr, New York.

The stock of S. A. Watson, Chester, Pa., was damaged slightly by smoke and water during a recent fire at that place.

### N. E. A. O. Elects Several Committees for the Advancement of That Association.

BOSTON, Mass., June 27.—The following committees were appointed at the meeting of the New England Association of Opticians, held here Tuesday of last week:

Lecture Committee—W. W. Slade, chairman; E. M. Parks, G. H. Newell, E. A. Fe, W. P. Bullard.

Code of Ethics Committee—W. L. Thomas, chairman; H. C. Doane, H. L. Kn, C. S. Hart, W. D. Ward.

Vigilance Committee—R. Wight, chairman; H. G. Wright, W. L. Bemis, E. G. Wiley, W. H. Wyman.

Examining Committee—F. P. Simmons, chairman; H. C. Doane, H. L. Klein.

Legislation Committee—B. S. Palmer, chairman; A. G. Barber, W. W. Slade, S. C. Witt, F. P. Simmons.

The duties of the Legislative Committee will be to follow up any bills which may be presented to this legislature, and watch the proceedings of other societies which are doing legislation.

The Code of Ethics Committee will draft one for the governing of the opticians.

The Vigilance Committee will carry out the thought of the president as outlined at the convention last May. The ultimate aim is to raise the standing of the opticians.

The Lecture Committee has been appointed to outline a plan of lectures for the coming year. It is desired they secure sufficient members from the association to lecture on the subjects most interesting to opticians—refraction, physiology, and anatomy. It is the intention to follow the lecture by a "quiz," to assist the members to fix the thoughts of the lectures more firmly in mind.

It has been also recommended that the association change the "ladies' night" from April to January.

### Suspect Held in New York on Charge of Virginia Jeweler Escapes Before He Is Extradited.

Wheaton B. Despard, alias Dan Stevens, was arrested in New York about the middle of June on a charge of grand larceny made by John F. Kohler, retail jeweler, Richmond, Va., has forfeited the \$1,000 bond which he gave to the police authorities, and skipped. Despatches from Richmond say that Charles Kohler, son of the jeweler, and Detective Wren have called on the governor of Virginia to consult him in relation to the escape. The Virginia authorities expected to extradite Despard, and detectives with the necessary paper came to New York for that purpose only to find that the man had slipped through the hands of the police of the metropolis.

The remarks made by the Richmond officials indicated that they were anything but pleased with the course pursued by the authorities in New York. The Richmond officials were of the opinion that as requisition papers had been made out immediately, and they had come on promptly to get the prisoner, it would have been courtesy for the police in New York to have kept the man in custody a few days, or at least to have required a higher bond than \$1,000.

It is said that the governor of Virginia will communicate with Governor Higgins

on the subject. Despard, according to the charge that had been made, entered Mr. Kohler's store with an accomplice and while examining a tray of diamond rings abstracted two, substituting cheap imitations.

### Another Unsuccessful Attempt to Work Forged Order Swindle in New York Jewelry Trade.

An attempt to swindle Charles A. Keene, 180 Broadway, was made last Wednesday. A small boy entered the store and handed to W. P. Talbot, the manager, a letter written on a plain sheet of letter paper as follows:

NEW YORK, June 27, 1906.

Mr. Keene, Esq.:

Dear Sir—Will you please be so kind as to give bearer of this note a 11-karat Tiffany with one-carat diamond, and oblige

C. P. GOLDSMITH & Co.,  
33-43 Gold St.

Mr. Talbot was quite certain that the order was a forgery. One reason was that an order from that company would scarcely be written on a sheet of paper of the kind used. However, he called up the company's office and was informed that no order had been sent. Then he gave a "dummy" package to the boy and followed the lad. The boy went to the corner of Cortlandt St. and Broadway, where he stood waiting for a few minutes, and then returned to the store. Mr. Talbot, meantime, had met Detective-Sergeant Nugent, and the two went back to the store and questioned the boy. The lad said that he worked for a financial paper, and had been stopped on the street by a young man who asked him to get a package at the jewelry store and carry it to the corner, promising to pay 10 cents for the service. The boy's story was apparently true.

A similar effort was made several weeks ago to obtain a pair of field glasses from the Julius King Optical Co., on a printed letter head of the company whose name he used. The swindler was foiled in that case also. A year or two ago several firms were made victims of forged orders of this kind, since which time the rule has been in the Maiden Lane district not to give merchandise to unknown boys unless the order is confirmed in some way.

### Recent Decisions by General Appraisers as to Metal Ornaments and Similar Articles.

Decisions in cases involving customs duties on metal and millinery ornaments and beaded articles were announced last week by the Board of United States General Appraisers, New York, as follows:

MILLINERY ORNAMENTS.—IMITATION CAMEOS.—Protest of Bamberger-Stern Co. against the assessment of duty by the Collector of Customs at New York. The protest related to millinery ornaments and imitation cameos. As claimed by the importers, the former were held dutiable as manufactures of the component of chief value, and the latter as imitation precious stones under Par. 435, Tariff Act of 1897. Note G. A. 6130 (T. D. 26653).

BEADED ARTICLES.—ORNAMENTS.—BEADS.—CHATELAINE CHAINS.—Protests of Deutsch Bros. against the assessment of duty by the Collector of Customs at New York. The Board held certain beaded leather articles,

ornaments, beads and chains for chataleine bags to be dutiable as manufactures of the component of chief value, as claimed by the importers. G. A. 6130 (T. D. 26653), G. A. 6322 (T. D. 27239), G. A. 6374 (T. D. 27382), Steinhardt v. United States (113 Fed. Rep., 996), and Tiffany v. United States (131 Fed. Rep., 398; T. D. 25316) followed.

METAL ORNAMENTS.—Protests of Glaenger Frères & Rheinboldt *et al.* against the assessment of duty by the Collector of Customs at New York. G. A. 6374 (T. D. 27382) followed.

### Complainant Again Fails to Start Test Case Under New York Gold Law.

On a summons issued from the Essex Market Court, J. Finkel, of Locketz & Finkel, jewelry manufacturers at 218 E. Houston St., New York, was in that court Tuesday of last week to answer to the charge of violating section 304-J of the Penal Code, the new Gold Law of the State of New York, the complainant being Maurice Blumen and J. Jacobs, of the Brooklyn Watch Chain Co., 275 Bowery. This was the second case brought by the same complainants. The charge which the complainants tried for the second time to press against the defendants was that the latter had sold gold chain slides with the mark of 14 karats, when the gold really assayed below 13 karats. Magistrate Breen was sitting in court when the case was called. Louis Karasik appeared as counsel for the complainants and Sol. L. Youngentob represented the defendants.

As soon as Mr. Karasik had stated the nature of the complaint, Mr. Youngentob interposed two objections. He said that in the first place the case was *res adjudicata*, having been before Magistrate Finn early in June. At that time an hour or more was consumed in taking testimony, and at an adjourned hearing the magistrate dismissed the case. Magistrate Breen intimated that as there was no complaint in the former case another prosecution was not barred.

Mr. Youngentob also objected on the ground that substantially the same issues are involved in a civil suit now pending in the Municipal Court, Seventh District of Brooklyn. In that case his clients have sued the Brooklyn Watch Chain Co. for \$45, the purchase price of the slides. The defense to the suit is that the slides did not conform to the guarantee.

Magistrate Breen, after listening for a few minutes to the arguments of the lawyers, concluded not to hear the case, as it had already been before Magistrate Finn. The complainants were advised to go before the latter magistrate and ask for a re-opening of the case if they so desired. Mr. Karasik said that he would do so.

Pearl Watson, Abingdon, Ill., and Miss Anna Arnold were recently united in marriage at the home of the bride's parents, Mr. and Mrs. C. A. Church, Belle Plaine, Ia. The groom was a clerk in Mr. Church's jewelry store until a few months ago when he moved to Abingdon, buying a stock of jewelry there, and engaging in business on his own account. The bride also has a knowledge of the jewelry business, having been Mr. Church's clerk and assistant during Mr. Watson's absence in Abingdon.

# HAYDEN W. WHEELER & CO.

## MOUNTED DIAMONDS

We are making up many new pieces in mounted diamonds for our Fall stock and will show new ideas and a larger and finer stock than ever.

Besides mounted diamonds, we have a large stock of loose diamonds, colored stones and pearls.

NECKLACES, BRACELETS AND LA VALLIERES ARE AMONG THE PREVAILING FADS AT PRESENT.



Trade-Mark  
Registered.

AMSTERDAM  
2 TULP STRAAT



Trade-Mark  
Registered.

LONDON  
50 HOLBORN VIADUC

2 MAIDEN LANE, NEW YORK

TELEPHONE  
7365 CORTLANDT

ORDER

# DIAMONDS

ON MEMORANDUM FROM

## ALFRED H. SMITH & CO.

170 BROADWAY, NEW YORK.  
Corner Maiden Lane.

London.  
6 Holborn Viaduct.

Chicago,  
103 State Street.

## Oppenheimer Bros. & Veith, Cutters of Diamonds,

65 NASSAU ST. (PRESCOTT BUILDING), NEW YORK.

AMSTERDAM,  
2 Tulp Straat.

LONDON,  
40 Holborn Viaduct.

CUTTING WORKS,  
Cor. Union & Nevins Sts., Brooklyn.

## HENRY E. OPPENHEIMER & CO.,

51 Holborn Viaduct, London.  
50 Rue de Chateaudun, Paris.  
7 Place Loos, Antwerp.

Tel. 621 Cortlandt.

3 MAIDEN LANE, NEW YORK.

DIAMONDS, PEARLS AND PRECIOUS STONES.

MEMORANDUM ORDERS SOLICITED.



## Debate on Watch Industry Renewed in Congress.

**Representative Rainey Renews His Attack on Certain Watch Movement and Watch Case Companies and Their Methods, and Is Answered by Representative Boutell.**

WASHINGTON, D. C., June 27.—The long expected renewal of the debate between Representatives Rainey and Boutell, both of Illinois, over the situation in the American watch trade, which was begun some time ago in the speech by the former before the House of Representatives, has taken place, Mr. Rainey having renewed his attack Monday night upon those manufacturers of watch movements and cases, he claimed, are in a trust.

In a previous speech Mr. Rainey had severely attacked the so-called "big four" in the watch trade, alleging that the products of these companies were sold cheaper abroad than in the United States, and citing as proof of most of his statements the admissions and affidavits of a New York dealer, who has claimed for some time that he can sell watches far below the American market price, because he bought watches abroad and reimported them into this country. At that time Mr. Boutell answered Mr. Rainey, introducing letters and statements tending to prove there is no watch "trust" or legal combination in the watch trade, and second, by attacking directly the truth of the statements of Mr. Rainey and the watch dealer, regarding specific instances in which it was claimed the watches had been purchased abroad and sold here under the market price.

When the amendment to the customs administrative act was before the House a committee of the whole, Monday night, Mr. Rainey again returned to the subject and delivered a long speech, which, in extended form, has just appeared in the *Congressional Record*. In the course of it he not only went over the ground, introducing more evidence in support of his contention that watches were sold abroad cheaper than in this country, but declared that the Treasury Department had helped the manufacturers in the alleged combination by aiding them in preventing the reimportation of such watches. He attacked Secretary Shaw, charging that he had issued orders to the collectors at all ports not to furnish him (Rainey) with any information in regard to the subject; attacked the rules of railroads requiring employees to carry watches up to a certain standard, as an abuse of authority done for the purpose of increasing the business in the products of the "big four;" attacked the officers and management of the watch and watch case companies generally and specifically for the agreements among themselves and between them and their customers under which their product was marketed, claimed that the documentary evidence, letters and other statements which he introduced and with which he supplemented his speech were sufficient to prove a violation of the anti-trust law, and threatened that the whole matter would be laid before the Department of Justice with a request for a special prosecution of the accused.

Mr. Rainey began by referring to a

statement in his previous speech to the effect that about 2,400 American watches were held up at the custom house in New York on the claim that they had been improved in condition while abroad, a cheap Swiss dial having been added. He had said that these watches had been bought from foreign dealers in various parts of the world at a fraction of the price at which they were selling in this country. After correcting the statement that he formerly made, that the entire stock of the New York dealer who had imported these watches, had been purchased abroad, he claimed that the statement had been made inadvertently, admitting the proof of the statement by Mr. Boutell that this same dealer had collected rebates on certain watches purchased in this country.

He then took up the statement formerly made by Mr. Boutell, that watch manufacturers were endeavoring to build up a foreign trade and had succeeded in the export business by using a class of very low grade watches for which there was no market in this country, and that these watches were gilt-plate watches and could be sold as cheap in this country as abroad. This Mr. Rainey claimed was false, as the gilt-plate watches were as good or better than the nickel and were wanted abroad for that reason; also that instead of doing an export business in cheap watches, the companies exported their highest grade movements, and this he insisted on despite the statements made on the authority of the companies' books, that but a very small number of high-grade named watches had ever been shipped abroad. In support of his contention Mr. Rainey read from an advertisement in a foreign paper, stating that a complete stock of Keystone-Elgin watches, in every grade from the highest to the lowest, was carried in the London office of the company at all times, and referred to other advertisements in the British jewelry trade papers in which the high-grade movements of the American companies were advertised by name. After referring to a letter of a Pittsburg jobber to the effect that the manufacture of gilt seven-jeweled movements for the American market was never abandoned, and that there was no superiority in the nickel movements, he referred to the export price list of one of the companies which he claimed showed 14 photographs of movements, every movement advertised, except one grade, being nickel.

On the subject of aid being given by the Treasury Department in preventing the reimportation of American movements, Mr. Rainey said that a statement was made in his presence in the office of the Assistant Secretary of the Treasury that the Waltham Watch Co. had filed a protest against the admission of a large consignment of American movements shipped through New York. He wrote the collector of that port for copies of the protest and the affidavits, offering to pay the usual fees if required. To his letter, he claimed,

the collector answered that he had asked instructions from the Secretary of the Treasury; after waiting some time the collector wrote again that he was unable to give the information, because the department did not feel that it could properly authorize him to do so.

However, Rainey had also written to collectors of about 20 ports, and from one of them (at Los Angeles) he received a copy of a letter sent by Robbins & Appleton to the Secretary of the Treasury stating that American watches were being imported bearing foreign dials, and that the attention of the customs officers be called to the fact and that they be notified to hold the consignment of Waltham watches until an opportunity be given to show whether such watch movements went abroad without dials and had work done upon them in foreign countries. The speaker insinuated that the Swiss dials were put upon the watches abroad by the American companies for the purpose of preventing reimportation, and characterized this as a subterfuge to which one of the great departments of the government was being made a party in order that Americans might not get any advantage of the low prices at which these products were sold out of the United States.

The citations and memoranda introduced by Mr. Rainey both in the course of his speech and in the extended remarks as reported in the *Congressional Record* are most numerous, the entire argument taking up nearly 30 pages of the *Record*. The subject of the "trust" in the watch trade, which he touched on to some extent in the course of his speech was amplified by the introduction in the *Record* of copies of letters from about 75 wholesale and retail dealers from whom he had asked information on the subject, the purport of most of these letters being that the "big four," so-called, consists of the Elgin and the Waltham watch companies, the Keystone and the Crescent watch case companies, and that allied with the interests of the latter two were certain other watch and case companies, such as the Philadelphia Watch Case Co., Bates & Bacon, the New York Standard Watch Co., E. Howard Watch Co., etc. Some of the letters were from jobbers who had been cut off the list of those handling the "big four" products, some from retail jewelers, who claimed that they had been discriminated against one way or another, and some from concerns who practically refused to give any information on the subject whatsoever; but all bore more or less on the subject of the existence of a combination of interests within the trade.

Other evidence as to the existence of a so-called "trust" was offered by Mr. Rainey, and published with his speech, including copies of correspondence between W. J. Johnston (of Pittsburg) and various watch and watch case companies and their representatives; a letter from a jobber to President Roosevelt; a copy of a petition signed by retail jewelers asking the Department of Labor to investigate the condition in the watch industry and the correspondence in regard to the same; and an account of the suit brought in New York courts against certain watch and

# Mr. ABE A. HELLER

is now in charge of our European offices, with headquarters at  
**39 Rue de Chateaudun, PARIS.**



BIRDSEYE VIEW OF PARIS.

Many years of studying the Jewelry trade here have given our Mr. Abe A. Heller an intimate knowledge of the wants of the American Manufacturer, which will be of great advantage in selecting the right goods for the American Market.

## *K. Heller & Son*

Importers of Precious and Imitation Stones.

New York, 51 Maiden Lane      Providence, 212 Union Street  
 Paris, 39 Rue de Chateaudun      Idar, 14 Hauptstrasse  
 TELEPHONE 219 JOHN.

GEORGE H. HODENPYL.

WALTER N. WALKER.

# DIAMONDS

AND

DIAMOND JEWELRY

# HODENPYL & WALKER

Unique  
 and  
 Staple Patterns

170 Broadway, New York  
 Corner of Maiden Lane  
 TELEPHONE, 1898 CORTLAND

Repairing and Recutting  
 Diamonds  
 a Specialty

OUR  
**40th**  
**YEAR**

IN  
 BUSINESS

1866-1906

**DIAMONDS**  
 LOOSE AND MOUNTED

**CASES and MOVEMENTS**  
 ALL MAKES AND GRADES

**JEWELRY**  
 GOLD AND PLATED

ORDERS SOLICITED FROM RESPONSIBLE JEWELERS.      GOODS SENT ON SELECTION.

All our goods are either direct importations, our own manufacture or bought for cash, enabling us to offer special inducements in prices and terms.



EST. 1866.  
*Lissauer & Company*  
 Importers.

2 TULPSTRAAT,  
 AMSTERDAM.

12 MAIDEN LANE,  
 (ONE FLIGHT UP)

P. O. Box, 1625,

**NEW YORK.**

# PEARLS ROUND, BUTTON AND HALF.

Selection Papers Sent on Request

**MARTIN LOW & TAUSSIG,**

51 Maiden Lane, New York.  
 Telephone, 2817-John.

139 Mathewson St., Providence, R. I.  
 Telephone, 3037-Union.

watch case manufacturers by a New York jobber. In addition Mr. Rainey cited the fact that the price lists of certain independent companies had been dropped by seniors' list, which had for many years supplied retail jewelers with prices of watches and movements, and that none now appear in the same, but the prices of the products of the companies which he alleged formed the trust.

Mr. Rainey also went into detail as to the officers and the management of the various companies. He said that Mr. Zurrugg, the president of the Philadelphia Watch Case Co., is also the president of the Keystone Watch Case Co. and the E. Howard Watch Co., and vice-president of the Crescent Watch Case Co., as well as a stockholder in the Elgin National Watch Co., that Mr. Fogg is the secretary and treasurer of the companies of which Mr. Zurrugg is an officer; that the Keystone Watch Case Co. owns the stock of the E. Howard Watch Co., and that the officers and directors of the two are the same; that the Keystone and Elgin companies have an exporting agreement, and that the Keystone company controls the stock of the Crescent concern, etc., all of which showed an identity of interests which he designated as a "trust."

Mr. Rainey claimed to be in a position to prove that the companies worked together, requiring foreign dealers to agree not to permit the reimportation of American watches, or sell them for any such purpose, and in this connection extended his remarks to include letters from various English dealers, which tended to confirm his statement. On the subject of watch inspection, he said:

"My colleague has inserted in the *Record* the protest of the labor union composed of employes in the Elgin company's works. I have nothing to say in reply to this, except that, in my opinion, it would be better for the railroad employes of the country to raise a fund and pension every "watch trust" employe, paying them as much for doing nothing as they now receive, than submit longer to the outrageous system of watch inspection \* \* \* Any railroad employe knows what the term "watch inspection" means. It is unnecessary for me to dwell on this point. I might, however, call attention to the infamous scheme a short time ago to compel the purchase of 5,000 watches by the employes of the Erie system, which scheme failed on account of the violent protest of the several brotherhoods of railroad employes.

"In most cases where watch inspection is ordered there is some graft in it somewhere. The watch inspector is always on hand when the order for inspection is made, and dictates the conditions of the order. If this order is made, no matter how good a watch may run, it is sure to be condemned if it does not comply with the order. Train men are familiar with the scheme by which a low-grade watch is purchased, and by changing the bridges or the dials the marking of the watch is also changed, so that it reads, "Locomotive firemen's standard," "Locomotive engineers' standard," "Locomotive trainmen's standard," or something of that kind; and the price of this watch, which has been im-

proved in no way, except by the addition of the above name or a similar name, is increased from \$10 to \$15, and the train man is compelled to submit and purchase one of the low-grade watches so fictitiously increased in value or lose his job. In this connection I expect to put in the *Record*, as an appendix to my speech, a certain letter written to the Brotherhood of Locomotive Firemen, and a letter from P. M. Arthur, of the Brotherhood of Locomotive Engineers, and certain other data upon this subject."

Representative Boutell answered Mr. Rainey June 26. He did not go into the detail that had characterized the attack of his antagonist, nor will the extension of his remarks be anything like as long. His treatment of the subject was in a lighter vein, though his telling points lost none of their effectiveness thereby.

Mr. Boutell compared the discussion about the watch tariff and the watch companies to a comedy to which he proposed to give the name of "Government by Advertisement," referring to the New York dealers' advertisements and to the use of them made by Mr. Rainey. Mr. Boutell then cited various other advertisements and humorously characterized them and applied them very wittily to the situation, keeping his audience well amused for half an hour.

The speaker took up a statement made by Mr. Rainey in regard to the picture of the New York dealer's store displayed in the House by Mr. Rainey during the progress of his speech. Having been asked on that occasion as to the origin of the picture, Mr. Rainey stated that the picture was a photograph made for himself and at his expense during February, 1906. Mr. Boutell then produced copies of the *Free Trade Broadside* for January, 1906, on the front page of which appeared the identical photograph. This produced quite a sensation, especially as Mr. Rainey vouchsafed no explanation.

Turning his attention to the New York dealer, Mr. Boutell read two letters written by him in September and November, 1906, to a Texas jobber, asking him to sell Waltham and Elgin movements of various grades in large quantities, and referring to them as "rare goods." Mr. Boutell commented on this letter as indicating the sham nature of this dealer's claim that he was buying all his Waltham and Elgin watches abroad.

Mr. Boutell produced an advertisement which appeared in the *New York Evening Telegram* in March, 1900, which read:

A WALTHAM WATCH CHEAP.—A man on the inside will give confidential wholesale prices. Box 184, Waltham, Mass.

Supposing that this advertisement emanated from some disloyal employe, the company caused a letter to be written in reply to this advertisement, which letter was answered under the letter-head of the New York dealer and signed with the latter's name.

Referring to the watch interests in Massachusetts, he said:

The Waltham Watch Co. has had 50 years of honorable struggle, sometimes facing failure and bankruptcy, which has resulted in final and triumphant success. The Elgin Co. branched off from the Waltham Co. in 1884. In 1864 the tariff on watches had been placed at 25 per cent. ad valorem, where it so remained even under the Wilson-Gorman act, down to the Dingley act of 1897.

when, in addition to the ad valorem duty, certain specific duties were placed upon watches. Under this invigorating tariff the watch industries flourished in this country, so that there are now in the country 12 manufacturers of watch movements and 18 manufacturers of watch cases, or 30 altogether. Their total output is about 3,300,000 watches. According to statistics we have been able to export 300,000 watches, or about nine per cent. of the total product. As against these 75,000 Swiss watches are annually brought into this country. So that in point of the workers and mechanics in the watch factories, there should not only be any reduction in the duty at this time, but it should be slightly increased, to prevent successful competition of the cheaper made Swiss watches.

I do not represent anybody in this business except the truth, as I can get it, and so far as I can learn there is no better or cleaner industry in this country than the watch industry of to-day—no industry in which there is more perfect rivalry than among these 30 institutions engaged in turning out 3,300,000 timepieces. I do not believe there is another example in the United States where there are great industries engaged in active, healthy rivalry such as in the watch industry.

Replying to the charge of Mr. Rainey that he had received about 100 letters saying that there was a watch "trust," Mr. Boutell said:

I have copies of some letters sent him in reply to his circular letter, and I will insert them in the *Record*, as I don't suppose he will. I here say positively there is no trust, no combination, or anything of that sort in reference to trade, and if there were, they would know it, and the jobbers from whom these came are the men to be affected by any conspiracy.

Referring to Mr. Rainey's statement about John C. Dueber as the first victim of the alleged watch combination, Mr. Boutell showed that the incident referred to took place in 1887; that thereafter Mr. Dueber sued several of the other watch companies in the New York Supreme Court for heavy damages, but failed to win his suit, the jury having disagreed; that he also brought suit in the United States Circuit Court, and that twice demurrers to the suit were sustained, and that finally he discontinued the actions.

Mr. Boutell also produced the minutes of the early meetings of the old association of American watch case manufacturers, organized in 1884, and showed from them that Mr. Dueber was one of the most prominent of the early members, a director and vice-president of that association, and that he was expelled from the association in 1887 upon a charge of breaking the association rules.

Mr. Boutell then closed with an eloquent tribute to the beauties of the Green Valley of Illinois, in which is situated Carrollton, the town of Mr. Rainey's residence, and satirized Mr. Rainey as being the only man from that section who was chronically unhappy and fault-finding, and the only man from Illinois who was not proud of the Elgin National Watch Co.

The Michigan Cut Glass Co., Lansing, Mich., was recently incorporated with a capital stock of \$6,000. The present concern is the outgrowth of the business formerly started by Mauer Bros., former employes of the American Cut Glass Co. The incorporators of the new concern are John J. Matthias, Joseph and Martin Mauer, Thomas Kinney, William E. Holey, August I. Sepanek, T. R. Lyon and Herbert J. Flint. The officers are: President, T. Rogers Lyon; vice-president, Thomas Kinney; secretary and treasurer, Herbert J. Flint; general manager, John J. Mauer. The officers with Matthias Mauer constitute the board of directors.

# Chester Billings & Son

1840

Successors to  
Kandel, Barmore & Billings

1906

Importers of Diamonds  
Other Precious Stones, and  
Pearls, Diamond Jewelry

1840, Kandel & Barmore; 1866, Kandel, Barmore & Co.; 1880, Kandel, Barmore & Billings; 1897, Chester Billings & Son

New York, 58 Nassau Street, 29 Maiden Lane  
London: 22 Holborn Viaduct, E. C. Paris: 53 Rue de Chateaudun  
Amsterdam: 2 Tulp Straat

## Fine Fresh Water Pearls Recently Found in Streams of the United States.

Since the warm weather the waters in the western rivers are receding and the pearls that come from the western cities and villages contain numerous paragraphs in relation to the finding of pearls of greater or less beauty and value. The pearl merchants in New York say that nearly all of the reports are exaggerated. A pearl which is hailed at its discovery as a prize that will surely bring hundreds and perhaps thousands of dollars is sometimes sold for \$50 and the finder is glad to get the money. But not all of the discoveries are of the same character; some really valuable pearls are being found this season as in past years and several of this class have been received in New York in the last week.

I. E. Anthony, of Comanche, Ia., came to New York about the middle of last week to exhibit a 91-grain pearl of pear shape and pink color, which he offered for \$5,000. Mr. O'Harra, of Memphis, Tenn., who was the first man to exploit the Arkansas pearl fisheries, was among the western men visiting the trade in the last week.

Among the reports which interest the trade was one from Red Wing, Minn., saying that William Bates, a clam fisherman, had found in the Wisconsin channel a pearl weighing 85 grains, absolutely round and perfect in structure and texture. Western papers said that the gem has a beautiful luster and when shaded from the light is almost transparent. The value of the pearl is placed by men along the river who have seen it anywhere from \$5,000 to \$100,000. One of the best authorities in New York remarked that the value will depend largely on the amount of rivalry between wealthy gem collectors. According to the story published, Bates and his wife, had been fishing, and at the close of the day he was tired and ready to go home when his wife induced him to make one more drag. One of the mussels which he then brought to the surface she found the pearl which they believe will make them wealthy.

At Vincennes, Ind., Mr. Fabian is said to have found a pearl weighing 102 grains next to the largest ever found in the West at that point. It brought \$1,500.

At Prairie du Chien, Wis., James M. Kelly is reported to have found a 12<sup>3</sup>/<sub>8</sub> grain pearl, which he sold to John Peacock for \$50 a grain. This gem is said to be the size of a pea, perfectly round and with a prettily pink tinge. A report from that city says that the New York buyers who are there declare this to be as fine a pearl of its size as has ever been found in American waters.

Arthur M. Shaw, Haverhill, Mass., was arrested about a week ago on a charge of peddling without a license. Shaw together with three or four other agents had been visiting places in the vicinity of Manchester, N. H., with cheap jewelry. A dozen cards, which were stick pins, clasp pins, etc., were left with different persons. When the person with whom they were left sold a lot for 10 cents a card, he or she was given the choice of a ring. Complaint was made to the police one day by the mother of a girl with whom some of the bogus jewelry had been left.

## COOPER'S SUN RAY DIAMOND

HAS 100 per cent. more brilliancy than any other style of cutting.

**We Challenge the World.**

Send your old mine and yellow diamonds to be recut; if the effect is not 100 per cent. better, NO CHARGE.

## COOPER DIAMOND

Cutting and Polishing Industry of America

49 MAIDEN LANE, NEW YORK.

Factories, 8th Ave & 18th St., Brooklyn.



# EDUARD VAN DAM

### Morris and Joseph Klein Withdraw Their Pleas of Guilty to Grand Larceny Charge and Are Held in Heavy Bail.

Another turn was taken last Wednesday in the case of Joseph and Morris Klein, of Klein Bros. & Co., the bankrupt manufacturing corporation, at 51 Maiden Lane, New York, who have been accused of grand larceny in eight indictments. The defendants appeared before Judge Rosalsky in the Court of General Sessions, and withdrew their former pleas of guilty, at the same time demanding a jury trial. Their bail was then increased to \$15,000 for Joseph Klein and \$10,000 for Morris Klein, the old bonds having been for \$5,000 and \$3,000, respectively. Being unable to furnish bonds in the increased amount the defendants were committed to the Tombs.

When the defendants were arraigned it was expected that sentence would be imposed on their plea of guilty of larceny of the second degree in converting diamonds sold to them on memorandum by L. A. Groen & Bro. On the case being called Morris Klein asked leave to address the court. He said that when he and his brother submitted the plea of guilty to the indictment they did so under the impression that sentence would be suspended. Since then they have been informed that they were mistaken in supposing that sentence would be suspended. He said that they were really innocent of the charge made against them in the indictment of which they pleaded guilty, and he demanded a jury trial.

Judge Rosalsky said that he had no knowledge of anything which would lead the defendants to suppose that sentence would be suspended. Certainly no person had any authority to make any promise in behalf of the court, and the question of sentence was purely for the court to decide. The judge said that the court had looked into the subject and believed that, under the plea of guilty, there was nothing to do but to pass a sentence for a number of years' imprisonment. However, the criminal code provides that if, after a plea of guilty, the defendants in open court desire to withdraw such plea and claim to be innocent then it is in the discretion of the court to allow the withdrawal of such plea.

In practice, said the judge, it is almost a matter of right to give a jury trial if the defendants desire it. Under such circumstances the judge said that if the brothers insisted on withdrawing their plea and were afterward convicted on any of the indictments it might have a serious effect on them.

Abraham Levy, attorney for H. A. Groen & Bro., and also for Eduard Van Dam, who made similar charges against the Kleins, based on memorandum transactions, objected to the court allowing the Kleins to withdraw the plea of guilty. And Judge Rosalsky asked Mr. Gleason, of Hastings & Gleason, attorneys for the Jewelers Board of Trade, what was his attitude in the matter.

Mr. Gleason said that if the court was disposed to allow the Kleins to withdraw their plea he had no suggestions to make.

He said that the memorandum indictments had not been obtained by his clients, and that from the first it had been his desire to have the Kleins tried upon one of the indictments based on the charges preferred by his clients. In these indictments, he said, the defendants are accused of obtaining merchandise under false pretenses by means of a written statement. The attorney said that in his judgment a trial, a verdict and a sentence based on one or more of these indictments would be of greater benefit to the trade than the sentence under a plea of guilty of grand larceny in the second degree.

Mr. Gleason said that his clients desired to get the ruling of the court on the question of the criminal responsibility of persons obtaining merchandise on fraudulent representation in writing as to their financial condition. The indictments include charges of this character made by C. F. Wood & Co. and D. C. Townsend & Co., said the attorney, and it had been his desire, from the inception of the proceedings, to have the Kleins tried on one of these two indictments.

Assistant District Attorneys Nott, Hart and Corrigan were present. There was some discussion as to where the Kleins got the impression that sentence would be suspended, and the judge showed some annoyance because such an idea had been conveyed. Mr. Nott denied that any promise had been made in behalf of the District Attorney's office. Mr. Corrigan, who was present at the time the plea was made, said that, as he told the court at the time, he had no suggestion to make in relation to the sentence.

Judge Rosalsky announced that in view of the misunderstanding of the situation on the part of the defendants and their present assertion of innocence, he would allow them to withdraw the plea.

Mr. Nott then said that as there would be some delay, as a result of the change in the situation, the bail of the defendants should be increased, and he suggested \$15,000 for each. This was vigorously opposed by the defendants' counsel, Louis Vorhaus, and finally the amount was fixed at \$25,000 for the two defendants. It is supposed that the Kleins will now be tried on one of the indictments in October.

Counsel for the Jewelers Board of Trade apparently derive much satisfaction from the result of the hearing. It has been almost an unwritten law that where a plea of guilty to one indictment is accepted the defendants are not tried on the other indictments. The Jewelers Board of Trade has been particularly desirous of having a jury trial on the allegations in the Wood or Townsend cases, and the counsel for the board is now hopeful that one of these cases will be selected for trial.

L. C. Mattern, manager of the optical department of the L. C. Henrichsen Co., Portland, Ore., has just perfected the invention of a bifocal eyeglass. Mr. Mattern, after a year's hard work, claims to have produced a perfect bifocal lens. The process of grinding is a professional secret. He claims that it may revolutionize the eyeglass business, as it is claimed the cost of production will be much less than by means of the old process.

### The Diamond Markets.

ANTWERP, June 24.—There has been a marked improvement in the diamond business in the past fortnight, and many transactions in m $\acute{e}$ lée of 150 to 200 francs per carat have been made. There have also been several important sales to Italian merchants in light brown roses and six faces. White roses of 70 to 150 francs per carat also find ready buyers. The news of the export tax of 10 per cent. passed by the government of Cape Colony also had a good effect in quickening sales of rough and polished goods here.

A partnership has been formed between Jacques Kryn and August Wauters, under the firm style of Jac. Kryn & Wauters, for the purpose of dealing in diamonds for a period of 10 years.

The following buyers were here during the past fortnight: Messrs. Hekster and Bawly, Amsterdam; Messrs. Kauffman, Bronkherst, Infeld, Gerson and Goldberg, London; Mr. Schetino, Naples; Mr. Michalson Montreal; Messrs. Matheassian, Hendamian, Poliatscheck, B. Rapoport, Ekndyssen, Garabistian and M. Slabotsky, Paris; Mr. Bidnowici, Czchernowitz; Mr. D. Acar, Beyruth; Mr. Pines, Warsaw; Messrs. Mounos, Sohn and Kahn, Moscow; Mr. Braum, Vienna; Messrs. Belluschi, Naud, Milan; Messrs. Rosenau and Mach, Munich; Mr. Morrison, Ork; Mr. Samios, Athens; Mr. Breidenbach and Mr. Hirschberg, New York; Mr. Abend, Berlin; Messrs. Frankel and Urbank, Frankfort-on-Main; Mr. Goreth, Rome; Mr. Nocera La Russo, Naples; Mr. Lagowir, St. Petersburg.

AMSTERDAM, June 20.—The month of June has been particularly good for the diamond trade. Several lots of roses have been sold, and brilliants, very small and of good color, find easy sales, as well as ordinary m $\acute{e}$ lée. Several foreign buyers visited the city recently. Work in the diamond shops is quiet.

PARIS, June 21.—The French market is not bad, owing to the fact that a number of foreign buyers have been here. A large jewelry house bought a quantity of old roses which were taken from unsold jewelry, and this somewhat influenced the condition of the market, as these stones were sold at rather low prices, being poor in form and thick in cutting. As far as the color is concerned, they were very good.

Pearls have been sold principally to American merchants. Rubies and emeralds were more or less in demand during the last few days. The demand during July and August is expected to be very much quieter, owing to the fact that many of the merchants will be away.

The old firm of Rambour, 81 Boulevard, Sebastopol, will be managed in the Orient by Mr. Gombault.

The fourth annual meeting of the Texas Optical Association will be held in Waco, Monday and Tuesday, July 9 and 10, in the Business Men's Club. The local opticians are prepared to give the visitors a cordial welcome. The executive committee includes John Wyche, Waco, and B. R. Stocking, secretary and treasurer.

# WM S. HEDGES & CO.,

IMPORTERS AND CUTTERS OF

## DIAMONDS.

Precious Stones and Pearls.

170 Broadway, Corner Maiden Lane, New York.

27 Holborn Viaduct, London.

Saunders, Meurer & Co. Cutters and Importers of

## DIAMONDS AND OTHER PRECIOUS STONES

FINE PEARLS A SPECIALTY.

65 Nassau St., cor. John St., Prescott Building, Telephone, 1613 Cortland. NEW YORK.

Chas. L. Power & Co., Cutters and Importers,

## DIAMONDS

AND OTHER PRECIOUS STONES,

170 Broadway, corner Maiden Lane, NEW YORK.

27 Holborn Viaduct, London.

## GOODFRIEND BROS.,

IMPORTERS AND CUTTERS OF PRECIOUS AND IMITATION STONES.

Pearls

Rubies

Sapphires

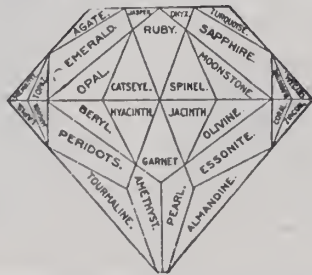

Tourmalines

Gem Corals

Opals

Emeralds

COPYRIGHT, 1895, BY GOODFRIEND BROS.

256 Westminster St., Providence, R. I.  
10 Rue Cadet, Paris.

Tel. No. 662 Cortl.

9-11-13 Maiden Lane, New York.

## CORAL

BORRELLI & VITELLI,  
CORAL MANUFACTURING COMPANY,

All kinds of Coral—DROPS, BUTTONS, LENTILLES.  
CORAL NECKLACES, Graduated and Uniform.

PINK AND WHITE CORAL A SPECIALTY.

GOLD MEDAL, ST. LOUIS, 1904.  
GRAND PRIX, LIEGE, 1905.

3 Via Amedeo, Torre del Greco, Italy. 32 Rue d'Hauteville, Paris, France.

401 Broadway, New York.

Telephone. 5412 Franklin.

CORAL

CORAL

### List of Jewelry Said to Have Been Stolen from Store of M. P. & S. Brann, New York.

For the arrest and conviction of burglars who broke into M. P. & S. Brann jewelry store, at 231 Eighth Ave., New York, and the recovery of the stolen property, a reward of \$1,000 is offered by firm. Pinkerton's National Detective Agency have sent out a circular announcing the reward and describing the jewelry burglary took place between closing time on Saturday, June 9, and the following Monday morning. The circular says:

All the jewelry described herein was stolen from the show window, to which the burglars gained access by entering a cellar next door to the premises in which the jewelry was located, and from there through floor and window floor to show window, viz.: Lady's Tiffany ring, 31 carat lady's Tiffany ring, 2 1/4 carats; lady's Tiffany ring, 1 1/2 carats; lady's Tiffany ring, 1 carat; lady's Tiffany ring, 1 1/8 carats; lady's Tiffany ring, 1.32 carats; man's 3-stone Gypsy ring, 3/4 carat; man's 3-stone Gypsy ring, 1/2 carat; lady's 3-stone Tiffany ring, 1 carat; lady's 3-stone Tiffany ring, 3/4 carat; turquoise ring, surrounded by diamonds; man's heavy Belcher ring, 7/8 carats; 12 Tiffany rings, each weighing from 1/4 to 1/2 carat; man's tooth setting ring, 1/2 carat; man's tooth setting ring, 3/8 carat; 6 Belcher rings, from 1/4 to 3/8 carat each; fancy ring, Belcher, 3/4 carat; cluster ring, emerald center, surrounded with diamonds; Tiffany ring, 1 carat; 2 fancy Belchers, about 1/2 carat each; 6 fancy Belchers, 2 plain, from 3/8 carat to 1/2 carat each; 7 rings, fancy setting, Belcher Tiffany, varying from 1/2 to 1 carat each; stone sunburst pendant; stone scroll pendant; stone pendant; stone heart pendant, stone woodpecker bird pendant 1 pair skeleton ear screws, 3/8 carats; lady's Tiffany ring, 3/4 carat; lady's Tiffany ring, 3/4 carat; lady's Tiffany ring, 3/4 carat; lady's Tiffany rings, from 1/4 of a carat to 1/2 carat each; 6 fancy Belcher rings, from 1/4 carat to 1/2 of a carat each; 6 plain Belcher rings, from 1/4 to 1/2 of a carat each; Tiffany ring, 1/2 carat; Belcher ring, weighing 3/8 carat; 2-stone ring, fancy setting, 3/8 carat, set diagonally; 3-stone ring, fancy setting, 3/8 carat, set diagonally; 5 fancy Belcher rings, about 1/2 carat; man's knot scarfpin, 1/2 carat diamond horseshoe pin with 12 diamonds; diamond horseshoe pin with 9 diamonds; diamond horseshoe pin with 9 diamonds; cluster scarfpin, ruby center, surrounded with diamonds; single scarfpin horseshoe pin, 13 diamonds; 12 pairs lady's earrings, fancy setting, weighing from 1/4 to 1/2 carat; pair diamond screw earrings, 1 1/8 carat lady's heart locket, with 3 diamonds, 3/4 carat; lady's heart locket, with 1 diamond, 1/4 carat; man's locket, set diamond, 3/8 carat; lady's heart locket with 1 diamond, 1/4 carat; lady's solid gold watch, half Roman, with 1 diamond; lady's solid gold watch, half Roman, with 1 diamond; lady's solid gold watch, fancy, with 9 diamonds; sunburst ring, about 1 carat; round pin, with 7 small diamonds, about 1-16 carat each; round pin, with 5 small diamonds, about 1-16 carats each; round pin, with 8 small diamonds, about 1/4 carat each; round pin, with 8 small diamonds, about 1/8 1-32 carat each; 2 round lockets, head shape, with diamond in center, 1 sunburst, with 30 stones, weighing about 3/8 carat; 2 cluster rings, all diamonds, weighing 1 carat; 1 cluster diamond ring, all diamonds, weighing 1 1/2 carats.

Two detectives were called in a hurry early one morning recently to the store of Chas. Horwitz, 303 Washington Ave., Minneapolis, Minn., where, according to report, a safe had been blown open. The result turned out to be the act of a joker.

The jewelry store of Joseph Kops, located at Pittsburg, Pa., was entered some time early Saturday morning and robbed of about \$50 worth of stock. The thief threw two bricks through the plate glass window while a street car was passing. One of the bricks broke the glass in a show case near the store door, causing \$60 damages additional to the value of the goods stolen.

### Back of Apprentices to the Jewelry Trades Emphasized in Report of Massachusetts Bureau of Statistics of Labor.

ATTLEBORO, Mass., June 30.—The Attleboro manufacturing jewelers received the first week copies of a report from the State Bureau of Statistics of Labor, containing data which they themselves, to a certain extent, helped to compile. The feature of the whole report is that the all-around workman has vanished from the jewelry and watch-making industries of Massachusetts, and his place has been taken by the worker who knows only his specialty, produces only a small part of the finished product, and is a far less valuable man from some points of view than the old-fashioned all-around man. The jewelry manufacturers of the town, and of the State at large, are shown to be strongly opposed to the introduction of union labor into their factories.

The State bureau in putting its report together selected the most characteristic and interesting letters from all the employers. The one they chose to show the attitude of the jewelry manufacturers follows:

The trade union has a tendency to lower the standard of mechanics and kill all ambition among laboring classes, as it places the jackass on the same plane as the thoroughbred racer. Its tendency is to pull down the expert to the level of the amateur; and if trade unions are ever successful in accomplishing their ends, there can no longer be anything as an all-round old-fashioned workman. Unionism, from a mechanical standpoint, is a grading in all its tendencies.

Formerly there were apprentices in nearly all the jewelry trades, but in recent years there have been very few. Possibly one reason for this is, many manufacturers have a specialty; for instance, one manufactures watch-bushings; another, chains; another, goods for ladies' wear, brooches, lace pins, etc., and we ourselves, make chains and lockets. So if an apprentice should come into one of these factories to learn the thought of learning the jeweler's trade, he would not get an all-round education in the trade; or, in other words, he would have to work for a year or two in one and then change. Of course, the manufacturer naturally would discourage this change. There have been one or two young men in past years who have worked with us for a time, and in that way might be called apprentices, although there was no special agreement, only an understanding that they should be taught some of the rudiments of the business and work up to become journeymen. So you see in the jewelry business there has been a tendency toward the gradual extinction of the old-fashioned all-around workman of which you speak.

We think it would be for the benefit of the trade generally, and for the young man, if he were to thoroughly learn the trade, even if in after years, when he became a journeyman, he should go to work in one of these shops where they make specialties. He would be a more valuable man and could command better wages.

In regard to the trade unions would say that in our town, and in neighboring town, there are no trade unions among the jewelry workers; that is, none of any strength. There is one in each town, but it does not have the endorsement of the great majority of our people, and we doubt if it will in the immediate future.

The attitude of the manufacturer of jewelry watches and watches was demonstrated by his specimen letter, which speaks for the majority who answered:

There is no doubt that the old-fashioned all-around workman is becoming extinct—shops run on the making of particular pieces in quantities—on the "rip them out" principle, generally as job work. Young men, boys even, soon become quite proficient on one thing and one set of operations, and when they are done with that they are nothing—neither machinists nor brassworkers nor anything else. We have hundreds of applications for

work from men of this kind, and they are not so valuable to us as an apprentice boy would be.

From the figures which the manufacturers furnished in their replies various tables were prepared. It was shown that one plant, making horological goods, has an apprenticeship system, but none of the others in the State, and none of the jewelry plants. This one watch and clock factory apprenticeship is under the control of the employer, who does not believe in placing any restriction upon the number given the advantage of the system, although apprentices are not employed to the exclusion of any journeymen.

The State bureau was impressed by the general character of the reports received with the idea that the State is badly in need of trade schools to teach young people the theory and first steps in all the important industries. This is a matter already agitated widely through the State, and a bill has been passed in the Massachusetts Legislature, which provides an opportunity for such schools to be opened. At Attleboro a school supported in part by the town and in part by the State to teach the young men and women to become all-around jewelers is favored by the manufacturers, and contemplated by the authorities.

To show what such trade schools are able to accomplish the report contains descriptions of the work of several. It has the following to say in regard to the Waltham Horological School:

The need of better and more thoroughly equipped workmen in trade of watchmaking, repairing, etc., led to the establishment of this school in 1870. Under modern conditions in the factories where watches are made, the workmen are kept on special branches of the work, and no one has the opportunity to practise or learn the whole of the trade. When a student has finished his course in this school he is able to make a complete watch, and is also a first class repairer.

The hours of work in the school are eight on every week day except one, when the number of hours is seven. Work is also required during such evenings as may be chosen by the manager. The charge for tuition is \$65 for the first three months, \$50 for the second three months, \$45 for the third three months, and \$40 for each three months thereafter, payable quarterly in advance.

The course of instruction covers the following branches: Plates, wheels, pinions, jewels, balances, staffs, jeweling, springing, screws, stem-winding parts, matching, finishing, adjusting, repairing, tools, ophthalmology and engraving.

Diplomas are given to all who successfully complete the prescribed course. Students are expected to purchase the smaller tools they use in ordinary bench work; the expense need not exceed \$20. Lathes and lathe attachments and the more expensive tools are furnished by the school. The school has four instructors, including a teacher of engraving and a teacher of optics, who is a regular physician and oculist. The annual cost of maintaining the school is \$5,000; this amount is raised from the money received from pupils in fees. The average attendance during 1904-05 was 30.

The marriage of John L. Eaves, of the firm of Edmund Eaves, Ltd., Montreal, one of the oldest jewelry jobbing firms in Canada, took place last week at St. Luke's Church, Montreal. The bride, Miss Florence Ogden, was given away by her father, and Miss Lyla Ogden, sister of the bride, was bridesmaid. Edmund Eaves, of the firm of Eaves Bros., brother of the groom, was best man. Mr. and Mrs. Eaves are spending their honeymoon in the west, and will reside on their return at 417 Mount Stephen Ave.

### Plant, Office Fixtures, Etc., of Bankrupt Firm of Schickerling Bros. & Co., Again Offered for Sale.

Machinery, office fixtures, furniture, safes and other chattels of Schickerling Bros. & Co., bankrupt jewelry manufacturers, 28 E. 22d St., New York, are to be sold at public auction under the direction of Robert S. Morris, the trustee in bankruptcy, next Tuesday, at 10:30 A. M., on the premises. The sale will be conducted by an engineer. The property may be inspected between 9 A. M. and 4 P. M. any day until Saturday.

This property was offered for sale before Mrs. Schroeder, the mother-in-law of Conrad Schickerling, holds a chattel mortgage and, the former effort to sell was made under an arrangement making the sale conditional on her approval. The highest offer was about \$3,000, and instead of approving this offer she suggested the sale to friends for \$100 more than the highest bid. Eph. A. Karelson, who acts as counsel for the trustee, objected to this plan. He said that the machinery had been inventoried at \$28,000, and that he did not intend to allow the Schickerlings to buy back the property for less than its value. As a result a new sale was ordered.

The stock of Schickerling Bros. & Co. was sold some time ago and after deducting expenses there remains about \$10,000 in money in the hands of the trustee. To this will be added whatever is received from the sale next week. The only other assets that are in sight, Mr. Karelson says, are the claims which the trustee has against certain creditors, who are alleged to have received preferences. Mr. Karelson says that after other legal proceedings involving the Schickerlings are out of the way it is his intention to proceed with the cases against the creditors who are alleged to have received preferences.

### Pittsburg Jeweler Asks Leniency for Prisoner Who Robbed Him.

PITTSBURG, June 30.—After prosecuting the defendant on four charges and securing a conviction, S. Gallagher, 1200 Penn Ave., appeared in the criminal court to-day and pleaded for leniency for S. Baccario, whom Gallagher brought back from Atlantic City several months ago for swindling him out of \$1,200 worth of goods and for forging several checks. Baccario was arrested by Detective Homer E. Crooks, of this city. Two charges of forgery was made against him, one of larceny by bailee and another for false pretense. He was convicted.

When Baccario was called up for sentence the jeweler asked the court to be lenient on the ground that the prisoner was helping to educate two orphan nieces and that when he committed the crimes charged against him it was for the purpose of getting money to pay for their education. Gallagher had trusted to the honesty of Baccario, giving him many goods to show a prospective customer, principally diamonds.

The court told the prisoner that he could give him 16 years on the charges made against him, but in view of the jeweler's plea sentenced him to two years in the Western Penitentiary.

ADDISON W. WOODHULL, President.  
FRANK K. HUFF, Vice-President.

GILBERT T. WOODHULL, Treasurer.  
WILLIAM J. McQUILLIN, Secretary.

# MOUNT & WOODHULL,

IMPORTERS OF

**DIAMONDS,  
OTHER PRECIOUS STONES,  
PEARLS, ETC.**

MAKERS OF

**FINE  
DIAMOND  
JEWELRY.**

26 Maiden Lane,  
(Southwest Corner Nassau Street)

**NEW YORK.**

**PARIS ADDRESS:**  
5 SQUARE DE L'OPERA.

**BAGG, PERINE & CO.,**  
RARE SPECIMENS OF  
DIAMONDS AND OTHER  
PRECIOUS STONES,  
21 & 23 MAIDEN LANE, NEW YORK.  
Tel. No. 6226 Cortlandt.

**EMERALDS,  
DIAMONDS  
AND  
PEARLS.**

**RUBIES AND  
SAPPHIRES.**

**CABLE ADDRESS:**  
**MILBAGG.**

## Pearl Necklaces and Collarettes.

**Mounted  
Diamond  
Jewelry**

of every  
description.

*Louis Vassier*  
*Edward Weiss*  
*Emil Knorr,  
John W. Pfeiffer,  
Frank L. Wood.*

Large  
assortment  
of all kinds of  
very fine, fancy  
and rare gems,  
including Pearls,  
Diamonds, Rubies,  
Emeralds and Sapphires.

182 & 184 BROADWAY  
NEW YORK

**Particularly Fancy  
Colored and Fancy  
Shaped Diamonds.**

### LETTERS TO THE EDITOR

San Francisco Diamond Dealer T  
of His Experience During the Fir  
SAN FRANCISCO, June 20, 1901  
Editor THE JEWELERS' CIRCULAR—WEEKLY  
Your valuable paper of the 6th inst. s  
received, and as I see no mention made f  
my store I decided to send you the foll  
ing:

The A. Andrews Diamond Palace wa  
old landmark in San Francisco and  
considered by all tourists who visited  
city to be one of the sights. Aside f  
the beauty of the goods in the cases, w  
were only of the best quality, the store  
an art gallery, and a sort of wonderlan  
account of the arrangement of the inter  
which consisted of thousands of incan  
cent electric lights and a great numbe  
immense mirrors so placed that it was  
possible to see just where the real s  
ended and the reflections began. The up  
ceiling was dome shaped and containe  
great number of beautiful oil painting  
famous artists.

When the fire was noticed to be cree  
towards the store I started my clerks p  
ing up all the diamonds; when that  
finished the watches; then all gold jew  
and so on until by the time the milk  
compelled all persons to leave the bloc  
had saved nearly all of the stock with  
exception of a small amount of silverw  
Of course the expensive fixtures w  
burned. Had I been able to get wagon  
carry the goods away I think I might  
saved everything, even to the show case.

My insurance losses were among the t  
adjusted, and I and my employes rece  
Many compliments from the insur  
people for the course I adopted to prot  
my goods and the immense money v  
that was saved. My books were place  
the disposal of the adjusters, who went  
every item and every piece of stock s  
checked off exactly right up to the da  
the fire. The three adjusters, who re  
undoubtedly as clever men as any in  
business, had only words of praise for  
thorough and yet simple manner in w  
the records of the stock were kept. Th  
cation of my store was such that I tk  
it was burned before any of the large v  
elry stores, and yet the amount saved  
greater than any of the others, which spk  
volumes for the bravery and coolness o  
men.

I intend building a new Diamond Pal  
larger and more beautiful than the old  
my aim will be to make it the most be  
ful store in the world. No expense w  
spared in its construction. I have al  
arranged with Edouard Tojetti, the fa  
artist, to come to San Francisco for  
work alone. As I am now past 80 yea  
age I think I am setting an exampl  
some of the younger, though more t  
business men of this city in a way th  
give them more confidence in them  
and the city and encourage them to be  
and doing." Yours respectfully,  
A. ANDREWS

A young man found an extraordin  
fine pearl near Red Wing, Minn., rec  
It is translucent and almost transpa  
weighing 85 grains. It is perfectly r  
and without a flaw.



### Important Points Involved in Suit to Recover 60 Per Cent. on Pearls Imported for a Necklace.

Announcement was made in last week's issue of the fact that the government had begun a suit against Bernard Citroen, of Paris, for the recovery of additional duties on the collection of pearls which he recently imported, and which are said to comprise the most valuable pearl necklace has been offered for sale in years. The complaint, drawn by Assistant District Attorney Francis J. Carmody has not yet been served. In it are recited the facts of the importation, June 11, on the steamship *La Touraine* of what the importer described as a package of pearls in their natural condition. Duties on the pearls were liquidated by the collector of customs at New York at \$132,102, and the importer paid \$107,707, so the government now demands a balance, \$110,335.

The contention of the government will be met by William B. Leeds, of New York City, and Pittsburg, bought the pearls in Paris for Citroen for the purpose of a necklace. It will be claimed that, although the pearls were placed on a temporary cord for the purpose of shipment, Mr. Citroen brought them to this country for the purpose of delivering them in safe condition to the buyer's wife. The law point will be that intent must be considered and the intention of the buyer was to procure a valuable necklace for his wife; that for this use the gems were sold by the jeweler in Paris.

The principle of protection will be invoked. The claim will be made that the pearls in the United States are entitled to the same protection against the jewelers of Paris or other foreign cities, who may import the bringing in at a low duty rate, that are really jewelry and therefore subject to a duty of 60 per cent.

The bringing in of the gems at 10 per cent., pearls in their natural state, the importer, it will be argued, has sought to evade the full duty required under the jewelry clause. If pearls may be removed from their permanent string and then imported at 10 per cent. instead of 60 per cent., it will be claimed, then all kinds of pearls may be removed from their settings and brought here at the same low rate, thereby giving to the jewelers of Europe an opportunity to compete on almost even terms, as to prices, with the jewelers of this country.

The Tiffany, Neresheimer and Coolidge positions will all be quoted. Although in some of those cases the government was defeated, the opinions are relied upon as furnishing strong arguments against the importer in the present case. In the other proceedings the courts pointed out that the government, in one or another respect, failed to constitute a necklace. The courts observed in making those decisions that when pearls are so assembled, graded, matched and sold as to make a collocation known in the trade as an article of jewelry or necklace (pearls strung), then they would be subject to the jewelry duty of 60 per cent. One of the tests suggested by the government was that if the assembling was of such a character that the collection of pearls had a greater value than the indi-

vidual pearls in such collection then it might properly be classified as a necklace or as pearls strung.

In the Citroen case it will be claimed not only do the pearls show all the elements that constitute a necklace under the rulings of the courts, but also the government has positive evidence that they actually were strung as a necklace when the sale was made in Paris, and the intention of the buyer was to get a necklace for his wife to wear. This intention, it is said, will sharply differentiate these pearls from those that may be assembled and matched and assorted for purposes of trade—that is to be sold in this country to be made up into various articles of jewelry.

Mr. Citroen has not indicated the grounds on which he will oppose the suit. He appeared last week for the second time before Assistant Secretary Reynolds of the Treasury Department and asked, this time, that he be allowed to take back the pearls to Paris. The assistant secretary was willing that he should do so, but refused to order the return of the duties already paid. Mr. Citroen was not willing to forfeit the duties which he paid, so it is expected that he will defend the suit now brought against him.

### Death of George E. Wilkins.

SYRACUSE, N. Y., July 3.—George E. Wilkins, a well-known jeweler, and one of the oldest in the business in Syracuse, died Thursday afternoon at his residence, corner of Cedar and Almond Sts. He took cold when a new window was being placed in the store, and his illness subsequently developed into pneumonia. His advanced age, 75 years, made his recovery impossible.

Mr. Wilkins was born in New England, and came to Syracuse to live in 1853, working for D. Valentine, a leading jeweler of those days. For 20 years he remained with Mr. Valentine, and came to be known as a superior judge of diamonds and precious stones, gaining a reputation which extended outside of Syracuse. About 25 years ago he went into the business for himself in the Larned block in E. Washington St., and had remained in the same store ever since, building up a business throughout central New York. He made frequent trips to Europe, where he purchased watches and diamonds in London, Germany and Switzerland. Mr. Wilkins had probably sold high-grade watches to more prominent and wealthy men of central New York than had any other man who ever lived in Syracuse. His customers had implicit faith in his judgment, and he was willing at any time to give his opinion, which was usually right.

Mr. Wilkins had a unique experience just prior to the breaking out of the Civil War. In 1861 he was located at Pensacola, Fla., where he dealt largely in ship chronometers and nautical instruments. When the war broke out Mr. Wilkins was ordered by the Confederates to leave Pensacola within 24 hours. He sailed to Cuba and went on foot all over that island. Being without funds, he tried to sell a ship's chronometer, and was arrested and locked up in jail in Havana. He was quickly liberated through the assistance of the American consul, as it was shown that his arrest was due to mistaken identity.

Mr. Wilkins married Miss Morris, of Baldwinsville. He is survived by a widow and two daughters, Frances and Louise Wilkins, of this city.

### Simon Robertson, New York, Goes Into Bankruptcy and Creditors Refuse His Offer of Settlement.

A petition in bankruptcy was filed last week against Simon Robertson, who has stores at 1283 Broadway, in Manhattan, and 1029 Broadway, in Brooklyn, New York. It was said that his debts exceed \$5,000. After the filing of the petition a meeting of creditors was held in the office of McBurney & McBurney, who represent a number of the creditors. A settlement on a basis of 25 per cent., of which 10 per cent. was to be in cash and the remainder in notes, was offered in behalf of Mr. Robertson. The creditors appointed a committee who, on Thursday last, held a conference with Marks & Marks, Robertson's attorneys. At that time the offer was increased to 33½ per cent. The committee asked for 40 per cent., but the bankrupt did not advance his offer to that extent, and the meeting adjourned without effecting a settlement.

Friday last Mr. Robertson was examined before the referee in bankruptcy in Brooklyn. His examination was interrupted to enable the attorneys to ask questions of one of the creditors. When the lawyers turned to place Robinson again on the stand he had gone, and they have been busy since trying to serve a subpoena requiring his further attendance.

George W. Minzil is the receiver, and is represented by Walter Kolm as attorney.

### Death of Alfred E. Seliger.

ST. PAUL, Minn., June 27.—Alfred E. Seliger, president of the Anchor Silver Plate Co., of this city, died yesterday of apoplexy. Mr. Seliger had been ailing since the fire destroyed the plant of his company last September. He worried considerably over this, and suffered from severe pains in the head. He went to New York early in the year to consult leading specialists, who thought his ailment was not serious. He returned to St. Paul and supervised the extensive preparations for rebuilding and refurbishing the factory. The machinery had all been refinished and the plant completely equipped and ready to start up when Mr. Seliger was stricken.

The deceased started in the manufacture of silver hollow ware in Oswego, N. Y., and, believing the west offered better opportunities, formed the Anchor Silver Plate Co. and located in Muncie, Ind., from which place, on account of the supply of natural gas giving out, the company removed about three years ago to St. Paul, where it met with great success until last September. There, in the middle of the Fall season, with nearly \$50,000 worth of orders on hand, the plant was entirely destroyed.

Mr. Seliger was well known throughout the trade, and his sudden death will be received with great regret by his many friends and acquaintances. His remains were taken to New York, where the funeral services were held. The interment was in Brooklyn. Mr. Seliger is survived by a widow, two sons and one daughter.

# EICHBERG & CO.,

IMPORTERS AND CUTTERS OF

## DIAMONDS,

65 NASSAU STREET, (Prescott Building.) NEW YORK.

# STERN BROS. & CO.,

IMPORTERS AND CUTTERS OF

## DIAMONDS,

CUTTING WORKS:  
138-142 West 14th St., N. Y.

68 Nassau St.,  
NEW YORK.

CHICAGO,  
103 State St.

LONDON,  
29 Ely Place.

### Interesting Problems Discussed at recent Convention of the Wisconsin Retail Jewelers' Association.

MILWAUKEE, Wis., June 29.—Wisconsin jewelers in State convention have set the seal of approval upon the law recently enacted by Congress, requiring that jewelry shall be just what it is stamped to be. A resolution was adopted at the closing session, Thursday, commending the act of Congress and providing for the cooperation of the Wisconsin State Retail Jewelers Association with the national organization to be formed next month, in Rochester, N. Y.

The resolution was thoroughly discussed but it met with practically no opposition. The gist of the remarks was contained in the short talk made by George Duran, Milwaukee delegate. "It is the fair thing all around," he said. "It not only protects the public, but it protects the retailer. Many a retailer sells a piece of gold jewelry as 18 karat, honestly believing that the goods are as represented. But there have been dishonest retailers, dishonest jobbers and dishonest manufacturers, and when the goods come down the line to the consumer it is then that the public gets the worst of it. A retailer will order a lot of plain rings, for instance. He will tell his jobber to shade them to about 16 karat and the jobber will instruct the manufacturer to make them 14 and the manufacturer, not to be outdone, will add from 10 to 25 cents on each ring to his own coffers by putting in only 12 karat metal."

Among the important papers read and discussed were: Wednesday—"Can a jewelry business succeed in the big city town under the present conditions or should we add a side line?" T. J. Thompson, Kenosha; "Is it possible or practical to conduct a jewelry store on a strictly cash basis?" John P. Hess, Fond du Lac; "What can be adopted to bring the jewelers in the big town and neighboring towns to a new understanding that will insure a living and more friendly feeling?" M. M. L. Kenosha.

Thursday—"What is the best way to reach the mail order house customer who comes to get prices and refers to 'factory logne prices'?" F. H. Coburn, East Troy; "Should we handle or push watches in the factory whose line is sold by the mail order house or even if they make a line of watches under special name for mail order concerns?" Arthur C. Wagner, Fond du Lac; "The retailer who cuts prices," Shannon, Montello; "Should the retailer patronize the jobber who furnishes goods to the customers of the retailer, either in sales over the counter or by mail order?" E. L. Feiling, Milwaukee.

Another important question discussed was the sale of silverware in hardware stores. A strong resolution was passed by the manufacturers to refuse to sell to the hardware dealers, and urging some kind of mutual co-operation among the retail jewelers to discipline such manufacturers and continue to sell to them.

Nearly 250 members were enrolled in the Wisconsin organization before the closing of the convention, and every man pledged himself to bring another member

## A. ROSEMAN, 9-11-13 Maiden Lane, New York

IMPORTER OF

# DIAMONDS

Maker of Diamond Jewelry



TRADE-MARK.

Established 1872

HEADQUARTERS FOR

# AMERICAN WATCHES

ESTABLISHED 1872.

## E. HAHN & CO.,

33, HATTON GARDEN, 33 LONDON.

CABLE ADDRESS: "AQUAMARINE," LONDON.

Precious Stones, Semi-Precious Stones, Ceylon Fancy Stones, Pearls, Corals, Opals and All Novelties in Stones suitable for

- I. All Jewelry and Export Purposes.
- II. Art Metal Work, Church Work.
- III. Mechanical Purposes.
- IV. Collectors, Educational purposes, Museums.

IMPORTERS

## DIAMONDS

CUTTERS

# Jacob Strauss & Sons

14 MAIDEN LANE

NEW YORK

## SOHN and HYMAN

IMPORTERS OF PRECIOUS AND IMITATION STONES

Crystals Engraved and Painted from Photo. Crests and Coats of Arms Engraved. Stone Seal Engravers and Incrusters. Lapidary Work a Specialty.

JOBGING STONES A SPECIALTY

47 and 49 Maiden Lane,

NEW YORK

THE BOSTON DIAMOND HOUSE

# JOHN B. HUMPHREY CO.

387 Washington St., Boston, Mass.

We are receiving Monthly Shipments of Diamonds from our Brazilian Mines, which are on exhibition at our Boston Office.

Cutters of DIAMONDS

Cutters of DIAMONDS

ld until all the 651 retail jewelers of the ate have come. An address on this sub- et was made by R. B. Watrous, secretary the Citizens' Business League of Mil- waukee. Mr. Watrous spoke on the open- ing day of the convention, when the wel- coming addresses were made. A. J. Stoess- l, Milwaukee, gave the delegates the free- om of the city, and a response was made Gustave Keller, Appleton, in behalf of e organization. At 5.15 o'clock on Wed- sday the Milwaukee Retail Jewelers' ab entertained the visitors. Work of e convention was dropped and forgotten. rom the hall the delegates were marshaled ward the good ship *Chequamogon*, and ter an hour on Lake Michigan in perfect ether were landed at Whitefish Bay Park. ere a banquet was served, and the guests re entertained by Joseph G. Donnelly, a ll-known after-dinner speaker.

At the business session Thursday the fol- lowing officers were elected: President, A. Stoessel, Milwaukee; vice-president, Gus- tave Keller, Appleton; secretary, Franklin Thomson, Milwaukee; treasurer, John Hess, Fond du Lac. Board of Di- rectors: A. J. Stoessel, Franklin Thomson, H. Upmeyer, H. F. Stecher, Gustave Keller, John P. Hess, George Durner and H. Coburn.

During the closing session all members re invited to submit designs for an asso- ciation emblem to be adopted at the next onvention. The local committee in charge e entertainment, consisting of George rner, Harry Stouthamer, A. J. Stoessel d E. F. Rohn, was given a vote of thanks, id the first annual convention of the Wis- consin Retail Jewelers' Association came to happy end.

#### ROSTER OF MEMBERS.

John Armbruster, Cedarburg; T. S. Arthur, Fond du Lac; Alsted-Kasten Co., Milwaukee; R. Anger & Co., Oshkosh; Charles F. Askins, Oshkosh; F. H. Boehrer, Durand; Bunde & Up- ьер, Milwaukee; Birely & Son, Oshkosh; W. Becken, Beaver Dam; A. Bloedel, A. Bringe d Emil Bachman, Milwaukee; H. J. Crook, Madison; F. H. Coburn, East Troy; T. J. Dale, Kenosha; George Durner and Louis Esser, Mil- waukee; Engels & Drusson, Green Bay; Fuchs & entschel and E. L. Feiling, Milwaukee; S. Feur- in, Green Bay; Albert Fuchs, Milwaukee; W. Grunert, Green Bay; Otto Georg, Milwaukee; Harry C. Hart, Plainfield; M. M. Huck and L. H. olbrook, Kenosha; John P. Hess, Fond du Lac; H. Haackleman and Frank C. Hyde & Co., Appleton; H. Hammersmith, Milwaukee; Oscar roehneke, Marathon; K. F. Keller & Son and A. Kamps Co., Appleton; Paul R. Kohls, Fre- ont; Edward Koenig, Green Bay; C. H. Koch, Milwaukee; H. J. Klee, Kaukauna; A. E. Kaiser, Green Bay; Thomas S. Lockhart, Kenosha; Oscar Lentz, Clintonville; J. Liebenow, Green Bay; J. Link, Shiocton; G. Logemann & Sons Co. d Casimir Meller, Milwaukee; Adolf Michael, Green Bay; Andrew McCormick, Greenwood; Otto ueller, Wausau; Victor S. Maurseth, Stoughton; Louis A. Manz and O. H. Nehs, Milwaukee; W. Ortscheid, Cassville; Preusser Jewelry Co., Mil- waukee; Rathke & Meiners, Mayville; A. C. adtke, Bangor; R. P. Rassmussen & Co., Racine; F. Rohn and E. J. Rohn, Milwaukee; Theo. C. eudell, Chilton; C. E. Slocum, Rosholt; Frank rannon, Montello; German Scherzinger and H. Sombre, Fond du Lac; J. Sauermann, R. Seidel, Hugo Schneider, Theo. Schelle, Henry F. Stecher, Sachs, Stouthamer Bros., A. J. Stoessel, W. & Schmidt Co. and Archie Tegtmeyer, Milwau- ee; T. J. Thompson, Barron; B. W. Thien and W. Teschner, Milwaukee; H. R. Vergerout, onfort; Jacob van der Zanden, Green Bay; D. an Wort, Evansville; W. W. Winchester, mery; Richard Weitlich, Sturgeon Bay; Arthur agner Co., Edgar; Jos. Wellstein and Frank inger, Milwaukee; Joseph T. Wendling, Chilton; P. Wilde, Milwaukee; R. P. Yale, Glenwood.

## News Gleanings.

E. C. Sizemore, Albertville, Ala., will shortly move into more commodious quar- ters.

Daniels & Williamson, Newberry, S. C., have enlarged and entirely renovated their quarters.

C. E. Fritts, Sag Harbor, N. Y., is spend- ing a few days with his parents at Ches- ter, N. Y.

Rudolph F. Schubart, Wheeling, W. Va., has left with a party of friends for a short tour of Europe.

Hastings, Doyle & Allum have suc- ceeded to the jewelry business of E. M. Allum, Revelstoke, B. C.

A. C. Wanner, Freeport, Ill., is enlarg- ing his store room by an addition of 25 feet of space and erecting a new front and steel ceiling.

The Portsmouth Loan Co., Portsmouth, N. H., has sold its jewelry and loan busi- ness to the former manager, S. Polimer, who will take possession July 16.

Rudolph C. Eisenbach, Lafayette, Ind., will supply the 1,000 buttons to the Purdu Athlete Society, the contract having re- cently been awarded to him.

In the possession of James T. McCan, Greensburg, Pa., is a unique clock, which is said to be over 100 years old. The old timepiece keeps accurate time.

John Deister, a watchmaker with Jno. Bally & Son, Elmira, N. Y., and Miss G. E. Stevens, were united in marriage at the home of the bride in that city, on Monday, of last week.

A new clock will shortly be installed by the E. Howard Clock Co., in the court house dome at Vinton, Ia. The timepiece is the gift of Paul Correll.

Austin Jones, a retail jeweler, of White- hall, N. Y., was united in marriage June 22 to Miss Margaret E. Miller, a trained nurse, of Montreal, Can., while the latter was dangerously ill with typhoid fever.

The store of F. Wylie, Waverly, Ill., was broken into, recently, by thieves, who stole several watches and a large amount of jewelry. Two shots were fired at the night watchman, but he escaped injury. There is no clue to the thieves.

During a recent fire at Jefferson, O., in which 14 buildings were destroyed, caus- ing a loss of \$75,000, damage amounting to several hundred dollars was done to the stock of Hurbert H. Moses. The loss was covered by \$700 insurance.

James Taylor, a negro porter in the store of the Calhoun Jewelry Co., Birming- ham, Ala., was recently arrested on a charge of grand larceny. When searched, a bundle of silver spoons, a watch and a fob and two fountain pens were found in his possession.

In the show window of the store of H. Frank Peters, Moline, Ill., are to be seen interesting relics of the San Francisco earthquake and fire. The souvenirs of the disaster were picked up in that city by Oscar Severin, of Moline, two days after the fire. The collection comprises chiefly chinaware, including plates, vases, etc. A watch was also found.

At 1 o'clock on the morning of June 25 it was discovered by the night watchman that Jaeger Bros.' jewelry store on Mor-

risson St., between 1th and 5th Sts., Port- land, Ore., had been robbed of about \$2,500 worth of jewelry. The robbers effected entrance through the rear door with a jimmy, broke through a glass door at the rear of the salesroom and abstracted a tray of precious stones which had been locked in a secret drawer under the show case.

A charter has been issued to the Allan Jewelry Co., of Charleston, S. C., and an- other to James Allan & Co., Inc., of the same place. The incorporators of both corporations are James Allan, E. F. Mis- cally, James Allan, Jr., W. S. Allan and Richard H. Allan. The Allan Jewelry Co.'s capital stock is \$75,000, and that of James Allan & Co., Inc., \$50,000. The pur- pose of the corporation is to continue the business of James Allan & Co. and separate the retail from the wholesale and manufacturing parts of the business.

Frederick Bucher & Sons, manufactur- ing jewelers, opened their new retail store at 218 N. Charles St., Baltimore, Md., June 25. The business was established in 1878 by Frederick Bucher at 9-11 E. Bal- timore St., and continued there until the great fire of 1904, when a temporary loca- tion was secured at 12 Clay St. The pres- ent store was purchased early this year, and thoroughly remodeled to suit the needs of the business. It is up to date in every respect, with mahogany furniture, glass cases, racks, etc., the whole blending har- moniously and making a very attractive appearance.

## New Stores and Enterprises.

Bernbaum & Polinsky have opened a store in Winnipeg, Man.

J. H. Williams opened a watch and jew- elry repairing shop in Normal, Ill., July 1.

The Empire Jewelry Co. is opening a jewelry store at 49 Queen St., W. Toronto, Ont.

Earl Bates, Hope, R. I., will shortly en- gage in the retail jewelry business in Attle- boro, Mass.

I. M. Buskirk has opened a retail jewelry store in the new Hinkel block, 66 Market St., Corning, N. Y.

H. Greenwald and Fred. Adams will soon start in business in Tucson, Ariz., under the firm name of Greenwald & Adams.

The Norvell Jewelry Co. is the name of a new business about to be started in Stutt- gart, Ark., by Mrs. Frances Norvell.

The Royal Loan & Jewelry Co., Ltd., New Orleans, La., has filed its charter with the Secretary of State, the capital stock of the concern being \$15,000. The officers are: President, P. M. Stein; secretary and treas- urer, A. Hurwitz.

The Kryptok Bifocal Association has just been incorporated in the State of New York with a capital stock of \$10,000. The incor- porators were: J. R. Schwenzer, C. Jessen, A. S. Moore, A. W. Proctor and W. M. Chapin, all of New York.

The Hurel Co. was incorporated a short time ago to manufacture and deal in jew- elry and optical instruments, with a capital stock of \$15,000. The officers are: Presi- dent, Benjamin W. King, Beverly, Mass.; treasurer, Willard E. Munday, Cambridge, Mass.; clerk, D. Hunt, Wakefield, Mass.

# OPALS

WE ARE CONSTANTLY RECEIVING ROUGH OPALS DIRECT FROM THE FIELDS WHICH WE CUT INTO DESIRABLE SIZES AND SHAPES.

WE HAVE A LINE OF DARK MATRIX KNOWN AS

## BRECCIATED OPAL

WHICH IS INTERESTING AND REASONABLE.

## BUY FROM THE CUTTERS

### AMERICAN GEM & PEARL CO.

14 & 16 Church St., NEW YORK

LONDON: 16 Holborn Viaduct

PARIS: 39 Rue de Chateaudun

## FROM MINES TO MARKET

IF you have any stones in the rough—except diamonds—to be cut, our new cutting works will enable us to fulfill your every wish. All work guaranteed. Best results attained. Try us.

### PASSMORE GEM COMPANY

LAPIDARIES, PRECIOUS STONES, ODD GEMS

373 Washington Street, Boston, Massachusetts



TRADE MARK.

## AZTEC TURQUOISES

Mines: MINERAL PARK, ARIZONA.



TRADE-MARK.

Of true CERULEAN BLUE, the rarest and most fashionable shade. Turquoises bearing Company's trade-mark are GUARANTEED. A new Turquoise will be given without question to replace any that discolors. The leading Jewelers of the World sell AZTEC TURQUOISES.

### THE AZTEC TURQUOISE COMPANY,

12-16 JOHN STREET, NEW YORK.

## Our Traveling Representatives

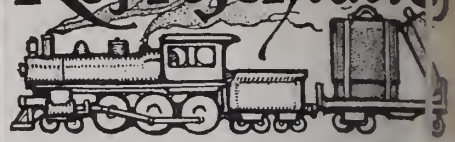

M. C. Winsor and R. B. Johnson will go the road for the new house of Perry-Aldrich Boston, Mass., this week.

The following traveling representatives called the trade in Kansas City, Mo., during the week: William Moore, Bausch & Lomb Optical Co.; W. F. Drexmit, Keystone Watch Case Co.

Among the traveling representatives who called on the trade in St. Louis, Mo., recently, were L. Smith, L. B. Bryant & Co.; Arthur H. I. Abel Bros. & Co.; M. B. Bernstein, Tuttle & Glass Co.

Among the traveling representatives who called on the trade in Lancaster, Pa., recently, were William D. H. A. Whaley & Co.; Mr. Wolf, W. Green & George B. Potter, E. J. Wilkins & Co.; Charles Montgomery, C. F. Rumpp & Sons; H. A. I. Rees & Yankauer; Max Gunzburger, Freeman.

Among the traveling representatives who called on the trade in Buffalo, N. Y., last week, were: James B. Frank M. Whiting & Co.; Mr. Fein, Henry & Co.; John M. Case, H. T. Carpenter & Charles E. Bride, Bride & Tinckler; M. L. Ward, Larler & Sons; J. T. Griffith, Jr., C. Howe & Co.

Traveling representatives who called on the trade in Cincinnati, O., during the past week, included: E. J. Mayer, Julius King Optical Co.; I. I. Louis Strasburger's Son & Co.; C. T. McKee, Kelly & Steinman; Alberto S. J. Schweizer, Sonia Clock Co.; Charles F. Sexton, William Sexton Co.; N. S. Benton, W. F. Upham.

Traveling salesmen visiting Boston, Mass., during the week, included: E. F. Skinner, Roy W. Case Co.; J. W. Sherwood, Solidarity Watch Co.; N. D. Moulds, New Haven Clock Co.; D. Childs, B. A. Ballou & Co.; Mr. Maria, M. Copeland & Co.; Ben Wymann; Fred Nichols, Allen; Louis Barrows, H. F. Barrows Co.; Dougherty, Providence Jewelry Co.; Mr. R. L. Tannenbaum & Co.

### The Great Gem Mine of Montana.

THE sapphire workings at Yogo Gem, Mont., are being gradually developed into a great and permanent mining industry. Taken as a whole, the Yogo dike is perhaps the greatest gem mine in the world. It is about four miles long on the surface, and being a true igneous dike descends to an indefinite depth. It is estimated that the entire contents of workable sapphire-bearing rock would approximate 10,000,000 cubic yards. A mining plant is now being erected here which will quadruple the previous output and make Montana sapphire mining a very important factor in American gem production.

The stones obtained are not of large size. They range from "culls," used for watch jewels and other mechanical purposes, to gems averaging, when cut, from half a carat to 2 or 3 carats and rising up to 5 or 6. As gems they are brilliant, free from flaws and of good color, ranging from light shades to the rich, deep blue of oriental sapphires. The Yogo crystals have an advantage for mechanical uses over East Indian stones in their shape, which are largely short prismatic or rhombohedral with flat basal terminations, hence they need much less cutting for mechanical purposes as watch jewels. The gems are sent to Amsterdam for cutting.

## Canada Notes.

R. McNaught, Seaforth, Ont., has sold.

J. Gundry, of C. J. Gundry & Co., Aylmer, Ont., died recently.

Henry Ratelle, Cornwall, Ont., has assigned to Daniel Davies.

The death is announced of Michael Murray, Montreal, brother of William Murray.

John Saunders, of H. & A. Saunders, Toronto, Ont., has returned from a European trip.

The American Jewelry & Novelty Co., Montreal, has dissolved, and Elias Auerbach has registered as proprietor.

J. H. Gmüther, Listowel, Ont., has removed to a fine new store fitted up in a seldom seen outside the cities.

William Wilson, 170 Queen St. W., Toronto, Ont., is selling off his stock preparatory to retiring from business.

Frederic J. Dingwall, of the D. R. Dingwall Ltd., is in the Winnipeg Hospital, Winnipeg, Man., suffering from appendicitis.

John H. McDougall, for having obtained money by false pretenses from David Spender, Montreal, has been sent to jail for one year.

E. C. Fitch, Jr., manager of the Robbins Appleton Co., Montreal, was in Toronto and Hamilton last week in the interests of the firm.

W. G. Kent, manager of the Toronto Jewelry Mfg. Co., Toronto, Ont., left, June 20, on a purchasing trip to New York and the western jewelry centres.

Frederick Whitehead, for many years with E. M. Murphy, Sons & Co., Toronto, Ont., has opened a jewelry store at 344 George St., recently vacated by Ellis Bros.

A fire occurred at Windsor, June 18, by which a number of stores sustained considerable damage, principally by water, among them being Abel Ashley, whose loss is \$1,000, and Bradley Bros. The latter's loss was small.

Out-of-town buyers calling on the Toronto, Ont., trade last week, included: T. Watson, Newmarket, Ont.; N. F. Babb, Stratford, Ont.; W. W. Ferguson, Niagara, Ont.; E. Smith, Oakville, Ont., and P. Birtwistle, London, Ont.

The staff of Ryrie Bros., Ltd., Toronto, Ont., had a very enjoyable picnic at Toronto Island last Thursday evening, at which about 150 were present. A sumptuous rest was served, and boating, games, foot races and other diversions made up the evening's entertainment.

D. R. Dingwall, of the D. R. Dingwall Co., Ltd., Winnipeg, Man., accompanied by his wife and daughter, returned last week from a protracted European trip. During the course of his travels he visited Rome and had an audience with the Pope. He notes an increasing scarcity of diamonds, as the output of the South African and other sources of supply is diminishing, while the demand from America is steadily on the increase.

William T. Ferguson and Maud Courtney, of St. John, N. B., and A. W. Leroux, Montreal, were arrested recently at Hamilton, Ont., on a charge of shoplifting. The three went into Robert Juner's store and asked to be shown some cut glass, but did not make a purchase. After they left Mr. Juner missed a cut-glass bowl valued at

\$12. He notified the police, the alleged thieves were arrested, and the property was recovered.

Hormidas Spenard, who pleaded guilty to being concerned with another in the theft of diamond rings from the store of Narcisse Beaudry & Sons, Montreal, has been sentenced to three months' imprisonment. He fled from justice, but returned and gave himself up, and his sentence was made light in consequence.

Harry Ryrie, of Ryrie Bros., Ltd., Toronto, Ont., returned home last week from a four months' purchasing tour in Europe, having placed large orders, especially for diamonds and pearls. He reports that fine goods have a marked upward tendency, which is especially noticeable in regard to pearls. Rubies continue to command high prices, the market for really fine goods not being affected by the manufacture of "scientific rubies."

## Rochester.

Philip Present is spending the week in New York.

Judgment was obtained by default, last week, in the Municipal Court by Don. I. Danks against Edward Keating for \$7.

Among the out-of-town jewelers visiting Rochester last week were: Mrs. G. A. Taylorson, St. Mary's, Pa.; F. E. Taylor, Bolivar, N. Y.; Charles Peck, Naples, N. Y., and G. D. Macomber, Honeoye Falls, N. Y.

The Rochester Optical Society, at a special meeting, last week, passed the following resolution on the death of the late Charles F. Kern:

*Whereas*, It has pleased the Divine Providence to take from us our friend and brother, Charles F. Kern, be it

*Resolved*, We, the members of the Rochester Optical Society, hereby express our profound sympathy to the members of his family in their sad bereavement, and the secretary has been instructed to send them a copy of this resolution and to have the same spread upon the minutes of this society.

H. M. BESTOR, President.  
C. I. SUMERISKI, Secretary.

The Sigler Bros. Co., Cleveland, O., recently received a letter from L. M. Sigler, which contained some interesting information in regard to the situation in the diamond trade in Europe at the present time. The letter was dated from London, which Mr. Sigler was then visiting after an absence of 15 years, having gone there from Antwerp and Amsterdam. The writer expressed extreme surprise at the decided scarcity of rough diamonds, it being almost impossible for an outsider to get a "sight" from the syndicate, and even the regular customers being only able to get it by making an appointment many weeks and sometimes months ahead. The cutters have to almost beg to get the rough that they want, and all rough is sold for cash only. The receipts from the South African mines were 10 per cent. less in the week in which Mr. Sigler wrote than a year ago. The Premier mine, which has not been producing much, owing to an accident in the machinery, is reported to be working again. The Jaegersfontein mine, which was flooded during the Boer war, has been pumped out and is again producing its famous blue stones.

## Buffalo, N. Y.

A. J. Best, of Best & Co., with his wife, is preparing for a long sojourn in Europe.

R. F. Pickert, manager of the Freeman Jewelry Co.'s store at 84 Seneca St., spent a portion of last week in his old home at London, Ont.

J. H. Ullenbruch, 510 Main St., had in place last week for the first time an immense electric sign. It is unique in design and the only thing of the kind in Buffalo.

Miss Fanny Kirschner, sister of Henry Kirschner, 59 E. Genesee St., goes to New York next week to spend her vacation term with friends. Miss Kirschner assists her brother in conducting the store here.

Frank Sutherland, who recently started a jewelry store at 125 Broadway, was married Thursday to Mrs. Leona Mann. Mr. Sutherland is arranging for the sale of his business here. He will go to Lakeville, N. C.

John W. Schler, for years jewelry engraver in rooms above 379 Main St., has purchased the Plarr plant in Niagara St., and will begin the extensive manufacture of jewelry in a newly fitted-up establishment at 178-80 Ellicott St.

C. B. Henschel, traveling representative for Heintz Bros., wholesale dealers at Swan and Ellicott Sts., has returned from a vacation trip to San Francisco. Mr. Henschel was formerly of Henschel & Frank, who sold out to Philip Present several months ago.

Local jewelers are disappointed in that the convention of the Knights of St. John failed to increase their sales to the extent predicted. The Knights brought 10,000 persons to the city, but the big parade took place on Monday, and a majority of the visitors departed for side trips.

Charles F. Damm, 520 Main St., has a unique advertising scheme in the shape of a rolled one-cent piece. On one side is a picture of Mr. Damm's store building; on the other the elongated Indian head and inscription. Mr. Damm is sending these out to his customers. He has added a number of new fixtures to his salesroom.

Joseph Block, president of the Citizens' National Bank, was, 20 years ago, one of the leading jobbers of jewelry in this city and western New York. He quit the jewelry trade to become a banker, and has been very successful. Last Wednesday Mr. Block, who is nearly 70 years old, was married to Mrs. Leiter, of Cleveland, O.

Harry Roberts was arrested by police detectives last Thursday in Michigan St. as a suspicious person. Roberts, the police say, is one of the best known jewelry thieves in the country. He had in his possession a purse containing 15 pieces of jewelry, including a sapphire ring worth \$50, a cluster scarf pin containing 15 diamonds, several diamond-set lockets and rings, and a gold bracelet of fine workmanship. Roberts admitted the jewelry he had with him was worth \$1,200 at wholesale prices. Buffalo jewelers have been asked to inspect the booty to ascertain if any of it belongs to them.

John E. Judge, Ames, Ia., recently sold his store to C. E. Edwards, Watertown, S. Dak., who has sold out to John Keating.

**I** make a specialty of purchasing for cash, jewelry and all kinds of precious stones which your customers desire to dispose of and which you do not wish to buy yourself.

Entire Stocks and Estates Bought. Bank References Given.

The Finest Collection of American Pearls in Stock.

# MAURICE BROWER

Headquarters for American Pearls

Telephone, 6233 Cortlandt

12-16 JOHN STREET, NEW YORK

SEND TO US ANY QUANTITY OF

## AMERICAN PEARLS

WE BUY FOR CASH.

Send by registered mail or express; we will make an offer by return mail. We will also buy any quantity of

**BAROQUE PEARLS (SLUGS).**

**BUNDE & UPMAYER CO.,**

Mack Block,

MILWAUKEE, WIS.

**Connecticut.**

The Bradley & Hubbard Mfg. Co.'s plant, Meriden, will shut down for one day only—day, July 4.

The International Silver Co. recently presented 1,000 flags to the Meriden Boys' Club, in Meriden.

C. B. Sanford, general manager of the Sessions Clock Co., Forestville, has moved on Bristol to Forestville with his family. M. B. Leete recently assigned a patent for a design for a teapot or similar article to the R. Wallace & Sons Mfg. Co., Wallingford.

Edward Ingraham, son of Wm. S. Ingraham, Bristol, was in New York last week taking his final examination for entrance to the next Fall.

W. E. Porter assigned a patent which was recently granted to him on an intermittent alarm clock, to the New Haven Clock Co., New Haven.

Col. C. H. Case, Hartford, attended the wedding of his nephew, Harold Case, in Meriden, Thursday. The groom's father is superintendent of the Gilbert House, in Meriden.

The New Haven Clock Co., New Haven, closed its factory June 30 for the semi-annual shut-down, and will remain closed until July 16. Repairs will be made and inventory taken.

The Sessions Clock Co., Forestville, has led down the brick storehouse that stood on the side of the old shop, and will use the bricks in the construction of a new storehouse, which is being erected.

W. W. Bigelow, for several years in the employ of Edward Miller & Co.'s factory, Meriden, died at that place Thursday, aged 67 years. The deceased was a member of the 25th Massachusetts Volunteers.

The fourth annual outing of the R. Wallace & Sons Mfg. Co.'s fire brigade was held at Mansfield Grove, Saturday. There were six events and the winner of each was awarded with a handsome silver trophy.

A clock is owned by H. J. Pulver, Lee, Mass., which is claimed to be at least 160 years old. It was made in Winchester, here in the latter part of the 18th century several clockmakers were located. The iron weights on the timepiece weigh 20 pounds.

Frederick H. Mann, for several years manager of the Parker Clock Co., Meriden, died last week of a complication of diseases at Dr. Johnson's Sanitarium in Hartford, after a long illness. The deceased is survived by a widow and two children. The interment was in Jefferson.

The New England Watch Co., of Watertown, has presented a petition to the city requesting that a sidewalk be constructed on the north side of Dover St., and that the street be paved from S. Main St. to the city. It also asks for the paving of Benedict St. and the north side of Clay St. to Liberty St.

Chas. F. Harwood, a well-known resident of Wallingford, and for a quarter of a century foreman of the plating department of Simpson, Hall, Miller & Co., died on Thursday morning, at his home, 200 Center St., of Bright's disease, aged 73 years. Mr. Harwood is survived by a widow and two daughters. The deceased served in the

Civil War, having been second lieutenant of Company A, in the 15th Connecticut Volunteers.

A. H. Hall & Co., Meriden, a partnership comprising A. J. Hall and J. D. Bergen, will soon be merged into a stock company, a meeting of prospective stockholders having been held recently. The concern, which manufactures decorated glass, was started in 1899 by Arthur J. Hall, who had small quarters in Mill St. The business outgrew its old quarters, and a transfer was made to the present factory on N. George St., in 1902.

Factory "A," International Silver Co., Meriden, closed Saturday and will remain so until July 9. Factory "E" closed for a week beginning July 1. Factory "H" ceased operations June 30, and will reopen July 9. Factory "N" will close for two weeks beginning July 30. The J. D. Bergen Co. is closed for one week; also the plant of Manning, Bowman & Co. for the same length of time. Extensive improvements will be made in several of the above mentioned factories during the shut-down.

John Ralston, who was arrested a short time ago on a charge of larceny preferred against him by the Davis & Hawley Co., Bridgeport, and who was subsequently released under bonds of \$300 after having reimbursed the concern, is believed to be the same man who is wanted in California under the name of John Webb. Webb was arrested in California some time ago on a criminal charge, and held in \$1,000 bail, which was put up by wealthy friends. Webb, however, disappeared, and the sheriff of San Bernardino County is endeavoring to recapture him.

The midsummer shut-down of Wallingford factories will be brief this season, which indicates the general busy and prosperous condition of local manufacturing concerns. Factory "L," International Silver Co., closed Saturday, and will reopen July 9. This is the shortest shut-down for this factory in a number of years at this season. The H. L. Judd Co. closed at the same time, and will also resume operations July 9. R. Wallace & Sons Mfg. Co.'s plant closed Saturday. The duration of the midsummer vacations at this company's factory will vary. Some departments will be closed one week, while others will be closed from 10 days to two weeks.

**Jewelers' Gold Bars Withdrawn and Exchanged at New York.**

Week Ended June 30, 1906.

The U. S. Assay Office reports:

Gold bars exchanged for gold coin.....	\$289,729.43
Gold bars paid depositors.....	63,935.43
Total .....	\$353,664.86

Of this the gold bars exchanged for gold coin are reported as follows:

June 25.....	\$51,559.59
" 26.....	51,898.72
" 27.....	47,561.70
" 28.....	97,656.88
" 29.....	20,495.40
" 30.....	20,557.14
Total .....	\$289,729.43

Andrew Wilson, Winfield, Kans., is recovering from a severe illness.

Obed Lyon, Brockton, Mass., recently erected a new Summer residence on the shore of Buzzard's Bay, Mass.

**Attleboro.**

E. A. Reed, of the traveling force of Reed & Barton, will spend the Summer roughing it on a New Hampshire farm.

Loring Everett Ladd, Mansfield, with J. F. Sturdy & Sons Co., was last week united in marriage to Miss Maud A. Eddy, Attleboro.

The progress on the cement and steel factory going up for the D. F. Briggs Co. gives promise that it will be completed by September.

The James E. Blake Co. and the W. H. Wilmarth Co. last week provided their employes with free tickets to a clam bake, a feature of the "Society Circus," which was Attleboro's main source of interest all last week.

Hon. Sidney O. Bigney, of S. O. Bigney & Co., conducted through his big factory last week an official party, comprising fellow members of the Governor's Executive Council, prominent military men from various parts of the State, and political and personal friends. Among the party was J. C. Sawyer, Boston. After the inspection of the plant and the presentation of handsome jewelry souvenirs to the guests a sumptuous repast followed at Col. Bigney's house.

John M. Fisher, of J. M. Fisher & Co., was last week elected to membership on the State central committee of the Prohibition party. Mr. Fisher was some years ago its candidate for governor. The Prohibitionists of Attleboro are reported to favor Charles E. Bliss, recently retired from Bliss Bros., for representative to the Legislature. He is now one of the aspirants for the Republican nomination.

**North Attleboro.**

**TRADE CONDITIONS.**

Business continues to hold out exceptionally well and quite a number of the factories are now compelled to work nights in order to fill the rush orders. There is an unusually brisk demand for experienced help.

Arthur Coddington is spending the Summer at Lake Archer, Wrentham.

W. S. Metcalf, of the Plainville Stock Co., returned last week from the west.

George K. Webster and family will spend the Summer months at Matunuck.

Horace L. Kent, for over 25 years an employe of the T. I. Smith Co., died Wednesday of last week in his 73d year. He observed, last April, his golden wedding anniversary. The funeral was held on Friday afternoon.

Word was received last week of the death in Indianapolis, Ind., of Charles S. Joslin, who for many years conducted the jewelry supply houses that George L. Clafin Co. maintains in North Attleboro and Attleboro. Mr. Joslin has been ill for many years with throat trouble, and this is what caused his death. He is survived by a son.

Harry Norteman, head colorer for J. J. Sommer & Co., was seriously injured Thursday. He was doing some satin finishing when a wire from the brush flew and struck him squarely in the ball of his left eye. The services of an eye specialist in Boston were called in, but there is still some fear that he may lose the sight of the eye.

# GORHAM SILVER

## SILVER-MOUNTED LEATHER BLACK-JACKS.

¶ The Gorham Company takes pleasure in suggesting to the Jewelry Trade that in its extensive assortment of old English Black-jacks (an exclusive Gorham product) will be found many pieces which cannot fail to appeal to sports committees and others as especially well adapted for presentation as prizes in Athletic and Sporting Contests.

¶ The Beakers, Mugs, Ale Sets and Loving Cups of solid hand-sewn leather, lined with ruddy copper, the rims and shields of Gorham Silver, are now universally accepted as offering an effective equivalent for solid silver at an exceedingly moderate cost.

## THE GORHAM COMPANY,



CHICAGO,  
137 Wabash Ave.

### Silversmiths and Goldsmiths

Fifth Avenue and 36th Street, New York.

#### BRANCHES:

NEW YORK,  
23 Maiden Lane.

SAN FRANCISCO,  
120 Sutter St.

LONDON,  
Ely Place.



WORKS: Providence and New York.



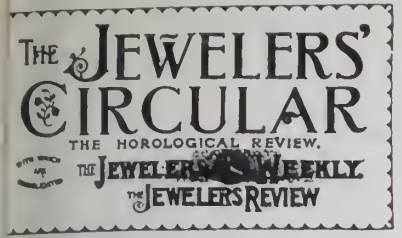

PUBLISHED EVERY WEDNESDAY BY THE JEWELERS' CIRCULAR PUB'G CO., 11 JOHN ST. COR BROADWAY, NEW YORK...

VOL. LII JULY 4, 1906. No. 22.

Description in U. S., Canada and Mexico, \$2.00; Foreign Countries in Postal Union, \$5.00; Single Copies, .10.

Notices of changes in standing advertisements to be received one week in advance; new matter can be received up to Monday.

No attention paid to communications unless accompanied by full name and address of the writer.

Index to Special Articles.

Table with 2 columns: Article Title and Page. Includes 'Handsome Silver Gilt Automobile Trophy', 'Diamond Markets', 'Death of Alfred E. Seliger', etc.

A Record in Gem Importations. WHILE the importations of precious stones and pearls have been increasing by leaps and bounds in the last two years...

The nearest approach to the splendid total of the fiscal year now closed was made by the figures for the calendar year ended Dec 31 last...

Comparisons with preceding fiscal years will indicate the extent of the increase in the consumption of precious stones by the American dealers.

Organization Going On in the Jewelry Trade.

THIS month may truly be considered the season of conventions among the jewelers in all parts of the Union...

In some States—and among these may be reckoned one or two of the greatest in population and importance—there does not seem to be an interest taken in the State association which is commensurate with the importance of the project.

The States which already have organizations, some of which have been in existence from one to a dozen years, will, of course,

be represented by delegates which have behind them an organization which properly authorizes them to speak for the jewelry trade of their territory...

The time before the dates set for the various State meetings is short, and every jeweler interested in the subject of organizing a State or national association should give heed to the calls which have been sent out for these meetings...

Resolution of Manufacturing Jewelers' Association of Newark, N. J., Thanking the Circular-Weekly.

NEWARK, N. J., June 28, 1906.

Editor THE JEWELERS' CIRCULAR-WEEKLY:

At a meeting of the board of managers of the Manufacturing Jewelers' Association of Newark, N. J., held June 25, announcement was made that the bill introduced by Representative Vreeland...

This law will no doubt be of great benefit to the trade and public at large.

Yours respectfully, HARRY DURAND, Secretary.

Death of Reginald D. Fogg.

ATTLEBORO, Mass., June 30.—Reginald D. Fogg, traveling salesman for the Watson & Newell Co., died Friday from spotted fever.

Mr. Fogg reached Attleboro suffering severely. His case was quickly diagnosed and there followed interminable weeks of exhausting fever...

Deceased leaves besides his mother a younger brother and hosts of friends in jewelry, social, athletic and Y. M. C. A. circles.

# WEDDINGS



**SOMETIMES,**  
all of a sudden, you  
find you have to meet an  
extraordinary demand  
—a wedding or something of  
that sort—for

**Diamond Jewelry and Diamonds.**

*That's the time to write us!*

*Give us an idea of range of prices and you'll get the  
richest assortment to be had in New York City.*

## CROSS & BEGUELIN

*Importers and Cutters of Diamonds and Precious Stones*

43 Rue de Meslay, PARIS Telephone, 2188 Cortlandt 17 Maiden Lane, NEW YORK

### Last Week's New York Arrival:

**THE CIRCULAR-WEEKLY** each day posts its office a bulletin of the latest buyers visiting New York, which every member of the trade cordially invited to copy.

- ALBANY, N. Y., M. Levitz, Astor House.  
O. A. Quayle, Cumberland.  
S. Miller (L. Miller & Bro.), Grand Union.
- BALTIMORE, MD., W. F. Jacobi (Jacobi & Jenkins), Woodstock.  
H. C. Kirk (Samuel Kirk & Son Co.), Seville  
M. Oppenheimer (Oppenheimer, Koshland Co.), Imperial.
- BOSTON, MASS., H. Hilliard (Jordan Mar Co.), 8 Greene St.  
A. W. Rounds, Marlboro.  
T. Stewart (Shepard Norwell Co.), Herald  
W. I. Wood (R. H. Stearns & Co.), Impetia
- BRIDGEPORT, CONN., J. C. Mizer (Howland Dry Goods Co.), 75 Spring St.
- CHICAGO, F. Purdy (J. H. Purdy & Co.), Gra Union.
- CLEVELAND, O., O. L. Mason (Williams & Rogers Co.), Grand.
- EASTON, PA., W. Bixler (C. W. Bixler & Co.), Imperial.
- GLENS FALLS, N. Y., H. E. Floyd, Grand.
- HAVANA, CUBA, M. Heymann (Heymann B & Co.), 43 Leonard St.
- MERIDEN, CONN., J. J. Killeen (A. S. Thoma Normandie).
- MIAMI, FLA., H. T. Whaler, Sinclair.
- NORFOLK, VA., C. W. Barrett (Miller, Rhoads & Swartz), York.
- NORFOLK, VA., F. J. Stanley (Porteous & Mitchell), New Amsterdam.
- OMAHA, NEBR., H. J. Penfold (H. J. Penfold Co.), Holland.
- PITTSBURG, PA., L. J. Marks, Herald Sq.  
W. Rosenbaum (Rosenbaum Co.), Netherland
- ROCHESTER, N. Y., J. Kopelovich, Astor House
- SALEM, MASS., W. T. Grant (Almy, Bigelow Washburn), 2 Walker St.
- SALT LAKE CITY, UTAH, S. E. Park (B. Park Jewelry Co.), Park Ave.
- SAN FRANCISCO, CAL., Mrs. K. Mulla (K. Mulla Bros. Co.), Albert.
- ST. LOUIS, MO., D. G. Braham (Stix, Baer Fuller Co.), Wellington.
- WASHINGTON, D. C., E. W. Everett (Woodward & Lothrop), Broztell.

### Importations at the Port of New York

*Weeks Ended June 30, 1905, and June 29, 1906*

China, Glass and Earthen Ware:	1905.	1906.
China .....	\$80,687	\$74,000
Earthen ware .....	9,766	19,000
Glass ware .....	22,018	25,000
Optical glass .....	4,906	1,000
Instruments:		
Musical .....	12,487	20,000
Optical .....	5,689	9,000
Philosophical .....	1,573	2,000
Jewelry, etc.:		
Jewelry .....	5,998	4,000
Precious stones .....	684,906	988,000
Watches .....	53,135	46,000
Metals, etc.:		
Bronzes .....	261	0
Cutlery .....	26,874	30,000
Dutch metal .....	2,946	3,000
Platina .....	20,539	55,000
Plated ware .....	1,000	0
Silverware .....	1,000	19,000
Miscellaneous:		
Alabaster ornaments .....	806	0
Amber .....	5,835	6,000
Beads .....	3,912	3,000
Clocks .....	2,255	0
Fans .....	4,080	4,000
Fancy goods .....	7,218	9,000
Ivory .....	944	21,000
Ivory, manufactures of .....	623	0
Marble, manufactures of .....	4,367	9,000
Statuary .....	1,000	4,000

## The Arch Crown Mounting



*Your Fall stock of diamonds  
will appear whitest and bright-  
est if set in Arch Crown Mount-  
ings.*



¶ The open arch design admits the light freely to all sides of the stone, and light is the life of a diamond.

¶ Platinum lined Arch Crown Mountings are especially good for stock.

¶ Send for a single mounting, set a stone in it, and if you don't agree with us, take it out and send the mounting back.

*The Only Mounting Ready to Set*

## Arch Crown Mfg. Co., 26 Camp Street, Newark, N. J.

Cross & Beguelin, New York.  
Kossuth Marx Jewelry Co., New York.  
Jos. Noterman & Co., Cincinnati.  
Schuader Wittstein Co., Chicago.

Chas. Wathen & Co., Denver.  
Eisenstadt Mfg. Co., St. Louis.  
Leonard Krower, New Orleans.  
M. Schussler & Co., Oakland, Cal.

W. B. Sherratt has retired from business at Lake Park, Ia., and will engage in business at Humboldt, Ia.

**New York Notes.**

I. Sluizer has engaged in the diamond business at 87 Nassau St.  
 Hugo Glaser is no longer connected with Louis L. Grey & Co., 71 Nassau St.  
 Henry W. Sowade has taken a position with Adolf J. Grinberg & Son, 8 Maiden Lane.  
 Simon Merker, who was in business under the style of Mrs. Minnie Merker at 102 Madison St., has closed the store.  
 I. Z. Oppenheimer, of H. Z. & H. Oppenheimer, went last week to Maine, where he intends to pass several weeks in fishing.  
 A. J. Grinberg, of A. J. Grinberg & Son, with his daughter, sailed recently on *La Savoie* for a two months' tour of Europe.  
 Miss Elizabeth Marshall, who completed her course in art at Pratt Institute in Brooklyn last month, has secured a position with Tiffany & Co.  
 Reed & Barton are advertising a reward of \$50 for the return of a filigree gold necklace mounted with precious stones, which was lost by a customer.  
 I. R. Conklin, of Cross & Beguelin, is returning July at Warwick, Orange County, N. Y.  
 J. G. Townly, of the same house, is using his vacation in the Pocono Mountains.  
 L. Tannenbaum, of L. Tannenbaum & Co., 52 Nassau St., accompanied by his wife and daughter, sailed recently on the *Kaiser Wilhelm der Grosse* for a two to three months' trip abroad.  
 William M. Green, late of M. J. Dunn & Co., will remain at the old stand, 11 Maiden Lane, room 1206, as representative of George L. Brown Co., Attleboro, Mass., makers of rolled plate chains.  
 Mrs. George F. Kunz, whose husband is a member of Tiffany & Co., last week lost a diamond-studded gold belt while on her way to a church dedication in Chappaqua, N. Y. The belt was subsequently found and returned.  
 Thomas Koch, who recently moved from the second floor to the third floor front of the Persch building, 37 Maiden Lane, has fitted up his new offices, in which he is now comfortably established, with double the floor space that he formerly had.  
 A certificate of incorporation was filed last day by the International Gem Co., of New York, which is to conduct business with a capital of \$3,000, the directors being A. Dwyer, Brooklyn; D. I. Dreher, New York; Henri Casenobe, Englewood, N. J.; John A. Abel, of Abel Bros. Co., 64 John St., sailed for Europe last Thursday on the *Deutschland*. Mr. Abel will visit Germany, Austria, Bohemia, France, Holland, Belgium and England in search of precious stones and designs, and to get ideas to be used in the coming season's productions.  
 Oliver M. Hamrick, formerly the manager of a jewelry store, pleaded guilty in the early part of last week to the charge of abduction and paid a fine of \$365. The complaint dates back to 1901. He was indicted in 1902 and thereafter his bail bond of \$2,000 was forfeited by his failure to appear for trial.  
 The International Pearl Co. is the name of a new corporation which filed a certificate last week. It is authorized to deal in pearls and precious stones, with a

capital of \$400,000. The incorporators named are: John Bradfute Knox and Frank C. Robertson, 96 Broadway; Jacob Burnet, 50 E. 77th St., New York.

A decision of the Board of United States General Appraisers handed down last week sustained in part a protest of Samstag & Hilder Bros. against an assessment of duty on an importation of metal belts and ornaments of various kinds. The Board divides the article into a number of classes, sustaining the protest as to some and agreeing with the collector as to others.

Eph. A. Karelson, who appears as counsel in various proceedings in which the jewelry trade is interested, was married yesterday to Mrs. Bianca E. Duclose at the residence of the bride's mother, Mrs. Pauline Elsasser, 1030 Lexington Ave., by Justice James A. Blanchard. Mr. and Mrs. Karelson will sail to-morrow on the *Friederich der Grosse* for a three months' trip to Europe.

A new concern, which will offer art glass products to the jewelry trade, has recently engaged in business, at 87 Maiden Lane, under the style of the Tivoli Art Glass Co. The company shares offices with L. Adler & Son, jewelry manufacturers, who are interested in the enterprise. The factory for the production of the glass has been established at Maspeth, and the company has secured the services of George Cook, formerly with the Tiffany Studios. The samples shown in the salesrooms include a wide variety of vases fashioned in conventional and eccentric shapes. The glass comes in antique and iridescent and opalescent hues and the decorations are worked in the material at the time of blowing by chemical processes.

Answers were filed last Friday in the Court of Chancery at Trenton, N. J., in suits instituted several months ago against the International Silver Co. and others by Edward R. Thomas, a banker of New York. The issues have been pending in one form or another for several years. Mr. Thomas, who is one of the leading promoters of the silver company, charges that certain defendants engaged in a plan of transferring stock for the purpose of perpetuating the present management. The answer denies that the transfers of stock were in any respect improper, and say that Mr. Thomas for several years has been trying to start a contest in the hope of forcing out the present directors in order that he might get control for speculative and stock jobbing purposes. At the last annual meeting about 45,000 shares of stock were voted by the present management and 4,300 were voted by opposition. Those named by Mr. Thomas as engaging in the transfers of stock include William E. Noore, Benjamin J. Hill, the Hackensack Trust Co., Home National Bank of Meriden, First National Bank of Meriden, the National City Bank of New York.

**Market Price of Silver Bars.**

The following are the quotations of silver bars in London and New York, as reported by Zimmerman & Forshay:

June 26	.....	\$.65	30 1-16d.
" 27	.....	.65	30 1-16d.
" 28	.....	.65 1/4	30 3-16d.
" 29	.....	.65 1/4	30 3-16d.
" 30	.....	.65 1/4	30 3-16d.
July 2	.....	.65 1/4	30 3-16d.

**Trans-Atlantic Voyagers.**

TO EUROPE.

P. C. Gillespie, of Gillespie Bros., Pittsburgh, Pa., will sail July 16.  
 Edward Alberti, Chicago, will sail July 10 on the *Kaiser Wilhelm der Grosse*.  
 Henry H. Schaul and Harry May, of Schaul & May, Atlanta, Ga., sailed recently.  
 Samuel Kind, of S. Kind & Sons, Philadelphia, Pa., sailed last week on the *Bremen*.  
 Leon J. Van Gelder, of Van Gelder, Kahn & Co., New York, sailed recently on the *Finland*.  
 A. J. Grinberg, of A. J. Grinberg & Son, New York, accompanied by his daughter, sailed recently on *La Savoie*.  
 A. J. G. Hodenpyl, New York, sailed last Wednesday on the *Noordam*. On the same boat was A. Hess, Chicago, Ill.  
 L. Tannenbaum, of L. Tannenbaum & Co., New York, with his wife and daughter, sailed recently on the *Kaiser Wilhelm der Grosse*.

Sailing on the *Deutschland* recently were John A. Abel, of Abel Bros. & Co., and N. A. Moore, Jr., of Alfred H. Smith & Co., New York.

Sailing recently on the *Kaiserin Augusta Victoria* were: W. S. Manheimer, of Louis Manheimer & Bro., Chicago, and R. E. Schubart, Wheeling, W. Va.

Leopold H. Herzfelder, with David Mayer, New York, and Henry C. Bergheimer, manager of Galt & Bro., Washington, D.C., sailed Saturday on the *St. Louis*.

Albert H. Gleason, of Hastings & Gleason, attorneys for the Jewelers Board of Trade, New York, sailed last Thursday on *La Provence*, as did also M. H. Berg, of Hyman, Berg & Co., Chicago.

FROM EUROPE.

L. H. Keller, of the Keller Jewelry Co., New York, arrived Friday on the *Baltic*.

H. Thompson Whaler, Miami, Fla., and Narragansett Pier, R. I., returned recently on the *St. Louis*.

B. Hyman, of Hirsh & Hyman, New York, will return this week on the *Kaiser Wilhelm der Grosse*.

Returning last Saturday on the *St. Louis* were Max Ellbogen, of the Stein & Ellbogen Co., Chicago, and Jules Franklin, New York.

Alfred G. Stein, of Patek, Philippe & Co., New York, arrived June 23 on *La Provence*, as did Harry C. Adler, of Charles Adler's Sons, New York.

**Death of Delos R. Brown.**

Word of the death at his home in Peoria, Ill., Sunday, of Delos R. Brown, reached New York Monday in a telegram to M. B. Bryant, of M. B. Bryant & Co.

Many of the older members of the trade will learn of his death with deep regret. Mr. Brown was born in Cummington, Mass., 66 years ago, and was for several years in business as a jeweler at Elmwood, Ill. Of late years he has lived at Peoria, where he had many interests. A genial, generous man, his death will grieve a large circle of friends in Massachusetts as well as at his last place of residence. He is survived by a widow, two sons and a married daughter.

IN THE HEART OF THE JEWELRY DISTRICT.

**Guardian Trust Company,**

170 BROADWAY, COR. MAIDEN LANE, NEW YORK.

**Capital and Surplus - Over \$1,000,000**

Equitable rates of interest allowed on surplus funds.

Collection of out-of-town items made on reciprocal basis.

FRANK W. WOOLWORTH, President.  
GEORGE W. FAIRCHILD, Vice-President.  
CHARLES L. ROBINSON, Vice-President.LATHROP C. HAYNES, Secretary.  
ALFRED M. BARRETT, Asst. Sec'y.Prominent Jewelers }  
Among our Directors } LUDWIG NISSEN.  
A. K. SLOAN.  
LEOPOLD STERN.**THE ORIENTAL BANK.**

ESTABLISHED 1853.

**182 and 184 Broadway, <sup>Corner</sup> JOHN STREET, NEW YORK.****Capital, - - - \$750,000.00.****Surplus and Profits, 1,100,000.00.****ACCOUNTS FROM THE JEWELRY TRADE ARE SOLICITED.**R. W. JONES, Jr., President.  
NELSON G. AYRES, First Vice-President.  
GEO. W. ADAMS, CashierLUDWIG NISSEN,  
ERSKINE HEWITT, } Vice-Presidents.  
CHARLES J. DAY, }

R. B. ESTERBROOK, Assistant Cashier.

**The Market and Fulton National Bank of New York.**

ORGANIZED 1852

81-83 FULTON STREET.

**Capital, \$1,000,000.****Surplus, \$1,335,000.**ALEXANDER GILBERT, President.  
R. A. PARKER - - Vice-President.  
T. J. STEVENS, - - - Cashier.  
JOHN H. CARR, - Asst. Cashier.**Invites the Accounts of Jewelers.****Will extend every facility that good banking will justify.****SAFE DEPOSIT VAULTS.****The Chatham National Bank**

Broadway and John Street, New York

H. P. DOREMUS, Cashier

GEORGE M. HARD, President

W. H. STRAWN, Ass't Cashier

**THE STATE BANK**

376-378 GRAND STREET, NEW YORK

**Capital and Earned Surplus, over \$1,100,000. Deposits over Fourteen Million.****Offers a favorable market for short and long time jewelry and diamond paper**

# The Mercantile National Bank of the City of New York

*Cordially invites Accounts  
from Good Merchants  
in the Jewelry Trade.*

**CONVENIENT LOCATION,  
AMPLE CAPITAL,  
LARGE SURPLUS,  
LONG EXPERIENCE.**

*FREDERICK B. SCHENCK, President.*

*MILES M. O'BRIEN, }  
WILLIAM H. TAYLOR, } Vice Presidents.*

*JAMES V. LOTT, Cashier,  
EMIL KLEIN, Asst. Cashier,  
ALFRED W. DAY, Asst. Cashier.*

<i>Capital,</i>	<i>.</i>	<i>.</i>	<i>.</i>	<i>\$3,000,000</i>
<i>Surplus,</i>	<i>.</i>	<i>.</i>	<i>.</i>	<i>\$3,000,000</i>

*Broadway, Corner of Dey Street,  
New York.*

# LATEST JEWELRY FOR SUMMER

CORRECT STYLES — SUPERIOR FINISH  
ARTISTIC DESIGNS

Embodied in Our

BRACELETS  
BACK COMBS  
LOCKETS

BUCKLES  
NECK CHAINS  
BROOCHES, Etc.

## DIAMONDS

Full Assortments in the Various  
Grades and Sizes

We strictly refuse to sell at retail, thus eliminating every  
element of possible competition with our customers

**D. C. PERCIVAL & CO., Inc.** 373 Washington Street  
BOSTON, MASS.

IMPORTERS OF DIAMONDS

MANUFACTURERS AND JOBBERS OF WATCHES, SILVERWARE  
CUT GLASS, ETC. COMPLETE MATERIAL DEPARTMENT

**T**HE continued scarcity of fine Pearls is the conspicuous feature of the day in  
European markets.

It not only takes days of hunting, but oftentimes weeks, before one can  
find what he actually needs.

American buyers are therefore quite ready to appreciate the value of the  
co-operation of a "GEMFINDER" always on the spot.

A word in advance of your coming to Europe and an idea of your wants  
would insure the possibility of securing the desired goods and save time.

FREDERICK A. JEANNE,  
"Gemfinder,"

5, Square de l'Opéra, PARIS, FRANCE.

London: Chancery Lane Safe Deposits. New York: Maiden Lane Safe Deposit Co.

### WORKSHOP NOTES

(Third Edition)

For Jewelers and Watchmakers.

A collection of  
the latest  
practical  
receipts on  
the manu-  
facture and  
repairing of  
watches,  
clocks and  
jewelry.

Price,  
**\$2.50**

300 pages  
(size 7½x  
10¼ inches),  
bound in  
cloth, stiff  
covers.  
Should be  
on every  
workbench.

Published by

THE JEWELERS' CIRCULAR  
PUBLISHING CO.,

11 John St., Cor. Broadway, New York.

**TRADE-MARKS** OF THE JEWELRY AND KINDRED TRADES.  
Over 4,000 Marks. Second Edition. Price, \$3.00  
The Jewelers' Circular Pub. Co., 11 John St., N. Y.

## MEYEROWITZ BROS.,

### IMPORTERS OF DIAMONDS,

37-39 MAIDEN LANE,  
NEW YORK CITY

A Complete Line of Precious, Semi-Precious and Imitation Stones. Mail orders promptly attended to.

London, 1, C. Holborn Viaduct 17.  
G. MARCUS.

ESTABLISHED 1860.  
L. O. LEVISON.

Amsterdam, Tulpstraat  
ALEX. FELDENHEIMER.

**CALIFORNIA JEWELRY COMPANY**  
Importers of  
**DIAMONDS and PRECIOUS STONES**

SAN FRANCISCO, Temporary Office, Oakland, Delger Building

YOUR MEMO. ORDERS ARE SOLICITED

NEW YORK, 41 Maiden Lane

## News From the Optical Trade.

W. W. Spaulding will shortly open an optical department in Ballston Spa, N. Y. J. P. Durfee, optician, is moving into quarters in the new Kent building, Drain, Ore.

The Hutesson Optical Co., Omaha, Nebr., has refurbished its optical rooms with attractive oak fixtures.

The Berteling Optical Co. will soon occupy new quarters on Bush St., near Van Ness Ave., San Francisco, Cal.

W. H. Stevenson, Fitchburg, Mass., recently sold his optical business to R. M. Morley, Springfield. E. L. Piper will act as manager of the Fitchburg office.

B. B. Combs, Omaha, Nebr., attended the meeting of officers of the Nebraska State Optical Co., of which he is treasurer, which was held in Lincoln recently, and reports that eight members will attend the meeting of the A. A. O., at Rochester, N. Y., July 2-Aug. 2, inclusive.

John Coburn, who conducted an optical establishment at 215 Main St., Jamestown, N. Y., has closed his office and left Jamestown to become general manager of the Coburn Optical Co., which will open stores in Kansas City, Mo.; Wichita, Kans.; Memphis, Tenn., and Birmingham, Ala.

T. F. Farrell, formerly an optician of Marysville, Cal., has given up that profession since the San Francisco disaster, and is now in company with a number of others has organized a contracting firm to assist in the work of rebuilding the city. The company is to be incorporated and will compete for work on all kinds of building contracts.

The California Optical Co., whose principal establishment on Kearny St., San Francisco, Cal., was destroyed in the San Francisco fire, has purchased the lease held

Mrs. Bettie Laymance, of the store at 13 Broadway, Oakland, and will take possession of one-half of the premises Aug. 1, the other half being occupied by a jewelry man.

M. E. O'Neill, optician, Denver, Colo., has just recovered a handsome and valuable gold watch which she lost over a year ago. At the time of her loss she advertised for the papers for three months but to no avail. The case was then placed in the hands of the local detectives, and after a careful search the missing timepiece was discovered in a pawnshop and returned to its owner.

At the June meeting of the New England Association of Opticians, which was held last week at Young's Hotel, Boston, Massachusetts, supervisory committees of members were appointed to promote educational interests of the organization, to watch for slackery in the trade and to scrutinize the advertising that is done by opticians, with a view of correcting abuses or shortcomings in the trade as a whole.

Abner C. Thomas, jeweler and ophthalmologist, has purchased an established optical business in the Metropolitan Life Insurance building, 29 E. 23d St., New York. He will move there in a short time. His office at Sistersville, W. Va., will be continued under the management of his brother, W. T. Thomas; another brother, W. Thomas, will take charge of the office at 1026 Noble St., Anniston, Ala.

## Boston.

The Perry-Aldrich Co., which, as recently noted, was incorporated in Maine, has taken quarters at rooms 709-710 Washington building, 387 Washington St., where a jewelry and art goods jobbing business has been established.

The Waltham Watch Co. will close its factory next week for the usual midsummer period, giving the employees opportunity for a brief vacation while the plant undergoes thorough inspection and whatever changes are necessary.

Buyers in town during the week included: David Robertson, South Framingham; G. Schmidt, Lawrence; Mr. Pettengill, manager for H. N. Noyes, Haverhill; H. W. Darling, Stoughton; Elmer G. Tucker, Worcester; E. Beaudreau, Marlboro.

The John B. Humphrey Co. has just received from the brother of Mr. Humphrey, who is at Diamantina, Brazil, where extensive prospecting is in progress under the direction of the Humphreys, an unusually fine lot of rough specimens, one bunch of the gems averaging about three carats.

Three young men entered the store of B. J. Short, 530 Tremont St., last Friday morning, and one of them broke the glass in the showcase while the other two engaged the attention of the clerk. Each of the trio then seized a tray of emblem pins and other jewelry, all making their escape. The jewelry was valued at nearly \$100.

## Montgomery, Ala.

New show cases have been installed in the store of J. A. Weiss & Son for the display of cut glass, silver and china.

The owners of the site of "The Fair," which carries a stock of jewelry, will erect a five-story building in the near future.

Hardwick Ruth, of C. L. Ruth & Son, was a visitor recently at the University of the South, Suwanee, Tenn., of which he is a trustee. The store has been generally overhauled for the Summer trade.

M. E. Pepperman has added a number of new features to his store in the New Exchange building. His father, Jacob Pepperman, has just returned from a trip with the National Editorial Association, of which he was a member from the State of Alabama.

Max Robinson writes from Birmingham that a large attendance of jewelers of the State is anticipated July 10, the day set for the organization of an Alabama association. Signatures to the call indicate much interest in the movement. Mr. Robinson recently added a watch material department in his store at Birmingham.

R. Blackinton & Co., North Attleboro, Mass., are making a feature of combinations in toilet and manicure sets, arranged in silk-lined cases. For the past few years they have met with such success, considering the few patterns which they have made in these goods, that the decision to make an extensive line this year was determined upon. The line on exhibition at the New York office is handsome beyond expression.

## Newark.

The Matthews Co., which was incorporated recently at Trenton, N. J., will manufacture silverware, with works and offices at 112 Arlington St., Newark. Harry B. Matthews, who was store manager of the Alvin Mfg. Co. for several years, will be the president of the new corporation. O. D. Jamouneau, who was formerly at the Alvin factory, will be the secretary and treasurer of the company. John Foster will also be associated with the new company.

On the application of Kremetz & Co., manufacturing jewelers, at 47 Chestnut St., an order has been issued, returnable July 5, requiring the Empire Varnish Co. to show cause why it should not abate alleged nuisances. It is charged that the smoke from soft coal and fumes from linseed oil enter the jewelry factory, annoying the employes and endangering their health. Another charge is that large quantities of turpentine and benzine are stored in the varnish works without proper protection against fire. The order was granted by Vice-Chancellor Pitner. The jewelers are represented by Chandler W. Riker as attorney.

Sympathy is extended by numerous friends to John M. Cutter, manager of the Trenton Watch Co., Trenton, N. J., whose wife, Mrs. Margie Watson Cutter, died unexpectedly of a blood clot on the brain on Monday of last week at her home, 908 W. State St., in that city. Mrs. Cutter seemed to be in her usual good health until the afternoon before her death, when she complained of a slight illness and her condition grew rapidly worse. Mr. Cutter was in Chicago, and was unable to get back to Trenton until after his wife's death. About two years ago the family moved to Trenton from Elgin, Ill., where Mr. Cutter had been connected with the Elgin Watch Co. Mrs. Cutter leaves, besides her husband, a boy of 13 years.

Bogus checks were offered recently to a number of jewelers in Trenton, and at last one of their number was swindled. A well-dressed young man called at F. W. Rowe's store, 175 S. Broad St., and after buying a ring costing \$5 handed in payment a check for \$15 drawn on a local bank. The jeweler had no suspicion that the check was not all right, and so he handed out \$10 change. Later in the day, when Mr. Rowe went to the bank to cash the check, he was surprised on learning that the order was worthless. Isaac S. Vogel, 446 S. Broad St., had a visit from a young man, probably the same swindler, who tendered a check for \$15 in payment for a \$4.50 ring. The check offered to Mr. Vogel was drawn on the First National Bank in the name of the Prudential Insurance Co., and was indorsed "J. E. Woodland." The jeweler offered to go with the young man in order to ascertain if the check was genuine, and this frightened the fellow, who left in a hurry.

A temporary injunction, which had been granted by Justice E. A. Speneer at a recent term of the Supreme Court in Schenectady, N. Y., restricting Charles Bickelman from erecting a piazza on his house, at 26 Union St., was vacated June 25, at a special term of the Supreme Court.



**Ball's Official Standard R.R. Watches**

**ESTABLISHED RETAIL PRICES      PROFIT GUARANTEED**

When competition grows keen, some jeweler will sell watches at jobber's list—sure as fate.  
We originated "established prices for complete watches"—always could and always have maintained them.  
Why not take an exclusive agency for the Ball watches—a fair return on your time and capital guaranteed by our system of established and maintained retail prices.

*Write for booklet, and watch this space.*

We want to add a lot of new friends to the Ball family of railroad watch dealers

**THE WEBB C. BALL WATCH CO.**

CLEVELAND Ball Building      CHICAGO 804-6-8 Railway Exchange

ESTABLISHED 1854.

INCORPORATED 1883.

**JUERGENS & ANDERSEN CO.,**  
DIAMONDS,  
MAKERS OF FINE JEWELRY,  
92 TO 98 STATE STREET,  
CHICAGO.

23-25 Looijersgracht, Amsterdam, Holland.

**THE HERMAN KECK MFG. CO**  
CUTTERS OF  
**DIAMONDS.**

**FOR SALE.**

A complete diamond cutting outfit of twenty benches, European make, consisting of sawing machines, rounding machines, laps, tongues, dops, scouring stands, etc., all in first class condition. Will sell cheap, if sold in bulk at once, as we have replaced them with American tools.

MANUFACTURING JEWELERS,      SILVERSMITHS.

Recutting and Repairing of Diamonds.

**17-19-21-23 West Fourth St.,**  
**CINCINNATI, O.**

RUDOLPH NOEL

PHILIP NOEL

**RUDOLPH NOEL & CO.**

IMPORTERS OF

**DIAMONDS**

2 Tulp Straat, AMSTERDAM

Phone 1902 John

37-39 Malden Lane, NEW YORK





# WESTERN DEPARTMENT

Western Office:  
204 COLUMBUS MEMORIAL BUILDING,  
CHICAGO.

Telephone:  
4079 CENTRAL,  
CHICAGO.

Vol. LII.

CHICAGO, WEDNESDAY, JULY 4, 1906.

No. 22.

## Chicago Notes.

L. Newhouse has returned from a northern trip.

Harry Miller is on a trip to Pittsburg and Cleveland.

Geo. H. Thomas, with the Mauser Mfg. Co., is now an Odd Fellow.

M. Newhouse has returned from a trip to the Coast.

E. H. Banker, vice-president of the Benedict Mfg. Co., is on a trip east.

C. J. Roehr, representing the Basset Jewelry Co., is on a trip to the factory.

All of the Chicago jobbers are busily at work on their new Fall catalogues.

Frank H. Challen, with the Ohio Cut Glass Co., is on a trip to the northwest.

T. C. Boylan, with Manning, Bowman & Co., left for the Pacific Coast last week.

Frank T. Barton, with the Fontneau & Cook Co., has returned from the Pacific Coast.

Herbert E. Cobb, of the Daggett & Clap Co., will discontinue his regular trips to the Coast.

W. A. Fay, with the John T. Mauran Mfg. Co., has returned from the Pacific Coast.

Mr. and Mrs. W. A. Beckingham have returned from their wedding trip spent in Europe.

H. H. Fruer, with the A. F. Smith Co., Omaha, Nebr., is taking a three weeks' vacation here.

H. C. Rowbotham, with the Schrader-Wittsein Co., has returned from a western and southern trip.

Geo. P. Marshall, manager for E. V. Roddin & Co., has returned from a vacation to the northern lakes.

E. C. Jacob, of Woollett & Jacob, has completed the building of a Summer cottage at McHenry, Ill.

M. R. Wadds, cashier for Wm. A. Rogers, Ltd., is recovering from a severe case of blood poisoning.

Math. Hermestroff, formerly of the Western Jewelry Co., is recovering from an operation for appendicitis.

A. R. Oughton, representing the Jennings Bros. Mfg. Co. and the Van Bergh Silver Plate Co., has returned from a northern trip.

The Star Watch Case Co. removed its plant at Elgin, Ill., to Ludington, Mich., last

week. The move was made in less than six days.

M. H. Berg, of Hyman, Berg & Co., accompanied by his wife, sailed last Thursday on *La Provence* for a three months' European trip.

A. Ellbogen, with Sproehule & Co., is taking a vacation at Lake Harbor, Mich. C. L. Caliger, with the same concern, is at Eagle Grove, Ia.

Julius Schnering, of Otto Young & Co., is the head of a committee appointed to draft a set of by-laws for the new Chicago Jobbers' Association.

Lebolt & Co. have opened a branch store at Saratoga Springs, N. Y. It is located on Broadway between the United States and Grand Union Hotels.

The J. E. Micks Co., retail jewelers of Elkhart, Ind., have entered the jobbing field. Their retail business will still continue. Indiana, Ohio and Michigan will be the field they intend to cover.

F. E. McCullin, western manager for Wm. A. Rogers, Ltd., has returned from a visit to the company's factories at Northampton, Mass.; Oneida, N. Y.; Niagara Falls, N. Y., and to the offices in New York.

J. B. Renker, manufacturers' agent at San Francisco, is here from the coast accompanied by his wife. Mr. and Mrs. Renker lost all their personal property in the San Francisco fire. Mr. Renker will again locate in California.

Among the out-of-town buyers here last week were: A. F. Smith, of the A. F. Smith Co., Omaha, Nebr.; John W. Neasham, Ottumwa, Ia.; A. L. Haman, of A. L. Haman & Co., St. Paul, Minn.; F. W. Hinrichs, Kalamazoo, Mich.; Cliff Sherman, of M. T. Sherman & Sons, Woodstock, Ill.; J. E. Micks, of the J. E. Micks Co., Elkhart, Ind.; Adolph J. Reinhardt, Lincoln, Ill.; John Schmelzer, Centralia, Ill.; Will Fulton, with the Lewis Jewelers' Supply Co., Denver, Colo.; E. H. Carpenter, Burlington, Ia.

What promises to be an interesting discovery was the outcome of a house party given by Mr. and Mrs. J. T. Brayton at their Summer cottage at Lake Kinkenosha, Wis., recently. Among the guests were Walter G. King, of the Julius King Optical Co., and A. G. Larsen, with the same firm. Messrs. King and Larsen, at the request of Mrs. Brayton, removed a large boulder in

front of the house, and as the stone rolled down the lawn a beautiful carved head of an Indian woman was exposed to view. It is a full face carved out of the solid rock. The base of the stone had been squared off and had evidently at one time rested on a pedestal. As the spot where it was found was formerly an old Indian trail, the sculpture had probably marked the last resting place of some former Indian queen.

## Cleveland.

J. H. Heiman has placed a new street clock in front of his store, 143 Euclid Ave.

H. S. Hurlbut, of the Scribner & Loehr Co., was married, a few days ago, to a Miss Moore. J. M. Jenks, also a member of the house, was married, last week, to a lady of Dayton, O.

Among the recent visitors to the city were the following: A. E. Kintner, Painesville; E. E. Critz, Elyria; R. R. Moore, Cuyahoga Falls; E. F. Seaman, Monongahela, Pa.; A. J. Heiman, Barberton, and Mrs. E. D. Kindig, Elyria.

A. E. Knight will shortly open a new store on Hough Ave. and is now engaged in purchasing stock and fixtures. Mr. Knight has been a traveling salesman for the Scribner & Loehr Co. and until a short time ago covered a portion of Michigan.

Stephen Touzinsky, a jeweler formerly doing business at 4918 Broadway, was arrested, last week, on a warrant charging him with conversion, issued at the instance of the Bowler & Burdick Co. The warrant charges Touzinsky with converting to his own use the sum of \$207.44. It is alleged that Touzinsky had been selling watches for the firm on a commission; that he collected the sum total named and did not account for it.

The Bowler & Burdick Co., of this city, has filed an intervening petition in the involuntary bankruptcy proceedings brought against the firm of Davis Bros., of Galion, by Freudenheim Bros. & Levy, White, Wile & Warner and West, White & Christy. The company asks to be made one of the petitioners and asserts that the firm is indebted to the nose to the amount of \$357.66. Davis Bros. have filed an answer to the original petition, in which they deny the allegations made. The case will probably be interesting because of these facts.

# To the Jobbing Trade.

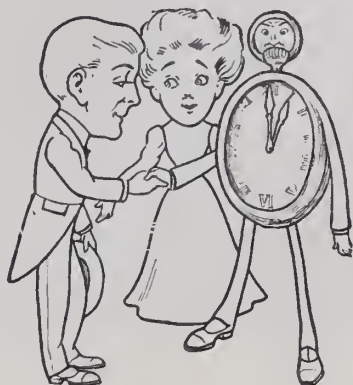

## It's Time

Now to look at our complete line of Diamond Mountings, if you have not already done so.

**SHIMAN BROS & CO.**  
 87 MAIDEN LANE, N. Y.  
 LONDON: 50 HOLBORN VIADUCT.  
 AMSTERDAM: 2 TULIP STRAAT.  
 FACTORY: 1, 3, 5 GOLD STREET.

### Kansas City.

#### TRADE CONDITIONS.

The wholesale optical business is especially good at this time, everyone having plenty to do. Wholesale jewelers are busy getting in their goods and preparing to put their men out on the road. The state, however, for the benefit of the retail trade of this section, that no traveling men on the road before July 5 will have a line of the newest goods to show the trade. Kansas City travelers will be starting out right after July 4.

Isador Eller, Richmond, Kans., was in this city, during the past week, for medical treatment.

Ed. Netzhammer, formerly with the H. Sig & Kricke Jewelry Co., has gone to St. Louis, Mo.

F. H. Stevenson, formerly of Shawn & Co., Okla., has taken a position with the Edwards & Sloane Jewelry Co.

J. R. Mercer has been superintending the installation of a new elevator in the Heaton building during the past few days.

H. M. Turney, Stockton, Ill., was here last week, on his way to Stilwell, Okla., where he will locate in the jewelry business.

Dr. W. F. Hammond, Manchester, Kan., and Dr. A. E. Howell, Salida, Colo., are taking a post-graduate course in the Southwestern Optical College.

M. H. Hill, Smith Center, Kans., is coming to Kansas City to take a course in engraving and watchmaking with the Kansas City Polytechnic Institute.

News has been received from Walter Jaccard, of the Jaccard Jewelry Corporation, who has been making a short diamond buying trip to Europe, that he is on his way home again.

The following out-of-town jewelers elsewhere mentioned were in this city, last week: L. E. Hendrickson, of A. C. Ross & Co., Osage City, Kans., and Cary Ma Baldwin, Kans.

Mr. Calder, formerly a watchmaker with F. W. Meyer, but now with the H. Wal Starcke Co., Junction City, Kans., was in this city on business during the early part of the week.

Mrs. Frances Norvell, who had been taking a course with the Kansas City Polytechnic Institute, finished last week, and went to Stuttgart, Ark., where she will engage in business as the Norvell Jewelry Co.

W. E. Huston, secretary of the American Association of Opticians; Fred C. Meyer, of the Merry Optical Co., and Dr. S. Lane and wife, of the Southwestern Optical College, will leave the latter part of July to take in the national convention of the organization.

Morris Klein, 1027 Main St., this city, was fined \$50 in the police court recently on a charge of selling goods at auction for more than they were worth. One woman asserted that she paid \$13 for a watch which Klein claimed was worth \$30 and which was alleged, subsequently proved to be worthless.

V. G. Cuthbert, who covers Kansas, Missouri, Oklahoma, Nebraska and Illinois, Otto Young & Co., and makes his headquarters in this city, has been home several days, on his vacation. He took his family to Excelsior Springs, Mo., and then went on a visit to the house. He will also visit his father, in Ohio, before returning to Excelsior Springs to join his family.

## Cincinnati.

Louis Rauch will leave this week on a western trip.

Erwin Herman, of Herman & Loeb, has returned on a western trip.

Wallace Miller, formerly of the Miller Jewelry Co., is visiting friends here.

Joseph Kramer, of Lindner & Co., is visiting at the home of A. H. Beer, Versailles, Ind.

Erwin Gruen, of D. Gruen, Sons & Co., has returned from a 10 days' stay at French Lick Springs, Ind.

Ernest P. Lovell, who about a year ago resigned under Kentucky laws, has offered 50 per cent. to his creditors.

G. Radebaugh, Stuttgart, Ark., was here last week purchasing stock for the new store that he has just opened.

Charles and John C. Daller, Jr., of the Oens Oskamp Co., have started on a summer's outing on the Miami river.

Ernest Leubuseher, of L. Gutmann & Sons, and his wife, has arrived from Europe, where he visited many jewelry centers.

A glass shelf in one of the windows of the Oskamp Jewelry Co.'s store suddenly came through the center and dropped, last week, carrying with it about \$200 worth of goods, which were destroyed.

Ernest P. Becht, for 19 years with the Clemens Oskamp Co., has severed his connection with this house. The employes of the company presented Mr. Becht with a handsome gold watch fob on his retirement.

Ernest T. Eichelberger, of Joseph Noterman & Co., with his family, has gone to his Summer home at Clark's Lake, Mich. Edward A. Pfueger, son of William Pfueger, of this house, was lately admitted to the bar.

In the window of George Newstedt's store last week was shown a tray of watch cases which had been through the earthquake and fire at San Francisco. The shape of the cases is still perfect, though the metal has a black and burnt appearance. On some the engraving is still clear and visible.

Ernest Rudolph Frank Maier, son of Frank Maier, Bowling Green, Ky., died Monday, June 25, from injuries received from a street car at Middletown, O., on Sunday afternoon, June 24. He and a friend were returning from a fishing camp about four miles from Middletown, and were struck by the approaching car. The deceased was 27 years old, and was an employe of Fred Wittlinger, of that place. The elder Maier, with C. E. Richter, of Richter & Phillips; a friend of the family, went on to Middletown for the remains. The funeral took place at Bowling Green Wednesday afternoon.

Out-of-town jewelers who bought stock last week included J. G. Irwin and daughter, Harriman, Tenn.; E. Dold, Madison, Ind.; Otto Zoellner, Portsmouth, O.; C. Beer, Sunman, Ind.; William Leive, Aurora, Ind.; Charles R. Brown, Dayton, O.; P. D. Freeman, Ashland, Ky.; Mr. Bowen, of Bowen & Simpson, Winchester, Va.; John A. Worrell, Washington C. H., Va.; Mr. Gayman, with the Hofman Jewelry Co., Columbus, O.; A. Wahrab, Dayton, O.; O. E. McWaters, Somerset, Ky.; Mrs. Kupferschmidt, Lawrenceburg, Ind.; Walter Eisensmith, Charleston, W. Va.; L. Olmsted, North Vernon, Ind.; C. F.

Schlegel, Chillicothe, O.; Mr. Rigdon, of Rigdon & Rigdon, Ohio City, O.; A. E. Axman, Franklin, O.

Two well-dressed men, one tall, the other short, called at the store of the Loring Andrews Co. about noon Wednesday and asked a saleswoman to show them some diamond rings. They described the kind they wanted, and were shown several trays, during which time the shorter man did the talking. The men were businesslike in their manner, displayed a roll of bills as though wanting to purchase, and in no way aroused any suspicion. Many articles were asked for by the shorter man, and he was apparently spending time in trying to make a selection. Finally he said his taller companion would come in later, and left the store with his companion. The clerk, in putting away the diamonds, discovered that one tray containing seven rings, valued at \$600, was missing. The police were immediately notified, and are looking for the two men. The short man wore a gray suit and straw hat, and had a smooth face. His taller companion wore a blue suit and straw hat; also had a heavy sandy mustache.

## St. Louis.

Joseph Linz, of Joseph Linz & Bros., Dallas, Tex., was in St. Louis last week.

Miss Eva Pecaut, of the sales staff of the L. Bauman Jewelry Co., returned last Monday from her vacation.

The vacation period of the Mermod, Jaccard & King Jewelry Co will begin early this month and close about Sept. 1.

The new signs on the windows of the Brooks-Auer Jewelry Co. read "J. J. Burke, President Brooks Jewelry and Optical Company."

Otto G. Steiner, secretary of the Steiner Jewelry Co., 1432A N. Park Pl., left last week for a fortnight's fishing trip at Gillead's Slough, on the Mississippi.

The auction sale of the Mermod, Jaccard & King Jewelry Co. is now being conducted at night until the stock has been sold out. The sale has been very successful.

Among the out-of-town buyers who visited the trade in St. Louis last week were: W. L. Derleth, Centralia, Ill.; J. Hainell, Litchfield, Ill., and E. S. Royer, Bismarck, Mo.

Alvin Bauman, president of the L. Bauman Jewelry Co., is expected back from his European trip about July 20. The vacations of this firm will not begin until after his return.

James W. Behen, of the sales staff of the Hess & Culbertson Jewelry Co., will leave for Seattle, Wash., on his vacation about the first of the month, to be absent all of this month.

The case of Charles E. Pitcher, formerly with J. F. Dailey & Co., charged with embezzlement, came up for trial in the criminal court Wednesday, but was continued on the docket indefinitely, the judge refusing to *nolle prosequere* the case.

Joseph Auer, traveling representative of the Bauman-Massa Jewelry Co., returned last week from his vacation spent in Yellowstone Park. Samuel H. Bauman, president of this firm, has sailed from Europe, and will arrive home about July 6.

William Weidlich, of William Weidlich & Bro., who went to Connecticut several weeks ago, called there by the death of his brother, is expected to return to St. Louis about the middle of this week. Charles Ens, manager of this firm, made a flying business trip to Springfield, Ill., during the past week.

The solid silver tea set presented at the Millers' Convention at Milwaukee has been on exhibition at the Merchants' Exchange, and later will be exhibited in the Hess & Culbertson Jewelry Co.'s windows. The set consists of six pieces and cost \$1,800.

Edgar L. Pike, of Joseph Linz & Bros., Dallas, Tex., and Valentine Hafner, of the Walter-Hafner Jewelry Co., Hillsboro, Tex., were included in a party of Texas business men which visited St. Louis recently on the way home from a tour of Illinois cities.

The jewelers of Franklin Ave. are quite generally joining in the movement of the Franklin Ave. Improvement Association, recently organized to obtain recognition from the city government of the claims of this street, which is said to be the longest retail street in the world.

J. F. Dailey, of J. F. Dailey & Co., who has been in Chicago since the first of June on business connected with the opening of their store in that city, is expected to return to-day. R. W. Wilson, upon his return, will go to Chicago, and while there will take his vacation, visiting many of the lake resorts around Chicago. In the intervals of the visits to Chicago of Mr. Dailey or Mr. Wilson, A. H. Aylesworth will have charge of the Chicago store of J. F. Dailey & Co.

The employes' outing of the Mermod, Jaccard & King Jewelry Co. was held last Saturday at Ramona Park, in St. Louis County, the picnickers going out to the lake in special cars of the Suburban line, which left Broadway and Locust St. at 1.20 p. m. The programme consisted of an address of welcome by J. C. O'Brien, chairman of the committee; baseball between the married and single men's teams, athletic exercises, etc. Music and dancing completed the programme, which lasted from 5 to 10.30 p. m. The officers of the course were: J. C. O'Brien, referee; N. P. Logan, clerk of the course; Charles Stephens, starter; W. A. Boehm, E. C. Eiseman and E. W. Bornmueller, judges.

Quite a number of the most prominent members of the local trade figure in a review printed in last Sunday's *Republic*, of the beginnings of some of the most successful business men of the city. According to the article, George Hess, of the Hess & Culbertson Jewelry Co., began his business career as a telegrapher; F. W. Drost was a watchmaker's apprentice before finally becoming the head of a large jewelry concern; G. F. W. E. Eggert, of Eggert & Fisher, began as an optician's apprentice in Germany in 1881; A. P. Erker, president of Erker Bros. Optical Co., learned the business in Germany and came to the United States in 1873; Patrick T. Whelan, of the Whelan-Aehle-Hutchison Jewelry Co., began as a salesman for the Eugene Jaccard Jewelry Co., and August Kurtzeborn embarked in the business as an apprentice for L. Bauman.

## San Francisco.

### TRADE CONDITIONS.

One of the most pleasant surprises that has greeted the retail jewelers who have started in business again since the fire, is the fact that refugees across the bay, as well as many suburban residents are coming in increasing numbers daily to make their purchases in San Francisco. As the retail stores here are, with but a few exceptions, still located in private houses, or in out of the way places, this phase of business is particularly gratifying and is regarded as an index to the activity that will result when the new shopping district is ready for business. The return of the country trade is only second in interest to the loyalty of people around the bay. The large jewelry houses are receiving orders all the time and these without any advertising or soliciting. It has not always been possible to fill these orders here, but each day new stock is arriving and the efficiency of this service is increased. Some of the ideas that were formed immediately after the fire as to the probable drift of trade in San Francisco have been revised considerably since that time. These early deductions, made on a calamity basis, are not being borne out by the actual resulting facts. Instead of the cheapest grades of goods being in universal demand, the reverse is true, and the call is for good substantial goods, much to the dealers' delight. Jewelers are not doing a heavy business in rings or bracelets, but they are selling many watches, clocks and table ware. When the large hotels are again open for business the tourist trade will again assume its old-time proportions and jewelers will commence to move back into the old retail district. Business is rushing with the wholesale jewelers. The country trade is above normal for this time of the year and the city business is heavy, owing to many stores which are just starting up in business again. Almost all the wholesalers who moved across the bay after the fire are now back again, but some of them are experiencing great difficulties in securing suitable offices.

Lichtenstein Bros. are now established on Market St., near 5th.

J. A. Sorensen Co., formerly of 6th St., will open a new retail store, in a few days, at 717 Market St.

G. R. Moss, formerly of G. R. Moss Co., Geary St., will open a restaurant, in a few days, on Market St.

The store of Mr. Alexander, formerly of 852 Market St., will be reopened at Van Ness Ave. and Pine St.

H. M. Abrams is back in the Kamm building, and reports a splendid business. Mr. Plamundurn, one of Mr. Abrams' traveling representatives, is to start out this week, his first trip since the fire.

Among the out-of-town visitors to the local trade last week were: Charles Harris, of Charles Harris & Son, Stockton, Cal.; L. C. Koberg, of Healdsburg and Tonopah; Mr. Mount, of Mount & Ross, Petaluma, and Mr. Frederick, Seattle, Wash.

W. H. Millroy, who was formerly with Hammersmith & Field, and who went to Los Angeles after the fire, is back again in his old position. Mr. Field has just returned from Sacramento, where he has been ever since the disaster. He has been suffering from paralysis for some time, and it is not likely that he will ever be able to resume business again.

A. I. Hall & Son are now receiving some heavy shipments of goods from the East. Mr. Huggins, president of this firm, is now in New York ordering goods for the Fall trade, and large consignments of his selections will soon arrive here. Workmen are busy on the rear of the Kamm building, in which the firm is located, but this portion will not be finished before Jan. 1, as the steel framework has to be removed. As

soon as this section of the building is ready for occupancy the store will be moved there and the part now being occupied will be repaired.

The rapid growth of Van Ness Ave. as a choice shopping district, and the turn that trade has taken for the better, has induced the W. K. Vanderslice Co. to enter the field again, and an admirable store location has been secured on Van Ness Ave. near California St. This location is considered the choicest in the new retail district, and is near the Claus Spreckles mansion, now in ruins. The contract has been awarded for handsome store furnishings, and the store is expected to be ready for occupancy about July 20. A complete line of gold and silver ware and jewelry will be carried as in the former store on Sutter St.

Although the new store of Hammersmith & Field, located at Van Ness Ave. and Eddy St., is as yet unfinished, Mr. Hammersmith states that quite a good business is being done, and, in fact, has been done for the past month. Within the next 10 days the shelving and show cases will be installed and the goods that are now arriving can then be placed on display. This firm is making a specialty of restoring burnt silverware, and has taken some heavy contracts for this class of work. For the big field day that is to be held in Golden Gate Park to-day, the firm has prepared 50 medals and 27 trophies, materials for which came from the east.

## Omaha.

Albert Edholm is on a fishing trip to Haywards, Wis.

John F. Mawhinney was at Fairbury, Nebr., on business, last week.

T. J. Bruner, a salesman for the A. F. Smith Co., is spending his vacation at Lake Okoboji.

Charles Ingalls, Lincoln, has sold out the entire stock formerly owned by his brother, J. F. Ingalls.

A. I. Agnew, president of the Columbian Optical Co., Denver, Colo., was a visitor here, during the past week.

W. C. Wheeler, watchmaker for the Mawhinney & Ryan Co., with his family, is spending his vacation at Vermillion, S. Dak.

Mr. Samson, of Farnham & Samson, Blair, Nebr., and Mr. Max Egge, Grand Island, were in the city last week, purchasing stock.

On June 25 Fred Brodegaard, of Fred Brodegaard & Co., was married to Miss Mary Nordin at the Danish Lutheran Church. The couple went immediately to Mr. Brodegaard's Summer home at Benson.

Jack Jennings, alias Kid Clark, and August Martin, alias McGregor, charged with the theft of a \$200 diamond from the jewelry store of M. D. Franks, June 5, were found guilty of grand larceny, after the jury had deliberated 10 minutes. Neither of the men went on the witness stand in his own behalf, and no testimony was offered for them.

Fred Brodegaard, through the death of his uncle, William Beck, at Aeroeskjobing, Denmark, March 30, has fallen heir to 20,000 crowns, or \$5,000. When Mr. Brodegaard left Denmark 23 years ago, his uncle

promised that he would be remembered his will. Last week Mr. Brodegaard received from the probate court of Denmark papers to be signed in the presence of Theodore Olsen, the Danish consul. As soon as they are returned to Denmark the bequest will be forwarded.

## Pacific Coast Notes.

E. R. Sawyer, Santa Rosa, Cal., moved into new quarters on Mendocino

Fred A. Smith, who has been in Quincy, Cal., for some time, has returned to San Francisco and re-entered the employ of Radke & Co.

M. K. Giant, Vallejo, Cal., has commenced the enlargement of his store at Georgia St., by extending the salesroom to the rear 25 feet and by installing plate glass show cases.

O. Burress, a soldier who stole a diamond ring valued at \$180 from A. Katz, Oakland, Cal., pleaded guilty to grand larceny before Judge Harris last week, and an effort is now being made to have him placed on probation. Sentence has been continued 10 weeks.

Rothschild & Hadenfeldt, long established in San Francisco previous to the earthquake and fire of last April, have begun erection of their future factory at 238 Pablo Ave. and 38th St., Oakland. The factory will not only be close to the traction lines, but adjacent to the Santa Fe and Key Route depots.

W. A. Manson, of the firm of Manson Bay, San Bernardino, Cal., has returned from a six weeks' vacation. Mr. Manson made a general tour of Ontario, Can., visiting friends and his former home, Woodstock, Toronto and other cities. Returning to New York, he took advantage of the opportunity to buy holiday goods.

A. E. Springborg, Redlands, Cal., recently extended his jewelry store room 20 feet to the rear and added another glass front wall case. He has also built a plate glass enclosure in the rear, to be used exclusively for cut glass, a line to which his firm has always paid much attention. The enclosure is mirror lined, and is rendered very attractive. The ceiling is lighted by a number of electric lights.

## Pacific Northwest.

Harvey W. Freeze, Brownville, Ore., on leave, in a few weeks, for the east, where he will take up the study of optometry and engraving for a year.

About a week ago thieves broke into a store in Fraternity block, Colton, Ore., which contained the bankrupt stock formerly owned by J. S. Keeney, now in charge of J. J. Kennedy, trustee in bankruptcy. A number of fountain pens, some jewelry and other articles were taken, valued in all about \$100. The authorities were notified and the thieves were caught at Astoria with the loot.

Burglars, about a week ago, broke into the general store of Harrison & Harris, Newark, Tex., and made off with jewelry and other stock aggregating about \$200 in value. The safe of the same concern was blown open by burglars last year and looted of nearly \$1,000 in cash.

INDEX TO ADVERTISEMENTS.

A. u. Lambert & Co. . . . .	104	Gorham Mfg. Co. . . . .	56	Oriental Bank . . . . .	60
A. opp & Ailsopp . . . . .	26	Gougelman, Paul . . . . .	92	Orkln Bros. . . . .	32
A. n Mfg. Co. . . . . Inside front cover		Griffoul, August . . . . .	96	Osmun Parker Mfg. Co. . . . .	22
A. rican Cuckoo Clock Co. . . . .	89	Guardian Trust Co. . . . .	60	Ostby & Barton Co. . . . .	19
A. rican Gem & Pearl Co. . . . .	52	Hagstoz, T. B., Ltd. . . . .	104	Page Davls Co. . . . .	90
A. rican Platinum Works . . . . .	102	Hahn, E., & Co., . . . . .	50	Palrpoint Corporation . . . . .	98
A. rican Ring Co. . . . .	29	Harris & Harrington . . . . . Outside back cover		Passmore Gem Co. . . . .	52
A. rican Silver Co. . . . .	35	Hedges, A. J., & Co. . . . .	22	Patek, Philippe & Co. . . . .	80
A. rican Waltham Watch Co. . . . .	82	Hedges, Wm. S., & Co. . . . .	46	Penfold, Wm. C., Co. . . . .	86
A. Crown Mfg. Co. . . . .	58	Helviz Bros. . . . .	27	Perival, D. C., & Co. . . . .	62
A. steln Bros. & Co. . . . . Outside back cover		Heller, L., & Son . . . . .	42	Pomfret Goldy School . . . . .	96
A. John, & Son . . . . . Outside back cover		Herpers Bros. . . . .	96	Potter & Luffinton Co. . . . .	31
A. Turquoise Co. . . . .	52	Hirsch & Hyman . . . . . Outside back cover		Power, Chas. L., & Co. . . . .	46
A. Perlne & Co. . . . .	48	Hoddenpyl & Walker . . . . .	42	Powers & Mayer . . . . .	13
A. Webb C. Watch Co. . . . .	64	Hoe's, James C., Sons . . . . .	90	Prior, Charles M. . . . .	29
A. Lkapf, Jacob . . . . .	34	Holtzer Cabot Electric Co. . . . .	103	Prybibil, P. . . . .	103
A. sett Jewelry Co. . . . .	32	Honesdale Decorating Co. . . . .	98	Pryor Novelty Co. . . . .	80
A. s & Bacou . . . . .	19	Hotel, St. James . . . . .	28	Racine, Jules . . . . .	89
A. nner, H., & Co. . . . .	98	Howard, E., Clock Co. . . . .	88	Reichhelm, E. P., & Co. . . . .	96
A. e, J., & H. . . . .	96	Hruba, Louis W. . . . .	98	Renzihausen, W. F., Co. . . . .	104
A. lke & Eckert Co. . . . .	74	Humphrey, John B. . . . .	50	Revell, A. H., & Co. . . . . Outside back cover	
A. ley, S. O., & Co. . . . .	4	Illinois Watch Co. . . . .	8	Ries & Armstrong . . . . .	92
A. ngs, Chester, & Son. . . . .	14	Jacot Mangle Box Co. . . . .	100	Rockford Silver Plate Co. . . . .	18
A. op, R. W., & Co. . . . .	100	Jandheuer, F., Jr. . . . .	104	Rockford Watch Co. . . . .	69
A. nktion R., & Co. . . . .	15	Jeanne, Frederick A. . . . .	62	Roger Williams Silver Co. . . . .	26
A. nktion, W. & S., Co. . . . .	17	Jewelers' League . . . . .	74	Rosenman, A. . . . .	50
A. ncard & Co. . . . .	101	Johnston, W. J., Co. . . . .	11	Rosenfeld, Wm. I. . . . .	72
A. e, L. . . . .	34	Jorgensen, F. C., & Co. . . . .	102	Ross, Sallman & Anderson . . . . .	22
A. e, Edward . . . . .	98	Jurgens & Andersen Co. . . . .	64	Rothschild Bros. & Co. . . . .	25
A. ell & Vitell . . . . .	46	Jurgensen, Jules . . . . .	33	Roy Watch Case Co. . . . .	89
A. den, J. B., & Co. . . . .	20	Kahn, L. & M., & Co. . . . . Outside back cover		Rudolph & Snedeker . . . . .	33
A. lloy Polytechnic Institute . . . . .	102	Kassel, Abe . . . . .	109	Rumpp, C. F., & Sons. . . . .	102
A. wer, Maurice . . . . .	54	Keck, Herman, Mfg. Co. . . . .	64	Sadler, F. H., Co. . . . .	31
A. hl Bros. & Henins Co. . . . . Outside back cover		Kent & Woodland . . . . .	23	Saunders, Meurer & Co. . . . .	46
A. nnt, M. B., & Co. . . . .	20	Ketcham & McDougall . . . . .	92	Schiff, M. . . . .	25
A. kley Sam'l, & Co. . . . .	21	Kohlbusch, Herman, Sr . . . . .	24	Schultz, Leiss & Co. . . . .	21
A. de & Upmeyer Co. . . . .	54	Kohn, Alois, & Co. . . . .	25	Sessions Clock Co. . . . .	86
A. oone, Geo. H., Co. . . . .	33	Kohn & Co. . . . .	27	Seymour, Cassius W. . . . .	100
A. ornia Jewelry Co. . . . .	62	Koshland & Hallie Co. . . . .	28	Shiman Bros. & Co. . . . .	66
A. rington & Co. . . . .	22	Kremenz & Co. . . . .	26	Simmons, R. F., Co. . . . .	12
A. rter, Howe & Co. . . . .	23	Lackner & Ohl . . . . .	92	Smith, Alfred H., & Co. . . . .	40
A. tham National Bank . . . . .	60	Langendorf Watch Co. . . . .	89	Smith, E. H. H., Silver Co. . . . .	32
A. pard Freres . . . . .	78	Larter & Sons . . . . .	38	Snow & Westcott . . . . .	24
A. verette . . . . .	16	Lederer, S. & B., Co. . . . .	28, 32	Sohn & Hyman . . . . .	50
A. ley & Straight . . . . .	104	Lees & Sanders . . . . .	104	Solidarity Watch Case Co. . . . .	34
A. per Diamond Co. . . . .	44	Leong, L., & Bro. . . . . Outside back cover		Spencer, E. L., Co. . . . .	30
A. le, S., Co. . . . .	24	Levy, L. W., & Co. . . . .	72	State Bank . . . . .	60
A. hn, M. . . . .	24	Levy, Robert . . . . .	21	Steiner, Louis . . . . .	29
A. ss & Beguelli . . . . .	34, 58	Lewy & Cohen . . . . .	26	Stern Bros. & Co. . . . . 50; Inside back cover	
A. uch & Fitzgerald . . . . .	100	Libbey Glass Co. . . . .	100	Sternau, S., & Co. . . . .	16
A. man, C. . . . .	96	Lissauer & Co. . . . .	42	Stilwell, L. W. . . . .	33
A. s, Clark & Co. . . . .	23	Loeb, Wm., & Co. . . . .	102	Stiven, John S. . . . .	96
A. on, Louis J. . . . .	33	Lorsch, Albert, & Co. . . . . Outside back cover		St. Louis Silver Co. . . . .	78
A. asse Mfg. Co. . . . .	24	L'w, Martin, & Taussig . . . . .	42	Strauss, Ignaz, & Co. . . . . Outside back cover	
A. Selms Watch School . . . . .	22	Lowe, Edwin, & Co., Inc. . . . .	32	Strauss, Jacob, & Sons . . . . .	50
A. mond Point Pen Co. . . . .	102	Luthy & Hine . . . . .	25	Street, Geo. O., & Sons. . . . .	20
A. shheim, Hipp., & Bro. . . . .	88	Lyons Gem Co. . . . .	35	Tavannes Watch Co. . . . .	78
A. nelly, J. J. . . . .	96	Maebert & Reiss . . . . .	103	Thomas, Seth, Clock Co. . . . .	90
A. n, Bagnall & Co. . . . .	33	Maple City Glass Co. . . . .	98	Tivoli Art Glass Co. . . . .	100
A. nger, C., & Sons . . . . .	98	Market & Fulton National Bank . . . . .	60	Trenton Watch Co. . . . .	90
A. ois Watch Case Co. . . . .	28	Mathey Bros., Mathez & Co. . . . .	92	Trout, Charles L., & Co. . . . .	24
A. k, Robt. . . . .	20	Mendes Cutting Factories . . . . .	92	Van Dam, Eduard . . . . .	44
A. nbar, Leach, Garner Co. . . . .	96	Mercantile National Bank . . . . .	61	Wadsworth Watch Case Co. . . . . 6, 7	
A. rand & Co. . . . .	22	Meyerowitz Bros. . . . .	62	Wagner Mfg. Co. . . . .	25
A. lberg & Co. . . . .	50	Miller, Fuller & Whiting . . . . .	34	Waite-Thresher Co. . . . .	30
A. in National Watch Co. . . . .	84	Moe, Chas. . . . .	33	Warner & Swasey . . . . .	92
A. ssaf Bros. & Co. . . . .	96	Moore & Sons . . . . .	20	Washburn, C. Irving . . . . .	27
A. P. H. Chain Catch . . . . .	27	Mount & Woodhull . . . . .	48	Wells, Chester H. . . . .	27
A. ys, Joseph, & Co. . . . .	1	Myers, S. F., Co. . . . .	32	Wendell & Co. . . . .	5
A. rchild & Co. . . . .	102	Nebeling, Edmund R. . . . .	33	Western Clock Mfg. Co. . . . .	76
A. vre-Jacot, Georges, & Co. . . . .	88	New York Central Railroad . . . . .	103	Wheeler, Hayden W., & Co. . . . .	40
A. ley, W. J., Co. . . . .	26	New York Telephone Co. . . . .	90	Whiteside & Blank . . . . .	23
A. rman Co. . . . .	88	Nissen, Ludwig, & Co. . . . .	48	Whiting & Havis . . . . .	18
A. rsinger, J. W. . . . .	86	Noel, Rudolph, & Co. . . . .	64	Whiting Mfg. Co. . . . .	9
A. ster, Theodore W., & Bro. Co. . . . .	36	Nonnenmann, A., & J. Aschenbrenner . . . . .	28	Whitman & Hough Co. . . . .	30
A. und, Henry, & Bro. . . . .	29	Noterman, Jos., & Co. . . . .	69	Witshausen, L. . . . .	22
A. edlander, R. L. & M., 14, Outside back cover		Ohan, G. . . . .	92	Wodiska, Julius . . . . .	28
A. rraud & Griser . . . . .	35	Ollendorf, L., Co. . . . .	80	Wolfsheim & Sachs . . . . .	35
A. sweln, F. W., Co. . . . .	96	Oppenheimer Bros. & Veith . . . . .	40	Wood, C. F., & Co. . . . . Outside back cover	
A. dsmith, Leo. . . . .	72	Oppenheimer, H. E., & Co. . . . .	40	Wood, J. R., & Sons. . . . . 2, 3	
A. odfrind Bros. . . . .	46				

JOS. NOTERMAN & CO. DIAMONDS

IMPORTERS AND CUTTERS

Recutting and Repairing odd shaped and chipped stones a specialty. Manufacturers of Mountings and Fine Jewelry. Special Designs Furnished.

CINCINNATI, OHIO.

Rockford Watches Speak for Themselves.

## Special Notices.

Payable invariably in advance.

Rates 75c. per insertion for notices not exceeding 25 words; additional words, 2c. each.

SITUATIONS WANTED, 1c. a word each insertion; minimum charge, 25c.

Heavy type, 5c. a word; minimum charge, \$1.25. Display cards, \$2.00 per inch.

In all cases, if answers are to be forwarded, 10c. extra to cover postage must be enclosed.

*All answers to advertisements addressed care The Jewelers' Circular-Weekly, should be sent to the New York Office, unless the Chicago Office is specifically mentioned.*

## Situations Wanted.

YOUNG MAN, 23 years, wishes position as salesman or to work inside in wholesale house. "I., 6741," care Jewelers' Circular-Weekly.

FACTORY FOREMAN wants position in jewelry factory, where there is advancement. Address "Foreman, 6751," care Jewelers' Circular-Weekly.

FOREMAN, experienced and thoroughly acquainted with all the details of a ring factory; best references. Address "G. E., 6745," care Jewelers' Circular-Weekly.

WANTED, A POSITION as engraver, book-keeper, cashier and saleslady; good references; terms reasonable. Address "Enquirer, 5877," care Jewelers' Circular-Weekly.

SALESMAN, with eight years' experience, selling department and jewelry stores in east and middle west, is open for a position. "Successful, 6659," care Jewelers' Circular-Weekly.

GRADUATE OPTICIAN, watchmaker, jeweler and salesman; seven years' experience; age 25; nothing less than \$20 per week considered. "L., 6752," care Jewelers' Circular-Weekly.

BY FIRST CLASS manufacturing jeweler and diamond setter; 18 years' experience; have had charge of shop for last six years. Address "A. B., 6692," care Jewelers' Circular-Weekly.

YOUNG MAN, 23 years of age, desires position where hard, conscientious work will be appreciated and advancement made possible. Address "S., 6793," care Jewelers' Circular-Weekly.

FOREMAN, designer and thoroughly practical jeweler, diamond work especially; can furnish artistic original designs for presentation jewels. "E. Beach, 6774," care Jewelers' Circular-Weekly.

FIRST CLASS WATCHMAKER desires position in New York City; has first class references and is thoroughly competent on fine and complicated work. "City, 6565," care Jewelers' Circular-Weekly.

WATCHMAKER and engraver to take charge of department; experienced; understands position and finer adjustments; best city references; A1 position desired. "H., 6754," care Jewelers' Circular-Weekly.

YOUNG MAN (20), with high references, wishes a steady position as fine jeweler and clock repairer; also understands polishing and colorings; can also do solution. "S. H., 6743," care Jewelers' Circular-Weekly.

WANTED, AT ONCE, position by young man as second watchmaker, jewelry repairer, good engraver and salesman; can give reference; Cincinnati or vicinity preferred. "R., 6756," care Jewelers' Circular-Weekly.

FIRST CLASS watchmaker wants permanent position with reliable house; competent to take full charge; large experience on fine and complicated work; fine tools and best of references. Address "Time, 6712," care Jewelers' Circular-Weekly.

PERMANENT POSITION wanted by an expert, first class watchmaker; thoroughly competent on all grades of watch and clock work; single; own full set of tools; well recommended. Address "Permanent, 6700," care Jewelers' Circular-Weekly.

YOUNG MAN, Protestant, plain engraver, good jewelry and clock repairer; good salesman; send sample of engraving; fine references; go anywhere; prefer New York; \$15; inquiries answered. "T., 6738," care Jewelers' Circular-Weekly.

A WATCHMAKER of recognized ability; trained in London; 15 years' American experience; seeks position in first class firm as fine watchmaker and adjuster; highest references; have also New York optical diploma. "H. G., 6794," care Jewelers' Circular-Weekly.

POSITION WANTED by first class watchmaker; 25 years' experience; fine set of tools; equally good on American or Swiss watches; fine pivoter; salary, \$25 per week; western States preferred; no objection to small town. "R., 6666," care Jewelers' Circular-Weekly.

AT ONCE; first change; \$30 per week can get a first class all around man; watchmaker, jeweler, engraver, plain, fancy and ornamental monograms, old English stone setter, etc.; hours, 8 to 6; go anywhere, prefer south or west; others needn't answer. T. Lambert, General Delivery, Birmingham, Ala.

FIRST CLASS jeweler and engraver wants position; can do all kinds of jewelry repairing, stone setting, letter and monogram engraving, make pierced monograms; own all tools; sober; Philadelphia, Baltimore, Washington or vicinity; inquiries answered. "L. A. S., 6782," care Jewelers' Circular-Weekly.

## Side Lines Wanted.

TRAVELING diamond merchant, with years of experience west of Mississippi, and A1 references, wishes sample lines from capable manufacturers of mountings and kindred goods. Address S. H. F., care S. Cohn & Co., 9 Maiden Lane, New York.

## Help Wanted.

WANTED, a clockmaker. F. V. Lindon, 62 Bond St., Brooklyn, N. Y.

JEWELER WANTED. Apply 9 Province St., one flight up, Boston, Mass.

ORDER CLERK in wholesale department. Apply Clemens Oskamp Co., Cincinnati, O.

WATCHMAKER and engraver for permanent position, at once. James Mix, Albany, N. Y.

FINE ENGRAVER and jewelry repairer; easy work; good salary; permanent position. W. H. Mortimer, Pottsville, Pa.

WANTED, two first class jewelry and silverware salesmen, for retail trade. Apply to Duhme Jewelry Co., Cincinnati, O.

YOUNG LADY wanted to take care of stock and make herself generally useful. L. S. Meyer & Bro., 38 Maiden Lane, New York.

A STEADY and well paying position awaits a practical watchmaker, with A1 references. Levy's, 483 Main St., Buffalo, N. Y.

WANTED, experienced salesman for established line of cut glass in New England and Middle West. Address Box 774 J, Corning, N. Y.

AT ONCE, a good engraver, clock and jewelry repairer; steady position to a good man. Address "J., 6367," care Jewelers' Circular-Weekly.

EXPERIENCED young lady to assort stones and to take charge of repair department. Untermeyer-Robbins Co., 38 Ferry St., New York.

SETTER WANTED, permanent position; give references, experience, age and salary in first letter. M. E. Nalstedt & Sons Co., Davenport, Ia.

WANTED, AT ONCE, a watch and clock repairer; an all around man in retail store; good wages. "A. P. S., 6762," care Jewelers' Circular-Weekly.

WANTED, jewelry repairer, engraver and optician; send samples of engraving, with particulars and salary wanted. W. H. Paekard, Uhrichsville, O.

WANTED, a good watchmaker who can engrave; good position for a first class man; address with references. Sylvester Engle, 16 West Broad St., Hazleton, Pa.

WANTED, diamond mounters and setters, jobbing jewelers; permanent positions, good wages. E. Maritz Jewelry Mfg. Co., 217 N. St., St. Louis, Mo.

WANTED, second watchmaker and repair man salary, \$15 per week; steady position; send photograph and reference. Address Box 1, Charleston, W. Va.

DIAMOND SETTER and jeweler or watchmaker wanting snap and permanent position, with stating lowest salary, at once. Sipe, Moo Bldg., Buffalo, N. Y.

DESIGNER, one experienced in silver business on hollow ware; state experience, salary expected, etc. T. F. Tuttle Silver Co., 387 W. ington St., Boston, Mass.

WANTED, AT ONCE, experienced salesman the road; must understand the diamond, precious and imitation stone business. R. A. Breidenbach, 51-53 Maiden Lane, New York.

COLORER, first class gilder on fine gold jewelry must know how to make solution; good position for the right party. Address "Good Wa 6763," care Jewelers' Circular-Weekly.

WANTED, a good letter engraver who also understands repairing watches and clocks; permanent position to first class man. Address "6672," care Jewelers' Circular-Weekly.

WANTED, young man with five or six years' experience in manufacturing jewelry shop; must be good jobber and be able to do some new work. Address E. C. Harpstrite, Wichita, Kans.

WANTED, jeweler, engraver and assistant watchmaker, capable to wait on trade; must be recommended; steady position for the right man. Address Jesse Davidson, Montgomery, Ala.

WANTED, WATCHMAKER, must be good salesman; experienced; salary based upon ability. Jules Asheim, 37 Maiden Lane, New York; Southern Loan and Jewelry Co., Tampa, Fla.

EXPERIENCED watchmaker and engraver, jeweler and watchmaker; no novice; good position; western Pennsylvania; send references. "Penn, 6773," care Jewelers' Circular-Weekly.

WANTED, WATCHMAKER, good engraver salesman; send sample of engraving; state years of store experience and salary expected town 5,000. Ed. J. Niewohner, Columbus, Ne

WANTED, good combination watchmaker, engraver and salesman; wages \$22 weekly; permanent; hours, 8 to 6; all particulars and references in first letter. T. W. Morrison, Newbu N. Y.

YOUNG MAN to do clock and jewelry repair and take charge of stock; state age, experience and salary expected; references required. Address "Connecticut, 6789," care Jewelers' Circular-Weekly.

SALESMAN, commission or as side line, for very high grade line of novelties for the far west, New York, State and Pennsylvania. full particulars. "Sterling, 6744," care Jewelers' Circular-Weekly.

WANTED, first class watchmaker of good address, who can assist as salesman; New York experience; permanent position to right man; references required. "New York, 6665," care Jewelers' Circular-Weekly.

WANTED, AT ONCE, a good watchmaker engraver, or a good jeweler and engraver; permanent position; good salary; references required; send sample of engraving. E. F. J. man, Norfolk, Va.

WANTED, WATCHMAKER on Swiss and American watches, also plain engraving; good permanent position; required, first class references, also tools. T. Neafach, 336 Washington St., Johnstown, Pa.

WANTED, girls to lay out orders and make themselves generally useful in a wholesale jewelry house; only those with experience in the jewelry business need apply. Fred Kaufman & Co., Broadway, New York.

A FIRST CLASS ENGRAVER; one who can do all kinds of lettering and monogram engraving can use a good steady man at a good salary. Apply to A. Newsalt, Jeweler, cor. Fourth Main Sts., Dayton, O.

FIRST CLASS watchmaker and optician wanted; good opportunity offered to right party; steady position; in one of the large cities in Pennsylvania; write at once. L. W. Rubenstein, 4 Maiden Lane, New York.

**HELP WANTED.—Continued.**

**WANTED, AT ONCE, A1, practical monogram** general engraver, for a first class retail store, in a city of 30,000; send samples, references and particulars at once. "Engraver, 6771," care Jewelers' Circular-Weekly.

**WANTED, a first class watchmaker and a good** around man for retail store, at once; first class job for good man; send reference; job will pay \$18 to \$20 per week to start. Meyer & Chamber, Meridian, Miss.

**I WANT to communicate with a first class gold,** silver, nickel and brass plater; none but one who understands the trade thoroughly should reply; good opportunity. Address "Plater, 6768," care Jewelers' Circular-Weekly.

**YOUNG LADY in office of jewelry factory; must** thoroughly experienced and competent to set stones and coral; highly recommended; address, stating reference, experience, etc. Kling Baer, 84 Fulton St., New York.

**WANTED, salesman with established route in the** north, to take line of sterling silver on commission basis, in connection with non-conflicting lines; must furnish first class references. "Silver, 6770," care Jewelers' Circular-Weekly.

**FIRST CLASS watchmaker for American** house, in New York. Address "Permanent, 6784," care Jewelers' Circular-Weekly.

**JEWELRY REPAIRER and stone setter** for American house, in New York. Address, "Permanent, 6785," care Jewelers' Circular-Weekly.

**WANTED, WATCHMAKER and engraver to assist** in selling; also jeweler and engraver; permanent position to right man; send samples of engraving and reference in first letter; state salary. Ike Kronberg, 416 Main St., Little Rock, Ark.

**WANTED, a first class optician; one who under-**stands edge grinding preferred; steady employment and good wages to the right man; must be well recommended. Address "Central Spectacle, 6640," care Jewelers' Circular-Weekly.

**WANTED, to go south, a first class jeweler and** diamond setter; must be a good salesman; one who can take charge of jewelry department; good salary and commission on sales to the right party. "Up-to-date, 6786," care Jewelers' Circular-Weekly.

**AT ONCE, A1 watchmaker; one who is capable of** doing fine charge of railroad watches; also must do engraving; none but first class men need apply; reference with first letter; will pay \$20 per week to the right man. Address Gorman & Green, Salisbury, N. C.

**WANTED, first class optician and watchmaker;** ready position; \$35 per week and will increase if competent; send reference, age, etc.; dwarfs need apply; have dark room and latest proved optical instruments. Geo. F. Blakeslee, Tonopah, Nev.

**RESPONSIBLE TRAVELERS to take our line,** consisting of fine Elk and gold jewelry, south-west and New England, also large and small cities in the entire west, as a side line on a commission basis; state territory. Schieckling Mfg. Co., 31 E. 31st St., New York.

**WATCHMAKER WANTED; a young man who** has learned the trade, to take a place in a store; one who can assist as salesman and make himself generally agreeable and useful; store near Maiden Lane, New York; a good future for the right young man. Write to "X. Y. Z., 6746," care Jewelers' Circular-Weekly.

**WANTED, strictly first class combination man** (watchmaker, jeweler and engraver); must be sober and well recommended; good salary and permanent position to good man; must be a willing worker, rapid and very thorough; state salary expected and send sample engraving in first letter, to Messrs. Van Auken & Co., 516 Pearl St., Beaumont, Tex.

**FIRST CLASS WATCHMAKER, engraver and** jeweler; good salesman; some knowledge of optics; must be able to assume full charge at times; permanent position; sample of engraving and full particulars in first letter; save stamps and time if not competent; \$20 per week; own watchmaker's tools. J. W. Campbell, 906 State St., Bowling Green, Ky.

**WANTED WATCHMAKER; Abraham** & Straus, Brooklyn, can place in a permanent position at liberal salary a competent man who thoroughly understands watch repairing in all its details. Apply to Superintendent.

**WANTED first class diamond and** precious stone salesman, one who has experience with southern and western trade; excellent opportunity for a hustler; good salary and commission; answer by letter, stating experience, etc.; communications confidential. "C., 6690," care Jewelers' Circular-Weekly.

**WANTED AN ARTIST with expert** knowledge of enameling to take full charge of small plant, for special work in artistically designed enameled jewelry and hollowware; address stating qualifications and particulars as to experience and ability; terms made satisfactory to right party. "W. E. T., 6724," care Jewelers' Circular-Weekly.

**WANTED, AUGUST 1, high grade sales-**man for well known manufacturer's line, of Providence, R. I., territory middle and western states; must have acquaintance with large department stores and leading retailers in large cities; to a young man of good address and who is aggressive and successful, with unexceptional references, a good position is open; state experience, age and salary expected. Address, "Permanent, 6590," care Jewelers' Circular-Weekly.

**Business Opportunities.**

**FOR SALE, old established jewelry store, Brook-**lyn, N. Y. Inquire E. Dreyer, Watch Materials, 75 Nassau St., New York.

**JEWELRY BUSINESS for sale; are you looking** for an A1 business opportunity; it will pay you to investigate; stocks, fixtures and building about \$6,000; good reason for selling. "H., 6759," care Jewelers' Circular-Weekly.

**A COMPLETE up-to-date plant for man-**ufacturing silverware, metal goods and clocks is offered at great sacrifice; power and hydraulic presses, drop hammers, lathes, moulds, etc., must sell to close estate. Lesser Bros., attorneys, 299 Broadway, New York.

**QUICK ACTION by corresponding with** us; we buy your entire stock; or send us your surplus stock of watches and diamonds; we originated this method and have twenty years of quick action and good service to our credit. Joseph Brown & Co., Fifth Ave. and Madison St., Chicago, Ill.

**DO YOU WISH TO RETIRE? We buy** jewelry stores to any amount; also entire stocks of jewelry, diamonds, watches, silverware, fixtures, etc.; we are known all over the United States to pay highest spot cash; notify us, we will call on you at once; all business transacted we handle strictly confidential. Address Brooklyn Purchasing Syndicate, 608 Broadway, Brooklyn, N. Y., or Tel. 2328, Williamsburg.

**For Sale.**

**AT 50 CENTS ON THE DOLLAR, a lot of** bracelets, long chains, set tie pins, chatelaine pins, hair barrettes, hatpins, scarfpins, necklaces; prices, 75 cents to \$3.75 dozen, less 10 per cent. for cash; goods were manufactured for a jobber who failed; selection packages sent to well rated jewelers. Dan I. Murray, Broker, 3 Maiden Lane, New York.

**AT 25 per cent. to 40 per cent. less than regular** price, a job lot of real amber necklaces, fine cut jet brooches, jewel necklaces, French pearl necklaces and cut crystal hat-pins, all of German and French manufacture; must be sold at once; price, \$1.25 per dozen up to \$60 dozen, less 5 per cent. 10 days, net 30 days; selection packages on memorandum to well rated dealers; any one lot if you want ambers and jets at cut prices; be quick or you will regret it. Dan I. Murray, Importer, Broker, 3 Maiden Lane, New York.

**To Let.**

**DESK ROOM or part of office to let. 3 Maiden** Lane, Room 53, New York.

**WILL RENT to desirable party, desk room with** office privileges, in light, attractive office; manufacturer's representative or diamond dealer preferred. "Maiden Lane, 6775," care Jewelers' Circular-Weekly.

**Wanted to Purchase.**

**WANTED, a second hand Webster-Whitcomb** lathe, must be in good condition, with or without chucks, for cash. Address Kurt Arnold, 1004 E. Market St., Akron, O.

**Lost.**

**WANTED, INFORMATION, leading to location** of open face Elgin, gold watch, monogram H. L. T. on back; probably left for repairs about November, 1905. J. F. Newman, 11 John St., New York.

**Miscellaneous.**

**SOMETHING entirely new in the line of window** decoration; send five two-cent stamps for sample and postage. Address The Window Exhibitor Co., 74 Cortlandt St., New York.

**TO LET.****Three Desirable Light Lofts**

**At 31 MAIDEN LANE, N. Y.,**

One door from Nassau St. Prominent location, center of jewelry district. Address F. J. Whiton, 130 Broadway, New York; or, your own broker.

**"PRACTICAL COURSE**

**IN**

**ADJUSTING."**

**PRICE \$2.50.**

**ALL JOBBERS OR**

**JEWELERS' CIRCULAR PUBLISHING CO.**

**TRADE-MARKS**

**OF THE**

**JEWELRY and KINDRED TRADES,**

**PRICE \$3.00.**

**THE JEWELERS' CIRCULAR PUB. CO.,**  
11 John St., Cor. Broadway, New York.



## L. W. Levy & Co.

Leather Goods,  
Novelties of all  
Sorts, Metal,  
Glass, China,  
Gun Metal, etc.

580-582 Broadway  
New York City

Real Seal Bags with  
inside purse, size of bag  
8 X 6 inches, retails at  
\$5.00

# DIAMONDS

Complete Stock—Right Prices

NOUGH SAID

WM. I. ROSENFELD

19 Maiden Lane

NEW YORK

Telephone 4115 Cortland.

**LEO GOLDSMITH**

IMPORTER OF

**DIAMONDS AND PRECIOUS STONES**

Headquarters for RECONSTRUCTED RUBIES and SAPPHIRES. All Sizes and Forms.  
9-13 MAIDEN LANE, NEW YORK

## Trade-Marks of the Jewelry and Kindred Trades.

Second Edition. Over 4,000 Marks.

Price, \$3.00.

THE JEWELERS' CIRCULAR PUBLISHING CO., 11 John St., New York.

## Is There Anything You Don't Know About Optics?

If there is, you can find out all about that anything, in a few minutes, by consulting the

### ENCYCLOPEDIA-DICTIONARY and REFERENCE HANDBOOK of the OPHTHALMIC SCIENCES

By R. H. KNOWLES, M. D.

which gives in complete and accurate statement, and in alphabetical order, the Orthography, Pronunciation, Definition and Etymology of All the Words and Terms used in the Ophthalmic Sciences.

### Complete Library of Optics in One Volume

A Thorough Exposition of the Principles of Refraction, and the use of the various instruments employed in measuring defects of vision.

**Price, \$2.50**

in Substantial Cloth Binding.

Published by

**The Jewelers' Circular Publishing  
Company**

11 John St., cor. Broadway  
New York



## Philadelphia.

R. Boite, 1801 Market St., has returned from a trip to Niagara Falls.

George Stoll, Lebanon, is complaining the loss of a valuable English bulldog. Max Einhorn, of M. Sickles & Sons, on Sunday at Anglesea, N. J., fishing. J. S. Fitch, Shamokin, returned, last week, to business after a four weeks' illness.

B. Wallem, Camden, N. J., has returned from a short vacation to Wildwood.

John Geist and David Gutkunst, of J. Bechtel & Co., have departed on their vacations.

John Smyth, formerly of 1711 South St., has opened his new retail store at 521 and Baltimore Ave.

J. T. Whaler, Miami, Fla., was in Philadelphia last week purchasing goods to the store which he is about to open on Narragansett Pier, R. I.

The widow of Malcolm Graham, who died about a year ago, and who formerly conducted a store on N. Front St., was married last week to a neighboring druggist.

Charles Schwartz, formerly a retailer on Chestnut St., near Chestnut St., but who for the past two years has been in the south, has returned to this city, and will probably open a jewelry store here.

Out-of-town retailers buying of the local wholesale trade last week included C. F. John, Cape May, N. J.; D. H. Krause, North Wales, Pa.; George Ware, Atlantic City, M. Friedberg, Atlantic City, and S. Hart, Kennett Square.

Thomas Campbell, western salesman for M. Sickles & Sons, has resigned his position to go with the Koshland & Italie Co. Mr. Campbell is well known in the trade, before going to M. Sickles & Sons was with the B. F. Williams Co.

H. Gantt, of Wm. H. Gantt & Son, Newport, Pa., is making extensive alterations and additions to his store and remodeling it along the latest lines. Mr. Gantt was in this city last week arranging the details of the renovation of his store.

A. J. Le Jambre, William Williams and Jacob Mann were among those who attended the funeral services Thursday over the body of Jacob F. Henderson. Mr. Henderson was especially well known to jewelers, whom he has entertained often and well on occasions of their festive celebrations.

Walter Hazelton, with Charles H. Bryon, 735 Sansom St., was made the victim of a clever practical joke at the jewelers' Club vaudeville show last week, when from the stage it was stentoriously announced that he was urgently wanted at home. This announcement came officially first as Mr. Hazelton was enjoying himself most, but as might have been expected from a man married and with a family he departed at once for home only to find that it was all a hoax.

The officers of the Koshland & Italie Co., the new corporation which succeeded the partnership of Koshland & Italie, the successors of Wm. Morris & Co., are: Charles Koshland, president; Bernard Italie, secretary and treasurer, and George E. Donald-

son, director. Mr. Koshland, the president, started, just nine years ago, with the late firm of Wm. Morris & Co., and Mr. Italie started 12 years ago with the same house; both were admitted to the firm exactly five years ago. Mr. Donaldson was with the late concern for eight years.

Simons, Bro. & Co.'s baseball nine administered last week the first defeat to the nine representing M. Sickles & Sons. The score was 5 to 1 in favor of the Simons' representatives. M. Sickles & Sons struggled hard for victory, appreciating that upon the result of this match depended largely the championship of the wholesale trade. The game was played at North Cramers' Hill, N. J., but since this is the first game the house of Simons has won this season the nine of M. Sickles & Sons proposes to continue playing other nines until its reputation is re-established. Then a return game may be sought with the team of Simons, Bro. & Co. The nine of M. Sickles & Sons met the one of L. P. White Saturday, at Logan, and Simons, Bro. & Co.'s team have yet to meet teams defeated by the nine of M. Sickles & Sons.

## Lancaster, Pa.

M. Dattelbaum, of Dattelbaum & Friedman, visited this city last week.

John J. Bowman, of Ezra F. Bowman's Sons, visited Philadelphia last week.

F. A. Peters, of the H. S. Meiskey Co., is home from a trip through central Pennsylvania.

A. F. Huchler, missionary for the Hamilton Watch Co., has gone to his home in Wilkes-Barre on his vacation.

At last week's High School Alumni Association reunion and reception John B. Roth, Jr., conducted the instrumental musical exercises.

Among the jewelers visiting here last week were F. H. Ewald, Coatesville; E. P. Zane, Ephrata; J. H. Andrews, Strasburg; J. H. Sensenig, New Holland; C. E. Hinkle, Ephrata.

W. E. Dudley, who came to the Hamilton Watch Co.'s factory last March from South Bend, Ind., to prepare for the manufacture of an O-sized movement, has been made assistant superintendent of the Hamilton factory.

Alfred W. Moyer, manager of the Non-Retailing Co., and Milo B. Herr, secretary of the company, with their wives, returned home last week from a four weeks' trip to the West, on which they visited Chicago, Milwaukee, Denver, Colorado Springs, Pike's Peak and the Yellowstone Park, the Great Lakes, Buffalo and Niagara Falls.

The jewelers of Haverhill, Mass., have decided to close their stores, Mondays, at 6 p. m. and on Wednesdays at 12 m., during the months of July and August and in September until the 12th inclusive.

The business heretofore conducted in Fresno, Cal., at 1119 J St., in the name of H. B. Oberlin, was recently changed to the name of Oberlin Bros., consisting of H. B. Oberlin and C. S. Oberlin, who are equal partners therein, and who are each liable as partners for all indebtedness against the business heretofore conducted by H. B. Oberlin.

## Pittsburg.

P. C. Gillespie, of Gillespie Bros., sails July 16 for Europe. He will be gone two months.

Unless something unforeseen happens, E. P. Roberts & Sons expect to begin moving into their new store this week.

Harry Heeren is taking a leading part in the ball of the Washington Infantry, to be given at Luna Park, early next month.

W. R. Hill, Fayette City; P. J. Manson, Jeannette; J. F. Murphy, Dawson; Frank Bloser, New Kensington, were among the out-of-town merchants who visited Pittsburg last week.

J. R. Reed & Co. will next week begin their semi-annual inspection of the watches of the Pennsylvania Railroad lines west of Pittsburg. The inspection will require several weeks, as hundreds of watches will be examined.

Ira E. Reidenbach, 205 Federal St., Allegheny, in the suit against the Burgess and the Town Council of Ben Avon, where he lives, has secured an injunction against them, restraining the defendants from removing trees in front of his property.

Miss Esther M. Keggler, employed at Gillespie Bros., celebrated her birthday last Saturday, and in honor of the occasion she was presented with a candy cane, six feet in length, it having been ordered especially for the occasion by the clerks in the store.

W. J. Johnston, of the W. J. Johnston Co., who has been in Washington for some time, attending the sessions of Congress and listening to the debate in the House of Representatives, regarding the alleged watch combination, has returned to Pittsburg.

The Merchants and Manufacturers' Association and the Chamber of Commerce gave a joint dinner last week at the Hotel Annex, which was attended by 400 business men, some of whom were local jewelers. The dinner was held in the interest of improving local waterways. A number of visiting Congressmen were present.

Sam F. Sipe, last week, nearly lost a \$2,500 diamond ring, which had been thoughtlessly taken by a customer, who put the ring in his pocket and walked out of the store. Mr. Sipe did not discover that the ring was missing until the man had gone several minutes, and then there was a hasty chase to bring him back. The customer had called at the store to exchange a ring with one stone for one with three gems, and was in a big hurry. The bargain, for this reason, was not struck. The man laid his ring on the counter and put the three-stone ring in his pocket, and Mr. Sipe put the one-stone ring in the case. When he discovered it was missing, he sent his own son after the man, who was found a half block away. The man returned, asked what was wanted, and Mr. Sipe told him he had a \$2,500 ring which he desired. The man appeared to be greatly surprised and, after feeling in his pocket, handed it over. Mr. Sipe is, however, satisfied that the man was not attempting to steal it, "but still I feel better satisfied with the ring in the case," said Mr. Sipe.

Mr. Gates, formerly of St. Louis, Mo., has taken charge of the jewelry department of F. H. Merritt & Co., Milford, Ia.



# Bigalke & Eckert Co.

IMPORTERS OF WATCHES,

No. 1 MAIDEN LANE, NEW YORK

Single and Split Second Timers in Nickel and Gun Metal Cases.

Complete Assortment of Chronographs,  
Split Seconds and Minute Repeaters.

Ladies' and Gentlemen's Flat and Ultra Flat Watches.

SOLE AGENTS FOR

**Haus, Neveux & Cie.**

FINE GENEVA WATCHES.



## The Jewelers' League of New York

12 JOHN STREET

Organized 1877

Reserve fund, January 1st, 1906 - \$304,408.78

Paid for deaths since organization - \$3,134,487.38

### Board of Officers, 1906

President,

GEORGE W. STREET.

Vice-Presidents,

BERNARD KARSCH,

M. J. LISSAUER,

JOHN R. GREASON,

O. G. FESSENDEN.

Secretary and Treasurer,

F. A. Marsellus, 12 John St.

Executive Committee.

Leo Wormser, A. K. Sloan, W. T. Gough, G. W. Mindil, G. H. Hodenpyl,  
D. N. Smith.

Advisory Committee.

Sammel H. Levy, C. C. Offerman, W. E. Moutoux, Sr., L. Witsenhausen, J. B.

Wood, Wm. Barthman, S. B. Mann, T. L. Parker, O. M. Farrand,

G. W. Parks, F. L. Wood, S. A. Baldwin, R. A. Breidenbach,

H. Freund, E. B. Eaton, F. H. Dana, S. B. Kent,

Morris Lissauer.

Examining Finance Committee.

R. A. Breidenbach, Andrew McLeod, John R. Greason, Jr.

The new schedule of rates offers maximum insurance at minimum cost—monthly payments make it convenient to carry.

Death benefits, \$1000.00 to \$5000.00

Age limit, 21 to 44 years, inclusive

This organization has never had occasion to contest any claim

## Practical Course in Adjusting

By THEO. GRIBI.

COMPRISING

A review of the laws governing the motion of the balance and balance spring in watches and chronometers, and application of the principles deduced therefrom in the correction of variations of rate arising from want of isochronism, change of position and variation of temperature.

ELUCIDATED AND DEMONSTRATED

by original experimental researches in the actual problem, never before published, showing the causes that are operative in the variation of rate, and leading to correct remedies. To which have been added chapters on

How to make a Balance Arbor with Modern Appliances; How to Clean a Watch Properly; and, the Lever Escapement—Some Current Defects in it and How to Remedy Them.

PRICE, \$2.50.

250 pages, including 18 diagram plates; Fine Paper; Large Type; Clear Illustrations; Systematically arranged; Solid Binding.

THE JEWELERS' CIRCULAR PUB. CO.  
Publishers

11 John St., cor. Broadway, New York.

# PATENT DEPARTMENT

WHICH IS CONTAINED A LIST OF THE LATEST PATENTS GRANTED BY THE UNITED STATES AND GREAT BRITAIN, THE UNITED STATES PATENTS THAT HAVE BEEN AND THE REGISTERED TRADE-MARKS.

## UNITED STATES PATENTS.

ISSUE OF JUNE 19, 1906.

**503. STEM-WINDING WATCH.** NUMA BEGUELIN, Solathurn, Switzerland. Filed Sept. 16, 1904. Serial No. 224,704.  
winding and hand-setting mechanism for watches comprising a longitudinally-movable operating stem, a pinion rotatable by the said stem, a series of gear-wheels driven by the said pinion,

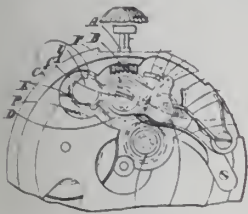

rotated lever carrying said gear-wheels, spring-winding mechanism and hand-setting mechanism adapted to be engaged respectively by said gear-wheels in accordance with the position of the said lever, a second pivoted lever actuated by said operating-stem, two projections on said lever, one of which is adapted to engage the side of the first lever, a spring acting upon the other projection of the second spring acting in the opposite direction against the side of the said first lever.

**517. SAFETY-LOCK FOR BROOCHES, SCARF-PINS AND THE LIKE.** FREDERICK DRISLER, New York. Filed Aug. 26, 1905. Serial No. 275,869.

a device of the class described, a loop-shaped hook member open at one side and adapted to receive the pointed end of a pin, a locking-arm pivoted in the base of the hook member by means



of a shank connected therewith and passing through the base, said shank being provided on the side of the base of the hook member opposite the locking-arm with a locking-finger adapted to be thrown into approximate engagement with the end of the hook member so as to complete the loop formed thereby, and means whereby the locking-arm may be engaged with the hook member when said arm and finger are in their operative positions.

**555. COMB-FASTENER.** GEORGE H. SMITH and JACOB STIEGLITZ, Yonkers, N. Y. Filed Feb. 18, 1905. Serial No. 246,353.  
An improved comb herein described having a pivot between the ends thereof, near the



edge and movable in a plane parallel with the plane of the series of comb-teeth, said hook comprising a finger-piece or part movable therewith in a parallel plane and adapted to lie either at the back in parallel relation therewith or to project above said edge.

**570. TEA STRAINER AND INFUSER.** FRANCIS N. DENISON, Victoria, Can. Filed April 21, 1905. Serial No. 256,762.  
A tea infuser and strainer, the combination

with the pot and the lid having an opening therein, of a perforated tea-receptacle and a divided stem having a lower portion connected to the receptacle

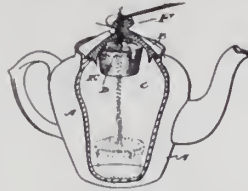

and an upper lifting portion pivotally connected to the lower portion and having lateral resiliency.  
**823,682. SYNCHRONIZING MECHANISM FOR TIMEPIECES.** AUGUSTUS L. HAIL, Chicago. Filed Sept. 26, 1903. Serial No. 174,777.

The combination with a timepiece, of an escapement comprising an escape-wheel fixed upon the seconds-hand shaft and a co-operating anchor, an axially-movable shaft upon which the anchor is mounted, a radial finger fixed upon the seconds-

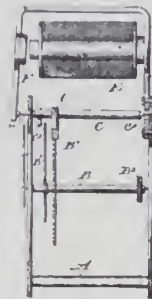

hand shaft, a pin fixed upon the anchor-shaft, and means for axially moving said anchor-shaft and thereby locating the anchor in a plane out of the path of movement of the escape-wheel and simultaneously locating the fixed pin on the anchor-shaft in the path of the movement of the radial finger on the seconds-hand shaft.

**823,704. NAPKIN-HOLDER.** JAMES SIMPSON, Crookston, Minn. Filed March 9, 1905. Serial No. 249,313.

The herein-described napkin-holder made of a single piece of resilient wire doubled to form a hook having a downwardly-directed bill, vertical spaced portions 6 at the inner end of the bill, lateral oppositely-extending jaws 3 having the



inner side portions 7 bent outwardly from the lower ends of the portions 6 and extending at right angles to said portions 6 and the outer side portions 8 bent reversely with reference to and converging inwardly toward and coming in contact with the sides 7, and the outwardly-curved finger-piece 4 connecting the ends of the outer side portions 8 of said jaws.

**823,743. SAFETY ATTACHMENT FOR SCARF-PINS.** ELIAS L. SCHREIBER, New York, assignor of one-half to DENIZEN H. PHILLIPS, New York. Filed Dec. 5, 1905. Serial No. 290,344.

A safety-attachment for scarf and other pins, comprising a screw provided with a head having transversely therethrough an opening through



which the pin may be passed, and a nut mounted on said screw and provided at one side with a projection or hub member having a recess adapted to receive a part of the head of the screw, the rim of the projection or hub member being adapted to bear on the pin.

**823,778. DISPLAY-CHEST FOR SILVERWARE, ETC.** EMIL HERBECK, Philadelphia, Pa. Filed Jan. 10, 1906. Serial No. 295,381.  
A chest having a body, a lid and a swinging tray.

one of the walls of said body having an upward

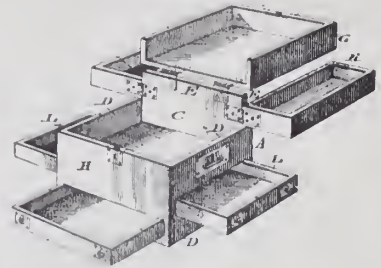

extension and said swinging tray being pivotally connected with the side of said extension.

**823,798. DESK UTENSIL.** JOSEPH N. MAINGOT, Trinidad, British West Indies. Filed Oct. 3, 1905. Serial No. 281,163.

An article of the kind described comprising a tubular casing forming a handle, said casing having two compartments at the ends thereof and

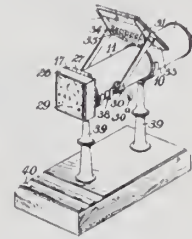

being separable at a point below the upper compartment, an absorbent pad at the end of one compartment, and means as the perforated spring-pressed disks adapted to turn in relation to each other for regulating the flow to said pad.

**823,894. INTERMITTENT-ALARM CLOCK.** WILSON E. PORTER, New Haven, Conn., assignor to the New Haven Clock Co., New

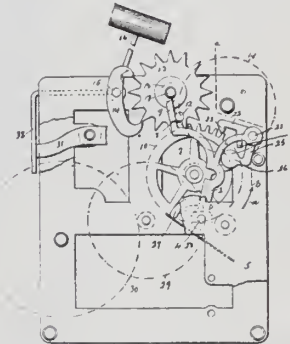

Haven, Conn. Filed Jan. 8, 1906. Serial No. 295,067.

In an intermittent-alarm clock, the combination with a wheel of the alarm-train, of a pin carried thereby, a vibratory alarm-lever having a stop-finger for engagement by the said pin, a coupling-hook carried by the said lever, and a wheel of the time-train engaged by the said hook, whereby the lever is coupled with the said wheel.

**823,905. SAFETY-PIN.** JOHN C. TRAILL, Malvern, Victoria, Australia. Filed June 26, 1905. Serial No. 267,065.

A double safety-pin formed of a single piece of wire bent upon itself to form a central pocket portion and having its extremities extended into opposite pin portions, the free ends or points of



the pin portions being directed toward the pocket portion and adapted to be engaged therewith and be closed thereby, and the wire in each of the two pin portions being bent one and a half times to form springs H, H, at that end of the pin portion farthest removed from the pin-point.

**823,975. DEVICE FOR FILLING FOUNTAIN-PENS.** HARRY B. SMITH, Janesville, Wis. Filed Aug. 7, 1905. Serial No. 273,073.

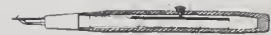

In a fountain-pen, the combination with a handle inclosing a laterally-compressible ink-reservoir

# THE WESTERN CLOCK MFG. CO.

Sole Makers of the "America" Alarm

NEW YORK  
51 Maiden Lane

La Salle,

Illinois.

CHICAGO  
131 Wabash Ave.



## THE ALTERNATING

Rings and stops alternately for 15 minutes at intervals of 20 seconds.

**T**HE ALTERNATING is the clock you have all been waiting for; a good reliable low-priced intermittent alarm. The movement is SIMPLICITY itself—no extra wheels, nothing to get out of order, and all the advantages of the Western Casting Process: FRICTION-LESS Pivots, SELF-CENTERED Wheels, HARD-STEEL PALLET Escapement.

4½-inch dial

7 inches high

75c. net

AT YOUR JOBBER

provided with a pen-point and a lateral opening a compressible strip located within the handle having a threaded stem projected through the lateral opening thereof, and a pressure-knob mounted upon the projecting end of the stem to serve as a clamp-nut, or an adjustable stop and a pressure-piece according to the position of the knob in reference to the handle, threaded stem and compression-strip.

**4,023. CIGAR-CUTTING PAPER-KNIFE.** HENRY H. JAMES, New York. Filed Jan. 15, 1903. Serial No. 139,101.

a cigar-cutting paper-knife comprising a solid member composed of a single piece of metal having a longitudinal recess near one end, and an extended handle tapering outwardly at the opposite



a finger-pivoted in said recess having a notch at its forward end, a pressure-surface near said finger, a spring to hold said finger outwardly, and a latching-catch at one end of the recess to engage the finger when closed, said pressure-surface and latching-catch being disposed in position to be actuated by the holder's thumb; a side aperture communicating with said recess whereat to enter a cigar to be cut, and an exit-opening provided below the cutter.

**4,058. CONDIMENT-HOLDER.** WILLIAM J. BAIN, Pierce City, Mo. Filed Oct. 20, 1905. Serial No. 283,684.

a condiment-holder comprising a receptacle, a cover mounted to rotate therein, a removable de-

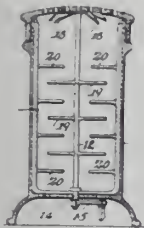

vice mounted within the receptacle, and inwardly-projected arms upon said device and adapted to operate with the beater.

**4,072. BRACELET.** THEODORE W. FOSTER, Providence, R. I. Filed Jan. 6, 1906. Serial No. 294,933.

a hinged bracelet, a concealed hinge comprising a member having a solid body portion at one end of which extends a central arm having an end in the concave face of which is a

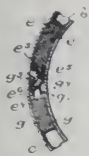

groove forming at one end a stop-shoulder, and a member having a solid body portion from which extend two side arms supporting a cross-bar having on its convex face a stamped-up stop-teat adapted to enter the groove and engage with the stop-shoulder in the first member to limit the opening movement of the hinge.

**4,073. BRACELET.** THEODORE W. FOSTER, Providence, R. I. Filed Jan. 6, 1906. Serial No. 294,934.

In a bracelet, a concealed hinge comprising two interlocking members each member having a solid end from which extends a rigid arm



extending away to form an arm having on its inner face a groove, a lip, a raised and a depressed portion intermediate the groove and the lip, and a ring side arm parallel with the central arm and forming an intermediate space.

**4,074. BRACELET.** THEODORE W. FOSTER, Providence, R. I. Filed Jan. 6, 1906. Serial No. 294,935.

In a bracelet, a concealed hinge comprising a member having a solid body portion from one end of which extends a central arm having a curved portion merging into a hook-shaped end, the inner concave face and the outer convex face of the curved portion being struck from a center which is concentric with the center on which the hinge opens, and a tubular member having a hollow body portion, an open end, a closed end in which



is a rectangular opening into which the central arm of the solid hinge member extends, and a stop-pin which extends across the inner concave face of the central arm on the solid member and is secured in the tubular member.

DESIGNS.

**38,087. BADGE.** DAVID L. Z. MERCHANT, Portsmouth, Va. Filed March 23, 1906. Serial



No. 307,725. Term of patent 3 1/2 years.

**38,090. BACK OF BRUSHES.** WILLIAM C. CODMAN, Providence, R. I., assignor to the Gor-

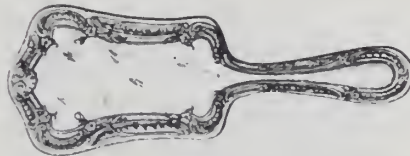

ham Mfg. Co., Providence, R. I. Filed May 16, 1906. Serial No. 317,250. Term of patent 14 years.

**38,091. BACK OF BRUSHES.** WILLIAM C. CODMAN, Providence, R. I., assignor to the Gorham Mfg. Co., Providence, R. I. Filed

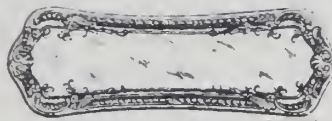

May 16, 1906. Serial No. 317,251. Term of patent 14 years.

**38,092. HANDLE OF SPOONS, FORKS, OR SIMILAR ARTICLES.** SIDNEY A. KELLER, New York, assignor to R. Blackinton & Co.,



North Attleboro, Mass. Filed May 16, 1906. Serial No. 317,249. Term of patent 7 years.

**38,093. TEAPOT OR SIMILAR ARTICLE.** MURRAY B. LEETE, Wallingford, Conn., assignor to R. Wallace & Sons Mfg. Co., Wal-



lingford, Conn. Filed May 9, 1906. Serial No. 316,041. Term of patent 14 years.

UNITED STATES TRADE-MARKS.

[The following trade-marks have been adjudged entitled to registration under the Act of Feb. 20, 1905, and are published by the Patent Office in compliance with Sec. 6, of said act, which provides: "Any person who believes he would be damaged by the registration of a mark may oppose the same by filing notice of opposition, stating the grounds therefor, in the Patent Office, within 30 days after the publication of the mark sought to be registered, which said notice of opposition shall be verified by the person filing the same before one of the officers mentioned in Sec. 2, of this act. If no notice of opposition is filed within said time the Commissioner shall issue a certificate of registration therefor, as hereinafter provided for."]

PUBLISHED JUNE 19, 1906.

SER. No. **2,323.** WATCH-DIALS AND WATCH-MOVEMENTS. RODE WATCH Co., New York. Filed April 20, 1905.

CHRONOSENTRY.

The arbitrary word "CHRONOSENTRY."

SER. No. **5,756.** OPERA-GLASSES. MERRY OPTICAL Co., Kansas City, Mo. Filed May 15, 1905.

DENISE

The word "DENISE."

SER. No. **5,757.** OPERA-GLASSES. MERRY OPTICAL Co., Kansas City, Mo. Filed May 15, 1905.

BADERE

The fanciful word, "BADERE."

SER. No. **5,762.** SPECTACLE AND EYEGGLASS FRAMES, MOUNTINGS AND LENSES. MERRY OPTICAL Co., Kansas City, Mo. Filed May 15, 1905.



The representation of a diamond-shaped figure.

SER. No. **6,838.** PEARLS, DIAMONDS AND OTHER PRECIOUS AND SEMI-PRECIOUS STONES MOUNTED AND UNMOUNTED. F. W. DROSTEN JEWELRY Co., St. Louis, Mo. Filed May 27, 1905.



The pictorial representation of a fleur-de-lis with the word "DROSTEN" printed on a scroll extending across the lower portion thereof and with the words "St. Louis" above the scroll. Below the fleur-de-lis are the words "THE DIAMOND CENTER OF THE LOUISIANA PURCHASE."

SER. No. **7,514.** LEATHER PURSES AND SATCHELS. A. & E. LEATHER GOODS Co., New York. Filed June 6, 1905.



The diphthong Æ in a circle.

SER. No. **10,263.** HAIR-BRUSHES, CLOTHING.



# Mr. Retailer:

**Do You Know** that some of the largest and finest stores are now carrying complete lines of French Jewelry? The success is pronounced, the profits great. Can we not interest you? We have opened a branch office in New York, where we carry a representative stock of the latest and newest designs in Parisian Jewelry.

**BACK and SIDE COMBS,  
BROOCHES,  
BRACELETS,  
HAT PINS,  
RINGS,  
STRING PEARLS, Etc.**

## CHOPARD FRÈRES,

Makers of French Jewelry Novelties,

49 Maiden Lane, New York.



No. 21, Cigar Jar, List \$12.50

## SALOSICO WARE WEATHERED OAK.

Silver Plated Trimmings and Linings.

Illustrations 1/4 size.



No. 112, Ice Tub, Removable Drainer, List \$10.00



No. 102, Loving Cup, \$10.50

Patented August 1st,  
1905.

**ST. LOUIS SILVER COMPANY,**  
St. Louis, U. S. A.

A COMPLETE LINE ON DISPLAY IN OUR NEW YORK  
OFFICE, 25 WEST BROADWAY.

# A NEW MOVEMENT

THE O-SIZE 7 JEWELLED PENDANT SETTING



## TAVANNES

Is Fully Guaranteed

FOR SALE THROUGH THE JOBBING TRADE

## TAVANNES WATCH COMPANY

2 & 4 Maiden Lane, New York

BRUSHES, HAT-BRUSHES AND BONENT-BRUSHES. JAMES E. BLAKE, Attleboro, Mass. Filed July 13, 1905.

**SterlinE**

The word "STERLIN E," the first and last letters of the word being capitals.

ER. No. 15,171. WATCHES AND CLOCKS. TIFFANY & Co., New York, N. Y. Filed Dec. 4, 1905. Used 10 years.

TIFFANY & Co

The word, character and abbreviation "TIFFANY Co."

ER. No. 18,778. WATCHES AND WATCH PARTS. THE HAMPTON WATCH CO., Canton, O. Filed April 13, 1906.

Upper Ten

The words "UPPER TEN."

TRADE-MARKS REGISTERED JUNE 19, 1906.

3,945. METAL-POLISH. AYLING BROS., Chicago.

The letters and character "B-K." Used 10 years. Filed April 28, 1905. Serial No. 3,431. Published April 24, 1906.

3,980. SPECTACLES AND EYEGLASSES AND PARTS THEREOF. SOUTHERN OPTICAL CO., Knoxville, Tenn.

The letters "S. O. Co." Filed March 15, 1906. Serial No. 17,908. Published April 24, 1906.

4,036. LEATHER PURSES AND HANDBAGS. GORHAM MFG. CO., Providence, R. I.

The word "GORHAM." Used 10 years. Filed March 7, 1906. Serial No. 17,029. Published April 24, 1906.

4,083. WATCH-MOVEMENTS. LOUIS MANHEIMER & BROS., Chicago.

The words "LOCOMOTIVE SPECIAL." Filed Nov. 17, 1905. Serial No. 14,766. Published April 24, 1906.

4,119. HOLLOW SILVERWARE. REED & BARTON, Taunton, Mass.

The compound word "GOLDYN-BRONZ." Filed Jan. 11, 1906. Serial No. 16,121. Published April 24, 1906.

4,162. TIME-REGISTERS. DEY TIME REGISTER CO., Syracuse, N. Y.

The word "DEY." Used 10 years. Filed Feb. 16, 1906. Serial No. 17,080. Published April 24, 1906.

4,163. TIME-REGISTERS. DEY TIME REGISTER CO., Syracuse, N. Y.

The word "DRUM." Used 10 years. Filed Feb. 16, 1906. Serial No. 17,081. Published April 24, 1906.

4,164. TIME-REGISTERS. DEY TIME REGISTER CO., Syracuse, N. Y.

The word "DRUMDIAL." Used 10 years. Filed Feb. 16, 1906. Serial No. 17,082. Published April 24, 1906.

4,165. TIME-REGISTERS. DEY TIME REGISTER CO., Syracuse, N. Y.

The word "DIAL." Used 10 years. Filed Feb. 16, 1906. Serial No. 17,083. Published April 24, 1906.

4,171. KNIVES AND RAZORS. EWALD KRUSIUS, New York.

The letters "K B." associated with the word EXTRA." Filed March 22, 1906. Serial No. 18,166. Published April 24, 1906.

4,172. CUT-GLASS ARTICLES. THE LIBBEY GLASS CO., Toledo, O.

The word "LIBBEY." Used 10 years. Filed Feb. 20, 1906. Serial No. 17,208. Published April 24, 1906.

4,179. WATCHES AND PARTS THEREOF. ADOLPHE SCHWOB, New York.

The monogram of letters "V W C." Filed July 12, 1905. Serial No. 10,172. Published April 24, 1906.

4,186. SILVER-PLATED FLAT WARE, HOLLOW WARE AND TABLE WARE. WM. A. ROGERS, LTD., New York.

The words "BUSTER BROWN." Filed March 1, 1906. Serial No. 17,439. Published April 24, 1906.

BRITISH PATENTS.

(ABRIDGMENTS OF SPECIFICATIONS, 1905, FROM THE Illustrated Official Journal.)

ISSUE OF JUNE 14, 1906.

2,790. CLOCKS. C. F. STAHLCKER, Newington, Middlesex. Feb. 10.

Striking-Mechanism; Chimes.—The main arbor *b* of the striking-train is prolonged beyond the rear plate, and carries the locking-wheel *c* and two pin-

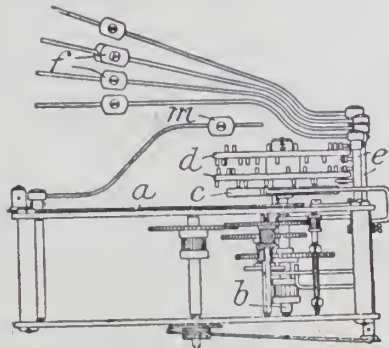

wheels *d*, which carry pins on each face for tripping the tails *e* of four hammers *f*. A lever *a* for operating the hour-hammer *m* is lifted and dropped by a pin on the locking-wheel.

2,975. MATCH STANDS. J. A. BRANDER, Sittertal, near Bischofzell, Switzerland. Feb. 13.

Match stands have bodies grooved for the reception of the matches, which are held in place by resilient plates, friction surfaces being placed between the plates and the matches, which are ignited on withdrawal. The matches *c*, Fig. 2, placed in the grooves *b* are held in place by steel plates *f* fixed to holders *h* mounted on longitudinal

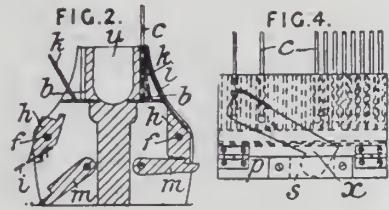

axles *f*, catches *m* being fixed to secure the holders in position. The paper *k*, provided with a friction surface, is held against the matches, and the recess *u* receives ash, cigar ends, and the like. In the modification, of which Fig. 4 is a back view, there is only one row of matches, and the steel plate is fixed to a support *p* hinged to the body of the stand and kept in position by a lug on the catch *x* fitting into a recess between the back of the support *p* and a plate *s* screwed to it. If desired, a cigar-cutter may be combined with the match stand.

3,046. BELTS FOR PERSONAL WEAR. F. SALMON, London. April 12.

The belt *a*, Fig. 1, having a buckle *b*, is threaded through slots *g*, *h*, *i*, *j* in the plates *c*, *d*, Figs. 3 and 4, and is fastened by means of pointed

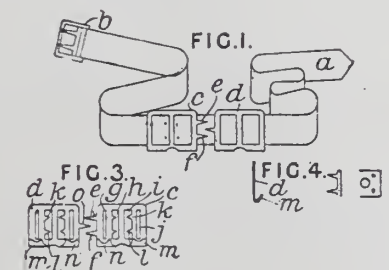

tongues *l*, *k* or by sewing. The plates *c*, *d* are provided with pins *e*, *f*, *o* to hold down the blouse or bodice, and with hooks *m*, *n* which engage the skirt-band and hold up the skirt. In a modification, the plates are sewn to the inside of the skirt-band, the hook being dispensed with.

3,052. UMBRELLAS, WALKING-STICKS, ETC. E. A. MITCHELL, Sussex. Feb. 14.

The sticks of umbrellas, parasols, sunshades and

the like are provided with detachable end-parts *c*, *d*, which are secured by the threaded tubes *e*



screwing upon the extensions *b*. Walking-sticks may be made similarly in three or more pieces.

[Reference has been directed under Patents Act, 1902, to Specification No. 21,147, A.D. 1894.]

3,059. CALENDARS. J. BALLANTYNE, Boston, Mass., U. S. Feb. 14.

In a clock-driven calendar, three annual dials carrying days of the month, months and days of the week are respectively connected to three gear-wheels, *a*, *b*, *c*, Fig. 2, by coaxial spindles. These gear-wheels have 31, 12 and 7 radial slots, separated by curved recesses, and are driven intermittently by pins on a clock-driven shaft *d* rotating once in 24 hours. The week-wheel *a* is driven directly from the clock-shaft, but the year and month wheel *b*, *c*, engage alternatively with pins 23 on a sleeve 25 which rotates with the shaft *d* but can slide along it. The month-wheel *c* carries an ear on each side, these ears 33, 34 engaging at different times with disk cams 31, 32 on the sliding sleeve 25, and throwing this sleeve into or out of engagement with the year-wheel *b*. A segmental flange 52 on the month-wheel prevents this from occurring prematurely. These fixed ears act for the months of 31 days. When the year-wheel *b* is being driven, a projection 29

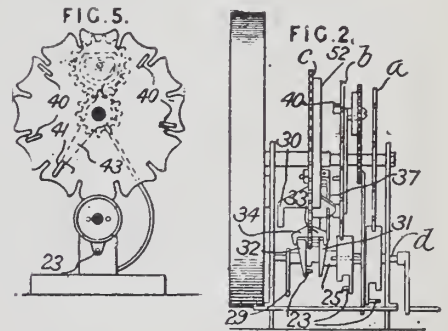

on the sleeve meets another projection 30 on the month-wheel *c* and moves this wheel forward until the first day of the month is indicated. For short months, a swinging ear 37 on the month-wheel *c* is provided, which is locked by a lug 40 on the year-wheel *b* at the end of each 30-day month, and acts like a fixed ear. For the month of February, a movable lug 41, Fig. 5, is provided on the year-wheel, this lug being attached to a lever 43 pivoted to the axle of the wheel. The other end of this lever 43 has a pin engaging in a cam-groove of a gear-wheel pivoted to the year-wheel and engaging a fixed central gear with a different number of teeth. By this arrangement, the movable lug is made to lock the swinging ear a day late every four years.

3,134. BRACELET FASTENINGS. T. WILCOX (trading as M. Wilcox & Son), Birmingham. Feb. 15.

A bracelet is fastened by means of a locket with



# At Last!

## KEY RING PROBLEM SOLVED!



Patented Key Ring, Silver, \$9.00 Doz.

The above key ring does the trick. You can put on and take off one dozen keys in less time than you could take one off any other make. We can also supply patent key rings in 10 and 14K. gold.

See our fall line before you place your order for Sterling Silver, Picture Frames, Card Cases, the new style Pocket Book, Toilet Ware, Manicure Articles, Buckles, Match Safes, Child's Cups and other hollow ware,

### PRYOR NOVELTY COMPANY

New York Office: 7 Maiden Lane

Factory and Office:  
473-475 Washington Street, Newark, N. J.

# If You Know the Marks

you are not confined to the limitations of your stock, but will be able to supply any goods desired. Frequently a resident of a town or city will return from a visit to a larger city, bringing back an attractive novelty or piece of jewelry that is greatly admired by her friends, who will probably want to obtain others like it. They will first call on the local jeweler and if he is not an up-to-date jeweler he will turn them away disappointed because he has not the articles in stock. If, however, he is a progressive dealer, he will examine the trade-mark on the article, identify the maker and send for a line on memorandum. He will tell his prospective customers that he has not the goods in stock just at present, but will have them in a few days. He will make a sale, and ever sale counts. But more than this, he will agreeably surprise and please his patrons and will convince them that it is not necessary to go out-of-town to obtain the latest and best productions of the jeweler and silversmith.

## "TRADE-MARKS OF THE JEWELRY AND KINDRED TRADES"

(Second Edition)

will enable the jeweler to identify the maker of any article embraced in the jewelry and kindred trades. It illustrates 4,000 marks and covers every branch of the trade. It also contains much interesting and valuable reading matter on the subject of trade-marks in general.

One jeweler, after having the book for a while, wrote: "This book has been invaluable to me upon many occasions. Like the cowboy's pistol 'tis not required every day, but when needed it is wanted quite bad."

PRICE \$3.00,

Express Prepaid.

PUBLISHED BY

The Jewelers' Circular  
Publishing Co.,

11 John Street, New York.

THE ONLY BOOK OF THE KIND  
EVER PUBLISHED.

AN  
ENCYCLOPEDIA-DICTIONARY  
AND  
REFERENCE HANDBOOK  
OF THE  
OPHTHALMIC SCIENCES

Designed to Give, in Complete and Accurate Statement, and in the Readiest Form for Popular Use the Orthography, Pronunciation, Meaning and Etymology of All the Words and Terms Used in the Ophthalmic Sciences.

And in Addition to Give in Didactic Form a Complete Treatise on Such Subjects as Demand a Wider and More Elaborate Treatment.

By R. H. KNOWLES, M. D.

PRICE \$2.50  
IN SUBSTANTIAL CLOTH BINDING.

PUBLISHED BY  
THE JEWELERS' CIRCULAR  
PUBLISHING CO.,

11 John St., cor. Broadway, New York.

INDISPENSABLE TO OPTICIANS

## OUR EIGHT SALESMEN ARE ON THE ROAD.

It is more than likely that one of them will call upon you in the near future. Let us impress upon you here the fact that the sample line of American Watches, Diamonds and Jewelry that he carries has been selected with more than usual care.

From our  
New York Office:  
H. OLLENDORFF  
H. OLLENDORFF  
H. GOLDSTEIN

"We cover the country."

Special Southern Representative:  
O. J. SOMERS

From our  
Pittsburg Office:  
W. S. BICKART  
J. S. BICKART  
W. E. PARISH  
S. A. REUTER

Should your wants necessitate an immediate delivery before our representative's arrival, either our New York or Pittsburg office will give your order by mail PROMPT and CAREFUL attention.

# I. OLLENDORFF CO.

JOBBER IN WATCHES, DIAMONDS AND JEWELRY

NEW YORK  
54 Maiden Lane.

Established 1868.

PITTSBURG, PA.  
Cor. Liberty Ave. & 6th St.

## 46 out of 99 PRIZES

were awarded to

# PATEK, PHILIPPE & CO.

In the Timing Contest of the Astronomical Observatory in Geneva, for the year 1905, comprising: The only First Unique Prize for Best Average Running; 2 First Prizes out of 3; 5 Second Prizes out of 10; 8 Third Prizes out of 18; 9 Fourth Prizes out of 24; 10 Honorable Mentions out of 23; 11 Simple Mentions out of 21. 11 Manufacturers participated.

68 NASSAU ST., NEW YORK.

GENEVA, SWITZERLAND.



inged or pivoted cover, the opening and closing of which fastens and unfastens the bracelet. The bracelet 2, Fig. 2, may be permanently attached at one end to the locket 3, the other end engaging the hook 5 on the opposite side, and being fastened thereto by the closing of the lid 7.

FIG. 2.

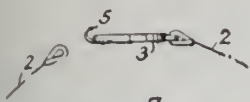

FIG. 3.

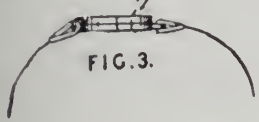

FIG. 1.



FIG. 5.



FIG. 4.

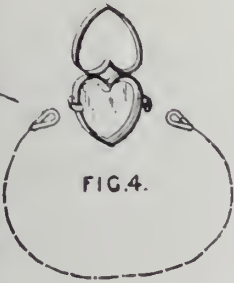

3. In one modification, Fig. 4, hooks are attached on both sides of the locket, both ends of bracelet being thus detachable; in a second, Fig. 5, the locket lid is pivoted; in a third, Fig. 1, a pin 21 on the lid enters a socket 25 attached to the locket, or vice versa. In a fourth modification, the attaching-loop and the hook shown in Fig. 2 are brought close together.

Complete specifications accepted June 7, 1906.  
1905.

- 1963. THIMBLE. NESBITT.
- 1978 and 15,979. TIME RECORDERS. DEY & DEY.
- 1928. FOUNTAIN-PEN FILLER. LOCKWOOD.
- 1946. STUD-SECURER. HAYNES.  
1906.
- 1986. CIGARETTE CASE. LAKE.
- 1915. CANDLESTICK. FOSTER & SMITH.
- 1965. FOUNTAIN-PEN. BAHR.  
Applications filed May 28 to June 2, 1906.
- 1982. SELF-OPENING UMBRELLA AND WALKING-STICK. ANDREW KLINGER, London.
- 1996. CANDLE-HOLDER. FRANCIS BAUMER, London. Complete specification.
- 1905. CLOCK-STRIKING MECHANISM. JAKOB KIENZLE, London. Complete specification.
- 15,588. FOUNTAIN-PEN. FRANCESCO CELLITI, Manchester. Complete specification.
- 1639. CANDLESTICK. C. J. H. LIGGINS, Ilmckley, Leicestershire.
- 1641. LINK CUFF HOLDER. W. M. ATTEWELL, London Road, Nottingham.
- 1702. HAIR-PIN. HANS SUMMA, London. Complete specification.
- 1745. SPOON. J. W. CUTHBERTSON, Lytham.

**UNITED STATES PATENTS THAT HAVE EXPIRED.**

[Reported especially for THE JEWELERS' CIRCULAR-WEEKLY by R. W. Bishop, Patent Attorney, Washington, D. C.]

Issued June 25, 1889.

- 15,687. CUFF-HOLDER. G. B. ADAMS, Irvington, N. J.
- 15,712. UMBRELLA. G. A. KITTREDGE and W. P. KILBOURNE, Chicago.
- 15,783. SCARF-PIN. J. C. LEIBEL, Colorado Springs, Colo., assignor of one-half to D. Ashby, same place.
- 15,877. CUFF-HOLDER. N. D. DABOLL and J. L. FOLLETT, Brooklyn, N. Y.

- 105,886. BELT-LOOP. F. J. HERRICK, New Britain, Conn.
- 105,920. BUCKLE. D. L. SMITH, Waterbury, Conn., assignor to the Waterbury Buckle Co., same place.
- 105,925. NECKTIE-FASTENER. C. E. STUBBS, Fairfield, Ia.
- 105,962. SUSPENDER-BUCKLE. JOHN KENNEDY, Birmingham, assignor to the Osborne & Cheesman Co., Ansonia, Conn.  
Design issued June 21, 1892, for 14 years.
- 21,834. RAZOR-HANDLE. J. R. TORREY, Worcester, Mass., assignor to the J. R. Torrey Co., same place.  
Designs issued June 27, 1890, for 7 years.
- 31,064. WATCH-CHAIN AND NECKLACE. M. M. MIRABEAU, New York, assignor to Lis-sauer & Co., same place.
- 31,065. PIN. MARY J. SMITH, New York.
- 31,066. BUTTON-HOOK HANDLE. T. W. FOSTER, Providence, R. I.
- 31,067. BUTTON-HOOK HANDLE. W. H. SAART, Attleboro, Mass., assignor to the J. E. Blake Co., same place.
- 31,068. SPOON-HANDLE. F. G. HOLMES, Pawtucket, R. I., assignor to the Howard Sterling Co., Providence, R. I.
- 31,069. SPOON-HANDLE. W. C. CODMAN, Providence, R. I., assignor to the Gorham Mfg. Co., same place.
- 31,071. PAPER-WEIGHT. S. E. GREENWAY, Deloraine, Canada.
- 31,073. PENCIL-POINT PROTECTOR. EDWARD TODD, JR., New York.

**Amendments to Trade-Mark Law Which Went Into Effect July 1.**

WASHINGTON, D. C., June 30.—The act for the amendment of the trade-mark laws will become operative July 1. Under its provisions it is amended so that the act reads:

That the owner of a trade-mark used in commerce with foreign nations, or among the several States, or with Indian tribes, provided such owner shall be domiciled within the territory of the United States, or resides or is located in any foreign country which, by treaty convention, or law affords similar provisions to citizens of the United States, may obtain registration for such trade-mark by complying with the following requirements: First, by filing in the Patent Office an application therefor, in writing, addressed to the Commissioner of Patents, signed by the applicant, specifying his name, domicile, location and citizenship; the class of merchandise and the particular description of goods comprised in such class to which the trade-mark is appropriated; a description of the trade-mark itself, only when needed to express colors not shown in the drawing, and a statement of the mode in which the same is applied and affixed to goods, and the length of time during which the trade-mark has been used. With this statement shall be filed a drawing of the trade-mark, signed by the applicant, or his attorney, and such number of specimens of the trade-mark as actually used as may be required by the Commissioner of Patents. Second, by paying into the treasury of the United States the sum of \$10 and otherwise complying with the requirements of this act and such regulations as may be prescribed by the Commissioner of Patents.

The second section provides that the Commissioner of Patents shall establish classes of merchandise for the purpose of trade-mark registration, and shall determine the particular description of goods described in each class. On a single application for registration of a trade-mark the trade-mark may be registered at the option of the applicant for any or all goods upon which the mark has actually been used comprised in a single class of merchandise, provided the particular description of goods be stated.

It is further provided that any owner of a trade-mark who shall have a manufacturing establishment within the territory of the United States shall be accorded, so far as the registration and protection of trade-marks used on the products of such establishment are concerned, the same rights and

privileges that are accorded to owners of trade-marks living within the territory of the United States.

The following are the classifications of interest to the trade:

- Class 2. Mineral raw materials.
- Class 4. Abrasive and polishing materials.
- Class 59. Horological instruments.
- Class 61. Jewelry, solid and plated precious metal ware, and fine cutlery.
- Class 64. Optical instruments.
- Class 66. Objects of art and ornament.
- Class 72. Merchandise not otherwise classified.

**Jewelry, Silverware, Clocks, Watches and Kindred Lines Exported from New York.**

WASHINGTON, D. C., June 27.—The following were the exports of jewelry, silverware and optical goods, clocks, watches and kindred lines from the Port of New York for the week just ended:

- Berlin: 1 package jewelers' sweepings, \$200.
- Bombay: 13 packages clocks, \$406; 39 packages clocks, \$525; 1 package watches, \$102.
- Bremen: 2 packages watches, \$915; 1 package clocks, \$107.
- Brisbane: 4 packages plated ware, \$136; 29 packages clocks, \$799.
- Buenos Ayres: 8 packages plated ware, \$735; 1 package watches, \$2,233; 3 packages clocks, \$295.
- Calcutta: 45 packages clocks, \$1,552; 1 package watches, \$270; 1 package jewelry, \$166.
- Callao: 2 packages jewelry, \$130.
- Colon: 2 packages watches, \$140.
- Genoa: 1 package jewelry, 500.
- Glasgow: 52 packages clocks, \$420.
- Hamburg: 3 packages clocks, \$456; 12 packages jewelry, \$199; 5 packages optical goods, \$856; 1 package optical goods, \$180.
- Havana: 63 packages clocks, \$607; 2 packages plated ware, \$145; 9 packages clocks, \$212.
- Havre: 3 packages optical goods, \$10,400; 2 packages jewelry, \$500.
- Launceston: 10 packages plated ware, \$643.
- Liverpool: 1 package plated ware, \$1,110; 1 package watches, \$1,000; 1 package jewelry, \$165; 3 packages plated ware, \$441; 70 packages clocks, \$1,901; 2 packages watches, \$600; 2 packages jewelry, \$1,021; 4 packages thermometers, \$195.
- London: 6 packages optical goods, \$2,246; 37 packages watches, \$6,457; 1 package jewelry, \$185; 3 packages scopes and views, \$527; 344 packages clocks, \$3,912; 62 packages clocks, \$1,692.
- Manchester: 28 packages clocks, \$189.
- Melbourne: 87 packages plated ware, \$5,899; 817 packages clocks, \$11,253; 6 packages optical goods, \$591; 7 packages scopes and views, \$1,050; 11 packages watches, \$390.
- Rio de Janeiro: 67 packages clocks, \$874; 1 package optical goods, \$100.
- Southampton: 1 package watches, \$660.
- Valparaiso: 1 package jewelry, \$257; 16 packages clocks, \$672; 4 packages plated ware, \$309; 3 packages watches, \$858.
- Vera Cruz: 6 packages plated ware, \$595.

A. E. Sipe, importer of diamonds, Buffalo, N. Y., takes great pride in devising new and novel advertising methods. He has attracted much local attention by his clever designs, the latest of which is well in line with his previous efforts. It is in the form of a match box for hanging on a wall, bearing these most pertinent inscriptions:

Rings That Make Matches.

If You Have the Girl, We Have the Ring.

Get Busy!  
Strike a Match and Buy Your Diamonds, Watches and Jewelry at Our Store.

# Mainspring Don'ts

## Simple Hints for Those Who Handle Mainsprings

---

Don't fail to provide yourself with the best mainspring winder that can be obtained. See that the hooks on all arbors of the winders are no longer than the thickness of the thinnest spring, and thus avoid kinking, and therefore unnecessary breaking of mainsprings.

Don't use a mainspring that is too long, because it fills the barrel and prevents that part, or the mainwheel, from making the required number of revolutions, with the consequence that the watch will not run as it should after each winding.

Don't use a mainspring that is too strong, because it will set, increase the percentage of breakage and injure the watch.

Don't use a mainspring that is too wide, and be sure that the tip and brace do not extend beyond the limits of the cover and barrel.

Don't forget that a mainspring should not occupy more than one-third the diameter of the barrel, thus leaving two-thirds to be divided between the arbor and winding space, to enable the watch to run about thirty-six hours.

Don't expect a mainspring to be flat if you put it in the barrel with the fingers. This method usually injures the spring, gives it a cylindrical form, and thereby increases the friction in the barrel.

Don't bend the inner or outer end of the mainspring with flat-nosed pliers, but provide yourself with specially made round-nosed pliers which will give a circular form to these parts, prevent short bends, contract the inner coil, and thus secure a closer fit to the barrel arbor without injuring the spring.

Don't expect other than a properly fitted flat mainspring with rounded edges to produce the least friction in the barrel, allow the greatest amount of power to the train, and give the best results as to time, service, etc.

Don't expect a mainspring to always endure extreme changes in temperature, or electrical disturbances, or straightening at full length, or neglect from lack of cleaning and oiling.

Don't expect a watch that needs cleaning or other repairs to run satisfactorily by merely putting in a new mainspring.

Don't expect a mainspring to plough through too much dirt.

---

## Waltham Watch Company

Waltham, Mass.

# THE HOROLOGICAL REVIEW.



## Some Key Watches Which Have Been Converted Into Stem Winders.

Translated expressly for THE JEWELERS' CIRCULAR-WEEKLY from the *Deutsche Uhrmacher Zeitung*.)

**E**VEN a cursory glance at the key watches converted into stem winders, illustrated herewith, will make it evident that all the competitors for the prizes which were offered have made use of the rocking bar. In fact, if we have to select a winding mechanism as nearly universally applicable as possible for the conversion of key watches, it will be difficult to find one better adapted to the various types of the latter. Whether

kind have often been described, and if we select one or two of Mr. Verinda's conversions, we do so principally because they are representative of types of watches frequently met with, viz., an ordinary gentleman's cylinder watch and a lady's watch by Vacheron and Constantin.

With both watches, there being no seconds hand, it was possible to turn the work in the case so as to obtain a favorable position for the barrel core or collet. In the

latter is provided underneath with a projecting, turned boss, which serves as a pivot for the wheel, b. In the lady's watch this steel plate (c, in Fig. 3) covers the entire barrel bridge, as well as the large, flat winding wheel, a, which, therefore, needs no washer. In Fig. 1, a new click spring, d, is inserted; in the lady's watch the old click work has been retained.

Both these conversions are very simple and very good, but, as we have said before, this winding system can only be applied in special cases; as a rule, especially when, in order that the seconds-hand may be kept in the right place, the work must not be turned in the case or when the barrel lies too close to the new winding arbor which is to be inserted, the rocking bar mechanism must be used. This, for instance, is al-

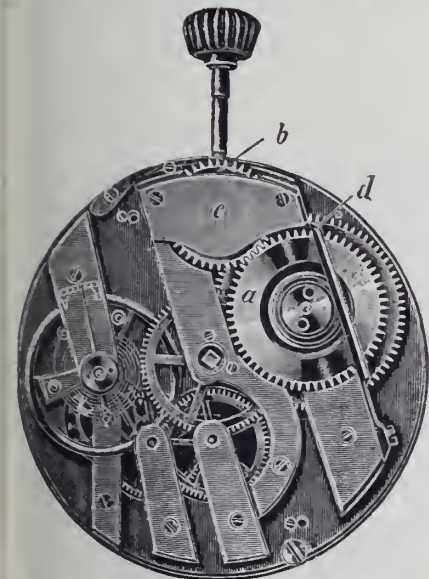

FIG. 1.



FIG. 2.

watch shown in Figs. 1 and 2, the plate on the dial side had to be provided with two recesses to receive the two set-hands wheels, d and e, and the curved slot for the click spring, f. The adjustment of these parts was still more easy with the Vacheron watch, because in this watch, as is known, the plate is recessed on the dial-plate side; accordingly Fig. 4, which shows the dial-plate side of this watch, scarcely allows it to be seen that a transformation has been made. To obviate a lateral movement of the spring, f, a small steel plate is inserted in a small cavity at g (Fig. 2), while a stop-screw, a', fulfils the same purpose in Fig. 4.

Let us now consider the arrangement of the winding wheels on the upper side of the work. In both watches the winding wheel, b, is placed between the bridges of the barrel and the center wheel (the two bridges are slightly recessed for this purpose), and kept in position by the steel plate, c. The

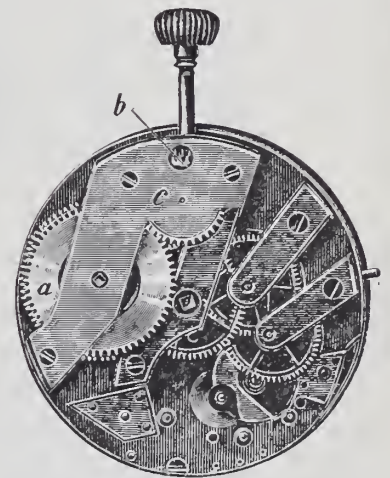

FIG. 3.

ways the case with the well-known Vacheron watches. In the latter, the barrel is almost exactly under the crown, and it would be impossible to find room for the movable set-hands pinion without previously turning the work in the case.

A perfectly successful transformation of this kind is shown in Figs. 5 and 6. It was designed and very neatly executed by H. Veringa, eldest son of the M. Veringa mentioned at the beginning of this article. As the action of this mechanism is made sufficiently clear in illustrations, we will merely make a few remarks on some details of the work.

To give a secure position to the winding wheel, a, the space between the barrel bridge and the rim of the case was filled by a suit-

the necessary space for the winding and set-hand wheels is found on the dial side or the reverse of the work; whether the barrel center is close to, or at a distance from, the winding arbor, the rocking bar can always be made of such a shape as to be easily adjustable to the existing arrangement. It would, however, be an error to conclude that recourse must always be had to the rocking bar in these conversions.

Every one who has had practical experience in this kind of work and with different kinds of watches, will be convinced that it will not do rigidly to adhere to one system. Where space and the situation of the barrel center allow, the result will be more quickly and better arrived at with a Bréguet winding device. Transformations of this



*Time  
O my friend  
is money!*

—BULWER-LYTTON.

And in this money making age there is an enormous and increasing demand for accurate timekeepers. This means that time is money for the dealer who carries a stock of

# ELGIN Watches

See Jobbers' list for prices or write the Company.

Every dealer is invited to send for the Elgin Art Booklet, "Timemakers and Timekeepers," illustrating the history and development of the watch.

## ELGIN NATIONAL WATCH COMPANY

Factories, ELGIN, Illinois, U. S. A.  
General Offices, 131 Wabash Ave., Chicago.

NEW YORK OFFICE, 11 John Street.  
SAN FRANCISCO OFFICE, 206 Kearny St.



the steel bridge, k (Fig. 5), recessed underneath. It should be noticed that the click spring has been discarded. The steel bridge, therefore, immediately joins on to the barrel-bridge. The wheel, b (Fig. 5) is mounted on the upper end, and the center wheel, Fig. 6) of the rocking bar on the lower (front) end of the arbor, c. The construction of this arbor was by no means an easy task; on the careful and scrupulously accurate manner in which this was done mainly

is an old one, its application to the conversion of key watches into stem winders may be regarded as one of the most recent novelties. As this arrangement may be unknown to many younger watchmakers, a few words of explanation may not be out of place.

The chief part of this mechanism consists of the rocking bar, a b (Fig. 7), having its center of motion at e and carrying the double-toothed wheel, e f. The outer teeth, e, of this wheel, have the usual epicycloidal form and engage with the wheel, h; the latter is fixed to an arbor, which carries the wheel, k, on the dial side (Fig. 8). The inner teeth, f, are pointed, like those of a ratchet wheel, and are geared with the ratchet, g, which is screwed on to the barrel core.

Both these ratchet teeth systems are cut somewhat conically; by this means the rocking bar is continually moved a little toward the barrel bridge during the winding. By this method of toothing, not only the reverse turning of the button, but also the construction of the inner teeth (which in this case had to be made by hand) are facilitated. The spring, d, which is filed out of one

**Some Experiments Recently Made With a Seconds Pendulum.**

(A paper read to members of the Municipal School of Technology by T. D. WRIGHT.)

(Continued from issue of June 27.)

It would also appear reasonable to suppose that the density of the atmosphere would change similarly in each case when the temperature was raised, unless the



FIG. 4.

depends the durability and the value of the mechanism.

The click work is now on the dial side. To make room for the wheel, e, and the motion of the rocking-bar, the barrel cover is turned down a little and the stop-work dispensed with. This arrangement of the winding mechanism was intended to give a secure support to the barrel-core, also on the dial side; for this purpose, Mr. Veringa



FIG. 7.

room, being more open to external barometric influence, maintained its density in spite of the higher temperature. It does not seem probable, and I am not well enough acquainted with this branch of physics to give a reliable opinion.

Only one other natural cause suggests itself to me. The case is heated by hot water, and although there is no leakage, the air in the case may be much more humid than that outside.



FIG. 6.

piece, like the rocking bar, keeps the two systems of ratchet teeth in gear.

This connection can only be broken by pressing the push-piece; the rocking bar, with the double-toothed wheel, e f, is then made to turn and the outer teeth engage with the pimon, i, fixed on the set-hands arbor. With the arrangement shown in the illustration, the push-piece had to be placed somewhat obliquely (see Figs. 7 and 8), so as to prevent any undue strain on the rocking bar, which is bent a little at b (Fig. 7), in order to give a proper surface for the push-piece to work upon. A small steel bridge is screwed in at l to receive the pivot of the winding arbor.

Although the drawbacks of the winding arrangement with inner teeth have long been known, and Mr. Veringa in applying it to the watches which we have described was principally actuated by the desire to produce something new, it must be confessed that when the watch is opened, the click work presents a most interesting appearance and works surprisingly well, and moreover, ensures a smooth winding, which is the essential feature sought.



FIG. 5.

applied the large, flat steel bridge, f (Fig. 5), in which runs the pivoted shoulder of the ratchet, e. The click spring, g, is supported laterally by this bridge. To connect the push piece of the set hands work and the rocking bar, w (Fig. 6), the steel lever, is pivoted on the stop screw, i, is inserted. Finally a specially unique conversion may be noticed. Although the idea on which the construction shown in Figs. 7 and 8 is based

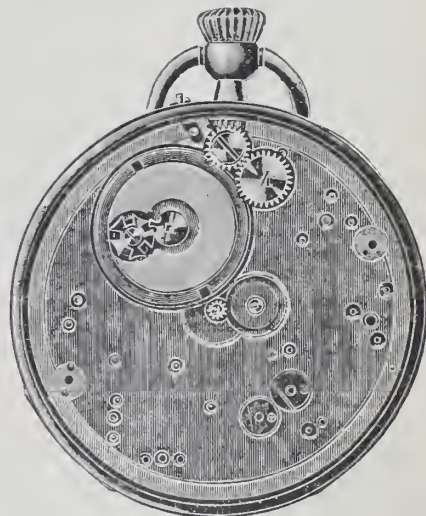

FIG. 8.

Some time after I had completed the experiments that caused me to contribute an article to the *Horological Journal* of July, 1904, on the behavior of watches in Southern Nigeria, and the curiously consistent gain on their rates of all the watches while in Africa, I was informed by the military officer conducting the survey, that at no time had those watches been any great distance above the sea level, that it was a

## SUMMER WATCH-SELLING CAMPAIGNS

**M**IDSUMMER may witness some falling off in the sales of ordinary lines of Jewelry. Such a staple article as the Watch, however, is less affected by the changing seasons. Is not this, therefore, a good time to emphasize Watches? Opportunity is afforded to appeal, not merely to your regular constituency, but to the great army of tourists and Summer visitors. Such activity paves the way for larger business the coming season.

### J. W. FORSINGER,

LEADING AMERICAN WATCHES AND MOVEMENTS

CHICAGO  
103 STATE ST.

NEW YORK  
2 MAIDEN LANE

### Sessions Clocks

Superior finish. Reasonable prices.

Have you seen our

**New and Exclusive Designs**  
in Mantel and Hanging Clocks?

Write for Catalog and supplement.

**The Sessions Clock Co.**

Main Office and Factories,

Forestville, Connecticut, U. S. A.

New York Salesrooms,

37 Maiden Lane.

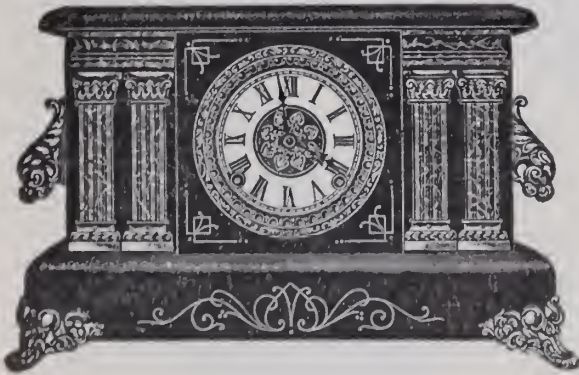

WHOLESALE

## DUEBER-HAMPDEN COMPLETE WATCHES

The conceded friend makers for the retail dealer. We are certain that we can help you make customers if you will write us for prices on Chains, Rings and all kinds of High-Grade Jewelry.

**WM. C. PENFOLD CO.**

WHOLESALE JEWELERS

AND AGENTS FOR DUEBER-HAMPDEN WATCHES

818-820 Chestnut St., Philadelphia, Pa.

where very little barometric change occurred, and that for all practical purposes I might assume the pressure to have been constant. The only information I could obtain of any difference of climate that might have a bearing on the subject was that it was a very moist atmosphere, where one lived in a perennial vapor bath.

Does increased humidity decrease the resistance to the motion of a balance or pendulum through the atmosphere? If so, and the alteration in the arc of my pendulum solely due to this cause, a pendulum in the air heated by some dry method will not behave in the same way. Reid observed the changes as I noticed, but he does not know how he obtained the higher temperature, nor does he say he obtained them by special means at all.

Secondly, the change that time has brought about in the expansion of the nickel steel. I have in this matter has been troubling Dr. Baume. My rod had undergone some accelerated process of annealing, but I understand from Mr. Baugh that a more elaborate system of "artificially ageing" the material is now found necessary. Can we be sure that any such system can permanently alter it? At what "artificial age" may we consider the material "grown up?" Other processes of preparation may delay the inevitable, but no one dare yet say that the process will permanently cure the unfortunate tendency to change.

It is a matter that concerns us very closely. A large number of high class watches and chronometers have been made with "artificial" balances and have obtained high marks in the official trials. Will these balances in the course of a year or two undergo the same sort of changes and prove to be under-compensated? Will they need re-adjusting for temperature every year or until the superior expansion has dwindled so far that they fail to compensate at all? I trust not, but can any one be quite sure? The balances have been in use long enough for some evidence to be forthcoming.

All the watches obtaining high marks in compensation two or three years ago obtain equally high marks now without frequent adjustment for temperature error? This question should be easily answered.

It is expected that within the course of a few months there will either be a new clock in the tower of the City Hall, Chester, Pa., or the one which is now there will be replaced. The matter is now in the hands of the Public Property Committee of City Councils and bids will be asked, both for repairs to the present clock and for a new clock for the tower. The present clock has been in service for the past 40 years. It was installed by Joseph Ladomus and he estimates the city solons that it would require about \$125 to make the necessary repairs and then he could not guarantee that it would run for more than three or four years at the most. A new clock, he estimates, would cost about \$500. Advertisements have been issued and proposals received for both repairs and a new clock, and it is believed they would be in readiness for the consideration of Councils at the meeting which was held on Monday evening July 2.

### The Little Things That Stop Watches.

(By CHARLES PECK, Ottumwa, Ia., before the recent convention of the Iowa Retail Jewelers' Association, in Des Moines, Ia.)

IT is not the large objects which cause a watch to stop, that are hard to locate, but, rather, as the subject would indicate, the little things, which give watch repairers the most trouble. I will start from the barrel and work toward the escapement. Very often the stoppage of the watch may be due to mainsprings having a T end, which is so long that it extends both beyond the barrel and barrel cover, coming in contact with various parts of the movement as the barrel makes its revolution. We have all noticed, no doubt, the endeavor some genius of the craft has made to shorten a T end after the mainspring was in place; usually the barrel received most of the filing. A mainspring that is too narrow will in time either work up or down, leaving one of the T ends project through, while a mainspring which is too wide will be unable to uncoil properly, causing the watch to stop.

My attention was recently called to a barrel hook which had worked outward until it came in contact with the center pinion, completely stopping the watch. Some watches are caused to stop by the fact that the barrel arbor has no end shake. The barrel being out of upright, thus causing the barrel to drag at some particular place, is sometimes found to be the cause of stopping. A mainspring which has been wound in with the fingers instead of a mainspring winder will sometimes present the appearance of a funnel, causing great pressure on both bottom of barrel and cap, undue friction in uncoiling, great loss of power, and unsteady power.

Passing on to the center wheel, we may find some things which will cause the watch to stop. The center wheel may not be true in the flat or the center staff that projects through the bottom plate may be bent, in which case the minute hand will rub on the glass in one place and on the dial in another, causing friction and catching of the hands.

Passing on to the fourth wheel, we sometimes find too much end shake due to various causes. This will give the second hand quite a degree of play, causing it either to drag on the dial or project up far enough to come in contact with the other hands. We will occasionally find a train wheel which is out of round, destroying the proper depth of wheel and pinion.

As we get to the escapement we can find a great many things which will cause the watch to stop. For instance, we take off the dial so we can observe the action of the escapement through the peep holes in the bottom plate. The escapement may seem to have plenty of lock while in full motion, but if we hold the balance and very slowly let the scape wheel drop, we may discover there is practically no lock at all and the safe appearance of the action, while the watch was in full motion, was due to the run on the pallet after the tooth had dropped. Now, if the guard pin is slightly back, giving great freedom between guard pin and roller, and through some jolt or jar the lever was slightly moved from the banking screw, the lock would not be suffi-

cient to hold safely. The result would be the overbanking of the watch.

We sometimes find one escape wheel tooth slightly longer than the other. The watch will escape on all teeth except this one. If a watch is banked up very close, so it will just escape without any run to mention, it may sometimes stop on account of the banking screws being bent toward the lever instead of being turned by the thread. For instance, if there is just enough freedom between lever and banking screws for the watch to escape and the watch was turned over, there being excessive shake to the lever, the points of the banking screws being bent in toward the lever, it would stop the fork from having the latitude of motion which it had before, so the tooth of the escape wheel would not leave the pallet stone.

A roller jewel which is slightly loose, just firm enough to stay in place when the watch is in one position, will sometimes cause difficulty in discovering the cause of stopping.

A watch came under my notice the other day which was caused to stop in a peculiar manner. This movement was an 18 size lever set; the screw which held the lever in place was slightly loose, which caused the lever to raise up enough to allow the spring which holds the lever in place, when not in use, to come in contact with the minute wheel, which would carry this spring up as far as the yolk and stop the watch.

Oil under the minute wheel causes a loss of power, as this wheel is very hard to remove when there is oil between it and the plate. Another thing which is a great source of trouble is a shifting dial which will allow it to shift enough to rub on the bit of the second hand. Sometimes a dust band will drag on the barrel, causing the watch to stop.

### Horological Notes.

A "GRANDFATHER'S clock," made in Boston, Mass., nearly 200 years ago and an heirloom in the family of Robert T. Murphy, of 82 Alexander St., has been sent by Mr. Murphy to a niece as a wedding present. The clock is over seven feet high and is one of the best specimens of its kind in existence.

W. E. Howard has discontinued business at Chatham, N. Y., and purchased a store in Philmont, in the same State.

It frequently happens, especially during long tours that automobilists are troubled with accumulation of fine dust and grit that find their way in some manner to the working parts of their watches, says an exchange. A good way to avoid this annoyance is to open the front case of the watch and with a match, cut chisel-shaped at one end, apply a thin coat of vaseline all about the seat of the case where the lid fits. When this is done treat the back lid of the case in the same manner. Only a small quantity of vaseline is required, just enough to make an unbroken film of it all the way round, and it will make the watch dustproof at these points. At the end of a month or six weeks open the cases and you will be surprised at the amount of dirt that has collected at the edges of the case. This removed, the treatment as outlined above can be repeated.



# ZENITH

## MOVEMENTS

Give the

**RIGHT TIME  
EVERY TIME  
For a LIFE TIME**

**Grand Prize, Paris Exposition, 1900**

Made in O size, 12 size, 16 size, all grades  
Hunting or Open Face, Pendant Set

**INTRODUCED FOR THE FIRST TIME IN AMERICA, THOUGH ONE OF THE BEST KNOWN WATCHES IN EUROPE FOR GENERATIONS**

Manufactured by

**GEORGES FAVRE-JACOT & CO., Locle, Switzerland**

HIPP. DIDISHEIM & BRO., Sole Agents, { 49 MAIDEN LANE, NEW YORK.  
COLUMBUS BUILDING, CHICAGO.

## The Carmen Watch Bracelet

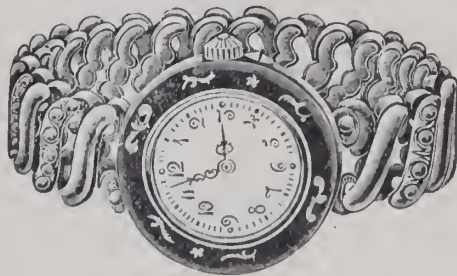

**GOLD FILLED**

WITH ENAMEL BEZEL ALL  
SHADES OR PLAIN GOLD FILLED

**BOTH BRACELET AND WATCH  
ABSOLUTELY GUARANTEED**

During the present great vogue of Bracelets, Jewelers  
will find these a profitable novelty to handle.

**HIPP. DIDISHEIM & BRO.**

Chicago Office, Columbus Bldg. 49 Maiden Lane, New York

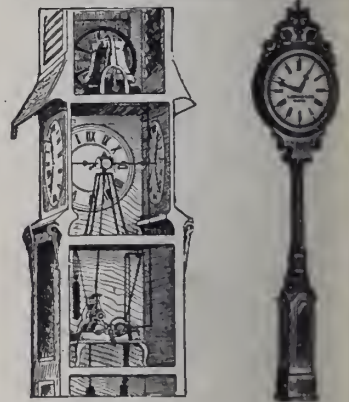

MAKERS OF

**Tower and Street Clocks**

For particulars write us, mentioning The Jewelers' Circular-Week  
**E. HOWARD CLOCK CO.,**  
EST. 1842. BOSTON, MASS., U.S.A.

## SIGNS

WE have sent signs as far  
west as Salt Lake City  
and as far south as Porto Rico.  
The mails and the railroads  
make us next door neighbors.

**THE FORMAN CO**  
**SIX LIBERTY PLACE**  
NEAR MAIDEN LANE . . . NEW YORK



IF IT'S A  
**ROY**

TRADE MARK  
IT'S STANDARD



O Size Bassine Engraved Cases, made from assayed Gold, quality as stamped.

**ROY WATCH CASE COMPANY,**



21-23 Maiden Lane,  
NEW YORK.

SAN FRANCISCO.  
LONDON, ENG.



This illustration shows our main factory exactly as it exists, where 3,000 complete watches are made daily.

## LANGENDORF WATCH CO.

CHAUX-DE-FONDS, SWITZERLAND.

It will be of great interest to every jeweler to learn that we are devoting our full attention to this market. The existing conditions in the watch trade have convinced us that there is a long felt want for moderate priced, but accurate Swiss Watches,

We wish to call your attention to our LONVILLE MOVEMENT. It has a lever escapement and is being made in Os, 12s and 16s, fitting perfectly all American cases. This movement is salable and profitable. Our Watches and Movements will be introduced in this market bearing the following names:

- |          |          |
|----------|----------|
| SOLDALE  | HIGHMERE |
| BONDALE  | LONVILLE |
| CLAREFAX | NAMTOC   |
| PEARLHAM | LADY MAY |

SOLE AGENTS FOR UNITED STATES,

**BYRON L. STRASBURGER & CO.,**  
17 Maiden Lane, New York, N. Y.

### The New Continental Watch Co.'s Movements.



O. 12 and 16 Size. 7 to 21 Jewels.  
All Bridge Model and Pendant Set.

Fitting all American cases without any change, interchangeable pendant set, have steel scape wheels, exposed pallets, double roller, Arabic or Roman dials, with and without marginal figures. CONTINENTAL WATCH CO. on bridges, C. W. CO. on dials except otherwise ordered. Special name or nameless movements require four months' time for delivery. Packed in glass show box inside paper box. No expense has been spared to make these movements the best on the market for the money. Every movement absolutely guaranteed. A full line of finished material constantly on hand.

For Sale by all Jobbers.

**JULES RACINE & CO., Exclusive Importers,**  
103 State St., Chicago. 37 MAIDEN LANE, NEW YORK.

### THIS IS HOW IT HAPPENED.

Some few years ago we determined that first of all we were going to make the best Cuckoo Clocks that brains and skilled craftsmanship could put together; then we were going to sell them for as little as we could.

The expected happened. Quality won out as it always does. We have a country-wide reputation for making the best Cuckoo Clocks that have ever been produced, and with that reputation has come the largest Cuckoo Clock business in the world.

Better write for our new Catalogue.



**AMERICAN CUCKOO-CLOCK COMPANY**  
Cuckoo Clocks and other Unusual Clocks  
STATION S. PHILADELPHIA

For **BEAUTY** of DESIGN, **PERFECTION** of FINISH and **RELIABILITY** Combined with Moderate Price

# TRENTON WATCHES ARE UNEQUALLED



No. 140. Bridge Model, 16 Size, 15 Jewel, Hunting and Open-Face, Pendant Setting.

A sample line is convincing. They are pendant setting in all sizes, fitting regular pendant setting cases, decorated dials and Louis XV hands.



No. 320. Bridge Model, 13 Size, 7 Jewel, Hunting and Open-Face, Pendant Setting.



No. 100. Bridge Model, 0 Size, 7 Jewel, Hunting and Open-Face, Pendant Setting.

A NEAT SIGN OR ADVERTISING BOOKLET FOR THE ASKING

JOBBERS SELL TRENTONS.

PRICE LIST ON APPLICATION.

Manufactured and Guaranteed by

**Trenton Watch Co., - Trenton, New Jersey.**

## SETH THOMAS CLOCK COMPANY.

Established 1813.



### EMPIRE No. 30.

15 Day, fine polished movement, half-hour strike, cathedral bell.

Four-inch, decorated, Porcelain dial. Cut glass top, sides, columns, and base. Height, 12¾ in.

List Price, \$60.00.

**SETH THOMAS CLOCK COMPANY,**

51 Maiden Lane, New York.

70 Wabash Avenue, Chicago.

### JAS. C. HOE'S SONS

10 Liberty Place  
Near Maiden Lane  
NEW YORK

Manufacturers of High Grade Wall Show Cases and Jewelers' Fixtures

INTERIOR REFITTING of STORES and OFFICES A SPECIALTY

Write for Estimates  
Finest references given if desired

Established 1820

## Telephone Calls

only 5c. each

## Extension Stations

only \$6 per year

These are only two of the many attractive features of the new telephone rates, effective July 1st.

Contracts now being taken.

Call nearest Contract Office for full information.

**NEW YORK TELEPHONE COMPANY**

Contract Offices:	Telephone No.:
15 Dey Street	9010 Cortlandt
115 West 38th Street	9040 38th
220 West 124th Street	9000 Morningside
616 East 150th Street	9020 Melrose

## LEARN JEWELERS ENGRAVING

"The Engraving School that Graduates Experts." A fascinating, high-salaried and easily learned trade, taught thoroughly and practically by correspondence. Your instructor is the foremost authority and master workman in the world. We will teach the beginner better engraving by correspondence than he can gain in years of right apprenticeship. We will improve the skill of any engraver one hundred per cent and make him master of the trade. The demand for competent engravers far exceeds the supply. Send for handsome, illustrated prospectus. **PAGE-DAVIS COMPANY,** Suite 10, 90 Wabash Avenue, CHICAGO

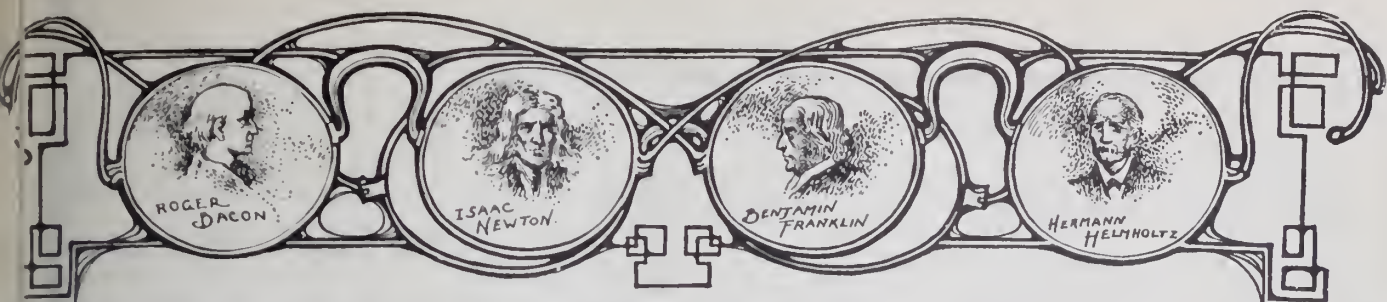

# OPTICAL DEPARTMENT

## Myopia.

MYOPIA, according to its nature, may be very dangerous or merely inconspicuous. If of the progressive type it constitutes the worst form of ametropia; if of the stationary type it causes blurred distant vision, but no other effects, and presents a number of advantages for close work. The myope, for instance, will be able to read, or perform any other kind of close work, for hours without the least sign of fatigue appearing; if he be a high myopic he sees with his naked eye as well as many emmetropes or hypermetropes would see with an average power microscope. This apparent magnification perceived by a myopic eye, is due to the enlargement of its retinal image, which is much larger than in emmetropic or hypermetropic vision on account of the necessary nearness of the eye to the object, and of the dioptric power of the refractive media.

The trustworthy rule for regulating the correction of myopia has never been established. That is, there is still doubt as to whether we should give myopic cases the full or a partial correction. There is also doubt as to the real cause of progressive myopia. Some believe that it is hereditary, the sufferer having inherited a weak sclerotic coat, which is unable to withstand ordinary intraocular pressure and which, before stretching, causing an increase in the length of the eyeball, with the accompanying myopia. Others claim that the unusually wide pupillary distance often accompanies progressive myopia because of the insufficiency of the converging power that would naturally accompany a wide pupillary separation.

There be any truth in the theory that a lack of converging power causes myopia to progress, optometrists will have given a boon to mankind (that part of it, at any rate which is myopic), in the perfection of which they are carrying prismatic exercises, for the ocular muscle. Thus, if lack of converging power be a cause of progressive myopia, the proper exercise of the internal recti will, by developing them, produce the necessary converging power and eliminate, thereby, the danger from increasing ametropia.

It is not safe to assume, however, that developing the interni would in itself suffice to check the myopia; it would be necessary to wear the minus correction, not only while exercising the muscles, but at all times.

The query at once arises, how shall we correct myopic cases—shall we give full or partial corrections? It is generally conceded that there is no universal rule, as

even in cases where conditions seem precisely similar one patient will stand full and the other only partial correction. Others claim that the higher cases should be fully corrected, while the lower cases should be advised to get along as well as possible without glasses.

One thing seems settled, namely, that should any myopic astigmatism exist in connection with the myopia, both should be fully corrected if the patient can possibly tolerate it.

If the effort at converging causes an increase in myopia, it is no less certain that by means of a concave lens the far-point is made to recede, in which case there is less convergence called for, and less chance, therefore, of the myopia increasing through this cause.

The writer's practice is to give as full a correction as tolerable in all cases for distance rise, but in high cases, above 6.00 dioptries, to order a weaker correction for reading use if deemed necessary. The older the patient the more apt is this weaker reading lens to be needed. For reading a -3.00 D. is usually deducted from the distance, unless presbyopia is present, in which case 1.00 D. more, in addition to the 3.00 D., is deducted for reading from the full distance correction.

In a case where the patient is over 40 years of age, has never worn distance correction, and whose error is less than 1.00 D., it is safe to give no distance correction. In younger cases, if you are sure it is real myopia, it seems wisest to correct any and all errors.

## Optical Notes and Briefs

Cross & McCullough, Fargo, N. Dak., will soon start the manufacture of optical goods in Crookston, Minn.

E. E. Thomas, representing the Milwaukee Optical Mfg. Co., Milwaukee, Wis., was a visitor in Omaha, Nebr., during the past week.

Frank Dalton and wife, superintendent of the Columbian Optical Co., Kansas City, Mo., paid the branch in Denver, Colo., a visit recently.

A correspondent informs us that John Wimmer, of Indianapolis, Ind., has improved the Kryptok invisible bifocal lens. The new form, instead of being cemented, is welded so as to make it practically solid, with none of the disadvantages of the old form of solid bifocal. It is claimed that the new lens is absolutely achromatic, and is the only one with but two curves that possesses all these advantages.

## Squint.

Speaking editorially in the *Ophthalmic Record*, Francis Valk states that the treatment of squint by oculists stands to-day where it did 20 or 30 years ago. That is, that the surgical treatment for squint is the same to-day as it was formerly by reason of the fact that all surgical procedures seem to be based on the principle that the case presents certain deviations of the optic axes, and an operation is advised merely for the purpose of correcting this deviation, regardless of the visual acuity, the rotation of the eyes in the field of vision, and the presence of acquired or congenital amblyopia.

To illustrate, it is still advised in a case of squint to perform tenotomy on one of the internal recti, and should this fail to give parallelism, then to cut the internal rectus of the other eye and so on indefinitely until the optic axes become parallel, with or without binocular vision as may happen. Then if an over-correction is produced, why just operate again and put it back. Valk sums up as follows: That every case of convergent or divergent squint must be studied from the standpoint of what may be the conditions of that particular case, and no operation performed until those points are settled. He does not think every case of squint must be subjected to operation, but that the visual acuity, the prospect of obtaining binocular vision, the field of vision and the mobility of the eyes, the degree of squint, and the age of the patient must be considered in all their bearings on the case, and then suitable operative procedure may be advanced with much greater prospect of securing that most desirable condition, true binocular vision and fixation.

It is edifying to optometrists to note that operative treatment in cases of squint is gradually falling into disuse and that such cases are being more successfully dealt with by means of lenses and prisms.

Of course with the passing away of tenotomy, passes one of the choice methods of oculists for extracting high fees, but there are a sufficient number of scrupulous men in the profession, it is to be hoped, to set a pace wherein the patient's welfare will come before the doctor's fee, and surely far too many ocular muscles are made useless by this wholesale operation idea now in vogue. The best results are at best only temporary in most cases, because to cut a muscle, nerves must necessarily be cut, which means that though all may seem well at first, the muscle so cut will in the course of a few years show signs of paralysis, and this



**It's the Little Things that count.**

The dainty little things that appeal at once to the casual observer. If it's useful, as well as ornamental, so much the better. Here is a LITTLE THING, so very useful and so pretty in design and finish, that you have but to show one to make a sale, and it yields a BIG PROFIT. It is called

**The Automatic Eye-Glass Holder**

Can be used as well for a Pencil Holder. It is made in Enamel, Gold, Silver and Rolled Plate, in a variety of artistic designs. We fully guarantee every Holder. We mean it, and will replace any Holder that fails to satisfy. Samples sent upon request. Send for catalogue.



Est. 1832. **Ketcham & McDougall, Manufacturers,**  
37-39 MAIDEN LANE, NEW YORK.  
ALSO MAKERS OF THE LEADING LINE OF THIMBLES.

*INSTRUMENTS for VACATION USE.*

**The Warner and Swasey**

Prism  
Binocular



*Now is the time to push the sale of these instruments. Write us at once for prices and discounts.*

2-inch  
Prism  
Terrestrial  
Telescope.



The Warner & Swasey Company,  
Dept. C,  
Cleveland, OHIO.

**"PERFECTION"**

The diamond pointed lens drill that has proven itself, beyond question, the best lens drill on the market is patented. Made in three qualities and sizes.

X \$5.00. XX \$6.00 XXX \$7.00.

MENDES CUTTING FACTORIES

12-16 John St. Phone 6605 Cort. NEW YORK.



**"Perfect Yourself"**

In ENGRAVING and EXPERT WATCH WORK.  
Take a Post-Graduate Course.  
**RIES & ARMSTRONG, Macon, Ga.**

**Expert WATCH and Chronometer REPAIRING FOR THE TRADE.**

When others fail you we guarantee satisfaction. A trial will convince. Prices very reasonable. List will be sent on request.  
**G. OHAN, 37-39 Maiden Lane, Lorsch Bldg., Room 27. NEW YORK.**

**ORNAMENTAL HAT PIN HOLDERS**

A Useful and Artistic Conceit in SILVER DEPOSIT ON GLASS

that contributes greatly to the appearance of any dresser

MADE IN A VARIETY OF HIGHLY ARTISTIC DESIGNS

Splendid sellers during the vacation period

**LACKNER & OHL**

50 Columbla Street NEWARK, N. J.



**"Cantlose"**

THE NEW EYEGGLASS HOLDER



Practical Simple Safe Secure

Positively prevents loss of Glasses from Hook. The feature of this Hook is a "Loop," making a secure connection.

For Sale by Leading Optical Dealers  
**PAUL GOUGELMAN, M: 37-39 Maiden Lane, New York City**

WATCHES OF PRECISION.

**Mathey Bros., Mathez & Co.**

Manufacturers and Importers of

Superior, Plain and Complicated Watches.

Sole Agents for

**CHAS. H. MEYLAN.**

SMALL WATCHES A SPECIALTY.

WATCHES DEMAGNETIZING



12 SIZE MOVEMENTS.

Brassus, Switzerland

21 MAIDEN LANE, NEW YORK.

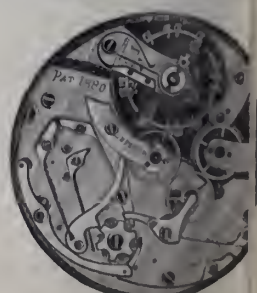

12 SIZE SPLITS.

## Optical Department.

ans the same squint or worse, and only spoiled muscle left with which to com-

Some remarks made by Dr. H. F. Hansell led to throw light upon this subject, wherein he admits that above 75 per cent. the cases of functional internal squint due to uncorrected hyperopia, and in a portion of these cases, if seen early in life, the squint may be cured by the rest of the ciliary muscle obtained by wearing proper hyperopic correction.

This being the case, the advocates of untended tenotomy will find it rather difficult to reconcile their practices to true scientific and optometrists may feel justified in bringing any cases of squint with which they come in contact, to insist on having the dangerous methods employed and provokes, before submitting to operative treatment.

### A New Invisible Bifocal and the Old.

It is reported that an improved form of invisible bifocal lens is about to be placed upon the market. Perhaps the form of invisible bifocal best known at present is that made under the Boršch patent and named the "Kryptok." This lens consists of three parts, cemented together with Canada balsam; there is no ridge, as the segment is a lens of a higher refractive index, between the two larger pieces. It is claimed, however, that a recent improvement made in these lenses will make them almost perfect in many respects.

There is also the invisible bifocal called the "Kantseum," which, it is claimed, is ground by an entirely new process. Cement is used, but only over the area covered by the segment, whereas in the "Kryptok" the entire lens area, both "distance" and "near" is covered with cement. Third is the "Bisight," claimed to be the only invisible bifocal ground in one piece, and in which the upper and lower each perfectly centered.

The new invisible form will have no cement, and will consist of only two pieces of glass. Not being a one piece bifocal, it is free from none of the bad features found in the usual form of "solid" bifocal, and not being a "cement" bifocal another disagreeable feature is also eliminated.

It consists of a disc or segment of high-refracting flint glass set into the main lens of crown glass, and secured so as to become, virtually, a part thereof. It has the smooth and uniform surface of the single lens.

Many improvements along the line of invisible bifocals may be naturally looked for, as much as bifocals are coming into much more general use. A belief was prevalent that bifocals were not good for the eyes, but this is not so and the public is learning the truth rapidly. But while you may convince a patron that the bifocal is not injurious to his eyes, you cannot convince him (or, more particularly, her) that the regular visible bifocal is not unsightly. Again, as bifocals are properly associated with advanced years, people do not care to wear them and thereby advertise the fact that they are past the prime of life.

E. L. R.

Thus, both pride and utility call for invisible bifocals and in view of the vast strides made in the last few years, one might almost say months, it is safe to predict that this form of lens is destined to be brought to a high state of perfection. It will behoove optometrists to keep "up-to-date," in the strictest sense of the term, on the subject of invisible bifocals. R. Y. U.

### Anatomy of the Nervous System.

(Lecture recently delivered before the Rochester Optical Society by DR. RALPH H. WILLIAMS.)

(Continued from issue of June 20.)

THE secretory nerves are those which cause secretion in the glands to which they are distributed, such as the salivary glands, pancreas, gastric, sweat glands, etc.

Trophia nerves, which accompany every nerve trunk in the body, control the nutrition of the part which they supply.

The function of nerves has been studied by a system of section and stimulation. Divide a nerve at both its central and peripheral end, if it be a motor nerve, stimulation of the central end will cause no result, whereas stimulation of the distant end will result in the usual muscle contractions governed by that nerve. If a sensory nerve be severed and the distant end be stimulated nothing will ensue, but if the central end be stimulated there will result pain, referred to the termination of that nerve and perhaps the normal reflex muscular action that would be brought about by the stimulation of that nerve. It is in the same manner that the other varieties of afferent nerves have been discovered.

Another aid in studying nerve paths and tracts is degeneration. When a nerve is severed it immediately begins to degenerate on the side away from the center or cell from which it originated. No matter how far the end of a nerve may be from the cell from which it originated, it still receives its nourishment to a considerable degree from that source and, if separated from it, will die and degenerate. Thus when a nerve is cut, both the brain and spinal cord remaining healthy, the peripheral end of the nerve loses its function at once and within two or three days degeneration of the distant portion of the nerve begins to progress. It does not begin to disintegrate at one end, but it commences simultaneously in all portions of the nerve at one time. Fatty degeneration of the nerve ensues.

Such a nerve will become regenerated; it is practically a new nerve, however, and is of slow development. It will require four weeks after it has been severed before it will begin to grow out again. The process is not complete and sensation will not be restored to the part affected for a period of about three months. This process can be materially hastened in the case of large nerves by the surgeon's suturing them together. It seems to make it easier for the new nerve to follow out along the path of the old one.

Nerves are spoken of as irritable. This is not in an abnormal sense at all, for a nerve must possess a certain irritability to maintain its function and any increase or diminution of that irritability will cause pathological changes in the parts affected. This irritability is controlled by two things.

First, by the continuity of the nerve, that is, the absence of any mechanical interference with the passage of impulses along the nerve, and second, by its nutrition.

There is one important fact which should be brought out and which is so outrageously ignored in the general consideration and treatment of diseases. The first effect of a diminution in the nutrition of the nerve or its center is to increase the irritability of that nerve, thereby increasing the activity of its function. The logical method of restoring such nerve tissue to its normal activity would be to endeavor to restore its normal nutrition, either by restorative remedies or by such means as will improve the blood supply to the affected point. Only the ignorant would use depressing measures. And yet we see it indulged in about us every day.

A slight interference with the nourishment of a nerve center or group of centers will, as stated, first cause an increase in its irritability, or a periodical increase in its irritability. For instance, there are many forms of neuralgic headaches, due solely to the fact that the center of the nerve involved is not being properly supplied with blood. The violence of the headache is often accompanied by a reflex muscular effort on the part of nature to restore the normal circulation. If left alone it will usually succeed, though it may leave conditions which may make a recurrence possible. The logical thing to do in a case of that kind is to restore the normal circulation, or nutrition, and yet the usual method employed to secure relief is either to resort to a nerve sedative which will temporarily paralyze the nerve so that it will no longer be capable of conducting painful impressions or by the use of a cardiac depressant, such as phenacetine acetanilid and the like which so far reduces the amount of blood to the nerve that its irritability is entirely destroyed or at least benumbed.

The actual form that the transmission of a nervous impulse by a nerve takes may come up in your mind and require a little explanation. So far as can be learned by the most delicate instruments there is no change of form or of temperature in a nerve while in action. When not in action it is non-electrical, but when in action a wave of negative electricity passes over the nerve at the same rate as the nerve impulse. This can be readily measured. A nervous impulse is not electrical, however. It is much slower than electricity, infinitely slower. In man it is estimated that a nervous impulse only travels about 105 feet per second.

In order to give you some impression of the method of the transmission of a nerve impulse to and from the brain we will take up some of the tracts of the brain showing the direction in which they transmit impulses and their relationship to the rest of the nervous structures. I will first show you a diagrammatic illustration of the course of nerve fibres. You will bear in mind the point made regarding sensory and motor nerve when dealing with the anatomy. Remember the motor nerves pass downward through the anterior columns of the cord while the sensory nerves pass upward in the posterior columns. This is a general division which will be further explained later.

(To be continued.)



### A "Realistic" Window Display.

(Continued from issue of June 27.)

SOME readers of THE CIRCULAR-WEEKLY will question the adaptability of the jeweler's stock to stage realism. Already the writer has stolen a few advance steps within that province by suggesting the display of the watch chain on actual vests (see issue April 18), but a slight straining of the thinking faculty will show that most, if not all, the details of the jeweler's equipment are amenable to this extension.

Suppose we take as an example a ring display. It is not necessary that a ring should be attached to the center of a piece of white cardboard because we have always seen them so accommodated. Rings were not born that way.

#### A REALISTIC RING DISPLAY.

Rings are built to adorn the fingers, toes, ankles, wrists, etc. Then why should they not be displayed that way in your show window? Being designed for such purposes they display their charms more entrancingly on the human member for which they are formed. And the above mentioned parts of the "human form divine" are by no means impossible of imitation. The wig-maker exposes the product of his skill on a waxen image of a human face; so does the milliner. And the human face is by far the most difficult portion of God's work represented in the genus homo.

The man's and woman's hand is easy to counterfeit in wax, plaster, papier-mâché and numerous other plastic materials. A dozen or so of such casts with rings attached to them (if necessary several on one finger), will set off the design and the gems far better than a piece of white cardboard. Wax is very soft and easily injured and scratched in passing a ring over it. But if the size of the fingers be such that the rings fit loose on adjusting they can be wedged tight with cotton batting from the under, unseen side and thereby display no visible looseness of fit. Other harder substances, such as plaster, can have a wax coating, if the question of cost is to enter into consideration.

To differentiate substantially between the male and female digits the former should lean toward the spatulate and the latter be strongly exemplifying the tapering "idealistic" of palmistry science, with almond-shaped nails.

So much for the "realistic" setting. If it is desired to maintain the entire window space in ring display, some ring history or

interesting facts can be interspersed among the casts. A beautiful centerpiece for a ring display would be a replica of the Franklin Pierce ring, presented to the President of that name in 1852 by the citizens of California, especially interesting while the earthquake disaster is still within recent memory. This ring is in our museum. It weighs a pound and is probably the most characteristic ring in the history of American gold and silver smithing. It is a signet with engraved illustrations of Cabinet history. The arms of the State, surmounted by banner and stars of U. S. A. in gold, form a lid which, when lifted, displays in nine compartments specimens of ores native to California. A picture of this masterpiece is to be found on page 43 of "History and Poetry of Finger Rings," published in 1855 by Redfield, 110 Nassau St., this city. The larger public libraries would probably produce a copy if you inquire.

A few cards similar to the following would add interest to the ring window:

Ring Ornaments  
Date Back to the Time When Woman Got Vain  
and Man Conceited.  
Nearer Adam's Day Than Ours.

Among Ancient Hindoos, Persians, Egyptians,  
a Ring Denoted Eternity.  
A Seamless Metal Ring Eternal Bondage.

The Ancient Roman Wedding Ring Was of Iron  
and Meant Slavery of Wife.  
Have Customs Changed Any?

One or two European "Gimmel" rings should figure in this display. If not quickly available they are easily made, being but two loose interlinked plain gold bands. A card might read:

"Gimmel" Rings.  
A Love Token (Truth).  
His Finger in One, Her's in the Other.  
"Yoked" Together.

Display a few spiral serpent and plain rings with this card alongside:

Spiral Band Rings  
Date Back to the Ancient Saxons.

That this department shall prove usually beneficial to our readers, it is desirable that the members of the trade generally communicate with THE JEWELERS' CIRCULAR-WEEKLY regarding any advantageous device or plan which they are utilizing in connection with their business.

Add a few serpent rings with tail in mouth to this card: :

This Design Derived From Egypt's Priest-  
Some Found in Temple of Phha.  
They Represented the Recurring Years, at  
Soon Became Popular.

Put a ring broken into two parts in the display and a card reading:

Old Betrothal Custom.  
Two Lovers Break a Ring in Two  
Each Retains a Part.

Another card might read:

Which Finger?  
First the Greek and Romans Made the Fourth  
the Ring Finger.  
Pliny Says: "Gauls and Romans Wore Ring  
Middle Finger."  
Ancient Egyptian Ladies Used Left Hand, &  
Most Rings Figured on Third Finger.

Have some mourning rings in your window:

An Ancient Custom.  
"Memorial" or "Mortuary" Rings Were  
Bequeathed by Will.

And one more card, which, properly backed up by a few attractive exhibits, should be conducive to sales:

The "Posy" Ring (Posie) Dates Back to  
16th Century.

"About a hoop of gold, a paltry ring  
That she did give me, whose p... was

Love me and leave me not"

—"Merchant of Venice," Act 5, Scene 1

"Is this a prologue, or the posy of a ring"

—"Hamlet" Act 1, Scene 3

"You are full of pretty answers. Have  
not been acquainted with goldsmiths wives  
could't them out of rings?"

—"As You Like It," Act 5, Scene 1

And right alongside this with an assortment of engagement rings have the joined posy list, or better or more, as get them.

Have a small card stating that you engrave any of these or other in the side engagement rings free of charge may and should bring you the name customers your industry and energy in

## Storekeeping Department.

ing the window display together so richly deserves

### Old "Posy" or Engagement Ring Mottoes.

"The gift is small, but love is all."  
 "In God and thee my joy shall be."  
 "Let not absence banish love."  
 "Let us love, like turtle dove."  
 "God did decree this unite."  
 "I have obtained whom God ordained."  
 "Virtue passeth riches."  
 "United hartes death only partes."  
 "The love is true that I O U."  
 "God thought fitt this knott to knitt."  
 "True love is the bond of peace."

Displays of this character affect passers-by rather psychologically by putting the mind in a mood to buy—which mood is often momentary and impulsive. The tricks to catch the prospective buyer while he is in the mood. C. W. C.

[THE END.]

## The Advertising Value of the Jeweler's Show Window.

Paper read at the recent convention in Des Moines of the Iowa Retail Jewelers' Association, by L. E. SMITH, member of the executive committee, Oskaloosa, Ia.)

MY subject, "The Advertising Value of the Jeweler's Show Window," is a broad subject, and worthy of much time and thought. I have had ample opportunity to note the effect of window work on the part of the retail trade, and the result, generally speaking, justifies the belief that the window when properly used is one of the most profitable of the several known advertising mediums.

The window is the eye of the store. You form your opinion of man very largely from the expression of his eye. The customer forms his judgment of a merchant very largely from the appearance of his window. The window itself, as you know, is nothing more or less than the outside sign of a store's interior. When goods are artistically grouped they unconsciously impress the passer-by that the store stock throughout is carefully selected.

The first essential of a window is freshness. The well-dressed window is the window that is always fresh. The finest suit of clothes in the world won't make a man look very well if he has worn them night and day for four or five days, and the best planned window decoration loses its effect after the dust has begun to settle on the goods and the glass gets a little dim. There is no fixed moment at which you can say that a window decoration has begun to lose its effectiveness any more than there is a definite moment when you can say that the rose has begun to fade. The deterioration is as gradual as it is certain.

The way to be on the safe side is to give the window a fresh dressing at regular intervals, whether it seems to need it or not. Every new window displays its advertising value. The window is so much space that we have to pay for, whether we use it to the best advantage or not. It is said a

good window dresser can make the window pay the rent of the whole store.

When reasonable goods are shown in their proper seasons, it equally impresses people that the store behind the window is filled with new and seasonable goods, and it will afford suggestions to the wavering public. Between seasons it will act as a temptation. Human nature is weak, and people want what they see.

Make the window tell the news of your store. We could not afford to get out a daily newspaper telling about the progress of our business and the changes in our stock, but we can get this matter before the public just as effectively because our window display can show real things and has a great advantage over print which can only tell about things.

But don't crowd your window. It is a poor place for the storage of merchandise which is not usually improved by strong sunshine or exposure to dust. Moreover, crowding the window makes too many things to be handled, and adds to the temptation to postpone rearrangement.

Most important of all, the window well arranged with a few articles commands attention and gives the passing crowd some-

## A Brilliantly Lighted Show Window.

ONE of the best-lighted show windows to be seen in any of the jewelry stores in Brooklyn, N. Y., is that of M. M. Freund, 725 Broadway; at least, that is the way it seemed to a reporter of THE CIRCULAR-WEEKLY, who recently visited the store just after the lights were turned on at night. There is also an expert's word to the same effect, for in a recent issue of the *Brooklyn Edison* is an article on the subject sustaining a tribute to the attractiveness of Mr. Freund's window.

Surely the electrical experts know when a window is well lighted, and this is what they say of Mr. Freund's display: "He has a most beautifully, lavishly-lighted store. He has more brilliancy to the square inch than two average stores, and he finds it profitable. Mr. Freund's establishment is located in one of the busiest parts of Broadway. It's a very small store, and being in juxtaposition with much larger establishments, might have remained insignificant and have been lost in the shuffle, but it isn't. It stands out at night with a bright persistence, like a diamond in a silver setting, and that brightness attracts

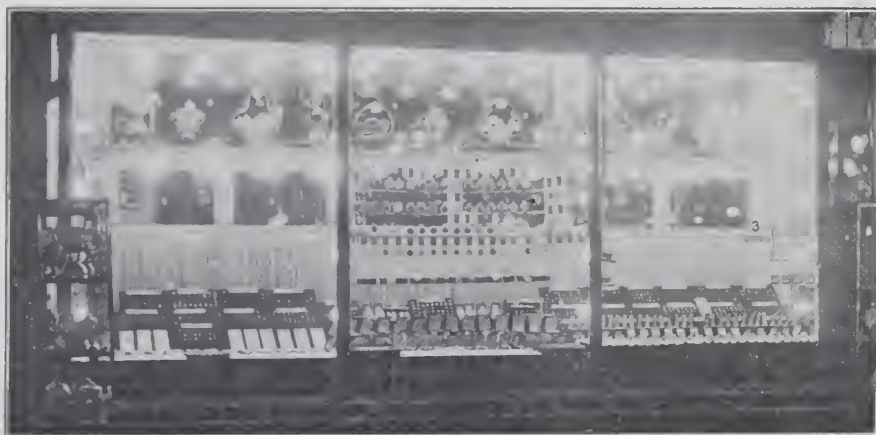

ILLUMINATED SHOW WINDOW OF M. M. FREUND, BROOKLYN, N. Y.

thing to stop and look at when that same space crowded with a variety of objects is passed unnoticed.

Aside from that fundamental work, however, the window can be used effectively as a direct seller of goods and many houses employ it for that purpose. Direct sales are made by displaying certain lines or companion pieces with window cards quoting price and brief text matter. Displays of that order, particularly in the case of stores on main business streets, almost invariably attract attention and, if the goods and prices are right, attract trade as well.

The window also is a splendid help to newspaper and similar advertising, and will confirm the printed statement. We have positive proof of the great "Advertising Value of the Jeweler's Show Window" in the inducements offered by the large manufacturers in the sums of money donated as prizes and expended on window fixtures with which you are all familiar.

It takes study and it takes time to arrange artistic displays but artistic displays are effective and pay. The time devoted in accomplishing such results can safely be considered as well spent.

trade and brings the small store customers."

The writer adds that Mr. Freund believes that money expended in a striking illumination is an investment, not an expense. He turns on his electric lights at night earlier than most stores. He does not turn them on in instalments, but flashes them all at once.

The lighting is both direct and reflected. The ceiling over the show window is studded with rows of bulbs, and there are similar rows down the sides and at the back. Along the bottom, close to the street, is another row, placed like the footlights on a stage. Vertical rows of lights are placed on the window frames.

F. W. Bromberg, Birmingham, Ala., has filed a bill for injunction and a suit for damages against the Eugenotto Construction Co., engaged in the erection of the 15-story Brown-Marx building, because, he alleges, that company has reduced, by about 18 inches each way, the floor space which was leased to him. Mr. Bromberg claims that he has expended \$5,500 in purchasing fixtures which will not fit, on account of the reduction of the space for which they were intended.

What Tool is of More Importance to THE MAKERS OF FINE JEWELRY than

A FIRST CLASS SAW?

SHARP—TRUE—UNIFORM  
—PERFECTLY TEMPERED

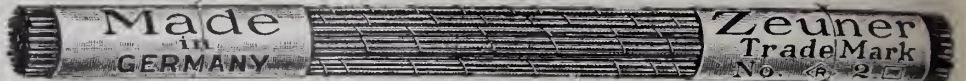

Such is the **ZEUNER SAW.**

TRY THEM, for "Only the Best are Good Enough," and only the Best are Cheap. Trial orders promptly filled under guarantee of perfect satisfaction, which applies also to our "AMERICAN SWISS FILES."

**E. P. REICHHHELM & CO.,** 23 JOHN STREET, NEW YORK.

**HERPERS BROS...**  
MAKERS OF  
**BRACELET SETTINGS**  
IN 10, 14 AND 18 KARAT GOLD AND IN PLATINUM.  
ALSO A COMPLETE LINE OF GALLERIES AND FINDINGS.

**GALLERIES**  
12 NEW PATTERNS

OFFICE AND FACTORY NEWARK, N. J., U. S. A.  
NEW YORK BRANCH 41-43 MAIDEN LANE

**GLARDONS' SWISS FILES**  
are the **HIGHEST STANDARD** of Excellence.  
We are Sole Agents for the United States and Canada.  
**F. W. Gesswein Company,**  
Established 1868. Incorporated 1896.  
WILLIAM DIXON, PRES.  
Dealers in Fine Tools and Supplies,  
39 John Street, New York.

**CULMAN BALANCE CHUCK**

For Refinishing Balance Pivots, without removing the Hair-spring or Roller, and protecting them while the pivots are being polished. ONCE TRIED, ALWAYS USED. FREE ON 10 DAYS' TRIAL.  
OVER 1000 SOLD THE FIRST YEAR. PRICE, \$3.50.  
C. CULMAN, 316 N. Sixth Street, ST. LOUIS, MO.

**CRUCIBLES**  
Jewelers' Supplies, Etc.  
Established 1850.  
**J. & H. BERGE,**  
95 John Street, NEW YORK.

**JAMES J. DONNELLY,**  
Gold and Silver Electro Plater,  
Fire Gilder and Colorer,  
41 and 43 Maiden Lane, New York.  
Prompt Attention Given to Mail Orders.

**ROLLED GOLD PLATE SEAMLESS WIRE AND TUBING**  
**DUNBAR, LEACH, GARNER CO.,**  
MANUFACTURERS,  
ATTLEBORO, MASS.

**CASTINGS** Gold, Silver, Bronze, Brass, German-silver, Copper & Iron.  
Supply Jewelers, Silversmiths, Die-makers, Mould-makers, etc.  
L. D. Tel. 2072 L.  
Unbreakable Bronze Forces. Hard Bronze Engraving Plates. Cast Iron Forces for making Steel Dies.  
Chandelier, Undercut Work, Statuary.  
**AUGUST GRIFFOUL,** 313 HALSEY STREET, NEWARK, N. J.

**JOHN S. STIVEN,**  
Gold and Silver Chaser.  
Room 219, Electrical Exchange Building,  
156 LIBERTY STREET, NEW YORK.

DAY CLASS | **ENGRAVING** | NIGHT CLASS  
THE SCHOOL FOR THOSE WITH MODERATE MEANS  
**POMFRET-GOLDY SCHOOL OF JEWELRY ENGRAVING**  
SEND FOR PROSPECTUS - 319 HEED BUILDING, PHILADELPHIA, PA.

"PRACTICAL COURSE IN ADJUSTING."  
Price, \$2.50.  
All Jobbers or Jewelers' Circular Publishing Co

**Eliassof Bros. & Co.** IMPORTERS AND JOBBERS OF  
A LARGE ASSORTMENT OF DIAMOND MOUNTED JEWELRY CARRIED IN STOCK.  
**DIAMONDS WATCHES JEWELRY**  
9-11-13 MAIDEN LANE, NEW YORK.  
100 STATE STREET, ALBANY, N. Y.





[Answers are also solicited from our readers to the questions published on this page.]

**QUESTION No. 1599.—Photos on Watch Cases.**—Will you kindly give us in detail the process of reproducing photos on watch cases and watch case cups? P. T.

**ANSWER:**—Photographs can be reproduced on watch cases just as easily as the master pictures which children reproduce on lamp shades, etc. The photographs are mounted on collodion paper, which, after having been dipped in luke warm water, is applied to the case or dial and pressed on evenly, with the picture side against the object which is to receive the impression. It is necessary, first, to apply a gelatine solution to the dial or watch cap, in order to insure good adhesion. After the collodion photo is fastened by gently rubbing the back, allow it to dry, then soak the covered object in water. This loosens the paper and leaves the picture adhering to the dial. The photo may be colored and then protected by good varnish.

**QUESTION No. 1600.—Mercurial Pendulum.**—In setting up a regulator with a mercurial pendulum we understand there is one way to prepare it so that the mercury will remain bright instead of turning dull. Could you tell us what we could do to avoid this? G. & H. Co.

**ANSWER:**—In filling the glass jar of a mercurial pendulum you need a long funnel which reaches to the bottom of the jar. This funnel is made of foolscap writing paper, having a very fine hole at the lower end, not much larger than a pinhole. Through this funnel the mercury must be filtered. It will come out clean and without air bubbles, and the local impurities will be retained in the funnel.

**QUESTION No. 1601.—Broken Porcelain Case.**—I have a large Japanese porcelain case with broken top. I want to cut off the broken top and leave a clean cut edge. What is the best and easiest way to do it? What metal can I use in hard soldering brass so that the joint will not show? B. M. M.

**ANSWER:**—The broken part of a porcelain case may be cut off smoothly by a disk of smooth tin, the edge of which is charged with corundum or diamond powder, and which is revolving with its edge in water for the purpose of keeping its edge clean. Brass may be hard soldered with spelter or brass containing more zinc than the brass to be soldered; the latter is called high brass, while the better quality of brass is called low brass.

**QUESTION No. 1602.—Cement for Marble.**—I have a marble clock which has a piece broken from the base. Kindly give me directions for making a suitable cement for the above? C. M.

**ANSWER:**—A cement suitable for marble

is made by using 12 parts of Portland cement, six parts of slacked lime, six parts of fine sand and one part of infusorial earth, worked into a thick paste with sodium silicate. The cement is to be applied cold, and the fractures or surfaces are closely fitted together. It will harden in 24 hours, and the cemented place will be stronger than the rest of the marble, it being impossible to break it at that point.

### The Enameling of Jewelry.

By CECIL H. SHERMAN.

(Copyright, 1906, by The Jewelers' Circular Publishing Co.)

(Continued from issue of June 27.)

**S**INCE glass is made by melting silica and mixing with it readily fusible material, oxide of lead (litharge), borax, potash, etc., the way to make it flow more easily is to add more of these materials. To five ounces of powdered glass add two ounces of litharge and one-half ounce of borax (powdered) and one-half ounce of nitrate of potash; mix very thoroughly and place in a sand crucible so large that the powdered mixture will only fill it half full; cover with a lid or any inverted crucible and place in a furnace that will generate enough heat to melt the same quantity of pure copper; heat it until the mass is molten and has stopped boiling or bubbling. Then pour on an iron slab or in an iron ladle. When cool grind a piece of it and try it in the manner described for testing enamels. It is a pretty good plan to try two or three colors with it and to fire over an alcohol lamp or bunsen burner flame.

If this flux flows or melts at about the same heat as enamels which you have found satisfactory, all is well; if it is too hard make another lot, decreasing the amount of glass until you have just what you want; if too soft, that is, will not stand the pickle test, add more glass to the formula. But should you find that when you make the enamel flow at the desired degree of heat it will not stand pickle, then the quality of your glass is not good enough, and a new kind will have to be used. One enamel maker of my acquaintance was so disgusted with the general run of glass that he studied glass making and was soon able to make his colors direct from powdered flints. The result was an improvement in his colors as well as the satisfaction of being pretty sure of producing the color which he started out to make.

The colors are produced by the oxides of metals. Black oxide of cobalt will make blue; a very small amount will produce a dark blue, but for some reason if an extra dark transparent effect is desired one must

add a little black oxide of copper. Black oxide of iron will sometimes make a dark blue very transparent.

Black oxide of copper, which you can make yourself by heating pure copper to a red heat and grinding the black scale formed on the surface, colors glass a light bluish green and is often used in the form of nitrate of copper, which will color opaque enamel a pretty baby blue or light turquoise.

Red oxide of copper, it is said, will make fine red enamel, but the color which I obtained was always green. Manganese, the black oxide, will produce reddish purple; combined with red oxide of iron it will make a brown; permanganate of potash with cobalt gives a fine purple.

In using any of the salts of metals with large quantities of oxide, the proportion of glass must be increased, because all the oxides of metal are fluxes and tend to soften enamels. Yellow oxide of uranium will produce yellow in transparent enamel and cream color in opaque.

Glass of antimony acts similar to uranium, but is not as strong a color.

Oxide of chromium is an especially strong color and a little seems to go a long way. Used in the form of oxide it has a tendency to make enamel hard, but if bichromate of potash be used this is overcome to a certain extent. It colors opaque enamel a very light pea green, and transparent a yellowish green. When mixed with black oxide of copper in the proper proportions a very fine grass green is produced.

Gold is used for making red, and because of this fact red commands an extra high price, but the fact of the matter is that the cost of making a very good red is not as great as is that of black.

White arsenic will make a good white, which can be used as a base for opaque colors. Take five ounces of powdered glass, one and one-half ounces of lead, one-half an ounce each of borax and nitrate of potash and add three-fourths of an ounce of white arsenic. Mix well and melt as in the case of transparent enamel, testing it in fusible and pickle; increase the amount of arsenic for opacity, and about one-half of what will make white will make an opal. The making of opaque yellow is a difficult process at which very few makers are a success. The old-time recipe, which can be found in most any encyclopedia, will, if the directions are followed, make a fine color.

In making enamels start first on a transparent flux, and then get some oxide of cobalt (black), oxide of copper (black), black oxide of manganese, yellow oxide of uranium, green oxide of chromium, red oxide of iron, black oxide of iron, nitrate of copper, permanganate of potash, glass of antimony and 15 grains of chloride of gold. Make a pot of flux colored with a small quantity of each oxide, mark down in a book the proportions used, and number the formula; have a box for the enamel with a corresponding number. When you have at least a dozen colors, make a test of them on silver and oxide; by keeping track of your results you will soon be able to make any color which you want, or at least a good assortment.

(To be continued.)

**C. DORFLINGER & SONS,**

36 MURRAY STREET, NEW YORK.

*Works, White Mills, Wayne Co., Penna.*

Manufacturers of plain and cut Table Glassware of the highest quality.



**ENGLISH :: GLASS.**

Large Assortment of  
FANGY VASES,  
GENTRE PIEGES and  
ROCK CRYSTAL STEM WARE,

Particularly adapted for the  
Jewelry Trade.

Write for particulars.

Sole Agent for the Celebrated CAULDON CHINA.

**EDWARD BOOTE,**  
46 West Broadway :: New York.

**Have You  
Received Our  
New Catalog?**

**Maple City Glass Co.,**  
CUT GLASS TABLEWARE,  
Hawley, Pa.

SALESROOMS:

- New York—H. B. Stiles, 253 Broadway.
- Baltimore—Green & Thomas, 33 S. Charles St.
- Boston—Sweetser-Bennett Co., 101 Tremont St.
- Buffalo—J. R. Stadlinger, 685 Main St.
- Indianapolis—J. A. Dugan Co., 22 S. Capitol Ave.
- Duluth—Duluth Crockery Co., 6th Ave. and West St.
- Denver—Western Selling Co., 1617 Lawrence St.



No. 3399.—Loving Cup. Height, 10 inches.

**The Pairpoint  
Corporation.**

Send for Catalogue showing  
our complete line of

**Prize Cups  
and Trophies.**

BRANCHES:

- 38 Murray Street, New York City
- 36 St. Antoine Street, Montreal, P. Q.
- 717 Market Street, San Francisco, Cal.

FACTORY: NEW BEDFORD, MASS.

Made in America

Not many years ago cut glass meant imported glass. Every dealer knows how this has changed. The same change is taking place now with gold decorated glass. Write for our catalogue of bonbons, compotes etc. if you care to sell the best glass money can buy.

The Honesdale Decorating Co.  
Honesdale, Pa.

Established 1879.

Manufacturer of

**LOUIS W. HRABA,** Fine Leather Goods,

29 East 19th St., New York.

Exclusively for the Jewelry Trade.

**C**LOCKS, BRONZES  
COMMUNITY SILVER  
CUT GLASS, NOVELTIES

SEND FOR CATALOGUE

**H. BEALMEAR & CO.**  
234-236 Park Ave.  
Baltimore, Md.

# THE CONNOISSEUR

*Devoted to Art Pottery, China, Marbles, Bronzes, Cut and Decorated Glass Ware, Bric-à-Brac, Lamps, Art Metal Wares, Fancy Goods and Kindred Lines.*

## The Origin of English Bone Porcelain.

ARTHUR VEEL ROSE, in the *American Pottery Gazette*.)

THE somewhat complex question, "When did bone porcelain first come into general use, and by whom was it first introduced?" is frequently asked, not only by amateurs, but by collectors and connoisseurs alike. It is generally acknowledged that bone porcelain existed as long ago as 1760, and this is evidenced by Sprimont's introduction of bone-ash into the body of Chelsea porcelain, but no factory was making it commercially in any quantity until the year 1800. In that year Josiah Spode II., who succeeded his father, the founder of the old Spode factory, perfected a new porcelain body which was composed of china clay, china stone or feldspar, and bone-ash which was obtained from calcined bones. This porcelain surpassed in quality of paste, translucency and brilliancy of glaze anything hitherto attempted.

This same body is used to-day by practically every English porcelain manufacturer, and is known as "English bone china," or porcelain, in contradistinction to "true" or hard porcelain, such as the Chinese, French or German product. William Burton, F. C. S., in his recent valuable work, "A History and Description of English Porcelain," in referring to this typical body of English porcelain, says:

"This paste may be taken as consisting of 6 parts of bone ash, 4 parts of china stone (petuntse or feldspar), and  $3\frac{1}{2}$  parts of china clay (kaolin) finely ground and mixed. So far as composition goes, it is to all intents and purposes the body of "true porcelain" with a large proportion of added bone ash. Here, however, all resemblance to true porcelain ends. The pieces are first fired to a temperature of about 1,200 to 1,250 degrees C., at which temperature they become beautifully white and translucent. The glaze, which is also of the same type as the glaze of hard porcelain, consists essentially of petuntse or feldspar, and china clay, but rendered more easily fusible by the addition of boracic acid, alkalies and oxide of lead, is subsequently fired on the biscuit body at a lower temperature."

To sum up this portion of the subject we may tabulate the materials and methods of the three main species of porcelain thus:

**True porcelain** (Chinese, Dresden, Bristol, etc.).—Body, or paste, petuntse and kaolin. Glaze: petuntse, sometimes softened by addition of lime. Body and glaze fired at one operation, so that the glaze receives the fiercest heat given.

**Glassy or fritted porcelain** (St. Cloud,

Vieux Sèvres, Bow and Chelsea).—Body, or paste: Largely glass or frit, with a small proportion of white clay. Glaze: A very fusible glass made from red lead, nitre, sand, etc. The first operation was the preparation of the glass or frit. Some of the later English frits were not very glassy, and contained bone ash. The body was fired to what is known as the "biscuit" condition, and the glaze was fired subsequently at a lower temperature.

**English bone porcelain** (practically all English factories of the 19th century).

—Body, or paste: Bone ash, china stone, china clay. Glaze: China stone and china clay, with boracic acid, alkalies and lead oxide. The body is fired first to what is known as the "biscuit" condition, and the glaze is fired subsequently at a lower temperature.

It will be evident that from such differences of material and treatment there must be equally striking differences in the appearance and qualities of the different kinds of porcelain.

Josiah Spode met with such commercial success, owing partly to the fact that this new method of manufacture was considerably less costly than the old, and, in addition, the quality was greatly improved, not only in the whiteness and translucency of the paste, but also in the lusciousness of the glaze, that his competitors were compelled to adopt his methods, and Worcester, Derby, Coalport and all the later porcelain manufacturers began making "bone porcelain," which is the typical English porcelain of to-day.

## Large Amount of Silver Used in the Arts.

THE heavy demand for silver in India and in the Orient generally is having, with other influences, a marked effect on its price. There has been an advance in the price of silver of 20 cents in three years. This advance is expected to continue, and it will have a good effect on the trade in Eastern markets by increasing the purchasing power of the money now used in the Orient. In the first four months of the current year Great Britain exported to India \$30,000,000 worth of silver.

The use of silver in the arts is rapidly increasing, it being estimated that fully 50,000,000 ounces are consumed in that way annually. The United States and Mexico combined yield more than 82 per cent. of the world's output of silver, and they both derive a large advantage from its increase in price.

W. T. Peters, Eureka, Kans., was married June 27.

## How Newark Stands First in the Manufacture of Fine Jewelry.

(From *New Jersey Commerce and Finance*.)

THE jewelry industry in the State of New Jersey is confined exclusively to the city of Newark and nearly 100 classified industries within the State, compiled according to the total amount of capital invested, it ranks not far from the top of the list. Jewelry makers have recently closed a year of unequaled prosperity, and at present are feeling no respite in the demand for their product. Orders are coming to manufacturers from all parts of the country and keeping factories running on full time. Compared with other years, when business usually lagged at this season of the year, it gives evidence of remarkable activity, and manufacturers feel confident the fruits of this year's work will give ample evidence of the country's growth in wealth.

The jewelry business is a barometer of the whole business of the country. Jewelry is a luxury, pure and simple. It is the first business to feel depression, and the last to revive after depression. It is the general business public who indulge their taste for dainty and costly articles of this manufacture, the majority of whom cannot afford to do so under any but the most favorable conditions. The mild Winter past was regarded as propitious for a large Spring trade, and with the receipt of a large number of orders since the holidays many factories have had as much as they can do.

### FIRST JEWELRY FACTORY.

The first jewelry factory was established in Newark in the year 1830 by Taylor & Baldwin, who manufactured fine gold jewelry. A few years later the firm name was changed to Baldwin & Co. Thomas G. Brown was a member of this firm, which was later changed to his name and afterward to Thomas G. Brown & Sons.

While there are many other cities in the United States that manufactured jewelry long before this city, Newark has outstripped them all in the manufactured product of fine jewelry.

The city has acquired a high reputation for the production of fine jewelry and is without a rival in this respect. The product of the factories of New York City is probably its nearest approach, but it does not equal that of Newark. For many years the industry was of large proportions in Philadelphia, but it has not grown so rapidly as here.

The goods made in Newark have been the standard of excellence in all lines of fine jewelry, and the products of the city's



# LIBBEY

THE WORLD'S BEST.

The cut glass world is sharply divided into two classes.

All the other cut glass tries to look like Libbey.

Sometimes it sells for less—but the lower price can't bring it up to the Libbey standard.

Quality considered, Libbey is not only the world's best—it is the world's best value.

The Libbey Glass Co.

TOLEDO, OHIO

New York Salesroom, No. 57  
Park Place.

# Libbey

"THE WORLD'S BEST."

LOOKING FOR  
THE NAME

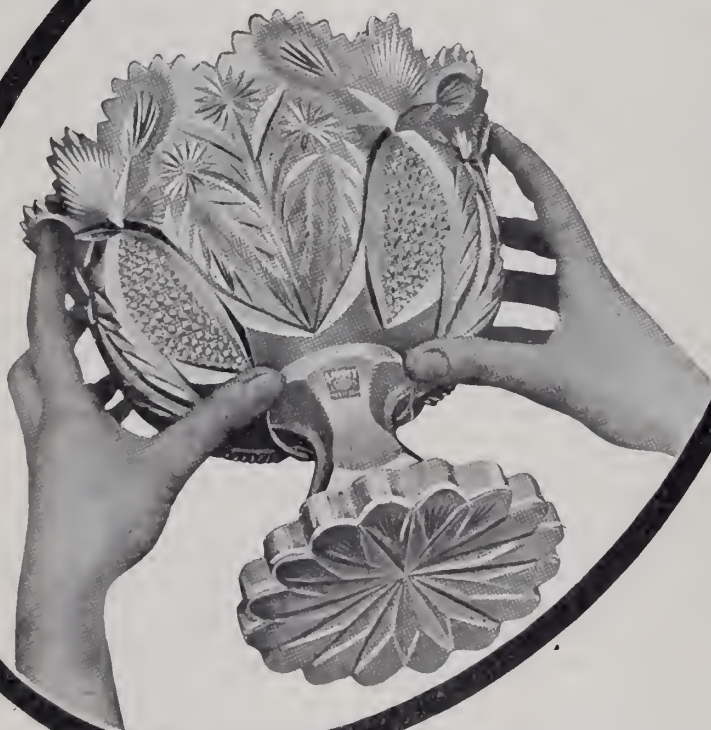

## Glassware

showing "The Colors of the Rainbow." Our line is complete with Vases, Fancy Bowls, Novelties, etc., that range in price from \$1.00 to \$50.00 each.

SEND FOR A SELECTION.

or call at our show rooms. The selling quality is in the sheen and colors; cuts cannot show its beauty.

Tivoli Art Glass Co.

Makers of High Art Iridescent and Decorated Glassware

87 MAIDEN LANE NEW YORK

Telephone 2054 John.

## CROUCH & FITZGERALD



Jewelry Trunks and Cases

177 Broadway,  
Bet. Cortlandt  
and Dey Sts.

688 Broadway,  
723 6th Ave.,  
New York.

CASSIUS W. SEYMOUR,  
37-39 Malden Lane, New York  
ALLOW ME TO CALL ON YOU IN THIS WAY



Jewelers'  
Stationer and Printer  
Jewelers' Cards,  
Tissue Paper,  
Tags,  
Blank Books, etc

ROLL AND FLAT PAPERS

Estimates cheerfully given. Mail orders promptly attended to.  
Let us quote you our prices on manfold book and sealing wax.

JACOT MUSIC BOX CO.,  
IMPORTERS.

Stella and Ideal Music Boxes,  
39 UNION SQUARE, N. Y.

## PATENTS

obtained on inventions and designs. Trade marks, prints and labels registered.

R. W. BISHOP,  
ATTORNEY AT LAW,

908 C Street N.W., Washington, D. C

## WE HAVE WHAT YOU WANT!

A COMPLETE LINE OF

### Jewelry and Silverware Cases

SHOW CASE AND WINDOW DISPLAYS

# ABE KASSEL

671-3-5 HUDSON ST.

NEW YORK

factories are the best and finest known in the trade all over this country. In the manufacture of plated goods New Jersey's products are exceeded in value by those of Massachusetts, New York and Rhode Island. Providence, R. I., and the Hebrons, Mass., produce the largest amount of plated goods of any cities in the country. They are considered leaders in the production of the lower grade of goods made especially for department stores.

#### ABOUT 100 JEWELRY CONCERNS.

There are about 90 to 100 jewelry establishments in the city and every article known to the jewelry trade is made by one. The method of manufacture in recent years has been revolutionized by the introduction of labor-saving machinery, the use of which has given Newark its wonderful lead in the business of jewelry manufacturing in so comparatively short a time. The finest goods, however, are had-made throughout and cannot be produced in any other way. The regular lines of jewelry, such as rings, brooches, lockets, etc., are made in presses especially designed for this purpose, and are afterward finished by hand.

The only product that compares favorably with that of Newark in artistic work is that of France, but the goods manufactured in that country are much more costly. A great deal of jewelry is also manufactured in Germany, but they have never been able to turn out the high grade of goods manufactured either here or in France.

It is estimated that the selling value of the output of high-grade jewelry in this city for last year was in the neighborhood of 10,000,000, an increase of about 15 per cent. over the previous year. Manufacturers would have been well pleased had the business proved equal to that of 1904, but it greatly exceeded their expectations. The factories vary greatly in size, and employ in the aggregate about 3,000 persons, more than 20 per cent. of whom are women.

The total capital invested in this industry in 1902 was almost \$4,000,000. In 1903 it was over \$4,500,000, and in 1904 it had grown to over \$6,500,000. The cost value of stock used in 1902 was just over the 4,000,000 mark; in 1903 it was \$4,248,360 and in 1904 it reached \$4,363,270.

The selling value at manufactory of goods made in 1902 amounted to a trifle over \$8,000,000; in 1903 it was \$8,378,649; in 1904 it totaled \$8,676,987, and in 1905 it is estimated to have been \$10,000,000. The total amount paid in wages was \$1,672,917 in 1902, \$1,753,002 in 1903 and \$1,689,932 in 1904.

Closely allied to the jewelry trade is that of the silversmith, and some of the largest factories in the city are engaged in both grades. In fact, large quantities of high-grade silverware are manufactured here, most of which is distributed without having the stamp of the maker.

The majority of the manufactories are large, and employ a number of operatives, ranging from 10 to several hundred to the establishment.

None but the best of material is used by the factories in the manufacture of their products, the greater portion of which consists of goods of 10, 14 and 18 karat gold.

Manufacturers are working in the standard of values all the time. The larger concerns buy their gold from the Government in gold bricks weighing about 20 pounds and costing from \$5,000 to \$6,000, dependent upon the exact weight. The Government will not sell less than \$5,000 worth at one time.

The majority of the smaller jewelers buy their gold through local banks, several of whom keep a supply on hand for them all the time, and to whom as broker they pay a small commission.

Sterling silver is used exclusively in the manufacture of solid silverware. This is bought by the silversmiths in bars and is melted down and rolled to the required thickness. Some of it is also bought through brokers, but this is usually in small quantities. The local refineries also sell both gold and silver to the jewelry trade in small quantities.

Considerable of the product that is now being made is for the purpose of having stock on hand when the busiest season arrives. There are, of course, changes in style and fashion taking place constantly in the trade, and the question of design is the problem for all the leading houses in the trade. The American public is exceedingly fickle in its taste, and new designs for gold work frequently have to be decided upon from European and American patterns. To guard against loss in this respect as much as possible the larger manufacturers employ expert designers at a cost of many thousands of dollars.

All the precious and semi-precious stones are used by the manufacturers in making jewelry. This was one of the features of the season just closed, and in consequence of the large demand from all sources for this character of product the prices of many of the precious stones have advanced considerably. While these advances are in many cases attributed to the growing scarcity of stones, it is due mainly to the increasing demand which has prevailed for them for several years.

#### QUANTITIES OF DIAMONDS EMPLOYED.

Diamonds are employed in great quantities either separately or in combination with other stones. There seems to be much craving for stones with color, and every stone that can be cut into pretty shapes or that has brilliancy or strength or delicacy of color is being employed. This demand is not only a craze, but is widespread, and lapidaries are kept busy in order to provide the supply required by the jewelry manufacturers. There has also been a heavy call for sapphires, amethysts, garnets and aquamarines. The demand for all of these has been of the richest designs, finest materials and the best workmanship.

The bulk of the product is consumed in the United States, and there is comparatively little in gold jewelry exported by Newark manufacturers. In the majority of cases goods are sold by the manufacturers directly to the retail trade, and the larger concerns have a force of salesmen traveling all year. The character of the goods is too fine to admit of placing them in the hands of middlemen for disposition. The largest trade perhaps is through the west and in the south, and through these sections immense quantities of goods are distributed.



#### CRYSTALLINE HANDSOME EFFECTS IN DOMESTIC POTTERY

glazes on a porcelain body, from the Clifton Art Pottery Co., Newark, N. J., are being shown in the salesrooms of W. H. Dunn & Co., 54 Murray St., New York, and are quite generally admired. Many pleasing effects are produced in variations of the glazes. The Patina line, resembling antique wares, is proving especially popular. An excellent collection of pottery which Mr. Dunn has received from the same works includes vases, bowls, jugs and other articles finished in robin's egg blue. There is also a fine collection of jardinières, which come in graceful shapes and ornamented with figures and designs in relief. Quite a large variety of pottery bases for lamps are shown. W. H. Dunn, of this company, was formerly New York representative of the J. B. Owens Pottery Co., Zanesville, O. Since establishing his present business he has taken the selling agency of a number of companies, including the Clifton Art Pottery Co., Newark, N. J.; J. J. Niland & Co., Meriden, Conn.; Burgun Decorating Co., Brooklyn, N. Y.; Colonial Co., East Liverpool, O.; Cartwright Bros. Co., East Liverpool, O.; Cook Pottery Co., Trenton, N. J.; Excelsior Pottery Co., Trenton, N. J.; A. Radford Pottery Co., Clarksburg, W. Va.; Ransbottom Bros., Roseville, O.; General Mfg. & Supply Co., Trenton, N. J.

#### NEW LAMP SHADES AND ELECTROLIERS.

SAMPLES of new lamp shades and electroliers have recently been received in the New York salesrooms of the Pairpoint Corporation, 38 Murray St. There is an increasing variety in shapes and decorations in floral, leaded and mosaic designs, and buyers will find many attractive designs. The company has been operating its glass cutting works and its decorating plant full time, and expects to continue this activity all through the Summer. The orders that have been arriving preclude the idea of a dull spell, which is not unusual at this time of the year. For some weeks the company has been advertising in New York for glass cutters and decorators for the purpose of strengthening its force with experienced men.

THE RAMBLER.

T. Gumlich, 18 years old, and C. W. Wilson, 17 years old, were sentenced by Judge Gainer in Sioux City, Ia., a short time ago, to six and five months, respectively, in the penitentiary at Anamosa, for breaking and entering the store of A. F. Roekwell, 4th St., Sioux City. When taken into custody the accused had in their possession 36 watches and cases and a number of chains.



Hand Bag.

Established 1850

**C. F. RUMPP & SONS**

Manufacturers of

**Fine Leather Goods**

**PHILADELPHIA**

NEW YORK SALESROOMS - - - 683 and 685 Broadway

Send for Catalogue.



Emergency Case.

# BRACELETS

IN ALL DESIRABLE STYLES AND SHAPES WITH SECRET JOINT AND CATCH OR PATENT SLIDE OPENING

HAND  
CHASED



ARTISTIC  
IN  
DESIGN

INLAID WITH STERLING SILVER AND SET WITH STONES IN ALL NEW SHADES

FINISHED IN ROSE OR ROMAN GOLD  
ALSO POLISHED IN 18K. AND 12K. SHADES

## WM. LOEB & CO.

Makers of Rings and Bracelets

**PROVIDENCE, R. I.,**

**U. S. A.**

## Jewelers' Show Cases.



Our Small **ROSEWOOD MOULDING STEEL LINED CASE.**  
We Challenge the World to Produce a Better Case.

### F. G. JORGESON & CO.

11-17 N. ANN ST., CHICAGO.

Makers of all Kinds of

### Jewelers' Fixtures.

Write for illustrated circular.

OUR MOTTO: The best of Everything.

## FAIRCHILD & COMPANY

225 to 233 Fourth Ave. NEW YORK CITY.

Manufacturers of GOLD PENS, PENCILS, PENHOLDERS, SEGAR CUTTERS, SPECIALTIES, PENCILS SET WITH JEWELS.



Style, quality and workmanship acknowledged the very best.

### Horological Department,

**BRADLEY POLYTECHNIC INSTITUTE,**  
Formerly Parsons Horological Institute,  
PEORIA, ILLINOIS.

Largest and Best Watch School in America.

We teach Watch Work, Jewelry, Engraving, Clock Work, Optics. Tuition reasonable. Board and rooms near school at moderate rates. Send for Catalog of Information.

### Encyclopedia-Dictionary

and reference hand-book of the Ophthalmic Sciences.  
Price, \$2.50.

The Jewelers' Circular Pub. Co., 11 John St., N. Y.

# PLATINUM AMERICAN PLATINUM WORKS

NEW YORK OFFICE 41 Cortlandt Street NEWARK, N. J.

## DIAMOND POINT FOUNTAIN PENS



No. 2WC \$7.50 per dozen. Guarantee in every box.

Largest Manufacturers of Popular Price Fountain Pens in the United States.

Send for Illustrated price list of 11 Kt. Gold Fountain Pens. Good case assortment 1 dozen pens, \$9.00.

**DIAMOND POINT PEN CO.** - - - **100-102 Beckman Street, New York**

# A Jewelers' Electric Lathe Motor

This illustration shows one of the eight different styles and sizes of Jewelers' Electric Lathe Motors, manufactured by The Holtzer-Cabot Electric Co.

Every Holtzer-Cabot Jewelers' Lathe Motor is backed by an absolute guarantee of one year.

which has passed through the experimental stages and which, through a careful elimination of defects, has become practically perfect.



In using Holtzer-Cabot Jewelers' Electric Lathe Motors you receive the benefit of their thirty years' experience in the building of electrical apparatus, and you get a motor which has had four years' trial in practically all classes of buffing, grinding, polishing and kindred uses.

Send for our special circular No. 409, regarding our offer of "A Jewelers' Lathe Motor on Trial."

MAIN OFFICE,  
BOSTON (Brookline), Mass.

The Holtzer-Cabot Electric Co.

CHICAGO OFFICE,  
395 & 397 Dearborn St.

## THE THOUSAND ISLANDS

will be more attractive than ever this season. The New York Central Lines Four-Track Series No. 10, "The St. Lawrence River from the Thousand Islands to the Saguenay," contains the finest map ever made of this region. Copy will be sent free, postpaid, on receipt of a two-cent stamp by George H. Daniels, Manager, General Advertising Department, Room 61A, Grand Central Station, New York.



REACH THE THOUSAND ISLANDS FROM EVERY DIRECTION

C. F. DALY, Passenger Traffic Manager, New York.

## WATCH REPAIRS

FOR THE TRADE ONLY  
WE BEAT THEM ALL!  
in Prices and Quick Service

MAEBERT & REISS

and 73 Nassau Street - NEW YORK

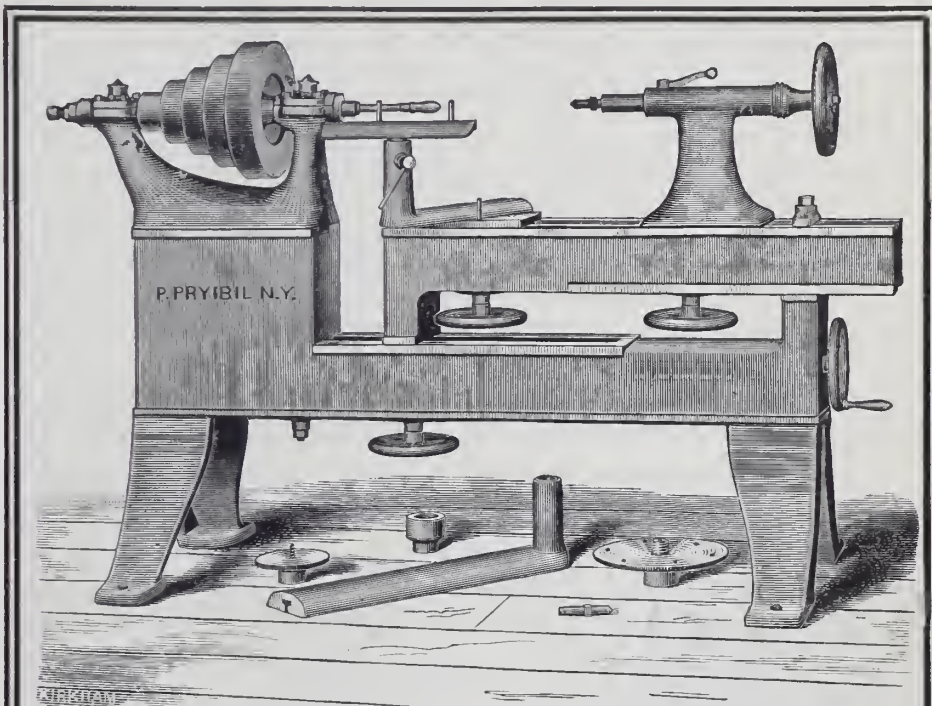

## Above Cut Shows Our EXTENSION SPINNING LATHE.

Swing of lathe 22 inches when closed, 44 inches when extended.

Substantially built for heavy work.

Write for Catalogue

P. PRYIBIL, 512-524 W. 41st St., New York.

*Mercantile Fountain Pen*

**The Best Self-Filling Attachment**

made and guaranteed by

**AIKIN, LAMBERT & CO.,** 19 Maiden Lane, NEW YORK.

Retail Price:

\$3.00

\$3.50

\$4.50

Send for Price Lists and Discounts.

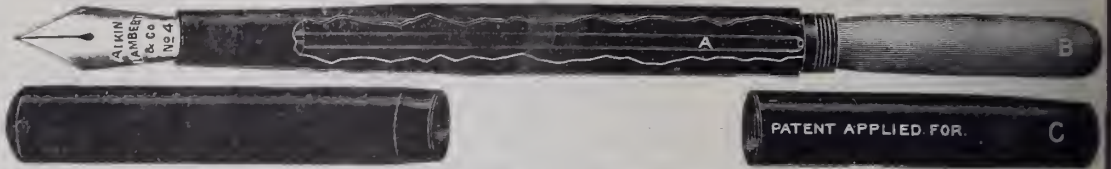

**WHY NOT SEND YOUR SWEEPS DIRECT TO THE SMELTERS?**

**LEES & SANDERS,**  
**BIRMINGHAM, ENG.**

Our plant is right up-to-date and specially arranged for smelting jewelers' sweepings

SEND ON AN ENQUIRY FOR REFERENCES ON YOUR SIDE.

ESTABLISHED IN 1870.

**BLANCARD & CO.,**

96 MAIDEN LANE,

NEW YORK.

WELL MADE GOLD FINDINGS.

**-: Comparison :-**

ofttimes leads to better returns. We invite investigation and guarantee satisfaction.

Send us a trial order.

**CONLEY & STRAIGHT,**

Gold and Silver Refiners,  
Assayers and Sweep Smelters,

236 EDDY STREET, - PROVIDENCE, R. I.

Dealers in Fine Gold,  
Silver and Copper.

All kinds of Gold  
and Silver Anodes.

**WM. F. RENZIEHAUSEN CO.,**  
**GOLD and SILVER REFINERS**

Sweep Smelters, Assayers and Analytical Chemists

Rolling of FINE AND STERLING SILVER a Specialty.

Long Distance Telephone, 3759-R.

45-49 Oliver Street, NEWARK, N. J.

**F. JEANDHEUR, Jr.**  
Rear 17 John St., N. Y. Third Floor.

**Gold and Silver Plating**  
SPECIAL WORK AND COLORING  
IN ALL SHADES A SPECIALTY.

Established 1868.

Platina Plating.

**Trade-Marks** of the Jewelry and Kindred Trades.

Second Edition. Price, \$3.00. The Jewelers' Circular Publishing Co., 11 John St., New York.

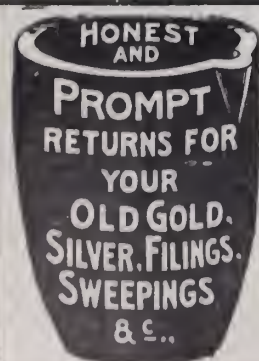

**WE BUY**

Old Gold and Silver Filings, Polishings, Sweeps, Hand Washings, etc. We will make accurate valuations and hold consignment subject to your acceptance. If valuation is not satisfactory, we reship to you at our expense.

**WE PAY FOR OLD GOLD:**

22 K. 88c. per dwt.	12 K. 48c. per dwt.
20 K. 80c. " "	10 K. 40c. " "
18 K. 72c. " "	8 K. 32c. " "
16 K. 64c. " "	6 K. 24c. " "
14 K. 56c. " "	4 K. 16c. " "

MARKET RATES FOR SILVER AND PLATINUM.

Try us and you will appreciate our Squareness, Promptness and Accuracy.

**T. B. HAGSTÖZ, Ltd.,** Main Office, 709 Sansom St., Philadelphia, Pa.  
SMELTERS, ASSAYERS, REFINERS.

**WE SELL**

Gold, Silver and Platinum, various qualities, rolled flat or drawn to wire of any gage.

**PRICES OF ALLOYED GOLD:**

10 K. 48c. per dwt.	14 K. 64c. per dwt.
12 K. 56c. " "	16 K. 72c. " "
18 K. 80c. per dwt.	

Gold and Silver Solder, either from formulas furnished or our own. "T. B. H." Alloy, 25c. per oz. Guinea Gold, 75c. per lb. Shot Copper, 40c. per lb. We will send tables for alloying without charge. They save figuring.





B 2624

# BROOKLYN BRISTOL CASE

*"It's the little things in life that count."*



B 2815

We thought we had considered every feature when we put the

## *Brooklyn Bristol Case*

on the market to take its place in the lead of all other 25-year cases—but by constant study our experts have added a new feature—

*A Combination of Green and Yellow Gold Color Effects.*

Can you realize the artistic beauty of the engine turning all around the shield in case 2624, being a delicate green, while the rest of the case carries a rich yellow gold color?

The contrast is very marked and the effect adds more real beauty to the case than one would imagine possible.

JOSEPH FAHYS & CO.



B 2907



B 2779

# The Only Middlemen



KNOWN TO THE CUSTOMERS OF

## J. R. Wood & Sons,

DIAMOND CUTTERS,

2 Maiden Lane,

NEW YORK.

# PROGRESS

New York's New Under-ground Railroad Built by "the Ring."

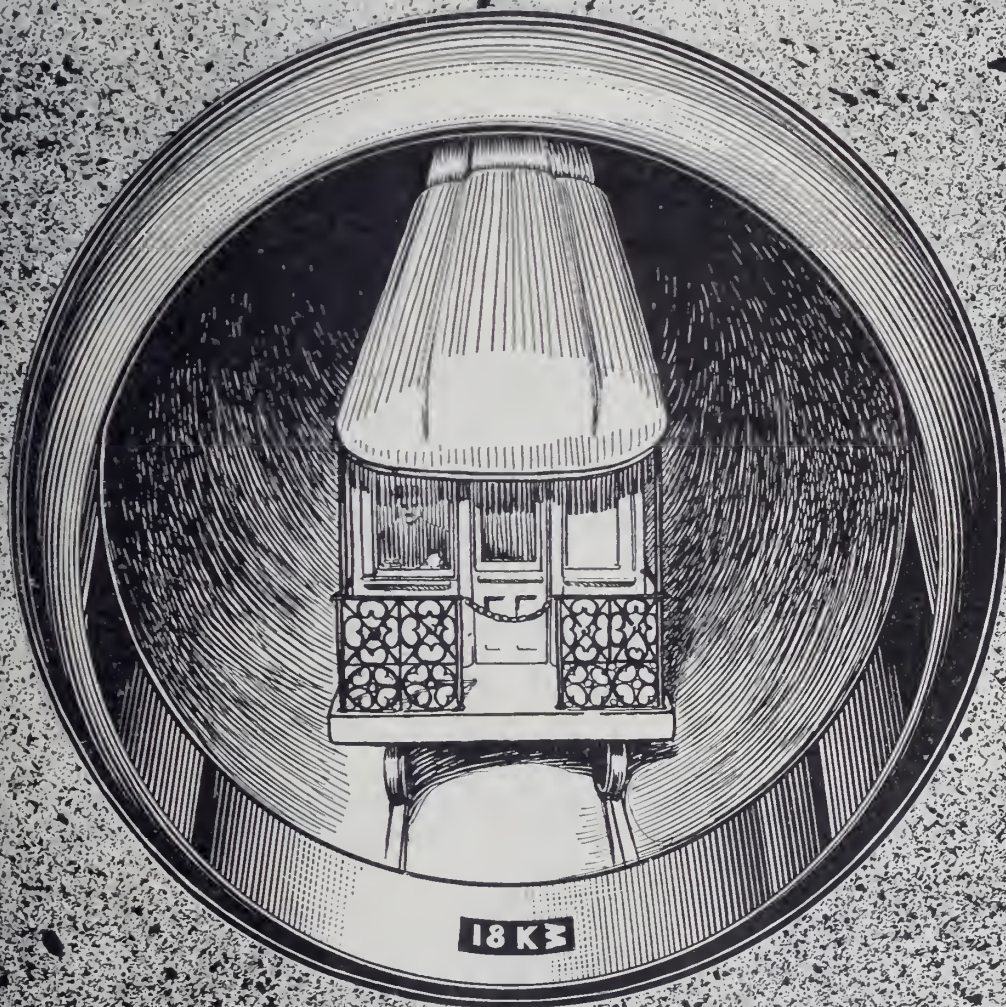

Makers of Plain Rings for Over 50 Years

2 Maiden Lane

NEW YORK

# Design, Workmanship, Quality and Durability

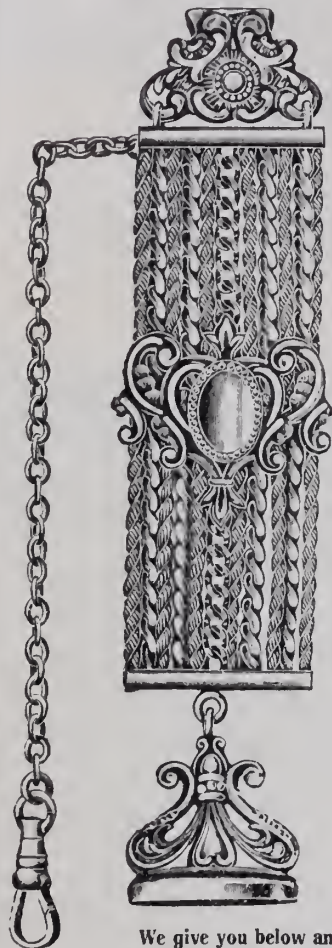

are the four factors which have made the

## BIGNEY CHAINS

the most popular in the market to-day. They are handled and worn by more people than any other make.



We give you below an exact copy of an assay of chains manufactured by the leading chain makers of the United States.

1-10 GOLD FILLED WATCH CHAINS, MINUS BAR AND SWIVEL.

Number	Gross Weight		Fineness	Value	Maker	Chain Number	Cost
	Ounces	Dec.	Gold 1000ths				
15		71	29½	\$0.43	S. O. Bigney & Co. - - - -	1155	\$2.85
16		75	50	.775		482	3.08
17		81	34	.57		3005	2.73
18		76	23½	.37		9533	2.97
19	1	00	16½	.31		83	2.14
32		52	49½	.53		213 X	2.83
34		73	34½	.52		733	2.41
46				.58		5011	3.82

1-8 CHAINS, MINUS BAR AND SWIVEL.

Number	Gross Weight		Fineness	Value	Maker	Chain Number	Cost
	Ounces	Dec.	Gold 1000ths				
35		57	68	\$0.80	S. O. Bigney & Co. - - - -	1604	\$3.96
36		60	65½	.81		7015	3.75
37		63	63	.78		4324	4.00
47		49	79	.80		2726	4.00

# S. O. Bigney & Co.

NEW YORK OFFICE,  
3 MAIDEN LANE.

FACTORY, Attleboro, Mass.

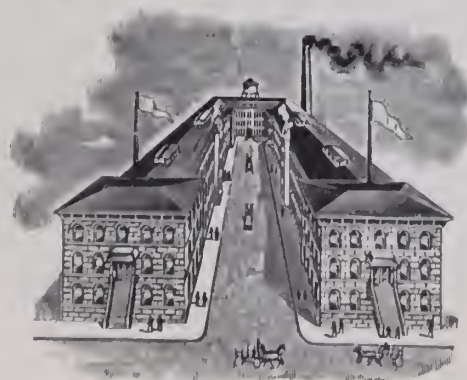



No. 301.



No. 302



No. 305.



No. 308.



No. 300.



No. 3.



No. 18.



No. 11.



No. 14.



No. 12.



No. 317.



No. 306.



No. 196.



No. 307.



No. 209.



No. 322.



No. 208.



No. 318.

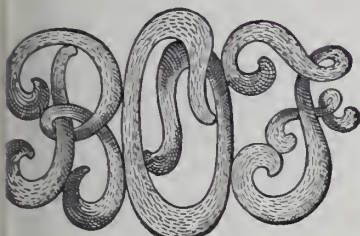

No. 316.



No. 321.



No. 320.

# Wendell & Company

MAKE

## GOLD MONOGRAM CHARMS, FOBS, SLIDES, BROOCHES AND RINGS.

SILVER MONOGRAMS for BROOCHES, BELT ORNAMENTS and CLASPS; also for LEATHER BAGS, PORTFOLIOS, MUSIC ROLLS AND ALL KINDS OF EBONY, IVORY AND TORTOISE SHELL GOODS.

ALL ORDERS PROMPTLY EXECUTED.

103 and 105 WILLIAM STREET  
NEW YORK

2 FACTORIES:

57 WASHINGTON STREET  
CHICAGO

# WADSWORTH

## 14-Karat Solid Gold Cases

THE EXCELLENCES which have given pre-eminence to **WADSWORTH WATCH CASES** reach their highest development in these Solid Gold Cases. Here the standard of the purchaser can be no higher than that of the manufacturer. A Case of Highest Quality.

THE PATTERNS and Models of the **WADSWORTH 14-KARAT SOLID GOLD WATCH CASES** are fine examples, embodying the Shapes and Designs most in line with prevailing phases of popular taste. They have strong, salable qualities, especially in view of reasonable prices.



# WADSWORTH

## 14-Karat

### Solid Gold





Do the retail jewelers appreciate what they were paying for 12 Size movements before our 12 Size was on the market?

Do the retail jewelers appreciate what they were paying for O Size movements before our O Size was on the market?

Do the retail jewelers stop to consider what they would be paying for movements if there was not an independent watch company manufacturing a complete line of superior watches?

ILLINOIS WATCH COMPANY  
SPRINGFIELD





**S**ILVERWARE destined for the general service and adornment of the table should, in order to be wholly satisfying, possess not only a markedly decorative effect, but an opulent dignity and a well defined individuality of design.

¶ It is the belief of the Whiting Company that in their new Louis Quatorze pattern, which has been applied to every article suitable for table use, these essentials of success are very prominently displayed.

¶ With the confidence born of this belief, therefore, they beg to call attention to their novel and original treatment of one of the most popular, as it is one of the most effective, of historical styles.



**WHITING MFG. CO., SILVERSMITHS**  
Broadway and 19th Street, New York.

## **Dueber Watch Cases**

## **Hampden Watch Movements**

“Dueber-Hampden” stands for honesty, integrity and consistency. Added to these qualities the talent and energy devoted to the development of

### **DUEBER-HAMPDEN WATCHES**

have earned for them the enviable reputation of

## **The Leading American Watch**

Made in all sizes and sold only as complete watches in 3/0 size and 12 size, cased in solid gold and gold filled cases of the most artistic designs.

## **The W. J. JOHNSTON COMPANY,**

Wholesale Agents of the Leading American Watch Companies,

**Fifth Avenue and Market Street, Pittsburgh, Pa.**

# **The W. J. JOHNSTON COMPANY,**

Wholesale Agents of the Leading American Watch Companies,

**Fifth Avenue and Market Street, Pittsburgh, Pa.**

---

## **Hamilton Watches**

## **Illinois Watches**

Made to be sold by live, progressive, American Retail Jewelers who realize the credit to be gained from selling reliable, accurate time pieces.

---

Protection to the Retail Jeweler is the "watchword" of The Hamilton Watch Co. and The Illinois Watch Co., and every effort will be made to restrict the sale of these watches to the Legitimate Retail Jeweler.

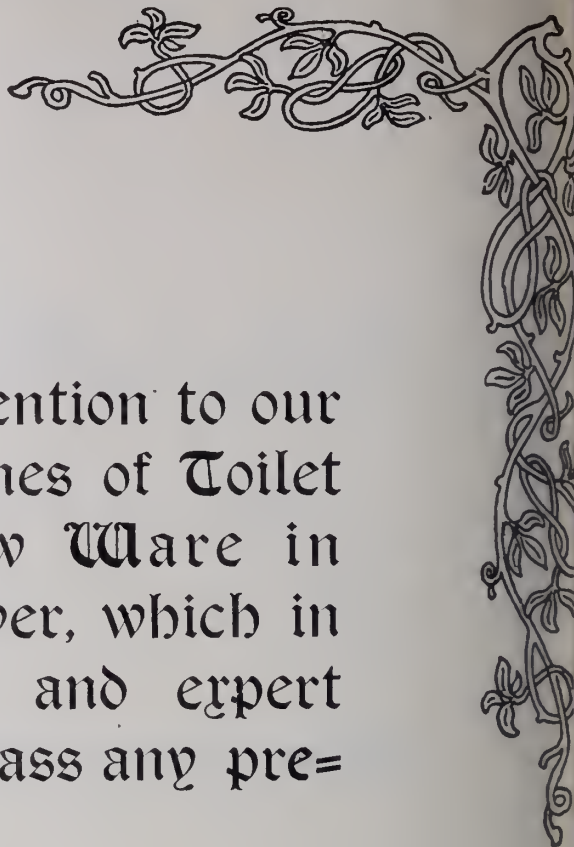

**W**E direct attention to our new Fall lines of Toilet and Hollow Ware in sterling silver, which in artistic conception and expert craftsmanship surpass any previous display.

Owing to the novel character of our Toilet Sets we will be unable to show same until about July 20, but we are sure you will agree that these sets are a radical departure from anything heretofore attempted. They will be illustrated shortly on this page.

**Woodside Sterling Co.**

Silversmiths

192 Broadway, New York

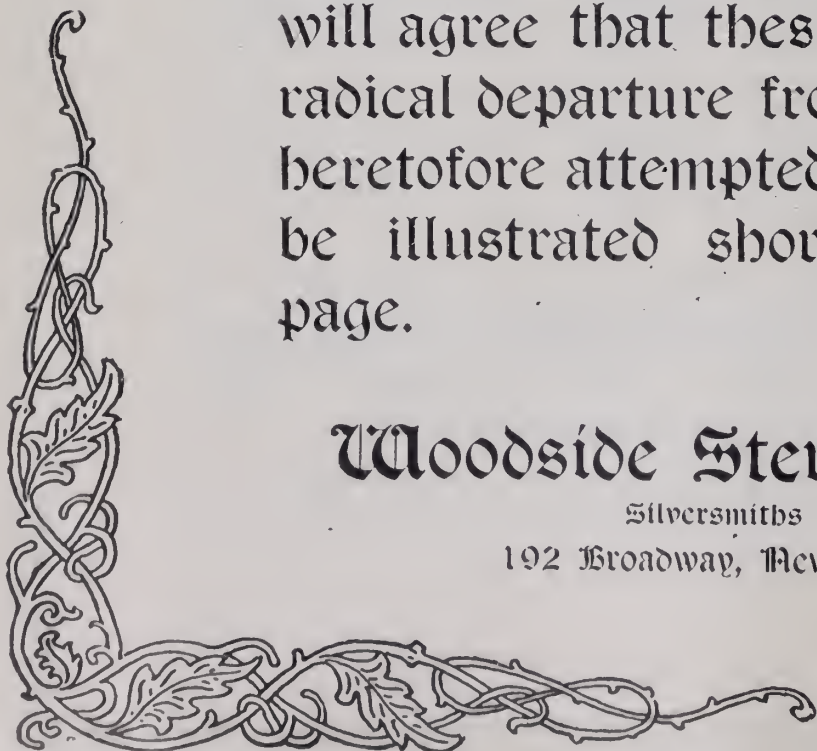

# Three New Patterns

---

---

OUR SALESMEN are starting on their display trips, and are showing a very large number of new designs in Ladies' and Gentlemen's Card Cases, Photo Frames, Baskets, Jewel Cases and other Novelties, and *three new and original patterns in Toilet Sets and Manicure Articles.*

For over 45 years we have enjoyed the distinction of originating the most handsome and best selling patterns in our several lines, including flat ware and napkin rings, but in the present offerings we excel all our previous efforts. Our etched effects supersede anything on the market at present.

We can supply Combinations in Toilet and Manicure Sets, arranged in handsome silk-lined cases. These combinations are beyond anything ever shown in the past.

Determine now to see these new creations; it will pay you well, and an opportunity will be lost if you neglect it.

These entire lines will also be on exhibition at our New York Showrooms.

TRADE  MARK.

---

---

## R. BLACKINTON & CO.

ESTABLISHED 1861.

3 MAIDEN LANE, NEW YORK

Factory, North Attleboro, Mass.



July justifies the confidence in the standard of **HB** Rings. Progressive jewelers realizing the value of judicious fall purchases are making Heintz Creations the selection for the coming season.

Beauty of design, artistic workmanship and excellence of finish enhance the "selling value" of **HB** Rings.

HEINTZ BROTHERS, Buffalo, N. Y.

*"We never follow the Fashion, the Fashions Follow Us."*

MAURICE L. POWERS.



JOSH W. MAYER.

## GRADUALLY

**O**UR stock is assuming immense proportions. We are gradually approaching the opening of our FOURTH ANNUAL EXHIBITION, which takes place in our offices between August 13th and 18th, inclusive.

We desire to make this display the most impressive of any heretofore given by us, for the reason that the prosperity everywhere is at its fullest and this has encouraged us to give full scope to the production of a remarkable display of Jewels. The reason we feel that this coming exhibition will be a remarkable one is that we have articles in Diamond Jewelry from twenty-five dollars up to thousands of dollars, so that a Jeweler from the smallest town or the largest city will find this display most interesting.

We have made this exhibition a little later than the preceding ones, so that it will be more convenient for most Jewelers to be with us around this date.

We can positively state from what is now finished that, by the time we are ready to open our display, it will be the most remarkable line of Diamond Jewelry ever shown in this country.

Once a visit always a visit.

## POWERS and MAYER,

Makers of Diamond Mounted Jewelry THAT SELLS.

258-260 Fifth Avenue,  
NEW YORK.

We are always pleased to ship goods on memorandum when satisfactory references are given.



View Ready for Use. Height, 8¾ inches.

## The Sternau Traveling Companion Serviceable Indoors and Outdoors

**J**EWELERS can increase their sales by stocking Sternau Traveling Companions which are the most useful articles for preparing hot luncheons when camping or yachting. ☐ For use in the nursery and the sick-room, for heating milk and broths and cooking cereals, they are of inestimable value. ☐ Being clean, neat, compact, and exceedingly convenient, they are used by tourists, travelers, sportsmen, picknickers, etc. Made in Nickel-plate and Silverplate.

☐ Circular No. 251 of Traveling Companions, sent on request.



View Showing the Parts Inside the Cup. Height, 4½ inches.

New York Salesrooms:  
Broadway, cor. Park Place,  
Opposite Post Office.

**S. STERNAU & CO.**

*Makers of Chafing Dishes, Coffee Machines, Fancy  
Kettles, Smoking Sets, etc.*

If It Burns Alcohol We Make It.

Office and Factory:  
195 Plymouth Street,  
Brooklyn, N. Y.

## The CLOVERETTE

Every piece bearing

**TRADE MARK**

which has been well known for

**TWENTY-FIVE YEARS**

A GUARANTEE

FOR QUALITY AND FINISH



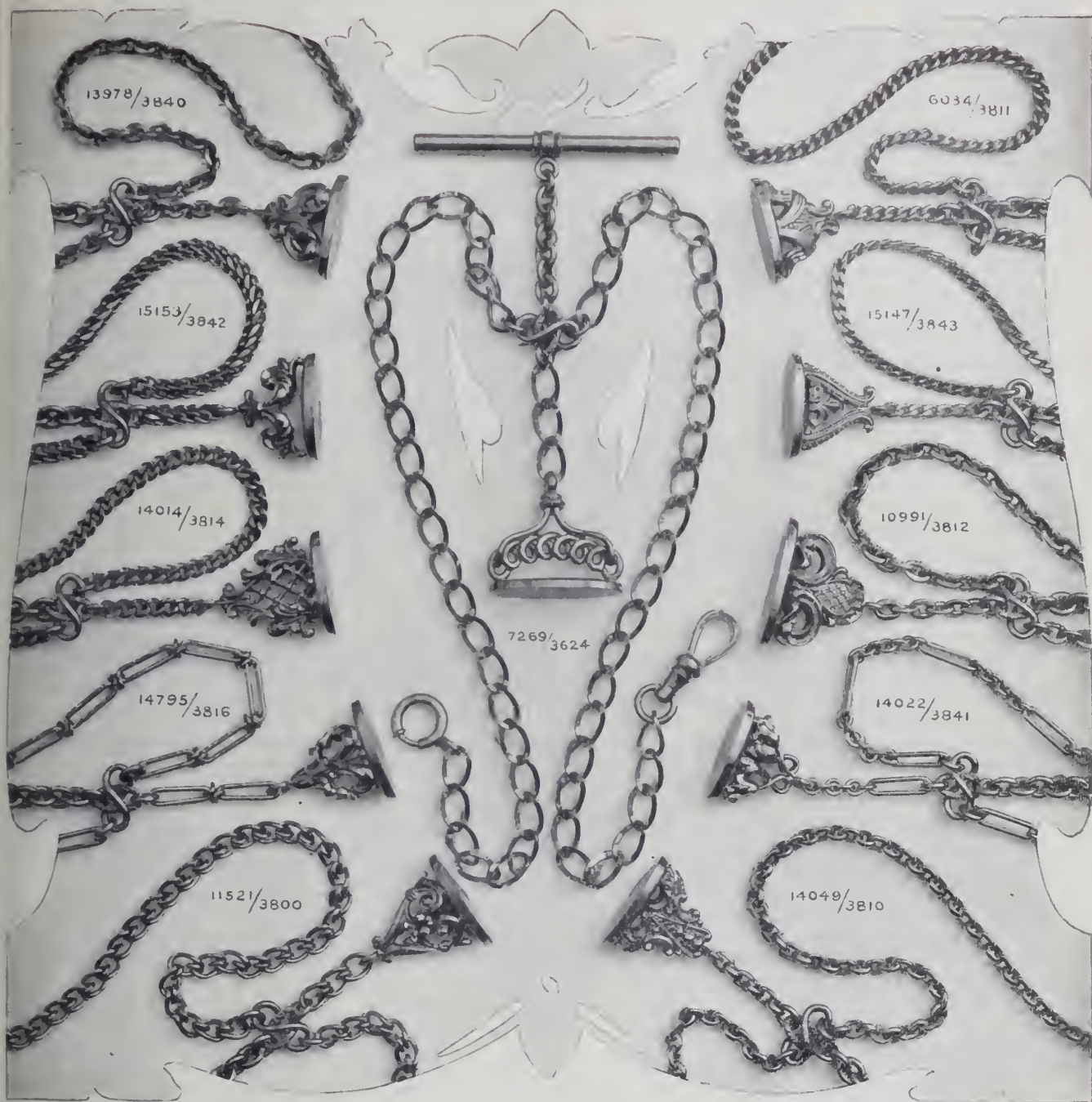

Surely you'll agree that these Simmons Dickens patterns with signet seals are about the smartest things in men's chains that have been shown. If you also agree that they ought to be included in your Fall chain display, an early selection is advised.

A representative showing of patterns may be seen at almost any wholesale jewelry house.

**R. F. SIMMONS COMPANY, Main Office and Works, ATTLEBORO, MASS.**  
Salesrooms, 9-13 Maiden Lane, New York; 42 Madison St., (Heyworth Bldg.), Chicago.

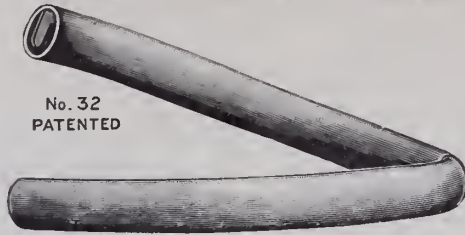
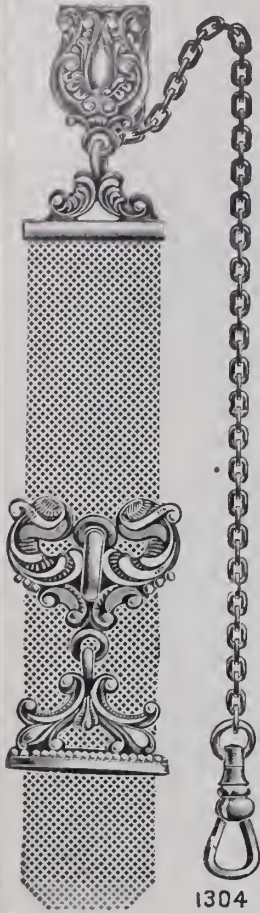

No. 32  
PATENTED

## The New "Bates" Bracelets

"Kant-Kum-Off"  
Made in Seven Sizes

Ask your jobbers for THE BATES BRACELETS and you get the BEST



B.190  
PATENTED

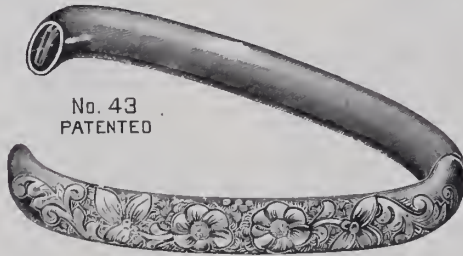

No. 43  
PATENTED

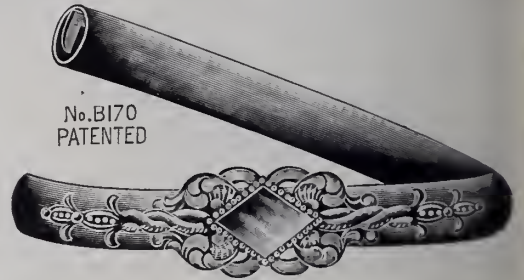

No. B170  
PATENTED

# BATES & BACON

Attleboro, Mass.

Makers of HIGH GRADE CHAINS

The BEST SAFETY FOB is one of our specialties; Gent's Vests, Dickens, Lorgnettes, Secret Locket Chains, Locketts and Chatelaines.

OFFICES:

NEW YORK,  
9 Maiden Lane.

CHICAGO,  
103 State Street

## THE Bracelet Hit OF THE Season.

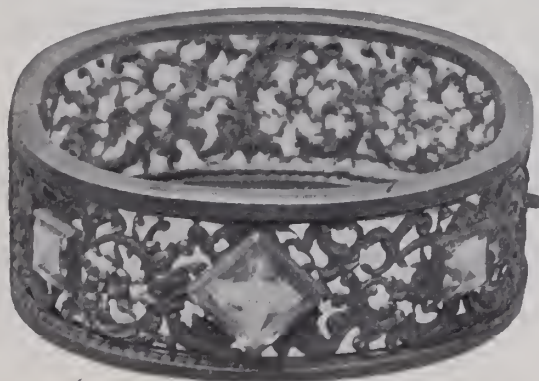

THE illustrations, which are exact size, show two of the best selling Bracelets of a big bracelet season.

Made of Rolled Plate, Pierced, Engraved—a neat, strong joint and catch—with and without stones, from 1/2 to 1 1/4 inches wide.

Our line offers an unsurpassed range of styles.

ASK YOUR JOBBER—HE HAS THEM.

**WHITING & DAVIS, Plainville, Mass.**  
NEW YORK OFFICE, 7 MAIDEN LANE.

# ZIMMERMAN'S ELK MASTERPIECE

Ever on the alert to improve our already most popular line of Elk emblems, we have added what we consider the

## Most Wonderful Reproduction of an ELK Head

in gold ever attempted. This is known as the Zimmerman Masterpiece of an Elk.



This Elk head is an exact reproduction in gold of Zimmerman's Masterpiece, "The Elk," which is world famous, receiving

## Prizes at Every Exhibition Where Shown

Every line in the painting has been faithfully reproduced by us in the emblem.

We are making this head in 3 sizes (medium, small and midget) in both gold and silver, and in various finishes, also combining it with the dial, with and without diamonds and other precious stones. If your jobber does not handle our line, send for a selection package. Our phenomenal success has inspired many imitators. There is but one line of FOX Emblems, and all goods of our make are stamped with this trade-mark  A quantity or low price may sell the first bill, but quality as well is required to get succeeding orders. Our goods are of the highest standard of quality.

# THE GUSTAVE FOX CO.

Branches in Antwerp, and Oakland, Cal. (temporarily)

14-16 E. Fourth Street, CINCINNATI, OHIO

# ROBERT LEVY'S

THE NAME THAT

STANDS FOR QUALITY

There must be dreary days. It is logical. Sages and wise men tell us that were the sun to shine on all days it would soon become monotonous. How cheerful those dull days can be made if we go about it in the proper way.

## Send for a Selection Package

and store it away for a rainy day. You have no idea what a difference it will make. Full line, beautifully designed and carefully executed in

10K. that is 10K.

# ROBT. LEVY,

Manufacturing Jeweler  
Green and Columbia Sts., Newark, N. J.

# The Allsopp Rings

THE UP-TO-DATE LINE OF  
**SIGNET AND SET RINGS**



In twenty years we have built up a business second to none in Rings exclusively. ALLSOPP QUALITY, DESIGN and WORKMANSHIP appeal to the most fastidious. It will pay you to examine a selection package.

**A ★**  
TRADE-MARK.

**ALLSOPP BROS.,** ALLSOPP BUILDING, Newark, N. J.

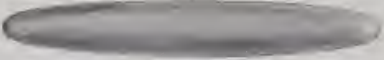

Quality and Finish Consistent  
with twenty years' experience.  
Original and Exclusive Designs.



## MOORE & SON,

ESTABLISHED 1886. NEWARK, N. J. INCORPORATED 1903.

## SIGNET RINGS



TRADE MARK 

### Geo. O. Street & Sons

Est. 1837

24 John St., New York.  
103 State St., Chicago.

### ROBERT DULK DESIGNER,

Etching in Gold and Silver  
Telephone, 3960 Chelsea.

No. 70 5th Avenue, NEW YORK

# The Bowden Rings

ARE COMPLETE IN VARIETY, CORRECT IN  
QUALITY AND PERFECT IN FINISH. WE  
MAKE EVERY VARIETY OF FINGER RINGS.

## J. B. BOWDEN & CO.,

1 Maiden Lane.

NEW YORK.

GOLD  
RINGS

BROOCHES AND MOUNTINGS

Also GOLD FILLED RINGS, including the popular THREE CROWN

Ostby & Barton Company respectfully announce to the jobbing trade that their fall line comprising many new and original designs is now ready.

OSTBY & BARTON COMPANY

New York, 13 Maiden Lane  
Chicago, 103 State Street

PROVIDENCE, R. I.



Tortoisene  
Combs

Mounted with 10-K. hand-work patterns. Every design is characteristic of originality and every detail is significant of superior workmanship.

*Tortoisene* is hard to detect from the real tortoise shell, having a rich effect that pleases the most skeptical in artistic hair treatment.

This cut represents a few of our patterns, actual size.

Combs will be much in demand throughout the year and orders should be in advance to insure prompt attention.

Prices on request.

Schultz, Leiss & Co.

OFFICES

New York, 14 John St. Chicago, 103 State St.

FACTORY

Cor. McWhorter and Oliver Sts., Newark, N. J.

# Appropriateness in Mountings



GENUINELY artistic mountings call for expert judgment and skill. Every stone possesses some individual characteristic with which the mounting should harmonize. Thus added value may be imparted. Such appropriate mountings are a specialty here.



**Durand & Company,**

49-51 Franklin Street,  
Newark, N. J.



## A COMPLETE LINE

of some of our handy pins. Made in all colors, sizes and finishes.

**A. J. HEDGES & CO.,**

Makers of Exclusive Designs in 14k. Jewelry.  
14 JOHN STREET, NEW YORK

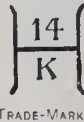

## Adjustable Glove Garters

IN  
GOLD AND SILVER

### Gold Jewelry

14K. in 10K.

Plain, Chased, Engraved, Diamond Set  
BRACELETS, BROOCHES,  
LINKS, LOCKETS, ELK  
BUTTONS, ETC.

**Chas. L. Trout & Co.,**  
15 MAIDEN LANE, NEW YORK.



## OSMUN-PARKER MFG. CO.

MAKERS OF

*Fine Pearl and Diamond Goods*

338 Mulberry Street  
NEWARK, N. J.



ESTABLISHED  
1871.

Factory and Office: Newark, N. J.

INCORPORATED  
1900.

## CARRINGTON & CO.,

*Patent Pocket Match Box*

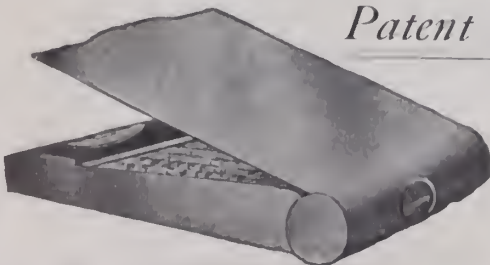

14K. ONLY IN STOCK

Book Safety Matches with  
Steel Cigar Cutter.  
(Patented.)

Sales Agent:  
7 Maiden Lane,  
NEW YORK.



## Unique Silver Deposit WHISKEY JUG



7 Inches High.

Just one piece from one of  
the best selling and most  
attractive lines in town.

**Depasse Mfg. Co.,**  
41-43 Maiden Lane, New York.



"GRIP"  
The King of all card games, price 2c  
sample pack 16c., two 30c., eight \$1.00  
Sent prepaid at once (only on receipt  
of price). See last week's issue of Cir-  
cular for prices of my Ring Adjusters  
which every jeweler should have in  
stock. Order 1 doz. asst. Enclose the  
amount. Mention order No. J and  
will forward a sample pack of Grip  
extra. Order them to-day.

**CHESTER H. WELLS,** Jeweler, Meshoppen, Pa.



## Demand for the Barrette

**H**ATLESS WOMEN on Summer outings find it necessary to protect the hair from boisterous winds. For this the Barrette well supplements Back and Side Combs. In growing demand.

### IN GOLD

with Colonial Engraved effect. Vermicilli trim and Fancy Applied Work. Mounted with Pearls and Fancy Stones.

IN TORTOISE-SHELL gold-mounted and set with Pearls.

ALSO A SPECIALTY.

## Day, Clark & Company

14 KARAT  
ONLY



23  
Maiden Lane  
New York

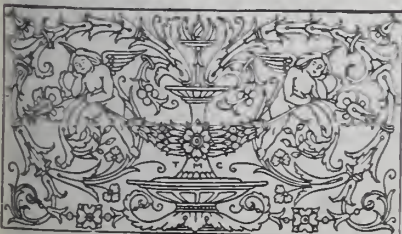

## WHITESIDE & BLANK Bride's-Rose

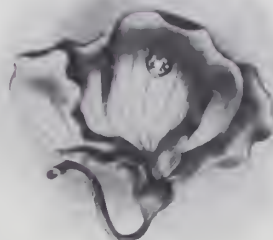

BROOCH No. 1685

*Pink Enamel  
and Green Gold*

NEWARK, N. J.,  
Lafayette and Liberty Streets.

NEW YORK,  
14 and 16 John Street.

ESTABLISHED 1841.

# Carter, Howe & Co.

TRADE



MARK

MANUFACTURERS OF

## Gold Jewelry,

9, 11, 13 MAIDEN LANE, - NEW YORK.

FACTORY, NEWARK, N. J.

A. CARTER.

G. R. HOWE.

W. T. CARTER

W. T. GOUGH.

## "THE BRACELET HOUSE." KENT & WOODLAND,

BRACELETS FOR EVERY WOMAN AND MISS.

16 John Street, New York.

San Francisco Office,  
Care JULIUS A. YOUNG.

"Nethersole Bangles,"  
Plain and with Stones.

"Pinhole" Secret Snap,  
with and without pre-  
cious and semi-precious  
stones.

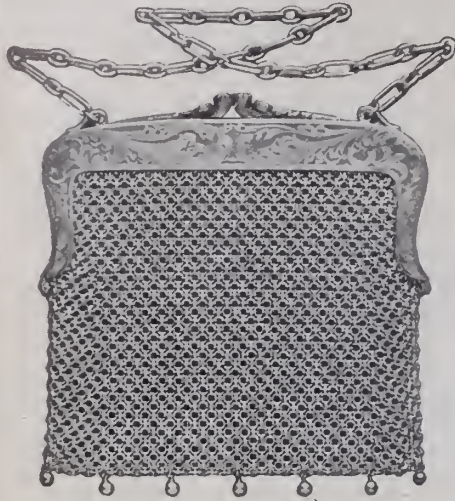

# S. Cottle Co.

GOLD AND SILVER BAGS  
AND PURSES, NEW STYLES  
AND DESIGNS—ALL OF  
SUPERIOR WORKMANSHIP.

31 East 17th Street,  
New York.



The Rosary  
in Fine Jewels

Fine  
Rosaries  
in pure  
and  
imitation  
stone.  
Mounted  
in solid  
gold and  
rolled  
gold-plate

ALL COLORS



Our special  
illustrated catalogue  
will give interesting  
advice regarding  
prices and discounts.

MADE BY

The **W. J. Feeley Co.**  
Providence, Rhode Island,  
Ecclesiastical Art Metal Workers.

## Bridesmaids' and Ushers' Pins

We would suggest something with color. Brooches, Scarf Pins and Handy Pins with Amethysts, Topazes, Garnets, Peridots, Aquamarines, Jades and Baroque Pearls. We have a large variety of patterns at moderate prices.

REGARDING OUR FOBS WE HAVE NOTHING TO SAY—  
THEY SPEAK FOR THEMSELVES.

**SNOW & WESTCOTT,**  
Makers of Good Jewelry for Over Seventy Years,  
21 MAIDEN LANE, NEW YORK.

ADOLPH LUTHY.

### LUTHY & HINE,

PERCY W. HINE.

13 EAST 30TH STREET, NEW YORK.

MANUFACTURERS OF

**Artistic Gold and Platinum  
Mounted Diamond Jewelry.**

Odd and Exclusive Patterns in NECKLACES, BROOCHES, BRACELETS,  
RINGS, RIBBON COLLARETTES, Etc.

MOUNTED WITH AQUAMARINES, PERIDOTS, AMETHYSTS  
AND OTHER PRECIOUS STONES.

(DIAMOND MOUNTED COMBS A SPECIALTY.)



# FANS

FAN SEASON is here, and we are prepared for it with the choicest line that has ever been imported from Paris. These dainty creations are appropriate for Graduation, Confirmation, Weddings, and in fact for any occasion where taste and exclusiveness are requisite.

SEND FOR A SELECTION, MENTIONING PRICE

**LEWY & COHEN** 530 BROADWAY  
NEW YORK

Importers of Fans, Brooches, Mounted Side and Back Combs, French Head Necklaces in mother-of-pearl effects, and THE "MEDICI CHAIN," a new French creation in fan chains.

**DESIGNS** For Silverware, Novelties and Jewelry . . . . . **FINE ETCHING**

We furnish Ideas for Silver and Goldsmiths.  
American Ideas.

**CHARLES M. PRIOR** (PHONE 1224 HARLEM) 1683 Madison Ave., New York





**SOLID GOLD CHAINS**

The selling price of our goods is based on the cost of honest materials, plus the cost of the very best workmanship it is possible to procure. The usual large selling cost is absolutely eliminated—we have no salesmen. You get the benefit of this system of honesty in manufacture and economy in selling, when you buy our

**SOLID GOLD CHAINS**



For 56 years, exacting Jewelers have found our chains ready sellers, very profitable to handle and most durable in service. Our prices are very low. We will be pleased to send you a selection package.

1850 1906

**ALOIS KOHN & CO.**

Makers of

**SOLID GOLD CHAINS**

of every kind.

16-18 Maiden Lane  
New York

10K 14K

**THE LOCKET HOUSE**

**ROTHSCHILD BROS. & CO.**

51-53 MAIDEN LANE, N.Y.

An Unlimited Line of Patterns of

- |                       |              |                  |
|-----------------------|--------------|------------------|
| LADIES' LOCKETS       | UNMOUNTED    | BROOCH MOUNTINGS |
| MEN'S LOCKETS         | MOUNTED WITH | LINK BUTTONS     |
| LOCKETS FOR EVERYBODY | DIAMONDS     | BRACELETS        |
|                       | OR ROSES     | RIBBON FOBS      |

**“TOPPY AND ORIGINAL”**

- |             |             |             |
|-------------|-------------|-------------|
| Bracelets   | A<br>&<br>V | Handy Pins  |
| Barrettes   |             | Scarf Pins  |
| Brooches    |             | Pendants    |
| Pearl Snaps |             | Collarettes |

**ALLSOPP AND ALLSOPP**

'PHONE 4075W

18 COLUMBIA ST. NEWARK, N. J.



**M. SCHIFF**

Established 1876  
82-84 Nassau St., N. Y.  
Phone 801 John.

Manufacturer of fine  
Diamond Mountings, Lockets  
and Buttons. Patentee of

**THE NEW IMPROVED  
Ear Screw**

The only one on the market  
of its kind, absolutely secure.  
Special attention paid to all  
order work.

ALL KINDS OF BRACELETS

EVERYTHING IN LOCKETS AND CHAINS.

THE BASSETT JEWELRY CO.,

PROVIDENCE, R. I.

# Look for the Stamp

ON BACK OF



ONE PIECE

The Standard American Collar Button

## KREMENTZ Collar Buttons and Studs



Krementz Stamp

PARKS BROS. & ROGERS  
20 Maiden Lane, New York  
Selling Agents to Jobbers

**KREMENTZ & CO.**  
Newark, N. J.

Send for booklet, "The Story of a Collar Button."—FREE



## BRACELETS

Carved,



Engraved,

Plain or

Mounted.

**C. P. GOLDSMITH & CO.,**  
33-43 Gold Street,  
NEW YORK.



-  1. Snap complete.
-  2. Outside of Snap.
-  3. Inside of Snap.

## The E. P. H. Patent NON-PULL-OUT Neck Chain Snap

*is a patented snap that insures  
the wearer against loss of*

**CHAIN or CHARM**  
for it positively will not pull out

Made in 10 and 14 Karat Gold and  
In Gold Filled.

*Can be had of the following Wholesale  
Selling Agents:*

- Messrs. W. Green & Co.,  
81 Nassau St., New York.
- |                           |                   |
|---------------------------|-------------------|
| M. Sickles & Sons,        | Philadelphia      |
| E. A. Cowan & Co.,        | Boston            |
| E. & J. Swigart,          | Cincinnati        |
| Swartchild & Co.,         | Chicago           |
| Nordman Brothers,         | San Francisco     |
| Leonard Krower,           | New Orleans       |
| A. Walker Co.,            | Providence, R. I. |
| Bauman-Massa Jewelry Co., | St. Louis         |

### PRICES.

- 14 Karat—Small, \$7 per doz. net
- Large, \$7.50 per doz. net
- 10 Karat—Small, \$6 per doz. net
- Large, \$6.50 per doz. net
- Gold Filled—Small, \$2 per doz. net
- Large, \$2.25 per doz. net

## ROSARIES



Of Foreign and our own Manufacture,  
\$2.40 per Dozen up.

**SIGNET JEWELRY** A SPECIALTY  
*Memo. Orders Solicited.*

**L. Witsenhausen**

**47-49 Maiden Lane,  
New York.**

Manufacturers of **MODERN JEWELRY**  
Chicago, 405 Masonic Temple.  
(L. KATLINSKY.)

# The Salable MOUNTING



Pat. Oct. 24, 1905.

It gives light and brilliancy  
to the stone

- EARSCREWS
- EARRINGS
- STUDS
- SCARF PINS
- and RINGS

of every description made  
in Platinum, 18K., 14K.,  
all sizes.

**Julius Wodiska**  
40 John St., New York

Manufacturer of a  
general line of

**PLATINUM**  
18k. and 14k.  
**MOUNTINGS**

Prompt attention given to  
special order work.

Estimates and designs sub-  
mitted.

Diamonds recut and re-  
paired.

# Our Trademark is stamped on every piece that we make.



*We are not ashamed to have  
it appear on any of our designs.*

*Our quality—you all know to  
be plump 10 K.*

*Our finish—it's the best ever  
put out on any gold jewelry, short  
of high-class 14K.*

*Kohn & Co*

Camp and Orchard Streets, NEWARK, N. J.

**Roger Williams Silver Co.,**  
PROVIDENCE, R. I., AND NEW YORK, 860 BROADWAY.

**Sterling Only.**

RICH DESIGNS :: :: :: Photos on Application.

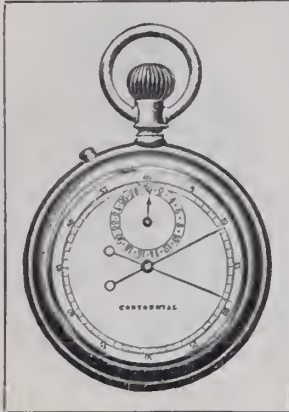

Timer is 1/8 Larger than cut

"Watch us" always for anything you wish in the "Watch" line.

THE OLD RELIABLE  
**Centennial**

SPLIT SECOND TIMER

"None better made"

Suitable for Racing and Mechanical Purposes.



Timer is 1/8 larger than cut

**CROSS & BEGUELIN,** Manufacturers, **New York.**

**The Comb House**

We manufacture a complete line of

**FINE MOUNTED COMBS**

in 14 K., 10 K., Sterling Gilt and Gold Filled.

Also all kinds of PLAIN, REAL and IMITATION TORTOISE SHELL COMBS.

Selection Packages sent to Responsible Jewelers.

**Wagner Manufacturing Co.**

41 Union Square,

**New York.** Factory, Lorimer St. and Throop Ave., B'klyn, N. Y.

Repair Work a Specialty.

35 Years Manufacturing

**CHAINS**

**S. Q. B. Lederer Co.**

11 Maiden Lane New York      Factory: 131 Wabash Ave. Providence, R. I.      Chicago

**Horological Department**  
**BRADLEY POLYTECHNIC INSTITUTE,**  
Formerly Parsons Horological Institute,  
PEORIA, ILLINOIS.

**Largest and Best Watch School in America**  
We teach Watch Work, Jewelry, Engraving, Clock Work, Optics. Tuition reasonable. Board and room in school at moderate rates. Send for Catalog of Information.

**MR. RETAILER :**

The Jobbers have placed orders for more cases than we can possibly produce this season.

Would it not be wise for you to secure a few "Solidaritys" from the *first* Jobber that shows them?

The next Jobber may sell his prettiest patterns before he reaches your town.

"THE RIPEST FRUIT FALLS FIRST."

**Solidarity Watch Case Co.**

ESTABLISHED 1885

GENERAL SELLING AGENTS  
JOHN W. SHERWOOD      FRANK E. HARMER

**3 Maiden Lane, New York**

Henry Freund.

Louis Freund.

Leo. Goldschmidt.

Chas. Danziger.

L. M. Heymann.



**T**HE little Brownies and the big Brownies work hand in hand, and with concentrated mental and physical energy, to introduce our "Sellers" to the trade. When once introduced, we have no fear of the results. We have customers who have been with us for 40 years, and the rule holds good, "Once a customer, always a customer." The right goods at the right time and at the right prices, combined with liberal treatment in every respect, make our customers our friends for all time. The list is constantly increasing. Let us add you to the number this season.

**HENRY FREUND & BRO., "Sellers of Sellers"**

ELK and EAGLE GOODS a Specialty

71 Nassau Street NEW YORK



Ladies' Fancy Stone Rings and Stone Scarf Pins in 10K. that defy competition.

Our reputation for making the finest and most complete line of 10-K. gold band rings is still maintained—ask your jobber.

The **EDWIN LOWE & CO., Inc.**  
 F.W. BODWELL, V.-Pres. and Gen. Mgr.,  
 116 Chestnut St., PROVIDENCE, R. I.  
 New York Representative, E. T. Wilson, 180 Bway.  
 Western Representative, S. H. Brower.

**THE CROWN PATENT SAFETY GUARD**

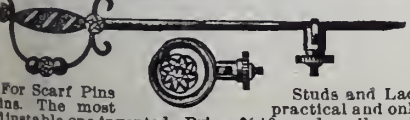

For Scarf Pins Studs and Lace Pins. The most practical and only adjustable one invented. Price, \$1.50 per doz. For sale by all wholesale jewelers and material houses. Sample by mail, 25c; in 10k. gold, \$1.00; 14k., \$1.25. M. CROWN, maker and inventor, 49 and 50 Maiden Lane, N. Y.



**At Last!**

**KEY RING PROBLEM SOLVED!**



Patented Key Ring, Silver, \$9.00 Doz.

The above key ring does the trick. You can put on and take off one dozen keys in less time than you could take one off any other make. We can also supply patent key rings in 10 and 14K. gold.

See our fall line before you place your order for Sterling Silver, Picture Frames, Card Cases, the new style Pocket Book, Toilet Ware, Manicure Articles, Buckles, Match Safes, Child's Cups and other hollow ware.

**PRYOR NOVELTY COMPANY**

New York Office: 7 Maiden Lane  
 Factory and Office: 473-475 Washington Street, Newark, N. J.

# ORDERS PROVE OUR GOODS SELL

We make for the Jobbing Trade the following lines of Solid Gold Jewelry :

*Rings, Scarf Pins, Studs, Brooches, Charms,  
Baby Pins, Handy Pins, Chain Sets,  
Link Buttons, Hair Barrettes,  
Crosses, etc.*

Insist upon seeing the designs of Gold Jewelry made by the

## E. L. SPENCER CO.

95 Chestnut Street, PROVIDENCE, R. I.  
New York Office, 9-11-13 Maiden Lane.  
SAMPLES ONLY.

Established 1855.

# ADAMS & SINGLETON,

Successors to BROOKS & PIKE,

Manufacturers of

# Fine Diamond Mountings.

Special Attention Given to Order Work.

364 Washington Street, Boston, Mass.

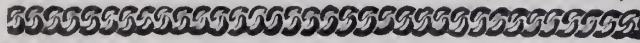
WM. SMITH & CO., Office, 9-13 Maiden Lane, N. Y.  
Established 1854.  Manufacturers of

## GOLD AND SILVER CHAINS,

Gold, Silver and Plated Chain Trimmings,  
Also GOLD AND SILVER KEY CHAINS AND BRACELETS.

# Ribbons

in stock and special designs **MADE to ORDER**, in large or small quantities, to use with medals and for club purposes. ✂ ✂ Correspondence invited.

JOSEPH LOTH & CO., Manufacturers, 65 Greene Street, New York.

**W**ait  
**A**nd See  
**I**n the "Celebrated Case"  
**T**his Season's New Goods.  
**E**very one a Seller  
**T**here  
**H**ave always been  
**R**easons:—  
**E**stablished reputation,  
**S**taple Patterns,  
**H**igh Quality,  
**H**ER'S  
**G**OODS  
**S**ELL

## Waite-Thresher Company

61 PECK ST., PROVIDENCE, R. I.

7 Maiden Lane, 1203 Heyworth Bldg.  
NEW YORK. CHICAGO, ILL.

# Scarf Pins

in unusual designs.

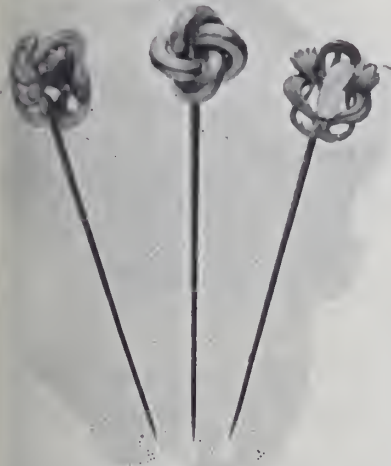

We have departed from the usual styles, and are showing a line of Pins this season that embodies Grace, Style and Beauty. With and without Precious and Semi-Precious Stones.

We are the largest exclusive makers of 10 Karat jewelry. Ask your jobber for our lines of Cuff Buttons, Lockets, Scarf Pins, Hat Pins, Fobs, Brooches, Tie Clasps, Baby Pins, Crosses, Bracelets, Bead Necks, Waist Sets, etc.

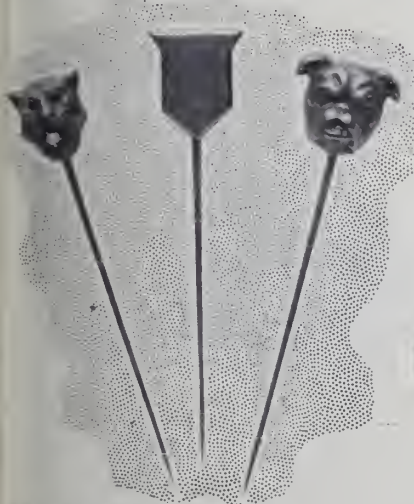

**Potter & Buffinton Co.,**  
Providence, R. I.

New York Office,  
65 Nassau St.  
San Francisco Office,  
206 Kearny St.

# LOCKETS ONLY

Satisfy your customers by using the recognized standard of excellence in this specialty

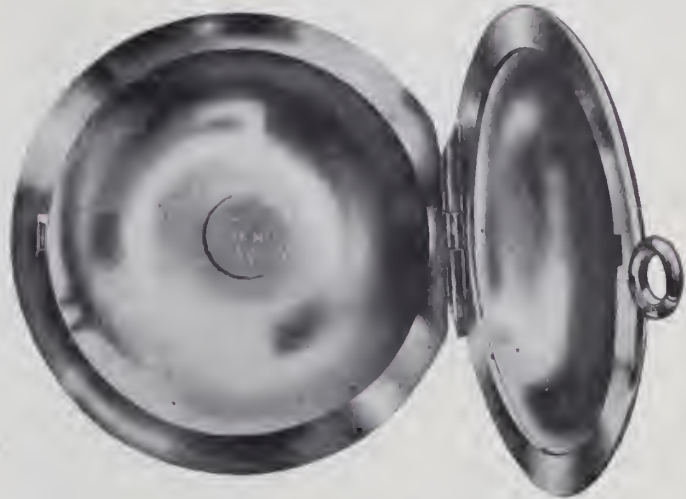

None genuine without **TRADE-MARK** stamped inside

ESTABLISHED FIFTY YEARS

**Wightman & Hough Co.**

New York Office  
3 Maiden Lane

Main Office and Factory { 7 Beverly Street  
Providence, R. I.

## EGYPTIAN PEARLS

—  
FINEST  
OF  
ARTIFICIAL  
PEARLS.

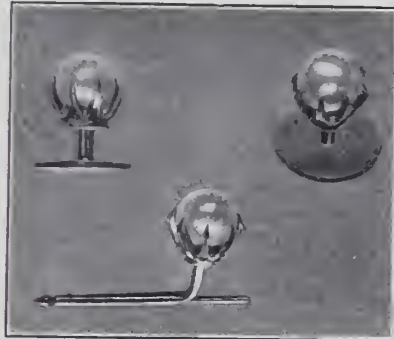

## EGYPTIAN PEARLS

—  
MOUNTED  
IN  
POPULAR  
JEWELRY.

**T**HE PEARL has always symbolized Beauty and Value. Nature's product is most closely approximated in the handsome "EGYPTIAN" Pearls. The iridescence, weight and color of natural Pearls are retained; and inspection of the "EGYPTIAN" Pearls will demonstrate their pre-eminence. The results attained are possible only by a special process, supplemented by expert workmanship. The articles of Jewelry to which "EGYPTIAN" Pearls are applied are artistic creations meriting your attention.

## GEORGE H. CAHOONE COMPANY,

Makers of Artistic Jewelry,

PROVIDENCE—7 Beverly Street.

NEW YORK—9 Maiden Lane.

# LOCKETS

Veribest  
Locketts



THE  
HORSE  
HEAD

illustrates one  
of several hun-  
dred artistic de-  
signs. Made in  
3 sizes.

Every Locket stamped  
on inside with



Insist on this  
Trade-Mark



MADE IN HIGHEST GRADE GOLD FILLED  
For the Jobbing Trade Exclusively.

Manufactured by

## S. & B. LEDERER CO.

NEW YORK  
9-11 Maiden Lane

Providence, R. I.  
100 Stewart St.

CHICAGO  
131 Wabash Avenue



THE TRADE

desirous of keeping in touch with modern, profit-producing methods should always consult the 500 pages of

**OUR BIG CATALOGUE,**  
with its 30,000 illustrations and long list prices. We send this splendid book free on request.

### S. F. Myers & Co.

Headquarters for the Best Handmade Watches.

WHOLESALE JEWELERS

The New  
S. F. Myers Bldg. 476-49 Maiden Lane  
New York.

### THE PREMIER REPAIRING HOUSE OF NEW ENGLAND

JEWELERS, SILVERSMITHS,  
STONE, METAL, SEAL ENGRAVERS  
AND INCRUSTERS.

LAPIDARIES AND DEALERS IN  
PRECIOUS AND IMITATION STONES

- We Cut Stones
- We Repair Stones
- We Drill Stones
- We Engrave Stones
- We Incrust Stones
- We Set Stones

**H. E. ALSTERLUND & CO.,**  
387 WASHINGTON ST. AND 12 BROMFIELD ST.,  
BOSTON, MASS.

All work positively Done in Our Own  
Factory.

Write us for terms and information.

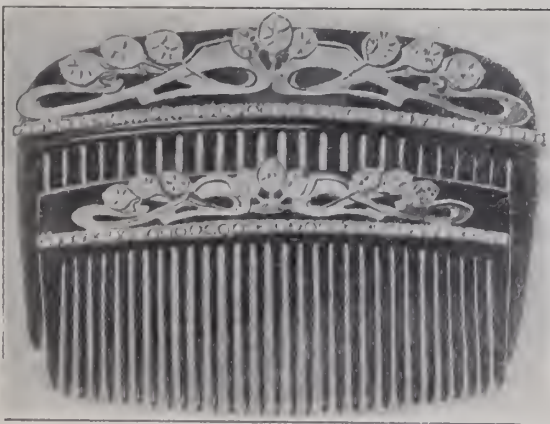

**COMBS** Our new line  
shows many  
designs;  
highly artis-  
tic and attractive, that will  
prove rapid sellers. The high-  
est class of workmanship is  
characteristic of all our lines.

Ask your jobber for our

Combs, Brooches,  
Scarf Pins, Brace-  
lets, Barrettes,  
Buttons, Baby  
Pins, Crosses,  
Waist Sets, Hat  
Pins, Collarettes,  
Silver Novelties.



TRADE  
MARK  
ALWAYS  
ON  
THE  
GO

LOOK FOR THE  
TRADE-MARK

**MILLER, FULLER & WHITING,** MANUFACTURING  
N. Y. Office, 9-11 Maiden Lane NORTH ATTLEBORO, MASS. JEWELERS

### CROUCH & FITZGERALD



**Jewelry  
Trunks  
and Cases**

177 Broadway  
Bet. Cortlandt  
and Day Sts.  
688 Broadway  
723 6th Ave.,  
New York.

### OUR Silver GOODS

Jewelry and Novelties are Original, Artistic  
and Sellers. Our name stands for the best of  
everything in our line at our prices.

**THE W. H. SAART CO.,** Attleboro, Mass.

OFFICES: 713 Market St., San Francisco.  
103 State St., Chicago. 204 St. James St., Montreal.  
49 Maiden Lane, New York.



Tollet Goods  
Wrist Bags  
Buckles  
Bracelets  
Hat Pins, etc.

### EDMUND R. NEBELING Diamond Setter

49 Maiden Lane - NEW YORK  
Telephone, 5029 John

Gypsy and Platinum Work a Specialty. Mail Order  
promptly attended to. Write us for references

### GARREAU & GRISEL

68 & 70 Nassau St., New York.

### LAPIDARIES.

PRECIOUS  
STONES  
GEMS in Unique Cutting





A good many dealers like their own names on America Alarm dials—it's a standing "ad." that somebody else pays for.

Ask your jobber or write us about this.

The Western Clock Mfg. Co.  
LA SALLE, ILL.

# WORLD BRAND SILVER



### Base Metal

☞ Manufactured in our own factory by workmen selected because of their knowledge and practical experience in its manufacture and use and with a view to obtaining the best possible results.

### Silver

☞ Not Less Than 50 per cent. heavier plate than the regular "Standard." Made in two grades, six and fourteen ounce plate.

### Designs

☞ Six fancy patterns—*original* in design and unexcelled in execution. Also four plain patterns.

### Prices

As low as consistent with quality.

*Write for catalogue and prices.*

THE AMERICAN SILVER COMPANY

BRISTOL, CONN.

46 West Broadway, New York.

Silversmiths' Building, Chicago, Ill.

## REMOVAL NOTICE!

THE LYONS GEM CO.,

Have Removed to

35 Maiden Lane, New York.

A FULL AND COMPLETE LINE OF PRECIOUS,  
SEMI-PRECIOUS AND IMITATION  
STONES ALWAYS IN STOCK.

Our Specialty is Scientific Rubies.

Local and out of town jobs promptly attended to at reasonable prices. Send us your mountings to be set with matched stones. A trial order will convince you that our prices are right, and our goods select.

## SHAFER & DOUGLAS

Ring Makers

## HAVE REMOVED

their Office and Factory to

9 & 11 Franklin Street, Newark, N. J.

OPPOSITE NEW CITY HALL

*WE are receiving weekly shipments  
of desirable goods in all sizes  
and grades, at prices that will interest  
large buyers.*

---

---

*ARNSTEIN BROS. & CO.,*

*Importers and Cutters of*

*DIAMONDS,*

*65 Nassau Street, Corner John, NEW YORK.*

*LONDON, Audrey House, Ely Place. AMSTERDAM, 6 Tulp Straat.*

SEND TO US ANY QUANTITY OF

**AMERICAN PEARLS**

WE BUY FOR CASH.

Send by registered mail or express; we will make an offer  
by return mail. We will also buy any quantity of

**BAROQUE PEARLS (SLUGS).**

**BUNDE & UPMAYER CO.,**

Mack Block,

MILWAUKEE, WIS.

# BLACKINTON

Old Reliable W. & S. B. ★ 1-10  
and  
Globe Filled W. & S. B. ★ 1-8

## CHAINS

are sold only to the legitimate jewelry trade. Jewelers who handle them do not have to meet the competition of Department Stores or Retail Mail Order Houses.

The adoption of this policy is the result of a vote of the directors of the W. & S. Blackinton Co. to protect the rights of the retail and jobbing jewelry trade. In declining the trade of department stores we close many large accounts. However, we are convinced that this policy of protection to the retail jeweler and jobber will work to their best interests, as well as our own.

---

### W. & S. BLACKINTON CO.

Manufacturers of Old Reliable W. & S. B. ★ Chains and Locketts

NEW YORK, 14 Maiden Lane

Factory, North Attleboro, Mass.

A selection package will be sent through any jobber whom the retailer may designate.

F&amp;B

F&amp;B

The  
**Gypsy**

Another of our new patterns in Toilet and Manicure goods.

Take particular notice of the new shape of Bonnet Mirror, which will be appreciated by every lady who uses one, it is so convenient. The regular shape can be furnished a little later if it is desired.

Our new line of Sterling Silver silk-lined Jewel Cases is especially attractive, and we are showing a great many Novelties which we will have illustrated in our new Catalogue, H, now in the hands of the publishers.

Owing to the phenomenal demand for

**"The Armlet,"**

the F&B invisible joint bracelet, it has been impossible to keep pace with the orders, but we now believe we shall soon be able to make prompt shipments.

See our full lines of gold-filled Locketts, Charms, Crosses, Pendants, Chains, Fobs, Neck Chains, Collarettes, Pins, Brooches, Earrings, Link Buttons, Scarf Pins, Hat Pins, Barrette Pins, Belt Pins, Waist Sets, Buckles, Hair Chain Mountings, Ribbon Book Marks and a large line of Sterling Silver Novelties.

# Theodore W. Foster & Bro. Co.

Manufacturing Jewelers and Silversmiths 100 Richmond Street. Providence, R. I.

New York Salesroom  
31 Maiden Lane

Chicago Salesroom  
Heyworth Building, Wabash Avenue and Madison Street

Canadian Salesroom  
350 King Street, Kingston, Ont.



**Over \$40,223,000 in Gems.**

**Diamonds, Pearls and Other Precious Stones Imported at New York During Fiscal Year of 1906 Break All Records.**

In the last issue attention was called to the prosperity of the precious stone and pearl trade as indicated by the fiscal year's importations at New York, which, for the first time, passed in valuation the \$40,000,000 mark, an advance of 20 per cent. over the total for the preceding year.

The exact figures for the year ended June 30, 1906, are \$40,217,542.78, of which \$29,196,69 was in cut precious stones and pearls, while \$10,698,346.09 was in uncut precious stones, chiefly diamonds. In the preceding year the cut precious stones and pearls amounted to \$22,942,522.36, and the uncut precious stones to \$10,289,642.33, a total of \$33,223,164.69.

For three years there has been a steadily increasing importation of gems, and the last two fiscal years have each exceeded all predecessors in the aggregate of imports. How the figures of the fiscal year just past compare with those of former fiscal years may be seen from the following table showing the year by year importations at New York, as compiled by Gen. George W. Mindil, the jewelry examiner at the Public Stores:

Year ended June 30, 1906	\$40,217,542.78
" " " " 1905	33,223,164.59
" " " " 1904	21,843,119.17
" " " " 1903	27,318,642.13
" " " " 1902	22,938,531.62
" " " " 1901	21,919,053.86
" " " " 1900	14,984,110.57
" " " " 1899	18,033,801.94

The gains in the last year, it will be observed, have been almost entirely in cut stones and pearls. The importers of rough diamonds say that they would import in larger quantities if the selling syndicate at London would sell supplies up to the requirements of the American trade. It is not possible to figure what is the extent to which the importation of cut stones is swelled by the inability of American diamond manufacturers to obtain all the rough stock that they desire for the home trade.

Only in each of the last two years has the importation of rough stones exceeded \$10,000,000 in valuation. In the fiscal year ended June 30, 1904, the total was \$7,957,266, and that was said to be the highest up to that time. That was the year of the European diamond workers' strike, which was supposed to have added to the demand upon the cutting industry in the United States. Those who feared that after the foreign strike the American lapidaries would have less to do have been agreeably disappointed by the annual totals since then, showing gains and not losses.

Every month of the last fiscal year has exceeded in the valuation of precious stones and pearls that were imported, the figures of the corresponding month of the year before, with the exception of November and January. This is shown in the following table, in which cents are omitted:

1904.	1905.
July ..... \$2,179,948	July ..... \$3,992,831
August ..... 2,021,295	August ..... 2,275,873
September ... 2,192,603	September .. 3,250,880
October ..... 3,045,355	October ..... 3,509,390
November ... 2,825,118	November ... 2,467,093
December ... 2,941,950	December ... 3,633,379

1905.	1906.
January .... \$2,831,212	January .... \$2,706,997
February ... 2,407,089	February ... 3,067,036
March ..... 3,673,383	March ..... 3,789,825
April ..... 2,429,338	April ..... 3,614,932
May ..... 3,233,825	May ..... 4,021,405
June ..... 3,442,043	June ..... 3,887,893

The total value of gems imported during June showed a handsome increase, more than \$400,000 over the total of the corresponding month of 1905, which was the greatest up to that time. A comparison of the figures showing the importation for June during the last nine years may be made from the following table:

1906	\$632,007	\$3,255,886	\$3,887,893
1905	834,537	2,607,505	3,442,043
1904	950,766	1,053,682	2,004,448
1903	781,190	1,879,486	2,660,676
1902	568,899	1,786,626	2,355,026
1901	149,097	1,943,922	2,093,019
1900	390,849	1,081,375	1,472,224
1899	576,732	1,523,718	2,100,450
1898	265,549	421,191	686,740

**Assets and Liabilities of Bernard Steinfeld as Shown by His Schedules.**

Schedules in bankruptcy of Bernard Steinfeld, 504 Sixth Ave., were filed last week, and showed total liabilities of \$5,951 with nominal assets. The creditors included: Frank Walker, \$2,134 (note); Isaac Levinson, \$385 (note); R. L. & M. Friedlander, \$756 (note); L. Beilenson, \$384 (note); Louis Grey, \$367 (note); E. G. Rochat, \$160 (note); Eliassof Bros. & Co., \$125; J. Rosenberg, \$104 (note), and the New Haven Clock Co., \$114. J. Sherman Moulton prepared the schedules as attorney for the bankrupt.

Several weeks ago Mr. Steinfeld reported that he had been robbed while on his way to a railroad station in New Haven, Conn., and that his sample case containing jewelry to the value of \$4,000 had been stolen from him. Directly afterward he made an offer of settlement at 30 per cent. to his creditors, who did not accept, and the involuntary bankruptcy proceedings were then begun. His assets, consisting of fixtures and a small amount of stock, were sold last week under the direction of Wm. Allen, the referee in bankruptcy, and brought less than \$300, which will not be sufficient to meet the legal expenses, so that there is nothing for the creditors.

**Death of Peyton Dearborn.**

ALEXANDRIA, Va., July 4.—The sudden death Saturday of Peyton Dearborn, of the firm of Dearborn & Son, this city, was a distinct shock as well as a cause of profound sorrow to his many friends in this city, Baltimore and Washington. Mr. Dearborn had been in the best of health up to Saturday morning, but on that day complained of a pain in his head and went to his room in his residence, 621 King St., to rest. While reclining on a couch he suddenly called his wife and told her he was dying. Before a physician could be summoned Mr. Dearborn passed away.

The deceased was about 28 years old, and was born in Amherst. Like his father, George W. Dearborn, who edited the Amherst *New Era*, he was engaged in newspaper work before entering the jewelry business here. He was prominent in fraternal circles, particularly in the Elks, being a member of the Amherst Lodge of

that order. He is survived by a widow and one child.

Mr. Dearborn's remains were shipped to his former home in Amherst, Sunday morning, for interment, and were accompanied by a delegation from the local lodges of Elks and Heptasophs, who participated in the services.

**Secretary of the Treasury to Act on Alleged Improper Seizure of Jewelry from Toledo Merchant.**

Commissioner Thomas Alexander, having completed taking of testimony in relation to the diamond brooch imported by Norman C. Hascall, of Jacob J. Freeman & Co., Toledo, O., last week sent his findings to the Secretary of the Treasury at Washington. The Secretary will now pass on the petition of Mr. Hascall, who asked that the brooch and certain other property taken from him on his arrival on the *Oceanic* on May 31 of last year be returned. The Commissioner's findings are a rehearsal of the facts brought out in Mr. Hascall's behalf by his attorney, Julius J. Frank, and also of the facts presented by Arthur M. King, Assistant District-Attorney, appearing for the Government.

The findings indicate that on March 28 of last year, when Mr. Hascall sailed for Europe, he carried a brooch containing nine diamonds, which had been the property of his wife for 14 years. While abroad he paid \$65 for repairing and resetting the brooch. On his return he had, besides the brooch, a gentleman's watch valued at \$60. It was shown that this watch had been imported some time before by his firm and the duty had been paid at the time of importation. The watch was sent back to Europe in order that a defect might be remedied, and for convenience he carried the timepiece on his return trip. He carried also two ladies' watches, costing \$30 each.

In his declaration Mr. Hascall gave the value of the articles which he was carrying as \$100. He did not believe that the brooch or the gentleman's watch was subject to duty, and the value of the other articles was about \$100, corresponding to his declaration.

Evidence was presented that Mr. Hascall had been a member of the Toledo firm for a number of years, and that neither he nor his firm had ever before had any question with the Government in relation to customs duty. While abroad he made purchases for his firm, which were imported in the usual way through Powers & Mayer, New York, the appropriate duty being paid. After the brooch and other articles were taken by the customs inspector, Mr. Hascall prepared the petition to the Secretary of the Treasury, asking that the property be returned.

The Secretary of the Treasury last week sent to collectors of all ports of customs in the country a circular letter calling their attention to the Gold and Silver Stamping Law recently passed by Congress, and pointing out that the Act forbids the importation or exploitation of spuriously stamped articles of merchandise or the carriage in interstate commerce of the same. The circular was accompanied by a full text of the law, which was the same as published in this journal June 20, 1906.

# ACTIVITY THE KEYNOTE OF OUR PROGRESS

A SERIES OF PICTURES SHOWING  
VARIOUS FORMS OF ACTIVE LIFE.



PUSH BALL.

In the game of push ball you must have pushing ability and strength to push the ball at the right time in order to win. This is just exactly our idea of increasing our business, for we are pushing it by having more new and original ideas in all lines for Fall Trade than in all of the 40 years of our existence.

Our travelers can prove this assertion if you will but give them the chance.

**LARTER & SONS,**  
21-23 Maiden Lane, NEW YORK.

## Handsome Gold Vase Presented to Dr. Edward Brooks.

IN the show window of their store, 902 Chestnut St., Philadelphia, Pa., J. E. Caldwell & Co. recently exhibited a solid gold vase which, for chasteness of design and simplicity of lines, is regarded in the trade as showing exceptional beauty. Besides its intrinsic value, which is great, the vase has been regarded as a noteworthy example of the goldsmith's art. It was presented as a testimonial by the teachers of the schools of Philadelphia to Dr. Edward Brooks, who some weeks ago retired as superintendent of the schools after 15 years service.

The vase weighs 625 dwt. and is of 14-karat gold throughout. It is 14½ inches high and 5½ inches in diameter, with a spread to the extremes of the handles of 8¾ inches. It rests upon a beautiful green onyx plinth. The classical outlines of the vase especially engage attention. For the borders of the vase, the Egyptian lotus is used for decorative purposes, as well as the laurel of the walls of Troy. In the central portion of the body is the seal of the city and above the national and city flags crossed.

The engraving of the inscription is most cleverly done in lettering appropriate to the simplicity of the general design.

### Importations at the Port of New York.

Weeks Ended July 7, 1905, and July 6, 1906.	
China, Glass and Earthen Ware:	1905. 1906.
China .....	\$96,582 \$122,274
Earthen ware .....	13,091 15,709
Glass ware .....	28,906 41,028
Optical glass .....	11 3,294
Instruments:	
Musical .....	20,745 12,932
Optical .....	5,979 5,982
Philosophical .....	4,054 705
Jewelry, etc.:	
Jewelry .....	8,901 5,220
Precious stones .....	979,836 725,117
Watches .....	18,618 26,916
Metals, etc.:	
Bronzes .....	1,386 1,977
Cutlery .....	42,266 \$1,634
Dutch metal .....	6,224 5,002
Platina .....	27,177 34,432
Silverware .....	356 1,932
Miscellaneous:	
Alabaster ornaments .....	.....
Beads .....	2,561 2,341
Clocks .....	6,372 6,415
Fans .....	2,506 5,508
Fancy goods .....	7,141 8,027
Ivory .....	..... 4,735
Ivory, manufactures of.....	295 3,618
Marble, manufactures of...	30,113 34,861
Statuary .....	10,159 5,431

M. A. Mead & Co., wholesale jeweler and jobbers of Chicago and Pittsburg, have sent their customers a new price list of the watch movements and cases which they handle, which will no doubt be found very valuable to all jewelers into whose hands it may come. The list is a small booklet of 12 pages neatly bound, in which the various movements and cases are listed in a distinctly original way in the form of a table concisely arranged, which shows at a glance the price of each movement and case as well as the complete watches, 25-year case being printed in black ink, 20-year in red ink. The availability of the list lies both in its compact form and the facility with which the jeweler can get the information which he wants with a minimum amount of trouble.

**The Canadian Gold and Silver Stamp-  
ing Bill Approved by Banking and  
Commerce Committee.**

OTTAWA, Ont., July 6.—Yesterday the Banking and Commerce Committee of the House of Commons approved of the provisions of the bill respecting the sale and marking of manufactures of gold and silver. On behalf of the promoters of the bill W. K. McNaught, of the American Watch Case Co., explained that there was much misrepresentation as to goods made of gold and silver. The purpose of the bill was to prevent this, and wholesale firms and manufacturers of jewelry, as well as retail dealers, Mr. McNaught said, were generally in favor of the bill, which applies to imported goods as well as to those manufactured in Canada.

Mr. Rosenthal, of Ottawa, spoke in favor of the bill from the retailers' point of view, while H. & A. Saunders, manufacturers, wrote asking for a postponement until further inquiry could be made. As one reason for passing the bill as early as possible, it was stated that it was a custom with some of the trade to stamp watch cases as being of a higher quality than they actually were, and Mr. McNaught produced a watch case which was "guaranteed for 20 years," but the gold on which, he said, would wear off in three years. Mr. McNaught said there were 200,000 of such watch cases in Canada today, although the firm that made them had gone out of business.

The example of England and the United States in this matter was approvingly referred to, and Mr. Fielding, Minister of Finance, finally declared himself in favor of the bill, which was ordered to be reported to the House.

The bill provides that 12 months after the passing of the bill:

It shall not be lawful to make or sell, or to import or attempt to import into Canada, any article composed either in whole or in part of gold or of silver, or of any alloy of gold or of silver, if to such article there is applied any mark other than:

(a) Trademarks registered in accordance with the Trade-mark and Design Act, Chapter 63 of the Revised Statutes of Canada; and

(b) Such letter as is, by schedule required to indicate the period of time during which such article was manufactured; and

(c) Marks truly and correctly indicating the quality of the gold or silver, or alloy of gold or of silver, used in the construction of such article.

The marks referred to shall state the fineness of the gold in karats. The number of karats so stated shall bear the same proportion to "24 K" as the gold in the alloy bears to pure gold. The actual fineness of the gold or alloy of gold of which the article is composed shall not be less than the said proportion by more than one-half of a karat, if solder is used, or by more than one-quarter of a karat if solder is not used.

Every one, being a dealer, is guilty of an indictable offence and liable to the penalty, who makes or sells, or imports or attempts to import into Canada, any article purporting to be wholly or partly composed of gold or of any alloy of gold, if the article when made or sold, has thereto applied any mark (a) indicating the gold in the article to be of less than 10 karats in fineness; or, (b), bearing the words "gold," "solid gold," "pure gold," "U. S. assay," or other words purporting to describe the gold or alloy of which the article is composed.

Every dealer is guilty of an indictable offence and is liable to penalty who makes, or sells, or imports or attempts to import into Canada, any article which has applied thereto any mark indicating, or purporting to indicate, or leading to a reasonable belief, that the metal or alloy of which such article is composed is sterling silver, if the metal or alloy of which such article is actually composed contains silver in less proportion than

**National Monthly Import and Export Statistics.**

WASHINGTON, D. C., July 9.—The records of the Treasury Department contain the following comparative statistics, of interest to the jewelry trade, for May, 1905 and 1906-06 and for the 11 months ending April, 1906:

	IMPORTS		—11 Months Ending—	
	May, 1905.	May, 1906.	May, 1905.	May, 1906.
Clocks and parts of.....	\$33,604	\$32,639	\$457,305	\$508,206
Watches, materials and movements.....	225,401	208,050	2,284,230	2,394,454
Diamonds, glaziers' diamonds, etc., unset, and watch jewels (free).....	652,727	.....	9,286,599	.....
Diamonds, n. e. s., not set (dutiable).....	1,705,109	2,067,311	15,350,713	22,043,458
Diamond dust or bort (free).....	390,415	23,980	732,259	130,317
Precious stones, rough or uncut (free).....	1,889	2,395	276,566	117,164
Precious stones and pearls, not set.....	582,340	322,332	4,891,670	4,772,322
Jewelry and manufactures of gold and silver....	91,638	95,032	1,222,852	1,626,574
EXPORTS OF DOMESTIC MERCHANDISE.				
Clocks and parts.....	\$97,128	\$101,566	\$1,096,876	\$1,186,463
Watches and parts.....	138,782	113,382	1,043,786	1,154,701
Jewelry and manufactures of gold and silver....	120,353	157,244	1,303,110	1,649,522
Plated ware.....	64,584	.....	654,482	.....
EXPORTS OF FOREIGN MERCHANDISE.				
Clocks and parts.....	.....	\$192	\$1,795	\$924
Watches, materials and movements.....	\$1,835	.....	15,935	3,916
Diamonds, rough, including miners', glaziers', etc. ....	.....	.....	185	2,954
Diamonds, n. e. s. (dutiable).....	.....	.....	1,282	21,266
Other precious stones, rough or uncut (free)....	.....	.....	.....	217
Other precious stones, cut but not set.....	1,590	219	336,176	4,466
Jewelry and manufactures of gold and silver....	2,880	96	33,135	5,810

925 parts of pure silver in every 1,000 parts of such metal or alloy by more than 25 parts in 1,000 when solder is used, or by more than 10 parts in 1,000 when solder is not used.

The provisions shall not apply to any article of gold less than 10 karats in fineness, or of silver, or of any alloy of gold or silver, to which is applied any hall-mark lawfully applied according to the laws of the United Kingdom of Great Britain and Ireland; or any mark indicating the quality of the gold or of the silver or of the alloy and applied by the government of any foreign country, if with respect to such article all the other provisions of the bill have been complied with.

In the case of articles made in whole or in part of an inferior metal, which has deposited or plated thereon, or brazed or otherwise affixed thereto, a plating, covering or sheet composed of gold or silver, or of an alloy of gold or of silver, and known in the trade as rolled gold plate, gold filled, gold plate, silver plate, silver filled, or gold or silver electroplate, or by any similar designation, and in the case of articles of like nature brought under the provisions of this section by regulation made by the Governor-in-Council, it is required that the quality and nature shall be clearly marked.

Schedule "A" referred to in the bill is as follows:

A indicates the period of time from June 30, 1906, to July 1, 1910.

B indicates the period of time from June 30, 1910, to July 1, 1915.

C indicates the period of time from June 30, 1915, to July 1, 1920.

D indicates the period of time from June 30, 1920, to July 1, 1925.

E indicates the period of time from June 30, 1925, to July 1, 1930.

F indicates the period of time from June 30, 1930, to July 1, 1935.

G indicates the period of time from June, 1935, to July 1, 1940.

H indicates the period of time from June 30, 1940, to July 1, 1945.

I indicates the period of time from June 30, 1945, to July 1, 1950.

**Jewelry, Clocks, Optical Goods and Kindred Lines Exported from New York.**

WASHINGTON, D. C., July 4.—The following were the exports of jewelry, silverware, optical goods, clocks, watches and kindred lines from the Port of New York for the week just ended:

- Bahia: 12 packages optical goods, \$1,130.
- Bergen: 4 packages engravers' machinery, \$298.
- Bremen: 1 package plated ware, \$300.
- Buenos: 13 packages plated ware, \$1,400; 34 packages clocks, \$578; 167 packages clocks, \$1,769;

3 packages watches, \$1,174; 3 packages plated ware, \$358; 1 package optical goods, \$289.

Calcutta: 28 packages clocks, \$532; 5 packages plated ware, \$616.

Copenhagen: 5 packages engravers' machinery, \$325; 11 packages clocks, \$305.

Ecuador: 1 package jewelry, \$238.

Glasgow: 23 packages clocks, \$240; 1 package optical goods, 150.

Gothenburg: 1 package engravers' machinery, \$120.

Hamburg: 1 package silverware, \$750; 1 package optical goods, \$250; 3 packages optical goods, \$376; 2 packages jewelry, \$605; 1 package watches, \$1,975.

Havana: 25 packages clocks, \$216.

Havre: 2 packages watches, \$500 2 packages jewelry, \$500.

Hong Kong: 4 packages scopes and views, \$675; 50 packages clocks, \$790.

Jeremie: 1 package silverware, \$100.

Kingston: 1 package clocks, \$129.

Liverpool: 8 packages clocks, \$305; 205 packages clocks, \$21,169 1 package watches, \$200; 1 package silverware, \$735; 1 package jewelry, \$500.

London: 82 packages clocks, \$3,130; 4 packages plated ware, \$358; 1 package silverware, \$200; 7 packages optical goods, \$1,461; 14 packages watches, \$2,413; 2 packages jewelry, \$100; 23 packages clocks, \$288.

Manila: 21 packages scopes and views, \$2,050.

Nassau: 1 package plated ware, \$162.

Oporto: 26 packages clocks, \$291.

Panama: 1 package jewelers' supplies, \$149.

Para: 4 packages jewelry, \$302; 12 packages clocks, \$267; 2 packages jewelers' machinery, \$123.

Pernamhuco: 3 packages watches, \$200; 4 packages jewelry, \$868; 4 packages optical goods, \$378.

Shanghai: 173 packages clocks, \$2,468.

Singapore: 4 packages jewelers' supplies, \$491; 1 package watches, \$707; 3 packages plated ware, \$295.

Southampton: 2 packages optical goods, \$150; 2 packages watches, \$1,175.

St. Johns: 16 packages clocks, \$157.

Sydney: 3 packages optical goods, \$119; 5 packages plated ware, \$389; 105 packages clocks, \$2,075.

Vera Cruz: 6 packages plated ware, \$1,302; 26 packages clocks, \$289.

Yokohama: 37 packages clocks, \$914; 1 package silverware, \$1,150.

Zanzibar: 12 packages clocks, \$185.

Calvin Clauer, who recently purchased the business of Alfred Hossick, Elkhart, Ind., is a member of the retail jewelry firm of Cleis & Clauer, 105 Michigan St., South Bend, Ind. A. Kishler will be the manager of Mr. Clauer's establishment in Elkhart. Mr. Hossick will go to Detroit, where he conducts a wholesale business.

# HAYDEN W. WHEELER & CO.

## MOUNTED DIAMONDS

We are making up many new pieces in mounted diamonds for our Fall stock and will show new ideas and a larger and finer stock than ever.

Besides mounted diamonds, we have a large stock of loose diamonds, colored stones and pearls.

NECKLACES, BRACELETS AND LA VALLIERES ARE AMONG THE PREVAILING FADS AT PRESENT.



Trade-Mark  
Registered.

AMSTERDAM  
2 TULP STRAAT



Trade-Mark  
Registered.

LONDON  
50 HOLBORN VIADUCT

2 MAIDEN LANE, NEW YORK

TELEPHONE  
7365 CORTLANDT

ORDER

# DIAMONDS

ON MEMORANDUM FROM

## ALFRED H. SMITH & CO.

170 BROADWAY, NEW YORK.  
Corner Maiden Lane.

London.  
6 Holborn Viaduct.

Chicago,  
103 State Street.

## Oppenheimer Bros. & Veith, Cutters of Diamonds,

65 NASSAU ST. (PRESCOTT BUILDING), NEW YORK.

AMSTERDAM,  
2 Tulp Street.

LONDON,  
40 Holborn Viaduct.

CUTTING WORKS,  
Cor. Union & Nevins Sts., Brooklyn.

## HENRY E. OPPENHEIMER & CO.,

51 Holborn Viaduct, London.  
50 Rue de Chateaudun, Paris.  
7 Place Loos, Antwerp.

Tel. 621 Cortlandt.

3 MAIDEN LANE, NEW YORK

# DIAMONDS, PEARLS AND PRECIOUS STONES

MEMORANDUM ORDERS SOLICITED.



### New Jersey Court Refuses to Restrain Wm. H. Rogers from Using His Name on Silverware.

In the suit of the International Silver Co. against William H. Rogers, of Plainfield, N. J., Vice-Chancellor Stevens in the court of Chancery, Trenton, N. J., last Thursday filed a decision which denied the plaintiff's application for an injunction restraining the defendant from stamping silverware with his own name. This is another step in litigation that has extended through a number of years.

The defendant was formerly a member of the William H. Rogers Corporation, which had a factory at Plainfield. The International Silver Co. through its attorneys, Brownell, Mitchell & Bartlett, brought proceedings to compel the Plainfield corporation to cease the use of the name of Rogers. The plaintiff claimed that when this name was used as a trade-mark on silverware the public was deceived into supposing that the articles had been manufactured by the original Rogers, whose trade-marks are now the plaintiff's property. It was set forth in that case that the Rogers whose name had been used by the corporation was formerly a bicycle repairer. The plaintiff claimed that it was only on the account of the similarity of the name that Rogers was brought by others into the silverware business. The courts sustained the plaintiff company's claims and granted the injunction that was sought.

After the courts granted the injunction against the William H. Rogers Corporation the name was changed to the Plainfield Silver Co., but the corporation was soon dissolved and the business went on under the individual style of William H. Rogers.

The International Silver Co. then began the present proceedings and asked for an injunction to restrain Mr. Rogers from using his name or any similar name as a trade-mark or stamp on silverware. It was argued on the plaintiff's behalf that it would be most unfortunate for men who had built up a profitable trade if another, who by accident of birth happened to have the same or a similar name, could engage in the same line of business and win patronage solely by reason of the similarity of name.

Evidence was introduced in the case to indicate that Mr. Rogers and the company which he succeeded had printed on some of the boxes and labels notices to the effect that he was not the original Rogers. On the plaintiff's behalf it was argued that this notice would reach nobody's attention except that of the jobbers, who all know that William H. Rogers of Plainfield was not the original Rogers. The public, it was argued, in buying the silver see only the stamp in the metal, and if the word Rogers is used such stamp deception may result. Mr. Bartlett, as attorney for the plaintiff, urged that if the word Rogers was stamped in the metal the words "not original Rogers" should also be stamped on the metal. For the purpose of this argument the attorney said that he waived questions as to whether or not Mr. Rogers is in good faith the sole owner of the business, or is only a blind for a corporation.

The Vice-Chancellor holds that Mr. Rogers has a right to use his own name

provided he does not affirmatively make it appear that his wares are those of the original Rogers. It is likely that the appeal to the Supreme Court will not be heard until Fall.

### How a New York Diamond Salesman Was Robbed in Oregon—Thief Captured and Sentenced to Prison.

Herbert A. Reichman, of Jos. H. Fink & Co., 65 Nassau St., New York, returned this week from his western trip after having been robbed of a quantity of diamonds, recovering most of them, arresting the robber and seeing him sent to prison for one year. He is thoroughly satisfied with the result of his experience, and believes that he has assisted in putting out of the way for a time a man who was a real danger to diamond salesmen.

Mr. Reichman arrived in Portland, Ore., June 18. Mr. Jaeger, of Jaeger Bros., local jeweler, gave him a card bearing the name of "K. Reber, jeweler, San Diego, Cal." It was said that the San Diego man was looking for diamonds, and was prepared to pay cash for them. Reber, whose real name is said to be G. M. Meyers, had been in Portland for a few days, and had introduced himself to Jaeger Bros., who had been led to suppose that he was a reputable merchant.

It happens that there is in San Diego a jeweler named G. Reber. The latter knew nothing of the man who was going about the country passing under a similar name.

A couple of days after reaching Portland Mr. Reichman went to Seattle, Wash., where he met Fred Davis, of Nordman Bros., San Francisco. Meyers had called on Davis, who, however, had no loose diamonds, and so informed Mr. Reichman that here was a prospective purchaser. At the hotel Meyers introduced himself to Mr. Reichman, saying that he had about \$5,000 in cash with which he wished to buy diamonds. They went to Reichman's room to examine his stock, the salesman taking the precaution of having a friend present, but the friend was called away before Meyers finished his examination of the stones.

Meyers spent a good deal of time looking over the stones on a table. With a lead pencil and a pair of tweezers he turned them about and handled them for inspection. After poking about in one lot of stones he would call abruptly for the salesman to push another lot toward him. Just at this point he abstracted stones from groups of m $\acute{e}$ lée. The little stones stuck to his pencil and tweezers, on which, as he afterwards said, he had placed "dope," a kind of grease. The pencil or tweezers being replaced in his pocket at the time that Mr. Reichman was reaching for the new package of diamonds, the act was not noticed. It was easy for Meyers to give the pencil or tweezers a twist in his pocket, and this would loosen the stones, after which he was ready to begin again.

Only one large stone was taken. This Meyers said he took with his tongue. He did this while breathing on a number of the stones, and the action must have been performed quickly to escape the salesman's attention, as Mr. Reichman was watching

carefully every movement that he made.

Meyers put aside diamonds to the value of about \$8,000, asking the salesman to hold them for him until 2 o'clock the next day. Mr. Reichman then placed his diamonds in the safe. The next morning, feeling a little uneasy, he weighed the stones and saw that there was a shortage, one brilliant having been taken and several of the packages of the m $\acute{e}$ lée being short. In all, the missing stones cost about \$500. The chief of police and the Jewelers' Protective Union were at once notified, and Pinkerton detectives went to work on the case.

Meyers did not call at the appointed time, but telephoned that he was busy and would call the next day. He did not do so. Mr. Reichman suspected that the man would go to the races, and the salesman went to the track to look after him. The salesman saw Meyers coming down the steps of the grand stand, and, taking him by the hand, remarked: "How are they coming?" Meyers showed the salesman a bet he had just made, and seemed anxious to get away. Reichman drew his revolver and held Meyers until the police arrived and handcuffed the man, taking him to the city jail.

At the jail the prisoner confessed that he had taken 21 small stones, and had sold them to the Goldwater Jewelry Co., who in turn sold them to Mayer Bros. These stones were afterwards recovered. A couple of days later the prisoner confessed the stealing of the brilliant, which weighed 1 5/32 of a carat, but this was not recovered. Before Mr. Reichman left Seattle Meyers was sentenced to one year's imprisonment and began to serve his sentence. The slight loss to Jos. H. Fink & Co. is covered by insurance.

According to the western police, Meyers attempted to steal from a number of salesmen and jewelry firms in Seattle, but did not succeed. Mr. Reichman believes, however, that the man had been working a game similar to the one now exposed on various diamond merchants. The man's operations were conducted so cleverly that in ordinary cases it would be difficult for a merchant to prove the theft, and because of this it is likely that complaints may have been withheld.

### Death of Chas. E. Sherwood.

Charles E. Sherwood, who for many years had been a wholesale dealer and importer of diamonds and jewelry in New York, died July 5 at Asbury Park. He had been ailing since he returned from a western trip a number of months ago, and had been confined to his home, 135 Hamilton Place, for several weeks.

Mr. Sherwood was a native of Kentucky. He first engaged in business as a member of Kelly & Sherwood, at San Francisco. In 1886, having sold out his western business, he came to New York, and had since been located successively at 25 and 21 Maiden Lane. He is survived by a widow. The funeral took place from his home, and was private.

An unknown man, supposed to have been a jewelry peddler, fell from a passenger train near Fisher, Minn., a short time ago and was instantly killed.

# Mr. ABE A. HELLER

is now in charge of our European offices, with headquarters at  
**39 Rue de Chateaudun, PARIS.**



BIRDSEYE VIEW OF PARIS.

Many years of studying the Jewelry trade here have given our Mr. Abe A. Heller an intimate knowledge of the wants of the American Manufacturer, which will be of great advantage in selecting the right goods for the American Market.

## *L. Heller & Son*

Importers of Precious and Imitation Stones.  
 New York, 51 Maiden Lane    Providence, 212 Union Street  
 Paris, 39 Rue de Chateaudun    Idar, 14 Hauptstrasse  
 TELEPHONE 219 JOHN.

GEORGE H. HODENPYL.

WALTER N. WALKER.

# DIAMONDS

AND

DIAMOND JEWELRY

# HODENPYL & WALKER

Unique  
 and  
 Staple Patterns

**170 Broadway, New York**  
 Corner of Maiden Lane  
 TELEPHONE. 1898 CORTLAND

Repairing and Recutting  
 Diamonds  
 a Specialty

OUR  
**40th**  
**YEAR**

IN  
 BUSINESS

1866-1906

**DIAMONDS**  
 LOOSE AND MOUNTED

**CASES and MOVEMENTS**  
 ALL MAKES AND GRADES

**JEWELRY**  
 GOLD AND PLATED

ORDERS SOLICITED FROM RESPONSIBLE JEWELERS.    GOODS SENT ON SELECTION.

All our goods are either direct importations, our own manufacture or bought for cash, enabling us to offer special inducements in prices and terms.



EST. 1866.  
*Lissauer & Company*  
 Importers.  
 2 TULPSTRAAT,  
 AMSTERDAM.

12 MAIDEN LANE,  
 (ONE FLIGHT UP)  
 P. O. Box, 1625,  
**NEW YORK.**

# PEARLS ROUND, BUTTON AND HALF.

Selection Papers Sent on Request

**MARTIN LOW & TAUSSIG,**

51 Maiden Lane, New York.  
 Telephone. 2817-John.

139 Mathewson St., Providence, R. I.  
 Telephone. 3037-Union.

### Funeral of the Late Max J. Lissauer, Who Died in Amsterdam, Held in New York.

The funeral of Max J. Lissauer, head of Lissauer & Co., 12 Maiden Lane, New York, who died June 18 in Amsterdam, Holland, took place last Thursday at his home, 61 E. 83d St., New York. There was a large attendance of friends of the family and of business men who had been associated with Mr. Lissauer and desired to show the high regard in which he was held. There were present representatives of the Columbia Bank, the Hudson Realty Co., the Jewelers' Board of Trade and other organizations. Although the family discouraged the sending of flowers, yet quite a number of pieces were sent by friends who could not refrain from showing this last mark of esteem, and there were particularly handsome pieces from the Columbia Bank and the Hudson Realty Co.

It was Mr. Lissauer's wish that his funeral should be conducted with as little ostentation as was possible, and the services were arranged in keeping with this purpose. He had asked that the addresses be limited to remarks by one or two friends and accordingly John L. Shepherd, of the Keystone Watch Case Co., and Hugo Adams, vice-president of the Freundschaft Club, were invited to speak.

Col. Shepherd, who had been for many years closely associated with Mr. Lissauer in commercial, social and political affairs, spoke eloquently of the sterling qualities of his friend, saying in part:

We are assembled here as business men and friends to pay the last sad tribute of respect to a gentleman who, by his integrity and ability, won the respect and esteem of all with whom he came in contact, but who now lies here in that last, endless sleep of death. I can say of him most truthfully that which I wish most sincerely could be said of every man at the end of his life's journey—that by example he has shown life to be worth the living. I know of nothing more grand and beautiful that can be said of any man than after his death he will be missed by mankind, missed for his virtues, missed for his charity, missed for his ability. All these qualities Mr. Lissauer had.

He was deeply interested in any movement in the trade and especially those that he thought would bring the greatest good to the greatest number. He was an earnest worker for the Jewelers' League. In the years of the great panic he organized the Jewelers' Relief Association and was its president until his death. By his integrity and ability he built up a business that so long as it stands will reflect honor and credit upon his name and character.

But this is not the time or place to speak of his commercial achievements. They are known to the business world. A member of a long persecuted race, yet he was a patriotic American citizen in the truest and noblest sense of the word, professing no religious belief other than that of the broad plane of humanity. In his charity he knew no sect or creed, he hated sham and hypocrisy, he despised wrong-doing in public or private life, and never varied in any movement that he thought for the best.

Ever ready with advice and assistance to those who sought it, his career should be an example to all young men who wish to make life worth living, so that when their fitful journey is over, it may be said of them as we can say here of Mr. Lissauer to-day, that he has left a name and reputation which time will not tarnish and which in each passing year will grow brighter and brighter. We know that he will be long remembered by those he loved and by the business men of Maiden Lane.

It is by the life of such men as Mr. Lissauer that we learn that great lesson of mankind, the true lesson of humanity, that one touch of nature makes the world kin. This inspires us with a new courage again to take up the burden of life,

refreshed and strengthened and elevated to a nobler and loftier plane where all the passions and prejudices are forgotten, where self and selfishness are remembered no more in our desire to assist the poor and lowly. By reason of this lesson we become men in the truest, noblest and gentlest sense of the word.

The house of our memory can be furnished alone by our own acts and deeds. If these acts and deeds have been like those of Mr. Lissauer, noble and unselfish, if we have assisted the poor and lowly, if we have spoken words of cheer to those to whom life is a hard and cruel burden, then our memory, like that of our dead friend lying here, will be full of beauty and peace and joy, with more sunshine than shadow, more pleasure than pain and more laughter than tears.

Mr. Adams's remarks, which were in German, were largely in relation to Mr. Lissauer's social qualities which endeared him to those who knew him best. Mr. Lissauer was formerly president of the Freundschaft Club, and the intense interest shown by him in the beneficent works of the organization was recalled by the speaker as illustrative of the character of their departed friend, who, during his career, had in many ways extended a helping hand to those about him.

The body, in accordance with wishes expressed by Mr. Lissauer before his death, was cremated in the Freshpond Cemetery, and the urn containing his remains will rest in the family mausoleum.

At the regular meeting of the directors of Columbia Bank, held on Wednesday, June 20, 1906, the president announced the death of their colleague, Max J. Lissauer. The following resolution was passed:

*Whereas*, It having pleased Almighty Providence to suddenly take from our midst our valued and beloved colleague, Max J. Lissauer, we feel that this bank has sustained a great loss in his death. Mr. Lissauer was a member of this board for 17 years (since January, 1889), during which period he faithfully attended the meetings and councils of the board and always had the welfare of the bank at heart. It is further

*Resolved*, That the sympathy of this board be extended to his bereaved family, and it is ordered that this resolution be entered upon the records of this bank, and that an engrossed copy thereof be submitted to his sorrowing family.

JOSEPH FOX, President.

W. S. GRIFFITH, Cashier.

At the regular meeting which the directors of the Jewelers' Board of Trade will hold to-morrow, appropriate action will be taken on Mr. Lissauer's death.

### Creditors of David Hartstein, New York, Considering His Offer to Compromise.

Creditors of David Hartstein, 4 Avenue C, have recently held several meetings for the purpose of considering a composition which he offered. Mr. Hartstein had been in business at that address for several years and enjoyed considerable credit. Part of his business was of the installment character, and his trouble has apparently been hastened by slow payments on these accounts. His first offer to his creditors was 30 cents on the dollar. The creditors at a conference held one day last week in the office of Samuel E. Koehig asked for a larger percentage, and he then offered 40 per cent., proposing to pay 10 per cent. in cash, 10 per cent. in indorsed notes due in six months, 10 per cent. in indorsed notes due in nine months, and 10 per cent. in notes that are not indorsed, due in 12 months.

The committee which had been looking

over Mr. Hartstein's books reported that the merchandise and fixtures, at a conservative valuation, were worth \$8,080, cash on hand amounted to \$370, and there was merchandise out on memorandum to the value of \$1,521, making a total of \$9,971. Out of \$20,000 due to Mr. Hartstein on accounts, about \$6,000 will be collected, the committee believes, if he continues in business. He claims that by continuing he can collect nearly all outstanding accounts. His liabilities amount to \$32,000.

Most of the creditors represented at the meeting were inclined to accept the offer of 10 per cent., although two or three expressed dissatisfaction. The proposition is now being circulated among the creditors for signature.

Mr. Hartstein has been in business altogether about 45 years. He started by selling to private trade from his home and about 1902 he opened a store at 413 E. Houston St. The next year he moved to his present address.

### All Indications Point to Success of Pennsylvania Retail Jewelers' Association Formed at Pittsburg.

PITTSBURG, Pa., July 10.—All arrangements have been completed for organizing the Pennsylvania Retail Jewelers' Association, which meets in convention in this city to-day. Jewelers from Pittsburg, Allegheny, Blairsville, Butler and surrounding towns met Thursday night at the Hotel Murray, where all the details were finally arranged and the various committees appointed. J. P. Steinman, chairman of the Reception Committee, completed his committee, the members including local and out-of-town jewelers. C. S. Wiley, who is the temporary secretary of the organization, believes that about 125 from all parts of the State will be in attendance.

At Thursday night's gathering a constitution and by-laws was presented and discussed, both being somewhat different than those of similar organizations in other States. They will be presented to the convention for ratification. There is no plan for the election of officers, and this will be left entirely to the convention.

Already the formation of the organization is attracting considerable attention among the wholesale dealers of this city, and especially those who do a retail as well as a wholesale business. Some of the wholesalers who retail do not look kindly on the project, and sort of resent what they term to be an interference on the part of the retailers. There, however, appears to be little doubt about the success of the movement, as those who have already arrived speak enthusiastically of the project. It has been decided to not hold a banquet. Delegates will be chosen to attend the first meeting of the national organization to be held in Rochester, N. Y., Aug. 3.

Congressman James Francis Burke and J. W. Wardrop, secretary of the Merchants and Manufacturers' Association, will address the convention to-day.

M. B. Lichtenstein, Salt Lake City, Utah, recently transferred to Charles H. Deer a parcel of real estate on State St., at that place, between 2d and 3d Sts., for \$30,600.

# Chester Billings & Son

1840

Successors to  
Kandel, Barmore & Billings

1906

Importers of Diamonds  
Other Precious Stones, and  
Pearls, Diamond Jewelry

1840, Kandel & Barmore; 1866, Kandel, Barmore & Co.; 1880, Kandel, Barmore & Billings; 1897, Chester Billings & Son

New York, 58 Nassau Street, 29 Maiden Lane  
London: 22 Holborn Viaduct, E. C. Paris: 53 Rue de Chateaudun  
Amsterdam: 2 Tulp Straat

## Diamonds Set Without Cost

Means a lot of money saved during the year. This you can do very easily if you have your settings done by a first-class setter. Your diamonds will improve in value more than three times the money you pay for setting them. At the same time your mountings improve greatly. Your customers are satisfied with all the orders you turn out. You can compete with all others who are slow in grasping the importance of these facts, by giving me all your settings. I am sure you will make no mistake as I will prove these facts.

I make a specialty of setting fine Platinum Mountings, Watch Cases, Locketts and Gypsy Settings.

### RUDOLF BRETTNER

65 Nassau Street NEW YORK

MAIL ORDERS RECEIVE PROMPT ATTENTION

Established 1883

Telephone 2547 Cortland



## COOPER'S SUN RAY DIAMOND

HAS 100 per cent. more brilliancy than any other style of cutting.

*We Challenge the World.*

Send your old mine and yellow diamonds to be recut; if the effect is not 100 per cent. better, NO CHARGE.

## COOPER DIAMOND

Cutting and Polishing Industry of America

49 MAIDEN LANE, NEW YORK.

Factorius, 8th Ave & 18th St., Brooklyn.

# EDUARD VAN DAM DIAMOND CUTTER

AMSTERDAM NEW YORK ANTWERP

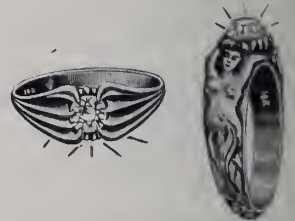

Manufacturer of  
Diamond Mountings and  
Diamond Set Jewelry  
Importer of  
Diamonds and Precious Stones

### A. S. Hirshberg.

373 Washington Street, Boston, Mass.

Cable Addresses: { Ashir, Boston.  
Hochschüler, Antwerp.

JACOB BASCHKOPF,  
DIAMOND SETTER  
LETTER AND MONOGRAM  
ENGRAVER,  
9-13 MAIDEN LANE,  
NEW YORK

Room 701  
Jewelers' Bldg.

### Designs Selected for Silver Service to be Presented to Battleship "Louisiana."

NEW ORLEANS, La., July 7.—Coleman E. Adler was awarded the contract for the making of the silver service for the battleship *Louisiana* a few days ago. The service is to cost \$10,000, and Mr. Adler hopes to have it ready for presentation in at least six months. The award of the contract was made at the meeting of the Silver Service Committee. The committee carefully considered the four designs presented, and finally Mr. Adler's design was adopted as being the most appropriate and beautiful. According to the design offered by Mr. Adler, the ornamentation of the piece will symbolize the State of Louisiana, the battleship *Louisiana* and the United States Navy. The rim of the bowl will suggest agriculture, clusters of fruit forming a wreath around it. The State seal will appear on one side of the bowl encircled by the magnolia, which is the State flower. On the reverse side will be engraved examples of cypress and long leaf yellow pine, two of the trees prominent in the State.

The scroll work will be of the *Louis le Grande* period, as it was during the reign of *Le Grande Monarque* that the State's story began.

In the bowl proper and on a central panel will be an engraving of the famous Cabildo building flanked on either side by medallions showing La Salle at the mouth of the Mississippi and the transfer of Louisiana to the United States by France. Cotton and design showing the tobacco plant will be added with effect around the grouping. The other side of the bowl will show the State Capitol at Baton Rouge, and the City Hall, New Orleans, and both will be flanked by medallions showing the progress of the city and State in commercial lines.

The base of the bowl will contain a large seal of the United States Navy.

The large silver tray on which the bowl is to be set will be typical of the battleship *Louisiana*. On one side the new ship will be shown, and on the other the old ram *Louisiana*. The seal of the Navy will appear at each end of the tray. The bowl will be gold lined, and the complete center piece, which includes the large tray, will weigh 2,000 ounces.

A smaller tray will have two massive scrolls at each end, forming handles, and the State seal, the Navy seal and designs showing cane, cotton, tobacco, rice, cypress, pine and the magnolia flower will appear with artistic profusion. The piece will weigh 300 ounces.

The two fruit baskets will have both the State and Navy seals and the magnolia flower interwoven with Louis XIV scroll work. The bodies of the baskets will represent trellis work with entwined grape vines. The two cake baskets will be similar to the fruit baskets, but will be solid instead of open worked. The two ladles will be very beautiful, the bowls formed by an open magnolia blossom and the handles bearing the State and Navy seals, each surmounted by an eagle.

There will be 58 goblets, one for each parish in the State. On each goblet the seal of the State will appear with the

name of the parish presenting it on the reverse side. The magnolia blossom will form the socket for the cup and continue to the base in the shape of a stem. The edge of the goblet will be festooned with garlands of fruit. Each goblet will weigh from 15 to 20 ounces.

The decorative mounts, including the figures shown in the panels, medallions, etc., are to be modeled, carved, and applied after being carefully finished by hand chasing. The silver to be used will be .935 fine.

### Corporation Reports Filed by Jewelry Manufacturers of North Attleboro, Mass.

NORTH ATTLEBORO, Mass., July 7.—A number of the local concerns have filed their annual corporation reports. C. Ray Randall, treasurer for C. Ray Randall & Co., presents the following figures: Machinery, \$10,970; cash and debts receivable, \$36,963; manufactures and merchandise, \$15,338; total, \$2,371. Capital stock, \$12,000; accounts payable, \$2,865; profit and loss, \$47,506; total, \$62,371.

Alton H. Riley, treasurer of G. C. Hudson & Co., presents this report: Machinery, \$16,845; cash and debts receivable, \$36,158; manufactures and merchandise, \$15,000; total, \$68,303. Capital stock, \$25,000; accounts payable, \$1,867; profit and loss, \$41,436; total, \$68,303.

William W. Sherman's report as treasurer of the H. D. Merritt Co. is: Machinery, \$18,330; cash and debts receivable, \$54,673; merchandise, \$28,390; good will, \$21,900; total, \$126,293. Capital stock, \$100,000; accounts payable, \$8,817; surplus, \$12,593; profit and loss, \$5,973; total, \$126,293.

The annual statement of the W. & S. Blackinton Co., as shown by the report of its treasurer, G. Herbert French, is: Machinery, \$30,905; cash and debts receivable, \$95,492; manufactures and merchandise, \$35,698; total, \$162,095; capital stock, \$150,000; accounts payable, \$2,079; profit and loss, \$10,016; total, \$162,095.

### William H. Saxton, Middletown, N. Y., Files Bankruptcy Petition in New York.

William H. Saxton, a jeweler and optician, at 67 North St., Middletown, N. Y., last Friday filed a voluntary petition in bankruptcy in the United States District Court in New York. The liabilities, given in the schedules, amount to \$9,524. The nominal value of the assets is \$4,906, comprising stock, \$3,000; fixtures, \$1,050; tools, \$250; accounts, \$666. Judge Holt, of the United States District Court, appointed Russell M. Vernon, of Middletown, receiver of the assets.

Among the local creditors are: Ditt & Cox, Middletown, \$180; Annie L. Saxton, Middletown, \$5,850; Arnstein Bros. & Co., New Stivers Printing Co., Middletown, \$100; Merchants' National Bank, Middletown, \$113.

Mr. Saxton bought out his present business in 1903. He formerly carried quite a large stock, but this he reduced some time ago by conducting an auction sale for a month. He is a young man about 36 years of age, and is married. It had been supposed by his creditors that he had other means outside of his business.

### Bold Thief Robs Brooklyn Jeweler at the Point of a Revolver and Escapes.

At the point of a revolver a thief at noon Monday robbed P. Friedrich, 1131 Broadway, Brooklyn. The robber, who was a tall young man apparently 22 or 23 years of age, after entering the store, said that he wished to buy an engagement ring.

Mr. Friedrich, who was about to go to lunch when the stranger entered, called a salesman, Charles Kuehnle, to show the stranger some rings. The visitor said that he desired a ring to cost \$25 or \$30. Mr. Kuehnle took from the show case a tray containing a number of rings, ranging in value up to \$150. The supposed buyer handled several of the rings, remarking on the beauty of several stones. Then he took a revolver from an inside pocket and, pointing it at the clerk, said in a low tone and with much deliberation: "If you move or shout for help I will shoot a hole through you."

Kuehnle was so stunned that he did not utter a word. Keeping the revolver pointed at the clerk, the stranger picked up the tray of rings, placed it under his coat, which he buttoned, and then he moved backward toward the outer door. As he reached the street the thief ran up Broadway and down Kosciusko St.

When the robber dashed into the street Mr. Kuehnle for the first time shouted, and other attendants in the back room came hurrying out, but they did not succeed in capturing the thief. The police of the Ralph Ave. station were notified of the robbery.

The jeweler was robbed in a similar way a number of years ago.

### Pittsburg Police Arrest Men Believed to Have Robbed Kansas City, Mo., Jewelry Store.

PITTSBURG, July 9.—The police of this city to-day arrested on suspicion Hugo Roman and Fred Decker, both of Brooklyn, New York, and it is believed that both were implicated in the robbery of a jewelry store committed on July 4 in Kansas City. Many articles of jewelry were found in two suit cases which were deposited by the men in the baggage room of the Union Station.

Hugo, who is 22 years old, had a great deal of jewelry with him for which he could not give a satisfactory account. Later his accomplice, Decker, was arrested, and he confessed that on the night of July 4 both broke the window of a jewelry store in Kansas City and made off with plunder valued at \$5,000. One pin alone is said to be worth \$1,000.

Decker, who claims to have worked for the Title Guarantee and Trust Co., New York, said that he struck the window with a torpedo cane while the other fellow threw a brick through it. They did this during the noise of the celebration of Independence Day, and were not detected.

The burglar alarm in the store of Egermann & Son, Aurora, Ill., attracted the attention of Capt. Wells and Policeman Strong at that place, about a week ago, but an investigation failed to discover anything irregular in the establishment. A thorough search was made of the store, but no thieves were in sight.

# WM S. HEDGES & CO.,

IMPORTERS AND CUTTERS OF

## DIAMONDS.

Precious Stones and Pearls.

170 Broadway, Corner Maiden Lane, New York.

27 Holborn Viaduct, London.

# Saunders, Meurer & Co. Cutters and Importers of

## DIAMONDS AND OTHER PRECIOUS STONES

FINE PEARLS A SPECIALTY.

65 Nassau St., cor. John St., Prescott Building, Telephone, 1613 Cortland. NEW YORK.

# Chas. L. Power & Co., Cutters and Importers,

## DIAMONDS

AND OTHER PRECIOUS STONES,

170 Broadway, corner Maiden Lane, NEW YORK.

27 Holborn Viaduct, London.

# GOODFRIEND BROS.,

IMPORTERS AND CUTTERS OF PRECIOUS AND IMITATION STONES.

Pearls

Rubies

Sapphires

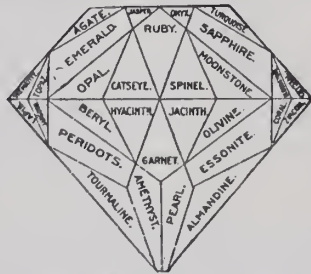

Tourmalines

Gem Corals

Opals

Emeralds

COPYRIGHT, 1895, BY GOODFRIEND BROS.

256 Westminster St., Providence, R. I.  
10 Rue Cadet, Paris.

Tel. No. 662 Cortll.

9-11-13 Maiden Lane, New York.

# CORAL

**BORRELLI & VITELLI,**  
CORAL MANUFACTURING COMPANY,

All kinds of Coral—DROPS, BUTTONS, LENTILLES.  
CORAL NECKLACES, Graduated and Uniform.

PINK AND WHITE CORAL A SPECIALTY.

GOLD MEDAL, ST. LOUIS, 1904.  
GRAND PRIX, LIEGE, 1905.

3 Via Amedeo, Torre del Greco, Italy. 32 Rue d'Hauteville, Paris, France.

401 Broadway, New York.

Telephone, 5412 Franklin.

CORAL

CORAL

### Omaha.

Fritz E. Sandwall, South Omaha, is back from a visit to Denver.

Joseph P. Frenzer has returned from a pleasure trip to Blue Lake, Ia.

A. W. Taylor, Oakland, Ia., was in this city last week, purchasing stock.

Joseph P. Frenzer has been beautifying his store by elaborate decorations and fresco work.

Walter Mandelberg, son of A. Mandelberg, is confined to his home on account of illness.

George W. Ryan, of the Mawhinney & Ryan Co., is traveling through Wyoming on business.

P. E. Flodman and J. L. Jacobson were elected delegates to the State Senatorial convention, which meets in Lincoln August.

Fred Brodegaard and wife gave a house warming at their new country home at Benson, July 3 and 4. Over 500 people called during the two days.

H. J. Penfold, president of the H. J. Penfold Co., has returned home from Philadelphia, Pa., where he attended the meeting of the American Surgical Association.

J. L. Jacobson supplied the gold medal set with diamonds which was presented by the A. Hospe Co. to E. Val Kamp, who has been in the employ of Mr. Hospe for over 25 years.

Jack Jennings and Angus Martin, the two men who were convicted of grand larceny for stealing a diamond at M. D. Frank's jewelry store, were both sentenced to seven and five years respectively in the penitentiary last week.

Mae Hayes, convicted of swallowing a diamond belonging to T. L. Combs & Co. has been sentenced to five years in the penitentiary by Judge Sutton. Her attorney, W. W. Dodge, gave notice that error proceedings would be carried to the Supreme Court, and a hard fight for her liberty would be made before that body.

### Jewelers Gold Bars Withdrawn and Exchanged at New York.

Week Ended July 7, 1906.

The U. S. Assay Office reports:  
Gold bars exchanged for gold coin...\$312,122.6  
Gold bars paid depositors..... 63,713.3

Total .....	\$375,836.0
Of this the gold bars exchanged for gold coin are reported as follows:	
July 2 .....	.....
" 3 .....	\$62,741.7
" 5 .....	136,204.8
" 6 .....	103,079.8
" 7 .....	10,096.1
Total .....	\$312,122.6

### Market Price of Silver Bars.

The following are the quotations of silver bars in London and New York, as reported by Zimmerman & Forshay.

	New York.	London
July 3.....	\$.65 1/4	30 3-16d.
" 4.....	.....	.....
" 5.....	.64 1/2	29 13-16d.
" 6.....	.64 3/4	29 15-16d.
" 7.....	.64 3/4	30d.
" 9.....	.64 3/4	29 15-16d.

E. E. Howendabler, Perry, Okla., expects to discontinue his jewelry business.

## Providence.

### TRADE CONDITIONS.

In spite of the fact that it is the vacation season the shops are unusually busy, some of them being busy into the night. Such a condition of affairs at this time of year is unusual to say the least.

Henry G. Thresher, of the Waite, Thresher Co., is spending his vacation in Maine.

Jewelers were well represented in the list of jurors drawn by the Board of Aldermen at its session last Thursday.

A number of concerns took advantage of the fact that there was a holiday last week and closed their shops for the week, to take needed repairs.

On June 30 the factory of the Gorham Mfg. Co. shut down for two weeks, in order that the annual repairs, inspection of boilers, etc., might be made.

A movement is on foot to purchase a new service for the battleship *Rhode Island* and about \$4,000 already having been contributed for the purpose.

The Castiglioni & Capaldi Co. is the firm in the lead of the concern which has succeeded the T. F. Greenwood Co. at 9 Calender St.

Castiglioni is president; J. Capaldi, treasurer, and R. C. Castiglioni is secretary. The present concern is making a patented watch bracelet.

The Wm. J. Feeley Co. has been awarded the contract for the tablet to be placed in the State House to the memory of Maj.-Gen. John Sullivan by members of the local branch of a well-known Irish society. The tablet will be of bronze and the design particularly neat and artistic.

The commercial travelers are expecting to hold their annual Summer outing soon, and are making promises that they will stand out the jewelers in nattiness of attire and general good looks in the parade they expect to make. All wagers that have been recorded seem to lean toward the jewelers, however.

Articles of incorporation of the Cornell & Andrews Co. have been taken out, following the death of William O. Cornell. The officers of the new concern are Frank W. Andrews, president; Frederick W. Andrews, vice-president; Reuben J. Rice (the brother of Meriden, Conn.), treasurer. The amount of capital stock is \$90,000.

## North Attleboro.

The Codding & Heilborn Co.'s factory closed for 10 days while repairs are being made.

Percy Clapp and Fred Cook intend, on July 15, to go on an extended fishing trip through Maine.

There is an agitation to have all jewelry shops that intend giving their employes a week's vacation to do so the week commencing July 28.

Frank Whiting, of Whiting & Davis; Percy Clap, of Daggett & Clap Co.; C. Forrest, of Frank M. Whiting & Co., and Frank Kennedy, of the Paye & Baker Mfg. Co., were in town during the past week.

The Plainville Stock Co. gave its employes an outing down the Providence river Saturday. The party left town in the morning on a special car for Providence. Arriving in that city the boat was taken to

Field's Point, where a shore dinner was enjoyed. Thence the party went to Crescent Park and passed a pleasant afternoon.

James Danielson Lincoln's will was admitted to probate at Fall River, Friday. It shows many liberal bequests to public charities. The Children's Aid Society of Boston receives \$1,000, the Children's Hospital of Boston secures \$2,000; the Boston Children's Aid Society, \$1,000; the Gwynne Temporary Home for Children of Boston, \$2,000; Nickerson Home for Children of Boston, \$2,000; New England Peabody Home for Crippled Children of Weston, Mass., \$2,000; town of Brimfield, Mass., for the maintenance of the Danielson Lincoln Memorial Library, \$3,500. This latter amount will be raised to \$6,000 if \$5,000 is secured from other sources. Woodbury Melcher and Fred Williams, of Brookline, are the executors.

## Attleboro.

The Attleboro Mfg. Co. and Attleboro Chain Co. will close July 21 to 30 for stock taking.

July 14 is the date selected for the annual shore outing of the employes of the Watson & Newell Co.

Fred Uhlig has been added to the Watson & Newell Co. force of traveling salesmen, to show samples in the Middle West.

Clarence A. Fisher, for years Attleboro representative of George L. Claffin Co., chemicals and jewelers' supplies, has been promoted to the general agency of the business.

The funeral of Reginald D. Fogg, salesman for the Watson & Newell Co., was held at his home last week. The Standard Button Co. sent a floral tribute. Among the bearers was Walter B. Marble, salesman for Marble, Forester & Co.

Charles E. Bliss, recently retired from Bliss Bros., and his son, Chester, a member of the present Bliss Bros. Co., narrowly missed death last week. In an auto they were riding from Taunton to Attleboro, when the machine stuck fast on a railroad grade crossing in the country. They had barely time to get out before an express train reduced the auto to splinters, beyond all repair. The escape of the two men was a matter of seconds.

A large number of the Attleboro jewelry factories are now closed, some for stock taking, more because of a lapse of business, and the bulk of those whose doors are shut will remain closed for a fortnight or more. The employers and employes are embracing the opportunity to get away for vacations. J. Lyman Sweet, of the R. F. Simons Co., with Mrs. Sweet, left last week for England. The voyage is taken solely for Mr. Sweet's health, and eight weeks will be spent in rest and practical seclusion in some English town. Continental sight-seeing is forbidden by his physician. James E. Blake, of the James E. Blake Co., and John C. Cummings, of J. C. Cummings & Co., with their wives, and Harold S. Blake, son of the former, as chauffeur, made a trip last week to Old Orchard, Me., in Mr. Blake's big touring car. Frank H. Sadler, of F. H. Sadler & Co., has opened his Summer place at Cottage City, Mass., and installed his family there. Lawrence Robbins, son of Charles M. Robbins, takes his

vacation in the form of a walking trip to Montreal. The elder Mr. Robbins is spending his vacation at Greenwood Lake, Mass. Arthur B. Cummings and Fred E. King, of Cummings & King, are engaged in a yachting cruise off the Massachusetts "north shore." Charles P. Keeler, of McRae & Keeler, with his family, has started for an auto tour in New Hampshire, of a week's duration. Miles Carter, of Carter, Qvarnstrom & Remington, has made his Summer home at Westport. N. Justin Smith and family are at Touisset, R. I.

## Boston.

August Sweetland, of the firm of C. W. Sweetland, is at Friendship, Me., for an outing.

John M. Cutter, of the Trenton Watch Co., was among the visitors to the trade during the week.

Eugene Sanger, buyer for the house of Harwood Bros., is at Amherst, N. H., for a couple of weeks.

E. A. Cowan, who has been in Europe during the past month, sailed for home on July 5, much improved in health.

Carl D. Smith, of the Smith, Patterson Co., has opened his Summer camp at Munsionsville, N. H., this month, and is enjoying a brief vacation there.

William J. Dron, formerly with Joseph A. Williams, of this city, but for the past three years in business in Brantford, Conn., has sold out his place at Brantford, and returned to the employ of Mr. Williams.

A. M. Mossman, jewelry jobber at 77 Summer St., this city, has taken a retail store on Washington St., near the corner of West St., and will shortly remove his jobbing department to the same building.

Lawrence F. Percival, of D. C. Percival & Co., who is one of the best known yachtsmen in Massachusetts, sailed his new craft, the *Sally VIII.*, to victory on July 4 in the Eastern Yacht Club regatta at Marblehead.

The midsummer outing of the Jewelers' Association of Boston took the form of an auto trip through the suburbs, 25 members participating, with six automobiles in line. The party took dinner at the Woodlawn Hotel in Auburndale.

Buyers in town during the week included: William Senter, Portland, Me.; E. F. Welch, Westboro; E. I. Thomas, Leominster; W. C. Smith, Haverhill; G. F. P. Mayher, Holyoke; A. E. Baudette, Woonsocket; H. S. Hewitt, Brockton; W. A. G. Smith, Rockland.

A number of additions to the employes of Henry Cowan are announced this week. Herbert N. Libbey, for a number of years with Charles May & Son, becomes the head of the material department, and Charles A. Pass, also from the May concern, enters Mr. Cowan's employ. The house will be represented on the road in Massachusetts by Martin Tishler, and William Crowley will have other New England territory, while William O'Leary will be outside city salesman. L. Watson is to take charge of the repair department. Other new employes are Mrs. M. Davis, bookkeeper, and Henry Casey and John Buckley.

J. L. Prince, Ensley, Ala., has sold out to J. H. Waters, Brookwood, and W. K. Thaxter, Birmingham, Ala.

ADDISON W. WOODHULL, President.  
FRANK K. HUFF, Vice-President.

GILBERT T. WOODHULL, Treasurer.  
WILLIAM J. McQUILLIN, Secretary.

## MOUNT & WOODHULL,

IMPORTERS OF

**DIAMONDS,  
OTHER PRECIOUS STONES,  
PEARLS, ETC.**

MAKERS OF

**FINE  
DIAMOND  
JEWELRY.**

26 Maiden Lane,  
(Southwest Corner Nassau Street)

**NEW YORK.**

PARIS ADDRESS:  
5 SQUARE DE L'OPERA.

**BAGG, PERINE & CO.,**  
RARE SPECIMENS OF  
DIAMONDS AND OTHER  
PRECIOUS STONES,  
21 & 23 MAIDEN LANE, NEW YORK.  
Tel. No. 6228 Cortlandt.

EMERALDS,  
DIAMONDS  
AND  
PEARLS.

RUBIES AND  
SAPPHIRES.



CABLE ADDRESS:  
MILBAGG.

## CROSSMAN COMPANY

☞ Be sure and keep us in mind before buying your Fall line of Necklaces and Pendants. We are getting out a nobby line of Necklaces and Pendants set with Baroque Pearls and Colored Stones.

☞ We also have a nice line of Baroque Pearl Rings, Brooches, Collars, Ear Studs, Scarf Pins, Lorgnette and Neck Chains always on hand. Memo. business will receive prompt attention.

3 Maiden Lane - New York

TRADE MARK.  **AZTEC TURQUOISES**  TRADE-MARK.

Mines: MINERAL PARK, ARIZONA.

Of true CERULEAN BLUE, the rarest and most fashionable shade. Turquoises bearing Company's trade-mark are GUARANTEED. A new Turquoise will be given without question to replace any that discolors. The leading Jewelers of the World sell AZTEC TURQUOISES.

**THE AZTEC TURQUOISE COMPANY,**  
12-16 JOHN STREET, NEW YORK.

TRADE-MARKS

OF THE JEWELRY AND KINDRED TRADES.  
Over 4,000 Marks. Second Edition. Price, \$3.00.  
The Jewelers' Circular Pub. Co., 11 John St., N. Y.

## Last Week's New York Arrivals

THE CIRCULAR-WEEKLY each day posts its office a bulletin of the latest buyers visiting New York, which every member of the trade cordially invited to copy.

ALTOONA, PA., L. Lippman, Normandie.  
BALTIMORE, MD., W. Jenkins (Jacobi & Jenkins), Holland.  
BOSTON, MASS., G. A. Reidpath (R. H. White Co.), Imperial.  
BUFFALO, N. Y., W. T. Mitchell (Adam, Meldrum & Anderson), Imperial.  
H. J. Simon (Adam, Meldrum & Anderson), 2 Walker St.  
CHICAGO, S. Carson (Carson, Pirie, Scott Co.), 115 Worth St.  
CINCINNATI, O., E. C. Poage (G. W. McAlp Co.), Breslin.  
ELIZABETH CITY, N. C., J. W. Kight (Kight & Bright), Herald Sq.  
HOT SPRINGS, ARK., D. M. Rinaldo, Herald Sq.  
MINNEAPOLIS, MINN., E. Langen (Towse Mercantile Co.), Normandie.  
NEW ORLEANS, LA., Leonard Krower, Maiden Lane.  
PITTSBURG, PA., S. Cerf (Sol. Cerf & Co. Astor House.  
W. L. McDougall, Union Sq.  
P. C. Gillespie (Gillespie Bros.), Herald Sq.  
ROCHESTER, N. Y., W. P. Briggs (Sibley, Lindsay & Curr Co.), Breslin.  
SACRAMENTO, CAL., J. S. Gattman (Wasserman, Kaufman & Co.), 260 W. Broadway.  
SPRINGFIELD, MASS., H. B. Davison, Astor House.  
G. D. Sleigh (Forbes & Wallace), Herald Sq.  
ST. JOSEPH, MO., R. W. Powell (J. S. Britta Dry Goods Co.), Holland.  
ST. LOUIS, MO., N. J. McEvoy (Ely & Walker Dry Goods Co.), Navarre.  
WASHINGTON, D. C., A. S. Heller (A. Lisner Normandie.  
C. E. Berry (Berry & Whitmore Co.), Imperial.

## Recent Publications.

TALKS BY AN OLD STOREKEEPER. A book for merchants, by FRANK FARRINGTON. 16mo, 150 pages profusely illustrated. Published by the Merchant Helps Pub. Co., Delhi, N. Y. Price, postpaid, 50 cents.

THIS book of talks by an old storekeeper was aptly termed by one of its readers as a "business man's fiction founded on fact." It purports to be a series of interviews with an old-time storekeeper, who speaks of various things that come up in the course of a merchant's career and gives his views thereon, but the matter is brought into connection with some incidents connected with the characters spoken of in the book in such a way as to make it vitally interesting, even if the book is read purely for amusement. The storekeeper, Tobias Jenkins, who retired from business and sold out his store to a young man, John Ballou, discourses on a few natural mistakes made by the latter, and his words of advice and his shrewd, hard-headed philosophy may be found distinctly profitable to the ordinary merchant who reads the book.

The old storekeeper's views on store management, advertising, window display, special sales, treatment of clerks, as well as his general hints, are not only based on common sense, but are the fruit of the author's many years' experience in actual storekeeping, and, in fact, the ring of actual experience seems to be manifest throughout the volume.

The book is neatly bound in cloth and illustrated with half-tones and sketches made by Maud Thurston.



## Philadelphia.

William Boyard, Manayunk, removed last day, with his family, to Rehobath Beach, Del., for the Summer.

J. E. Caldwell & Co. were awarded, last week, the contract for the prizes for the Ocean City Yacht Club regatta.

Charles Diesinger, the diamond dealer, has closed his town house and taken a cottage at Atlantic City for the Summer.

Abe Sickles, of Morris Sickles & Sons, has removed, with his family, to the Royal Palace Hotel, Atlantic City, for the balance of the Summer.

Charles H. Dean, 715 Sansom St., is again this season summering at Atlantic City, where he is almost always to be seen on the Boardwalk in a rolling chair.

Joseph Bradley, a silver plater, 1130 S. Canal St., and William Bachman, Jr., a dealer, 2428 Turner St., were, last week, sworn for service on the July Grand Jury. Weber & Bros.' jewelry store, 2209 N. 3rd St., caught fire, last week, from defective insulation of an electric light wire and was quickly put out, with a loss of only \$500.

Fred Barry, with S. O. Bigney & Co., and R. H. Woodrow, with Cross & Begue, two former Philadelphians, spent the first of July holidays visiting their families in this city.

J. Warner Hitchins, J. Clifford Wilson and Isaac Elliott, of the Jewelers' Club, were the guests of Mr. Wilson last week on his yacht, cruising for several days from Cape May to Beach Haven.

Wm. H. Moore, 1708 Ridge Ave., has engaged his Summer cottage at Pitman, N. J., to which place he has removed with his family. Wm. H. Moore, Jr., has just returned from a honeymoon trip.

The only 4th of July accident sustained in any in the trade is that reported to have happened to William H. Waltz, Perkasiel, Pa., whose thumb was torn and shattered by the premature explosion of a cannon racker.

The stock and fixtures of the retail store of Louis Gwartz, 1034 N. 2d St., recently adjudged a bankrupt, were disposed of at auction at the Freeman building, last week. Bernard Italic, of the Koshland & Italic Co., Inc., has been appointed receiver.

Harry Barry, with M. Sickles & Sons, has removed, with his family, to Lansdowne, Pa., for the Summer. Samuel Chestnut is spending his holidays at Atlantic City. Burroughs Robertson was at Woodwood over the 4th, and Elmer Horn at Easton.

Walter Hazelton, with Charles H. O'Bryon, 735 Sansom St., suffered painful injuries last week by falling during an attack of vertigo after leaving his business. His scalp was severely lacerated and he was removed to his home, to which he has since been confined.

The wholesale district was to a large extent alarmed Thursday night by a fire which started at 107 S. 8th St. Fortunately it was speedily controlled and prevented from spreading to the Sansom St. establishments, which are regarded as mere tinder boxes. The only one in the trade to suffer material loss was J. Myers, diamond broker, 107 S. 8th St. His place was flooded with

water. The loss has not yet been determined.

Morris Sickles & Sons' baseball team defeated, last week, the nine representing L. P. White, by a score of 22 to 21. In the last inning Sickles' team let loose in a Garrison finish and making 11 runs, won out. The only team which has so far defeated Sickles' nine is that of Simons, Bro. & Co., which won by a 5 to 1 score. There is talk of a return match, but the trade is inclined to award the laurels to Simons' nine.

Martin Mayer, an uptown retailer, formerly of the firm of Mayer Bros., with stores on 8th St. and in Atlantic City, was adjudged an involuntary bankrupt last week. The creditors and the amounts claimed are reported to be as follows: B. J. Cooke's Sons, \$158,37; Elias Weinmann, \$183; and Adelaide L. Pfersich & Co., \$199.33. Elias Weinmann has been appointed receiver and fixed yesterday for the sale of the stock of diamonds, watches, rings, pins, etc., fixtures and cut glass at 1229 Chestnut St.

## Lancaster, Pa.

Fred J. Stener, a jeweler, died last Friday at Steelton.

Mr. and Mrs. Wilson Drobs have gone to Atlantic City for two weeks.

J. H. Souseing, New Holland, Pa., has entered the Philadelphia optical college.

Johann Obermyer, a diamond cutter, of Amsterdam, Holland, spent last week in Lancaster with relatives.

Charles L. Evans, of this city, lately watchmaker for Charles J. Künzer, Bluefields, W. Va., has gone to Mexico City, Mex.

Jacob Esch, Intercourse; A. S. Beiler, Lolla; and G. F. Frymyer, Groffs Store, were among the few jewelers visiting here recently.

John J. Bowman, of Ezra F. Bowman's Sons, made a trip last week through the Cumberland Valley in an automobile with several friends.

Harry Lichtenstem, lately in the jewelry business at Lebanon, a brother of Benjamin Lichtenstein, of this city, has engaged in business at Williamsport.

J. H. McKechnie, department superintendent of the Hamilton Watch Co.'s factory, has gone on a visit to his old home, Springfield, Mass., accompanied by his wife and George Daniels, another department superintendent. W. H. Wanby, also a department head, has gone to Reading, Pa., with his wife, and M. J. Bolger, another head of department, is visiting Oklahoma.

## Baltimore.

The City Hall clock was out of order again last week, owing to the grounding of an electric wire, and is being repaired.

Gen. J. Stuart MacDonald, president of the J. S. MacDonald Co., took the oath of office June 30 as naval officer of the port at Baltimore. Speeches and flowers were much in evidence.

The Old Town Merchants and Manufacturers' Association returned last week from their outing to Atlantic City and all pronounced it very successful. J. George Gehring, Jr., was on the committee of arrangements.

Fred Bucher, of Fred Bucher & Sons, who recently moved into their handsomely equipped new home at 218 N. Charles St., has combined his two stores at 12 Clay St. and 219 S. Broadway and moved them into his new place.

H. Bealmear & Co. have leased the building at 25 W. Baltimore St., now occupied as a ticket office by the Western Maryland Railroad Co., and will conduct their establishment there. The firm is temporarily located at 231 and 236 Park Ave. The building has a very handsome front and is centrally located, being between Charles and Hanover Sts.

## Pittsburg.

A number of the local wholesale houses are taking stock.

The Hunter block at Turtle Creek, Pa., in which several jewelry stores are located, was last week sold for \$100,000.

A number of jewelers are out of the city on their vacation. W. E. Schmitt is at Atlantic City, W. A. Rudolph at Turkey Foot Lake and A. M. Bailey at Grove City.

Only one traveling salesman visited Pittsburg last week—Alberta S. J. Schweizer, of the Ansonia Clock Co. E. P. Shattuck took the road for the George P. Barrett Co.

S. Davis & Co., who were burned out several weeks ago, are remodeling their store. The painters are now at work. The firm will carry a much larger line than formerly.

The following out-of-town merchants visited this city last week: H. Zilliken, Wellsburg; C. H. Bauer, Blairsville; L. L. Swan, New Castle; R. A. Noble, Wells-ville; P. J. Manson, Jeanette.

P. S. Gillespie, of Gillespie Bros., who had intended sailing for Europe July 10, left for New York Sunday night, and will sail this week. His brother, A. A. Gillespie, spent last week at Lancaster, Pa., with relatives.

The firm of E. P. Roberts & Sons, Inc., began moving last Thursday night into its new store at 233 Fifth Ave. and continued moving Friday and Saturday. It will be a week or two before the firm finally gets settled. The new fixtures have been installed.

A. Larney & Co., who at present have quarters in the Bessemer building, will shortly move to a ground floor store room in the new Fulton building, being erected at Sixth street and Duquesne Way, one of the latest modern skyscrapers built in Pittsburg by Henry Phipps. The firm will largely increase their stock.

The mystery surrounding the disappearance of a diamond ring worth \$200 from Mrs. Robert A. Tress, 1420 Washington Ave., Allegheny, Pa., was cleared Friday night of last week, by the arrest of a diamond salesman of 128 Moultrie St. The ring was found under a rug, and at the time of its disappearance the salesman is said to have been in the house. He was held on a charge of larceny and later released in \$500 bail.

The August Bruder Co. was incorporated Monday, of last week, in the State of Indiana, with a capital stock of \$40,000, the main offices being in Fort Wayne. The directors are: August Bruder, J. A. and Nora Calhoun.

# EICHBERG & CO.,

IMPORTERS AND CUTTERS OF

## DIAMONDS,

65 NASSAU STREET, (Prescott Building.) NEW YORK.

# STERN BROS. & CO.,

IMPORTERS AND CUTTERS OF

## DIAMONDS,

CUTTING WORKS:  
138-142 West 14th St., N. Y.

CHICAGO,  
103 State St.

LONDON,  
29 Ely Place.

68 Nassau St.,  
NEW YORK.

### Pacific Northwest.

The marriage of George G. Hedger and Miss Myra Gregory took place last week at Walla Walla, Wash.

The store of A. N. Johnson, Estacada, Ore., was broken into last week, and about \$100 worth of watches and jewelry was taken.

E. B. Lecky, formerly of Iowa, has purchased the store of A. Schindeler, North Yakima, Wash., and is now in possession. Mr. Lecky is an experienced jeweler and will carry about the same stock and class of goods formerly carried by Mr. Schindeler.

From Jaeger Bros.' establishment, 29 Morrison St., Portland, Ore., which was robbed June 24, plunder aggregating over \$3,000 in value was stolen. The thieves entered from the back of the store by breaking a pane of glass out of the rear window and prying the steel bars apart guarding the opening. A large quantity of diamond doublets were taken and trays containing rubies, emeralds and sapphires were emptied and gold collars studded with precious stones also went into the pockets of the burglars. No trace of the latter has been found.

### Newark.

A report comes from Totenville that about seven acres of land have been purchased on the bluff near Brown's shipyard by a large watch manufacturing company which is to establish works there.

Proceedings are to be begun against the watch manufacturing company in Greenville, N. J., for the abatement of the smoke nuisance, according to a statement made last week by the corporation counsel of Jersey City.

A story was published in one of the Newark papers several days ago to the effect that two manufacturing jewelers who have shops on Canfield St., recently underwent a disagreeable experience. The one arose early one morning and went to the building in which they have their shops in order to get tackle stored there the day before for a fishing trip on which they were about to start. A manufacturer of leather belting in the same building had reported to the police a few days before that pieces of leather were being stolen from his factory. When the jewelers entered the building the detective who was watching summoned a patrolman and placed the two would-be fishermen under arrest. They were taken to the First Precinct police station in the police patrol wagon, and it was some time before they succeeded in convincing the officers that a mistake had been made. They were released in time to go rejoicing on their fishing trip.

Samuel Silverstone, for some time engaged in the optical business in Peoria, Ill., died recently at his home at the corner of Sixth Ave. and Monson St., that place aged 58 years. The deceased was a member of the Masonic fraternity and of the Order of Modern Woodmen, deputations from both of which organizations attended the funeral. Mr. Silverstone is survived by two sons and one daughter, his wife having died two years ago.

A word to the wise is sufficient

“GEMFINDER”

**A. ROSEMAN, 9-11-13 Maiden Lane, New York**

IMPORTER OF

# DIAMONDS

Maker of Diamond Jewelry



TRADE MARK.

Established 1872

HEADQUARTERS FOR

# AMERICAN WATCHES

Telephone 4115 Cortland

## LEO GOLDSMITH

IMPORTER OF

### DIAMONDS AND PRECIOUS STONES

Headquarters for RECONSTRUCTED RUBIES and SAPPHIRES. All Sizes and Forms.  
9-13 MAIDEN LANE, NEW YORK

THE BOSTON DIAMOND HOUSE

## JOHN B. HUMPHREY CO.

387 Washington St., Boston, Mass.

We are receiving Monthly Shipments of Diamonds from our Brazilian Mines, which are on exhibition at our Boston Office.

Cutters of  
DIAMONDS

Cutters of  
DIAMONDS

## Connecticut.

Mrs. W. Irving Wilcox and Roy Wilcox left Meriden recently for Fishers' Island.

John B. Kirby, New Haven, is spending the Summer months with his family at Silver Sands.

William Sparks, traveling representative of the Seth Thomas Clock Co., Thomaston, recently spent a few days at his home in Thomaston.

Joseph H. Lamb was recently appointed to the position of general superintendent of both factories of the Landers, Frary & Clark Co., New Britain.

Walter A. Ingraham, of the E. Ingraham Co., Bristol, accompanied by his family, left July 6 for Cottage City, where they will spend the Summer.

The William L. Gilbert Clock Co., Wind- ed, June 30, closed its factory for the annual inventory of two weeks, during which time repairs will be made.

C. B. Sanford, who, about a year ago, was appointed superintendent of the office force of the Sessions Clock Co., Forestville, has just moved his family to that place.

Clayton H. Case & Co., Hartford, have an exhibition the three shields in bronze and silver to be competed for at the regimental shooting contest this year in Hartford.

The Ford building, New Haven, owned by Gen. George H. Ford, president of the Ford Co., New Haven, has been sold to the New York, New Haven & Hartford Railroad Co.

William S. Ingraham, of the E. Ingraham Co., Bristol, July 3, was elected a director of the Bristol National Bank to succeed William E. Sessions, who resigned from the board some time ago.

Clarence E. Breckenridge, Jr., Wallingford, son of C. E. Breckenridge, director of the International Silver Co., and Miss Bertha L. Backes, also of Wallingford, have announced their engagement.

The new water wheel of the International Silver Co.'s Shelton factory was placed in position Monday, and the work was completed in time for the turning of the water in the canal Thursday morning, July 5.

Abraham Silverthau, of S. Silverthau & Sons, New Haven, is rapidly recovering from severe injuries sustained during a collision with a wagon while riding his bicycle a short time ago.

G. T. Higginbotham, who was assistant superintendent in the clock factory of the Seth Thomas Clock Co., several years ago, was a recent visitor to old friends in Thomaston. Mr. Higginbotham is superintendent of the South Bend Watch Co.

L. Tunick, of Tunick & Shalett, Torrington, and Miss Rose Rosenfeld, were recently united in marriage in New York. The couple spent their honeymoon at Atlantic City, N. J., returning home July 4.

David P. Snow, who died recently at the age of 65 years, had been in the employ of the Meriden Britannia Co., Meriden, for a period of 40 years. The deceased was born in Westbrook, but had spent much of his life in Meriden.

Thomas C. Lewis, Jr., treasurer of the Ford Co., New Haven, and Miss Lillian Viola Proctor, daughter of Mr. and Mrs. Sanford Proctor, New York, were married

recently in New York. The couple will reside in Westville, Conn., after Oct. 1.

Passers-by have recently been attracted to the show window in the store of S. Kronholtz, Stamford, by a display of the silver trowel with which Bishop Turney laid the corner stone of St. John's Parochial School at that place. The trowel was supplied by Mr. Kronholtz.

Mrs. Cora Northrup was arrested a short time ago in Bridgeport on a charge of stealing a ring valued at \$11 from Max Wittstem, 1162 Main St., at that place. The jeweler agreed not to prosecute the woman provided the gem was recovered. Upon surrendering the ring the woman was advised to leave the city at once.

Joseph W. Beach, for several years engaged in the manufacture of bronze metal goods, died, July 2, after an illness of several weeks' duration, at his residence, 1427 Fairfield Ave., Bridgeport. The deceased was born in Derby 64 years ago. He was of a kindly disposition, and admired and respected by all who knew him. He is survived by a widow.

A night watchman at the silver shop of the E. H. Smith Silver Co., Bridgeport, accidentally overheard a conversation between four supposed yeggmen in the vicinity of the factory shortly before midnight July 7. He followed the men to a rendezvous and there heard enough to convince him that they were planning to extend their depredations to the silver plant. The watchman telephoned General Manager Parks of the concern, and also a deputy sheriff, who went post haste to the factory, arriving just in time to see the would-be burglars effecting a hasty retreat, before completing their plans.

## Buffalo, N. Y.

Berthold Block, of Berthold Block & Co., ring manufacturers, and his wife go to their country place near Melland, Ont., next week to spend the balance of the Summer.

Heintz Bros., manufacturing jewelers, have donated a beautiful silver cup which will be given as one of the prizes at the Skat tournament to be held here next week.

Adolph Block, of the Queen City Ring Mfg. Co., Ellicott and N. Division Sts., has purchased a large auto touring car, one of the most expensive that has been shipped to this city.

T. & E. Dickinson & Co., retailers, close their store at noon on Saturday during July and August, to give the firm members and employes a half holiday. This fact is unusual, in that not another Buffalo jewelry store closed on Saturday afternoon. All of the optical stores in Main St., however, do so under a signed agreement.

Mrs. Carrie Schlenker, a saleswoman, charged with robbing the store of the Freeman Jewelry Co., 84 Seneca St., was released from jail on bail last week. It is understood she is now in Batavia at the home of friends, who are working to prove at the trial that Mrs. Schlenker was insane at the time she committed the alleged thefts. About \$150 of the \$1,500 worth of jewelry stolen has been recovered.

Benjamin Summer, 24 years old, an employe of King & Eurele, wholesale jewelers,

is under arrest here on the charge of stealing gold rings, brooches and pins of a total value of \$200. The thefts are alleged to have covered a period of two weeks. Summer came here from Cleveland, O., about three weeks ago. The firm missed the jewelry and located some of it in a Niagara Falls pawnshop. Then followed the identity of the alleged thief, who, at the Falls, had pawned the goods under the name of Robert W. Strong. Summers has been held for the Grand Jury.

## Cleveland.

Capt. R. E. Burdick sailed for Europe July 4, where he will spend six weeks in the diamond markets.

Among the jewelers visiting in this city in the past week were: W. J. Higgins, Shelby; E. N. Davis, Kent, and George F. High; Medina.

All the jewelry stores in the downtown section of the city will close at noon on Saturday during July and August. Some of those in other portions may not observe this rule strictly.

C. P. Coyne, 37 Bond St., commenced an auction sale Monday morning in order to clear out a lot of stock that has accumulated in the wholesale department, which is to be discontinued.

The Taylor building, where the Webb C. Ball Watch Co. will locate when completed, is progressing nicely now. The outside walls are all up and the front finished. Workmen are now engaged on the floors and the inside work.

Herbert W. Burdick, of the Bowler & Burdick Co., returned a few days ago from a buying trip to New York and other eastern points. Mr. Burdick states that business so far this year has been better than for the same time last year, and that the fiscal year ended a short time since was the best in the history of his house.

Some months ago two men entered the cigar store of Isaac Rosenblatt and offered to sell him five diamonds cheap. He had them examined and they were declared to be well worth the price asked. Rosenblatt bought five jewels the next day, paying \$250 for them, but later he says they were found to be paste. Last week on a warrant sworn out by Rosenblatt, Sam Richmon, a salesman, was arrested. He was later released on bail.

In an item published in THE CIRCULAR-WEEKLY last week, referring to the issuance of a charter to the Allan Jewelry Co., Charleston, S. C., and another to the James Allan Co., of the same place, the firm name of the latter was given as James Allan & Co. The Allan Jewelry Co. will conduct the wholesale business and the James Allan Co. the retail business. The officers of the retail firm are: President, James Allan; vice-president and treasurer, W. S. Allan; secretary, R. H. Allan. The following are the officers of the wholesale concern: President, James Allan, Jr.; vice-president, E. F. Miscally; secretary, C. F. Steinmeyer, Jr. As previously reported, the Allan Jewelry Co.'s capital stock is \$75,000, and that of the James Allan Co. is \$50,000.

# OPALS

WE ARE CONSTANTLY RECEIVING  
ROUGH OPALS DIRECT FROM THE  
FIELDS WHICH WE CUT INTO DESIRABLE  
SIZES AND SHAPES.

WE HAVE A LINE OF DARK MATRIX  
KNOWN AS

## BRECCIATED OPAL

WHICH IS INTERESTING AND  
REASONABLE.

### BUY FROM THE CUTTERS

## AMERICAN GEM & PEARL CO.

14 & 16 Church St., NEW YORK

LONDON: 16 Holborn Viaduct

PARIS: 39 Rue de Chateaudun

### FROM MINES TO MARKET

# DIAMONDS

Complete Stock—Right Prices

'NOUGH SAID

## WM. I. ROSENFELD

19 Maiden Lane

NEW YORK

IMPORTERS

## DIAMONDS

CUTTERS

## Jacob Strauss & Sons

14 MAIDEN LANE

NEW YORK

## SOHN and HYMAN

IMPORTERS OF PRECIOUS AND IMITATION STONES

Crystals Engraved and Painted from Photo. Crests and Coats of Arms Engraved. Stone  
Seal Engravers and Incrusters. Lapidary Work a Specialty.

### JOBGING STONES A SPECIALTY

47 and 49 Maiden Lane,

NEW YORK

### New Stores and Enterprises.

J. A. Wolfe is a new jeweler in Sidney, Nebr.

Wm. Kaiser will shortly begin business in Millbank, S. Dak.

C. L. Hoffman, Minneapolis, Minn., is about to add a line of jewelry to his gent's furnishing business.

A Mr. Walker has completed arrangements to open a retail jewelry store in Strasburg, Sask., Can.

Cooper & Borsheim recently started the jewelry manufacturing and engraving business in the Paxton Block, Omaha, Nebr.

J. R. Jenkel will shortly open a retail jewelry store in Van Ness Ave., near Sutter St., San Francisco, Cal. He will also conduct an optical department.

Emil Zielke will start a school of instruction in the manufacture of jewelry, in conjunction with his watchmaking school, Omaha, Nebr., in the near future.

David Perreault, formerly watchmaker for the Grant Jewelry Co., Lowell, Mass., has started in business on his own account at 260 Merrimac St., in that city.

J. Hirsh & Co. is the firm name of a general store which recently began business at West Berkeley, Cal. The concern will carry a line of jewelry and novelties.

T. S. Weekley has opened a store in the Otten building, on Oak St., Hood River, Ore. Mr. Weekley will carry a line of silverware and jewelers' notions, and will make a specialty of fine watch repairing.

Articles of incorporation were granted in Camden, N. J., last week to the Larney-Barr Jewelry Co., with a capital of \$75,000. The incorporators are Anthony Larney, F. C. Barr and Henry A. Davis. The company is to do both a wholesale and retail business.

### Canada Notes.

The assets of Henry Ratelle, Cornwall, Ont., insolvent, are offered for sale by tender.

A. W. Meyers, of the Canadian Jewelry & Importing Co., and T. J. Perte, both of Winnipeg, Man., have returned to that city from extended purchasing trips in the east.

Out-of-town buyers calling on the Toronto, Ont., trade last week included J. Park, Bradford, Ont.; F. R. Clark, Warrenton, Ont.; J. E. Mulligan, Omamee, Ont.; James Johnston, of Johnston Bros., Montreal, and W. T. Wherly, Harriston, Ont.

George H. Lees & Co., Ltd., have been incorporated under the laws of Ontario as manufacturing jewelers, etc., with head office at Hamilton, Ont., and a capital of \$100,000. The provisional directors are William Lees, George H. Lees, Stuart H. Lees, Elizabeth Lees and Herbert S. Lees.

Edgar Tripp, Canadian commercial agent for Trinidad and Tobago, West Indies reports that Canadian jewelry is being introduced. The souvenir jewelry is pronounced better than any other that comes there, the designs being chaste and the workmanship excellent. A larger trade in ordinary silver goods would be done, but the purchasers are not satisfied with the word "sterling." The hall mark Lion is always looked for, and the people will not accept anything not so stamped as genuine.

## News Gleanings.

R. I. Campbell, Golden, Colo., has sold out.

W. M. Loftus has purchased the store of Monnen Bros., Tucson, Ariz.

Chas. E. Barker, Peterson, Ia., has sold his business to S. A. St. Cyr.

G. L. Sande, Larimore, N. Dak., sustained a slight fire loss recently.

The store of Ernest Bowden, Ripley, Tenn., was recently destroyed by fire.

A. G. Lietsch, Mt. Union, Ia., has bought the stock of H. L. Tucker, New London, Ia.

Edgar Levy has succeeded to the business of Levy & L'Herisson, Natchitoches, La.

Ludwig Bondy, Davenport, Ia., has gone to Vienna, owing to the severe illness of his father.

A new plate glass front is being added to the store of Harry D. Beresford, Fort Dodge, Ia.

The wife of Henry Elbelt, St. Joseph, Mo., has gone to Germany, to pay a visit to relatives.

Paul Berens, West Hope, N. Dak., is about to erect a new building for his jewelry business.

F. C. Roder, formerly in business in Rosedale, Kans., has permanently located in Higginsville, Mo.

The jewelers of Gloversville, N. Y., are closing their stores every night in the week except Saturday during the months of July and August.

The Fred. Frick Clock Co., Waynesboro, Pa., recently shipped a large program clock to Altoona, in the same state, for the new \$300,000 Altoona high school.

L. L. Powell, formerly of 1939 Broadway, Denver, Colo., has moved to 1423 Fremont St., where, in addition to his regular retail business, he will make a specialty of fine repair work.

The retail jewelry store of Geo. A. Sites, Lake View, O., was entered July 2, by thieves, who escaped with a large amount of miscellaneous jewelry. Thus far no clue has been obtained.

From Tuesday to Saturday last week the Reed & Barton silver works, Taunton, Mass., were closed for stock taking and vacations. A large number of the employees migrated to Lakeville, Mass.

S. A. Asquith, of the retail firm of S. A. Asquith & Bro., Waterloo, Ia., has put in an equipment for polishing stones for his retail trade, having learned the business while on a trip to California.

A burglar was caught in the act of prying open the front door in the store of G. L. Shirmman, Bellingham, Wash., a short time ago, by a police officer who gave chase to the intruder, but failed to catch him.

John L. Green, proprietor of the Junction City Jewelry & Novelty Co., Junction City, Ark., has purchased the business of Constantine & Fuller, Eldorado, Ark., and will take personal charge of the latter store.

A trustee's sale of the stock of P. L. Lowenthal, Bradford, Pa., was held on Monday, July 2, and the stock of the bankrupt was sold for \$1,407.75. The first dividend will probably be declared at an early date.

Edwin F. Lilley, Milford, Mass., whose

store was burned recently, is having repair and reconstruction work pushed rapidly to completion, and will shortly have a more attractive establishment than before the blaze.

C. F. Miller, Cairo, Ill., is about to make extensive improvements in the interior and exterior of his store. A new front of gray pressed brick with a marble base will be erected and the interior will be entirely renovated.

Jerome Flannery, who has been acting as Denver correspondent of THE JEWELERS' CIRCULAR—WEEKLY since Jan. 1, 1906, left there, July 1, for New York en route for England, where he will spend the balance of the summer on a vacation trip.

E. H. Freeman, Blairstown, N. J., has sold out to John Knox, until recently in the employ of David Couse, Newton, N. J. Mr. Freeman, who had conducted the business at Blairstown for the past 25 years, will retire from active work.

At the sale of the stock of Roy R. Spencer & Co., Newark, N. Y., now in bankruptcy, about \$700 was realized. The sale was under the direction of T. Davis Prescott, trustee in bankruptcy. The claims against the estate amounted to more than \$6,000.

The store of A. M. Greer, Iowa City, Ia., was broken into recently by thieves. The exact amount of the loss is unknown. The proprietor was unable to open the safe after the robbery, owing to the fact that the thieves had tampered with the combination.

John S. Lockwood, who lived with his sister in Kansas City, Mo., took an overdose of laudanum July 4, and was removed to the general hospital. He called his sister at 1 o'clock and told her he had taken the poison. She then called for assistance. Lockwood is a jeweler, 35 years old.

B. Gerson, of Pensacola, Fla., has moved into the Brent Block, having taken two of the new stores. In addition to the present business of china, cut glass and bric-a-brac a full line of diamonds, watches, gold jewelry and silverware will be added, of which Ed Sharp, of Philadelphia, Pa., will have charge.

The P. J. Cummings Co., Attleboro, through Treasurer P. Joseph Cummings, has filed with the secretary of the Commonwealth of Massachusetts the following annual corporation report: Merchandise, \$28,661; machinery, \$20,407; cash and debts receivable, \$23,384; manufactures, \$5,612; good will, \$55,000; stock, \$100,000; accounts payable, \$736; floating debt, \$20,736; profit and loss, \$576.

Miss Emma Marguerite Girardet, the daughter of the late John Girardet, for many years a well-known jeweler of Louisville, Ky., died of asphyxiation recently at 629 E. Broadway, Louisville. It is believed that she committed suicide, and that the act was the result of unbalanced mental condition produced by continual grieving over the death of her parents. Miss Girardet was a graduate of the Louisville High School and was the niece of Matt Irion.

The charter of A. B. Griswold & Co., Ltd., New Orleans, La., granted last month, has been published in full. The capital stock of the corporation is fixed at \$150,000 (divided into 1,500 shares) of which

\$100,000 have been subscribed. Of this H. Ginder holds 996 shares and Geo. P. Griswold, A. G. Palfrey, E. L. Roane and William B. Young hold one share each. The officers are: H. Ginder, president; Geo. P. Griswold, first vice-president and manager; A. G. Palfrey, second vice-president and assistant manager; Edgar L. Roane, treasurer, and William B. Young, secretary.

## Utica.

Henry Greenman, Richfield Springs, who recently went into voluntary bankruptcy, has filed an application for a final discharge and it is returnable before Judge Ray at Norwich, N. Y., July 17, at 10 A. M.

Local jewelers have signed an agreement to close their stores evenings during July and August. The stores will close at 6.30 o'clock each evening except on Mondays and Saturdays. The latter evenings have always been particularly busy ones, and the jewelers unanimously decided to keep open until the customary hour.

Abraham Hermann, an optician at 15 Court St., Watertown, has been placed under bail in proceedings begun against him to recover damages for slander. The plaintiff in the suit against him to recover \$5,000 damages is Miss Bidah Nellis, a former employe. The latter sued Hermann to recover wages she alleged were due her, and it is over this action that the alleged slanderous statements were made. The woman secured a judgment against Hermann. Then he brought a suit against her to recover a ring, and also started an action for slander against Miss Nellis' father. Hermann is also a defendant in other legal proceedings. He formerly lived in Ohio, where his wife secured a decree of divorce against him and an allowance of \$5,000 alimony. Hermann left Ohio and located in Watertown, and now Mrs. Hermann has brought suit to make the judgment of the Ohio courts against her husband the judgment of the New York State courts. The latter litigation has been noticed for trial.

## Savannah, Ga.

R. Van Keuren, of R. Van Keuren & Co., was a member of the June term Grand Jury of Chatham County.

S. E. Theus, of Theus & Co., was a winner of a prize at a recent shooting contest held by the Savannah Rifle Association.

On Saturday afternoon Alexander & Edwards, attorneys, filed in the office of the Clerk of the United States Court at Savannah a schedule of the liabilities and assets of Sternberg & Co., involuntary bankrupts.

An attractive catalogue of 32 pages, bound in a green cover, has been issued by L. W. Rubenstein, 54 Maiden Lane, New York. The catalogue contains illustrations and descriptions of the emblem rings made by Mr. Rubenstein of 10-karat gold enameled in appropriate colors. He is ready to furnish electrotypes of the patterns to retailers who desire such cuts for advertising purposes. It is also announced that he is ready to furnish estimates on special patterns and to quote prices on application. If desired, the rings may be made in 14 instead of 10 karat gold.

# GORHAM SILVER

## SOME NOTABLE ACCESSIONS.

¶ It is now generally recognized by discerning Jewelers that there is an increasing demand on the part of the average purchaser for such small articles of silverware as, by reason of their practical utility, their decorative appearance and their moderate cost, may be regarded as suitable for gifts.

¶ The Gorham Company, therefore, have taken pains to largely, but discriminatingly, increase their line of small wares despite the fact that this has always been notable for the complete and varied nature of its character.

¶ It will now be found that for diversity of range, attractiveness of design, and excellence of workmanship it is without parallel.

## THE GORHAM COMPANY,

Silversmiths and Goldsmiths

Fifth Avenue and 36th Street, New York.

### BRANCHES:

CHICAGO,  
137 Wabash Ave.

NEW YORK,  
23 Maiden Lane.

SAN FRANCISCO,  
Temporary Office:  
1103 Broadway, Oakland, Cal.

LONDON,  
Ely Place.

WORKS: Providence and New York.



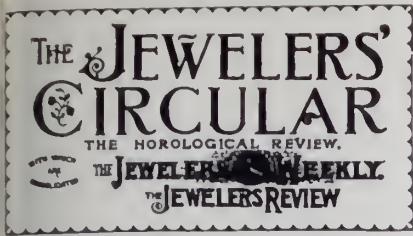

PUBLISHED EVERY WEDNESDAY BY  
**THE JEWELERS' CIRCULAR PUB'G CO.,**  
 11 JOHN ST. COR. BROADWAY, NEW YORK.  
 TELEPHONE: CABLE ADDRESS: JEWELAR NEW YORK  
 148 CORTLANDT.

OL. LII. JULY 11, 1906. No. 23.

Subscription in U. S., Canada and Mexico, \$2.00  
 other Countries in Postal Union, \$5.00  
 Single Copies, .10  
 Remit by check or money order. Remittances in  
 money are at sender's risk.

Notices of changes in standing advertisements  
 must be received one week in advance; new mat-  
 ter can be received up to Monday.

No attention paid to communications unless ac-  
 companying by full name and address of the writer.  
 This is asked not necessarily for publication, but  
 as an evidence of good faith.

**Index to Special Articles.**

	Page.
Handsome Gold Vase Presented to Dr. Edward Brooks. Illustrated on front cover; text on page	38
Over \$40,000,000 in Gems Imported During Fiscal Year	37
Assets and Liabilities of Bernard Steinfeld..	37
Death of Peyton Dearborn.....	37
Secretary of the Treasury to Act on Alleged Improper Seizure of Jewelry from Toledo Merchant	37
Imports at the Port of New York.....	38
The Canadian Gold and Silver Stamping Bill Approved by Banking and Commerce Committee	39
National Monthly Import and Export Statistics. Jewelry, etc., Exported from New York.....	39
New Jersey Court Refuses to Restrain William H. Rogers from Using His Name on Silverware	41
How a New York Diamond Salesman Was Robbed in Oregon.....	41
Death of C. E. Sherwood.....	41
Funeral of the Late Max Lissauer.....	43
Creditors of David Hartstein, New York, Considering His Offer to Compromise.....	43
Pennsylvania Retail Jewelers Form Organization at Pittsburg.....	43
Design Selected for the Silver Service to Be Presented to the Battleship Louisiana.....	45
Corporation Reports of Jewelers of North Attleboro, Mass.....	45
William H. Saxton, Middletown, N. Y., Goes Into Bankruptcy.....	45
Pittsburg Police Arrest Men Believed to Have Robbed Kansas City, Mo., Jewelry Store..	45
Bold Thief Robs Brooklyn Jeweler at Point of Revolver and Escapes.....	45
Archie Rutherford Sues H. A. Kirby Co.....	55
What Must Be Done to Protect Patents and Trade-Marks in Hungary.....	77
Some German and French Horological Inventions.....	79
The Addimeter.....	81
Clock Soon to Celebrate the 200th Anniversary of Its Ticking.....	81
A New Style of Watch Without Hands.....	83
Time as Indicated by Some New York Clocks.	83
A New Watch Constructed With the Tourbillon Escapement.....	83
German Inventor's Mode of Tightening Loose Hand Setting Posts.....	83
The Optometrist's Catechism—(Continued)...	90
Why Many Fail With the Skiascope.....	91
The Health Ray Lens.....	91
How Shall I Begin to Advertise?—(Concluded).....	93
Recent Booklets and Folders.....	93
An Ingenious Novelty for the Effective Display of Jewelry.....	94
A Business Talk to Salesmen—(Concluded)..	94
Side Lines for Jewelers.....	95
Mode of Preparing Silver for Application of Red Enamel.....	97
Interesting Exhibition of Doulton Pottery....	99
Recent Reappraisements of China.....	99
Popular Talks on Law—(Continued).....	101

**Dr. Kunz's Report on Precious Stones.**

THE annual report of Dr. Geo. F. Kunz, giving in detail the production of precious stones for the year just past, has just been published by the United States Geological Survey, through whose courtesy we are enabled to again give the full text of the same, the first instalment commencing in the issue of July 18. This report, which will eventually form part of the Government publication known as "Mineral Resources of the United States for 1905," is somewhat smaller in form than the report of last year, but at the same time is as replete in all details in connection with the finding of precious stones throughout the world for the 12 months which it covers, as any of Dr. Kunz's previous compilations, and will be as distinctly interesting to jewelers who follow the subjects covered.

In the introduction the salient features of the report are noted in general terms, and jewelers who may have neither the time nor inclination to follow in detail all the subjects covered by the government expert will do well to read carefully this part of his work, if nothing else. On the other hand the many members of the trade who have in former years taken a deep interest in the report will find a careful perusal of the entire text will prove both instructive and profitable to them in their study of gems, as from it can be had a general review of all departments of the precious stone industry, and a collection of facts relating to gems, their discovery and use in all parts of the world that can be had from no other source.

**Retail Jewelers Now Organizing.**

AS THE CIRCULAR-WEEKLY goes to press, meetings are being held at many places for the purpose of forming State associations of jewelers which in turn will elect delegates to participate in the convention to form a national association, which will be held in Rochester, N. Y., Aug. 3 and 4. Among the principal State associations to be formed yesterday are those of Pennsylvania, for which a meeting was held in Pittsburg; New York, at Albany; Connecticut, at Hartford; West Virginia, at Parkersburg; Oklahoma, at El Reno, and South Carolina, at Charleston. The meeting of the State association of Illinois will be held to-day at Springfield. The opticians of Michigan will meet to-day at Detroit and the jewelers of the State begin their meeting to-morrow in the same city, while the meeting of the Ohio jewelers is scheduled for the 17th. As it is impossible to obtain reports of most of these meetings in time for this issue, the accounts will have to be deferred until the issue of July 18.

To the jewelers of all the aforesaid States, as well as those of Missouri, Massachusetts, Iowa, Wisconsin, North Dakota, Minnesota, South Dakota and Nebraska, who have already formed associations, THE CIRCULAR-WEEKLY extends best wishes for success, and hopes that the movement for organization now manifest throughout the entire trade will be given by retail jewelers generally the serious and careful consideration which a subject of this importance naturally deserves.

**Retail Jewelry Business in San Francisco Continues to Increase.**

SAN FRANCISCO, Cal., July 5.—Within the next three weeks many large retail jewelry stores will resume business again, and clerks and watchmakers who have been out of employment will be able to get back to their old occupations. Many of these have for the time being been engaged in other lines of work, while others have sought positions in different parts of the State.

The retail stores that have been doing business report a volume of business much in excess of the anticipations of two months ago. There is also a large amount of repair work, especially on watches and clocks, for these were thrown around quite promiscuously on the morning of April 18. There is a great deal of work being done in restoring silver tableware that has been damaged, most of this being for jewelers who kept such articles in vaults, which afforded a measure of protection.

This week will witness quite an exodus of traveling salesmen to the country districts. There are many jewelers in the interior of the State who have the interests of San Francisco so much at heart that they refuse to patronize houses in other cities, preferring to let their stock run short and wait for the establishments here to get on their feet once more in a business way. The large wholesale houses here are now all ready for trade with a fair stock of goods on hand for immediate shipment and plenty on the way.

**the H. A. Kirby Co.**

Archie Rutherford, who has been for a number of years a stockholder and sales manager of the H. A. Kirby Co., 13 Maiden Lane, New York, recently began a proceeding in the United States Circuit Court at Providence, R. I., where the factory is located, asking for an injunction restraining Mr. Kirby from continuing the business in a way that would violate his rights, and also asking for appointment of a receiver. Jacob Fromme, of New York, acted as Mr. Rutherford's attorney, and Mr. Kirby was represented in court by a Providence lawyer. A temporary restraining order was granted, and to-day a hearing is to take place in Providence on the motion for the appointment of a receiver.

Mr. Rutherford charges that he is the owner of one-fifth of the shares of the company's capital stock, and that Mr. Kirby has assumed absolute control of the business in violation of his rights as a minority stockholder. When Mr. Rutherford began his association with the company, it is said, its capital stock was \$150,000, and he took \$30,000 worth. Since then, it is said, the undivided profits have been used in increasing the capital stock until it amounts to \$300,000. Mr. Rutherford claims one-fifth interest in the whole.

The New York office so long in charge of Mr. Rutherford was in personal control of Mr. Kirby in the last week, and Mr. Rutherford's name was taken off the door. Mr. Kirby did not desire to make any statement further than to say that several people who had been with him for several years have seen fit to go elsewhere.

# Diamonds Wanted!



He swore by the bright stars  
above her.  
(You know how a lover can  
swear.)  
How he'd love her and love her  
and love her:  
And the stars twinkled down at  
the pair.  
(You know how a star can  
twinkle  
When maidens to lovers confess.)  
They want just one thing—A  
DIAMOND RING,  
"Shipped by the next express."  
An assortment of precious  
stones, loose or mounted; pins,  
rings, brooches, etc., will be  
sent to any jeweler on mem.

## CROSS & BEGUELIN

Importers and Cutters of Diamonds and Precious Stones

43 Rue de Meslay, PARIS Telephone, 2188 Cortlandt 17 Maiden Lane, NEW YORK



In these days of high priced diamonds and close competition, a mounting that will increase the attractiveness of your diamonds is worthy of your most careful consideration, and the Arch Crown Mounting does this to the letter.

The importance of having the gem securely and perfectly set is a matter that concerns you vitally. The Complete Bearing, which alone is found on the Arch Crown Mounting, has been brought to such a state of perfection that the work of the setter is practically done in advance for him so accurately that perfect results in stone setting are always insured.

You should mount your Fall stock of diamonds in Arch Crowns, carrying an assortment for remounting customers' gems, all of which will be profitable.

Order from your jobber if more convenient, or direct from us.

Samples cheerfully sent for inspection.

**Arch Crown Mfg. Co.**

26 Camp Street,  
NEWARK, N. J.

**ARCH CROWN MOUNTINGS  
IMPROVE DIAMONDS**

### New York Notes.

Elias Gordon, 401 Broadway, has gone out of business.

L. W. Sweet & Co., 37 Maiden Lane, are making alterations in their store.

A. F. Lowenthal, 37 Maiden Lane, returned from Europe this week on the *Kaiser Wilhelm II.*

Frank S. Sherry, Boston representative of Joseph Fahys & Co., has been in New York during the past week.

Jerome M. Lissauer, with R., L. & M. Friedlander, after a pleasant vacation, has resumed his trip on the road.

Max G. Ernest, 558 Columbus Ave., is a member of the July Grand Jury for New York County, sworn in last week.

Albert F. Strasburger, manager of Wana-maker's New York jewelry store, sailed Saturday for Paris on the *Philadelphia*.

Among the prominent singers at the Sangerfest, held last week in Newark, N. J., was William Hoffman, with R., L. & M. Friedlander.

John Frankel, formerly of Joseph Frankel's Sons Co., 68 Nassau St., sailed recently on a pleasure trip to Europe on *La Provence*.

Andrew Irons, formerly with the Rogers, Lunt & Bowlen Co., Greenfield, Mass., is now with his father, Joseph Irons, 16 John St., New York.

Emanuel Arnstein, of Arnstein Bros. & Co., 65 Nassau St., accompanied by his wife, left last week for a brief stay in Europe, sailing on the *Kronprinz Wilhelm*.

Herbert Cooper, of the Cooper Diamond Co., 49 Maiden Lane, accompanied by his wife and daughter, will sail July 21 on the *Campania* for a six weeks' tour of Europe.

Christian Dorflinger, senior member of C. Dorflinger & Sons, 36 Murray St., sailed June 30 on the *St. Louis* for Europe, accompanied by his grandson, Dwight C. Dorflinger.

E. Goldschmidt, of the Steel & Taylor Co., 31 E. 17th St., accompanied by his wife, is in Europe on a combined pleasure and business trip, having sailed recently on *La Provence*.

Mr. and Mrs. Alfred E. La Vigne, of Mathey Bros., Mathez & Co., announce the marriage of their daughter, Stella, to Edward Freytag on Monday, July 2, at St. George's Church, E. 16th St.

Several representatives of watch manufacturing companies who were seen this week say that they have no knowledge as to a report from Tottenville, to the effect that a new watch factory is to be established there.

Eugene A. Kennedy, of the Kennedy-Carey Co., 198 Broadway, is favorably mentioned in a syndicate letter sent out from New York by "Macaulay," in which he speaks of former newspaper men who are now succeeding in other occupations.

An interlocutory decree of divorce was granted last Thursday to Mrs. M. Mayer from her husband, D. Mayer, by Supreme Court Justice Blanchard. The Mayers were married in 1900, and separated last year. The case was tried before a referee.

Tiffany & Co. are advertising this week a reward of \$100 for the return of a circular brooch in which baroque pearls alternate with diamonds, the article having been



st, June 17, by a patron of the house while automobiling between Tarrytown and New York.

J. Bernstein sailed Saturday on the *Roanland*, and will return Sept. 8. Dr. George F. Kunz, of Tiffany & Co., returned Monday after a 10 days' vacation in the country.

Charles Danziger is no longer with Henry Freund & Bro., 71 Nassau St., and his trade will be looked after by Louis Freund, Leo Goldschmitt and L. M. Heymann.

The Mercantile National Bank is sending out circulars announcing its removal to the new quarters in the Western Union building, 195 Broadway, corner of Dey St.

Herman Stein, 210 Eldridge St., sent out this week an announcement that the business will be conducted after this by a co-partnership under the name of Braumstein Stein.

Lambert Bros., 968 Third Ave., are to furnish two diamond-studded watches which will be awarded by the *Daily News* in New York in a popular voting contest confined to officers of Irish societies.

Harry Rosensweig, a Brooklyn jeweler, was brought into the Adams St. Court last Friday on the charge of stealing three diamond rings from his wife Sadie, who lives at 92 Orange St. He was paroled for a hearing of the case.

Erle R. Sheppard, formerly traveling representative with Schickerling Bros. & Co., is now with the Dreyfus Mfg. Co., 89 Fulton St., makers of rings and gold jewelry, as its representative in Pennsylvania, New York and the middle west. He will start to-morrow on his first trip.

Henry Bohm, of the Bohm-Bristol Co., San Francisco, Cal., and the Bohm-Allen Co., Denver, Colo., who has been in New York for a week or two, making his headquarters with Joseph Frankel's Sons Co., 68 Nassau St., has returned to Denver and expects to reach San Francisco about Aug. 1.

A truck of the Tiffany Studios, while laden with antiques and stained glass, was struck last Friday by a trolley car in Long Island City, and the contents were practically demolished. The truck was returning to Manhattan from the repair factory at Corona. The street car company is expected to pay for the damages, which were considerable.

Samuel Hochhaus, well known in the diamond trade, who had been representing Valhiet & Maxwell on the road, started in business for himself Monday as a diamond importer with temporary quarters at 14 Maiden Lane. Mr. Hochhaus will make his first trip to Europe for his own business in the latter part of the month, and will sail from New York, July 28, on the *Vaderland*.

John Scheidig & Co. was last week incorporated to conduct the optical manufacturing business carried on by a co-partnership under the same style at 50 Maiden Lane. The first meeting of the incorporators will be held this week when officers will be elected. The incorporators are: S. and J. Scheidig, New York; W. A. Wirth, of New Jersey. The authorized capital stock is \$10,000.

Six scarf pins, a diamond brooch, two gold neck chains and three ladies' watches to the value of \$500 were among the arti-

cles seized by a customs inspector from the baggage of Wm. Hoffman, treasurer of the United Brewing Companies, Cincinnati, O., who was a passenger on the *Grosser Kurfuerst*, which docked in New York last Tuesday. He said that the articles were intended as presents for friends.

Early on the morning of July 4 a bullet from a revolver in the hands of a reckless celebrant struck Nathan Gans, a jewelry peddler of 241 Clinton St., while he was standing in front of his home, and was embedded in his skull. Gans, who was 63 years old, was able to walk to the Beth Israel Hospital, where the surgeon extracted the bullet, and congratulated him on his narrow escape from death.

Harry Levinson, 39 years old, a jewelry salesman employed by Louis Sonnabend, 15 Elm St., Boston, Mass., was arrested Thursday at 74 Mill St., Astoria, L. I., where he had been living with relatives. He was taken to the Tombs Police Court in New York and arraigned on the charge of grand larceny made by his employer, who accuses the salesman of taking jewelry valued at \$1,200. Levinson said that most of the jewelry had been returned to the Boston man. The salesman was held to await extradition papers.

A report from Comanche, Ia., says that L. E. Anthony, of that place, was the buyer of the large pearl recently found at Red Wing, Minn., by Wm. Bates. It was later announced, however, that Maurice Brower, 16 John St., had bought the Bates pearl, the weight being 68 grams, and not 86 grains as was reported in the western papers. Mr. Brower said that some of the stories told in the western papers of the circumstances under which the pearl was found were not quite accurate. He was informed that the shell containing this pearl was one of a bunch sold to Mr. Bates for 75 cents. The exact price that Mr. Brower will put on the pearl is not yet announced, but it is intimated that something like \$15,000 may be required to take the gem from him.

According to figures given out by New York banking corporations, which are selling the new stock of Sears-Roebuck & Co., the western mail order concern sold during the year 1905 jewelry and silverware to the value of \$1,454,452. The circulars sent out by the bankers indicate large gains in the sales of various kinds of merchandise. The object of the recent \$40,000,000 incorporation under the laws of New York, it is said, is to give the concern certain advantages in organizing subsidiary companies that cannot be had under the Illinois laws, but it is said that there is no intention of conducting business from this State as a center. According to reports, organizations of business men in several lines of trade are investigating certain phases of the mail order business with a view of blocking legislation which might give further advantages to companies of this kind.

The committee having charge of the fifth annual outing of the 24 Karat Club, which will be held Saturday, Sept. 8, has decided to hold a clam bake at Porto Peck Hotel, Long Branch, N. J., after which the usual programme of athletic sports will be engaged in. The members and guests of the club will leave New York on that date at 10 A. M., taking the Sandy Hook boat

from Pier 10, at the foot of Cedar St., and going directly to Long Branch. The military band of the First Regiment, N. G., S. N. J., has been engaged for the day, and will accompany the members down in the boat, then to the hotel, and will return with them in the evening. The usual prizes for athletic sports will be awarded and the sub-committees on the various events will be announced in the near future. Altogether about 150 members and guests are expected to participate. The committee in charge of the arrangements are John B. Wood, chairman; E. R. Crippen, Alfred Krower, James R. Gleason and Percy Savory, to whom all applications for tickets should be addressed.

Members of the Jewelers' Bowling League of New York met Monday evening of last week in order to make arrangements for the coming tournament. President C. F. Brinck was in the chair and there was a representative attendance. The time set for the several clubs to send in their applications was July 1, and Secretary A. C. Capouilliez reported the receipt of application from all the teams which participated in last year's games, with the exception of the Elgin team, which has been withdrawn, the members having decided to combine with the Cooper Diamond team, which will be entered under that name. There will, therefore, be 15 teams, the same number as last year. A committee was appointed to make up the schedules for the coming season, and this with the names of the bowlers will be issued about Sept. 1. It is expected that games will start about the middle of September. The Albion Alleys at Sixth Ave. and 23d St., New York, were selected for this seasons' tournament, and it is believed that the location will meet with general approval.

A representative of the house of Boucheron, one of the leading jewelry firms of Paris, was in New York recently and obtained a lease for a long term of years of a new building now being constructed at 590 Fifth Ave., between 47th and 48th Sts. The building, which will be a six-story marble structure, is to be ready for occupancy by Sept. 1. Boucheron is to occupy the store and basement, and will probably lease the upper floors. The structure has a frontage of 27.6 by 100 feet. It is owned by R. M. Haan, proprietor of the St. Regis Hotel. On the same block are the homes of Charles T. Cook, the president of Tiffany & Co., and Perry Belmont, while on the opposite side of the street are the residences of Helen M. Gould and the Golet family, also the Frederick Roosevelt house recently acquired by Charles A. Gardiner. On the southwest corner of Fifth Ave. and 47th St. Simon Frankel, of Joseph Frankel's Sons, is putting up a new building into which a number of jewelry houses are to move. Jewelers say that the accession of Boucheron to the Fifth Ave. colony will add to its strength as a jewelry center. The store in this city is to be a branch of the Paris establishment, and it is understood that some manufacturing will also be conducted here. While Boucheron's representative was in the city he supervised the manufacture of several special pieces of jewelry for which, it was said, he had orders from some of the Vanderbilts.

IN THE HEART OF THE JEWELRY DISTRICT.

**Guardian Trust Company,**

170 BROADWAY, COR. MAIDEN LANE, NEW YORK.

Capital and Surplus - Over \$1,000,000

Equitable rates of interest allowed on surplus funds.

Collection of out-of-town items made on reciprocal basis.

FRANK W. WOOLWORTH, President.

GEORGE W. FAIRCHILD, Vice-President.

CHARLES L. ROBINSON, Vice-President.

LATHROP C. HAYNES, Secretary.

ALFRED M. BARRETT, Asst. Sec'y.

Prominent Jewelers  
Among our DirectorsLUDWIG NISSEN.  
A. K. SLOAN.  
LEOPOLD STERN.**THE ORIENTAL BANK.**

ESTABLISHED 1853.

182 and 184 Broadway, <sup>Corner</sup> JOHN STREET, NEW YORK.

Capital, - - - \$750,000.00.

Surplus and Profits, 1,100,000.00.

**ACCOUNTS FROM THE JEWELRY TRADE ARE SOLICITED.**R. W. JONES, Jr., President.  
NELSON G. AYRES, First Vice-President.  
GEO. W. ADAMS, CashierLUDWIG NISSEN,  
ERSKINE HEWITT, } Vice-Presidents.  
CHARLES J. DAY, }

R. B. ESTERBROOK, Assistant Cashier.

**The Market and Fulton National Bank of New York.**

ORGANIZED 1852

81-83 FULTON STREET.

Capital, \$1,000,000.

Surplus, \$1,335,000.

ALEXANDER GILBERT, President.  
R. A. PARKER - - Vice-President.  
T. J. STEVENS, - - - Cashier.  
JOHN H. CARR, - Asst. Cashier.**Invites the Accounts of Jewelers.**

Will extend every facility that good banking will justify.

**SAFE DEPOSIT VAULTS.****The Chatham National Bank**

Broadway and John Street, New York

H. P. DOREMUS, Cashier

GEORGE M. HARD, President

W. H. STRAWN, Ass't Cashier

**THE STATE BANK**

376-378 GRAND STREET, NEW YORK

**Capital and Earned Surplus, over \$1,100,000. Deposits over Fourteen Millions.**

Offers a favorable market for short and long time jewelry and diamond paper

The Officers and Directors of

**THE MERCANTILE NATIONAL BANK**

of the City of New York announce  
the removal of their banking rooms  
to their new quarters in the Western  
Union Building, 195 Broadway,  
corner of Dey Street, and invite your  
inspection of their equipment

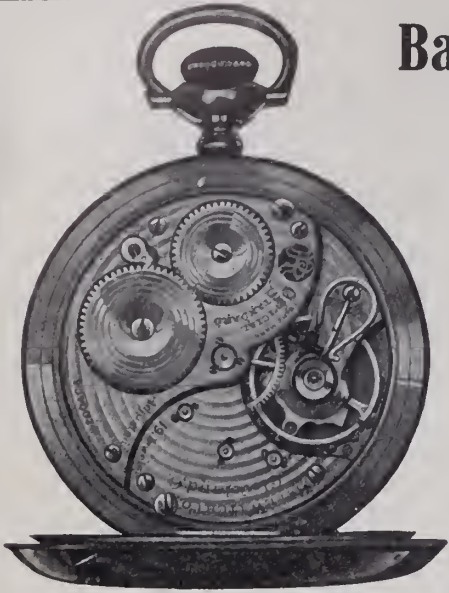

## Ball's Official Standard R. R. Watches

WHAT WOULD YOU GIVE FOR A LIFELONG CUSTOMER?

Try this plan :

Sell your next watch customer a "Ball."

Its reliable performance will convince him you are a dealer to be depended on—he'll keep coming back for other things.

The watch will win you his business and friendship for always.

*Write for booklet, and watch this space.*

We want to add a lot of new friends to the Ball family of railroad watch dealers.

### THE WEBB C. BALL WATCH CO.

CLEVELAND  
Ball Building

CHICAGO  
804-6-8 Railway Exchange

ESTABLISHED 1854.

INCORPORATED 1893.

## JUERGENS & ANDERSEN Co., DIAMONDS,

MAKERS OF FINE JEWELRY,  
92 TO 98 STATE STREET,  
CHICAGO.

23-25 Looijersgracht, Amsterdam, Holland.

# THE HERMAN KECK MFG. CO. CUTTERS OF DIAMONDS.

### FOR SALE.

A complete diamond cutting outfit of twenty benches, European make, consisting of sawing machines, rounding machines, laps, tongues, dops, scouring stands, etc., all in first class condition. Will sell cheap, if sold in bulk at once, as we have replaced them with American tools.

MANUFACTURING JEWELERS, SILVERSMITHS.  
Recutting and Repairing of Diamonds.

17-19-21-23 West Fourth St.,  
CINCINNATI, O.

RUDOLPH NOEL

## RUDOLPH NOEL & CO.

IMPORTERS OF

# DIAMONDS

2 Tulp Straat, AMSTERDAM

Phone 1902 John

37-39 Malden Lane, NEW YORK

PHILIP NOEL



# WESTERN DEPARTMENT

Western Office:  
204 COLUMBUS MEMORIAL BUILDING,  
CHICAGO.

Telephone:  
4079 CENTRAL,  
CHICAGO

Vol. LII.

CHICAGO, WEDNESDAY, JULY 11, 1906.

No. 23.

## Chicago Notes.

Reuben W. Cohen is on a trip to Minneapolis.

W. A. Fay is taking a vacation at Charlevoix, Mich.

James W. Clark spent July 4 at his native town of Haddam, Conn.

J. A. Lucas is taking a vacation at the northern Wisconsin lakes.

Miss Leila Eudaley, formerly with Loftis Bros. & Co., is now with J. F. Dailey & Co.

W. S. Sparrow, western manager for Stern Bros. & Co., is back from the Pacific coast.

A. P. Du Puis, representing E. E. Stanger, left last Saturday for the Providence territory.

Elmer A. Rich, in addition to his diamond business, is handling the Cantlose eyeglass holder.

J. A. Cunningham, with Regnell, Bigney & Co., celebrated the 25th anniversary of his marriage last Tuesday.

Creditors of the estate of the late Geo. F. Schmitt, Battle Creek, Mich., have received their first dividend of 15 cents.

J. F. Dailey & Co. have erected over their store the largest watch sign in Chicago. It is five feet high and weighs 300 pounds.

George and Fred Pettee and "Tom" Hoefer left last Saturday for a tour of the Great Lakes in a motor boat, owned by the Pettee brothers.

Ed. Fishman, for many years with the F. E. Morse Co., has severed his connection with that firm. Mr. Fishman contemplates going into business on his own account.

Harry J. Mayers, with the Emporium, San Francisco, was here last week buying goods. Mr. Mayers is general manager and has also taken Harry Jehlinger's place as buyer for the concern.

A. E. Madsen, of Rettig, Hess & Madsen, is again at his Minneapolis office after a three weeks' vacation spent at Clear Lake. J. Mark and A. Cohen, with the same firm, are on a northern trip.

Frank Behrendt, diamond buyer for Otto Young & Co., will sever his connection with that concern Aug. 1. Mr. Behrendt will thereafter represent several eastern manufacturers of gold jewelry.

Racine (Wis.) celebrated the Fourth of July by holding a reunion of the Spanish-American War veterans. A large industrial

parade, in charge of J. W. Spence, was one of the features of the day.

All of Sproenble & Co.'s salesmen have started on their Fall trips: C. L. Caliger for Michigan and Minnesota, A. Ellbogen for Indiana, J. Donnelly for the Pacific Coast and P. H. Winterberg for the east.

C. P. Kryhl, of C. P. Kryhl & Son, Santa Ana, Cal., passed through here last week on his way home after an eight weeks' tour of all the principal cities of the United States. Mrs. Kryhl accompanied him.

A Masonic silver trowel which is to travel around the earth as a symbol of brotherly love was presented to a local lodge here last week. It was on exhibition for two days at the retail jewelry store of H. W. Gilmore & Co., 504 W. 63d St.

H. C. Barker, for the past nine years with Mandeville, Carrow & Crane, will hereafter represent the western selling agency for Omega watches for which A. Max Holzheimer is the general manager. Mr. Barker starts on his first trip through his old territory Aug. 14.

Mrs. Henry Hyman, 308 W. 63d St., who has been conducting the jewelry store at that address since the death of her husband, has been appointed watch inspector for the L. S. & M. S. Railroad. Mrs. Hyman recently graduated from the Northern Illinois College of Optometry.

H. S. Aicher and F. J. Aicher, who represent the Alvin Mfg. Co., were here last week, F. J. Aicher coming from New York. H. S. Aicher was in charge of the Chicago office during the absence of W. E. Hayward, the resident Chicago manager. Both the Aicher brothers are now on their respective western trips.

H. W. Gilmore, formerly of H. W. Gilmore & Co., 455 W. 63d St., who recently sold his interest in that establishment to S. C. McKnight, has opened a new store at 504 W. 63d St., which is said to be one of the most attractive jewelry establishments in Chicago. The new concern, H. W. Gilmore & Co., is a corporation, Mr. Gilmore being president.

Charles E. Reeve leaped or fell from a window on the 12th floor of the Stewart building, Tuesday, July 3, and was instantly killed by striking a skylight on the third floor. The skylight forms the roof of the mailing department of Loftis Bros. & Co., and a panic was caused among the 200

employees at work there when they saw the man's head and shoulders protruding through the glass. S. Lindhagen was struck by a piece of iron, and Miss Emma Tiark was hurt by falling glass.

The diamond jewelry which Mr. and Mrs. Berg obtained on memorandum from Elmer A. Rich, and which was pawned with the Bauman Loan Co., has been redeemed. In addition to principal and interest the loan company received \$350 for their trouble in engaging counsel in the proceedings brought by Mr. Rich. Bauman's suit against Mr. Rich for \$50,000 damages has been dropped. All of the pawned goods have been redeemed except those secured by Mr. and Mrs. Berg from A. Lipman.

Among the buyers in Chicago last week were: R. E. Lincoln, Plano, Ill.; "Sam" Diamond, of Maas, Hirschberg and Diamond, Sterling, Ill.; Jas. G. Mines, Wayne, Nebr.; Harry J. Mayers, with the Emporium, San Francisco, Cal.; N. V. Cole, Michigan City, Ind., recently retired; Albert Brown, of Downey & Brown, Lincoln, Ill.; Will Haseltine, of Haseltine Bros., Kokomo, Ind.; M. E. Barnes, of Barnes & Foster, Spencer, Ind.; J. W. Spence, Racine, Wis.; C. P. Kryhl, of C. P. Kryhl & Son, Santa Ana, Cal.; Mr. and Mrs. John M. Bigwood, Terre Haute, Ind., and David Goldman, Milwaukee, Wis.

The delegates of opticians and jewelers from Chicago and surrounding territory will leave over the Grand Trunk Railroad at 11.05 Sunday morning, July 29, for the Rochester convention. The round trip fare is \$18.80 with the privilege of returning from Buffalo to Detroit by boat and stop-over privileges at Buffalo and Niagara Falls. Those purchasing tickets from points west of Chicago will see that their tickets read from Chicago, east over the Grand Trunk Railroad, and should not fail to ask for a certificate before leaving home. Those desiring to go with the Chicago party and who wish to engage a berth for the trip should write to A. G. Larsen, care of the Julius King Optical Co., Chicago Savings Bank building, this city.

Frank Killgore, Caldwell, Kans., contemplates selling out and moving to Washington, to be near his parents, who live in that State.

# To the Jobbing Trade.



## A WINNING COMBINATION

Direct Importers of Diamonds  
and Manufacturers of Diamond  
Mountings of every description



### San Francisco.

The California Watch Case Co. is now located on O'Farrell St., near Larkin St.

The Golden West Jewelry Store, located before the fire at 8½ Stockton St., is now established at 1645 O'Farrell St.

J. R. Jenkel will open a jewelry store on Van Ness Ave., near Sutter St., within a few days and will also conduct an optical department.

Henry Bohm, of the Bohm-Bristol Co. San Francisco, and the Bohm-Allen Co. Denver, Colo., has returned to Denver and will be here about Aug. 1.

Paul V. Garin has just moved into a handsome store on Fillmore St., near Geary St., and although the fittings are not all in place he is already doing considerable business.

Ralph Friedman now has an office with Carrau & Green, at 1510 Buchanan St. Quite a colony of jewelers has sprung up here, and this section is becoming known as a jewelry center.

S. Sternheim & Son, formerly located on Market St., where they carried on both retail and a wholesale business, are now on Sutter St., near Van Ness Ave., where a full line of silverware is being carried.

William Glindemann, formerly located in the *Examiner* building, at 3d and Market Sts., is now at 1532 Fillmore St., where he is carrying his usual high grade goods, and in addition has a well-fitted optical department.

The handsome new store of Hamme Smith & Field, at Eddy St. and Van Ness Ave., was formally opened to the public last week, the first store of this kind in the new retail district. A large stock of goods is now on display, and this firm is carrying the same high grade lines as before and finds that the demand is for the best. The manufacturing department supplies the trophies and medals for the Fourth of July field meet in Golden Gate Park.

Rothschild & Hadenfeldt, formerly located on Sutter St., this city, are now in Oakland. They have secured a satisfactory site for a factory there, at 28 San Pablo Ave., and have a large amount of machinery, tools, etc., coming from the East. When completed this factory will be by far the largest and best equipped of any establishment of its kind on the Coast, and Rothschild & Hadenfeldt will be in a better position than ever to carry on the manufacturing business.

Work is progressing rapidly on Shreve & Co.'s new store, at Van Ness Ave. and California St., but it will be several weeks before it can be finished and ready for occupancy. There is also a stock of goods on hand in the building at Post St. and Grant Ave., and the place is becoming quite a rendezvous for tourists. The lease for this building is now being taken down and as soon as insurance matters are settled the structure will be put in shape for occupancy.

The Missouri, Kansas & Texas Railway Co., of Texas, has sent out notice announcing that Webb C. Ball, Cleveland, O., has been appointed general time inspector, with headquarters at Dallas, Tex. The appointment dates from July 1.

## Kansas City.

Prof. M. M. Thomas, Medford, Okla., was enrolled with the Southwestern Optical College.

J. H. Whitney, with the Edwards & Sloane Jewelry Co., has just returned from a fishing and hunting trip to Fargo, N. Dak.

C. E. Banta, Pittsburg, Kans., and wife, were visitors at the home of E. S. Villmoare, traveler for the C. B. Norton Jewelry Co., last week.

J. C. Davis, a Florida optician, who took an optical course in this city, three years ago, is back here on a visit for a couple of months.

J. F. Hibbard, Amsterdam, Mo., was in the city last week, and announces that he will move to Mound City, Mo., where he will engage in the same line of business.

W. M. Jaccard, of the Jaccard Jewelry Corporation, has just returned from his buying trip to Europe, and states that the company expects to move into the new location by Sept. 15.

George Kricke, of the manufacturing firm of the Hassig & Kricke Jewelry Co., has just returned from Emporia, Kans., where he and a large party of friends went on a Fourth of July fishing trip, as the guests of the local jewelers.

Samuel M. Bannister, at one time engaged in the retail jewelry business, and also for several years connected with his brother in the publication of the *Saturday Herald* in this city, died recently in Los Angeles, Cal. He leaves a widow and one son.

Travelers who have called on the jewelry trade all over the west state that there is a heavy demand for young men who are good manufacturing jewelers and watch-makers. Retailers, it is said, are unable to find enough competent men in this line of work.

L. E. Atterbury, Marshall, Okla.; A. J. Roberts, Chanute, Kans., and George Casper, Kansas City, Mo., have enrolled with the Kansas City Polytechnic Institute. Ed. Levin, who has been taking a course there, has finished and gone to St. Joseph, Mo., where he takes a position in his father's store.

E. H. Hemenway, formerly of Stoneham, Mass., who took a course in optics at the Southwestern Optical College a few years ago, and has since that time located in western Kansas, was in this city last week, on his way back to Massachusetts, where he will locate permanently in his profession.

The front window in the retail jewelry store of Grim & Smith was broken one night last week, and jewelry and diamonds valued at about \$1,000 were taken. In the rush of closing the store the night before one of the proprietors overlooked the goods in the window, and they proved too big a temptation to the outsider before morning.

The following out-of-town jewelers were in this city last week: E. R. Moses, of E. R. Moses Mercantile Co., Great Bend, Kans.; I. Eller, Richmond, Mo.; George A. Young, Moberly, Mo.; E. C. Banta, Pittsburg, Kans.; F. W. Galer, Nowata, Okla.; A. R. Kane, Baxter Springs, Kans.; E. A. Durlinger, Burrton, Kans.; C. B. Libby,

Weir City, Kans.; C. A. Clement, Springfield, Mo.; F. C. Roder, Higginsville, Mo.; M. B. Gordon, Braymer, Mo.; Mr. Pettit, of Kelly & Pettit, Bonner Springs, Mo.; W. A. Carrant, Nickerson, Kans.; J. A. Allison, Rolla, Mo.; F. S. Hester, Lawrence, Kans.; E. M. Crelin, Chillicothe, Mo.

C. P. Kionka, of the firm of Kionka & Kionka, has just returned from his trip through Minnesota and Wisconsin. Coming home he stopped off in Waterloo, Ia., long enough to make a fishing trip with O. J. Ludwig, the local jeweler, in his launch. He was also entertained, while in Omaha, by the Ak-Sar-Ben aggregation, in their club rooms.

## Indianapolis.

J. H. B. Ness has opened a repair shop in North Indianapolis. He is located at the corner of Clifton and 27th Sts.

A peculiarly constructed clock in the display window of F. M. Herron, North Pennsylvania St., drew scores of passers-by to the show window last week.

While in Portland, Ore., recently, Charles Bernloehr, of Chris. Bernloehr & Bros., visited the store of Yeager Bros., who formerly had a store at La Porte, Ind., and were frequent visitors to this city.

Berne B. Cohen, of H. Cohen & Sons, was a candidate before the Marion County legislative convention recently for the nomination of representative, but was defeated. Harry E. Cohen, of the same firm, will go to New York, about Aug. 1, to purchase Fall and holiday goods.

Charles Mayer & Co. recently had a display of cut glass made by the Wright Rich Cut Glass Co., of Anderson. Glass was shown in four different stages, beginning with the plain or blank glass, and ending with the finished and polished piece. The display attracted marked attention.

J. H. Reed has been appointed official watch inspector for the Pennsylvania lines. He holds this position with the Vandalia also. Mr. Wilcox, saleswoman for Mr. Reed, has returned from a three weeks' visit in New York. Harry J. Reed is in Georgia, where he may accept a position.

Charles B. Dyer recently turned out a handsome loving cup for the Indiana High School Athletic Association. The cup was 13½ inches high and was beautifully engraved. John A. Dyer, manager of the repairing department of Charles Mayer & Co., is building a handsome home in North Alabama.

Henry A. Winn, who has had a store in Brightwood for several years, has opened a new store in the Pembroke Arcade. Mr. Winn has just been appointed official watch inspector for the Indianapolis Southern, a new railroad just opened up for traffic by the Illinois Central. He will continue his Brightwood store.

A local paper had an extended article recently on the hunting experiences of J. C. Sipe and Mrs. Sipe, who have just returned from a protracted stay in Mexico and Colorado. As trophies of the chase to add to his already large collection Mr. Sipe brought home the skins of one lion, seven bears, eight wildcats, a snowshoe lynx, and other wild animals. The largest bear skin was nine feet long. Mr. Sipe has had the wildcat skins made into a sleigh robe.

## St. Louis.

Mr. Crompton returned to St. Louis July 5 from a week's visit to Chicago.

J. Boydsen, Albia, Ia., accompanied by his wife, was in this city last week on business.

Mr. Aehle, of the Whelen-Aehle-Hutchinson Jewelry Co., returned last Friday from a fortnight's fishing trip on the Gasconade River, in Missouri.

S. H. Bauman, of the Bauman-Massa Jewelry Co., returned from Europe last week, having arrived at New York Friday. The salesmen of this firm are preparing to go out on the road next week.

Moses Strauss, of the L. Bauman Jewelry Co., attended the funeral of August Fister, a young jeweler of St. Charles, Mo., who died at the age of 30, July 2, and was buried July 6 at St. Charles.

Mark Eisman, traveling representative of the L. Bauman Jewelry Co., started for a six months' tour of the south July 9, going from St. Louis direct to Birmingham, Ala., which he is making his headquarters.

Edwin Hale, traveling representative for William Weidlich & Bro., returned last week from a business trip and will leave for his regular tour of the south this week. E. S. Gregory, also a traveling salesman for this firm, will leave this week for Kansas and Nebraska. William Weidlich was expected to return from Connecticut yesterday.

A party of employes of the Mermod, Jaccard & King Jewelry Co. left Saturday night for a fishing trip on the Cass River, at Stonewall, Ark. In the party were Lee Schumm, Walter Lauman, Jos. Rodgers and Elmer Puellman. They brought four tents with them and several of the members of the party were accompanied by members of their families.

Among the visiting jewelers who called on the trade here last week were: H. W. Foerste, Okawville, Ill.; A. P. Linn, Carbondale, Ill.; Enno Dick, New Baden, Ill.; J. J. Lysakowski, Lebanon, Ill.; Mr. Anderson, of the firm of Bransford & Anderson, Union City, Tenn.; W. H. John, Pacific, Mo.; Fred Simon, Collinsville, Ill.; J. Beilenson, Helena, Ark.; C. F. Gardner, Sorento, Ill.

The employes of the Mermod, Jaccard & King Jewelry Co. gave a successful picnic at Ramona Lake, June 30. Special cars brought the picnickers to the grounds, and the afternoon's programme consisted of a speech, athletic events and a baseball game between the married and the single men. The athletic events were won by the following: Fifty-yard dash for boys, Edward Pentz first, George Hazzard second; 50-yard dash for men, Albert Riesen; 50-yard dash for girls, Bertha Burkell; egg and spoon race, Miss Lilly Wonderley; 100-yard dash for men, Albert Riesen, who made it in 11 flat; 75-yard dash for men, Frank Hassner first, Thos. Kinsella second, Mr. Kinsella's weight being 250 pounds; nail-driving contest, Miss Gussie Starr; three-legged race, Fred Harnagel and Gus Schuerman. The prizes were umbrellas, military brushes, cuff links and bracelets. Owing to the delayed state of alterations in this store the auction sale has been continued until the improvements have been completed.

### Cincinnati.

Edgar Fox, of Lindenberg & Fox, has left on his regular trip north.

Frank Herschede, of the Frank Herschede Co., is ill with typhoid fever.

S. Lindenberg, of Lindenberg, Strauss & Co., leaves this week on a business trip east.

F. T. Thompson, formerly of Tiffin, O., is now with Joseph Mehmert as watchmaker.

J. C. Miller, of the Miller Jewelry Co., has started on a trip through Pennsylvania and New York.

A. Herman, of Herman & Loeb, has returned from a stay in Germany, greatly improved in health.

Edward Albert, of the firm of Albert Bros., left this week for a three weeks' stay at Hot Springs, Va.

John C. Daller, Sr., manager of the Clemens-Oskamp Co., spent last week in camp on the Miami River.

Mr. Conroy, buyer for the Geo. W. Meyer Jewelry Co., Chattanooga, Tenn., was here last week visiting friends.

E. J. Morris, manager for the Loring-Andrews Co., has been enjoying a Summer's outing at Clark's Lake, Mich.

Burton Fox, of Fox Bros. & Co., has had plans perfected for a handsome new house which he will soon erect in Avondale.

E. E. Elsbach, manager for Hahn & Oppenheimer, has returned to business, after suffering from an attack of typhoid fever.

Sam Wagner, with George Simper, is expected to return this week from Europe, where he made a tour among the principal cities.

Charles Sieglitz, Vevay, Ind., was here last week to accompany his son home. The latter has fully recovered from an operation for appendicitis.

The sympathy of his friends in the trade was extended, last week, to J. C. Holderbach, Findlay St., whose son, the past week, died of heart trouble.

Cincinnati friends of L. W. Sturdevant, of Newark, O., received word, last week, that he had suffered serious injuries in a recent street car accident.

Jonas Wise, of Frohman & Co., has started on a western trip, and B. S. Newman

has returned from a pleasure tour in the east to make his southern business trip.

Fred G. Gruen, of D. Gruen, Sons & Co., and his bride are due in New York July 14 on the *Kaiserin Augusta Victoria*, on which they return from their honeymoon spent abroad.

Mr. and Mrs. Frank Maier, Bowling Green, Ky., were in town on business last week. E. R. Matters, Neosho, Mo., with his bride, also passed through here, en route to the east.

John A. Herschede, of the Herschede Hall Clock Co., is making a 10 days' stay at the furniture exhibition at Grand Rapids, where the company has an exhibit of clocks under the management of Walter Herschede.

Among the out-of-town buyers here, last week, purchasing stock, were: Philip Hoar, Aurora, Ind.; J. G. Irwin, Harriman, Tenn.; Mr. Metzger, Lexington, Ky.; G. F. Gallup, Catlettsburg, Ky.; Mr. Davis Jackson, O.; C. A. Gossard, Washington C. H., O.

Oscar Keck, of the Herman Keck Mfg. Co., sailed yesterday on the *Kaiser Wilhelm der Grosse* for Europe. Eugene Mahy, foreman of the diamond cutting factory of this company, with all the force of this department, July 30, enjoyed a banquet in the club house at Chester Park and also attended the opera in the evening.

### Pacific Coast Notes.

H. W. Arnstine, Cleveland, O., was a recent visitor to the trade in New Mexico.

C. H. Wright, Eureka, Cal., is building a large new residence at the corner of H and 13th Sts.

B. Hartfield, Anaheim, Cal., is preparing to move into the building about to be vacated by Hussman Bros.

C. Reimer, Arcata, Cal., and Miss Laura Norton, of McKinleyville, were married last week, and are making a brief visit to Eureka.

O. G. Tullis, Santa Monica, Cal., will move his stock, about Aug. 1, from his present location to 233 3d St., the store formerly occupied by A. M. Montgomery. Mr. Tullis has taken a long lease and will remodel the front.

### Minneapolis and St. Paul.

Mr. Noble has resigned his position with Morsman & Feagans, St. Paul.

The Gophir Diamond Co. has opened newly furnished offices at 391 Robert St. St. Paul.

A. O. Holmes has started in business on Plymouth Ave., North Minneapolis.

A new retail store is about to be opened for business on Lake St., near Hennepin Ave., Minneapolis.

T. A. Shirley, St. Paul, who was recently burned out in the Ryan annex, has resumed business at 307 Baltimore Block.

George W. Wooley and W. E. Mowrey watchmakers for the trade, have reopened in their old quarters at 404-6 Ryan annex St. Paul.

The Minneapolis School of Watchmaking and Engraving has completed its reorganization and will continue its business along the same lines as hitherto.

Arthur Anderson and Gus Anderson have left S. H. Clausin & Co., Minneapolis. Victor Sax and Carl York succeed them. A. A. Schaeppi is away on a vacation.

The Ryan annex building, St. Paul, which furnished office room for a number of jewelers, is to be rebuilt as soon as possible. Plans for the work have been prepared.

C. F. Yeager, manager of the Twin City Jewelry Mfg. Co., St. Paul, has reopened in the old quarters on the third floor of the Ryan annex, his apartments not having been damaged badly by the fire.

Kirchner & Renich, Minneapolis, have enlarged the space occupied by their manufacturing jewelry business and added three more men to their force: George Metzler, a trade watchmaker, Carl Swanson silversmith, and John Lewis, platinum worker.

Several cheap watches and some clothing were stolen recently from a second-hand store at 213 First Ave., S., Minneapolis, owned by Hans A. Cumfeld. The thieves had pushed in one of the front windows with their elbows or knees and through the aperture thus made had effected an entrance.



# A. C. BARD & CO.

IMPORTERS AND  
CUTTERS OF

## DIAMONDS

Loose or mounted goods on memo. to responsible dealers.

103 STATE ST., CHICAGO. COLUMBUS MEMORIAL BUILDING.

# JOS. NOTERMAN & CO. DIAMONDS

IMPORTERS AND CUTTERS

Recutting and Repairing odd shaped and chipped stones a specialty. Manufacturers of Mountings and Fine Jewelry. Special Designs Furnished.

CINCINNATI, OHIO.



INDEX TO ADVERTISEMENTS.

dams & Singleton . . . . .	30	Freund, Henry, & Bro. . . . .	29	Noterman, Jos., & Co. . . . .	64
ikin, Lambert & Co. . . . .	103	Friedlander, R., L. & M. 14, Outside back cover		Novelty Engineering Ass'n . . . . .	96
Missopp & Missopp . . . . .	25	Garreau & Griser . . . . .	32	Ohau, G. . . . .	86
Missopp Bros. . . . .	20	Gesswein, F. W., Co. . . . .	96	Oppenheimer Bros. & Veith . . . . .	40
Olstertund, H. E., & Co. . . . .	32	Goldsmith, C. P., & Co. . . . .	26	Oppenheimer, H. E., & Co. . . . .	40
Olvin Mfg. Co. . . . . Inside front cover		Goldsmith, Leo. . . . .	50	Oriental Bank . . . . .	58
American Gem & Pearl Co. . . . .	52	Goodfriend Bros. . . . .	46	Osmun-Parker Mfg. Co. . . . .	22
American Platinum Works. . . . .	104	Gorham Mfg. Co. . . . .	54	Ostby & Barton Co. . . . .	21
American Silver Co. . . . .	33	Gougelman, Paul . . . . .	98	Patek, Philippe & Co. . . . .	85
American Waltham Watch Co. . . . .	78	Griffoni, August . . . . .	104	Potter & Bullinton Co. . . . .	31
Arch Crown Mfg. Co. . . . .	56	Guardian Trust Co. . . . .	58	Power, Chas. L., & Co. . . . .	46
Arnstein Bros. & Co. . . . . 34, Outside back cover		Hagstoz, T. B., Ltd. . . . .	104	Powers & Mayer . . . . .	15
Aschelm, Jules. . . . .	74	Harris & Harrington . . . . . Outside back cover		Prior, Charles M. . . . .	24
Austin, John, & Son. . . . . Outside back cover		Hedges, A. J., & Co. . . . .	22	Prybill, P. . . . .	103
Aztec Turquoise Co. . . . .	48	Hedges, Wm. S., & Co. . . . .	46	Pryor Novelty Co. . . . .	29
Bagg, Perline & Co. . . . .	48	Helutz Bros. . . . .	14	Rachne, Jules . . . . .	86
Baker, Geo. M. . . . . Outside back cover		Heller, L., & Son . . . . .	42	Reichhelm, E. P. & Co. . . . .	96
Bail, Webb C., Watch Co. . . . .	60	Hepers Bros. . . . .	104	Reuzelhausen, W. F., Co. . . . .	104
Bard, A. C., & Co. . . . .	64	Hirshberg, A. S. . . . .	44	Revell, A. H., & Co. . . . . Outside back cover	
Baschkopf, Jacob . . . . .	44	Hodenpyl & Walker . . . . .	42	Ries & Armstrong . . . . .	88
Bassett Jewelry Co. . . . .	25	Hoe's, James C., Sons. . . . .	92	Rockford Watch Co. . . . .	86
Bates & Bacon . . . . .	18	Hooper, H. J. . . . .	100	Roger Williams Silver Co. . . . .	27
Bealmear, H., & Co. . . . .	98	Hotel, St. James. . . . .	103	Roseman, A. . . . .	50
Berge, J. & H. . . . .	104	Howard, E., Clock Co. . . . .	86	Rosenfeld, Wnt. I. . . . .	52
Bergalke & Eckert Co. . . . .	74	Hraba, Louis W. . . . .	98	Rothschild Bros. & Co. . . . .	25
Bigney, S. O., & Co. . . . .	4	Humphrey, John B. . . . .	50	Roy Watch Case Co. . . . .	85
Billings, Chester, & Son. . . . .	44	Illhuols Watch Co. . . . .	8	Rudolph & Suedeker . . . . .	85
Bishop, R. W. . . . .	103	Jacot Music Box Co. . . . .	98	Rumpp, C. F., & Sons. . . . .	102
Blackinton, R., & Co. . . . .	13	Jeantheur, F., Jr. . . . .	104	Saart, W. H., Co. . . . .	32
Blackinton, W. & S., Co. . . . .	35	Jeanne, Frederick A. . . . .	50	Saunders, Meurer & Co. . . . .	46
Bancard & Co. . . . .	102	Jewelers' League . . . . .	72	Schiff, M. . . . .	25
Boote, Edward . . . . .	98	Johnston, W. L., Co. . . . . 10, 11		Schultz, Leiss & Co. . . . .	21
Borrelli & Vitelli . . . . .	46	Juergens & Andersen Co. . . . .	60	Sesslons Clock Co. . . . .	92
Bowden, J. B., & Co. . . . .	20	Juergensen, Jules . . . . .	85	Shafer & Douglas . . . . .	33
Bradley Polytechnic Institute . . . . .	28	Kahn, L. & M., & Co. . . . . Outside back cover		Shiman Bros. & Co. . . . .	62
Bretzner, R. . . . .	44	Keck, Herman, Mfg. Co. . . . .	60	Siegel, Rothschild & Co. . . . .	100
Brower, Maurice . . . . .	72	Keut & Woodland . . . . .	23	Simmons, R. F., Co. . . . .	17
Brubl Bros. & Henlus Co. . . . . Outside back cover		Ketcham & McDougall . . . . .	102	Smith, Alfred H., & Co. . . . .	40
Buckley, Sam'l, & Co. . . . .	92	Klipper Bros. . . . .	86	Smith, E. H. H., Silver Co. . . . .	100
Bunde & Upmeyer Co. . . . .	34	Kohlbusch, Herman, Sr. . . . .	104	Smith, Wm., & Co. . . . .	30
Buhoone, Geo. H., Co. . . . .	31	Kohn, Alois, & Co. . . . .	25	Snow & Westcott . . . . .	24
Burrington & Co. . . . .	22	Kohn & Co. . . . .	27	Sohn & Hyman . . . . .	52
Butler, Howe & Co. . . . .	23	Koshland & Italie Co. . . . .	88	Solidarity Watch Case Co. . . . .	28
Castiglioni & Capaldi Co. . . . .	76	Kreumentz & Co. . . . .	26	Spencer, E. L., Co. . . . .	30
Catham National Bank . . . . .	58	Kuehl, Geo., & Co. . . . .	88	Sprague Law School . . . . .	103
Chopard Freres . . . . .	76	Lackuer & Ohl . . . . .	72	State Bank . . . . .	58
"Cloverette" . . . . .	16	Langendorf Watch Co. . . . .	85	Steiner, Louis . . . . .	98
Columbia Jewelry Supply Co. . . . .	102	Larter & Sons . . . . .	38	Stern Bros. & Co. . . . . 50; Inside back cover	
Conley & Straight . . . . .	104	Lederer, S. & B., Co. . . . . 28,		Sternau, S., & Co. . . . .	16
Cooper Diamond Co. . . . .	44	Lelmann Bros. . . . .	96	Stiven, John S. . . . .	104
Cottle, S., Co. . . . .	24	Lelong, L., & Bro. . . . . Outside back cover		St. Louis Silver Co. . . . .	92
Crohn, M. . . . .	29	Levy, L. W., & Co. . . . .	100	Strauss, Ignaz, & Co. . . . . Outside back cover	
Cross & Bequellm . . . . . 28,		Levy, Robert . . . . .	19	Strauss, Jacob, & Sons. . . . .	52
Crossman Co. . . . .	48	Lewy & Coheu . . . . .	24	Street, Geo. O., & Sons. . . . .	20
Crouch & Fitzgerald . . . . .	32	Lissauer & Co. . . . .	42	Tavannes Watch Co. . . . .	76
Cattelbaum & Friedman . . . . .	100	Loeb, Wm., & Co. . . . .	72	Thomas, Seth, Clock Co. . . . .	89
Day, Clark & Co. . . . .	23	Lorsch, Albert, & Co. . . . . Outside back cover		Tivoli Art Glass Co. . . . .	100
Decker's Sons, James H. . . . .	104	Loth, Joseph, & Co. . . . .	30	Trenton Watch Co. . . . .	89
DePasse Mfg. Co. . . . .	22	Low, Martin, & Tauszig . . . . .	42	Trout, Charles L., & Co. . . . .	22
De Selms Watch School . . . . .	86	Lowe, Edwin, & Co., Inc. . . . .	29	U. S. Electro-Chemical Co. . . . .	96
Diamond Point Pen Co. . . . .	102	Luthy & Hine . . . . .	24	Van Dam, Eduard . . . . .	44
Oldsbelt, Hipp., & Bro. . . . .	86	Lyons Gem Co. . . . .	33	Wadsworth Watch Case Co. . . . . 6,	
Donnelly, J. J. . . . .	104	Maebert & Reiss . . . . .	86	Wagner Mfg. Co. . . . .	28
Dorflinger, C., & Sons. . . . .	98	Maple City Glass Co. . . . .	98	Waite-Thresher Co. . . . .	30
Dubois Watch Case Co. . . . .	89	Market & Fulton National Bank. . . . .	58	Washburn, C. Irving . . . . .	76
Dulk, Robt. . . . .	20	Mead, M. A., & Co. . . . .	84	Wells, Chester H. . . . .	22
Dunbar, Leach, Garner Co. . . . .	96	Mendes Cutting Factories . . . . .	92	Wendell & Co. . . . .	5
Durand & Co. . . . .	22	Mercantile National Bank . . . . .	59	Western Clock Co. . . . .	33
Eichberg & Co. . . . .	50	Meyerowitz Bros. . . . .	69	Wheeler, Hayden W., & Co. . . . .	40
Elgin National Watch Co. . . . .	80	Miller, Fuller & Whiting . . . . .	32	Whiteside & Blank . . . . .	23
Eliassof Bros. & Co. . . . .	69	Moore & Sons. . . . .	20	Whiting & Davis . . . . .	18
E. P. H. Chain Catch . . . . .	26	Mount & Woodhull . . . . .	48	Whiting Mfg. Co. . . . .	9
Fabys, Joseph, & Co. . . . .	1	Myers, S. F., Co. . . . .	32	Wightman & Hough Co. . . . .	31
Fairebild & Co. . . . .	102	Nebeling, Edmund R. . . . .	32	Witsenhausen, L. . . . .	26
Favre-Jacot, Georges, & Co. . . . .	87	Newburgh, R. . . . .	85	Wodiska, Julius . . . . .	27
Feeley, W. J., Co. . . . .	24	New England Watch Co. . . . .	82	Wolfsheim & Sachs. . . . .	103
Forman Co. . . . .	95	New York Central Railroad. . . . .	89	Wood, C. F., & Co. . . . . Outside back cover	
Forsinger, J. W. . . . .	87	New York Telephone Co. . . . .	103	Wood, J. R., & Sons. . . . . 2, 3	
Foster, Theodore W., & Bro. Co. . . . .	36	Noel, Rudolph, & Co. . . . .	60	Woodside Sterling Co. . . . .	12
Fox, Gustave, Co. . . . .	19	Nonnenmann, A., & J. Aschenbrenner . . . . .	92		

Eliassof Bros. & Co.

IMPORTERS  
AND  
JOBBER'S OF

**DIAMONDS  
WATCHES  
JEWELRY**

9-11-13 MAIDEN LANE,  
NEW YORK.

100 STATE STREET,  
ALBANY, N.Y.



A LARGE ASSORTMENT OF DIAMOND MOUNTED JEWELRY CARRIED IN STOCK.

MEYEROWITZ BROS.,

DIAMONDS,

IMPORTERS OF
37-39 MAIDEN LANE,  
NEW YORK CITY

A Complete Line of Precious, Semi-Precious and Imitation Stones. Mail orders promptly attended to.

## Special Notices.

### Situations Wanted.

EXPERT in diamonds wishes a position as buyer or salesman; best reference. "Diamonds, 6871," care Jewelers' Circular-Weekly.

YOUNG MAN, 23 years, wishes position as salesman or to work inside in wholesale house. "J., 6863," care Jewelers' Circular-Weekly.

SALESMAN acquainted with retail jewelers; New York City and vicinity; open for a position. "N., 6857," care Jewelers' Circular-Weekly.

POSITION WANTED as first class gilder; 15 years' experience; can furnish best of reference. "Gilder, 6866," care Jewelers' Circular-Weekly.

WANTED, by A1 engraver, position at once; can do some jewelry repairing; samples and references. Address "G., 6809," care Jewelers' Circular-Weekly.

WANTED, POSITION, through July and August, by good jeweler and engraver; young man; best references from former employers. D. F. Dodd, Shelton, Conn.

ENGRAVER wants position in New York City or within 50 miles of the city for Saturday afternoons and evenings. Walter Hohl, 407 E. 122d St., New York.

SITUATION WANTED by a good all around watchmaker and plain engraver; good set of tools; good references. "Jeweler," 528 Jackson St., Sandusky, O.

WATCHMAKER AND ENGRAVER; long experience; fast, accurate; has tools; come at once; state salary and hours. "Watchmaker," 143 Grand St., Albany, N. Y.

WANTED, by young married man of good habits, permanent position as watchmaker, in south; 10 years' experience. "Watchmaker, 6874," care Jewelers' Circular-Weekly.

SALESMAN (26), who has traveled through New York, Pennsylvania and Ohio, desires position with manufacturer or jobber. "J., 6798," care Jewelers' Circular-Weekly.

WANTED, A POSITION as engraver, book-keeper, cashier and saleslady; good references; terms reasonable. Address "Enquirer, 5877," care Jewelers' Circular-Weekly.

SALESMAN, with eight years' experience, selling department and jewelry stores in east and middle west, is open for a position. "Successful, 6659," care Jewelers' Circular-Weekly.

A YOUNG MAN, having three years' experience in the jewelry line, desires a permanent position. Address "Unquestionable References, 6809," care Jewelers' Circular-Weekly.

WATCHMAKER desires good position with high class jewelers; accustomed to waiting on trade; first class references; no engraving. "N. J., 6803," care Jewelers' Circular-Weekly.

BY FIRST CLASS manufacturing jeweler and diamond setter; 18 years' experience; have had charge of shop for last six years. Address "A. B., 6692," care Jewelers' Circular-Weekly.

YOUNG MAN (20), 10 years' experience as salesman, clock and jewelry repairer, desires position in retail store; good references. Address "Retail, 6846," care Jewelers' Circular-Weekly.

FIRST CLASS watchmaker, desiring to change, would like position at once; Massachusetts preferred; competent to handle railroad work. Address "E. H. B.," 45 Charles St., Springfield, Mass.

FOREMAN, designer and thoroughly experienced, practical jeweler; platinum diamond mountings especially; can do all kinds of alloying. Address "Foreman, 6840," care Jewelers' Circular-Weekly.

BY YOUNG MAN (23), as assistant watchmaker and plain engraver, with chance to advance in watch work; knowledge of optics; owns all tools. Address "O., 6836," care Jewelers' Circular-Weekly.

A STRICTLY first class watchmaker, salesman and optician desires to make a change; New York or vicinity; good appearance; best of references. "American, 6812," care Jewelers' Circular-Weekly.

ENGRAVER, young man, desires position to finish trade; good letterer on flat ware, also have some knowledge of script copper plate engraving, samples on request. "Script, 6804," care Jewelers' Circular-Weekly.

YOUNG MAN, 22 years old, with four years' experience in retail store, wants position as second watchmaker and engraver; can do clock and jewelry repairing. Address "M., 6815," care Jewelers' Circular-Weekly.

WATCH and clock repairer; young man; good on all makes of clocks and plain watch work; seeks opportunity for improvement with an expert watchmaker; moderate wages. Address "Good, 6820," care Jewelers' Circular-Weekly.

FIRST CLASS watchmaker wants permanent position with reliable house; competent to take full charge; large experience on fine and complicated work; fine tools and best of references. Address "Time, 6712," care Jewelers' Circular-Weekly.

YOUNG LADY, seven years' experience with large manufacturing and diamond house, desires position; thoroughly conversant in all its branches; capable of taking full charge of office. "Capable, 6632," care Jewelers' Circular-Weekly.

WATCHMAKER, engraver and salesman; capable to take charge; familiar with complicated work and finer adjustments; has had charge of departments in leading city houses; best references. "C., 6829," care Jewelers' Circular-Weekly.

PERMANENT POSITION wanted by an expert, first class watchmaker; thoroughly competent on all grades of watch and clock work; single; own full set of tools; well recommended. Address "Permanent, 6700," care Jewelers' Circular-Weekly.

YOUNG MAN (20), first class letter and monogram engraver, desires position in large retail store in the middle northern States, where he can learn jewelry and watchwork; reference given. Address "Ohio, 6847," care Jewelers' Circular-Weekly.

WATCHMAKER, competent to take full charge, desires position Aug. 1; 15 years' experience; prefer railroad work; accustomed to taking in and delivering work; references from former employers. Address "W., 6876," care Jewelers' Circular-Weekly.

A WATCHMAKER of recognized ability; trained in London; 15 years' American experience; seeks position in first class firm as fine watchmaker and adjuster; highest references; have also New York optical diploma. "H. G., 6794," care Jewelers' Circular-Weekly.

POSITION wanted with reliable firm in California, by first class watchmaker, 25 years' experience on fine, complicated and railroad watches; take in, deliver and give estimates on work; have also some knowledge of optical work. "Cal., 6837," care Jewelers' Circular-Weekly.

FIRST CLASS jeweler and engraver wants position; can do all kinds of jewelry repairing, stone setting, letter and monogram engraving, make pierced monograms; own all tools; sober; Philadelphia, Baltimore, Washington or vicinity; inquiries answered. "L. A. S., 6782," care Jewelers' Circular-Weekly.

COMPETENT WATCHMAKER on high grade and complicated work; good jeweler and plain engraver; 18 years' experience; steady and reliable; capable of taking entire charge; good salesman; best references; desires good position; salary \$18 to \$20 per week. Address "Thomas, 6869," care Jewelers' Circular-Weekly.

AD. MAN and A1 correspondent desires position with jewelry or silverware concern (wholesale or retail); highest endorsements as to business ability, character, etc.; can show specimens from ad. campaign which "delivered the goods" and secured many new customers; salary, \$1,500. "Business, 6850," care Jewelers' Circular-Weekly.

### Side Lines Wanted.

WANTED, a side line of rings for Indian Territory and Oklahoma. Address S. W. Eckley, 921 S. Adams St., Peoria, Ill.

WANTED, AT ONCE, one or two first class manufacturer's lines on commission or salary; New York City or traveling. "S. W., 6801," care Jewelers' Circular-Weekly.

TRAVELING SALESMAN; south and southwestern territory; long established trade; desires a first class line of sterling flat ware and hollow ware, before July 27. "Successful, 6862," care Jewelers' Circular-Weekly.

TRAVELING diamond merchant, with years of experience west of Mississippi, and A1 references, wishes sample lines from capable manufacturers of mountings and kindred goods. Address S. H. F., care S. Cohn & Co., 9 Maiden Lane, New York.

### Help Wanted.

JEWELER WANTED. Apply 9 Province Ct., on flight up, Boston, Mass.

WANTED, good watchmaker and engraver; will pay \$25 per week. "Good, 6831," care Jewelers' Circular-Weekly.

WANTED, optician and engraver, with some knowledge of jewelry repairing. Sylvan Bros., Columbus, S. C.

WANTED, a first class jeweler for small town in Pennsylvania. Address "L. B., 6797," care Jewelers' Circular-Weekly.

AT ONCE, watchmaker and engraver; permanent position to a good man. "M., 6849," care Jewelers' Circular-Weekly.

WANTED, two first class jewelry and silverware salesmen, for retail trade. Apply to Dubme Jewelry Co., Cincinnati, O.

WANTED, clock and jewelry repairer; pleasant and permanent position, at good wages. J. D. Taylor, Logansport, Ind.

WANTED, LAPIDARY, a good polisher on face work; steady work, good wages. Garreaud & Griser, 68 Nassau St., New York.

WANTED, experienced salesman for establishment of cut glass in New England and Middle West. Address Box 774 J., Corning, N. Y.

SETTER WANTED, permanent position; give references, experience, age and salary in first letter. M. E. Nabstedt & Sons Co., Davenport, Ia.

ENGRAVER, also able to assist watchmaker as second man; bring references and sample of engraving. Edw. H. Huftnagel, Mount Vernon, N. Y.

WANTED, watchmaker and optician; permanent position for a competent man; state salary and reference. Louis Kades, 33 Water St., Newburg, N. Y.

WANTED, a good watchmaker who can engrave good position for a first class man; address with references. Sylvester Engle, 16 West Broad St. Hazleton, Pa.

WANTED, diamond mounters and setters, also jobbing jewelers; permanent positions, good wages. E. Maritz Jewelry Mfg. Co., 217 N. 6th St., St. Louis, Mo.

WANTED, second watchmaker and repair man salary, \$15 per week; steady position; send photograph and reference. Address Box 890 Charleston, W. Va.

DESIGNER, one experienced in silver business on hollow ware; state experience, salary expected, etc. T. F. Tuttle Silver Co., 387 Washington St., Boston, Mass.

SALESMAN WANTED to handle an up-to-date line of jewelry and silverware cases, as a side line on commission basis. "Line, 6839," care Jewelers' Circular-Weekly.

WANTED, AT ONCE, first class watchmaker, optician and engraver; American preferred, good salary; permanent position. Address Cap-Ilohtsen Jewelry Co., Tucson, Ariz.

WANTED, by jobbing house, carrying first class stock, salesman for south, having established trade; must be good man. Address "C., 6843," care Jewelers' Circular-Weekly.

WANTED, a first class watchmaker, jeweler, engraver and optician; permanent position at \$3 a week; only first class men need apply. M. Hammerslough, Anaconda, Mont.

WANTED, experienced traveler to represent American watch house in Pennsylvania and New York States; address in confidence. "Watch, 6825," care Jewelers' Circular-Weekly.

MATERIAL and tool salesman wanted; a man of experience as inside salesman; address, stating experience and giving reference. Charles May, Son, 403 Washington St., Boston, Mass.

WANTED, young man with five or six years' experience in manufacturing jewelry shop; must be good jobber and be able to do some new work. Address E. C. Harpstrite, Wichita, Kans.

WANTED, jeweler, engraver and assistant watchmaker, capable to wait on trade; must be well recommended; steady position for the right man. Address Jesse Davidson, Montgomery, Ala.

WANTED, WATCHMAKER, must be good sale man; experienced; salary based upon ability. Jules Asheim, 37 Maiden Lane, New York; or Southern Loan and Jewelry Co., Tampa, Fla.

**HELP WANTED.—Continued.**

ANTED, good combination watchmaker, engraver and salesman; wages \$22 weekly; permanent; hours, 8 to 6; all particulars and references in first letter. T. W. Morrison, Newburgh, N. Y.

ANTED, first class engraver and jewelry repairer, city in Connecticut; one who is good in both branches; good position and salary to right party. "Ability, 6852," care Jewelers' Circular-Weekly.

ANTED, SALESMAN, with experience to sell department and jewelry stores in the southern states; a good position for the right man. Address "Southern, 6835," care Jewelers' Circular-Weekly.

ANTED, good combination watchmaker, engraver and jewelry repairer, for southern Florida; state references, salary expected, etc. Address "Florida, 6806," care Jewelers' Circular-Weekly.

ANTED, good engraver who can do fine monogram, old English and script lettering; good salary; permanent job; young man preferred. C. Abbott & Bro., 1905 Second Ave., Birmingham, Ala.

ANTED, first class watchmaker of good address, who can assist as salesman; New York experience; permanent position to right man; reference required. "New York, 6865," care Jewelers' Circular-Weekly.

ANTED, CLOCKMAKER, who is also an experienced letter and monogram engraver; send samples of engraving with references; and state salary wanted. "Samples, 6832," care Jewelers' Circular-Weekly.

ANTED, SALESMAN for New York City, by manufacturing concern; one with experience in the city and vicinity; state full particulars and references. "Diamond, 6816," care Jewelers' Circular-Weekly.

ANTED, good watchmaker; must be capable of doing ordinary engraving and waiting on trade; permanent position to right man; good salary. Address Krauss & Sectors, 45 N. Illinois St., Indianapolis, Ind.

ANTED, AT ONCE, a good watchmaker and engraver, or a good jeweler and engraver; permanent position; good salary; references required; send sample of engraving. E. F. Jake-man, Norfolk, Va.

ANTED, WATCHMAKERS to go south to a large city and with the largest and most prominent jeweler; first class treatment to the right parties. Apply Ingomar Goldsmith & Co., 182 Broadway, New York.

ANTED, girls to lay out orders and make themselves generally useful in a wholesale jewelry house; only those with experience in the jewelry business need apply. Fred Kaufman & Co., 565 Broadway, New York.

ANTED, experienced watchmaker, engraver and salesman; send sample of engraving, reference, age and salary expected; steady position and short hours. Address "Indiana, 6821," care Jewelers' Circular-Weekly.

ANTED, watchmaker; must be first class and be able to do high grade work on railroad and high grade watches; state what salary required and give references. "R. R., 6824," care Jewelers' Circular-Weekly.

FIRST CLASS ENGRAVER; one who can do all kinds of lettering and monogram engraving; can use a good steady man at a good salary. Apply to A. Newsalt, Jeweler, cor. Fourth and Main Sts., Dayton, O.

HIGH GRADE watchmaker and engraver can secure a permanent position in a fine jewelry store, at \$25 to \$30 weekly, by addressing, with reference and sample of engraving in first letter, to Hahn, Durango, Colo.

FIRST CLASS watchmaker and optician wanted; good opportunity offered to right party; steady position; in one of the large cities in Pennsylvania; write at once. L. W. Rubenstein, 54 Maiden Lane, New York.

ANTED, a first class watchmaker and a good all around man for retail store, at once; first class job for good man; send reference; job will pay \$18 to \$20 per week to start. Meyer & Schamber, Meridian, Miss.

OUNG MAN, who thoroughly understands the repairing of French and American clocks; position permanent; wages, \$12 per week; chance for advancement; must come immediately. Jules Wendell & Son, Oswego, N. Y.

ANTED, SALESMAN for Chicago trade to sell jewelry and solicit special order and repair work; one familiar with manufacturing preferred. Address "Mfg., 6815," care Jewelers' Circular-Weekly, 103 State St., Chicago, Ill.

YOUNG LADY in office of large manufacturing jeweler; one with experience in diamond house preferred; good opportunity for right party; state full particulars and references. "Emerald, 6817," care Jewelers' Circular-Weekly.

FIRST CLASS watchmaker for American house, in New York. Address "Permanent, 6784," care Jewelers' Circular-Weekly.

JEWELRY REPAIRER and stone setter for American house, in New York. Address, "Permanent, 6785," care Jewelers' Circular-Weekly.

ANTED, two experienced young men, one as watchmaker; other as jeweler and clock repairer; those who can engrave preferred; state salary, experience and reference in first letter; steady position. A. Hawkins, 727 Eighth Ave., New York.

ANTED, a first class optician; one who understands edge grinding preferred; steady employment and good wages to the right man; must come well recommended. Address "Central Connecticut, 6840," care Jewelers' Circular-Weekly.

EXPERT WATCHMAKER wanted, at once; none but first class workmen need apply; must be reliable, steady and sober; send references and state salary. Address R. J. Satterthwait, 722 Kanawha St., Charleston, Kanawha Co., W. Virginia.

ANTED, AT ONCE, two first class men and one lady, one watchmaker, jeweler, engraver and optician; one engraver and salesman; also one saleslady and engraver; give full particulars in first letter. B. L. Gates, 809 Second Ave., Seattle, Wash.

RESPONSIBLE TRAVELERS to take our line, consisting of fine Elk and gold jewelry, southeast and New England, also large and small cities in the entire west, as a side line on a commission basis; state territory. Schicklering Mfg. Co., 31 W. 31st St., New York.

ANTED, WATCHMAKER for the shop only; who can do hard soldering and clock repairing; young or old man; no tools needed; town has 1,200 inhabitants; wages, from \$20 to \$35 per month with board, lodging and washing; difficult work sent out. F. C. Rivoire, Napolconville, La.

AT ONCE, experienced watchmaker and jeweler; one who can engrave; young married man preferred; must be reliable; state experience, salary, age and references; permanent position for the right man, with old established house; good town. Jno. W. Ruth & Sons, Shelbyville, Tenn.

ANTED, AT ONCE, a thorough, competent watchmaker, jeweler and diamond setter; one who can do some engraving preferred; must be sober and industrious; a permanent position to the right man; address, stating wages and references. W. T. Eisensmith, Box 358, Charleston, W. Va.

EXPERIENCED watchmaker and clock repairer; quick workman, for Washington, D. C.; fine French and chime clocks your special work; apply, stating years of experience and where, also age, and wages expected; life position to right man; hours, 8 to 6. "Box 6833," care Jewelers' Circular-Weekly.

M. J. AVERBECK, 19 Maiden Lane, New York, has a permanent position in office for salesman and office assistant; a high grade man with executive ability; do not answer this advertisement unless you have had previous experience; state experience, reference, age and salary expected; all communications strictly confidential.

SALESMAN for the south, wanted to carry our line in connection with one other good house on commission or half expenses and salary; our line is up-to-date; we want a reliable man for the best cities in the south. Edward Todd & Co., manufacturers, gold and silver novelties, pencils, fountain pens, etc., 1 W. 34th St., New York.

ANTED first class diamond and precious stone salesman, one who has experience with southern and western trade; excellent opportunity for a hustler; good salary and commission; answer by letter, stating experience, etc.; communications confidential. "C., 6690," care Jewelers' Circular-Weekly.

ANTED, strictly first class combination man (watchmaker, jeweler and engraver); must be sober and well recommended; good salary and permanent position to good man; must be a willing worker, rapid and very thorough; state salary expected and send sample engraving in first letter, Thos. Van Auker & Co., 516 Pearl St., Beaumont, Tex.

TWO MEN WANTED; we need two combination men to fill the following positions, jeweler, watchmaker, engraver, diamond setter and graduate optician; each applicant must be reliable and furnish references as to his ability to fill two or more of the above positions; state salary expected. Ignatius Fried, Jeweler and Diamond Expert, Mobile, Ala.

ANTED WATCHMAKER; Abraham & Straus, Brooklyn, can place in a permanent position at liberal salary a competent man who thoroughly understands watch repairing in all its details. Apply to Superintendent.

ANTED AN ARTIST with expert knowledge of enameling to take full charge of small plant, for special work in artistically designed enamelled jewelry and hollowware; address stating qualifications and particulars as to experience and ability; terms made satisfactory to right party. "W. E. T., 6724," care Jewelers' Circular-Weekly.

TRAVELING WATCH SALESMAN and watch inspector for one of the leading railroads in Mexico; must be practical man of experience, and well up in watches; single, good habits, best references and possessing ability to make friends and hold them; dealings with Americans, knowledge of Spanish unnecessary; Elgin and Waltham watches; good salary with excellent opportunity for advancement to right man; to travel in the best part of Mexico; climate unsurpassed, cool summers, warm winters; write fully in first letter, giving experience, age and references, with photo if possible. A. C. Smith, General Watch Inspector for the Railways of the Republic of Mexico. Apartado 2151, City of Mexico, Mexico.

**For Sale.**

FOR SALE, Geneva retinoscope; wired; adjustable base; chin rest, \$20. Oskamp Jewelry Co., Cincinnati, O.

FOR SALE, watchmakers' wire railing, \$4; spectacle signs, \$2.50; 6 ft. oak "silent salesman" show case, \$16.50; Seth Thomas oak regulator, \$14; all good as new; cash must accompany orders. J. F. Carr, Portsmouth, O.

AT 50 CENTS ON THE DOLLAR, a lot of bracelets, long chains, set tie pins, chateaine pins, hair barrettes, hatpins, scarfpins, necklaces; prices, 75 cents to \$3.75 dozen, less 10 per cent. for cash; goods were manufactured for a jobber who failed; selection packages sent to well rated jewelers. Dan I. Murray, Broker, 3 Maiden Lane, New York.

AT 25 per cent. to 40 per cent. less than regular price, a job lot of real amber necklaces, fine cut jet brooches, jewel necklaces, French pearl necklaces and cut crystal hat-pins, all of German and French manufacture; must be sold at once; price, \$1.25 per dozen up to \$60 dozen, less 5 per cent. 10 days, net 30 days; selection packages on memorandum to well rated dealers; any one lot if you want ambers and jets at cut prices; he quick or you will regret it. Dan I. Murray, Importer, Broker, 3 Maiden Lane, New York.

**To Let.**

DESK ROOM or part of office to let. 3 Maiden Lane, Room 53, New York.

TO LET, part of an exceptionally desirable office, with fine north light; opportunity for precious stone business or manufacturer's agent. Room 48, Lorsch Bldg., 37 Maiden Lane, New York.

(Special Notices continued on page 72.)

# The Jewelers' League of New York

12 JOHN STREET

Organized 1877

Reserve fund, January 1st, 1906 - \$304,408.78  
 Paid for deaths since organization - \$3,134,487.38

## Board of Officers, 1906

President,

GEORGE W. STREET.

Vice-Presidents,

M. J. LISSAUER.

BERNARD KARSCH,

JOHN R. GREASON,

O. G. FESSENDEN.

Secretary and Treasurer,

F. A. Marsellus, 12 John St.

Executive Committee.

Leo Wormser, A. K. Sloan, W. T. Gough, G. W. Mindil, G. H. Hodenpyl,  
 D. N. Smith.

Advisory Committee.

Samuel H. Levy, C. C. Offerman, W. E. Moutoux, Sr., L. Witsenhausen, J. B.  
 Wood, Wm. Barthman, S. B. Mann, T. L. Parker, O. M. Farrand,  
 G. W. Parks, F. L. Wood, S. A. Baldwin, R. A. Breidenbach,  
 H. Freund, E. B. Eaton, F. H. Dana, S. B. Kent,  
 Morris Lissauer.

Examining Finance Committee.

R. A. Breidenbach, Andrew McLeod, John R. Greason, Jr.

The new schedule of rates offers maximum insurance at  
 minimum cost—monthly paymen's make it convenient to carry.

Death benefits, \$1000.00 to \$5000.00  
 Age limit, 21 to 44 years, inclusive

This organization has never had occasion to contest any claim

## ORNAMENTAL HAT PIN HOLDERS

A Useful and Artistic Conceit in  
 SILVER DEPOSIT ON GLASS

that contributes greatly to  
 the appearance of any dresser

MADE IN A VARIETY OF HIGHLY ARTISTIC DESIGNS

Splendid sellers during the vacation period

### LACKNER & OHL

50 Columbia Street

NEWARK, N. J.

## RINGS

### WM. LOEB & CO.

101 Sabin St.,

Providence, R. I.

New York Office, 37 Maiden Lane.

## "PRACTICAL COURSE

IN

ADJUSTING."

PRICE \$2.50.

ALL JOBBERS OR

JEWELERS' CIRCULAR PUBLISHING CO.

## MAURICE BROWER

Largest Buyer and Seller of

## AMERICAN PEARLS

12-16 JOHN STREET

NEW YORK

## Special Notices.

(Continued from page 71.)

### Business Opportunities.

FOR SALE, old established jewelry business; ce-  
 tral New York; only store; town 1,000; s  
 fixtures; tools or part; write for particulars. A  
 dress "Established, 6873," care Jewelers' C  
 ular-Weekly.

FOR SALE, well equipped manufacturing jewel  
 shop, in rapidly growing western city of 40,000  
 good machinery; old established place; no co  
 petition. Address "F. G., 6860," care Jewel  
 Circular-Weekly.

CASH FOR WATCHES and diamonds:  
 send them at once and get you  
 money by return mail. Josep  
 Brown & Co., Fifth Ave. and Madiso  
 St., Chicago, Ill.

MAN, thoroughly experienced in the manufact  
 ing of jewelry for the wholesale or retail tra  
 artistic designer and modeler, for the cutting  
 steel dies by machine; owner of a patent fo  
 making of ornamented seamless bracelets a  
 rings, hollow or solid, in plate or solid g  
 wants a partner with capital to start a pla  
 which is not only promising but cannot fail  
 be successful. Address "Partner, 6830," ca  
 Jewelers' Circular-Weekly.

A COMPLETE up-to-date plant for ma  
 nufacturing silverware, metal goo  
 and clocks is offered at great sacri  
 fice; power and hydraulic presse  
 drop hammers, lathes, moulds, etc  
 must sell to close estate. Less  
 Bros., attorneys, 299 Broadway, Ne  
 York.

DO YOU WISH TO RETIRE? We bu  
 jewelry stores to any amount; al  
 entire stocks of jewelry, diamond  
 watches, silverware, fixtures, etc.; v  
 are known all over the United Stat  
 to pay highest spot cash; not  
 us, we will call on you at once; a  
 business transacted we handle stric  
 ly confidential. Address Brookly  
 Purchasing Syndicate, 608 Broadwa  
 Brooklyn, N. Y., or Tel. 2328, W  
 llamsburg.

### Wanted to Purchase.

WANTED, jewelers' safe, roll top bench, re  
 lator clock, counters, cases, etc., cheap, for ca  
 "Roberts, 6844," care Jewelers' Circular-Weekl

ANTIQUY JEWELRY WANTED; we are alwa  
 ready to make cash offers on any antique je  
 elry containing mosaics, cameos, seed pearls, et  
 also filigree, enameled or etruscan jewel  
 either all gold or set with diamonds or ot  
 stones. Chas. S. Crossman & Co., The "C  
 Mine" Diamond House, established 1880,  
 Maiden Lane, New York.

### Wanted to Rent.

BENCH ROOM WANTED by setter. L. Leight  
 Room 120a, 12th floor, 51 Maiden Lane, N  
 York.

### Lost.

WANTED, INFORMATION, leading to locati  
 of open face Elgin, gold watch, monogram  
 L. T. on back; probably left for repairs abo  
 November, 1905. J. F. Newman, 11 John S  
 New York.

### TO LET.

#### Three Desirable Light Loft

At 31 MAIDEN LANE, N. Y.,

One door from Nassau St. Prominent locati  
 center of jewelry district. Address F. J. Whit  
 130 Broadway, New York; or, your own broker.

# PATENT DEPARTMENT



IN WHICH IS CONTAINED A LIST OF THE LATEST PATENTS GRANTED BY THE UNITED STATES AND GREAT BRITAIN, THE UNITED STATES PATENTS THAT HAVE EXPIRED AND THE REGISTERED TRADE-MARKS.

## UNITED STATES PATENTS.

ISSUE OF JUNE 26, 1906.

**824,148. POCKET-KNIFE.** ALBERT S. ROBERTS, Hillsboro, Ill. Filed Aug. 31, 1905. Serial No. 276,566.

A knife comprising a handle formed with a pair of spaced longitudinal sides united at their ends, a back-spring disposed within the space between the sides of the handle and having rigid connection with said sides, blades pivotally mounted be-

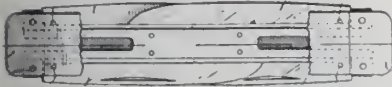

tween the sides of the handle and occupying the same longitudinal plane as said back-spring, said back-spring comprising a body having bifurcated ends, the furcations serving as spring-fingers and being in the same plane with one another and with said blades, said blades engaging said spring-fingers when in their open position and forcing said fingers toward the longitudinal axis of said back-spring.

**824,205. INTERMITTENT-ALARM CLOCK.** WILSON E. PORTER, New Haven, Conn., assignor to the New Haven Clock Co., New Haven, Conn. Filed Jan. 8, 1906. Serial No. 295,065.

In an intermittent-alarm clock, the combination with the time and alarm trains thereof, of an

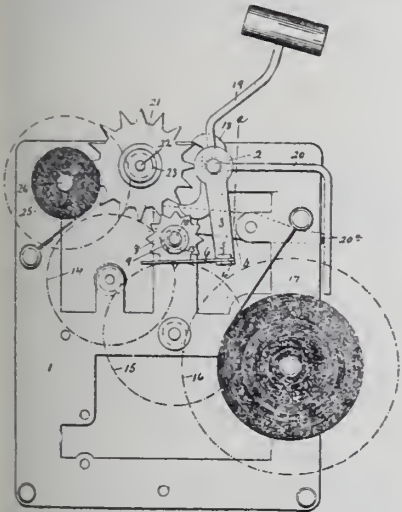

alarm-wheel driven by the time-train, and a vibrating spring connected with the alarm-train and engaging with the teeth of the said wheel which it tends to revolve in the direction in which the wheel is revolved by the time-train.

**824,220. LENS-DRILLING MACHINE.** EDGAR T. WAITE, Southbridge, Mass., assignor to

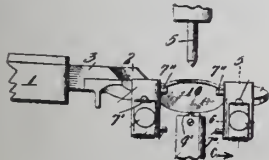

In a lens-drilling machine, the combination with lens-holding jaws or supports, of plates attached to said jaws, and having pins or projections thereon for one end of a lens, said pins extending in two different horizontal planes, and means for holding said plates on said jaws.

**824,262. ELECTRIC TIME-SIGNAL.** JOHN M. POWELL, Portecasi, N. C. Filed Aug. 31, 1905. Serial No. 276,583.

In combination with a time mechanism having an alarm apparatus, a key to wind the alarm apparatus and having a drum free to rotate thereon,

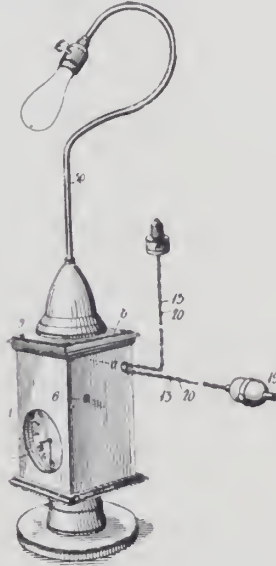

said key being further provided with means to lock the drum thereto; an electric switch, and a flexible element to operate said switch, said flexible element being connected to said drum.

**824,309. SLIDE-BRACELET.** EDWARD F. PRESBRY, Providence, R. I., assignor to Hamilton & Hamilton, Jr., Providence, R. I. Filed April 18, 1905. Serial No. 256,310.

In a slide-bracelet, the combination of the hollow members of the bracelet, with the flexible slide-strips, each secured at its outer end to the end of a bracelet member, and provided at its opposite



inner end with the struck-up engaging depression, and with the struck-up elevation, with the curved guides, secured within the cavity of the bracelet member, and each provided with a struck-up elevation, adapted to engage with the depression of the guided flexible slide-strip, and also provided with the slot adapted to receive the stop elevation which serves to limit the outward and inward movement of the flexible slide strip.

**824,379. BRACELET.** EDGAR A. PHILLIPS, Providence, R. I., assignor to Hamilton & Hamilton, Jr., Providence, R. I. Filed Feb. 5, 1906. Serial No. 299,598.

In a bracelet, a pair of rigid tubular members, a

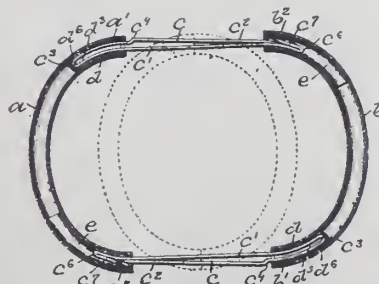

flexible connecting-link *c* to telescope into said members consisting of a strip of thin metal shaped

to form a comparatively wide body portion *c*<sup>1</sup> from one end of which extends a long narrow spring-tongue *c*<sup>2</sup> bent over the body portion *c*<sup>1</sup> forming a looped end *c*<sup>3</sup> and having a bend *c*<sup>4</sup> forming a snap member adjacent the looped end *c*<sup>3</sup> and a beveled end *c*<sup>5</sup>, a short spring-tongue *c*<sup>7</sup> on the end *c*<sup>6</sup> of the body portion *c*<sup>1</sup> having a beveled end *c*<sup>8</sup> and bent over the body portion into a position to lap over the beveled end *c*<sup>5</sup> on the long tongue *c*<sup>2</sup>.

**824,466. WATCH-REGULATOR.** JOSEPH BRUN, Chaux-de-Fonds, Switzerland. Filed April 18, 1904. Serial No. 203,822.

A balance including an arbor and a spring, a stud to which the end of the spring is attached, in-

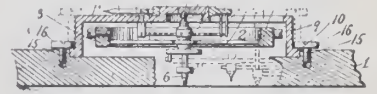

closing means for the balance, said means serving as a bearing for said arbor and also as an adjustable support for said stud.

**824,525. LEVELING DEVICE FOR CLOCKS AND SIMILAR INSTRUMENTS.** OSCAR L. BONNEY, Denver, Colo. Filed Sept. 5, 1905. Serial No. 276,935.

The combination with the base of a clock or similar instrument, of a nut embedded in the base in a manner to prevent rotation, a screw threaded in the nut and protruding both above and below the

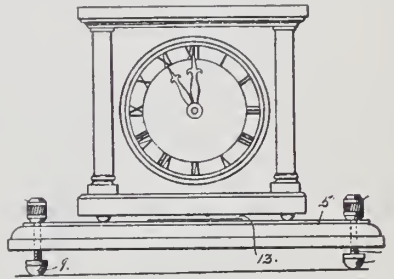

base, and a key having an unthreaded opening, applied to the upper threaded extremity of the screw and slidable freely on the threaded portion thereof, but connected therewith to cause the two parts to rotate in unison, the threaded portion of the screw extending above the clock-base and the key being located at all times entirely above the said base.

**824,537. CLOCK.** ALBERT D. GARY, Lavonia, Ga., assignor of one-half to Henry Hoyt Chandler, Lavonia, Ga. Filed June 29, 1905. Serial No. 267,540.

The combination with the clock-train having an escapement shaft and wheel, of a plate having a laterally-extending arm, a pallet for engaging the

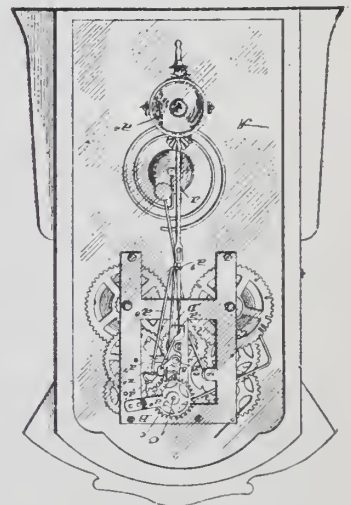

escapement-wheel mounted on the arm, a pendulum mounted to swing upon the plate, a connection between the pallet and the pendulum, said plate being provided with a bearing for engaging the escapement-shaft and a slot leading therefrom to permit removal and attachment of the plate, and a



## Bigalke & Eckert Co.

IMPORTERS OF WATCHES,

No. 1 MAIDEN LANE, NEW YORK

Single and Split Second Timers in Nickel and Gun Metal Cases.

Complete Assortment of Chronographs,  
Split Seconds and Minute Repeaters.

Ladies' and Gentlemen's Flat and Ultra Flat Watches.

SOLE AGENTS FOR

**Maas, Neveux & Cie.**

FINE GENEVA WATCHES.



# COMBS and BRACELETS

WILL BE THE LEADING SELLERS THIS FALL



Those here shown are but a few of our complete line in both Gold and Filled. There is not a poor seller in our stock. Our line of

**Gold and Diamond Rings and Jewelry, Gold and Filled Chains, Festoons, etc.**

is more complete than ever before. A card to us will bring our representative to you when in your vicinity.

*Selection packages sent on request*

**JULES ASCHEIM**

37 Maiden Lane, New York



rod secured to the plate and extending therebelow whereby to swing the plate.

**824,598.** WAIST BELT. WALTER C. SPITTLE. Olton, England. Filed Dec. 12, 1905. Serial No. 294,496.

An expanding and self-adjusting waist-belt consisting of an endless band made up of an elastic or distensible portion and a longer inelastic portion whose returned extremities are attached re-



spectively to the ends of the said elastic portion, a pair of loops or runner-fittings wherethrough the returned ends of the inelastic portion are passed, and clasp or fastener fittings connected to the said loops

**824,617.** EYEGLASSES. EUGENE C. BERNHEIM Newark, N. J. Filed Feb. 18, 1904. Renewed March 8, 1906. Serial No. 304,901.

An eyeglass consisting of the lenses, the nose-guards having the horizontal portions arranged on one side of the lens, the bow or bridge spring having the horizontal portions arranged on the other



side of the lens, the intermediate bearing-plates, means for connecting the nose-guards and bearing-plates and for securing the nose-guards and spring to the lenses, said bow or bridge spring being formed with coils or spring-loops of thinner material than the body of the spring.

**824,618.** ALLOY. CHARLES H. BIRMINGHAM, Baltimore, Md. Filed March 13, 1906. Serial No. 305,826.

An alloy composed of silver, nickel, bismuth and gold.

DESIGNS.

**38,103.** HANDLE FOR SPOONS, FORKS OR SIMILAR ARTICLES. HENRY W. HIRSCHFELD. Meriden, Conn., assignor to the Inter-



national Silver Co., Meriden, Conn. Filed May 18, 1906. Serial No. 317,642. Term of patent 7 years.

The ornamental design for a handle for a spoon, fork or similar article, as shown.

**38,104.** PLATE. HERMANN EHRLICH, Fürth, Germany, assignor to the Ceramic Transfer Co.,

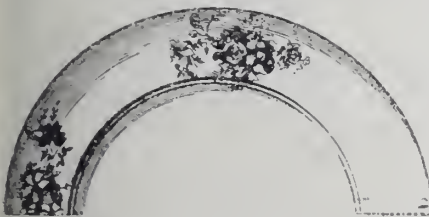

New York. Filed May 2, 1906. Serial No. 314,902. Term of patent 3 1/2 years.

UNITED STATES PATENTS THAT HAVE EXPIRED.

[Reported especially for THE JEWELERS' CIRCULAR—WEEKLY by R. W. Bishop, Patent Attorney, Washington, D. C.]

Issued July 2, 1889.

**406,021.** CLASP. J. H. BLEY, New York.

**406,070.** HANDLE FOR TEA OR COFFEE POTS. GEORGE VOGL and JOHN HESS, New York, assignors of one-third to A. H. Fisher, Jersey City, N. J.

**406,217.** OPERA-GLASS HOLDER. GIDEON ISLEY, Jersey City, N. J., assignor to Edwin Terry, Brooklyn, N. Y., and Leo Wormser, New York.

**406,238.** JUG-COVER. S. J. SCOTT, Cincinnati, O.

**406,240.** BELT-CLASP. G. E. ZELTMACHER, Brooklyn, N. Y.

**406,307.** HAND-SETTING MECHANISM. F. J. ROUX, Geneva, Switzerland, assignor to Ancienne Fabrique Vacheron & Constantin (Ltd.), same place.

**406,340.** PINCUSHION. W. O. DAY, Seneca Falls, N. Y.

**406,356.** SPLIT CHUCK FOR W. H. MAKER'S LATHEES. FREDERICK LAUTER MILCH, Kirkwood, Mo., assignor of one-half to Edward Wilmas, same place.

**406,364.** ANTI-MAGNETIC WATCH. C. I. MASON, Sumter, S. C., assignor to the American Waltham Watch Co., Waltham, Mass.

**406,371.** SAFETY-PIN. EDWARD MCCONNELL, Cape Girardeau, Mo.

**406,375.** FOUNTAIN-PEN. CHRISTOPHER STOCKMAN Brooklyn, N. Y. Designs issued July 4, 1899, for 7 years.

**34,116.** SPOON HANDLE. A. G. ROGERS, Meriden, Conn., assignor to C. Rogers & Bros., same place.

**34,119.** NAIL-FILE. EMIL FORQUIGNON, New York.

**34,120.** PUFF-BOX COVER. T. W. FOSTER Providence, R. I.

**34,121.** BRUSH-BACK. T. W. FOSTER Providence, R. I.

Designs issued Dec. 30, 1902, for 3 1/2 years.

**36,180.** PURSE. EMMA A. SYLVESTER Boston, Mass.

**36,185.** LAMP-SHADE. R. D. CHANDLER, Hyde Park, Mass.

UNITED STATES TRADE-MARKS.

[The following trade-marks have been adjudged entitled to registration under the Act of Feb. 20, 1905, and are published by the Patent Office in compliance with Sec. 6, of said act, which provides: "Any person who believes he would be damaged by the registration of a mark may oppose the same by filing notice of opposition, stating the grounds therefor, in the Patent Office, within 30 days after the publication of the mark sought to be registered, which said notice of opposition shall be verified by the person filing the same before one of the officers mentioned in Sec. 2, of this act. If no notice of opposition is filed within said time the Commissioner shall issue a certificate of registration therefor, as hereinafter provided for."]

PUBLISHED JUNE 26, 1906

SER. NO. 1,755. SILVER TABLE WARE, HOLLOW WARE AND FLAT WARE. ALVIN MFG. CO., New York. Filed April 15, 1905.



A central shield bearing the letter A, and to one side of which is a circular frame inclosing a bar and crescent, and to the other side of which is a circular frame inclosing or surrounding the head and feathered neck of a bird.

SER. NO. 10,453. SCARF-PINS, STICK-PINS, BROOCHES, BRACELETS, CHAINS, CHARMS AND SLEEVE AND SHIRT BUTTONS. PLAINVILLE STOCK CO., Plainville, Mass. Filed July 17, 1905.



The letters P S Co.'

SER. NO. 14,800. SILVER AND SILVER-PLATED SPOONS, KNIVES AND FORKS AND SPOONS, KNIVES AND FORKS

CUEVEE

MADE OF METAL COMMERCIALY KNOWN IN THE ART OF TABLE WARE

MAKING AS "WHITE METAL." QUAKER VALLEY MFG. Co., Chicago. Filed Nov. 18, 1905.

The word "CUEVEE."

SER. NO. 17,373. CLOCKS AND WATCHES. THE WESTERN CLOCK MFG. Co., La Salle, Ill. Filed Feb. 26, 1906.



The letter W partially formed by the hands of a clock, and the representation of a clock, all inclosed in a diamond-shaped figure.

SER. NO. 18,186. EYEWATER. FRANK MOSMAN JONES, Lockport, N. Y. Filed March 23, 1906.



The words "BLIND MAN'S FRIEND," and the representation of a youth leading a blind older person.

SER. NO. 19,183. WATCHES, WATCH CASES AND WATCH MOVEMENTS. THE KEYSTONE WATCH CASE Co., Philadelphia, Pa. Filed April 30, 1906.



The word "CARMEN."

TRADE-MARKS REGISTERED JUNE 26, 1906.

54,334. PLATED SILVERWARE. GORHAM MFG. Co., Providence, R. I.

The word "GORHAM." Used 10 years. Filed Nov. 15, 1905. Serial No. 14,695. Published May 1, 1906.

54,353. WATCHES, WATCH MOVEMENTS, WATCH CASES AND WATCH PARTS. WILLIAM F. DOLL, New York.

The word "DOLL." Used 10 years.

54,358. MEDALS AND BADGES. CALVIN W. LITTLE, Montclair, N. J.

The words "LITTLE SYSTEM" arranged in opposite-curved lines. Filed Aug. 26, 1905. Serial No. 12,013. Published May 1, 1906.

54,561. STERLING SILVERWARE. R. WALLACE & SONS MFG. Co., Wallingford, Conn.

A stag's head, heraldic roll, and the letters "R W & S." Filed April 27, 1905. Serial No. 3,254. Published May 8, 1906.

54,602. SILVER HOLLOW WARE, FLAT WARE AND TABLE WARE. WILCOX & WAGONER CO., New York.

A circular wreath and upon it a conventional sword. Filed Aug. 26, 1905. Serial No. 12,042. Published May 8, 1906.

54,731. SILVER-PLATED FLAT WARE, HOLLOW WARE AND TABLE WARE. WM. A. ROGERS, LTD., New York.

A pair of opposed braces. Arranged upon either side of the braces are the words "EXTRA" and "PLATE," and within the braces are the words "COIN SILVER." Used 10 years. Filed May 25, 1905. Serial No. 6,568. Published May 8, 1906.

(Patents continued on page 77.)

# Jet is Most Popular

It has taxed our utmost capacity to keep up with orders; however, our stock is now complete and we are ready to fill any demand from the largest and finest collection of French Jet in the United States.

**COLLARETTES,  
FESTOONS,  
BRACELETS,  
BARRETTES,  
DIADEMS,  
BROOCHES,**  
In Bright and Matt Effects.

## CHOPARD FRÈRES,

Makers of French Jewelry Novelties,

49 Maiden Lane, New York.



Made of gold plate, in all the popular finishes and sizes, with and without stones.

Ask your jobber to show you this new creation, or write us for details of construction and price.

MANUFACTURED BY

### CASTIGLIONI & CAPALDI CO.

Successors to T. F. GREENWOOD CO.

9 Callender St. Providence, R. I.

Manufacturers of Novelties in Bracelets, Brooches, Hat Pins, Scarf Pins, Barrettes, etc., of highest grade, that defy competition



## The "Opera"

works with a spring and gracefully fits any wrist. Invisible joint, and the peer of all. The best seller of the season.

## THE WASHBURN SECURITY MAGIC NUT

Automatic Holder for all sizes of scarf-pin wire. Guaranteed.



**EAR WIRES**  
for unpierced ears.



for ear studs, scarf-pins, etc.



Open.



Closed.

**SAFETY CATCH**  
For brooches, etc. Can be applied to any work where pin tongues are used.

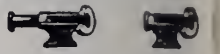

Open.



Closed.

Descriptive Circular on Application.

Pearl Drilling and Adjusting a specialty.

Special Order Work and Repairing.

C. IRVING WASHBURN, 12-16 John St., N. Y.

# A NEW MOVEMENT

THE O-SIZE 7 JEWELED PENDANT SETTING

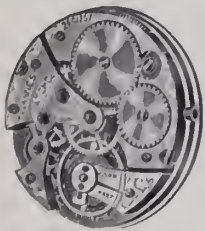

## TAVANNES

Is Fully Guaranteed

FOR SALE THROUGH THE JOBBING TRADE

## TAVANNES WATCH COMPANY

2 & 4 Maiden Lane, New York



**BRITISH PATENTS.**

(ABRIDGMENTS OF SPECIFICATIONS, 1905, FROM *The Illustrated Official Journal.*)

ISSUE OF JUNE 20, 1906.

**3,333. HOOKS.** G. BRENTON, Kent. Feb. 17.  
Relates to a hook for suspending china plates, pictures and other ornaments on walls. The hook

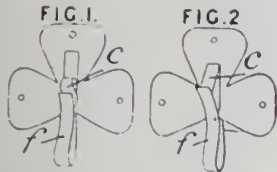

is preferably trefoil in shape. The stalk is turned inwards at *f* and meets a piece *c* stamped out of the body.

**3,360. MAGNETIC COMPASSES.** A. F. C. BENTLEY, Waltham Abbey, Essex. Feb. 17.  
In a compass, fitted with a sighting device, the

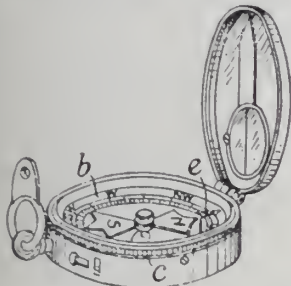

graduated compass rim *b* is fixed to, and rotates with, the bezel *c*. A pointer *e* is fixed in the line of sight.

**3,371. CLOCKS.** G. SCHONBERG, Frankfurt, Germany. Feb. 17.  
*Electric Clocks.*—A centrally-pivoted armature 13, rocking between a stop 14 and the poles 12 of an electromagnet, throws back an eccentricity-loaded fly-wheel 1, which drives a clock movement

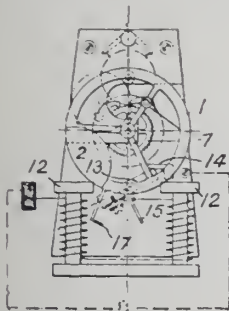

through a ratchet-wheel 7. The circuit is made and the impulse is given by the contact of arms 17, 15, on the fly-wheel and armature respectively, the arms sliding on one another. A spring may replace the load 2 on the wheel.

**3,398. LENSES.** H. D. TAYLOR, Mount Villas, York. Feb. 18.

Relates to a modification of the Cooke photographic lens, described in Specification No. 22,607, A.D. 1893, to adapt it either for single use or for

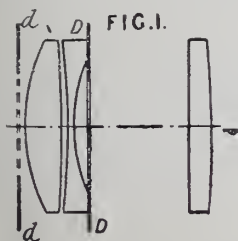

conjoint use with a similarly modified lens of the same or different focal length. In this way, such lenses may be used either singly or in combination to obtain a greater range of focal length.

Fig. 1 shows such a modified lens. The stop is removed from D-D to *d-d* so that, when two are combined as shown in Fig. 2, the two stops func-

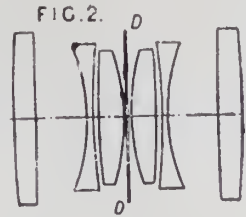

tion as one. The constructional data and the optical constants for the variously modified lenses are given at length in the specification.

**3,445. MATCH BOXES, PURSES, ETC.** S. M. LEVI and C. M. LEVI (trading as S. M. Levi), Birmingham. Feb. 20.

One part A of a hinged case made in two parts contains a sovereign purse K of usual form and

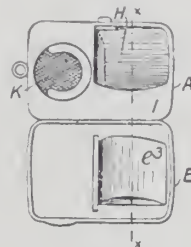

a match holder H consisting of a space in the case partially covered by a plate I; the other part B is formed with a depression *e*<sup>2</sup> to hold stamps, which are kept in place by two projections. A hinged lid on the outside of the case is provided to cover this depression, and is held closed by a pin engaging in a hole in the case.

**3,589. SOLDER.** A. W. KING, London, and ADVERTISING MIRRORS Co., London. Feb. 21.

A solder, by means of which aluminum may be soldered to aluminum or to another metal, is obtained by melting together, at a low red-heat, 10 parts of soft solder, five parts of pure zinc, and five to eight parts of aluminum. The aluminum to be soldered is coated with this solder before the soldering operation itself, which is effected by means of ordinary solder.

**3,632. PURSES.** A. W. COULTER, Richmond, Surrey. Feb. 21.

In the construction of a sovereign purse of metal provided with two chambers, two channel-section metal strips, bent into a horseshoe shape and having slots *a* cut in the flanges, are fitted together,

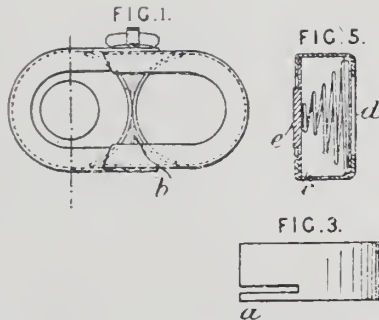

so that each piece projects slightly above the other. A partition *b* separates the case into two chambers. Within each chamber is a spring *c* with plates *e*, *d*. The latter forms the usual support for the coins, while the former projecting somewhat prevents the coins from the opposite chamber from slipping out. To insert a coin, it is laid on this projecting plate *e*, which is then depressed and the coin pushed horizontally along into the other chamber.

**3,691A. SPRINGS.** C. D. ABEL, London.—(Siemens & Halske Akt.-Ges., Berlin, S. W.). Feb. 22.

The springs of clockwork are made of tantalum or of alloys thereof, with other metals such as iron, or with carbon or other hardening-media. The tantalum or alloy is best fused *in vacuo* by the electric current, and is annealed at a moderate

temperature on plates or in drums, or at higher temperatures *in vacuo* by electric resistances, or directly by passing the current through the object.

**3,691B. PENS.** C. D. ABEL, London.—(Siemens & Halske Akt.-Ges., Berlin, S. W.). Feb. 22.

Pen nibs are made of tantalum or alloys thereof with other metals. The tantalum may contain small quantities of other substances such as carbon, silicon, or boron, serving to impart greater hardness thereto. In the process of working, the metal may require annealing. This may be done by bringing the nibs in contact with heated plates or drums. If a high temperature is required, heating *in vacuo* by electric means may be employed. Alloys of tantalum with wolfram or iron may be used.

Complete specifications accepted June 23, 1906.

- 15,876. TIME RECORDER. DYSON.
- 17,847. BEZEL. SIMMONS.
- 20,410. CLIP. SALMON. 1906.
- 3,323. COMB. STEERE. Applications filed June 5 to June 9, 1906.
- 12,956. COLLAR BUTTON. E. C. FORRESTER, Birmingham.
- 12,995. LENS-GRINDING MACHINE. E. M. LONG and THE STANDARD OPTICAL Co., London. Complete specification.
- 13,014. COLLAR BUTTON. HEINRICH ROSEN-BUND, London.
- 13,017. CLOCK. E. M. GOLDSMITH, London. Complete specification.
- 13,043. SAFETY-PIN. ANTON THISEN, London. Complete specification.
- 13,206. SPECTACLES. F. G. SHAW, London.
- 13,211. HOROLOGICAL APPARATUS. META A. SIEDENTOPFF, London. Complete specification.
- 13,227. TIME-RECORDER. WILLIAM TAYLOR, London.
- 13,236. SAFETY HOOK FASTENING. W. A. CLARK, Birmingham.
- 13,276. TIME-RECORDER. L. W. GREAVES, London.
- 13,299. POCKET KNIFE. JOSEPH RODGERS, Sheffield.
- 13,340. TIME RECORDER. ALEXANDER RONA, EMIL WIRTH and SALAMAN DEUTSCH, Liverpool.
- 13,353. NAPKIN RING. PHILIP DIETMAR, London. Complete specification.

**What Must be Done to Protect Patents and Trade-Marks in Hungary.**

UNDER date of April 9, Consul General Frank D. Chester, of Budapest, reports on the injury resulting to American export interests from their failure to adequately protect their goods in Hungary. The consul general calls the attention of machine exporters to the necessity of obtaining Hungarian patents and registering their trade-marks in Hungary, at the same time designating a Hungarian attorney to prevent infringements on the same. He cites the case of a well-known American firm engaged in manufacturing incubators, which firm will sustain a loss of about \$3,600 yearly in case it fails to prove promptly in the district criminal court of the city of Budapest, under section 12 of the Hungarian patent law, that its goods were used in Hungary (or prepared to be used) before the filing of the application for a certain patent granted to a Hungarian firm for incubators of a somewhat similar form and system.

Thus far no clue has been obtained to the thief who broke into the store of Maurice Duncombe, Wattsburg, Pa., and stole four dozen gilt spoons and about 25 watches. A reward of \$25 has been offered for his apprehension.

# Mainspring Don'ts

## Simple Hints for Those Who Handle Mainsprings

---

Don't fail to provide yourself with the best mainspring winder that can be obtained. See that the hooks on all arbors of the winders are no longer than the thickness of the thinnest spring, and thus avoid kinking, and therefore unnecessary breaking of mainsprings.

Don't use a mainspring that is too long, because it fills the barrel and prevents that part, or the mainwheel, from making the required number of revolutions, with the consequence that the watch will not run as it should after each winding.

Don't use a mainspring that is too strong, because it will set, increase the percentage of breakage and injure the watch.

Don't use a mainspring that is too wide, and be sure that the tip and brace do not extend beyond the limits of the cover and barrel.

Don't forget that a mainspring should not occupy more than one-third the diameter of the barrel, thus leaving two-thirds to be divided between the arbor and winding space, to enable the watch to run about thirty-six hours.

Don't expect a mainspring to be flat if you put it in the barrel with the fingers. This method usually injures the spring, gives it a cylindrical form, and thereby increases the friction in the barrel.

Don't bend the inner or outer end of the mainspring with flat-nosed plyers, but provide yourself with specially made round-nosed pliers which will give a circular form to these parts, prevent short bends, contract the inner coil, and thus secure a closer fit to the barrel arbor without injuring the spring.

Don't expect other than a properly fitted flat mainspring with rounded edges to produce the least friction in the barrel, allow the greatest amount of power to the train, and give the best results as to time, service, etc.

Don't expect a mainspring to always endure extreme changes in temperature, or electrical disturbances, or straightening at full length, or neglect from lack of cleaning and oiling.

Don't expect a watch that needs cleaning or other repairs to run satisfactorily by merely putting in a new mainspring.

Don't expect a mainspring to plough through too much dirt.

---

## Waltham Watch Company

Waltham, Mass.

# THE HOROLOGICAL REVIEW.



## Some German and French Horological Inventions.

**PLATE FOR MANIPULATING WATCH SPRINGS.**  
 THIS plate is designed especially for the use of watch repairers in truing springs. It prevents the shadow cast by the spring in operating with an ordinary slab of ivory or even a simple sheet of paper. Fig. 1 gives a perspective view and Fig. 2 cross section of the plate.

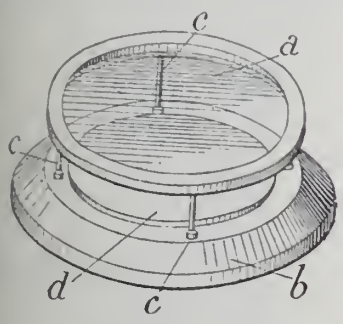

FIG. 1.

It consists of a disk of glass *a*, flat and mounted on a pedestal by means of pillars *c*, which keep it in a horizontal position at a desired distance from the pedestal. On the latter is fixed a round slab *d* of ivory, celluloid, enameled metal, or any other white, polished material. In order to true a spring, this is simply placed on the glass disk and worked in the usual manner. The spring is lighted from above by daylight or

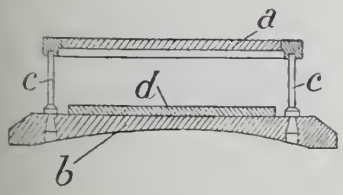

FIG. 2.

by a lamp, while it is also lighted from below by the same sources of light, the ivory slab serving as a reflector. The coils, which appear confused as ordinarily observed, can thus be readily distinguished and separated on occasion, even without the aid of a microscope.

### DATE WATCH.

In date watches, levers or outside push-pieces are generally made use of for setting the hands of the date, days and months, as

well as the disk of the lunar phases, or else a mixed system of pushpieces, levers and star wheels, projecting slightly beyond the setting of the glass; but hitherto a system embracing only star wheels has never been employed. Such a system is illustrated herewith. (See Fig. 3.)

In this watch the hands *q* of the date, *m*, of the months, and *i* of the days, as well as the disk *p*, of the lunar phases, are all governed for their setting by star wheels slightly extending beyond the bezel of the glass. The bezel, which is not given in the drawing, is adjusted as ordinarily on the notch *c* of the rim *C* of the case.

The wheel *M*, solidly connected with the hand *m*, is governed by the wheel *A*; the wheel *Q*, solidly connected with the hand *q*,

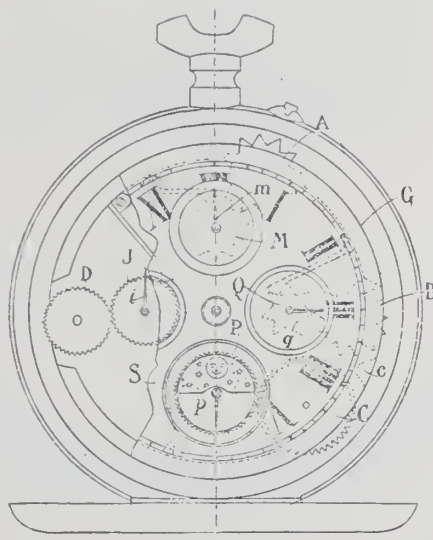

FIG. 3.

is governed by the wheel *B*; the disk *p* of the lunar phases, solidly connected with the wheel *P*, is governed by the wheel *C*; and the wheel *J*, solidly connected with the hand *i*, is governed by the wheel *D*. All these setting wheels are placed under the dial *S*, and project slightly beyond the bezel of the glass through openings, allowing the action of the finger.

### WARNING SYSTEM FOR STRIKING CLOCKS.

In this system the warning is secured in the following manner: On the pinion immediately governing the barrel of the movement is a wheel of 80 teeth. The pinion should project beyond the plate from seven to nine millimeters on the side of the dial.

At the end of the pinion is a similar wheel of 80 teeth, furnished with 10 pins, which serve as lifts for one or more hammer rods, according as one or several rods are arranged to give one or several strokes, together or separately, as in cuckoo clocks.

This wheel of 80 teeth and 10 pins actuates all the dial work by means of a pinion of eight leaves, placed below or immediately above the hour wheel. This should be free on the arbor of the center pinion. The hammer rods and the bells are placed as in the

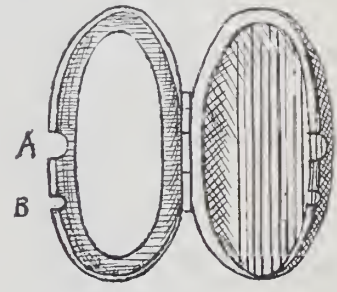

FIG. 4.

ordinary movements of clocks in the side of the movement, working the system. The bells are placed one over the other on the

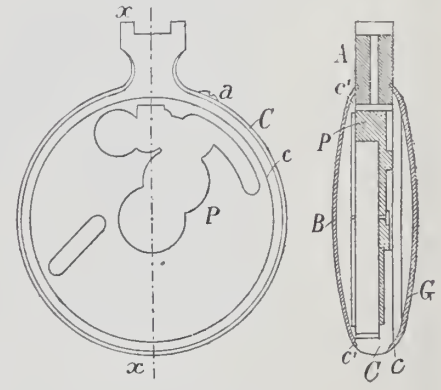

FIG. 5.

same support, but they may be placed differently.

The system consists in the adaptation of the train. The rods, hammers and bells are only accessories.

### NEW FORM OF WATCH CASE.

The case illustrated in Fig. 4 needs but a short explanation. Those who have seen the old, double case watches will understand the combination. A ring surrounds the movement. It bears the pendant and the

# An Argument for the ELGIN Dealer

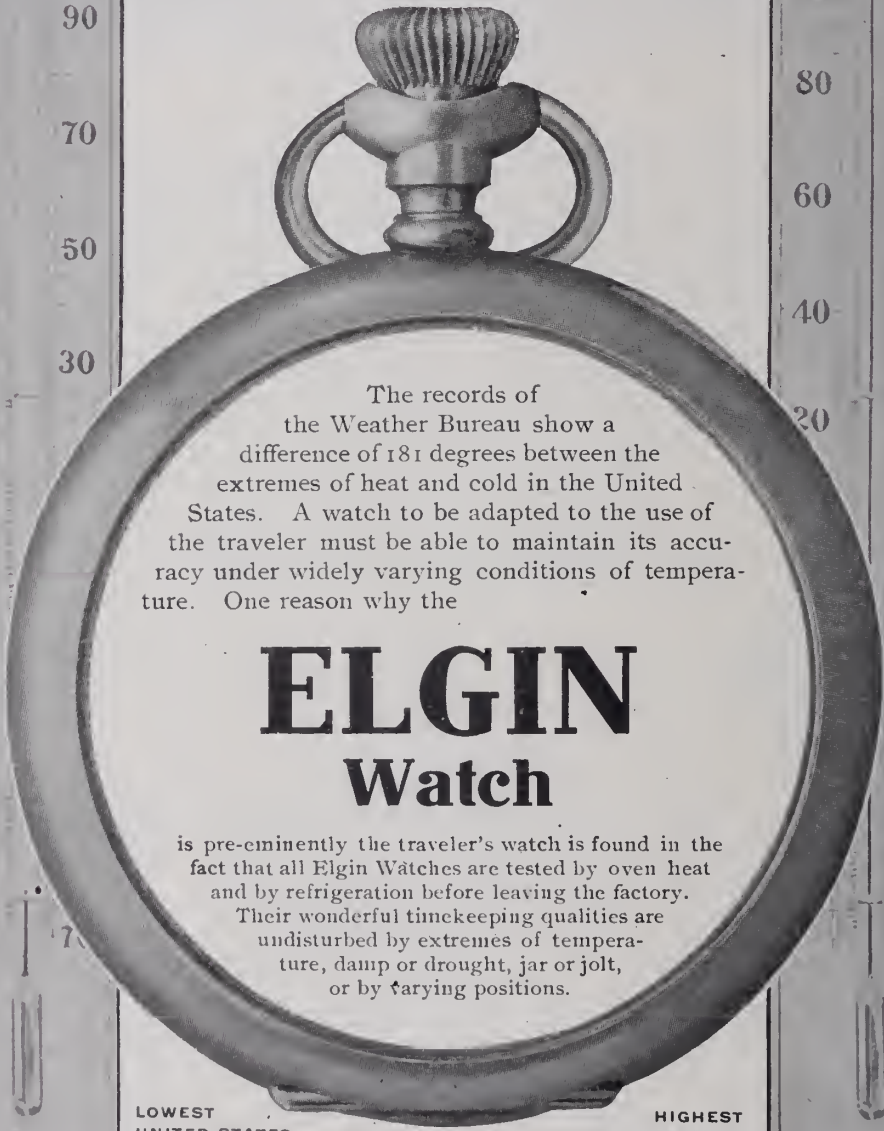
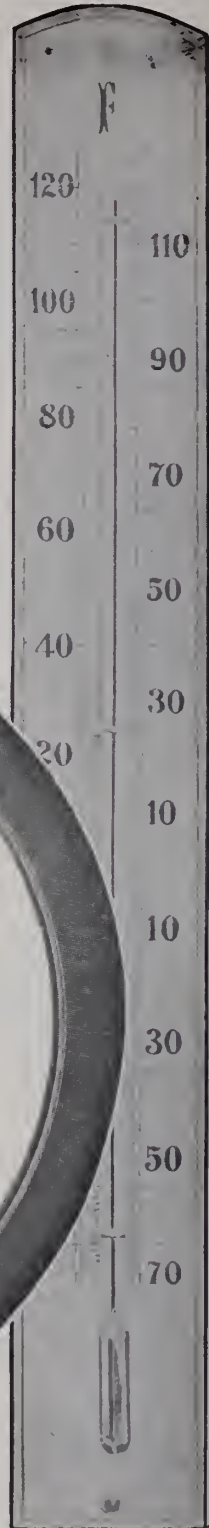
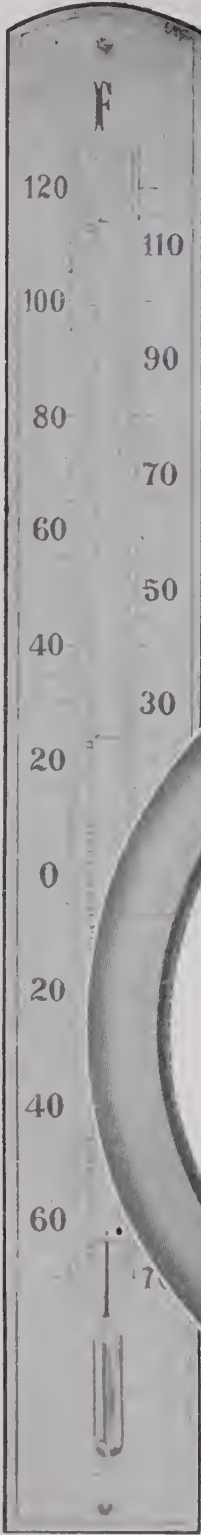

The records of the Weather Bureau show a difference of 181 degrees between the extremes of heat and cold in the United States. A watch to be adapted to the use of the traveler must be able to maintain its accuracy under widely varying conditions of temperature. One reason why the

## ELGIN Watch

is pre-eminently the traveler's watch is found in the fact that all Elgin Watches are tested by oven heat and by refrigeration before leaving the factory. Their wonderful timekeeping qualities are undisturbed by extremes of temperature, damp or drought, jar or jolt, or by varying positions.

LOWEST  
UNITED STATES  
TEMPERATURE  
63° BELOW

HIGHEST  
UNITED STATES  
TEMPERATURE  
118° ABOVE

The above is one of the many good arguments for the Elgin Watch, all of which help the dealer to sell Elgins.

See Jobbers' list for prices or write the Company.

Every dealer is invited to send for the Elgin Art Booklet, "Timemakers and Timekeepers," illustrating the history and development of the watch.

### ELGIN NATIONAL WATCH COMPANY

Factories, ELGIN, Illinois, U. S. A.  
General Offices, 131 Wabash Ave., Chicago.

NEW YORK OFFICE, 11 John Street.  
SAN FRANCISCO OFFICE, 206 Kearny St.

pe of the pushpiece. The case closes with groove snap and has two notches, A and for the passage of the pendant and the shpiece.

**WATCH HAVING PLATE AND PENDANT IN A SINGLE PIECE.**

In this watch, one form of which is illustrated in Fig. 5, the plate and pendant are formed together of a single piece of metal, the periphery of the plate also forming the rim of the case. A plan and a cross section are shown following the line XX, the bezel of the glass not being represented in the former figure.

The plate P and the pendant A of the watch may be stamped out of the same piece, or cut out in any way. The circumference C forms the rim, and the back of the case, as well as the setting of the glass are fitted on the notches c, c', made respectively on and under the plate.

Instead of a single back, B, two may be adjusted; that is, a dome and the usual back. A glass may also be placed under the back B, the glass being fitted, either directly on a corresponding notch of the plate, or by the intervention of a bezel. A hunting watch may also be formed in the same way by placing a second back on the setting of the glass on the side of the dial. A projection a may be formed, if desired, on the circumference C, forming the rim. The ticks or coverings may be fitted with or without hinges; these may be formed in the body of the plate or inserted.

The forms and dimensions of the plate and the part forming the pendant, as well as the metal employed in the construction of such a watch, may, of course, be varied at will. This is true also of the movement, which may be a key watch or a stem winder, with cylinder, lever or other escapement. The watch is simple, solid and economical in manufacture, since several pieces may be omitted, and some of the handwork, especially in putting in the movement, may be saved.

**Horological Notes.**

GREATER than ever, jewelers say, is the demand for women's watches this year. Why this should be the purveyors have not undertaken to explain. Of course, with woman's position of increasing importance in the affairs of the business world she practices more frequently the virtue of punctuality. The increased sale of tiny timepieces, however, cannot be accounted for through that circumstance, for the varieties that are being sold are of the small, showy sort that are pinned on the front of the dress where the actual wearer cannot see them. It is doubtful, too, if they are being worn in increased numbers through any desire of the owners to add to the convenience of the watchless public.

The wind recently caused the dome of the courthouse at Independence, Mo., to vibrate so much that one of the heavy pendulums of the big clock was dislodged. It fell to the stairway below, narrowly missing the heads of several persons. The county court has been considering the rebuilding of the tower, but last Saturday postponed the matter on account of the cost, which would be about \$15,000.

**The Addimeter.**

(Translated for THE JEWELERS' CIRCULAR-WEEKLY from the *Revue Internationale d'Horlogerie*.)

THE new measuring instrument illustrated herewith, was invented by Ch. Rode, manager of the Rode Watch Co., and Maurice Picard, Chaux de Fonds. It is being manufactured by the house of Henry Picard & Bro., and is called the addimeter. It is intended for gauging the distances between watch plates and bars, giving in this manner the exact height of staff shoulders of mobiles (staffs of pinions, pallets, etc.).

These measurements have hitherto been difficult to obtain by means of micrometers of the ordinary construction, which have attachments, such as jaws or points moving in opposite directions, and the thickness of



A NEW MEASURING INSTRUMENT.

which prevented the measurement of some of the shoulder heights of such mobiles as mentioned.

The addimeter has only one attachment or jaw, which is pierced for the fixing of a staff. This staff projects in both directions, up and down, as shown herewith. The extremities of these projections are intended for points of contact in taking measurements. In this manner the thickness of one of the jaws of the old fashioned micrometer is suppressed and greater facility of the entry of the one jaw modified between the hole jewels is provided.

The device, which is constructed in the same manner as the "selometer," is eminently practical. The platform for the placing of the watch plate is movable and may be adjusted and held in a proper position by a female screw, placed in the lower part of the base of the apparatus. In addition to the measuring arbor in the jaw, another movable arbor is fixed in the bottom of the mechanism, but not connected in any manner with the first. This second arbor serves for the support of and to keep in place the jewel of the watch plate.

The principal of gauging is based on the fact that the measuring arbor in the jaw has a dimension in millimetric units; by means of the movable platform the num-

ber of units which any mobile may contain is recorded by raising or lowering the watch plate until the long hand stands at O. Then the pressure on the lever will bring the upper projection of the arbor in the jaw in contact with the jewel in the bar and the small hand will indicate the fraction of a millimeter in hundredths, which is to be added to the units of millimeter. The sum is the exact height of the shoulders of the mobile, of which should be deducted a small proportion for end shake. It may become necessary, when this tool is applied to general use to modify the form of the jaw and make it right or left, knee shape or of any other convenient form.

**Clock Soon to Celebrate the 200th Anniversary of Its Ticking.**

AN old and interesting grandfather's clock was shipped from Rochester, N. Y., as a wedding gift, recently, by C. H. Barker. The clock will be 200 years old next year, and was until recently the property of Robert T. Murphy, of Alexander St., that city. It is an heirloom and was given to Mr. Murphy by his grandfather, with the understanding that it was to go to his lineal descendants, or, in default of such, to another branch of the family.

One of Mr. Murphy's nieces was married a short time ago and he decided to send it to her as a wedding present. He had Mr. Barker repair and clean the clock and ship it to the bride in Pennsylvania.

The clock is seven feet two inches high and has in general the appearance of copies of such clocks made to-day. It is of ash and was painted a yellowish color with brown trimmings. It is very heavy, being of boards one inch thick and hand made. The dial is of wood, three-eighths of an inch thick. The diameter of the dial is 12 inches. The hands are antique and necessarily long. The clock is run by weights and wound with a large key which reminds one of a crank.

Under glass in a wooden frame, which is attached by screws to the inside of the case, is a label, which says:

HARGRAVE & SON,  
Clock and Spinning Wheel Makers.  
Finest ash of all kinds for sale cheap, rigging spars, splices and caulkers' oakum. A goodly import of Norwegian pitch direct from England. Trunnels spokeshaved by the hundred. All of Chandler's supplies. Loft and salesroom over Bell's Tavern.  
Narset Square, Boston, Mass.  
1707.

Besides this advertisement there is within the clock, where the pendulum swings, a screw on which is hung an old-fashioned bootjack. The clock has been in use right along and will probably tick off many more seconds, hours and days.

In the possession of Major D. H. Kelton, Montpelier, Vt., is a clock said to be over 100 years old. The clock was made at Osburne's factory, in Birmingham, Eng. It has brass works and shows the days of the month and the phases of the moon. The clock stands eight feet high and is finished in brass trimmings. The case is made of inlaid cherry of a very pretty grain.



## Is Your "Middle Case" Empty?



In watches, Mr. Jeweler, there are three classes necessary to serve all customers—to make up a complete stock. The high-priced watch, the *medium-priced* watch and the low-priced watch. The *medium-priced* watch is the *one important* class from the *profit standpoint*. That is why the

# New England

THE WATCH FOR THE GREAT AMERICAN PEOPLE

fills the most important place in the jeweler's stock. It is built for the great mass of buyers of medium-priced goods. It is the highest grade, medium-priced watch made.

With both Ladies and Men New England Watches are sellers, but far more, they are without competition; they have the medium-priced field all to themselves; they are indispensable to *your* "middle case," Mr. Jeweler.

And there's another point of vital interest. We are talking New England Watches to the public, and are going to talk them convincingly again this Fall *through extensive advertising*. We are widening their already wide and exclusive field and making them more necessary to you. Frankly, the results are showing in doubled sales. But they will do better.

**Remember, the jeweler handling the New England line will get the trade this Fall and this Christmas and ever afterwards. Advertising is going to do it.**

If *your* medium-priced case is empty; if *you* don't handle the New England Watch, this is a mighty favorable time to take the matter up with us. Write us for details of our carefully worked out plans for bringing you business. Let us help you.

Address,

DEPARTMENT OF PUBLICITY

**NEW ENGLAND WATCH CO., Waterbury, Conn.**

**New Style of Watch Without Hands.**

(Translated for THE JEWELERS' CIRCULAR-WEEKLY from the *Revue Internationale de l'Horlogerie*.)

THE making of new designs of watches without hands has in recent years been selected by inventors. Of the latter some preferred to direct their efforts to the production of new models of flat or extra watches; some others have made novelties in watches, where the balance and parts of the escapement were exposed to view in some part of the dial, while still others have made specimens of watches which would go for one or two weeks with single winding.

It will, therefore, interest our readers



FIG. 1.

When we bring to their notice a description of a newly invented watch without hands under the name of "Domina," which presents an attractive novelty and is a distinct advance in the characteristics of such a watch as regards simplicity and solidity in its mechanical construction.

Here instead of the usual complicated construction offering very little satisfactory service in certain watches without hands, for instance the one with double wheel, governed by the action of a spring motion producing the sudden jump for the change of the minute; or yet the one with single wheel, where the cutting of a number of teeth has created a balance in the wheel which at the moment of the change of a minute makes a sudden jump against the pinion of the fourth wheel, to effect a change of the cipher. The new watch which is described to-day presents marked advantages.

Attached to the staff of the center wheel is a disk, the rim of which shows a division from 0 to 60, and the ciphers 5 to 60 following each other in sub-divisions of 5 marked 5, 10, 15, 20, etc.

These divisions and ciphers marked on the disk are visible through an opening cut out of the dial, below which the disk revolves and turns once per hour.

This disk, indicating the minutes, carries at a certain point on its circumference an index finger, which at every turn projects a tooth on a star wheel of 12 teeth,

the staff of which is pivoted on the plate in such a manner that it turns 1/12 of one revolution for an entire turn of the minute disk. A jumping spring controls at the same time the teeth of the star wheel, to hold the latter in a steady position till a change for a successive cipher is in order. These ciphers from 1 to 12 are seen through a second opening of the dial above the one showing the minutes. (Fig. 2.)

The center wheel controls by means of



FIG. 2.

the third wheel and the next pinion of the fourth wheel the pinion of which carries the second hand and which pinion describes one revolution per minute of which a subdivision of 60 parts is traced on the dial.

**Time as Indicated by Some New York Clocks.**

WHAT'S the matter with the clocks in Broadway, between 23d and 45th Sts.? asks a writer in a daily exchange. The other day a friend set a valuable gold watch by the clock in front of the Fifth Ave. Hotel. When he got to 28th St. the clock in a big store near the corner was 10 minutes ahead of the time on his watch. There was a difference of seven minutes between the Gilsey House clock and the one across the street, and the clock in a jeweler's store two blocks up was two minutes faster than the hotel timepiece.

In the Hotel Marlborough the clock was four minutes faster than the one in the jeweler's shop diagonally across the street, and the big clock on top of the Cadillac was three minutes behind the one in the Marlborough. There also was a difference of almost five minutes between the clock in front of the Metropolitan Opera House and the one on the Cadillac.

A clock in the tower of the Town Hall of Harrison, N. J., recently developed a tendency to erratic bursts of speed sandwiched between attacks of abnormal laziness. There was apparently no cause for this, the works, on examination, appearing to be all unimpaired. Recently a passerby noticed a commotion among pigeons flying around the face of the clock, and, watching them, found that one of them was comfortably roosting on the hand of the clock and others were trying to perch on the slanting arm. It is now believed that the birds have been the cause of all the trouble.

**A New Watch Constructed With the Tourbillon Escapement.**

(Translated for THE JEWELERS' CIRCULAR-WEEKLY from *La France Horlogere*.)

A WATCH has been shown to us by Paul Loichat, Charquemont (Doubs, France), with a visible rotary escapement intended to keep perfect time in all positions. The escapement being visible in the dial, these watches can be used to advantage as a show window attraction.

Under the name of the "watch with a phenomenal tourbillon," it has been patented in France and in other principal countries. Its size is 19 lignes.

The five parts which constitute the es-

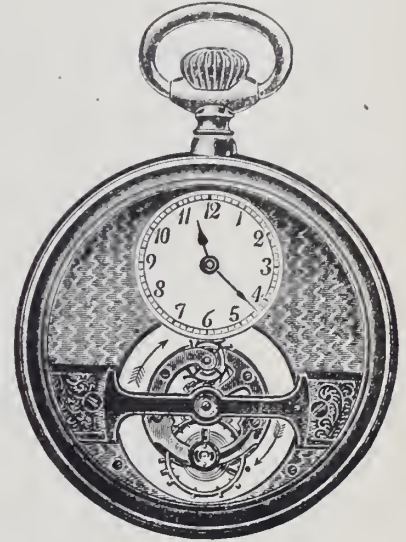

WATCH WITH VISIBLE ROTARY ESCAPEMENT.

capement are placed on a rotating plate, which makes one revolution per minute.

**A German Inventor's Mode of Tightening Loose Hand Setting Posts.**

A CONTRIBUTOR to the *Deutsche Uhrmacher Zeitung* describes a tool for repairing loose hand setting posts, illustrated herewith. *A* is a brass stake 3 cms. long and 7 mm. wide and thick; *b* is a piece of watch spring somewhat longer than the brass stake, *a*, as shown at *b*, and which is

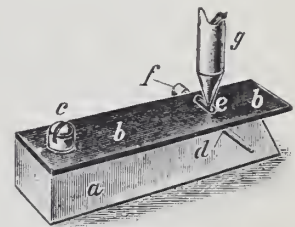

DEVICE FOR TIGHTENING HAND-SETTING POSTS.

attached to *a* by a screw at *c*, which leaves to the long end an elastic freedom at *b*.

The brass block *a* has at *d*, a groove covered by the spring *b*, by means of which the setting post, *f*, to be operated upon, is held in place. The spring, *b*, has an opening at *e*, through which the setting post, *f*, is made accessible to the center punch, *g*, which, by the blow of a hammer, raises a burr on several of them on the setting post.

# A Booklet, Showing Complete Prices on Watches in all Sizes, for the Asking

This small price-list, printed in RED and BLACK, gives prices on more than 1000 complete watches. Prices on the 25-year and 20-year cases are printed in different colors.

## THE MEAD PRICE-LIST

COMPLETE WATCHES

COMPLETE WATCHES

16 SIZE COMPLETE WATCHES.					16 SIZE COMPLETE WATCHES.											
JEWELS	ELGIN NUMBER	WALTHAM NUMBER	PRICE	JAS. BOSS OR CRESCENT				JAS B OSSOR C RESCENT				CROWN				Nickel
				HUNTING		OPEN FACE		S. B. & B.		S. B. & S. R.		P. P., E. T. or ENG.		S. B. & B. & S. R.		
				Eng.	P.P. or E.T.	Eng.	P.P. or E.T.	Eng.	P.P. or E.T.	Eng.	P.P. or E.T.	Hunt-ing	Open Face	S. B. & B. & S. R.	S. B. & B.	
				\$21.00	\$19.00	\$19.00	\$17.50	\$17.00	\$15.50	\$19.00	\$17.50	\$17.00	\$15.50	\$12.50	\$15.50	\$ 1.30
				16.00	15.00	14.00	13.00	11.50	10.50	14.00	13.00	11.50	9.80	7.00	9.70	
7	290 291	610 610	\$10.00	31.00	29.00	29.00	27.50	27.00	25.50	29.00	27.50	27.00	25.50	22.50	25.50	11.30
				28.00	25.00	24.00	23.00	21.50	20.50	24.00	23.00	21.50	19.80	17.00	19.70	
15	312 313	620 620	14.00	35.00	33.00	33.00	31.50	31.00	29.50	33.00	31.50	31.00	29.50	26.50	29.50	15.30
				30.00	29.00	28.00	27.00	25.50	24.50	28.00	27.00	25.50	23.80	21.00	23.70	
17	339 340	625 625	18.00	39.00	37.00	37.00	35.50	35.00	33.50	37.00	35.50	35.00	33.50	30.50	33.50	19.30
				34.00	33.00	32.00	31.00	29.50	28.50	32.00	31.00	29.50	27.80	25.00	27.70	
17 Adj.	241 244	630* or P.S.B.	23.00	44.00	42.00	42.00	40.50	40.00	38.50	42.00	40.50	40.00	38.50	35.50	38.50	24.30
				39.00	38.00	37.00	36.00	34.50	33.50	37.00	36.00	34.50	32.80	30.00	32.70	
17 Adj.	C. M. W. G. M. W.		25.00	46.00	44.00	44.00	42.50	42.00	40.50	44.00	42.50	42.00	40.50	37.50	40.50	26.30
				41.00	40.00	39.00	38.00	36.50	35.50	39.00	38.00	36.50	34.80	32.00	34.70	
17 Adj.		Ryl. Ryl.	27.50	48.50	46.50	46.50	45.00	44.50	43.00	46.50	45.00	44.50	43.00	40.00	43.00	28.80
				43.50	42.50	41.50	40.50	39.00	38.00	41.50	40.50	39.00	37.30	34.50	37.20	
17 Adj.	242 No O. F.		35.00	56.00	54.00							52.00				
				51.00	50.00							46.50				
17 Adj.	No Htg. 280 L.S.		40.00			59.00	57.50	57.00	55.50	59.00	57.50		55.50	52.50	55.50	41.30
						54.00	53.00	51.50	50.50	54.00	53.00		49.80	47.00	49.70	
17 Adj.		Rvsd. Rvsd. E.S.	41.00	62.00	60.00	60.00	58.50	58.00	56.50	60.00	58.50	58.00	56.50	53.50	56.50	42.30
				57.00	56.00	55.00	54.00	52.50	51.50	55.00	54.00		50.80	48.00	50.70	
17 Adj.	243 No O. F.		44.00	65.00	63.00							61.00				
				60.00	59.00							55.50				
21 Adj.		No Htg. Cr. Sl. L.S.	45.00			64.00	62.50	62.00	60.50	64.00	62.50		60.50	57.50	60.50	46.30
						59.00	58.00	56.50	55.50	59.00	58.00		54.80	52.00	54.70	
19W Adj.	No Htg. 270 L.S.	No Htg. Vang.	50.00			69.00	67.50	67.00	65.50	69.00	67.50		65.50	62.50	65.50	51.30
						64.00	63.00	61.50	60.50	64.00	63.00		59.80	57.00	59.70	
23 Adj.		No Htg. Vang. L.S.	60.00			79.00	77.50	77.00	75.50	79.00	77.50		75.50	72.50	75.50	61.30
						74.00	73.00	71.50	70.50	74.00	73.00		69.80	67.00	69.70	
23W Adj.	156 182	R. Max. R. Max. E.S.	100.00	121.00	119.00	119.00	117.50	117.00	115.50	121.00	119.50	119.00	117.50	112.50	115.50	101.30
				116.00	115.00	114.00	113.00	111.50	110.50	114.00	113.00		111.50	109.80	107.00	

\* No. 630 and Bartlett Waltham are both O. F. and Htg. cases. —Dust Proof Pend. on 20 year S. B. & B. Crown Cases, 30c. extra.

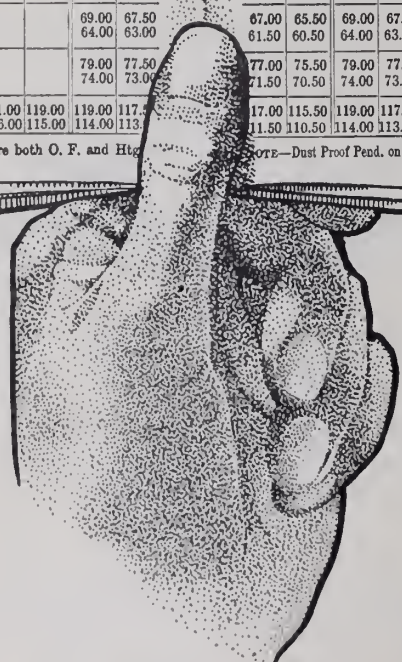

# M. A. MEAD & CO.

American Watches at Wholesale

CHICAGO—Columbus Memo. Bldg.

PITTSBURG—Farmers' Bank Bldg.



IF IT'S A  
**ROY**

TRADE MARK  
IT'S STANDARD



O Size Bassine Engraved Cases, made from assayed Gold, quality as stamped.

**ROY WATCH CASE COMPANY,**



21-23 Maiden Lane,  
NEW YORK.

SAN FRANCISCO.  
LONDON, ENG.

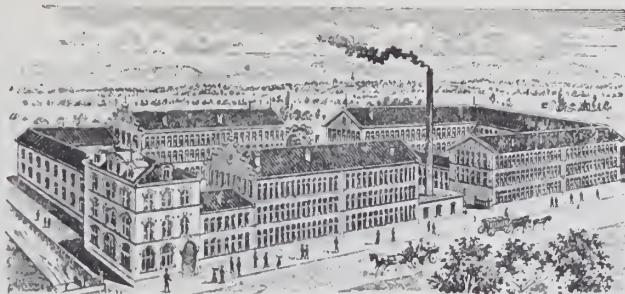

This illustration shows our main factory exactly as it exists, where 3,000 complete watches are made daily.

## LANGENDORF WATCH CO.

CHAUX-DE-FONDS, SWITZERLAND.

It will be of great interest to every jeweler to learn that we are devoting our full attention to this market. The existing conditions in the watch trade have convinced us that there is a long felt want for moderate priced, but accurate Swiss Watches.

We wish to call your attention to our LONVILLE MOVEMENT. It has a lever escapement and is being made in Os, 12s and 16s, fitting perfectly all American cases. This movement is salable and profitable. Our Watches and Movements will be introduced in this market bearing the following names:

- |          |          |
|----------|----------|
| SOLDALÉ  | HIGHMERE |
| BONDALÉ  | LONVILLE |
| CLAREFAX | NAMTOC   |
| PEARLHAM | LADY MAY |

SOLE AGENTS FOR UNITED STATES,

**BYRON L. STRASBURGER & CO.,**  
17 Maiden Lane, New York, N. Y.

## A Complete Line of the Celebrated NARDIN WATCHES

Thin Minute Repeaters, Split Seconds, Movements fitting American Cases, Ship Chronometers and Torpedo Boat Watches can be secured through

**R. NEWBURGH**

Sole Agent

12-16 John Street NEW YORK

Manufacturer of the Current Grade Colbert Watch

## 46 out of 99 PRIZES

were awarded to

## PATEK, PHILIPPE & CO.

In the Timing Contest of the Astronomical Observatory in Geneva, for the year 1905, comprising: The only First Unique Prize for Best Average Running; 2 First Prizes out of 3; 5 Second Prizes out of 10; 8 Third Prizes out of 18; 9 Fourth Prizes out of 24; 10 Honorable Mentions out of 23; 11 Simple Mentions out of 21. 11 Manufacturers participated.

68 NASSAU ST., NEW YORK.

GENEVA, SWITZERLAND.

**JULES JÜRGENSEN**

**Watches and Chronometers**

PARIS—"THE GRAND PRIX" - 1900

**SOLE**

RUDOLPH & SNEDEKER,  
65 Nassau St., New York

**AGENTS**

# The Carmen Watch Bracelet

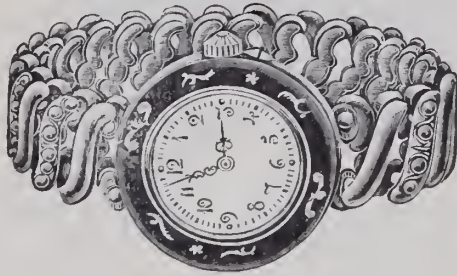

**GOLD FILLED**  
 WITH ENAMEL BEZEL ALL  
 SHADES OR PLAIN GOLD FILLED  
**BOTH BRACELET AND WATCH**  
**ABSOLUTELY GUARANTEED**

During the present great vogue of Bracelets, Jewelers will find these a profitable novelty to handle.

## HIPP. DIDISHEIM & BRO.

Chicago Office, Columbus Bldg. 49 Maiden Lane, New York



**C. L. Guinand**  
**Split Chronographs**  
**with Minute Registers**

**The Turfman's Standard.**

Remarkable for accuracy and reliability. Are cased in Gun Metal, Silver filled and Gold. Prices reasonable.

Imported exclusively by

**Jules Racine & Co.,**

Importers of all grades of Watches and Movements.

103 State Street, Chicago. 37 Maiden Lane, New York.

## Greatest Traveling and Desk Watch

Exact Size.



Runs eight days with one winding.  
 Anchor movement and fine timepiece.  
 Back flies open and stands firm.  
 Can be closed and put in pocket.  
 Come cased in Gun Metal—Artistic German Silver and Damaskeened.

**ALSO NOVELTIES IN WATCH BRACELETS**  
 in SILVER, GOLD FILLED and SOLID GOLD

Write us for information if interested in the new season's offerings.

**KLIPPER BROS.**

59 Maiden Lane - NEW YORK

### Expert WATCH and Chronometer REPAIRING FOR THE TRADE.

When others fail you we guarantee satisfaction. A trial will convince. Prices very reasonable.

List will be sent on request.

**G. OHAN, 37-39 Maiden Lane, Lorsch Bldg., Room 27. NEW YORK.**

### LEARN WATCHMAKING AT HOME

by THE De SELMS CHART SYSTEM, copyrighted and patented. The most simple, practical and up to the minute method of learning.

Saves you time and money while learning and puts you in a position to more than double your income.

50 million timepieces to be repaired. Accurate time is a necessity in the business world. When time is money the watchmaker gets his share of profit. Positions for graduates. Booklet free. Write to-day.

**The De SELMS WATCH SCHOOL,**

109 Perry Street, ATTICA, INDIANA.

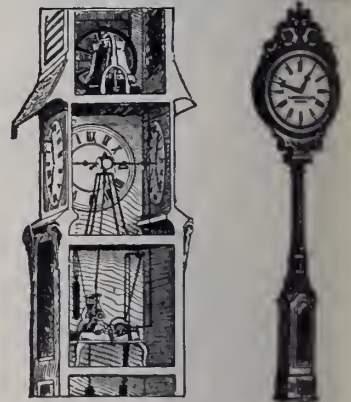

MAKERS OF

**Tower and Street Clocks**

For particulars write us, mentioning The Jeweler's Circular, Week

**E. HOWARD CLOCK CO.,**

EST. 1842. BOSTON, MASS., U. S.

## WATCH REPAIRS

FOR THE TRADE ONLY

**WE BEAT THEM ALL!**

in Prices and Quick Service

**MAEBERT & REISS**

71 and 73 Nassau Street - NEW YORK

# Rockford Watches Speak for Themselves

## SPECIAL REQUIREMENTS IN WATCHES

**N**OT ONLY are these Offices equipped to meet the general needs of the Trade, but to supply such particular requirements as may arise from time to time. You will not be told that the movement you want is "not carried." You may have had that experience elsewhere. Every standard make of movement which is in demand is to be found here. Latest price lists on application.

### J. W. FORSINGER,

LEADING AMERICAN WATCHES AND MOVEMENTS

CHICAGO  
103 STATE ST.

NEW YORK  
2 MAIDEN LANE



# ZENITH

MOVEMENTS

Give the

**RIGHT TIME  
EVERY TIME  
LIFE TIME**

For a

**Grand Prize, Paris Exposition, 1900**

Made in O size, 12 size, 16 size, all grades

Hunting or Open Face, Pendant Set

INTRODUCED FOR THE FIRST TIME IN AMERICA, THOUGH ONE OF THE BEST KNOWN WATCHES IN EUROPE FOR GENERATIONS

Manufactured by

**GEORGES FAVRE-JACOT & CO., Locle, Switzerland**

HIPP. DIDISHEIM & BRO., Sole Agents, } 49 MAIDEN LANE, NEW YORK.  
COLUMBUS BUILDING, CHICAGO.

FULLY GUARANTEED



SOLE AGENTS OF

**400-Day Clocks**  
WITH



# GEO. KUEHL & CO.

178 E. Randolph St., CHICAGO, ILL.

Manufacturers and Importers of

HAND-CARVED  
GENUINE BLACK FOREST

## Cuckoo Clocks

WITH



Jewelers! If you order Cuckoo Clocks, order them with our trade mark.

They are the BEST. There are none BETTER.

Our clocks have received the highest award, "Gold Medal," at the Chicago, Omaha, Paris and St. Louis Expositions.



It is not the question how cheap a Cuckoo Clock is, but how good.

A customer will never remember that he paid a little less for his clock, but he will always remember if the clock does not give entire satisfaction.

For Sale at all Wholesale Clock and Jewelry Houses



# Koshland & Italic Co.

702 Chestnut Street, PHILADELPHIA, PA.

Not how **CHEAP**  
but how **GOOD** is the  
principle we follow  
in selecting the goods  
we offer for sale.

**Diamonds, Watches and Jewelry**

## Practical Course in Adjusting

By THEO. GRIBI.

COMPRISING

A review of the laws governing the motion of balance and balance spring in watches and chronometers, and application of the principles deduced therefrom in the correction of variations of rate arising from want of isochronism, change of position and variation of temperature.

**ELUCIDATED AND DEMONSTRATED**

by original experimental researches in the actual problem, never before published, showing causes that are operative in the variation of rate, and leading to correct remedies, which have been added chapters on

How to make a Balance Arbor with Modern Appliances; How to Clean a Watch Properly; and, the Lever Escapement. Some Current Defects in it and How to Remedy Them.

PRICE. \$2.50.

250 pages, including 18 diagram plates; Fine Paper; Large Type; Clear Illustrations; Systematically arranged; Solid Binding.

THE JEWELERS' CIRCULAR PUBLISHERS  
Publishers

11 John St., cor. Broadway, New York

## "Perfect Yourself"

in ENGRAVING and EXPERT WATCH WORK  
Take a Post-Graduate Course.

RIES & ARMSTRONG, Macon, Ga.

**MOST COMPACT**

AND THINNEST  
DUST-PROOF

**OPEN FACE  
GOLD CASE**

MADE IN THE WORLD  
FOR  
AMERICAN MOVEMENTS.

Made in all shapes, engine turned,  
engraved or plain.



Colby Patent, April 24, 1894.

**DUBOIS WATCH  
CASE CO.**

21 Maiden Lane, New York.

THE THOUSAND  
ISLANDS

will be more attractive than ever this season. The New York Central Lines Four-Track Series No. 10, "The St. Lawrence River from the Thousand Islands to the Saguenay," contains the finest map ever made of this region. Copy will be sent free, postpaid, on receipt of a two-cent stamp by George H. Daniels, Manager, General Advertising Department, Room 61A, Grand Central Station, New York.



REACH THE THOUSAND ISLANDS FROM EVERY DIRECTION

C. F. DALY, Passenger Traffic Manager,  
New York.

For *BEAUTY* of DESIGN, *PERFECTION* of FINISH and *RELIABILITY* Combined with *Moderate Price*

**TRENTON WATCHES  
ARE UNEQUALLED**



No. 140. Bridge Model, 16 Size, 15 Jewel, Hunting and Open-Face, Pendant Setting.

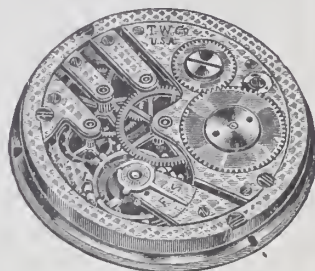

No. 320. Bridge Model, 12 Size, 7 Jewel, Hunting and Open-Face, Pendant Setting.

A sample line is convincing. They are pendant setting in all sizes, fitting regular pendant setting cases, decorated dials and Louis XV hands.



No. 100. Bridge Model, 0 Size, 7 Jewel, Hunting and Open-Face, Pendant Setting.

A NEAT SIGN  
OR ADVERTISING  
BOOKLET FOR  
THE ASKING

JOBBERS SELL  
TRENTONS.

PRICE LIST ON  
APPLICATION.

Manufactured and Guaranteed by

**Trenton Watch Co., - Trenton, New Jersey.**

**SETH THOMAS CLOCK COMPANY.**

Established 1813.

THE MADELEINE.



Wood Case, Adamantine Finish, Metal Columns, Gold Plated Caps and Bases. Superior 8-day Movement, Porcelain Dial, French Sash with Beveled Glass.

List Price, \$10.50; Height, 12 inches.

70 Wabash Avenue, Chicago. **Seth Thomas Clock Co.,** 51 Maiden Lane, New York.

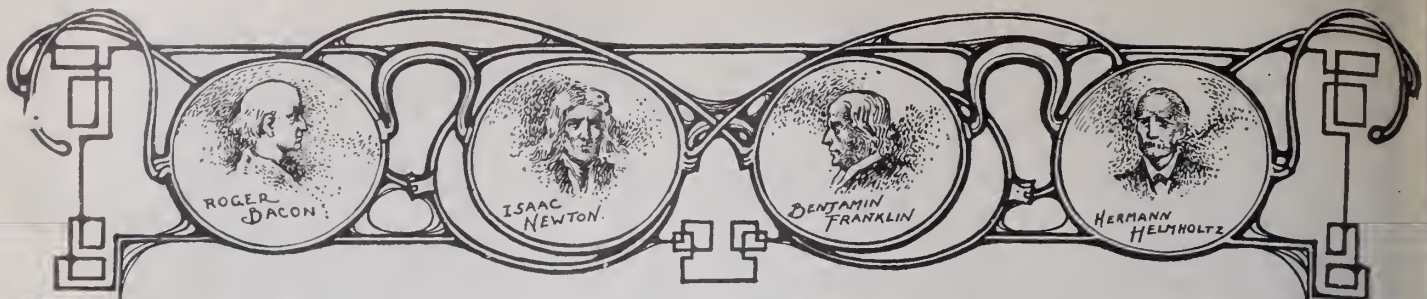

# OPTICAL DEPARTMENT

## The Optometrist's Catechism.

A SERIES OF QUESTIONS AND ANSWERS ON ELEMENTARY OPTICS, IN CATECHETICAL FORM.

By E. Le Roy Ryer.

Copyright, 1903, by THE JEWELERS' CIRCULAR PUBLISHING CO.

(Continued from issue of June 20.)

(Answer to Question 656 Continued.)

### THE NEW OR DIOPTRIC SYSTEM.

The inaccuracies and inconveniences of the old system became so apparent that a new method was sought, which resulted in the introduction of the meter in measuring the focal distances of lenses and in numbering them.

In 1875 the Ophthalmological Society, convened at Heidelberg, adopted as a unit of measurement a lens having a focal distance of one meter. It further agreed to call this unit of measure a "dioptre"; the system of numbering based upon this unit is called the "dioptric system." Efforts have been made to call this standard unit a "meter lens," but while it is a well chosen term, embodying the definition of the object it serves to designate, and requiring no further explanation, it has nevertheless failed to become well established.

With this system we need no longer concern ourselves about the radius of curvature; we measure the refractive power of the lens, caring, as a rule, little or nothing about its refractive index or its radius of curvature so long as it produces the desired optical effect.

The focal distance is not measured in inches either, but with the meter (not with the centimeter or millimeter).

The meter is equal to 39.37 + English inches. It was originally defined as  $\frac{1}{10,000,000}$  of the total distance (on the earth's surface from the pole down to the equator. In the United States the value of the meter is legalized at 39.37 inches, while in England and France its exact value is given as 39.37079 inches, and in some instances it is carried out to 39.3707905. For practical purposes 39.37 answers, and in many instances the round number 40 is employed.

A lens therefore which causes parallel light to focus at 39.37 inches distance from said lens is the standard unit of measurement, and such a lens is termed a 1.00 dioptre. A lens that will focus parallel light at half a meter (about 19½ inches) must be twice as powerful and is a 2.00 dioptre lens, and one that will focus parallel light at two meters is only half as powerful as the standard one meter lens, and is termed an 0.50 dioptre lens.

The interval of a whole dioptre is, of course, too great for a complete series of optical lenses, and intermediate lenses have been added at regular intervals of one-eighth dioptre and numbered in deci-

and the following is all that need be kept in mind:

If you have dioptries and wish the inch values, divide the dioptric value into 39.37, and the quotient will give the inch-value. Thus, to find the focal distance in inches of a 3.00 dioptre lens, divide 3 into 39.37 and the result, 13+, gives the desired result.

Having the focal distance in inches you can obtain the dioptric value by dividing it also into 39.37. Thus, if the focal distance is 13 inches, the dioptric value of such a lens is  $39.37 \div 13 = 3.00$  dioptre. Rough-

LANDOLT TABLE.

Old System.				New System.			
I.	II.	III.	IV.	V.	VI.	VII.	VIII.
No. of the lens, old system.	Focal distance in English inches for refractive index of 1.53.	Focal distance in millimeters.	Equivalent in dioptries.	No. of the lens, new system.	Focal distance in English inches.	Focal distance in millimeters.	No. corresponding of the old system for refractive index of 1.53.
72	67.9	1,724	0.58	0.25	157.48	4,000	166.94
60	56.6	1,437	0.695	0.5	78.74	2,000	83.46
48	45.3	1,150	0.87	0.75	52.5	1,333	55.63
42	39.6	1,005	0.99	1.	39.37	1,000	41.73
36	34.0	863	1.16	1.25	31.5	800	33.39
30	28.3	718	1.39	1.5	26.22	666	27.79
24	22.6	574	1.74	1.75	22.48	571	23.83
20	18.8	477	2.09	2.0	19.69	500	20.87
18	17.0	431	2.31	2.25	17.48	444	18.53
16	15.0	381	2.6	2.5	15.75	400	16.69
15	14.1	358	2.79	3.0	13.17	333	13.9
14	13.2	335	2.98	3.5	11.26	286	11.94
13	12.2	312	3.2	4.0	9.84	250	10.43
12	11.3	287	3.48	4.5	8.74	222	9.26
11	10.3	261	3.82	5.0	7.87	200	8.35
10	9.4	239	4.18	5.5	7.16	182	7.6
9	8.5	216	4.63	6.0	6.54	166	6.93
8	7.5	190	5.25	7.0	5.63	143	5.97
7	6.6	167	5.96	8.0	4.92	125	5.22
6½	6.13	155	6.42	9.0	4.37	111	4.63
6	5.6	142	7.0	10.0	3.94	100	4.17
5½	5.2	132	7.57	11.0	3.58	91	3.8
5	4.7	119	8.4	12.0	3.27	83	3.46
4½	4.2	106	9.4	13.0	3.03	77	3.21
4	3.8	96	10.4	14.0	2.8	71	2.96
3½	3.3	84	11.9	15.0	2.64	67	2.8
3¼	3.1	79	12.7	16.0	2.44	62	2.59
3	2.8	71	14.0	17.0	2.32	59	2.46
2¾	2.6	66	15.1	18.0	2.17	55	2.29
2½	2.36	60	16.7	20.0	1.97	50	2.00
2¼	2.1	53	18.7				
2	1.88	48	20.94				

TABLE SHOWING RELATIVE VALUES OF LENSES ACCORDING TO NEW AND OLD SYSTEM

imals as 0.12, 0.25, 0.37, 0.50, 0.62, 0.75, 0.87, 1.00, etc. Thus addition and subtraction of strengths with the dioptric system is infinitely more simple than with the old inch system. On the other hand, if we wish to add and subtract focal distances instead of powers it is sometimes simpler to do it in inches. In case of any such event occurring, it is well to be able to know how to change dioptric values into their equivalent inch values. This is a very simple process,

ly speaking, if you have one and want the other divide into 40.

These rules hold good while the new system of numbering has been employed, but to find the number of the old system corresponding to a given number of dioptries, 41.73 (instead of 39.37) must be divided by that number. The whole number 42 is usually employed in these cases. Thus a 2.00 dioptre reduced to the old system number would be a No. 21 inch, i. e.,  $42 \div 2$ ,

## Optical Department.

hereas by the new system a 2.00 dioptre equals a No. 20 inch, *i. e.*,  $40 \div 2$ .

Everybody capable of judging agreed that was absolutely necessary to abandon the system of numbering which was based upon the radius of curvature of the lenses, and that the metric system was the proper substitute, but some claimed that it would be better to write the focal distance, as the number of the lens instead of numbering it according to its refractive power. This claim is not tenable because the focal distance is virtually to be found expressed in meters in the numbers of the new system, because it is the inverse of the dioptric value; for instance, a 5.00 dioptre has a focal distance of one-fifth of a meter.

The accompanying table, arranged by Lantolt, shows the relative values of lenses numbered by the old and new systems. In these calculations the index of refraction was taken as 1.53, that of glass generally used in making spectacle lenses:

(To be continued.)

### Why Many Fail With the Skiascope.

THAT the results obtained with the shadow test do not always agree with the subjective findings cannot be denied. That there can be but one perfect correction must also be conceded; therefore, when two tests do not agree one at least must be wrong. That the subjective and objective tests are based upon some principles is well known. Why, then, do they disagree? This problem attracted the author's attention some time ago, and immediately investigations were instituted toward discovering why the skiascope did not give trustworthy results or, more definitely, why it showed high astigmatic errors wherein subsequent tests proved no such error to exist, and why, in cases where high astigmatic errors did exist, did it fail to disclose them?

Like many similar problems this has a simple solution, so ample, indeed, that it seems to have been studiously disregarded and more complicated solutions sought. For instance, some claim that false skiascopic findings are due to the irregularity of the retinal tissue; others that they were due to the fact that we did not refract the muscular region, and still others claim that such findings are due to our refracting at the optic disk, which has a natural, physiological depression, and so on.

These may be in part the cause of the trouble, but careful investigation showed that the chief source of error is due to the tilting of the crystalline lens while the eye is under test.

The general practice has been to direct the patient to look "just over my head" or "just past my right ear." This necessarily causes a decided tilting of the crystalline lens, and the closer the optometrist works the more marked is this tilting; because the eye must be turned at a greater angle to clear the operator's head. It is assumed that every optometrist knows that if a spherical lens be looked through obliquely or with the plane of the lens not at right angles to the line of vision, a cylindrical effect will be created.

With the patient looking over the top of his head, the author noted time and time again an "against" motion in the vertical meridian that required a 200 dioptre cylinder to neutralize, yet no astigmatic error could be uncovered subjectively, nor could its correction be tolerated; in these cases the horizontal meridian often showed a "with" motion. In other cases, with patient looking at a fixation object to the right or left of operator's head, a false astigmatic condition was noticed on the horizontal meridian. Thus the position of the error varied with the position of the patient's head. This gave the clue. With this in mind, when such a case presented itself, the skiascopic test was made with the patient looking at a small letter-chart attached to the mirror; the cross bracket mirror was the style used, and no such astigmatic findings were obtained. At the same time the test was made nearer the macula, which, while it causes a slight con-

are oblique use the dynamic test only. Thus, by testing horizontally when patient's eye is tilted vertically you avoid the cylindrical error, as this is confined to the vertical meridian, and this error is confined to the horizontal meridian, while the eye is turned to the side, so one is then safe in testing the vertical meridian. To attempt to correct both meridians with the eye fixed at one point is bound to result in error in one meridian, and herein lies one of the chief, if not the chief, cause of failure with the skiascope. E. L. R.

### The Health Ray Lens.

ILLUSTRATED below is a photo made with the best quality "Health Ray" lens and the regular spectacle lens. We know that when light strikes photographic paper-it turns it black. The right hand lens in spectacle frame is of regular glass, the left hand lens is of "Health Ray" glass, show-



PHOTOGRAPH SHOWING TOTAL TRANSMISSION OF LIGHT BY "HEALTH RAY" GLASS.

traction of the pupil, cannot be considered a hindrance to the skillful skiascopist, and the more reliable findings far outweigh any objections to this method; the contracted pupil also eliminates the peripheral area that forms a source of trouble in many instances.

If, however, the operator desires to use the static instead of the dynamic method, as above described, the patient must look off in the distance, and to so look must look either over the top or past the side of the operator's head. To practice skiascopy and avoid the mystifying cylindrical effects the author suggests the following rules be followed, these rules being the result of careful observation and having been tested and proven trustworthy in hundreds of cases: When employing the dynamic test have patient look at the chart on bracket mirror. When employing the static test, have patient look over your head while you test the horizontal meridian, but when you test the vertical meridian have patient look to your side on a level with his eye.

In cases where the principal meridians

ing that the latter transmits all the light, while the former or regular glass does not transmit it, thereby not affecting the paper to so great an extent.

The lower part of the illustration shows the result obtained with a block of regular glass (right), 35 mm. thick and a block of "Health Ray" glass (left) of the same thickness.

### Another Suggestion Offered for the Advancement of Optometry.

PATERSON, N. J., July 5, 1906.

Editor of THE JEWELERS' CIRCULAR—WEEKLY:

In reference to establishing a national academy of optometry, I would say that I am heartily in favor of anything that will tend to lift the refractionist and our profession to a higher plane. I am not familiar with the details for establishing the proposed academy and do not feel myself competent to suggest a plan for its organization.

Generally speaking, the optician or refractionist needs a better optical education. There should be some standard of education agreed upon and all optometrists should endeavor to work up to this point. A systematic course of study that the busy refractionist could take up at home would be appreciated by many who wish to increase their knowledge of optics and cannot leave their business. FRED H. HEWLETT.

## SAM'L BUCKLEY & Co.

100 William Street, New York.  
118-122 Holborn, E. C., London, Eng.

COMMISSION MERCHANTS.  
MANUFACTURERS' AGENTS.

Invite visiting buyers to avail themselves of the facilities afforded by their showroom at above address in which are exhibited English novelties of SHEFFIELD PLATED TRAYS, SILVER AND SILVER PLATE, TANTALUS SETS, WICKER BOTTLES, SILVER MOUNTED GLASS, POTTERY, GLASS, ETC.

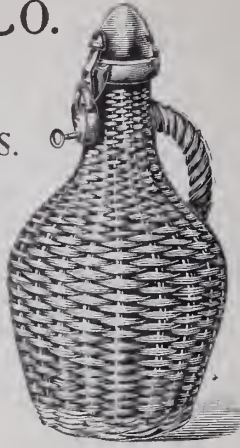
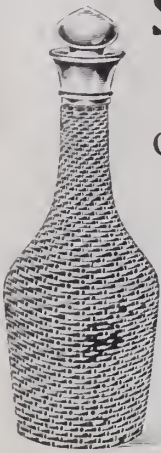

REN# 271107

## JAS. C. HOE'S SONS

10 Liberty Place  
Near Maiden Lane  
NEW YORK

Manufacturers of High  
Grade Wall Show Cases  
and Jewelers' Fixtures

INTERIOR REFITTING  
OF STORES and OFFICES  
A SPECIALTY

Write for Estimates  
Finest references given if desired

Established 1820

## “PERFECTION”

The diamond pointed lens drill that has proven itself, beyond question, the best lens drill on the market is patented. Made in three qualities and sizes.

X \$5.00. XX \$6.00 XXX \$7.00.

MENDES CUTTING FACTORIES

12-16 John St.

'Phone 6605 Cort.

NEW YORK,



A. Nonnenmann & J. Aschenbrenner,  
114-118 East 23d St., New York.

Original Designers for Platinum,  
Gold and Silver  
Jewelry. Artistic  
Designs for Silverware and Novelties  
furnished at shortest notice.

## Sessions Clocks

Superior finish. Reasonable prices.

Have you seen our

New and Exclusive Designs

in Mantel and Hanging Clocks?

Write for Catalog and supplement.

The Sessions Clock Co.

Main Office and Factories,  
Forestville, Connecticut, U. S. A.

New York Salesrooms,  
37 Maiden Lane.



Style 610.

Illustration 1/3 size.

(Pat. Aug. 1st, 1905.)

## Black Leather Smoking Set

Silver Plated Mountings—Gold Lined

TANKARDS, STEINS, MUGS, SMOKERS' ARTICLES,  
LOVING CUPS, FERN DISHES, PITCHERS, VASES,  
PUNCH BOWLS, Etc., in both

BLACK LEATHER and WEATHERED OAK

A complete line in our New York Office,  
25 WEST BROADWAY.

ST. LOUIS SILVER CO.

ST. LOUIS, U. S. A.





# RETAIL JEWELERS ADVERTISING

The use of this department is open to every retail jeweler and optician. Forward for criticism your newspaper ads., booklets, catalogues, novelties, circulars, etc. Ask advice and offer suggestions. Replies in these columns are unbiased. Make letters as full and particular as you desire. Every letter and ad. sent will receive full attention, though the publication of the matter may sometimes be delayed several weeks.

## How Shall I Begin to Advertise?

(Continued from issue of June 27.)

WHEN the head of a business is uncertain about his venture in advertising, and the different advertising representatives only make him more uncertain and confuse him, then there is only one thing to do. The most reliable, experienced and time-tested agency and service should be entrusted with the work. There is no safety short of this.

The amount of appropriation is usually the next vital concern. Here again the same conditions prevail. Advertising is the most terrible sinkhole that ever grew on the face of the earth. Nobody has ever yet filled it up.

Therefore it is of the most vital importance that an appropriation be made and spent in the light, not in the dark. What amount is the smallest with which to secure the largest proportion of results? How deep ought I to dip into advertising, to start off with? What will a good, vigorous, common sense campaign cost? These are questions of much importance which an advertiser asks and ponders over.

The truth is that an appropriation for advertising should not be made with the idea of appropriating, and then advertising up to it. That's wrong in principle. Lay out what will be the very best campaigning possible to do, and then figure on its cost. That amount ought to be the appropriation.

Too much emphasis cannot be placed on the need of enough money to push an adequate campaign. I don't mean a lot of money to make a big dash, but enough money to pay for what sound advertising judgment figures out as necessary for lasting and resultful success.

Every advertising campaign to be begun presents certain conditions to be met, certain things to be accomplished. There are so many possible customers to reach, there is this and that competition to meet, this and that resistance to offset. There are certain conditions of human nature to be considered, certain merchandising considerations to keep in mind—and there's your problem!

Now, what the advertising agency does is to use its experience and knowledge—the more it has, the more valuable its services are—and arrive at an estimate and outline of a plan which will meet every consideration. Copy, media, selling plan, all will conform to every consideration in a way to make the most of them.

But meantime the advertiser can figure out his own side of the matter, and keep his advertising on a solid basis. If he is

a mail order advertiser, he must figure out very closely just how much he can afford to pay for inquiries. That is, what sum must be the maximum that he can profitably pay for an inquiry. By figuring on turning one-fourth of his inquiries into orders he can get at this basis, by close reference to the margin of profit on his goods. He ought to do just the same thing that any other business house does with the sales department—he ought to know exactly how much he can afford to spend in selling his goods. When returns come in, all he need do is to divide the total cost of his advertising with the number of inquiries, and he will know exactly where he stands on the ledger. The gamble will be out of his proposition.

It is a sad mistake to crowd a mail order proposition into too little space. Larger space will nearly always bring in enough increase of inquiries to pay for it. But space should be no larger than necessary to tell a new story. Here is where the value of keen service comes in—a master of condensation can oftentimes cut down an ad a half, while actually heightening its effectiveness.

The general advertiser has no better criterion to settle on the amount of appropriation than to figure out what percentage he can afford. And in making this judgment, he ought to remember that advertising has as much sound claim for as the sales department costs, even more. The modern idea is to combine both as properly coming under one selling expense, and to divide at least equally.

There are a vast number of manufacturers who ought to advertise, and who know it, and desire to do so, but are holding off because they don't see where they're coming out exactly, and have dubious feelings of uncertainty about objections the dealers might raise and other trade conditions.

The bull's-eye of advice to those who want to know how to begin to advertise is to go at it in a thoroughly business-like way and put the keenest brains and experience possible to secure into the copy, follow-up and campaigning; and to keep a keen business eye on everything that is done, so that the campaign won't run away with you and land you in a ditch.

[THE END.]

Edward Delano, who, about 20 years ago, was engaged in business in Watertown, N. Y., on the application of George H. Fenner, his trustee, was recently examined as to his sanity and subsequently committed to the St. Lawrence State Hospital.

## Recent Booklets and Folders.

“SUGGESTIONS for Wedding Gifts in Cut Glass and Silver” is the title of a booklet, 4½ by 8¼ inches, issued by Ambrose Kent & Sons, Ltd., Toronto, Ont. The cover pages are printed in blue and silver; the inside pages are lettered A, B, C, etc., instead of being numbered. The half-tones of appropriate wedding gifts, including brooches, scarf pins, wedding rings, miscellaneous silverware and cut glass articles are printed in light brown. The price is printed in black under each article.

\* \* \*

Henry Birks & Sons, Montreal, Ottawa and Winnipeg, have recently issued two tastefully designed folders, which, at first glance, look more like booklets. One is called “Communion Silver” and contains prices and illustrations of memorial gifts, such as may be given to a church in memory of a departed relative or pastor. It measures 6½ by 5½ inches, the cover pages being an ecclesiastical purple. The front cover page is set off with a red border with silver interspacing. The title is printed in red in the center, with the firm name in silver, in the lower left-hand corner. The make-up of the three inside pages is strictly rubrical, the type being ecclesiastical and the printing red and black. The other folder mentioned above is designed to appeal to first communicants. It is 7¼ by 3 inches and contains three pages of attractive half-tones portraying crosses, crucifixes, rosaries, holy medals and watches. The text is written in French, the color scheme of the cover pages being similar to the foregoing—red and purple. The title, “Cadeaux de première communion,” is centered under a red cross.

## What Some Jewelers Say.

SPECIAL silver for wedding gifts.—Our line of silverware in the plated goods is made especially for us. Every piece receives at least one-fourth heavier plating than any other make of plated ware. It is the most beautiful and durable plated ware ever made. In sterling solid silver we have a choice selection. H. Poppendick, Columbus, O.

Jewelry of the highest grade is here in great variety. We firmly believe we have gathered together the choicest collection of watches and jewelry ever assembled under one roof. Rings and brooches in exquisite designs; some are set with stones of unusual brilliance. Fine repairing satisfactorily done. J. S. James, Richmond, Va.

Diamonds and other gems.—Our prices are based on actual worth, and when quality is considered, they are the lowest. All correspondence given careful attention. Goods sent on approval, express prepaid. Galt & Bro., Washington, D. C.

Watches.—A good watch—one that can be relied upon—is a satisfaction and a necessity to every progressive up-to-date person. If you desire a good timepiece, please give me a chance to show you my stock and talk the matter over with you. Watches and jewelry repaired. All my work is guaranteed. Do you realize what a saving in expense this means to you? Do you? R. A. Horn, Walla Walla, Wash.



That this department shall prove mutually beneficial to our readers, it is desirable that the members of the trade generally communicate with THE JEWELERS' CIRCULAR-WEEKLY regarding any advantageous device or plan which they are utilizing in connection with their business.

### An Ingenious Novelty for the Effective Display of Jewelry.

ILLUSTRATED herewith is a simple, practical novelty in the way of window dressing of but trifling cost. It opens a wide field to ingenuity and taste by the exercise

dark blue, and articles, such as brooches, badges, charms, rings (singly or in boxes), lockets, in brief, anything of small size, are to be placed, or when necessary, hung in the openings, for which purpose ordinary pins are sufficient.

With these "Decorators" such designs as

### A Business Talk to Salesmen.

(By W. N. AUBUCHON, in *AdSense*.)  
(Continued from issue of April 25.)

**J**UMPING from conclusions is like sliding off the top of a haystack before taking a look around to see where Dad left the pitchfork. You are pretty darn sure to hit it if it's anywhere around, and will get a jab that brings you to a realization of the fact that a little careful investigation before you jump anywhere, is just ordinary common sense.

Look your creditor in the eye and shake hands with your competitor. Don't snarl and don't snarl. Hold your head up, draw in deep breaths of God's oxygen, feel rich and important, be to-day in imagination what you desire to be next year, and you will reach your goal in reality, if you walk in the middle of the road and step along vigorously and with courage.

Preach good and you can reach good. There's always trade enough in sight for the man whose voice is heard in the land and his trade arm will go out as far as his voice will carry conviction.

In salesmanship use pleasant names for disagreeable things—avoid words that are disfigured by the "bar sinister" of tainted association. Never "cut" a price, but make a "special." Do not "knock" a competitor's goods, merely "comment" upon them. Do not "instruct" a salesman, just "suggest" the point—for an ill-smelling flower does take on a sweeter odor with another name—by the law of mental concepts.

Strike often and strike hard, but use a musical hammer—in salesmanship or advertising. There's much in the force of it, but more in the harmony of it after all. Discordant sounds irritate the nerve centers of inclination and drive away the expectant and disappointed audience.

Be square with your trade and you can bid defiance to the attacks of the cavalry of competition. It may drive at you and seek to capture, but will meet defeat on the bristling points of your integrity.

Say what you mean, and say truly if you want to build a business of the kind which will weather the storms of opposition that are sure to come sooner or later.

If you do the same thing that everybody does in the same way you make small impression in the world of business. You must get a little originality and snap into your methods to secure more than passing notice. Be awkward, if you must, but make

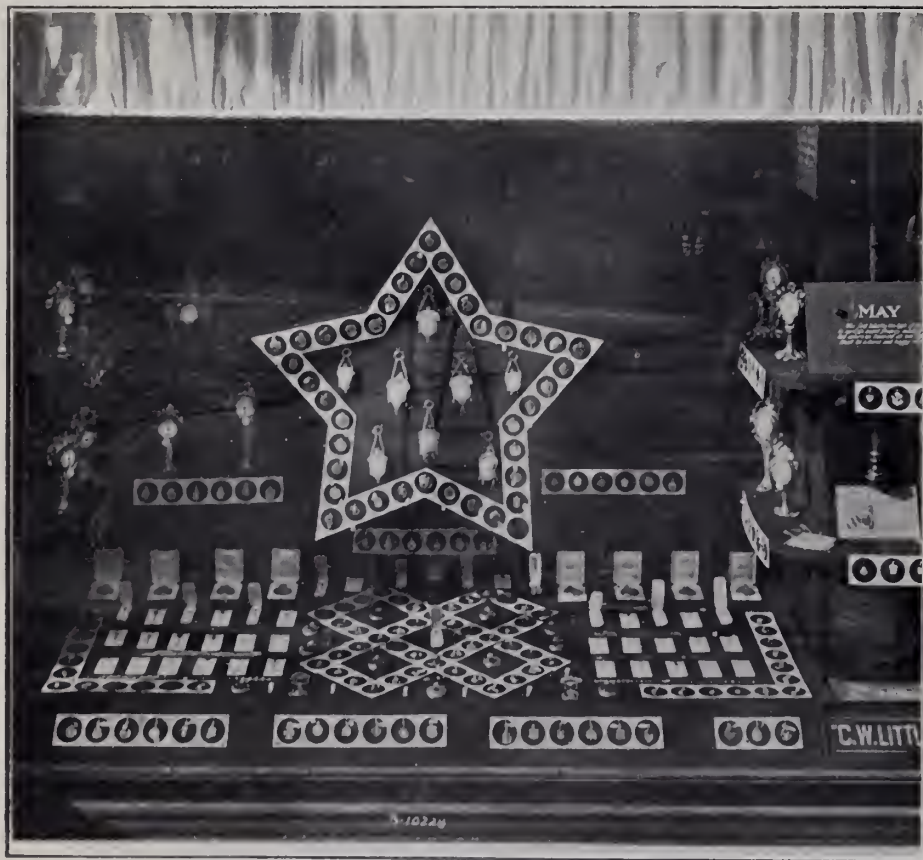

AN ATTRACTIVE WINDOW DISPLAY MADE AT NOMINAL COST.

of which an endless variety of novel and beautiful designs may be exhibited in the show windows, and attention directed to an indefinite number of small articles in a manner that cannot escape the notice of the most indifferent passerby.

The designs are made of cardboard strips two and one-fourth inches wide. These strips may be had in various lengths. On the back of the strips are pasted colored crepe or plain paper, as desired.

These strips are intended to be used with a dark background, preferably black or very

maltese, Latin and Teutonic crosses, diamonds, squares, stars, etc., can be constructed, or they can be used as horizontal or vertical strips, as borders to shelves or in countless ways that will, as already intimated, suggest themselves to the ingenious and tasteful window dresser.

The two windows illustrated herewith were fully dressed, as shown, at a total expense of \$3.

Mrs. E. E. Roberts, Falls City, Nebr., intends to sell out.

## Storekeeping Department.

the gong sound loud enough to make heads turn in your direction.

I think the best diplomacy is the kind that comes out in the open and says: "Here are the goods, look at them. This is the price, hear it." All revealed, nothing concealed, and "the d—I take the hindmost"

[THE END.]

### Side Lines For Jewelers.

(By N. NIELSON, Harlan, Ia., Vice-President Iowa Retail Jewelers' Association, before the latter's recent convention in Des Moines, Ia.)

IN taking up this subject I will say that this paper will treat the question of side lines mainly from the country jeweler's point of view. My experience has been chiefly in conducting a business of my own in an Iowa town of medium size, and consequently I will naturally look at it in the light of what my experience has taught me in the years I have been doing business and built up my trade. Experience is the best teacher, they say, and, if such is the case, I shall try to give a short description of what I have found out in regard to side lines I have handled.

If my little sketch should not happen to apply to our brother city jeweler, I hope he will excuse me for taking up a few minutes of valuable time. Conditions for handling side lines are entirely different in the city from what they are in the smaller towns, and the rules that apply to one do not always apply to the other. From personal observation I have come to the conclusion that side lines are not handled as extensively by the city jeweler, and in trying to reason out why such is the case I decided that there were good reasons, at least, from the outsider's point of view. One of the main reasons, without question, is that it takes a city to furnish sufficient trade to support the exclusive one-line stores in certain lines of goods or lines that can be handled with advantage in a jewelry store. In a city large enough to justify the one line stores, they will do the business and prosper, if the right man is back of it.

In the smaller towns, the same conditions do not prevail. Lines of goods that are sold in the city in an exclusively one-line store and sold in quantities to make money could not possibly be marketed that way in smaller towns on account of the limited demand for those certain lines, and here is where the jeweler comes in. He can market those lines with better success than any other merchant.

In giving my views and experiences on this subject I will assume that I am talking to jewelers who are not now handling side lines, but who may possibly do so soon. I take this way of going at it for the reason that the man with the side lines may not need any information in regard to this subject; in fact, he may have had a great deal more experience than I have, and we will admit that experience certainly is the best teacher even if it is a little costly sometimes. We will assume that you have built up your trade in the regular jewelry line.

In looking around the store you find

that by changing the arrangement of your goods you have some extra space. This extra space will hold either more goods in the regular line, or you can add a side line. Now, which will it be—which will bring the best profit? These are the questions to answer. If you asked me these questions, I would answer this way, provided you are now carrying enough stock so that an addition would only benefit your trade slightly and your trade being established on a good paying basis in the jewelry, you can add a side line and make it pay you a fair profit, which will practically be extra and at the end of the year will show you as the gainer, provided you do not neglect your regular line.

Now, having established the fact in your mind that you will add a side line because you have the extra space to display it, and also that if properly managed it will pay

try. First of all, I will mention cut glass and china, the hand-painted kind of china. You may say that they are not side lines any more because they are now sold by almost every jeweler in the country, but I mention these lines particularly for the reason that there are jewelers that do not handle either line yet, and in a case of this kind, these lines most assuredly ought to be the first consideration, for we have no other lines that will show up to better advantage in a jewelry store than these and consequently they will sell better in a jewelry store than in any other store.

The following lines are all good money-makers if properly displayed, advertised as they should be, and handled with intelligence: Cameras, and supplies for same, photographs, small stringed instruments, sewing machines, stationery. I consider these the main and leading lines for

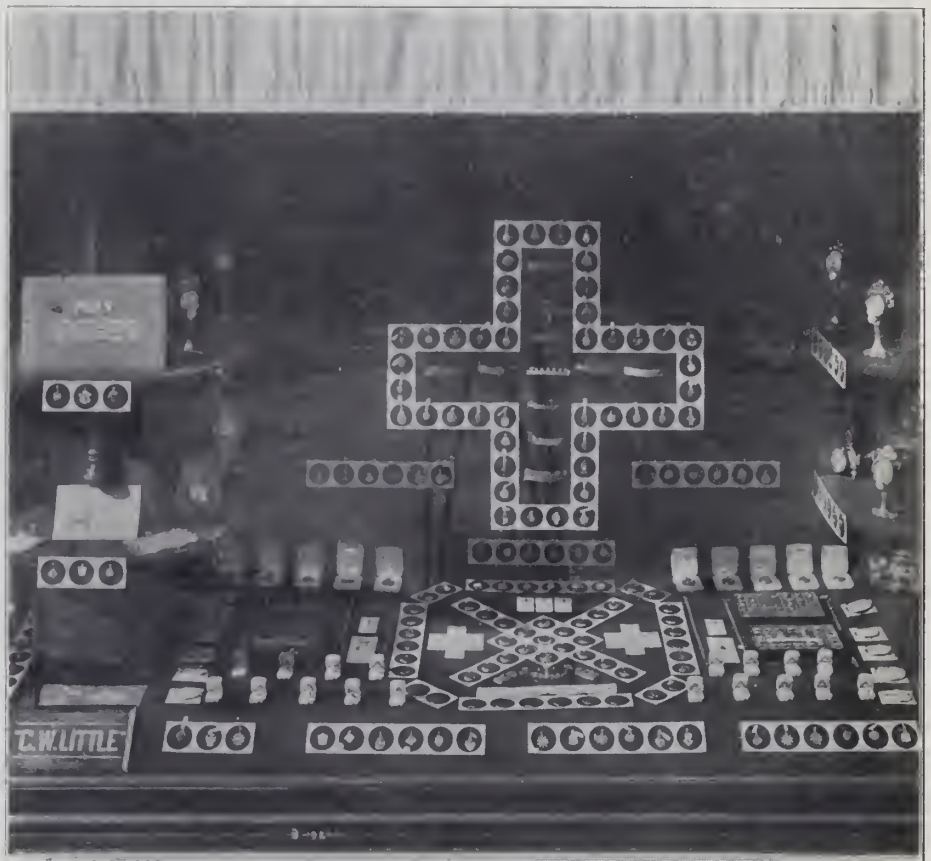

ANOTHER NEAT DISPLAY WELL CALCULATED TO ATTRACT ATTENTION.

you a profit, then the questions will be what lines are suitable for jewelers, which line will be the most profitable, the best seller; numerous other questions will also come up in your mind. For profits and also for sales I would decide on a line that would give the least competition, for one may overdo a thing. Therefore leave alone lines that are already well represented in your city, select the line that will give you the least competition and at the same time give you promise of good demand, good interest on money invested and a line that will display well and not detract from the appearance of your store.

I consider the following lines splendid for jewelers, every one of which has been sold with great success all over the coun-

try. First of all, I will mention cut glass and china, the hand-painted kind of china. You may say that they are not side lines any more because they are now sold by almost every jeweler in the country, but I mention these lines particularly for the reason that there are jewelers that do not handle either line yet, and in a case of this kind, these lines most assuredly ought to be the first consideration, for we have no other lines that will show up to better advantage in a jewelry store than these and consequently they will sell better in a jewelry store than in any other store.

(To be continued.)

J. O. Warren has purchased the bankrupt stock of the Colgate Jewelry Co., 205 N. 2d St., Muskogee, Okla.

What Tool is of More Importance to THE MAKERS OF FINE JEWELRY than

A FIRST CLASS SAW ?

SHARP—TRUE—UNIFORM  
—PERFECTLY TEMPERED



TRADE  
**ONLY**  
**THE BEST**  
ARE  
GOOD  
ENOUGH  
MARK



Such is the **ZEUNER SAW.**

TRY THEM, for "Only the Best are Good Enough," and only the Best are Cheap. Trial orders promptly filled under guarantee of perfect satisfaction, which applies also to our "AMERICAN SWISS FILES."

**E. P. REICHELME & CO.,** 23 JOHN STREET, NEW YORK.

**THE REMINGTON RING EXPANDER.**

The most useful implement a jeweler can own.

PRICE \$7.00 NICKEL PLATED INCLUDING A STEP MANDREL AND EIGHT ROLLS

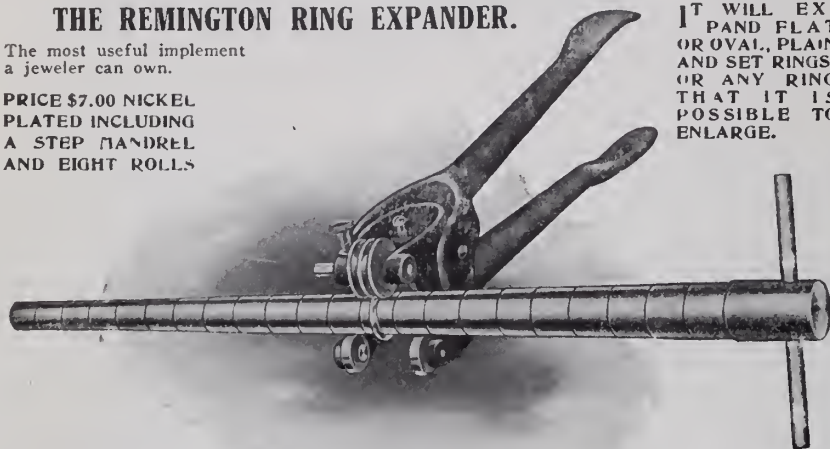

IT WILL EXPAND FLAT OR OVAL, PLAIN AND SET RINGS, OR ANY RING THAT IT IS POSSIBLE TO ENLARGE.

IF YOUR JOBBER CANNOT SUPPLY YOU WRITE TO US DIRECT.

**SPECIAL FEATURES OF THE REMINGTON RING EXPANDER.**

A MANDREL WITH STEPS SQUARED and 1/2 size variation is used to prevent tapering of the ring. THE FOUR SMALL ROLLS ON THE LOWER JAW OF THE TOOL (see cut) PREVENT FRICTION, and make it possible to use any amount of pressure WITHOUT ROUGHING THE MANDREL. THE PRESSURE IS CONTROLLED BY THE HAND and it is not necessary to use a vise or other implement when operating the REMINGTON.

Manufacturers of Patent Tools and Machinery.

**NOVELTY ENGINEERING ASSOCIATION,** FITCHBURG, MASS.

**LEIMAN'S NEW SAND BLAST.**

SIMPLE. EFFECTIVE. ECONOMICAL.

**NEW FEATURES**—Let us tell you about them.  
**RESULTS**—Let us show you samples of work done.

**Improved High Pressure Blower**

NOISELESS. INEXPENSIVE.

Delivers Greater Volume at Higher Pressure Than Any Other Made.

**LEIMAN BROS.,**

Jewelers', Silversmiths' and Metal Workers' Machinery, Tools and WORK BENCHES,

141 Centre Street, NEW YORK.

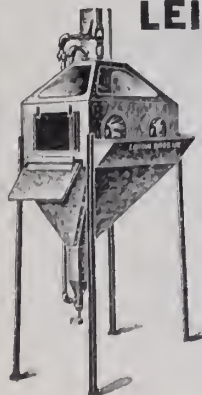

PATENTED.

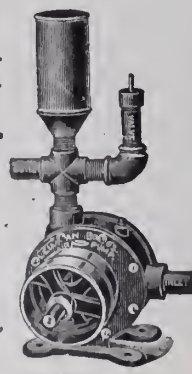

PATENTED.

**OUR ELECTRO-PLATING SALTS**

when dissolved in water make a plating solution at once ready for work and of always correct shades. Know that we are the originators and manufacturers of the Dark Green Gold Salts (Antique) and other Shades of Green.

Likewise the Rose and Orange Rose Gold Salts used for single and double gilding, and of a good many other shades now on the market.

Our Roman Gold Salts produce an almost bright deposit, requiring little or no scratch brushing.

French Grey, 11 or 12 Kt. gold, Old English gold, Silver Rhonizer, in fact any shade wanted, can be had of us. Write for circular.

Our Automatic Electro Plating Machine specially designed for the small manufacturing and the retail Jeweler, will be of interest to them. Send for Pamphlet.

**U.S. ELECTRO-CHEMICAL CO.** H. Hirschbach, Prop., 80 Elm Street, New York



**GLARDONS' SWISS FILES**

are the HIGHEST STANDARD of Excellence.

We are Sole Agents for the United States and Canada.

**F. W. Gesswein Company,**

Established 1868. Incorporated 1896.

WILLIAM DIXON, PRES.  
Dealers in Fine Tools and Supplies.

39 John Street, New York.

**SIGNS**

OF all materials, engraved brass, sawed metal letters, carved wood, glass, etc. Electric signs for day or night.

"No trouble to ship out of town."

**THE FORMAN CO.**  
SIX LIBERTY PLACE  
NEAR MAIDEN LANE ··· NEW YORK

"PRACTICAL COURSE IN ADJUSTING."  
Price, \$2.50.

All Jobbers or Jewelers' Circular Publishing Co.

**ROLLED GOLD PLATE SEAMLESS WIRE AND TUBING**

**DUNBAR, LEACH, GARNER CO.,**  
MANUFACTURERS,

ATTLEBORO, MASS.



[Answers are also solicited from our readers to the questions published on this page.]

**QUESTION No. 1603.—Cement for Glass.**  
—One of my customers brought in a glass water pitcher which was broken by a fall. I have tried all kinds of glass and china cement; then I let it set for 10 or 12 hours; next I filled it with water. In a short time however, it broke apart. Please tell me what I should use in this case. B. & S.

**ANSWER:**—It is always well not to expose broken glass which has been mended by cement to hot or boiling water, as this will sometimes crack a perfectly sound glass vessel. The best cement is prepared as follows: Soak two drachms of cut sm-glass in two ounces of water for 24 hours; boil down to one ounce, add one ounce of spirits of wine and strain through linen. Mix this while hot with a solution of one drachm of mastie in one ounce of rectified spirits, and triturate thoroughly with one-half a drachm of powdered gum ammoniac.

**QUESTION No. 1604.—Blanching Process for Silver Articles.**—Please describe to me what the blanching process is. I understand it is extensively used by silver manufacturers in Europe. B. P. S.

**ANSWER:**—The *Metal Arbeiter*, Vienna, recently described the blanching process as follows: "If the silver were absolutely pure, it would not be changed even by red heat, as the silver has no tendency to oxidize. But since, on account of its softness, it is always alloyed with copper, a film of copper oxide appears when it is heated. If the silver thus coated is now heated in dilute sulphuric acid, the copper oxide is dissolved and the pure metal is brought out. This method is also used for bringing more silver to the surface of silverware, and giving it a purer white color. The article is brought to red heat in the air, whereby the copper of the surface is burned to copper oxide, through the action of sulphuric acid. The surface will be left with more silver than the rest of the alloy."

**QUESTION No. 1605.—To Drill Glass.**—How can I drill holes through glass? D. R.

**ANSWER:**—Make a solution of one ounce gum camphor, one and a half ounces spirits of turpentine and three drachms of ether. Keep the end of the drill tool wet with this fluid. The sharp corner of a freshly broken point of a file is one of the best drilling tools for this purpose.

**QUESTION No. 1606.—Hard and Soft Soldering.**—Please tell me if hard soldering may be done as easily as soft soldering? A. J. Q.

**ANSWER:**—There is little difference in the common acceptance of the terms; hard soldering requires that the parts to be soldered be submitted to red heat, while soft soldering may be done at a heat which is generated by a common alcohol lamp without the assistance of charcoal heat. Various

compounds of soft metals, such as Britannia metal, for instance, may be soldered by a special process, which is neither hard nor soft soldering, but to solder jewelry by such or a similar process is out of the question.

**QUESTION No. 1607.—Magnifying Glass for Igniting.**—Will you kindly tell me if you can smelt glass or make metal red hot through a large magnifying glass; if so, what size would be necessary and where can I get one? S. M. C.

**ANSWER:**—No magnifying glass can produce a degree of heat as intense as that of which you speak.

**QUESTION No. 1608.—Renovating Bronze and Gilt Pieces.**—In our jewelry store we always have some pieces that need renovating, such as gilt statues, gilded clocks and also bronze articles. We would thank you for a few formulas for renovating the above line of ware. B. B. & G.

**ANSWER:**—(1) For gilt work, first remove all grease, dust, wax, etc., with a solution of potassium or sodium hydrate; then dry and with a soft cloth apply the following: Sodium carbonate, seven parts; Spanish whiting, 15 parts; alcohol, 50 parts; water, 125 parts. Go over every part carefully, using a brush to get into the minute crevices. When this dries on, brush off with a fine linen cloth or a good chamois skin. (2) Remove grease, etc., as directed above, dry and go over the spots where the gilt surface is discolored with a pencil dipped in a solution of two parts of alum and 250 parts of water, carrying 65 parts of nitric acid. As soon as the gilding reappears or the surface becomes bright wash off, and dry in the direct sunlight. (3) Still another cleaner is made of nitric acid, 30 parts; aluminum sulphate, four parts; distilled or rain water, 125 parts. Clean off grease, etc., as above, and apply the solution with a camel's hair pencil; rinse off and dry in sawdust. Finally, some articles are best cleaned by immersion in hot soap suds and rubbing with a soft brush. Rinse in clear hot water, using a soft brush to get residual suds out of crevices, let dry, then finish by rubbing the gilt spots or places with a soft linen cloth, or a bit of chamois. There are some bronzes gilt with imitation gold and varnished. Where the gold is well done and the gilding has not been on too long, the most practical eye will sometimes be deceived. The deception, however, may easily be detected by touching a spot on the gilt surface with a glass rod dipped in a solution of corrosive sublimate. If the gilding is true no discoloration will occur, but if false a brown spot will make its appearance.

### Mode of Preparing Silver for the Application of Red Enamel.

TORONTO, Ont., July 3, 1906.

Editor THE JEWELERS' CIRCULAR—WEEKLY:

We are very successful with the metal enameling, but so far are not satisfied with our silver goods. It may be that we have not yet found a good pigeon-blood red, or ruby red. Ours is a faded red, or a little brown. A. H. W.

**ANSWER:**—The difficulty of getting a good red on silver is explained, not by the fact that a good silver red is hard to find, but rather by the fact that few people know how to prepare silver for enameling. The oxides of metals color enamel. Silver oxide colors enamel yellow, and one form of silver will make enamel opaque. So, in order to get the best results, the silver must be perfectly clean.

The usual method of preparing a silver article is by boiling it in a sulphuric pickle. In enameling an article treated in this manner the red will be a semi-opaque brown. We have three remedies for overcoming this. One is to "bright cut" or "wriggle" with a flat graver the surface to be enameled. Remove all of the pickle coating, dissolve the engravers' cement in alcohol, or, still better, don't use any at all. Then carefully heat the article until it turns a straw color when cool. Most any red enamel will answer, one of purple cast being preferable.

Another way to prepare silver is by stripping. This can be accomplished by different methods—by using the silver as an anode in a silver plating solution, or by dipping it in a solution of 1 part of distilled water and 2 parts of chemically pure nitric acid. In either case the article should be kept in motion while in the solutions, rinsed occasionally in clean water and scratch-brushed either in the regular way or with a stiff bristle hand brush with sand and water. The acid solution will rot German silver joints and catches.

The best method is to start with sterling or coin silver that you know is composed of pure copper and silver. Don't pickle the silver or, if it has already been pickled, scrape or file the side to be enameled; work it into shape and, after soldering and annealing have been completed, place the article in a cold nitric acid pickle, using C. P. nitric acid. Brush well with a stiff bristle brush, using sand and water, after which dip in the nitric acid stripping solution; clean again and heat until the straw color appears. A piece of silver is properly prepared for red enamel when, after having been heated red-hot, it will turn black when cold.

Oxide of silver colors enamel yellow, and hence, if in firing a silver piece a slow heat is used, the surface under the ground enamel will have a chance to oxidize and the result will be brown—the combination of red and yellow. Or, if there are a number of colors on a piece of silver work which necessitates several firings, the red is liable to be brown. In order to get a "purple cast" red, have the silver so clean that it will color like polished steel when heated. Anneal it to a straw color. Fire in a hot muffle or at a quick heat and do not fire the red any more than is necessary.

**C. DORFLINGER & SONS,**

36 MURRAY STREET, NEW YORK.

*Works, White Mills, Wayne Co., Penna.*

Manufacturers of plain and cut Table Glassware of the highest quality.



**ENGLISH :: GLASS.**

Large Assortment of FANCY VASES, GENTRE PIEGES and ROCK CRYSTAL STEM WARE,

Particularly adapted for the Jewelry Trade. Write for particulars.

Sole Agent for the Celebrated CAULDON CHINA.

**EDWARD BOOTE,**  
46 West Broadway :: New York.

**Have You Received Our New Catalog?**

**Maple City Glass Co.,**  
CUT GLASS TABLEWARE,  
Hawley, Pa.

SALESROOMS:

- New York—H. B. Stiles, 253 Broadway.
- Baltimore—Green & Thomas, 33 S. Charles St.
- Boston—Sweetser-Bennett Co., 101 Tremont St.
- Buffalo—J. R. Stadlinger, 685 Main St.
- Indianapolis—J. A. Dugan Co., 22 S. Capitol Ave.
- Duluth—Duluth Crockery Co., 6th Ave. and West St.
- Denver—Western Selling Co., 1617 Lawrence St.



**FANS**

Headquarters for the most exclusive line in this country.

SPECIALY DESIGNED FOR THE FINE JEWELRY TRADE

**NECKLACES**

Imitation Pearl and Fancy Bead, in all newest shades and exquisite colorings. Write for Samples, mentioning price.

**LOUIS STEINER, Importer,** 520 & 522 Broadway NEW YORK



**"Cantlose"**

THE NEW EYEGGLASS HOLDER

Practical Simple Safe Secure

Positively prevents loss of Glasses from Hook. The feature of this Hook is a "Hump" engaged by a "Loop," making a secure connection.

For Sale by Leading Optical Dealers  
**PAUL GOUGELMAN, Mfr.**  
37-39 Maiden Lane, New York City

Established 1870.

Manufacturer of

**LOUIS W. HRABA,**  **Fine Leather Goods,**

29 East 19th St., New York.

Exclusively for the Jewelry Trade.

**JACOT MUSIC BOX CO.,**  
IMPORTERS.

Stella and Ideal Music Boxes.  
39 UNION SQUARE, N. Y.

**C**LOCKS, BRONZES  
COMMUNITY SILVER  
CUT GLASS, NOVELTIES

SEND FOR CATALOGUE

**H. BEALMEAR & CO.**  
234-236 Park Ave.  
Baltimore, Md.

# THE CONNOISSEUR

*Devoted to Art Pottery, China, Marbles, Bronzes, Cut and Decorated Glass Ware, Bric-à-Brac, Lamps, Art Metal Wares, Fancy Goods and Kindred Lines.*



## An Interesting Exhibition of Doulton Pottery at London, England.

**D**OULTON & CO. recently gave an exhibition of new effects in pottery in the New Dudley Gallery, London, and the visitors found much to admire among the 600 pieces from the works at Lambeth and Burslem. As the company sends a considerable part of its output to New York, there will be interest in its new lines, regarding which the *Pottery Gazette* says:

"Speaking generally, the work from Lambeth is on a stoneware basis and that from Burslem on earthen ware and china. Very different methods are employed at the two studios, and as the bodies of the wares manipulated are diverse, the effects produced are as dissimilar as possible. But we are introduced to new effects in both.

"The development in the artistic ornamentation of the two classes of ware is very marked. Chemical investigation has enabled the Lambeth artists to produce brighter schemes of color than could the old stone ware workers. The evolution of what is now called 'Lambeth Faience' has been interesting and rapid. Though the firm of Doulton was founded in the early years of the 19th century, no definite attempts to produce anything artistic were made until 1867 and 1871, when small collections of very simply treated salt-glazed vases were shown at exhibitions in those years. These were so favorably received that Henry Doulton (afterwards Sir Henry), the then head of the firm, was induced to found an art section of the works. In this he was assisted by J. C. L. Sparks, master of the Lambeth School of Art and a staff of artists, with George Tinworth as modeler.

"There was no tradition of art to follow at Lambeth. The methods of work had to be invented; clays and colors had to be found and tested, and special kilns had to be constructed to suit the new work. So that 35 years before the committee of the Technical Education Board, of London, denounced our pottery manufacturers as being ignorant of chemistry, a manufacturer at Lambeth had invented (and has since perfected) the salt-glaze decoration of pottery as the result of his chemical research. The new effects in salt-glaze ornamental ware are represented by the fine group of vases, etc. The examples exhibited of the artistic treatment of Lambeth stone ware are creditable to the chemist and the art potter.

"The exhibits supplied by the Burslem artists show the greater possibilities in artistic decoration on a white body, and they illustrate very emphatically the perfection attained in the treatment of the *rouge flambe*, and crystalline glazes. The first of

these exhibits striking and novel results of great beauty. The long sustained efforts to rediscover the secrets of the old Chinese *flambe* have been rewarded by a close approximation to the original results if the methods of securing it have been different. But it is believed that the method now employed is identical with that of the old Chinese. Still, its rediscovery entitles it to be described as a new effect.

"The coloring oxide is copper, which under different conditions of firing produces very different results, the hues varying from blood-red to blue. This blood-red—one of the most marvelous colors ever applied to pottery—was seen to great advantage on a beautiful flower pot. It is a charming rich decoration, with a landscape introduced in subdued tones. An interesting exhibit at the end of one of the sections was a group of vases and useful articles, with silver and copper mounts, by "The Potteries Cripples' Guild," of which the Duchess of Sutherland is patroness.

"One of the most interesting of the new effects shown is two crystalline glazes. These are new only in their developed form, for crystallization was produced—though unintentionally—long ago. Then it was due to accidental, defective glazing; now it is the intended result of perfect glazes; so that what was once only an occasional effect is now the intended result of well-considered design. But even now there is a limit to the certainty of result, because these glazes change color capriciously if, in the process of firing, they are subjected to different temperatures. It is thus evident that, although, with the scientific care now bestowed on firing, intended results may generally be secured, 'new effects'—and probably beautiful ones—are likely to be sprung upon the manufacturers at any time.

"A particularly fine specimen of crystalline is the almost globular vase, the glaze on which is broken up into regular fine lines from the top toward the base, which appear to follow the natural flow of the melted glaze. In this piece the fine glazed lines are so uniform as to suggest that they may have been applied by the pencil of the artist. We may, however, be sure that if Messrs. Doulton could repeat this disposition of the crystalline glaze they would do so. As it is, the effect on this piece is unique. A duplicate of this form may be treated with a very similar crystalline ornamentation, but the process of production precludes the possibility of any two pieces being identical. A number of artistically painted china vases show the versatility of the Burslem painters; flowers and figure subjects were presented in great and charming variety."

## Recent Reappraisements of White and Decorated China.

**T**HE following reappraisements of decorated china and similar lines were announced recently by the Board of United States General Appraisers, New York:

Decorated china from Chieppe & Barbarin, and Gustav Balleroy, Limoges, exported Sept. 2, 1905, to Feb. 24, 1906, entered at New York (File Nos. 3,568 and 39094/95); findings of Board No. 2: Prices as published in reappraisal No. 6940, May 2, 1906, and No. 6939, May 2, 1906. Reappraised value affirmed.

White and decorated china from Porzellanfabrik Schonwald, Sonberg, exported April 10, 1906, entered at Newport News (File No. 39796); findings of Waite, G. A.: Tassen, 6012, white, entered at 12, advanced to 15 marks per gross; do., 6011, entered at 1080 marks per gross, advanced to 12 marks per gross. Discount, 5 per cent. Add 10 per cent. From Porzellanfabrik Mischendorf: Tassen, 1066, decorated, entered at 1.85, advanced to 2.05 marks per dozen; do., 1065, entered at 2, advanced to 2.25 marks per dozen. Discount, 8 and 2 per cent. Further advanced by addition of 10 per cent. verbandsauslag. Add cases, etc., on all.

Decorated china from Insam & Prinoth, Nurnberg, exported Feb. 2 and March 17, 1905, entered at New York (File Nos. 39178 and 39580); findings of Waite, G. A.: Figures, 3475, 3549, 1920, 3474 and 3588, entered at 4.75, advanced to 5.75 marks per gross. Add cases and packing.

Decorated china from Altrohl, Porz. Fabriken, mark 1724, Bodenbach, exported Jan. 9, 1906, entered at New York (File No. 38386); findings of Waite, G. A.: Plates, 2149-3, entered at 3.20, reappraised at 3.93 crowns per dozen. To entered value add 10 per cent. Discount, 2 per cent. Reappraised value is net. Add cases.

Decorated china from Gebr. Benedict, mark 7067, Bodenbach, exported Sept. 18, 1905, to Nov. 18, 1905, entered at New York (File Nos. 36929, 37062, 37233, 37512, 37556 and 37886); findings of Waite, G. A.: Dinner sets, 100 pieces, 853, entered at 19.32, advanced to 21.32 crowns per set; do., 851, entered at 21.57, advanced to 22.57 crowns per set; vases, 864, entered at 3.25, advanced to 3.75 crowns each; do., 863, entered at 2.60, advanced to 3 crowns each; do., 862, entered at 2, advanced to 2.30 crowns each; plates, 854, entered at 2.45, advanced to 2.75 crowns per dozen; do., 854-2, entered at 3.35, advanced to 3.80 crowns per dozen. And similar goods. Discount, 2 per cent. Add cases.

Decorated china from Ludwig Engel & Son, mark 7129, Bodenbach, exported Sept. 28, 1905, entered at New York (File No. 36905); findings of Waite, G. A.: Dinner sets, 102 pieces, 3835 and 6547/51, entered at 27.90, advanced to 30.40 crowns each. Discount, 2 per cent. Add cases.

Decorated china from Pfeiffer & Lowenstein, mark 7581, exported from Bodenbach, March 16 to April 6, 1906, entered at New York (File Nos. 39469 and 39793); findings of Waite, G. A.: Dinner sets, 100 pieces, 216/2386, entered at 33.29 crowns per set; do., 4260, entered at 36.75 crowns per set. Discount, 9.1 per cent. and 3 per cent. Add 10 per cent. Add cases. No advance.

Decorated china from Retsch & Co., mark 1666, Wunsiedel, exported Feb. 23 to March 29, 1906, entered at New York (File Nos. 39336, 39470 and 39638); findings of Waite, G. A.: Salads, 3549, entered at 2.75, advanced to 3.25 marks per dozen. Add 10 per cent. Less 7 per cent. Add cases.

G. Backus has purchased the store of Otto Wiederanders, Gathenburg, Nebr.



No Springs  
No Screws  
CAN BE PUT  
IN A TRUNK

THE PERFECT SHAPE UMBRELLA

**"MAIDEN BALTIMORE"**

IT IS now nearing the time when Jewelers are looking toward purchasing their stocks for the Fall and Holiday seasons in Umbrellas and Canes. We are prepared with our line, which we have specially designed for the Jewelry Trade. It consists of rare novelties, and things entirely new and exclusive.

Our Detachable Handle Umbrella has met with great favor, and will increase your Umbrella Business, as it is the only

one on the market without levers, springs or screws.

We make Umbrellas from \$1.50, with Sterling Silver and Gold Handles, up to \$125.00 each, and Canes from 50 cents up to \$25.00 each. *Send for a Selection, Express paid.*

**SIEGEL, ROTHSCHILD & CO.**

MAKERS

418-420 West Baltimore Street, BALTIMORE, MD.

NEW YORK SALESROOM  
353 Broadway

PHILADELPHIA SALESROOM  
1011 Chestnut Street

**Tivoli Art Glass Co.**

(L. ADLER & SON)

General Agents

Makers of High Art Iridescent and Decorated Glassware

87 MAIDEN LANE NEW YORK

Telephone 2054 John.

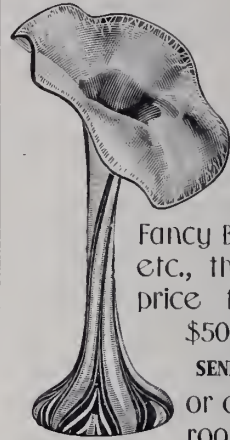

GLASSWARE showing "The Colors of the Rainbow." Our line is complete with Vases, Fancy Bowls, Novelties, etc., that range in price from \$1.00 to \$50.00 each.

SEND FOR A SELECTION, or call at our show rooms. The selling

quality is in the sheen and colors; cuts cannot show its beauty.



**HOOPER,  
Jewelers' Auctioneer**

For the legitimate trade only. All sales conducted along modern and high-class lines. I know it would pay any legitimate jeweler thinking of having an auction sale to write me for terms and reference, which cannot be excelled by any auctioneer in the business. All correspondence held in the strictest of confidence.

**H. J. HOOPER,**  
22 John Street, NEW YORK.

Telephone, 3255 Cortlandt.



**L.W. Levy & Co.**

LEATHER GOODS, NOVELTIES OF ALL SORTS, METAL, GLASS, CHINA, GUN METAL, Etc.

580-582 Broadway, New York City

Real Seal Bags with inside purse, size of bag 8 x 6 inches, retails at \$5.00



**DATTELBAUM & FRIEDMAN,**

Makers of Gold Rings of All Descriptions.  
45 John Street, New York.

Our Trade-Mark "D. F." in all our Rings is the guarantee of quality.  
*Send for Catalogue.*

**E. H. H. SMITH SILVER CO.**

BRIDGEPORT, CONN.

Silversmiths' Building,  
CHICAGO, ILL.

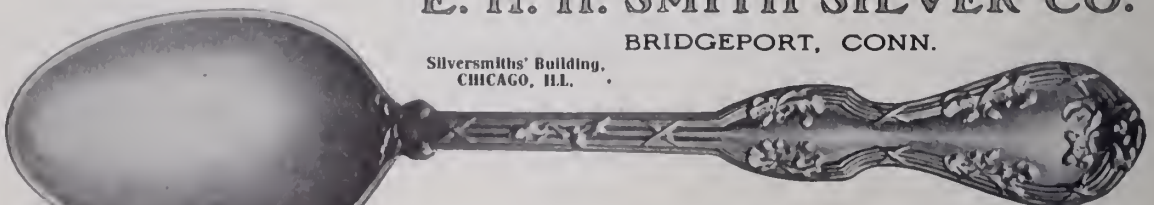

THE OAK.

Manufacturers of  
**Sterling Effects in Plate**

Write for our new catalogue.



## Popular Talks on Law.

Copyrighted, 1906, by WILLIAM C. SPRAGUE.

### CONTRACTS.

(Continued from issue of June 13.)

CONTRACTS BY MAIL, TELEGRAPH, TELEPHONE.

EVERY contract includes an offer and an acceptance.

An offer of proposal for a contract may be made in person, by agent, by telegraph, or by letter, and an assent to it or an acceptance of it may be given in the same manner.

If the proposition is made by letter, and sent by mail, the person making the offer may retract by a subsequent letter which reaches the offeree at any time before an answer of acceptance has been written and sent in the mail.

Example: A in Detroit mails a letter on Monday to B in New York offering to sell him 500 dozen eggs at eight cents a dozen. His letter reaches B Saturday noon. Saturday morning A writes a letter to B withdrawing his offer, which letter reaches B Monday morning, while he is in the act of writing a letter accepting the offer. It is too late for him to mail the letter and therefore he does not accept it.

As soon as an acceptance is put into the mail the contract is closed as to both parties.

Example: On Friday, A in Detroit writes a letter to B in New York, offering him 500 dozen eggs at eight cents a dozen. The letter reaches B Saturday noon. Saturday afternoon at 3 o'clock B writes a letter accepting the offer and deposits it in the mail box provided by the postoffice authorities, at the street corner. On the 4 o'clock delivery B receives a letter from A withdrawing his offer. A's withdrawal is too late; the contract was closed at 3 o'clock.

An acceptance by letter takes effect from the time when it is mailed and not from the time of its receipt by the party making the offer.

A retraction, however, takes effect when the letter of retraction is received and not at the time of mailing it.

The law as to the making of contracts by letter, telegraph, etc., grew out of the practice in early days of transmitting communications by private agencies. In an early case it was decided that a sale was complete when the letter of acceptance was mailed in response to a mailed letter containing the offer, the court merely deciding that, by sending the offer through the mail, the offerer made the mail his agent for the receipt of his acceptance.

The theory is, therefore, that where a man making an offer uses the United States mails for the purpose of transmitting his offer he makes the Postoffice Department his agent, and an acceptance delivered to an agent is the same as if delivered to the principal. It is on this theory that a contract is complete when the acceptance is delivered to the postoffice for transmission; while a retraction is not complete until it is delivered to the person to whom it is addressed, the mail not being the agent of the acceptor, but the agent of the offerer, that being the means he has chosen by which to communicate his offer.

The fact that the post has become a public agency and not a private agency, as formerly, does not prohibit the application of

the theory; one may make a public agency his own agent as much as he can make a private individual his agent.

So one may be bound when he really does not know that he is bound, as one does not usually know the moment when an acceptance is put into the mails.

If a proposition and its retraction reach the person to whom they are sent at the same instant of time, the question arises as to the result of an acceptance. It has been held that if the offer was opened and an acceptance posted before the letter of retraction is opened and read, the contract is binding. If the letter containing the offer is opened and read and afterward the letter of retraction is read, and then a letter accepting is posted, it is not a contract. The person must have had no actual notice of the retraction at the time when he mails his acceptance in order that the contract may be complete.

If A should send by mail an offer of goods at a certain price, and 10 hours later to ensure a sale send a second offer of the same goods for less money, and B mails an acceptance of the first offer before he receives the second offer, he cannot avoid his first acceptance by writing an acceptance of second offer and putting it in the mails, stating therein that he avoids his first acceptance. If on receipt of the first offer he mails his acceptance and two hours later receives the second offer of a lower price and then telegraphs his acceptance of the second offer, disaffirming the first, he is still bound to the first acceptance. A contract once made is irrevocable except by the agreement of both parties. The moment the letter accepting the first offer was posted the contract was complete, even although the acceptance never reached the offerer. Nearly all questions of validity of contracts by mail and telegraph may be answered by bearing in mind that the contract is complete the moment the letter accepting the offer is posted.

It must be borne in mind that the posting of the letter of acceptance, or the sending of the telegram, must be such a posting or sending as puts the communication practically out of the control of the sender; for instance, if the acceptor writes his letter of acceptance and places it in his own private letter box, to be called for by his own private messenger at a certain time in the day and taken by him to the postoffice, it is not posted within the meaning of the law. Or, if the acceptor gives the letter to a messenger, other than a postman or accredited agent of the Postoffice Department, he has not thereby made the acceptance complete until his messenger has placed the letter in the postoffice box, or the postoffice, or delivered it to an accredited agent of the postoffice authorities, so that if one writes a letter of acceptance and gives it to a private messenger to be taken to the postoffice and a telegram is received withdrawing the offer while the messenger is en route to the postoffice, even although he may be at the very door of the office, the retraction of the offer is sufficient.

(To be continued.)

A fire caused by lightning occurred in the store of Privett & Co., Winston-Salem, N. C., June 24, and did considerable damage.



FINE SPECIMENS OF  
DOMESTIC ART GLASS.

IN the sample rooms of the new Tivoli Art Glass Co., 87 Maiden Lane, New York, are a large number of specimens of the work that is now being done in the factory at Maspeth, L. I. The vases, made of glass, in the prismatic colors, are certainly attractive. The decorative patterns are produced at the time when the glass is blown. The specimens that are shown indicate that the process includes layer work and the clever use of acids. Every object comes from the works with a distinctive character, especially as to the ornamental design. Some of the vases come in antique effects, others are radiant with iridescent hues. Several are shown which give the idea of a porcelain body, although they are entirely of glass. The shapes show as much variety as the patterns, ranging from the ordinary forms to those that are eccentric and of the school of art nouveau. Altogether the line is decidedly attractive.

NOVELTIES IN  
VIENNA FAIENCE.

VIENNA Faience in a wide range of shapes and coloring is displayed among the various new lines in the salesrooms of Schwartz Bros. & Co., 39 Union Sq., New York. The articles are adapted for photograph holders, flower vases, card trays and mantel ornaments. Painted glass panels add to the pleasing effect of many of the pieces, especially those of the larger sizes. Figures of various kinds are modeled; one specimen has two little Dutch girls looking into a bowl, apparently to see their shadow in the water. The bowl may be used as a receptacle for flowers. Many other pleasing conceits make this collection a tempting one for buyers.

THE RAMBLER.

Patrolman Anderson, of the Worcester (Mass.) police force, found in a freight yard one night recently a box containing solid silverware bearing the stamp of the Goodell Silver Co., Concord, N. H. The contents are estimated at \$525 in value. Anderson was going about the yard on his usual round when he found the box with the cover ripped half off. He investigated and found heavy, solid silver knives, forks and other table ware. He reported the matter to the station, and the box was conveyed there. From the appearance of the case and of the surrounding circumstances the police believe that the box was on its way to Woonsocket, R. I.; that the freight car holding it was broken open, and that the thieves carried away as much of the silverware as they could take in their pockets and their hands.



Hand Bag.

Established  
1850

**C. F. RUMPP & SONS**

Manufacturers of  
**Fine Leather Goods**  
**PHILADELPHIA**

NEW YORK SALESROOMS - - 683 and 685 Broadway  
Send for Catalogue.



Emergency Case.

# The Thimble House.



No. 149.

Thimbles are not a side line with us—They are our main business. We study Thimbles, our designers study thimbles, our workmen study thimbles—The result is the finest and largest line of Thimbles on the Market.



No. 136.

**KETCHAM & McDOUGALL,**  
Manufacturers,  
37 @ 39 Maiden Lane, New York.  
*Send for Catalogue.* *Established 1832.*  
**ALSO MAKERS OF THE NEW AUTOMATIC EYE-GLASS HOLDERS.**

**BLANCARD & CO.,**  
96 MAIDEN LANE,  
NEW YORK.  
WELL MADE GOLD FINDINGS.

**FAIRCHILD & COMPANY**  
225 to 233 Fourth Ave. NEW YORK CITY.

Manufacturers of GOLD PENS, PENCILS, PENHOLDERS, SEGAR CUTTERS, SPECIALTIES, PENCILS SET WITH JEWELS.

*Style, quality and workmanship acknowledged the very best.*



**LEROY W FAIRCHILD.**  
**GOLD PENS.**



(Pat. Feb. 7, 1905.)

**Price**  
**\$3.00**

The LATEST, the BEST and the ONLY ACCURATE  
**Pallet Stone Setting Tool**

on the market, used in connection with the Depthing Tool. With this tool you can set a pallet stone in fifteen minutes, in place of from one to four hours at guess work. With the above instrument there's no guess work. In less than fifteen minutes your pallet is set correctly.

FOR SALE BY  
**The Columbian Jewelry Supply Co.**  
122 West 2nd Street, Central Block, 1st Floor,  
PUEBLO, COLO.  
Send for descriptive circular  
Write us for prices on Clock Tools and Materials  
JOHN A. BLAIR, Manager

**Trade-Marks** of the Jewelry and Kindred Trades.  
Second Edition. Price, \$3.00. The Jewelers' Circular Publishing Co., 11 John St., New York.

**DIAMOND POINT FOUNTAIN PENS**



**DIAMONDPOINT**

No. 2WC \$7.50 per dozen. Guarantee in every box.  
Largest Manufacturers of Popular Price Fountain Pens in the United States.  
Send for Illustrated price list of 11 Kt. Gold Fountain Pens. Good case assortment 1 dozen pens, \$9.00.

**DIAMOND POINT PEN CO.** - - - **100-102 Beekman Street, New York**

# Reduced Rates for Telephone Service

throughout Greater New York are effective from July 1st. Contracts now being taken at new rates.

Call nearest Contract Office for full information.

## NEW YORK TELEPHONE COMPANY

<b>Contract Offices:</b>	<b>Telephone No.:</b>
15 Dey Street	9010 Cortlandt
115 West 38th Street	9040 38th
220 West 124th Street	9000 Morningside
616 East 150th Street	9020 Melrose

**STUDY** THE ORIGINAL SCHOOL. Instruction by mail adapted to everyone. Recognized by courts and educators. Experienced and competent instructors. Takes spare time only. Three courses—Preparatory, Business, College. Prepares for practice. Will better your condition and prospects in business. Students and graduates everywhere. Full particulars and special offer **FREE**.

**LAW**

**AT**

**HOME** THE SPRAGUE CORRESPONDENCE SCHOOL OF LAW, 733 MAJESTIC BLDG. DETROIT, MICH.



## The ST. JAMES

Corner Walnut and Thirteenth Streets  
PHILADELPHIA, PA.

The Ideal Hotel of Philadelphia  
European Plan EUGENE G. MILLER, Mgr.

# PATENTS

obtained on inventions and designs. Trademarks, prints and labels registered.

**R. W. BISHOP,**  
ATTORNEY AT LAW,

308 C Street N.W., Washington, D. C.

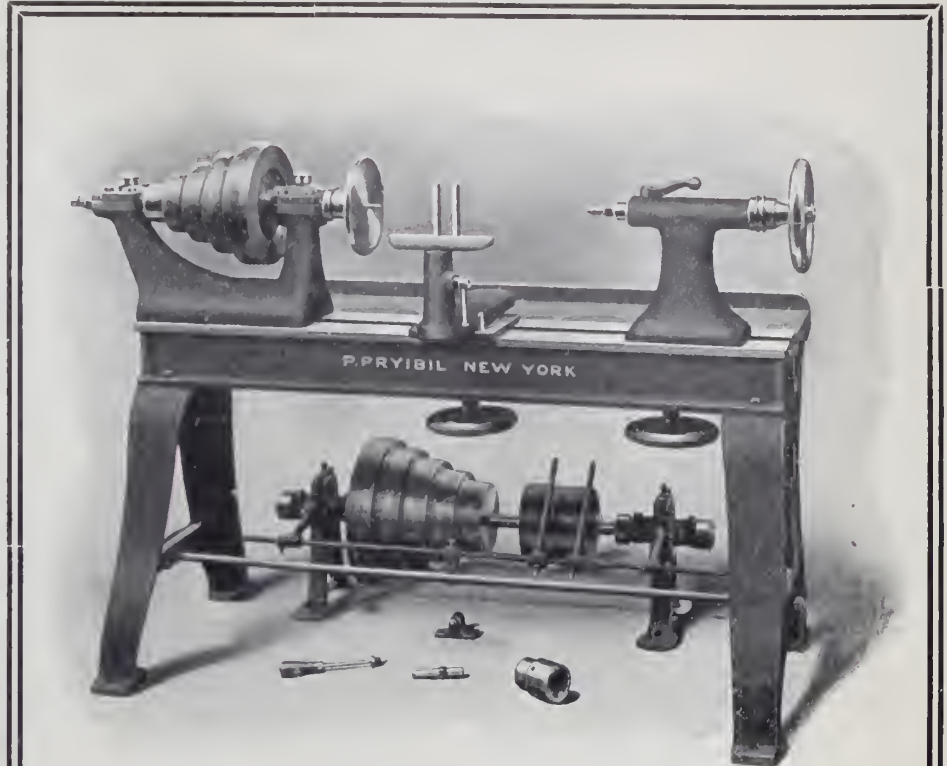

Above Cut Shows Our  
**METAL SPINNING LATHE**

We manufacture these lathes in sizes from 12-inch to 44-inch Swing, and can equip sizes 18-inch and larger with our Chucks for oval work.

Write for Catalogue

**P. PRYIBIL,** 512-524 W. 41st St., New York.

## REMOVAL NOTICE

We now occupy the new store of

**The Lorsch Building, 35 Maiden Lane, N. Y.**

# WOLFSHEIM & SACHS

MAKERS OF

Fine Boxes, Trays and Novelties for Jewelers and Silversmiths

**35 MAIDEN LANE, N. Y.**

Telephone, 3518 John.

Factory, 10 Gold Street.

*Mercantile Fountain Pen*

## The Best Self-Filling Attachment

made and guaranteed by

**AIKIN, LAMBERT & CO.,** 19 Maiden Lane, NEW YORK.

Retail Price:

**\$3.00**

**\$3.50**

**\$4.50**

Send for Price Lists and Discounts.

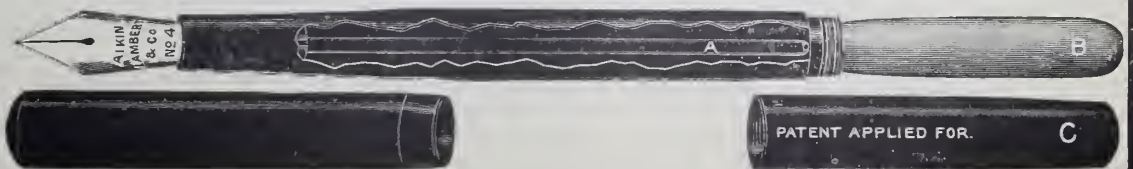



**HERPERS BROS..**  
MAKERS OF  
**BRACELET SETTINGS**  
IN 10, 14 AND 18 KARAT GOLD  
AND IN PLATINUM.  
ALSO A COMPLETE LINE OF  
GALLERIES AND FINDINGS.  
OFFICE AND FACTORY NEWARK, N. J., U. S. A. NEW YORK BRANCH 41-43 MAIDEN LANE  
12 NEW PATTERNS

**-: Comparison :-**  
ofttimes leads to better returns. We invite investigation and guarantee satisfaction.  
Send us a trial order.  
**CONLEY & STRAIGHT,**  
Gold and Silver Refiners,  
Assayers and Sweep Smelters,  
236 EDDY STREET, - PROVIDENCE, R. I.  
Dealers in Fine Gold, Silver and Copper. All kinds of Gold and Silver Anodes.

**CRUCIBLES.**  
Jewelers' Supplies, Etc.  
Established 1850.  
**J. & H. BERGE,**  
95 John Street, NEW YORK.

**WM. F. RENZIEHAUSEN CO.,**  
**GOLD and SILVER REFINERS**  
Sweep Smelters, Assayers and Analytical Chemists  
Rolling of FINE AND STERLING SILVER a Specialty.  
Long Distance Telephone, 3759-R. 45-49 Oliver Street, NEWARK, N. J.

**JAMES J. DONNELLY,**  
Gold and Silver Electro Plater,  
Fire Gilder and Colorer,  
41 and 43 Maiden Lane, New York.  
Prompt Attention Given to Mail Orders.

**CASTINGS** Gold, Silver, Bronze, Brass, German-silver, Copper & Iron, Supply Jewelers, Silversmiths, Die-makers, Mould-makers, etc.  
L. D. Tel. 2072 L.  
Unbreakable Bronze Forcés, Hard Bronze Engraving Plates, Cast Iron Forcés for making Steel Dies, Chandelier, Undercut Work, Statuary.  
**AUGUST GRIFFOUL,** 313 HALSEY STREET, NEWARK, N. J.

Frank Dederick. Established 58 Years. James E. Dederick.  
**James H. Dederick's Sons,**  
Assayers and Bullion Dealers.  
All qualities of Gold and Silver, in Plate, Square and Round Wire, Rolled to any gauge.  
ALL QUALITIES OF GOLD AND SILVER SOLDER.  
16 Maiden Lane, NEW YORK  
We buy Old Gold and Silver.

**F. JEANDHEUR, Jr.**  
Rear 17 John St., N. Y. Third Floor.  
Gold and Silver Plating  
SPECIAL WORK AND COLORING  
IN ALL SHADES A SPECIALTY.  
Established 1868. Platina Plating.



**HERMAN KOHLBUSCH, Sr.,**  
ESTABLISHED 1859.  
Manufacturer of Fine Balances and Weights for every purpose where accuracy is required.  
Office and Salesroom, 194 BROADWAY, NEW YORK.  
Send for Price List. Tel. 370 Cortlandt.



**JOHN S. STIVEN,**  
Gold and Silver Chaser.  
Room 219, Electrical Exchange Building,  
156 LIBERTY STREET. NEW YORK.

**HONEST AND PROMPT RETURNS FOR YOUR OLD GOLD, SILVER, FILINGS, SWEEPINGS & C.**

**WE BUY**  
Old Gold and Silver Filings, Polishings, Sweeps, Hand Washings, etc. We will make accurate valuations and hold consignment subject to your acceptance. If valuation is not satisfactory, we reshipe to you at our expense.  
**WE PAY FOR OLD GOLD:**  
22 K. 88c. per dwt. 12 K. 48c. per dwt.  
20 K. 80c. " " 10 K. 40c. " "  
18 K. 72c. " " 8 K. 32c. " "  
16 K. 64c. " " 6 K. 24c. " "  
14 K. 56c. " " 4 K. 16c. " "  
MARKET RATES FOR SILVER AND PLATINUM.  
Try us and you will appreciate our Squareness, Promptness and Accuracy.  
**T. B. HAGSTOZ, Ltd.;** Main Office, 709 Sansom St., Philadelphia, Pa.  
SMELTERS, ASSAYERS, REFINERS.

**WE SELL**  
Gold, Silver and Platinum, various qualities, rolled flat or drawn to wire of any gage.  
**PRICES OF ALLOYED GOLD:**  
10 K. 48c. per dwt. 14 K. 64c. per dwt.  
12 K. 56c. " " 16 K. 72c. " "  
18 K. 80c. per dwt.  
Gold and Silver Solder, either from formulas furnished or our own. "T. B. H." Alloy, 25c. per oz. Guinea Gold, 75c. per lb. Shot Copper, 40c. per lb. We will send tables for alloying without charge. They save figuring.

**PLATINUM AMERICAN PLATINUM WORKS**  
NEW YORK OFFICE 41 Cortlandt Street NEWARK, N. J.

## Special Features of the BROOKLYN BRISTOL CASE.

- ☞ Best 25 year case on the market.
- ☞ A binding guarantee as to wearing qualities.
- ☞ All new designs made by the most experienced artisans.
- ☞ A new one-piece pendant, eliminating all solder.
- ☞ Solid gold ball bearing bow.
- ☞ Made in full line open face and hunting, screw bezel and back and screw bezel and solid back.
- ☞ Engraved or plain.
- ☞ New green and yellow gold color effects.

JOSEPH FAHYS & CO.

# The Only Middlemen



KNOWN TO THE CUSTOMERS OF

## J. R. Wood & Sons,

DIAMOND CUTTERS.

2 Maiden Lane,

NEW YORK.

# PROGRESS

New York's New Under-ground Railroad Built by "the Ring."

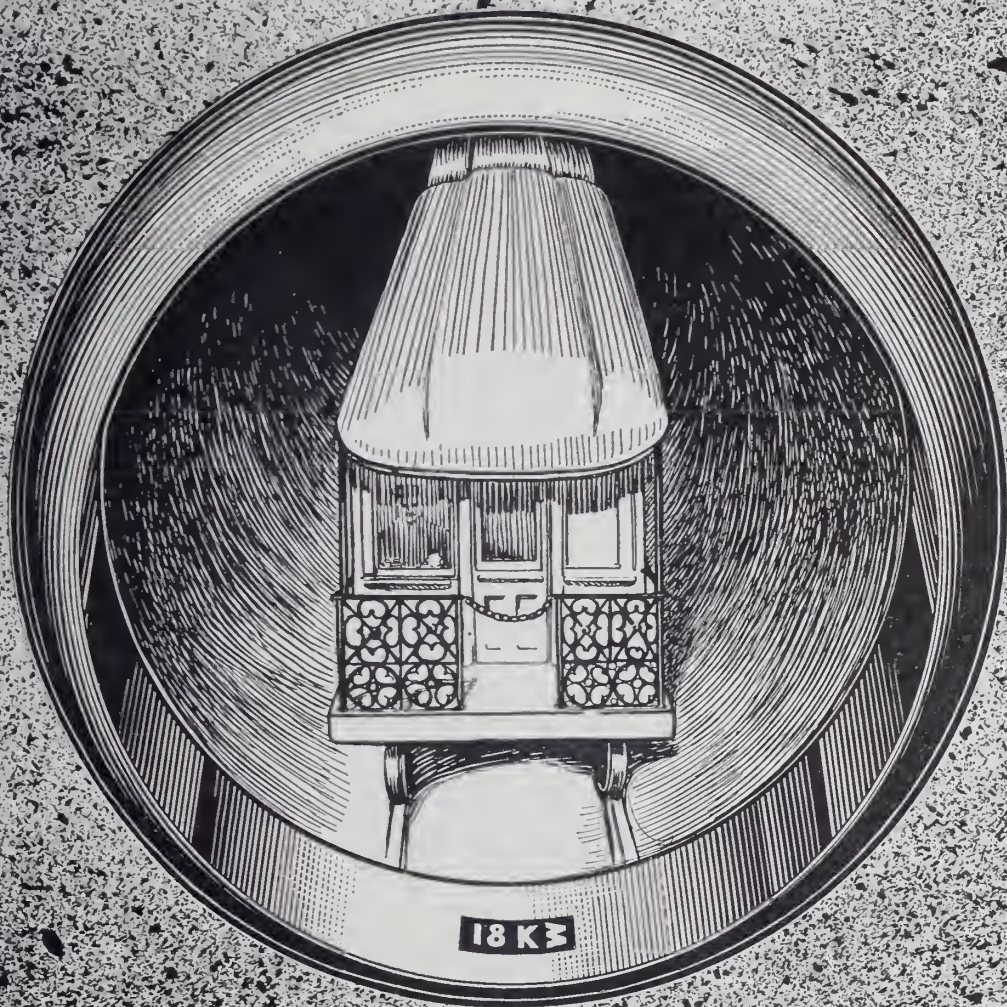

Makers of Plain Rings for Over 50 Years

2 Maiden Lane

NEW YORK

# Design, Workmanship, Quality and Durability

are the four factors which have made the

## BIGNEY CHAINS

the most popular in the market to-day. They are handled and worn by more people than any other make.

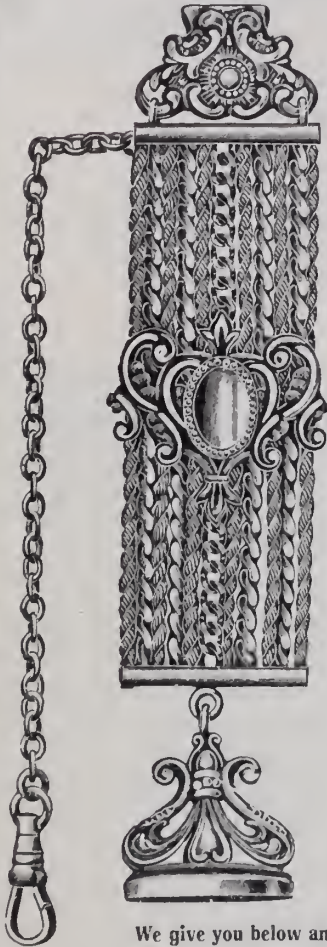

We give you below an exact copy of an assay of chains manufactured by the leading chain makers of the United States.

1-10 GOLD FILLED WATCH CHAINS, MINUS BAR AND SWIVEL.

Number	Gross Weight		Fineness	Value	Maker	Chain Number	Cost	
	Ounces	Dec.	Gold 1000ths					
15		71	29½	\$0.43	S. O. Bigney & Co. - - - -	1155	\$2.85	
16		75	50	.775		482	3.08	
17		81	34	.57		3005	2.73	
18	1	76	23½	.37		9533	2.97	
19		90	16½	.34		83	2.14	
32		52	49½	.53		213 X	2.83	
34		73	34½	.52		733	2.41	
46				.58			5011	3.82

1-8 CHAINS, MINUS BAR AND SWIVEL.

Number	Gross Weight		Fineness	Value	Maker	Chain Number	Cost
	Ounces	Dec.	Gold 1000ths				
35		57	68	\$0.80	S. O. Bigney & Co. - - - -	1604	\$3.96
36		60	65½	.81		7015	3.75
37		60	63	.78		4324	4.00
47		49	79	.80		2726	4.00

# S. O. Bigney & Co.

NEW YORK OFFICE,  
3 MAIDEN LANE.

FACTORY, Attleboro, Mass.





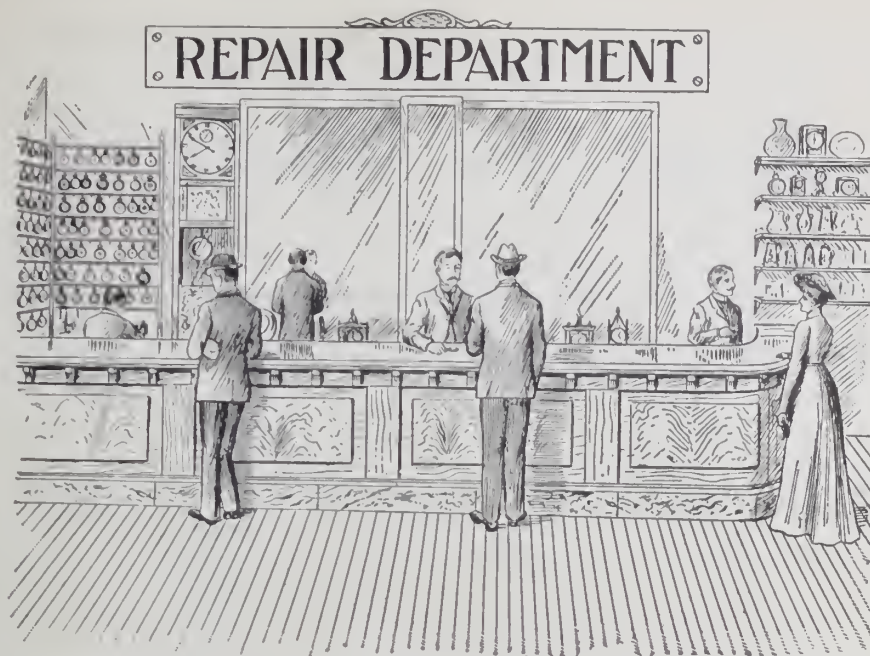

# The REPAIRING

END OF YOUR BUSINESS IS THE  
MOST IMPORTANT PART OF IT

More people come into your store to leave work than to purchase goods.

Almost every one of your good customers became so through your repair department.

Progressive jewelers know this and concentrate their efforts on the repair department of their business. They give it the most prominent place in their stores; they emphasize it in all their advertisements; they keep themselves and their employes thoroughly informed on the costs of all kinds of work, new ideas and methods; they are courteous and accommodating to repair customers; have all work ready when promised; and do only such work at home as they can do well.

They send all the rest to us.

We devote our entire time, energy, capital, and twenty-five years' experience to this important branch of the jewelry business; employ and educate the best help that can be obtained; systematize and inspect the work, and use every modern method to produce the best work promptly at reasonable prices.

It is to your interest to do business with us, it is to our interest to have you.

Let us work together.

## WENDELL & COMPANY

The Special Manufacturers for the Retail Jewelry Trade  
Do a larger variety of work than any other firm in the country

TWO WONDERFUL SHOPS:

103 and 105 William Street  
Near Maiden Lane  
NEW YORK

57 Washington Street  
Near State Street  
CHICAGO





These illustrate a few of the dozens of New Patterns we



are making in our Pilot Cases for this Fall delivery



*The* Wadsworth Watch Case Co.

CHICAGO  
Columbus Building

SAN FRANCISCO  
717 Market St.

NEW YORK  
49 Maiden Lane

FACTORY, DAYTON, KY.



?

?

?

Do the retail jewelers appreciate what they were paying for 12 Size movements before our 12 Size was on the market?

Do the retail jewelers appreciate what they were paying for O Size movements before our O Size was on the market?

Do the retail jewelers stop to consider what they would be paying for movements if there was not an independent watch company manufacturing a complete line of superior watches?

ILLINOIS WATCH COMPANY  
SPRINGFIELD



**S**ILVERWARE destined for the general service and adornment of the table should, in order to be wholly satisfying, possess not only a markedly decorative effect, but an opulent dignity and a well defined individuality of design.

¶ It is the belief of the Whiting Company that in their new Louis Quatorze pattern, which has been applied to every article suitable for table use, these essentials of success are very prominently displayed.

¶ With the confidence born of this belief, therefore, they beg to call attention to their novel and original treatment of one of the most popular, as it is one of the most effective, of historical styles.



**WHITING MFG. CO., SILVERSMITHS**  
Broadway and 19th Street, New York.

## **Dueber Watch Cases**

### **Hampden Watch Movements**

“Dueber-Hampden” stands for honesty, integrity and consistency. Added to these qualities the talent and energy devoted to the development of

#### **DUEBER-HAMPDEN WATCHES**

have earned for them the enviable reputation of

## **The**

# **Leading American Watch**

Made in all sizes and sold only as complete watches in 3/0 size and 12 size, cased in solid gold and gold filled cases of the most artistic designs.

## **The W. J. JOHNSTON COMPANY,**

Wholesale Agents of the Leading American Watch Companies,

**Fifth Avenue and Market Street, Pittsburgh, Pa.**

# **The W. J. JOHNSTON COMPANY,**

Wholesale Agents of the Leading American Watch Companies,

**Fifth Avenue and Market Street, Pittsburgh, Pa.**

---

---

## **Hamilton Watches**

## **Illinois Watches**

Made to be sold by live, progressive, American Retail Jewelers who realize the credit to be gained from selling reliable, accurate time pieces.

---

---

Protection to the Retail Jeweler is the "watchword" of The Hamilton Watch Co. and The Illinois Watch Co., and every effort will be made to restrict the sale of these watches to the Legitimate Retail Jeweler.



**W**E direct attention to our new Fall lines of Toilet and Hollow Ware in sterling silver, which in artistic conception and expert craftsmanship surpass any previous display.

Owing to the novel character of our Toilet Sets we will be unable to show same until about July 20, but we are sure you will agree that these sets are a radical departure from anything heretofore attempted. They will be illustrated shortly on this page.

**Woodside Sterling Co.**

Silversmiths

192 Broadway, New York



*"We never follow the Fashion, the Fashions Follow Us."*

MAURICE L. POWERS.



JOSH W. MAYER.

## ANNOUNCEMENT.

**W**E are now in a position to state that the greater part of our stock of new and effective goods that will be shown at our coming exhibition, to be held in our offices between August 13th and 18th, inclusive, is finished and by the 13th of August the display will be completed in its entirety.

**W**e desire to impress forcibly upon the Jewelers throughout this country that it will well repay them to visit this wonderful display. We have very many reasons for this assertion, but one of our strongest is that where one of our representatives calls on you, you see but one stock, while at this exhibit you will find five stocks combined into one, including large pieces that are never shown or carried on the road. We would very much like to acquaint you with our entire line, so that in case any of your clientele desires anything out of the ordinary, or any important pieces, you will know where to write or telegraph for them.

**T**he assortment at this exhibition will be tremendous and the prices will vary so that the very smallest and the very largest dealers will find the stock most attractive, from the simple everyday goods to the most extravagant.

Once a visit always a visit.

### POWERS and MAYER,

Makers of Diamond Mounted Jewelry THAT SELLS.

258-260 Fifth Avenue,  
NEW YORK.

We are always pleased to ship goods on memorandum when satisfactory references are given.



**J. F. STURDY'S SONS CO.**

*Makers of the Original Secret Lock and Joint Bracelet*

SOLD THROUGH THE WHOLESALE TRADE ONLY.

# Three New Patterns

---

---

OUR SALESMEN are starting on their display trips, and are showing a very large number of new designs in Ladies' and Gentlemen's Card Cases, Photo Frames, Baskets, Jewel Cases and other Novelties, and *three new and original patterns in Toilet Sets and Manicure Articles.*

For over 45 years we have enjoyed the distinction of originating the handsomest and best selling patterns in our several lines, but in the present offerings we excel all our previous efforts. Our etched effects supersede anything on the market at present.

We can supply Combinations in Toilet and Manicure Sets, arranged in handsome silk-lined cases. These combinations are beyond anything ever shown in the past.

Determine now to see these new creations; it will pay you well, and an opportunity will be lost if you neglect it.

These entire lines will also be on exhibition at our New York Showrooms.

TRADE  MARK.

---

---

## R. BLACKINTON & CO.

ESTABLISHED 1861.

3 MAIDEN LANE, NEW YORK

FACTORY, NORTH ATTLEBORO, MASS.



## FOR GENTLEMEN.

The very latest specialty in  
**ASH-RECEIVERS** is the  
**STERNAU ASH-RECEIVER**  
with stand.

It is gold-lined and is fitted with three rests, two for cigars and one for a safety-match box. Height of stand and Ash-Receiver,  $24\frac{7}{8}$  inches; diameter of Ash-Receiver, 6 inches; diameter of base of stand,  $12\frac{1}{2}$  inches. We have these receivers in polished brass, old brass, nickel plate, polished copper and silver plate.

**IT IS SALABLE AND  
PROFITABLE TO HANDLE.**

No. 927.—The Sternau Ash-Receiver  
with Stand in Use.

*New York Showrooms:*  
Broadway and Park Place,  
Opp. Post Office

**S. STERNAU & CO.,**  
Manufacturers of Coffee Machines, Chafing Dishes,  
Fancy Kettles, Trays, Etc.

*IF IT BURNS ALCOHOL WE MAKE IT.*

*Office and Factory:*  
195 Plymouth Street,  
Brooklyn, N. Y.

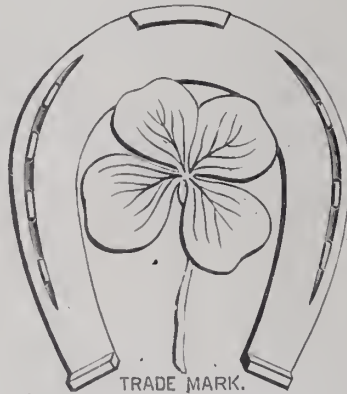

This is the **TRADE-MARK** stamped on

*The* **CLOVERETTE**



Posed by Chorus from "His Honor the Mayor."

## THE CORRECT TIME

to inspect our extensive line of 10 and 14 Kt. Rings **IS NOW**. No superior assortment, quality, design and workmanship considered, has ever been shown than is contained in our present offerings. We ask your especial attention to our creations in **EMBLEM RINGS**. The official seal of every order artistically and prominently displayed. We are known as "The Emblem Ring House of the United States."



Send to-day for our New Illustrated Catalogue, showing Designs and Prices; it will be mailed promptly.

**L. W. RUBENSTEIN,** 54 Maiden Lane  
New York City



# Tortoisene Combs

Mounted with 10-K. hand-work patterns. Every design is characteristic of originality and every detail is significant of superior workmanship.

*Tortoisene* is hard to detect from the real tortoise shell, having a rich effect that pleases the most skeptical in artistic hair treatment.

This cut represents a few of our patterns, actual size.

Combs will be much in demand throughout the year and orders should be in advance to insure prompt attention.

Prices on request.

## Schultz, Leiss & Co.

OFFICES

New York, 14 John St. Chicago, 103 State St.

FACTORY

Cor. McWhorter and Oliver Sts., Newark, N. J.

# ROCKFORD SILVER PLATE COMPANY ROCKFORD, ILL.

*Only  
Retail  
Jewelers  
Can  
Buy  
It*



*Rockford  
Silver  
Plate  
Co.  
Made  
It*

**Watchword of the Craft—"Stand By Those Who Stand By You"**



Trade Mark  
925-1000 Fine

# SMITH SILVERWARE



Trade Mark  
925-1000 Fine

appeals to that class of buyers who appreciate *distinctiveness* and *quality*. Our line of Hollow Ware and Flatware embraces designs well known to the representative retail houses throughout the country.

## Frank W. Smith Co.

Manufacturers of Sterling Silverware  
Gardner, Mass.

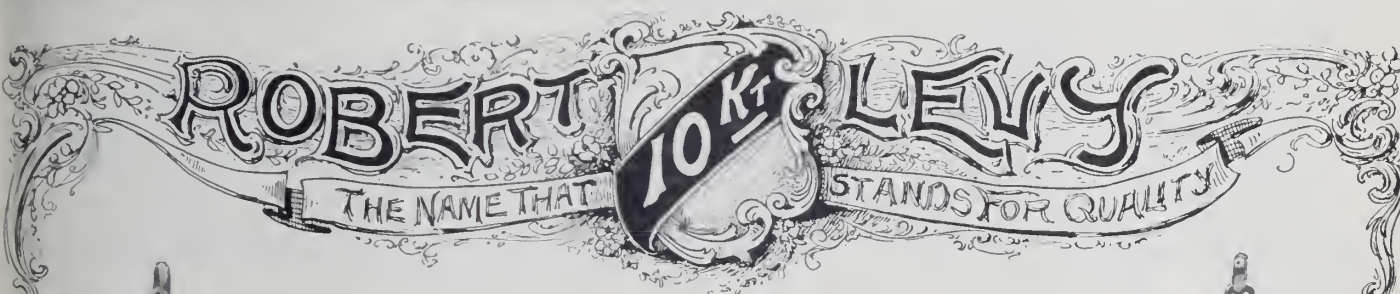

*The gun is steady and the aim is true.*

Each time we pull the trigger we hit the bull's-eye. We aim at the retailer through the columns of the "Circular," and the ads. are the trigger on which we work. Our goods are the projectiles and when we hurl them in the form of selection packages you can easily see your way clear for advancing your sales

**Locketts in heart shape and round.**

10 sizes to each style.

**10K. that is 10K.**



No. 1545.



No. 1548.



No. 1549.



No. 1547.

# ROBT. LEVY,

Manufacturing Jeweler  
Green and Columbia Sts., Newark, N. J.

# THE Bracelet Hit OF THE Season.



THE illustrations, which are exact size, show two of the best selling Bracelets of a big bracelet season.

Made of Rolled Plate, Pierced, Engraved—a neat, strong joint and catch—with and without stones, from ½ to 1¼ inches wide.

Our line offers an unsurpassed range of styles.

ASK YOUR JOBBER—HE HAS THEM.

**WHITING & DAVIS, Plainville, Mass.**  
NEW YORK OFFICE, 7 MAIDEN LANE.

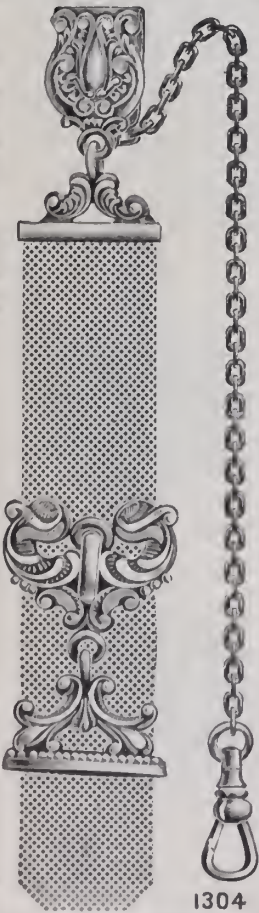

1304

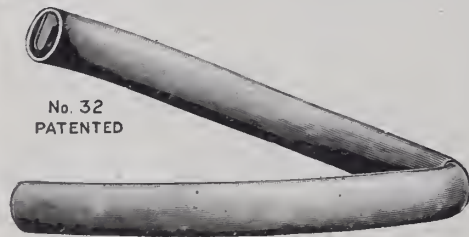

No. 32  
PATENTED

## The New "Bates" Bracelets

"Kant-Kum-Off"

Made in Seven Sizes

Ask your jobbers for THE BATES BRACELETS and you get the BEST

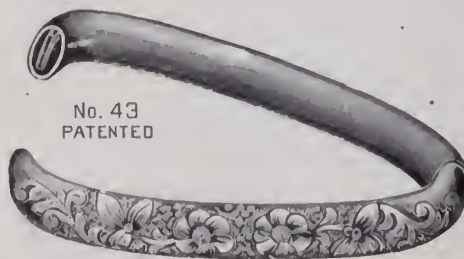

No. 43  
PATENTED

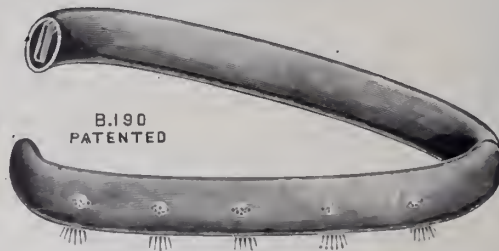

B.190  
PATENTED

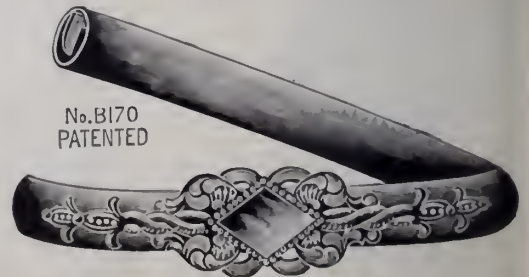

No. B170  
PATENTED

## BATES & BACON

Attleboro, Mass.

Makers HIGH GRADE CHAINS

The BEST SAFETY FOB is one of our specialties; Gent's Vests, Dickens, Lorgnettes, Secret Locket Chains, Lockets and Chatelaines.

OFFICES:

NEW YORK,  
9 Maiden Lane.

CHICAGO,  
103 State Street.



GOLD  
RINGS

BROOCHES AND MOUNTINGS

Also GOLD FILLED RINGS, including the popular THREE CROWN

Ostby & Barton Company respectfully announce to the jobbing trade that their fall line comprising many new and original designs is now ready.

OSTBY & BARTON COMPANY

New York, 13 Maiden Lane  
Chicago, 103 State Street

PROVIDENCE, R. I.

# The "Bryant" Rings.

WE have made the **Bryant Rings** for 50 years, and know how to make first class goods. The stone setting—which every retailer knows is a very important part of the work—we give special attention to. The **Bryant Rings** will help your reputation as a first class Jeweler.



TRADE-MARK.

M. B. BRYANT & Co., No. 7 MAIDEN LANE,  
NEW YORK.

## The Bowden Rings

ARE COMPLETE IN VARIETY, CORRECT IN  
QUALITY AND PERFECT IN FINISH. WE  
MAKE EVERY VARIETY OF FINGER RINGS.

J. B. BOWDEN & CO.,

1 Maiden Lane.

NEW YORK.

# Appropriateness in Mountings



GENUINELY artistic mountings call for expert judgment and skill. Every stone possesses some individual characteristic with which the mounting should harmonize. Thus added value may be imparted. Such appropriate mountings are a specialty here.



**Durand & Company,**

49-51 Franklin Street,  
Newark, N. J.

EVERYTHING IN  
**MOURNING JEWELRY.**

**A. J. HEDGES & CO.,**  
Makers of Exclusive Designs in 14K. Jewelry,  
14 JOHN STREET, NEW YORK.

TRADE-MARK



## Adjustable Glove Garters

IN  
GOLD AND SILVER

### Gold Jewelry

14K. in 10K.

Plain, Chased, Engraved, Diamond Set  
BRACELETS, BROOCHES,  
LINKS, LOCKETS, ELK  
BUTTONS, ETC.

**Chas. L. Trout & Co.,**  
15 MAIDEN LANE, NEW YORK.

TRADE MARK

**OSMUN-PARKER MFG. CO.**  
MAKERS OF  
*Fine Pearl and Diamond Goods*  
338 Mulberry Street  
NEWARK, N. J.

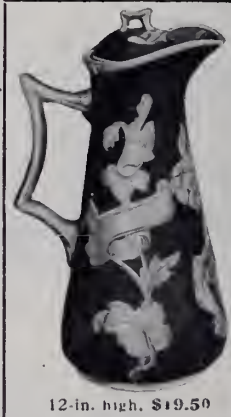

### Supremacy in Silver Deposit Ware

Illustration shows our new Chocolate Pot, of Silver Deposited Frost Ware in Cobalt Blue. The design and workmanship of our line have never been equalled.

12-in. high, \$19.50

### Deposit Ware Exclusively

Representative Jewelers are invited to send for a selection of

FANCY BASKETS, CHOCOLATE SETS,  
WHISKEY JUGS, EXCLUSIVE NOVELTIES, ETC.

### DEPASSE MFG. CO.

41-43 Maiden Lane, New York

ESTABLISHED  
1871.

Factory and Office: Newark, N. J.

INCORPORATED  
1900.

## CARRINGTON & CO., *Patent Pocket Match Box*

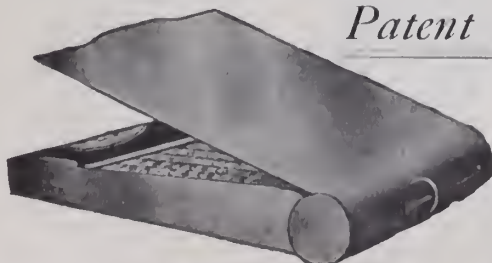

Book Safety Matches with  
Steel Cigar Cutter.  
(Patented.)

Sales Agent:  
7 Maiden Lane,  
NEW YORK.



14K. ONLY IN STOCK.

## ROBERT DULK, DESIGNER,

Etching in Gold and Silver,  
Telephone, 3960 Chelsea.

No. 70 5th Avenue, NEW YORK



## Some Glances Ahead

THE SATISFACTORY filling of your orders later, is preceded by painstaking preparation now.

There is no lowering of standards here from season to season. The quality of the past justifies high expectations for the future. These expectations will not be disappointed.

In a few days the Fall lines will be ready to reward your inspection, which is respectfully invited.

## Day, Clark & Company

14 KARAT  
ONLY



23

Maiden Lane  
New York

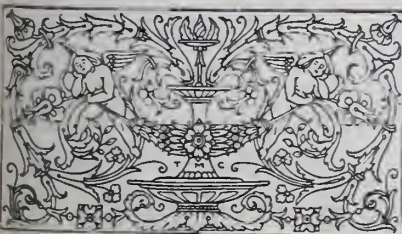

## WHITESIDE & BLANK Bride's-Rose

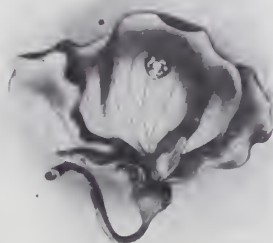
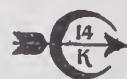

BROOCH No. 1685

*Pink Enamel  
and Green Gold*

NEWARK, N. J.,  
Lafayette and Liberty Streets.

NEW YORK,  
14 and 16 John Street.

ESTABLISHED 1841

## Carter, Howe & Co.

TRADE



MARK

MANUFACTURERS OF

## Gold Jewelry,

9, 11, 13 MAIDEN LANE, - NEW YORK.  
FACTORY, NEWARK, N. J.

A. CARTER.

G. R. HOWE.

V. T. CARTER

W. T. GOUGH.

"THE BRACELET HOUSE."

## KENT & WOODLAND,

BRACELETS FOR EVERY WOMAN AND MISS.

16 John Street, New York.

San Francisco Office,  
Care JULIUS A. YOUNG.

"Nethersole Dangles,"  
Plain and with Stones.

"Pinhole" Secret Snap,  
with and without pre-  
cious and semi-precious  
stones.

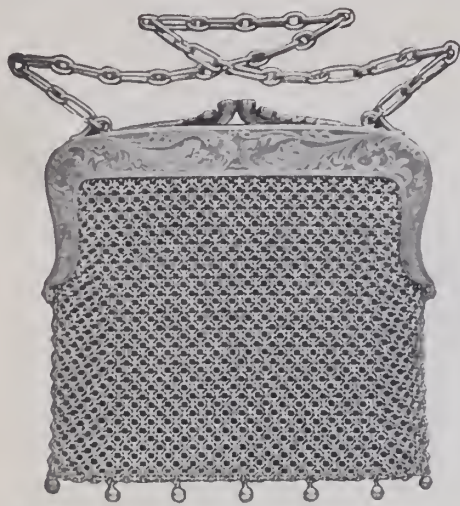

# S. Cottle Co.

GOLD AND SILVER BAGS  
AND PURSES, NEW STYLES  
AND DESIGNS—ALL OF  
SUPERIOR WORKMANSHIP.

31 East 17th Street,  
New York.



The Rosary  
in Fine Jewels

Fine  
Rosaries  
in pure  
and  
imitation  
stone.  
Mounted  
in solid  
gold and  
rolled  
gold-plate

ALL COLORS.



Our special  
illustrated catalogue  
will give interesting  
advice regarding  
prices and discounts.

MADE BY

The **W. J. Feeley Co.**

Providence, Rhode Island,  
Ecclesiastical Art Metal Workers.

## Bridesmaids' and Ushers' Pins

We would suggest something with color. Brooches, Scarf Pins and Handy Pins with Amethysts, Topazes, Garnets, Peridots, Aquamarines, Jades and Baroque Pearls. We have a large variety of patterns at moderate prices.

REGARDING OUR FOBS WE HAVE NOTHING TO SAY—  
THEY SPEAK FOR THEMSELVES.

**SNOW & WESTCOTT,**

Makers of Good Jewelry for Over Seventy Years,

21 MAIDEN LANE, NEW YORK.

ADOLPH LUTHY.

PERCY W. HINE.

## LUTHY & HINE,

13 EAST 30TH STREET, NEW YORK.

MANUFACTURERS OF

**Artistic Gold and Platinum  
Mounted Diamond Jewelry.**

Odd and Exclusive Patterns in NECKLACES, BROOCHES, BRACELETS,  
RINGS, RIBBON COLLARETTES, Etc.

MOUNTED WITH AQUAMARINES, PERIDOTS, AMETHYSTS  
AND OTHER PRECIOUS STONES.

(DIAMOND MOUNTED COMBS A SPECIALTY.)



OUR BUYERS have  
just returned from  
European markets which  
they have ransacked in  
search of novelties for  
the jewelry trade.

Our line of FANS for  
the coming fall possesses  
such charm that it will  
satisfy the most exact-  
ing buyer.

We also present the  
latest Novelties in

**BROOCHES  
MOUNTED COMBS  
NECKLACES  
CHAINS  
BUCKLES, Etc.**

A call at our show-  
rooms is imperative to  
a visiting buyer.



**LEWY & COHEN**

IMPORTERS,  
530 BROADWAY, NEW YORK

**DESIGNS** For Silverware, Novelties and Jewelry . . . **FINE ETCHING**

We have just completed a number of designs for HIGH CLASS JEWELRY.  
Drop us a line and we'll call

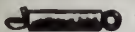
CHARLES M. PRIOR (PHONE 1224 HARLEM) 1683 Madison Ave., New York

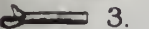
-  1. Snap complete.
-  2. Outside of Snap.
-  3. Inside of Snap.

## The E. P. H. Patent NON-PULL-OUT Neck Chain Snap

is a patented snap that insures  
the wearer against loss of

CHAIN or CHARM  
for it positively will not pull out

Made in 10 and 14 Karat Gold and  
in Gold Filled.

Can be had of the following *Wholesale  
Selling Agents:*

- Messrs. W. Green & Co.,  
81 Nassau St., New York.
- |                           |                   |
|---------------------------|-------------------|
| M. Sickles & Sons,        | Philadelphia      |
| E. A. Cowan & Co.,        | Boston            |
| E. & J. Swigart,          | Cincinnati        |
| Swartchild & Co.,         | Chicago           |
| Nordman Brothers,         | San Francisco     |
| Leonard Krower,           | New Orleans       |
| A. Walker Co.,            | Providence, R. I. |
| Bauman-Massa Jewelry Co., | St. Louis         |

### PRICES.

- 14 Karat—Small, \$7 per doz. net
- Large, \$7.50 per doz. net
- 10 Karat—Small, \$6 per doz. net
- Large, \$6.50 per doz. net
- Gold Filled—Small, \$2 per doz. net
- Large, \$2.25 per doz. net

## SAM'L BUCKLEY & CO.

English Fancy Goods.



Carry in New York a full line of

### ENGLISH PLATED WAITERS.

118-122 Holborn, E. C.,  
London, England.

100 William St., New York.

# WORLD BRAND SILVER



### Base Metal

Manufactured in our own factory by workmen selected because of their knowledge and practical experience in its manufacture and use and with a view to obtaining the best possible results.

### Silver

Not Less Than 50 per cent. heavier plate than the regular "Standard." Made in two grades, six and fourteen ounce plate.

### Designs

Six fancy patterns—*original* in design and unexcelled in execution. Also four plain patterns.

### Prices

As low as consistent with quality.

*Write for catalogue and prices.*

THE AMERICAN SILVER COMPANY  
BRISTOL, CONN.

46 West Broadway, New York.

Silversmiths' Building, Chicago, Ill.

## AT LAST!

### KEY RING PROBLEM SOLVED!

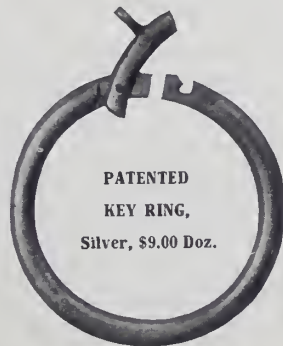

PATENTED  
KEY RING,  
Silver, \$9.00 Doz.

THE ring illustrated herewith does the trick. You can put on and take off one dozen keys in less time than you could take one off any other make. We can also supply patent key rings in 10 and 14K. gold.

See our fall line before you place your order for Sterling Silver, Picture Frames, Card Cases, the new style Pocket Book, Toilet Ware, Manicure Articles, Buckles, Match Safes, Child's Cups and other hollow ware.

## PRYOR NOVELTY COMPANY

New York Office: 7 Maiden Lane

Factory and Office:  
473-475 Washington Street, Newark, N. J.

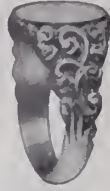

Quality and Finish Consistent  
with twenty years' experience.  
Original and Exclusive Designs.

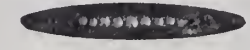

# MOORE & SON,

ESTABLISHED  
1886.

NEWARK, N. J.

INCORPORATED  
1903.

## The Comb House

We manufacture a complete line of

### FINE MOUNTED COMBS

in 14 K., 10 K., Sterling Gilt and Gold Filled.

Also all kinds of PLAIN, REAL and IMITATION TORTOISE  
SHELL COMBS.

Selection Packages sent to Responsible Jewelers.

Wagner Manufacturing Co.

41 Union Square,

New York. Factory, Lorimer St. and  
Throop Ave., B'klyn, N. Y.

Repair Work  
a Specialty.

## SIGNET RINGS



TRADE  MARK

## Geo. O. Street & Sons

Est. 1837

24 John St., New York.  
103 State St., Chicago.

## ROSARIES



Of Foreign and our own Manufacture,  
\$2.40 per Dozen up.

## SIGNET JEWELRY <sup>A</sup> SPECIALTY.

Memo. Orders Solicited.

# L. Witsenhausen

47-49 Maiden Lane,  
New York.

Manufacturers **MODERN JEWELRY**  
of  Chicago, 405 Masonic Temple.  
(L. KATLINSKY.)

## Roger Williams Silver Co.,

PROVIDENCE, R. I., AND NEW YORK, 860 BROADWAY.

**Sterling Only.**

RICH DESIGNS :: :: :: Photos on Application.

## CROUCH & FITZGERALD



**Jewelry  
Trunks  
and Cases**

177 Broadway,  
Bet. Cortie and  
Dey Sts.

688 Broadway,  
723 6th Ave.,  
New York.



## SOLID GOLD CHAINS

Gold Chains that don't have to first pay the heavy expenses of traveling salesmen, before a selling price is placed on them, are chains that to-day are interesting the careful and exacting buyer.

WE are the makers of just such  
**SOLID GOLD CHAINS**



Are YOU one of these careful and exacting buyers?

For 56 years critical Jewelers have found our Chains ready sellers, very profitable to handle and most durable in service.

We have no salesmen, and our prices are therefore very low. We will be pleased to send you a selection package.

1850 1906

**ALOIS KOHN & CO.**

Makers of

**SOLID GOLD CHAINS**

of every kind.

16-18 Maiden Lane  
New York



## The Unquestioned Success of Our Line

*is no surprise to those who have seen it.*  
*For many years there had been an opening for a very high-grade 10K. line, and we believe that we have satisfied the demand.*

*No finish like this, nor such designs were ever before seen short of high-grade 14K. jewelry.*



*Kohn & Co*

Camp and Orchard Streets, NEWARK, N. J.

## M. SCHIFF

Established 1876  
82-84 Nassau St., N. Y.  
Phone 801 John.

Manufacturer of fine  
Diamond Mountings, Locketts  
and Buttons. Patentee of

## THE NEW IMPROVED Ear Screw

The only one on the market  
of its kind, absolutely secure.  
Special attention paid to all  
order work.

ALL KINDS OF BRACELETS

## HEINTZ BROTHERS

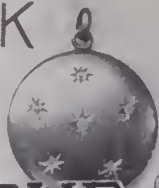

• We Make the Largest Line of Solid Gold Set Rings in America for the Retail Trade •

10K    14K

**THE LOCKET HOUSE**



**ROTHSCHILD BROS. & CO.**  
51-53 MAIDEN LANE, N.Y.

An Unlimited Line of Patterns of

LADIES' LOCKETS  
MEN'S LOCKETS  
LOCKETS FOR EVERYBODY

UNMOUNTED  
MOUNTED WITH  
DIAMONDS  
OR ROSES

BROOCH MOUNTINGS  
LINK BUTTONS  
BRACELETS  
RIBBON FOBS

**"TOPPY AND ORIGINAL"**

Bracelets  
Barrettes  
Brooches  
Pearl Snaps

A  
&  
V

Handy Pins  
Scarf Pins  
Pendants  
Collarettes

**ALLSOPP AND ALLSOPP**

'PHONE 4075W

18 COLUMBIA ST.

NEWARK, N. J.

**Ross, Saltman & Anderson**

MANUFACTURERS OF

**Rings and Diamond Mountings**



000



204

89 FULTON STREET,  
NEW YORK

Jewelers will find it desirable and profitable to keep in touch with our new and artistic monthly productions. They represent that originality and perfection upon which we propose to establish a substantial reputation.

**Salosico Ware**

WEATHERED OAK

Silver Plated Trimmings and Lining



Style 31  
List \$10.50

See our complete line at New York Office, 25 West Broadway.

**St. Louis Silver Company**  
St. Louis, U. S. A.

Illustrated Catalogue mailed on request

**THE WASHBURN SECURITY MAGIC NUT**

Automatic Holder for ear studs, scarf-pins, etc.  
for all sizes of scarf-pin wire. Guaranteed.



**EAR WIRES**

for unpierced ears.



**SAFETY CATCH**  
For brooches, etc.  
Can be applied to any work where pin tongues are used.

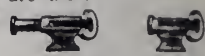

Open. Closed. Open. Closed.

Descriptive Circular on Application.  
Pearl Drilling and Adjusting a specialty.  
Special Order Work and Repairing.

C IRVING WASHBURN, 12-16 John St., N. Y.



Pat.  
U.S. and  
Canada.

**Try Wells' Perfect Ring Adjusters**

1 doz. asst. sizes 10k gold filled (gold on front twice as thick as on back), \$2.00.  
1 doz. asst. sizes solid 10k gold, \$4.75.  
1 doz. asst. sizes metal, 85c. Ask your jobber for them, or I will send, prepaid, at once (only on receipt of order), two samples—one small and one medium large gold filled and one metal adjuster for 50c. Address

CHESTER H. WELLS, Jeweler Meshoppen Pa

OVER  
4000  
MARKS.

**"Trade-Marks of the Jewelry and Kindred Trades"**

SECOND EDITION. PRICE, \$3.00.

Published by  
The Jewelers' Circular  
Publishing Co.,

11 JOHN ST., NEW YORK.



# The Salable MOUNTING

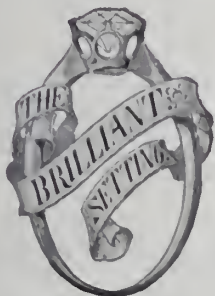

Pat. Oct. 24, 1903.

It gives light and brilliancy  
to the stone

EARSCREWS  
EARRINGS  
STUDS  
SCARF PINS  
and RINGS

of every description made  
in Platinum, 18k., 14k.,  
all sizes.

## Julius Wodiska

40 John St., New York

Manufacturer of a  
general line of

PLATINUM  
18k. and 14k.  
MOUNTINGS

Prompt attention given to  
special order work.

Estimates and designs sub-  
mitted.

Diamonds recut and re-  
paired.

## TRIED AND PROVEN

### FOR 29 YEARS THE JEWELERS' LEAGUE

have been in continuous and successful operation.  
During this period they have paid to the beneficiaries  
of their members over

**\$3,134,000.00**

without disputing or compromising a single claim.

To-day, with adequate rates, they are in the full  
blast of vigor and prosperity.

Those desiring life insurance protection for their  
wives, or those dependent upon them, should inves-  
tigate the new monthly table of rates, which offers  
maximum insurance at minimum cost.

**Death Benefits, = \$1,000 to \$5,000**  
**Age limit of applicants, 21 to 44 years**

For full particulars, address the Home Office, 12 John St., New York City

GEO. W. STREET,  
President.

F. A. MARSELLUS,  
Sec'y and Treas.

## Koshland & Italic Co.

702 Chestnut Street, PHILADELPHIA, PA.

¶ Not how **CHEAP**  
but how **GOOD** is the  
principle we follow  
in selecting the goods  
we offer for sale.

**Diamonds, Watches and Jewelry**

"Watch us" always for anything you wish in the "Watch" line.

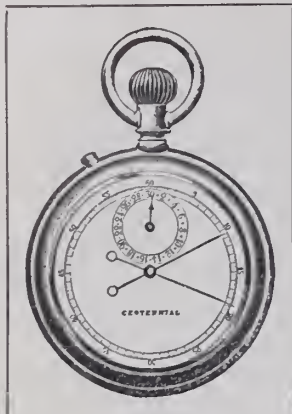

Timer is 1/8 Larger than cut

# THE OLD RELIABLE Centennial

SPLIT SECOND TIMER

"None better made"

Suitable for Racing and Mechanical Purposes.

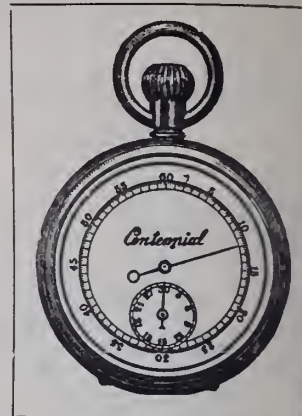

Timer is 1/8 larger than cut

**CROSS & BEGUELIN, Manufacturers, New York.**

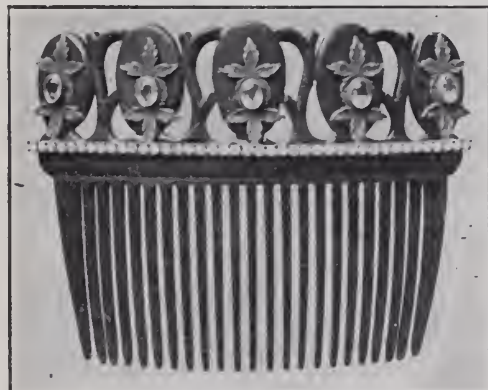

**COMBS** Our new line shows many designs, highly artistic and attractive, that will prove rapid sellers. The highest class of workmanship is characteristic of all our lines. Ask your jobber for our

Combs, Brooches, Scarf Pins, Bracelets, Barrettes, Buttons, Baby Pins, Crosses, Waist Sets, Hat Pins, Collarettes, Silver Novelties.

LOOK FOR THE TRADE-MARK



TRADE MARK  
A.O.T.G.  
M.F. & W.  
ALWAYS ON THE GO

**MILLER, FULLER & WHITING, MANUFACTURING JEWELERS**  
N. Y. Office, 9-11 Maiden Lane NORTH ATTLEBORO, MASS.

35 Years Manufacturing  
**CHAINS**

**S. & B. Lederer Co.**

11 Maiden Lane New York      Factory: 131 Wabash Ave. Providence, R. I. Chicago

THE CROWN PATENT SAFETY GUARD.



For Scarf Pins Pins. The most adjustable one invented. Price, \$1.50 per doz. For sale by all wholesale jewelers and material houses. Sample by mail, 25c; in 10k. gold, \$1.00; 14k., \$1.25. M. CROHN, Maker and Inventor, 48 and 50 Maiden Lane, N. Y.

**MR. RETAILER :**

The Jobbers have placed orders for more cases than we can possibly produce this season.

Would it not be wise for you to secure a few "Solidaritys" from the *first* Jobber that shows them?

The next Jobber may sell his prettiest patterns before he reaches your town.

"THE RIPEST FRUIT FALLS FIRST."

## Solidarity Watch Case Co.

ESTABLISHED 1885

GENERAL SELLING AGENTS  
JOHN W. SHERWOOD      FRANK E. HARMER

**3 Maiden Lane, New York**

Henry Freund.

Louis Freund.

Leo. Goldschmidt.

L. M. Heymann.

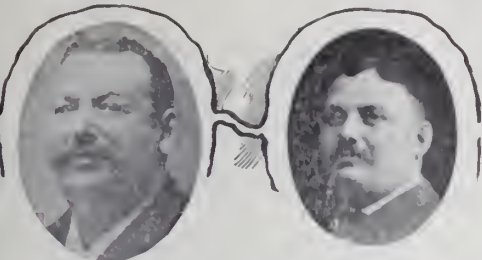

OUR TRADE-MARK  
THE ROSE



STANDS FOR QUALITY  
AND EXCELLENCE.



**T**HE little Brownies and the big Brownies work hand in hand, and with concentrated mental and physical energy, to introduce our "Sellers" to the trade. When once introduced, we have no fear of the results. We have customers who have been with us for 40 years, and the rule holds good, "Once a customer, always a customer." The right goods at the right time and at the right prices, combined with liberal treatment in every respect, make our customers our friends for all time. The list is constantly increasing. Let us add you to the number this season.

**HENRY FREUND & BRO., "Sellers of Sellers"**

ELK and EAGLE GOODS & Specialty

71 Nassau Street NEW YORK



Our Line of Rings is hard to beat, as is also our line of

**SCARF PINS, EAR SCREWS, CROSSES, BROOCHES, ETC.**

They are the kind that sell. Insist on seeing the line of Gold Jewelry manufactured by

**THE AMERICAN RING CO.**  
94 Point St., PROVIDENCE, R I.

**OUR EIGHT SALESMEN ARE ON THE ROAD.**

It is more than likely that one of them will call upon you in the near future. Let us impress upon you here the fact that the sample line of American Watches, Diamonds and Jewelry that he carries has been selected with more than usual care.

From our New York Office:  
H. OLLENDORFF  
T. OLLENDORFF  
H. GOLDSTEIN

**"We cover the country."**

Special Southern Representative:  
O. J. SOMERS

From our Pittsburg Office:  
W. S. BICKART  
J. S. BICKART  
W. E. PARISH  
S. A. REUTTER

Should your wants necessitate an immediate delivery before our representative's arrival, either our New York or Pittsburg office will give your order by mail PROMPT and CAREFUL attention.

**I. OLLENDORFF CO.**

JOBBERS IN WATCHES, DIAMONDS AND JEWELRY

NEW YORK  
54 Maiden Lane.

Established 1868.

PITTSBURG, PA.  
Cor. Liberty Ave. & 6th St.

## ORDERS PROVE OUR GOODS SELL

We make for the Jobbing Trade the following lines of Solid Gold Jewelry :

*Rings, Scarf Pins, Studs, Brooches, Charms,  
Baby Pins, Handy Pins, Chain Sets,  
Link Buttons, Hair Barrettes,  
Crosses, etc.*

Insist upon seeing the designs of Gold Jewelry made by the

**E. L. SPENCER CO.**

95 Chestnut Street,

PROVIDENCE, R. I.

New York Office, 9-11-13 Maiden Lane.

SAMPLES ONLY.

### EGYPTIAN PEARLS

—  
FINEST  
OF  
ARTIFICIAL  
PEARLS.

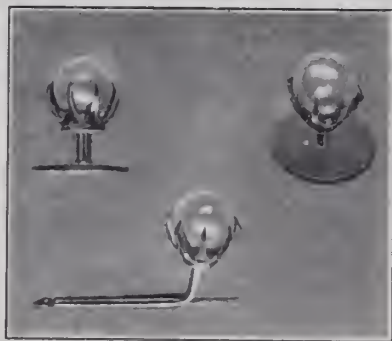

### EGYPTIAN PEARLS

—  
MOUNTED  
IN  
POPULAR  
JEWELRY.

**T**HE PEARL has always symbolized Beauty and Value. Nature's product is most closely approximated in the handsome "EGYPTIAN" Pearls. The iridescence, weight and color of natural Pearls are retained; and inspection of the "EGYPTIAN" Pearls will demonstrate their pre-eminence. The results attained are possible only by a special process, supplemented by expert workmanship. The articles of Jewelry to which "EGYPTIAN" Pearls are applied are artistic creations meriting your attention.

### GEORGE H. CAHOONE COMPANY,

Makers of Artistic Jewelry.

PROVIDENCE—7 Beverly Street.

NEW YORK—9 Maiden Lane.

AN UNEXCELLED  
LINE OF

## WAIST SETS

The illustrations show some simple designs. These are but a few of a large and varied assortment.

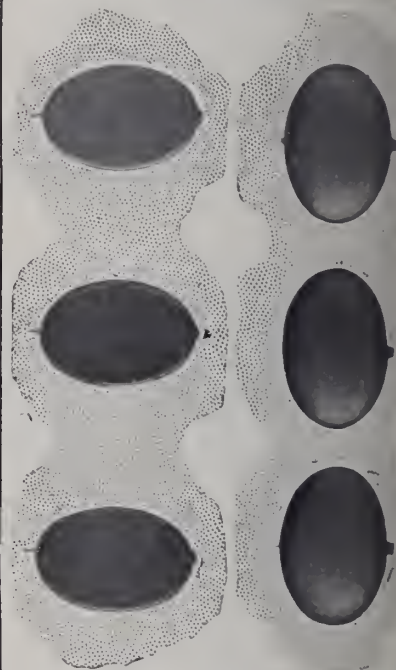

**A**SK YOUR JOBBER for the P. & B. Co. lines of Waist Sets, Fobs, Lockets, Tie Clasps, Brooches, Scarf Pins, Hat Pins, Baby Pins, Bead Necks, Cuff Buttons, Crosses and Bracelets.

We are the largest exclusive makers of 10 Karat jewelry.

## Potter & Buffinton Co.,

Providence, R. I.

New York Office,  
65 Nassau St.

San Francisco Office,  
206 Kearny St.

**W**ait  
**A**nd See  
**I**n the "Celebrated Case"  
**T**his Season's New Goods.  
**E**very one a Seller

**T**here  
**H**ave always been  
**R**easons:—  
**E**stablished reputation,  
**S**taple Patterns,  
**H**igh Quality,  
**E**ndless Variety,  
**R**'s  
**S**

**G**  
**O**  
**O**  
**D**  
**S**  
**S**  
**E**  
**L**  
**L**

**Waite-Thresher  
 Company**

61 PECK ST., PROVIDENCE, R. I.

7 Maiden Lane,  
 NEW YORK.

1203 Heyworth Bldg  
 CHICAGO, ILL.

**LOCKETS ONLY**

Satisfy your customers by using the recognized standard of excellence  
 in this specialty

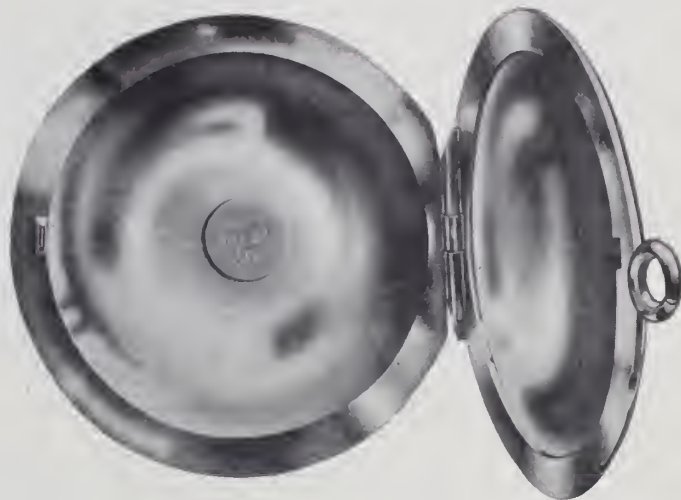

None genuine without **TRADE-MARK** stamped inside

**ESTABLISHED FIFTY YEARS**

**Wightman & Hough Co.**

New York Office  
 3 Maiden Lane

Main Office and Factory { 7 Beverly Street  
 Providence, R. I.

**The Kenilworth Bracelet.**

(Patented Jan. 2, 1906, No. 808,805.)  
 No. 4086.

All of the foremost  
 jobbing houses now  
 carry a full line in  
 stock, and you will miss  
 an opportunity if you  
 fail to see them. Ask  
 your jobber to show  
 you the full line.

A success beyond our expectations. Its sim-  
 plicity of operation in putting on or taking  
 off, "having no catch or snap," commends it  
 to the discriminating buyer, and has made  
 it the most popular bracelet on the market.  
 Made in plain, beautifully chased and stone  
 set, plain polished,  
 English and Roman  
 finishes, and in gold-  
 filled and sterling  
 silver.

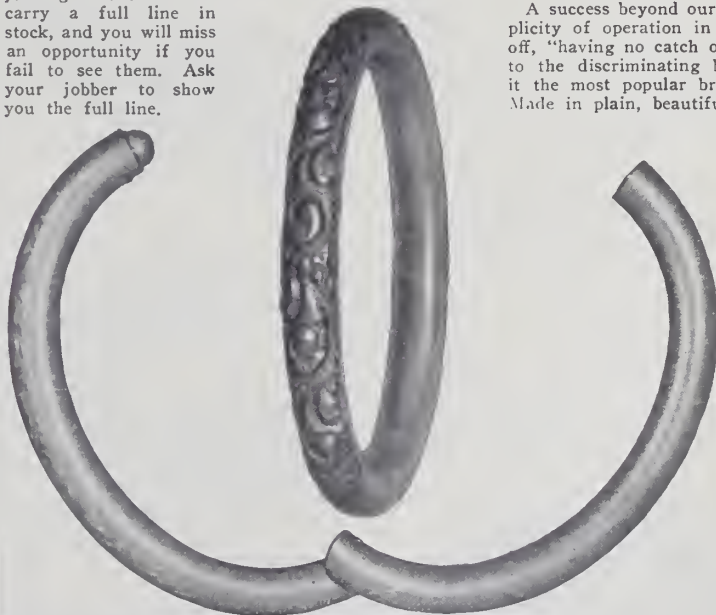

Manufactured by  
**Doran,  
 Bagnall  
 & Co.,**

North Attleboro,  
 Mass.  
 194 BROADWAY,  
 NEW YORK.  
 67 WABASH AVE.  
 CHICAGO.  
 126 KEARNY ST.,  
 SAN FRANCISCO.

Established 1879.

Manufacturer of

**LOUIS W. HRABA, Fine Leather Goods,**

29 East 19th St, New York.

Exclusively for the Jewelry Trade.

# LOCKETS

## Better Than The Best "VERIBEST"

There are Three Things Necessary to Produce the "Veribest" Locket:

First: The knowing how—"That's knowledge."

Second: The necessary facilities—"That's equipment."

Third: Wanting to do it—"That's disposition."

THAT'S OUR PART.

There is One Thing Necessary to the Purchase of the "Veribest" Locket:



Look for the  when you buy.

THAT'S YOUR PART.

These four factors give you the "Veribest" Locket with every purchase.



Every Locket stamped on inside with



Insist on "Star Quality," this Trade-Mark



MADE IN HIGHEST GRADE GOLD FILLED  
For the Jobbing Trade Exclusively.

## S. & B. LEDERER CO.

NEW YORK CITY  
9-11-13 Maiden Lane

Providence, R. I.  
100 Stewart St.

CHICAGO, ILL.  
131 Wabash Avenue

EVERYTHING IN LOCKETS AND CHAINS.

THE BASSETT JEWELRY CO.,

PROVIDENCE, R. I.



THE TRADE

desirous of keeping in touch with modern, profit-producing methods, should always consult the 500 pages of

OUR BIG CATALOGUE,

with its 30,000 illustrations and long list prices. We send this splendid book free on request.

*S. F. Myers & Co.*

Headquarters for Duober-Hampden Watches.  
WHOLESALE JEWELERS  
The New S. F. Myers Bldg. 47G-49 Maiden Lane New York.



Ladies' Fancy Stone Rings  
and Stone Scarf Pins  
in 10K. that defy  
competition.

Our reputation for making the finest and most complete line of 10-K. gold band rings is still maintained—ask your jobber.

The **EDWIN LOWE & CO., Inc.**  
F.W. BODWELL, V.-Pres. and Gen. Mgr.,  
116 Chestnut St., PROVIDENCE, R. I.  
New York Representative, E. T. Wilson, 180 Bway.  
Western Representative, S. H. Brower.

## BOSTON'S FOREMOST JOBBER HOUSE.

As manufacturers of diamond mountings, we have established a reputation for giving the greatest value at the least price. As direct importers of precious, semi-precious and imitation stones, we can serve as the repaler of your jewelry better than any other house. A full line of stones always on hand.

Write us for information, or  
Send us a trial order.

**ORKIN BROTHERS**  
373 Washington Street,  
Jewelers' Bldg., BOSTON, MASS.

## E. H. H. SMITH SILVER CO.

BRIDGEPORT, CONN.

Silversmiths' Building,  
CHICAGO, ILL.

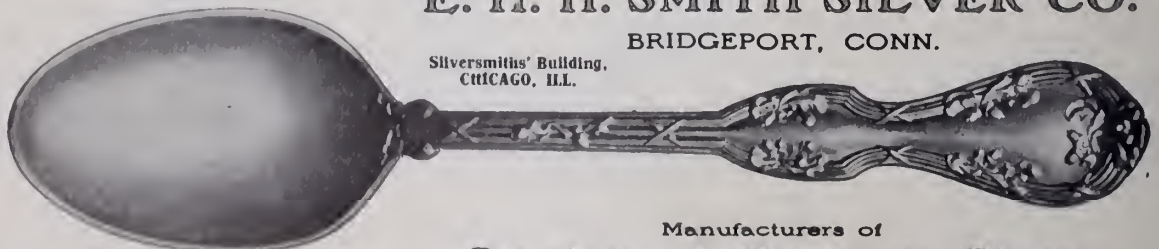

THE OAK.

Manufacturers of  
**Sterling Effects in Plate**

Write for our new catalogue.



A good many dealers like their own names on America Alarm dials—it's a standing "ad." that somebody else pays for.

Ask your jobber or write us about this.

The Western Clock Mfg. Co.  
LA SALLE, ILL.

A. Nonnenmann & J. Aschenbrenner,  
114-118 East 23d St., New York.

Original Designers for Platinum, Gold and Silver Jewelry. Artistic Designs for Silverware and Novelties furnished at shortest notice.

The ST. JAMES

Corner Walnut and Thirteenth Streets  
PHILADELPHIA, PA.

The Ideal Hotel of Philadelphia  
European Plan EUGENE G. MILLER, Mgr.

**Trade-Marks** of the Jewelry and Kindred Trades.  
Second Edition. Price, \$3.00. The Jewelers' Circular Publishing Co., 11 John St., New York.

**NORMA**  
TRADE MARK

The New  
**NORMA**

Patented  
Adjustable  
Bracelets

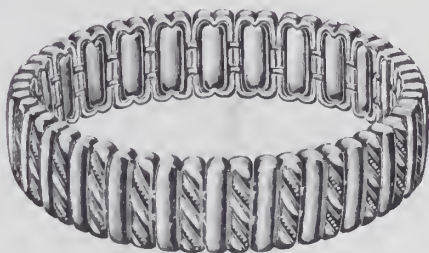

No. 253.



No. 265.



No. 254.



No. 271.



Examine our Popular Prices  
ranging from

**\$16.50 to \$36.00**  
per dozen

The illustrations represent a few of the  
many styles we make

THE QUALITY OF  
ALL THESE GOODS IS  
FULLY GUARANTEED

Send for our new  
illustrated booklet of patterns and prices

MADE ONLY BY

**The F. H.  
Sadler Co.**

80 County Street

ATTLEBORO, MASS.

Address all communications to  
Attleboro, Mass.

N. Y. Office, 180 Broadway  
Room 43

**NORMA**  
TRADE MARK

F&amp;B

F&amp;B

The  
**Gypsy**

Another of our new patterns in Toilet and Manicure goods.

Take particular notice of the new shape of Bonnet Mirror, which will be appreciated by every lady who uses one, it is so convenient. The regular shape can be furnished a little later if it is desired.

Our new line of Sterling Silver silk-lined Jewel Cases is especially attractive, and we are showing a great many Novelties which we will have illustrated in our new Catalogue, H, now in the hands of the publishers.

Owing to the phenomenal demand for

**"The Armlet,"**

the F&B invisible joint

bracelet, it has been impossible to keep pace with the orders, but we now believe we shall soon be able to make prompt shipments.

See our full lines of gold-filled Locketts, Charms, Crosses, Pendants, Chains, Fobs, Neck Chains, Collarettes, Pins, Brooches, Earrings, Link Buttons, Scarf Pins, Hat Pins, Barrette Pins, Belt Pins, Waist Sets, Buckles, Hair Chain Mountings, Ribbon Book Marks and a large line of Sterling Silver Novelties.

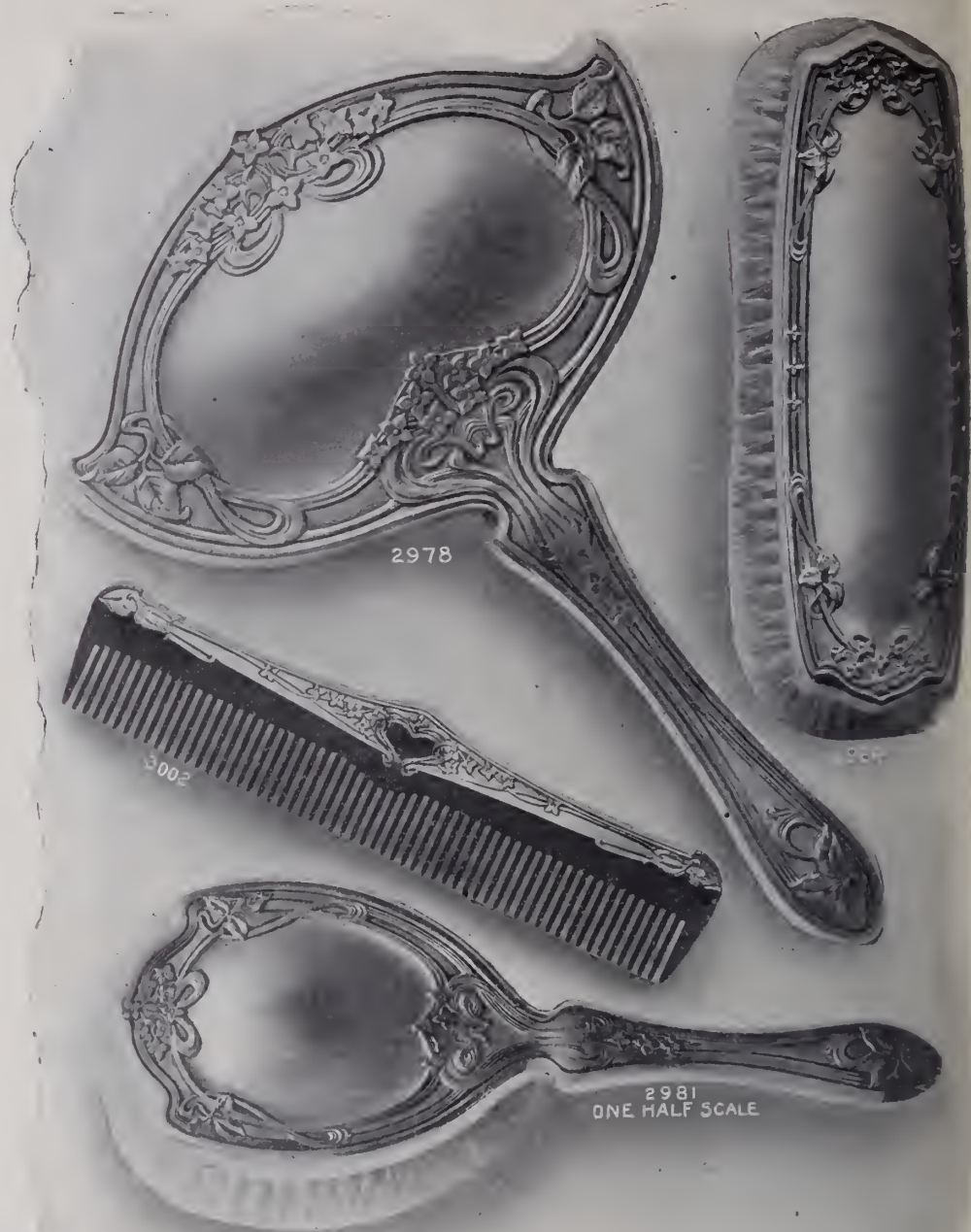

# Theodore W. Foster & Bro. Co.

Manufacturing Jewelers and Silversmiths 100 Richmond Street, Providence, R. I.

New York Salesroom  
31 Maiden Lane

Chicago Salesroom  
Heyworth Building, Wabash Avenue and Madison Street

Canadian Salesroom  
350 King Street, Kingston, Ont.



### Silver Statue Presented to the German Emperor.

ON the front cover of this issue appears the picture of a solid silver model of an officer of the Royal Dragoons in full dress uniform, mounted upon a charger, which was recently presented to the German Emperor on the occasion of his silver wedding. The statuette stands upon an ebonized pedestal, which does not appear on the cut. The pedestal has a silver plate on the front, engraved with the following inscription:

Presented to  
Their Colonel in Chief,  
His Imperial Majesty,  
The German Emperor,  
on the occasion of his Silver Wedding,  
by  
the Officers of the Royal Dragoons.  
February 27, 1906.

There is a similar plate on the reverse, having the regimental crest engraved thereon.

The statuette was modeled and manufactured by the Goldsmiths & Silversmiths' Co., Ltd., of 112 Regent St., London W., silversmiths by appointment to King Edward, and in its absolute fidelity to the smallest detail of uniform, etc., reflects the greatest credit on the makers.

### Jewelry, Clocks, Optical Goods, Watches, Silverware and Kindred Lines Exported from New York.

WASHINGTON, D. C., July 11.—The following were the exports of jewelry, silverware and optical goods, clocks, watches and kindred lines from the Port of New York for the week just ended:

Antwerp: 1 package silverware, \$300.  
Barcelona: 1 package plated ware, \$130.  
Bombay: 3 packages plated ware, \$374.  
Buenaventura: 3 packages plated ware, \$287.  
Calcutta: 53 packages clocks, \$1,035; 1 package jewelry, \$500; 2 packages jewelry, \$581.  
Cape Town: 79 packages clocks, \$1,413; 6 packages watches, \$1,129.  
Cartagena: 3 packages clocks, \$100.  
Christiania: 7 packages clocks, \$120.  
Genoa: 1 package jewelry, \$500.  
Georgetown: 1 package watches, \$163.  
Gibraltar: 1 package plated ware, \$103.  
Guadeloupe: 1 package plated ware, \$160.  
Guayaquil: 2 packages plated ware, \$343; 2 packages jewelry, \$166; 1 package watches, \$133.  
Hamburg: 4 packages jewelry, \$707.  
Havana: 50 packages plated ware, \$475; 1 package optical goods, \$317; 1 package jewelry, \$189; 13 packages clocks, \$475; 8 packages plated ware, \$145; 26 packages clocks, \$393; 2 packages watches, \$220.  
Havre: 3 packages jewelry, 500.  
Limon: 1 package plated ware, \$166.  
Liverpool: 61 packages clocks, \$1,465; 1 package watches, \$300; 1 package jewelry, \$5,000.  
London: 57 packages clocks, \$1,724.  
Madras: 1 case jewelers' supplies, \$275.  
Malta: 10 packages clocks, \$110.  
Melbourne: 56 packages clocks, \$855.  
Para: 18 packages clocks, \$525; 12 packages jewelry, \$1,823; 3 packages watches, \$452.  
Rio de Janeiro: 2 packages plated ware, \$400; 1 package jewelry, \$100; 18 packages clocks, \$567.  
Sagua La Grande: 2 packages plated ware, \$171.  
St. Thomas: 1 package jewelry, \$120.  
Valparaiso: 10 packages plated ware, \$1,503.  
Vera Cruz: 9 packages plated ware, \$268.

The Hotchkiss Jewelry Co. has moved from Brownsville, Tenn., to Water Valley, Miss. The firm style will shortly be changed to the Hotchkiss-Parsons Jewelry Co. H. C. Parsons, formerly manager for A. K. Jobe, Water Valley, will have charge of the watch department. Mr. Hotchkiss, who is an optician, will give his personal attention to the optical department.

### Reports Read at the Annual Meeting of the New Jaegersfontein Mining & Exploration Co.

THE annual meeting of the New Jaegersfontein Mining & Exploration Co., Ltd., was held in Kimberley, Cape Colony, with Col. D. Harris, the chairman, presiding. The chairman in his annual speech recalled that the profits for the financial year ending March 31, 1905, were £437,355, and the amount of blue earth on the floors was increased in that year 33,490 loads. In the year ending March 31, 1906, the net profits amounted to £437,293, and the amount of blue earth on the floors was increased 349,825 loads, making a total at the close of the fiscal year of 1,358,500 loads. The chairman emphasized the importance to a diamond mining company of having a sufficient quantity of blue earth on the floors to keep the machines continuously employed.

The total assets of the company amount to £1,309,976. The shareholders received in the last year £425,000, or £62,500 more than in the preceding year, and at the same time the assets were increased more than £10,000. The results were accomplished, said the chairman, by washing a quantity of blue 59,500 loads less than in the preceding year. This was a showing on which the chairman extended hearty congratulations to the shareholders.

The yield in 1906 was 10.89 carats from 100 loads of blue ground, an increase of two-fifths of a carat over the preceding year, when the total was 10.49. The chairman gave as a reason for the increase that the longer the blue ground is on the floor, weathering and pulverizing, the greater the prospects of an improved yield, and the amount of blue ground in the last year had been larger than in the year before, as already explained.

In relation to prices the chairman indicated that the company is getting constantly higher figures for the product. He said:

Another most important matter to which I wish to refer is the price of diamonds. In 1905 our diamonds realized, speaking in round numbers, an average of 61s. 6d. per carat. During our last fiscal year they realized 63s. 4d. per carat. The increase was in consequence of the higher price which we obtained during the first three months of the present year. We are now receiving 70s. per carat for our output, which the syndicate has again purchased for the whole of the year.

It is hardly necessary to point out that the increased price will have an important bearing on our profits. It is very satisfactory, from a point of view from those who are largely interested in diamond mining, that the demand for diamonds in the last 10 years has so enormously increased. The world is getting richer as the population increases. Ladies are just as fond of diamonds today as they were 30 years ago, and the rich men who can afford to gratify their desires in this respect are more numerous than they were at the commencement of the last decade.

I feel confident, therefore, that the present price of diamonds will be well maintained, provided the large producers accurately gauge the world's demand, and feed the market steadily and judiciously.

The police of East St. Louis, Ill., have been asked to find Gustave Hoffman, 56 years old, who recently disappeared from his home, 1314 Illinois Ave. Mr. Hoffman was a jeweler and did a small business in East St. Louis. The missing jeweler is five feet six inches tall, and weighs 145 pounds. When last seen he wore a black suit, fedora hat and a blue and black tie.

### Report on a Uniform Carat Weight Made to the Association of German Jewelers, Goldsmiths and Silversmiths.

RESPECTING the metric carat for precious stones, Privy Councillor Prof. W. Foerster writes as follows to the Association of German Jewelers, Gold and Silversmiths:

"In reply to their letter of April 19, I beg to notify the Association of German Jewelers, etc., etc., of the following facts after having been again in correspondence with the International Institute of Measures and Weights at Sèvres, near Paris, regarding the present stage of the endeavors to arrive at an understanding in this matter. By virtue of the information received, I am in a position to advise you that there is absolutely no chance of any of the countries, which have been using the metric system, legally adopting a carat weight which does not correspond to the weights admitted as standards according to the principles of the metric system. On the other hand, it is reported that a steadily increasing inclination is shown by those interested in the various countries to adopt, in lieu of the various units of the carat obtaining in the different places, an international carat, the unit of which represents a sort of mean value of the various carats, still in force at the present day, and amounts to exactly 200 milligrammes. In the International Weights and Measure Service the opinion prevails that all facilities admissible according to the tried principle of the unification of weights and measures should be granted for the denomination of such a carat. The subdivisions, according to the duodecimal system (by continued halving) heretofore in use (*i. e.*,  $\frac{1}{4}$ ,  $\frac{1}{8}$ ,  $\frac{1}{16}$ ,  $\frac{1}{32}$ ,  $\frac{1}{64}$ ), will, of course, have to be dropped in connection with the international carat, since only legally admissible subdivisions of 200 milligrammes can be considered, viz., 100, 50, 25, 10, 5, 2, 1 milligrammes, or  $\frac{1}{2}$ ,  $\frac{1}{4}$ ,  $\frac{1}{10}$ ,  $\frac{1}{20}$ ,  $\frac{1}{40}$ ,  $\frac{1}{100}$ ,  $\frac{1}{200}$  in units of the carat, which is still far more serviceable for the immediate footing-up and computation of the weighings in carat-units than the obsolete duodecimal series, to which one could, by the way, conveniently revert during the transition periods by means of conversion tables.

"Summing up, I declare, as chairman of the International Weights and Measures Committee, that everywhere great desire is shown for an international regulation of the carat-weight question, while, with all experts of the weights and measures system, the unanimous conviction prevails that a retention of the carat units used by the various countries, as conflicting with the practical unification and simplification of the common weighing system, should be combated with all legal means at disposal."

Plans for the new building to be erected by Frederick R. Coats for the manufacture of jewelers' tools, on the southwest corner of 11th and Laurel Sts., Harvard Park, Springfield, Ill., are about completed and work will be begun at once. The building will be three stories high, 150 feet in length, and the center part 42 feet square. It will have a floor capacity of 16,200 square feet.

# ACTIVITY THE KEYNOTE OF OUR PROGRESS

A SERIES OF PICTURES SHOWING  
VARIOUS FORMS OF ACTIVE LIFE.



PUSH BALL.

In the game of push ball you must have pushing ability and strength to push the ball at the right time in order to win. This is just exactly our idea of increasing our business, for we are pushing it by having more new and original ideas in all lines for Fall Trade than in all of the 40 years of our existence.

Our travelers can prove this assertion if you will but give them the chance.

**LARTER & SONS,**  
21-23 Maiden Lane, NEW YORK.

## Jewelers' League Allowed to Interplead in Order to Settle Question of Rival Claims.

In the Supreme Court, Special Term, Part I, New York, Justice Blanchard granted a motion last week, allowing an interpleader in the case of the Jewelers' League of New York against Frank Denton, in which there are rival claimants for the money to be paid out on a member's insurance policy.

The court enjoined Denton and other claimants from suing the league.

Edgar Gray, who was a member of the league, died Jan. 16 of this year. He had transferred his membership certificate to Frank Denton, who now claims the benefit money. The league maintains that benefit money is to be paid only to relatives of the deceased members, with one exception. The league pays to a creditor who has actually advanced money on the certificate, and then only repays the advances, the balance of the money going to the family.

Margarita Gray, widow of the deceased, and his children filed a claim to the benefit insurance. Mr. Denton also brought suit against the league in Orange County, New York, asking for the entire amount of the policy. The league then asked for an injunction against all the claimants, and offered to deposit an amount equivalent to the benefit money either with the court or with a trust company, until it was decided to whom the money belongs.

The hearing took place before Justice Blanchard, who decided to enjoin all the claimants from bringing suits against the league. The money was deposited in court until the claims will be passed upon as a result of the interpleader action.

## Importations at the Port of New York.

<i>Weeks Ended July 7, 1905, and July 13, 1906.</i>	
	1905. 1906.
China, Glass and Earthen Ware:	
China .....	\$96,582 \$80,505
Earthen ware .....	13,091 20,868
Glass ware .....	28,906 29,842
Optical glass .....	11 458
Instruments:	
Musical .....	20,745 15,064
Optical .....	5,979 7,947
Philosophical .....	4,054 2,676
Jewelry, etc.:	
Jewelry .....	8,901 7,429
Precious stones .....	979,836 754,094
Watches .....	18,618 26,020
Metals, etc.:	
Bronzes .....	1,386 1,775
Cutlery .....	42,266 40,729
Dutch metal .....	6,224 3,497
Platina .....	27,177 43,964
Silverware .....	386 2,092
Miscellaneous:	
Alabaster ornaments .....	262
Beads .....	2,561 3,007
Clocks .....	6,372 4,914
Fans .....	2,806 4,605
Fancy goods .....	7,141 6,579
Ivory .....	11,260
Ivory, manufactures of.....	295 139
Marble, manufactures of....	30,113 21,309
Statuary .....	10,159 6,549

Geo. W. T. Case, New Bedford, Mass., about a week ago handed over to the police a letter which he received signed "Black Hand Branch," and making all kinds of dire threats unless he placed \$1,000 worth of diamonds under a tree in the high school yard. Mr. Case declares that he regards the threat as a joke. The police suspect a crank wrote the letter.

**Dr. George F. Kunz's Report.**

**Production of Precious Stones in 1905  
Published by the United States  
Geological Survey.**

WASHINGTON, D. C., July 12.—The annual report on the production of precious stones in 1904, prepared for the Geological Survey by Dr. George F. Kunz, the gem expert, has been published and, as usual, contains a vast amount of valuable information. Through the courtesy of the Geological Survey, THE CIRCULAR-WEEKLY is enabled to present the report in full.

**INTRODUCTION.**

The year 1905 made a record for the importation of precious stones of every variety. This importation was attended by prosperity in every branch of the jewelry business, the sales ranging from the richest gems to those of the poorest qualities, and even to every known form of imitation. This record was achieved notwithstanding the Russo-Japanese war, and was due to general prosperity.

The discovery of uhalite, a green variscite, translucent, golden-green in color, and used as a gem and decorative stone, at a new locality 40 miles southwest from Salt Lake City, eight or nine miles west of Stockton, 20 miles northwest of Mercur, and 25 miles northwest of the other uhalite locality in Utah, promises to furnish a quantity of this peculiarly American stone that may be used in semibarbaric jewelry or where a rich but not precious stone is desired.

In the search for and the mining of tourmaline, beryl, topaz, kunzite and other stones peculiar to the southern counties of California, some wonderful crystals of rose-colored beryl implanted on feldspar and many fine crystals of tourmaline (red and green) are found, and in connection with these occur many specimens of great interest to the science of mineralogy. The region bids fair to excel that of the Ural Mountains, which for more than half a century has led the world in such products. So great has been the interest in California gems and their mining that the State mineralogist, the Hon. Lewis E. Aubury, requested the writer to prepare an illustrated report on the finding, the history, and the cutting of the precious stones of California, with a description of its mines. This volume, numbering 150 pages, illustrated with many plates, is now being issued by the California Bureau of Mines in San Francisco.

In the State of Maine, during 1905, prospecting and slight working was done for gems at Mount Mica, Paris, Auburn, Newry, Mount Black, Rumford, and other mining localities. But only a few gems, tourmalines, were found, and their total value did not exceed a few thousand dollars.

The turquoise mines of New Mexico and Arizona have not been as productive as formerly, but those of California and Nevada have been more so.

Rose quartz from the Black Hills of South Dakota has been cut in great quantity in the form of beads, in Germany, and has been sold over the entire world in competition with rich green aventurine with its sparkling specks of mica.

Amethyst, topaz, malachite, lapis lazuli, amazon stone from Amelia County, Va., and a great variety of stones of all quaint colors have been in greater demand than in 1904. The topaz sold is generally the variety known as "Saxon" or "Spanish" topaz. It is in reality the result of the decolorization of the smoky quartz found in Spain, Brazil and Colorado, and according to the amount of unexpelled color, it is straw-colored, amber-yellow, or rich reddish-brown. So much demand has existed for the true Brazilian yellow topaz and the pink topaz, the latter produced by heating the Brazilian yellow, that the opening of the original mines at Ouro Preto in Brazil is under discussion.

A novelty in the gem line has been the cutting of the chrysoprase, so extensively found in Visalia, Tulare County, Cal., in its iron-brown and dark-brown matrix, which forms a pleasing contrast to the golden-green color of the chrysoprase.

Highly colored gems, green, red, yellow and purple, have been in great demand, so much so that many thousands of peridots of Arizona origin have been cut, and many times more of those from Egypt. This is equally true of the California tourmalines, pink and red, and also of those from the Urals and from Madagascar and Brazil. So great

has been the demand for amethyst that the remainder of the great finds in Brazil, in 1900, and also stones from every available source have been cut, frequently into pear-shaped and diamond-shaped stones.

The emerald is still the gem in evidence. At no time has it received so high appreciation as to price. It is more than ever in demand, for the supply has been only in part sustained by the yield of the mines in the United States of Colombia. Part of the gems have been cut in the United States from the rough stones shipped directly to the firms doing the cutting. Many of the finest gems were undoubtedly taken from old jewels by the owners on the inducement of the high prices obtained.

The pearl is in as great favor as ever. The English Government has published the results of the investigations of the experts who have studied the life history of the pearl oyster, its parasites, its enemies, and the methods of further increasing its production. The present demand is causing a drain upon the Ceylon pearl banks, which have always yielded so great a revenue.

Within the last two years, and with the introduction of Louis XV. and Louis XVI. designs in jewelry, there has been immense improvement in lapidary work in the United States in every variety of stone. No better lapidary work has ever been done at any period, and every intricate form of cutting and polishing such gems as aquamarines, tourmalines, peridots, kunzite, amethyst and similar stones has been employed, including not only the round but the oblong, hexagonal, octagonal marquise, pear-shaped, and other forms set with borders of small brilliants. There has been especial preference for many of the larger stones; and never have aquamarines, tourmalines and amethysts been sold in such profusion. Probably \$100,000 worth of aquamarines from the Brazilian locality found two years ago have been used.

**DIAMOND.**

**UNITED STATES.**

There are four regions where diamonds have been met with in the United States. These are (1) the Pacific coast, chiefly along the western base of the Sierra Nevada, in the central counties of California, associated with gold in the cement gravels; (2) along the line of the moraine of the ancient ice sheet in Wisconsin, Michigan, Indiana and Ohio; these have been transported from an undiscovered source, presumably somewhere in Canada; (3) Kentucky and Tennessee; (4) the Atlantic States from Virginia to Alabama, chiefly along the eastern base of the Appalachians in what is known as the Piedmont region. The actual place of origin of the diamonds is in all these cases unknown. Those of the Pacific coast and the Atlantic States have been derived by erosion from the adjacent mountain ranges, but the original sources have never been discovered. Those of the northern drift have doubtless come from beyond our borders, in Dominion territory, and their exact source is entirely a matter of speculation. The few occurrences in Tennessee and Kentucky are not as yet definitely traceable, even in theory. All have been found in loose and superficial deposits, and all accidentally. Most of those in the Atlantic and Pacific regions have been met with in washing for gold.

This subject of the occurrence of diamonds in the United States has been treated in some detail by the writer in a report to the United States Geological Survey, to be issued in the near future.

**SEARCH FOR DIAMONDS IN BLACK SANDS OF THE UNITED STATES.**

The high price of diamonds has made the search for these precious stones in the United States and Canada keener than ever before. In the examination by the United States Geological Survey of many samples of gold and platinum sands during the Lewis and Clark Exposition at Portland, Ore., diamonds were carefully looked for. Diamonds have been watched for also by a number of parties that have been dredging for gold on an extensive scale in the rivers of California, but in neither case have any finds been reported.

**INDIANA.**

*Minerals of the Indiana Drift in Relation to Their Supposed Canadian Source.*—The only well-attested diamond discoveries in the drift region of the United States during the last four years have been those in connection with the gold washings of Brown and Morgan counties, in southern central Indiana. The writer has taken special pains to obtain a full series of specimens of the rocks and minerals found in the gold-bearing drift of this region from George C. Royce, of Martinsburg, W. Va., and Prof. Blatchley, State geologist of Indiana, and others, for the purpose of having

them compared with the rocks in Canada, north of the Great Lakes, with a view to tracing out, if possible, the source whence the diamonds came.

With the hope of aiding in the solution of this problem the collections of drift minerals and rocks from the diamond section of Indiana were sent to Canada for examination and were laid before the Ottawa meeting of the Geological Society of America, in December, 1905. Considerable discussion was awakened, but no very definite results have as yet been reached.

Among those who examined the specimens at the meeting with particular interest and expressed opinions thereon are the following Canadian geologists: Dr. A. E. Barlow, W. J. Wilson, and Prof. H. M. Ami, of the geological survey of Canada; Prof. W. G. Miller, of the Ontario Bureau of Mines; Dr. G. A. Young, petrographer, and subsequently in more detail, Prof. Frank D. Adams, of McGill University, at Montreal. All these gentlemen were especially qualified to judge of these materials by intimate acquaintance with the geology of the region under consideration and its glacial phenomena.

Dr. Barlow and Mr. Wilson recognized a number of the fragments in the collection from the Indiana drift as apparently identical with rocks familiar to them at various points in northern Ontario. Especially marked was the prevalence of pieces and rolled pebbles of jasper and jaspilite, characteristic in association with the iron ores of the Michipicoten and other iron ranges north of Lake Superior.

After the meeting of the geological society the material, consisting of some 30 samples, was sent to Prof. F. D. Adams, of McGill University, for more detailed examination. In these 30 samples there were more than 200 specimens, every one of which was carefully examined by Prof. Adams, who then divided them into groups clearly definable. These groups and the percentages which they represent he states as follows:

1. Laurentian gneiss .....	14.4
2. Quartzite .....	29.8
3. Chert and jasper .....	32.7
4. Iron ore .....	9.6
5. Amphibolite and green schist .....	6.3
6. Trap, two types .....	8
7. Sandstone, etc. ....	4.0
8. Limestone and shale .....	2.4
	100.0

No. 1 is represented by characteristic material, much of it evidently coarse pegmatite, rich in feldspar.

Nos. 3 and 4 are certainly, and Nos. 5 and 6 probably, from the iron ranges of the Huronian or Keewatin.

The pieces numbered 7 seem to be partly Keewenawan and partly Huronian, while those included under 8 are distinctly Paleozoic.

It thus appears that the portions decidedly referable to the iron ranges of the Huronian and Keewatin (Nos. 3 to 6, inclusive) make up nearly half of the whole material (49.4 per cent.), while the quartzite, No. 2 (29.8 per cent.), is largely Huronian. These rocks are widely developed north of the Great Lakes and at no great distance from them.

**KENTUCKY.**

There has been some revival of speculation as to the existence of diamonds in the peridotite dikes of northeastern Kentucky. D. Draper, a Transvaal geologist, has visited the celebrated dike at Ison Creek, in Elliott County. The lessees or owners have under consideration a plan to work a large part of this tract with diamond machinery like that used at the South African mines, and apparently this entire tract of land has been bonded and the parties engaged are endeavoring to proceed to work the place extensively, although up to the present time no definite proof exists of the occurrence of diamonds in this region. The examination made there by the Kentucky Geological Survey, under the late Prof. John A. Procter and Dr. Crandall, and also that made by J. S. Diller and the writer 17 years ago, were both without result. Recently W. C. Phelen, of the United States Geological Survey, visited the region and spent some time in the preparation of an economic bulletin on the Kenova quadrangle. He located a new outcrop of the peridotite, but was unsuccessful in obtaining any diamonds. He heard at Grayson, Carter County, that a diamond or two had been found in the Ison Creek district, but he could not verify the report.

*(To be continued.)*

S. Stacy, Lake City, Minn., has removed to Minot, N. Dak.

# HAYDEN W. WHEELER & CO.

## MOUNTED DIAMONDS

We are making up many new pieces in mounted diamonds for our Fall stock and will show new ideas and a larger and finer stock than ever.

Besides mounted diamonds, we have a large stock of loose diamonds, colored stones and pearls.

NECKLACES, BRACELETS AND LA VALLIERES ARE AMONG THE PREVAILING FADS AT PRESENT.



Trade-Mark  
Registered.

AMSTERDAM  
2 TULP STRAAT



Trade-Mark  
Registered.

LONDON  
50 HOLBORN VIADUCT

2 MAIDEN LANE, NEW YORK

TELEPHONE  
7365 CORTLANDT

ORDER

# DIAMONDS

ON MEMORANDUM FROM

## ALFRED H. SMITH & CO.

170 BROADWAY, NEW YORK.  
Corner Maiden Lane.

London.  
6 Holborn Viaduct.

Chicago,  
103 State Street.

## Oppenheimer Bros. & Veith, Cutters of Diamonds,

65 NASSAU ST. (PRESCOTT BUILDING), NEW YORK.

AMSTERDAM,  
2 Tulp Street.

LONDON,  
40 Holborn Viaduct.

CUTTING WORKS,  
Cor. Union & Nevins Sts., Brooklyn.

## HENRY E. OPPENHEIMER & CO.,

51 Holborn Viaduct, London.  
50 Rue de Chateaudun, Paris.  
7 Place Loos, Antwerp.

Tel. 621 Cortlandt.

3 MAIDEN LANE, NEW YORK.

DIAMONDS, PEARLS AND PRECIOUS STONES.

MEMORANDUM ORDERS SOLICITED.

**Two Young Men Arrested in Pittsburg Taken to Kansas City to Answer Charge of Robbing Jewelry Store.**

PITTSBURG, Pa., July 12.—Detective James Orford, of Kansas City, arrived in Pittsburg this morning and took back with him to Missouri Frederick Decker and Hugo H. Roman, two men arrested here and now charged with robbing the jewelry store of Grim & Smith, on the night of July 4. The booty, most of which was recovered, and which is valued at \$5,000, was also taken along. The prisoners, who were arrested in this city Monday afternoon, as told in the last issue of THE CIRCULAR-WEEKLY, did not know whose store they had robbed until Detective Orford arrived here and informed them. As both made a confession they did

employed as a bank clerk in Brooklyn, giving the name of the Guarantee Trust Co., and said that he was a member of the 14th Regt. of the N. G. N. Y., and had won several medals as a sprinter. He confessed that the goods found on him had been stolen.

He said that while he and Roman were standing in front of a jewelry store at Kansas City, with only 10 cents in their pockets, tired and hungry, some explosive caps were placed on the car track. Under cover of the noise one of the pair broke the show window with a brick and cleaned it out of all of the stock and then both ran away. They first went to Chicago, where they pawned some of the jewelry, securing enough money to bring them to Pittsburg. When arrested they were endeavoring to

**New Members Elected by the Jewelers Security Alliance.**

The regular monthly meeting of the executive committee of the Jewelers Security Alliance was held on Friday, the following members being present: Vice-president Champenois, Treasurer Karsch, Secretary Noyes and Messrs. Alford and Bowden, of the committee. The following new members were admitted:

I. D. Allen, Cooperstown, N. D.; J. B. Bennett & Co., Norfolk, Va.; Chas. Brandow, Bloomville, N. Y.; Jaeger Loan and Jewelry Co., St. Louis, Mo.; O. M. Nelson, Madison, Wis.; A. E. Palmer, Grand Forks, N. D.; E. Schmalz & Son and Chas. E. Zinn, St. Paul, Minn.; F. W. Birchard, Tiffin, O.; E. F. Bowman's Sons, Lancaster, Pa.; California Watch Case Co., San Francisco, Cal.; S. Callison, Dexter, Ia.; Carran & Green, San Francisco, Cal.; C. E. Cunningham, Council Bluffs, Ia.; J. F. Dailey & Co., Chicago, Ill.; Eagle Jewelry Co., Kansas City, Mo.; Eustis Bros., Minneapolis, Minn.; M. D. Franks, Omaha, Nebr.; L. E. Garrigus & Co., Newark, N. J.; L. A. Griffee, Boone, Ia.; William Hiles, Sioux City, Ia.; Jacob L. Jacobson, Omaha, Nebr.; Jassoy Bros., New York; J. Johanson and Roy A. Lee, San Francisco, Cal.; Sidney D. Lehmann, Gulfport, Miss.; S. T. Little Jewelry Co., Cumberland, Md.; Perry-Aldrich Co., Boston, Mass.; Geo. W. Pipes, Morgantown, W. Va.; Jos. O. Pokorny, Minneapolis, Minn.; Walter Starcke, Junction City, Kans.; C. G. Strippel and Tuckey & Kline, San Francisco, Cal.; G. W. Wills, Tecumseh, Nebr.; Wissing & Anderson, Sioux City, Ia.; Harrie M. Wright, Patterson, N. Y.; Percy P. Davis, Seattle, Wash.; P. H. Boyson Jewelry Co., Cedar Rapids, Ia.; W. K. Dunmore, Sterling, Ill.; Louis Freedman, New York; A. M. Greer, Iowa City, Ia.; A. A. Handle Co., Berkeley, Cal.; William Hellberg, Marshalltown, Ia.; C. Jansen, Davenport, Ia.; W. T. Miller, Marshalltown, Ia.; S. T. Morrison, Iowa City, Ia.; Eric A. Okerberg, Moline, Ill.; W. L. Phillips, New Brighton, Pa.; C. C. Price and Geo. C. Robinson, Marion, Ia.; Skidmore Drug Co., Skidmore, Mo.; Tollef Twenge, Decorah, Ia.; F. Wittstein & Sons, New Haven, Conn.

A reward of \$100 was ordered paid to J. A. Deskin and Michael J. Dugan for the arrest and conviction of Mike Hagan, professional crook, who smashed the window of Wm. J. Eroo, New Castle, Pa., and was sentenced to pay a fine of \$5 and cost of prosecution, together with the value of the goods stolen and three years' imprisonment in the Western Penitentiary of Pennsylvania. Hagan seems to have had influential friends who engaged the best criminal lawyer in that section of the country to defend him, but finding that the case would be vigorously pushed, and no compromise accepted, he finally pleaded guilty. Besides the reward, Mr. Eroo presented handsome gold and silver badges to the two officers who made the arrest, in recognition of their efficient work in the case.

The Paul-Gale-Greenwood Co., Norfolk, Va., which was recently formed by the merger of the jewelry interests of D. P. Paul, Frank H. Gale and Fred Greenwood, and which thereafter absorbed the Harris jewelry store will continue to operate two stores in this city. The headquarters of the corporation will be at Mr. Paul's present store, 190 Main St., pending the construction of the new building to be erected by the corporation at the corner of Granby St. and City Hall Ave. The Harris store will be continued in its present location, and will be known as the Main St. store of the company. The Paul store will be vacated as soon as the new building is completed, to which will then be moved the stock, offices and manufacturing departments.



FRED H. DECKER.

HUGO ROMAN.

Recently arrested at Pittsburg, Pa., and now charged with robbing a Kansas City jewelry store.

not fight extradition and went back without any trouble. Both men reside in Brooklyn and come of good families, so they say. Roman lives at 4 Decatur St., in that borough, and Decker at 11 Decatur St. The former is 22 years old and the latter 18.

The arrest was made through the cleverness of Detective Morgan McDonald, of this city. The detective was walking along Smithfield St. and saw ahead of him Roman dangling a number of rings in his hand. The officer accosted the fellow and when he refused to give satisfactory answers, took him to the central police station. In the prisoner's pockets were found 47 gold rings, two of them set with diamonds; a pearl scarf pin worth \$1,000 and two gold watches, two railroad tickets to Johnstown and two baggage checks for baggage left at Union Station. When asked who the second ticket was for Roman gave a wrong description of his partner, but, armed with a picture found on Roman, which proved to be a good likeness of Decker, the detective watched at the station, found Decker and arrested him and got his baggage. In Decker's pockets were found three rings, a watch and a pawn ticket for another ring. Decker said that he had formerly been

pawn goods in Pittsburg to get enough money to take them east.

The police are not altogether satisfied with the story of the thieves and will investigate their career. The men were neatly dressed and of good appearance.

**John J. Cerkoff, Trenton, N. J., Files Voluntary Bankruptcy Petition.**

TRENTON, July 11.—John Jacob Cerkoff, who had been in business at 145 E. State St. about a year, yesterday filed a petition in bankruptcy, through his attorney, Elwood W. Moore, Jr. The schedules show liabilities of \$1,781; nominal assets, \$1,017.

The Trenton creditors include Benjamin G. Frame, chattel mortgage on stock in store, \$250; D. Wolff & Co., goods purchased under lease, \$93; Remington Typewriter Co., \$50.

Cerkoff's assets consist of stock in trade (reversible to consignees), \$370; household goods (covered by conditional sale), \$220; tools, \$100; balance in Broad Street National Bank, 52 cents; personal property (all exempt), \$200; and accounts due from purchasers, about \$250.

He formerly worked for the Standard Watch Co., and then resided in Jersey City.

**Mr. ABE A. HELLER**  
 is now in charge of our European offices, with headquarters at  
**39 Rue de Chateaudun, PARIS.**



BIRDSEYE VIEW OF PARIS.

Many years of studying the Jewelry trade here have given our Mr. Abe A. Heller an intimate knowledge of the wants of the American Manufacturer, which will be of great advantage in selecting the right goods for the American Market.

***K. Heller & Son***

Importers of Precious and Imitation Stones.  
 New York, 51 Maiden Lane    Providence, 212 Union Street  
 Paris, 39 Rue de Chateaudun    Idar, 14 Hauptstrasse  
 TELEPHONE 219 JOHN.

GEORGE H. HODENPYL.

WALTER N. WALKER.

**DIAMONDS**  
 AND  
 DIAMOND JEWELRY  
**HODENPYL & WALKER**

Unique  
 and  
 Staple Patterns

**170 Broadway, New York**  
 Corner of Maiden Lane  
**TELEPHONE. 1898 CORTLAND**

Repairing and Recutting  
 Diamonds  
 a Specialty

<p>OUR  <b>40th</b>  <b>YEAR</b></p> <p>IN          BUSINESS</p> <p><b>1866-1906</b></p>	<p><b>DIAMONDS</b>          LOOSE AND MOUNTED</p> <p><b>CASES and MOVEMENTS</b>          ALL MAKES AND GRADES</p> <p><b>JEWELRY</b>          GOLD AND PLATED</p>
<p>ORDERS SOLICITED FROM RESPONSIBLE JEWELERS.    GOODS SENT ON SELECTION.</p> <p>All our goods are either direct importations, our own manufacture or bought for cash, enabling us to offer special inducements in prices and terms.</p>	
	<p>EST. 1866.</p> <p><i>Lissauer &amp; Company</i></p> <p>Importers.</p> <p>2 TULPSTRAAT,          AMSTERDAM.</p>
<p><b>12 MAIDEN LANE,</b>          (ONE FLIGHT UP)          P. O. Box, 1625,  <b>NEW YORK.</b></p>	

**MEYEROWITZ BROS.,**  
 IMPORTERS OF **DIAMONDS,**

**37-39 MAIDEN LANE,  
 NEW YORK CITY**

A Complete Line of Precious, Semi-Precious and Imitation Stones. Mail orders promptly attended to.

<p>London, E. C., Holborn Viaduct 17.  <b>G. MARCUS.</b></p>	<p>ESTABLISHED 1860.  <b>L. O. LEVISON.</b></p>	<p>Amsterdam, Tulpstraat 2.  <b>ALEX. FELDENHEIMER.</b></p>
<p><b>CALIFORNIA JEWELRY COMPANY</b></p> <p>Importers of  <b>DIAMONDS and PRECIOUS STONES</b></p>		
<p>SAN FRANCISCO, Temporary Office, Oakland, Delger Building</p>	<p>YOUR MEMO. ORDERS ARE SOLICITED</p>	<p>NEW YORK, 41 Maiden Lane</p>

## Retail Jewelers Form Organizations in Many States.

Successful Meetings Held in Pennsylvania, Illinois, New York, Michigan, West Virginia, North Carolina, South Carolina, Etc.—Resolutions Endorse Stamping Legislation and Protest Against Methods of Mail Order Houses.

Retail jewelers met in many States last week for the purpose of forming associations to represent the trade within each commonwealth, and to elect delegates to the convention which will be held in Rochester, N. Y., Aug. 3 and 4, for the purpose of forming a national association of jewelers. Among the most important meetings, reports of which appear below, are those of the jewelers of Pennsylvania held at Pittsburg; Michigan, at Detroit; Illinois, at Springfield; New York, at Albany; North Carolina, at Greensboro; South Carolina, at Charleston; West Virginia, at Parkersburg; Connecticut, at Hartford, and Alabama, at Birmingham. When it is remembered that organizations had previously been formed in Missouri, Michigan, Massachusetts, Iowa, Kansas, Wisconsin, North Dakota, South Dakota, Minnesota and Nebraska, it will be seen that the organizations which will send delegates to the Rochester convention will, geographically at least, be representative of the trade of all parts of the United States.

One of the remarkable features of the meetings of last week was the small attendance of jewelers both at Albany, N. Y., and Springfield, Ill., when the State associations of these great commonwealths were formed. While it is true many dealers who did not attend indorsed the movement for organization and signified their intention of coming, nevertheless it is the fact generally commented upon that larger and more prominent members of the retail trade were conspicuous by their absence. On the other hand, some of the smaller States held meetings with an attendance that might be considered representative of the trade in their State.

In North Carolina the new jewelers' association absorbed the Optical Association, while in Michigan and Tennessee the meetings of optometrists and jewelers were held almost at the same time. In Connecticut no new State association was formed, it being decided by those who attended the convention to join the old organization formed many years ago, but which has not been much in evidence recently.

### Pennsylvania Retail Jewelers' Association Organized to Correct Trade Abuses.

PITTSBURG, Pa., July 11.—The Pennsylvania Retail Jewelers' Association was organized here yesterday under favorable auspices. A Pittsburg association with most of the local retail jewelers as members will be formed in September. This city has never had a retail dealers' organization. When the convention adjourned last night it was with the understanding that it would reconvene the first Wednesday in September to hear the report of the delegates to the national convention and to organize the Pittsburg branch, which is expected to strengthen the State organization.

A. C. Graul called the convention to order and appointed J. P. Archibald, Blairsville, P. C. Yester, McKeesport, and C. E.

Snyder, Pittsburg, a committee on constitution and by-laws. The committee reported favorably on the adoption of a draft made up principally from the constitution of the national association. The dues of the association, which starts off with a membership of about 50, will be \$2 a year.

A number of resolutions were presented and adopted. The principal resolutions follow:

*Whereas*, The cause of honesty in the jewelry trade has suffered seriously from the prevalence of untrue quality marks on gold and silver products; and,

*Whereas*, The encroachment of retail mail order houses and department stores on the legitimate domain of retail jewelers have been attended with widespread and incalculable injury; and

*Whereas*, The practice of retailing by jobbers



A. C. GRAUL, PRESIDENT PENNSYLVANIA RETAIL JEWELERS' ASSOCIATION.

has grown to proportions which threaten the complete demoralization of just retail values to the great loss of the retail jewelry trade; therefore, be it

*Resolved*, That we record our condemnation of all marks on gold and silver products which are not indicative of their true quality, and that we heartily approve of the new federal stamping law relating to gold and silver jewelry, believing it will aid materially in the promotion of honest qualities and honest methods in the trade.

*Resolved*, That we favor the enactment by the general assembly of this State of legislation following substantially the lines of the federal law directed against dishonest qualities or false stamps on gold and silver jewelry, believing that supplemental legislation by the States is indispensable to the full realization of the benefits to accrue from the federal enactment.

*Resolved*, That we favor such action as shall secure to the retail jewelry trade exemption from the unfair, unjust and ruinous competition by the retail mail-order concerns, department stores, and similar alien elements, and we call upon manufacturers and wholesalers to lend their assistance in such measures as shall recognize the rights and interests of the retail jewelry trade, and afford to the trade that full measure of protection to which it is entitled.

*Resolved*, That we condemn the practice of retailing by wholesale jewelers as fraught with great and widespread injury to retail jewelers and as being fundamentally unjust in that it involves competition between the wholesaler and retailer who buys from such wholesaler. We therefore regard the practice as being hostile to the welfare

of the jewelry trade when such retail dealing is not regularly maintained as a separate business apart from the wholesale business.

*Resolved*, That it is the sense of this association that retail jewelers should confine their purchases of watches, clocks, jewelry and kindred articles, as far as practicable, to those manufacturers and wholesale dealers who restrict their sales to retail jewelers, or who sell under those conditions only which enforce retail prices recognized by the retail trade as reasonable and just.

The election of officers resulted as follows: A. C. Graul, Sharpsburg, president; J. P. Archibald, Pittsburg, first vice-president; A. Isaacs, Pittsburg, second vice-president; William Haines, Philadelphia, third vice-president; T. H. McNary, Washington, Pa., fourth vice-president; C. S. Wiley, Pittsburg, secretary; J. P. Steinmann, Pittsburg, treasurer.

The following executive committee was appointed: P. C. Yester, McKeesport, and F. E. Leitzell, Scottsdale. The following delegates were elected to represent the association at the national convention in Rochester, N. Y.: Mr. Graul, Mr. Archibald, Mr. Wiley, J. F. Brozier.

In addressing the convention, upon assuming the chair as president, Mr. Graul called attention to the abuses of the trade. His address will be given in THE CIRCULAR-WEEKLY in another issue. Extemporaneous talks followed by Mr. Wiley, Frank R. Coe, A. Katzenmeyer, Mr. Leitzell, Mr. Steinmann and others.

While the selling of goods at retail by wholesalers is deplored, Mr. Wiley said the association is not yet strong enough to correct what is termed an evil. No effort will be made for the present to prevent "curbstone" dealers from doing business, but legislation probably will be asked.

Congressman James Francis Burke and James W. Wardrop, secretary and general manager of the Merchants and Manufacturers' Association, were to have spoken, but through a misunderstanding neither appeared.

While the attendance was not as large as was anticipated, yet there is every indication that the association will be a success, because those who have joined its ranks are enthusiastic. A further increase in membership, it is expected, will be announced at the September meeting. No jobbers or wholesalers were admitted to the association.

### Jewelers of Empire State Meet at Albany and Found Association.

ALBANY, N. Y., July 11.—The Empire State has finally joined the ranks of the other commonwealths which have a State association of jewelers, an organization having been formed in this city yesterday by representatives of the trade from New York, Brooklyn, Albany, Troy, Coopers-town, Cobleskill, Auburn, Fort Edward, Albion, Batavia and other cities and towns. The meeting was held at Centennial Hall and was the result of the call issued by Henry J. Pfantz, of this city, who acted as local secretary.

The meeting was called to order by Edward Mix as temporary president, and the objects of the association were outlined to those in attendance; generally they are for the purpose of protecting members from unjust competition by retail mail order houses and to enforce the laws against false marking and branding of silver and

*WE are receiving weekly shipments of desirable goods in all sizes and grades, at prices that will interest large buyers.*

---

---

**ARNSTEIN BROS. & CO.,**

*Importers and Cutter: of*

**DIAMONDS,**

*65 Nassau Street, Corner John, NEW YORK.*

*LONDON, Audrey House, Ely Place. AMSTERDAM, 6 Tulp Straat.*

SEND TO US ANY QUANTITY OF

**AMERICAN PEARLS**

WE BUY FOR CASH.

Send by registered mail or express; we will make an offer by return mail. We will also buy any quantity of

**BAROQUE PEARLS (SLUGS).**

**BUNDE & UPMAYER CO.,**

Mack Block,

MILWAUKEE, WIS.



gold, and in other ways taking steps to remedy the evils from which the trade has suffered for some time.

No delegates were elected to represent the association at the convention, which will be held in Rochester next month, but the organization elected officers for the year as follows: President, Samuel Tappin, Troy; first vice-president, W. A. Tice, Auburn; second vice-president, Theodore A. Kohn, New York; general secretary, Henry J. Pfantz, Albany; treasurer, C. C. Bradley, Batavia; executive committee: Frederick Jennings, E. H. Souder, W. F. Antemann, Jr., William Kennedy, H. M. Seaman, John Fuhrman, Albany, and C. H. Paris, Troy.

It was decided that President Tappin make the appointment of the delegates to the national convention at a later date.

Among the jewelers attending the meeting were: M. E. Lippitt, Cooperstown; C. H. Shafer, Cobleskill; F. P. D. Jennings, Albany; Sidney A. Meren, Brooklyn; G. C. Beverly, Fort Edward; F. L. Hunke, Albany; J. W. Mende, Albany; Otto R. Mende, Albany; J. P. Buenau, Albany; R. P. Thorn & Sons, Albany; Marston & Seaman, Albany; L. M. Derby, Albion; Edward Mix, Albany; J. Strom, Brooklyn; E. H. Souder, Albany; William H. Kennedy, Albany; W. F. Antemann & Son, Albany; J. Neafach, Albany; M. Kunkel, Albany; John Fuhrman, Albany; H. J. Pfantz, Albany; C. E. Cannady, Schoharie.

In addition to the many jewelers who attended, a large number of letters were sent by jewelers in all parts of the state who were unable to be present, endorsing the movements and wishing the convention every success.

### Members of Retail Jewelers' Association of Illinois Hold Interesting Meeting and Listen to Lectures.

SPRINGFIELD, Ill., July 12.—The members of the Retail Jewelers' Association of Illinois met at the Leland Hotel in this city yesterday, and perfected the organization already formed. The officers elected at the previous meeting, April 10, and which meeting adjourned until July 11, were unanimously confirmed. The officers are: S. M. Strain, Nokomis, president; C. W. Slaybaugh, Taylorville, vice-president; H. C. Watts, Forrest, secretary and treasurer. The executive committee consists of W. H. Hammond, Bement; Andrew Anderson, Rankin; J. C. Pappmeier, Beardstown.

The meeting began yesterday by the dis-



S. M. STRAIN, PRESIDENT ILLINOIS RETAIL JEWELERS' ASSOCIATION.

tribution of badges and a call to order. The secretary read the minutes of the previous meeting, which were approved unanimously. Then followed an address by the president, who said:

#### ANNUAL ADDRESS OF S. M. STRAIN.

*Brother Retail Jewelers*—We are here today representative of the retail jewelry interests of the State of Illinois; we are here as an organization with a deliberate purpose, we have not come here simply to lay aside our work for a day and meet with no object in view no, there is that determination born of necessity, to meet the requirements of the present age and overcome the evils that beset us as a class of business men.

The Illinois Retail Jewelers' Association was formed in this room on April 10, of the current year; the attendance was small and the outlook was very discouraging to the promoters of organization; however, we who were here put on a stiff upper lip, buckled on the shield and armor and tackled the job. The outcome of our efforts was gratifying; we had many letters from all parts of the State—from large towns and small towns they came, and when we left this place we had a membership of 68. Many more have been added since that time; the prospects for a steady growth are gratifyingly flattering. Almost daily I have letters of inquiry from jewelers all over the country in regard to our aims and purposes; I have invariably answered these letters, stating that the national organization which will federate these State associations will be formed in August, and that it will be to advantage to have formed by that time all State organizations.

There is at present an unprecedented demand for organization on the part of the retail jewelers, and as soon as it is well accomplished we will be a great power in the mercantile world. Jewelers are as a rule well satisfied with their lot, and are slow as a rule to awaken to the necessity of forming organizations for the preservation of their interests, individual and collective, and as strong as the statement may seem, still the fact remains that there are few jewelers who are con-

petitors who are congenial and work harmonious. This is an end which should be accomplished.

Your president took up the work of organization in December, 1904, at which time an article appeared which met with a ready response, and among the letters received was one from E. R. Roehm, secretary of the American Association, calling my attention to that society. I at once enlisted for the war with the American Association as my army, and now I have command of the first Illinois. From time to time, as I read the reports of the forming of State organizations, I grew more and more enthusiastic; in February of this year I urged the officers of the American Association to get to work on the Illinois jewelers and urge them forward to the necessary step. Mr. Roehm, Roberson and myself went to work and the present association is the result of the hard work we did at that time, and it is the intention to keep up the work. We are not satisfied with the bare fact that we are organized, we expect to begin now to show results, and we hope to have every retail jeweler in Illinois enlisted as a member before we hold another meeting.

There is a great deal of apprehension on the part of the jeweler lest the mail order houses gobble up all the business. This is hogie, and the bogie man will not get us at all. We must put out our flag and rally round it. Some who are not alive to the situation will suffer and have suffered from their attacks, but we must fight fire with fire; advertise, offer inducements as they do, show up their methods. Tell your customers that they are not asked to buy your goods "side unseen." How many will let you blindfold them before they are allowed to select the goods? That is the way the mail order bogie man does. Can you go to one of these houses and pick out the article you want? NO, they will bring you a catalogue and let you select the article, then the house roustabout will go and get it for you, but you have passed up the coin first, and you will have to be satisfied with what is brought to you. Talk this to the customer. Tell them that if they will pass over the lucre first that you will blindfold them and let them take a grab, if they will take what they get and make no kick; tell them that in this way you will meet any catalogue house price. Our patrons are not turned so far toward these business leeches that they cannot see the justice of such arguments, still they were easily influenced to go there and by proper methods it will be easy to persuade them, they must come back to us.

I hope to have the hearty co-operation of all the jewelers who are alive to their own interests in the work we have before us; it is the intention to make this Illinois association the brightest star in the national federation, and to accomplish that end we need the undivided support of the jewelers in general.

Now we have the start, let us roll up our sleeves, start our think boxes and before we leave this city we will have well laid plans, well fraught with the purpose of correcting the existing conditions that endanger the retail jewelers.

The secretary's report showed a membership of about 150, of which 50 applications were received during the last month.

A set of resolutions and by-laws stating the object of the association were then read and adopted. The objects are the same as those of all other retail jewelers' organizations now forming, viz., to overcome the competition of mail order houses and department stores and to promote a more cordial feeling among retail jewelers themselves.

H. E. Duncan, mechanical expert for the American Waltham Watch Co., then delivered an interesting lecture on "The Main-spring, the Power Behind the Train." One of the chief points in Mr. Duncan's lecture was that in putting in a new mainspring great care should be exercised in selecting one of the desired breadth and thickness. Mr. Duncan incidentally remarked that the Waltham Watch Co. produced annually 12 tons of mainsprings.

After an enjoyable dinner the president read a paper on "Advertising," which is published in full on page 84 of this issue, and

# Chester Billings & Son

1840

Successors to  
Kandel, Barmore & Billings

1906

Importers of Diamonds  
Other Precious Stones, and  
Pearls, Diamond Jewelry

1840, Kandel & Barmore; 1866, Kandel, Barmore & Co.; 1880, Kandel, Barmore & Billings; 1897, Chester Billings & Son

New York, 58 Nassau Street, 29 Maiden Lane  
London: 22 Holborn Viaduct, E. C. Paris: 53 Rue de Chateaudun  
Amsterdam: 2 Culp Straat

GUESSING HAS CEASED TO BE A VIRTUE.

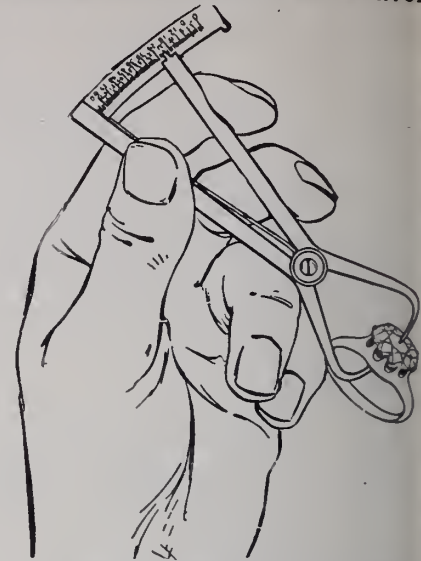

**THE MOE DIAMOND WEIGHT GAUGE** is the only correct system for determining the weight of mounted diamonds. INDORSED BY THE LEADING JEWELERS. Those who are not familiar with the device, kindly send for descriptive booklet.

Charles Moe, Inventor, 80 Adams St., CHICAGO, U. S. A.

Price for Instrument and Book, \$3.75 prepaid.

May also order from the following agents: D. C. PERCIVAL & CO., Boston; CROSS & BEGUELIN and R., L. & M. FRIEDLANDER, New York; M. SICKLES & SONS, Philadelphia; NORDMAN BROS., San Francisco; E. & J. SWIGART, Cincinnati; LEONARD KROWER, New Orleans.

BACKES & STRAUSS, Sole Agents for Europe and India, London, E. C., 14-17 Holborn Viaduct.

## REMOVAL NOTICE!

### THE LYONS GEM CO.,

Have Removed to

35 Maiden Lane, New York.

A FULL AND COMPLETE LINE OF PRECIOUS, SEMI-PRECIOUS AND IMITATION STONES ALWAYS IN STOCK.

Our Specialty is Scientific Rubies.

Local and out of town jobs promptly attended to at reasonable prices. Send us your mountings to be set with matched stones. A trial order will convince you that our prices are right, and our goods select.

## COOPER'S SUN RAY DIAMOND

HAS 100 per cent. more brilliancy than any other style of cutting.

*We Challenge the World.*

Send your old mine and yellow diamonds to be recut; if the effect is not 100 per cent. better, NO CHARGE.

### COOPER DIAMOND

Cutting and Polishing Industry of America

49 MAIDEN LANE, NEW YORK.

Factorles, 8th Ave. & 18th St., Brooklyn.



# EDUARD VAN DAM

## GARREAU & GRISER

38 & 70 Nassau St., New York.

LAPIDARIES. PRECIOUS STONES  
GEMS in Unique Cuttings.

### EDMUND R. NEBELING Diamond Setter

49 Maiden Lane - NEW YORK  
Telephone, 5039 John

Gypsy and Platinum Work a Specialty. Mail Orders promptly attended to. Write us for references

### Encyclopedia-Dictionary

and reference hand-book of the Ophthalmic Sciences. Price, \$2.50.

The Jewelers' Circular Pub. Co., 11 John St., N. Y.

the secretary read a paper on "Unfair Competition."

C. T. Higginbotham, the superintendent of the South Bend Watch Co., then delivered an interesting lecture on "The Escapement, the Most Vital Part of the Modern Watch." This was illustrated by wooden models and attracted the undivided attention of all present. After his lecture Mr. Higginbotham answered questions in regard to the escapement to the satisfaction of all present.

The association then went into executive session, and vital questions were discussed. It was agreed to affiliate with the Retail Jewelers' Association of Cook County.

S. M. Strain was elected a delegate to the Rochester convention, with power to appoint an alternate in case he could not go. The time and place for the next meeting was not decided on, but was left to the executive committee. It will probably be held in Chicago.

The following members were present: F. B. Tinker, Chicago; Andrew Anderson, Rankin; Frank B. Means, with M. M. Sovers, Lexington; S. Sve, Pana; J. F. Goudy, Fairbury; E. F. Randolph, Farina; H. C. Watts, Forrest; E. E. Barber, Sullivan; E. W. Bassett, Jacksonville; D. W. McDermond, Buda; J. H. Schmith, Clinton; B. M. Judd, Colfax; George C. Schreiber, Lincoln; G. A. Donaldson, Girard; L. A. Gardner, Edwardsville; C. W. Siaybrough, Taylorville; S. M. Strain, Nokomis; Sam Bentley, Raymond. Among the representatives of manufacturers were H. E. Davran, with the Waltham Watch Co.; C. T. Higginbotham and J. W. Frazier, with the South Bend Watch Co.; A. L. Sackett, with the Duober-Hampden Watch Works; Chas. H. Tew, with the E. Howard Watch Co., and Geo. F. Johnson, J. W. Arnbruster and A. S. Wormwood, with the Illinois Watch Co.

Many letters were received from members who regretted they could not attend the meeting, and the next meeting promises to be better attended.

#### Annual Convention of the Opticians of Tennessee Held at Nashville.

NASHVILLE, Tenn., July 11.—The Tennessee Opticians' Society met here last week, with sessions Friday and Saturday. A number of thoughtful and instructive addresses were delivered. President H. J. Cook, Knoxville, pronounced the meeting the best attended and most interesting held since the organization of the society. The convention will be held next year at Knoxville, on a date to be fixed by the executive committee.

Following was the programme of the two days' session: President's address, "Organized Effort," William E. Huston, Kansas City, Mo., secretary American Optical Association; "Educational Benefits of Organization," Weakley Ruth, Shelbyville; "Optical Practice," D. M. Quarles, Clarksville; "Optical Organizations of To-day," H. J. Cook, Knoxville; "Therapeutic Optics," Dr. W. S. Metcalfe, Knoxville; "Social and Pecuniary Benefits of Organization," H. W. Liggette, Memphis; "Professional Status of Opticians," C. L. Andrews,

Union City; "Eye Strain and Its Relation to Health," Dr. Edward Goetz, M.D., Knoxville; X-ray exhibit, Prof. W. O. Horner, Cleveland, O.

In all the addresses delivered before the meeting the prime object of the organization was emphasized—that is, the necessity of placing the optician's business on a higher plane. The paper read by Dr. Goetz was of special interest because of the fact that in early life he was a jeweler, then he became an optician and finally acquired the title of M.D.

The following officers were elected for the ensuing term: Dr. H. J. Cook, Knoxville, president; Harry J. Liggette, Memphis, vice-president; Weakley Ruth, Shelbyville, secretary and treasurer; D. M. Quarles, Clarksville, chairman of the executive committee, and George R. Calhoun, Nashville, and Prof. W. O. Horner, Cleveland, members of the executive committee.

A resolution was passed extending thanks to the Merry Optical Co., of Memphis, for its handsome exhibit of opticians' wares.

#### Tennessee Jewelers Form State Association and Elect Officers.

NASHVILLE, Tenn., July 11.—A number of retail jewelers of the State met at the Maxwell House, Saturday morning, and organized the Tennessee Retail Jewelers' Association. The organization will be affiliated with the National Retail Jewelers' Association.

The following officers were elected: J. B. Carr, Nashville, president; R. B. Herzer, Nashville, secretary and treasurer; L. Fish, Chattanooga, first vice-president; J. Malford, Memphis, second vice-president. Executive Committee: George R. Calhoun, Nashville; H. J. Cook, Knoxville; W. O. Horner, Cleveland; J. W. Thornton, Knoxville; Weakley Ruth, Shelbyville; E. B. Cayce, Franklin; D. M. Quarles, Clarksville.

Delegates to the national association, which will meet in Rochester, N. Y., August 3, were selected as follows: H. J. Cook, G. R. Calhoun, W. O. Horner, Weakley Ruth and D. M. Quarles.

Resolutions were adopted, declaring the purposes of the association to work for the abatement of trade abuses, to promote legislation prohibitive of deceptive marks, and to co-operate in measures for the improvement of conditions of education, apprenticeship and employment. These resolutions were prepared by a committee composed of George R. Calhoun, chairman; D. M. Quarles and E. B. Cayce.

#### Texas Optical Association Meets at Waco and Elects Officers.

WACO, Tex., July 11.—The Texas Optical Association held an annual meeting here in the last two days, at which an attractive programme was carried out, a number of members speaking on subjects of interest to the trade.

The following are the officers of the association: Dr. West Cathcart, Fort Worth, president; B. R. Stocking, Belton, secretary; John Wyche, Waco, chairman executive committee.

#### North Carolina Jewelers Form a State Association and Absorb the Optical Organization.

GREENSBORO, N. C., July 11.—Twenty jewelers from different parts of the State met in the rooms of the Chamber of Commerce in this city yesterday and organized the North Carolina Retail Jewelers' Association. Letters from 113 other jewelers in the State were received stating that they would join.

The meeting was called to order by R. C. Bernau, of this city. He introduced Mayor T. J. Murphy, who delivered the address of welcome. Mayor Murphy said that he was glad to see so many jewelers present, as he knew they were all "bright" men. In closing, he congratulated them upon organizing a State association and hoped that it would grow until it had all the jewelers of the State as its members.

The call for the meeting was read, setting forth that the objects for which the new organization is to strive, are as follows:

First—To get acquainted with each other.  
Second—To correct trade abuses, such as wholesale dealers selling at retail; price cutting; department stores advertising goods for less than honest goods can be bought, and also to see that the new stamping law is enforced.

The following members were appointed to draft a constitution and by-laws: H. E. Vogler, Winston-Salem; J. T. Burke, Wilmington; J. H. Bell, Concord; W. C. Correll, Concord; S. Schiffman, Greensboro. The committee made its report, which was adopted. The constitution and by-laws are nearly the same as those of the Iowa Retail Jewelers' Association.

The following officers were elected: President, R. C. Bernau, Greensboro; vice president, H. E. Vogler, Winston-Salem; secretary and treasurer, A. P. Staley, High Point; directors, J. T. Burke, Wilmington; C. N. Brown, Winston-Salem. These five officers will also constitute the executive committee for the next year.

Messrs. R. C. Bernau, Greensboro, and A. P. Staley, High Point, were elected delegates to the National Retail Jewelers' Association, which meets in Rochester, N. Y., Aug. 3.

The following communication was received from the North Carolina Optical Association, which was accordingly merged in the jewelers' organization:

"We, the remaining members of the State Optical Association of North Carolina, do this day declare the said optical association disbanded by the order of the officers of said association. The treasurer is hereby requested to turn over to the treasurer of the North Carolina Retail Jewelers' Association all the funds and papers with his final report. A. P. Staley, president; R. C. Bernau, secretary; W. H. Leonard, treasurer; H. E. Vogler, vice-president; C. F. Denny, finance committee."

The following jewelers were present: J. H. Bell, Tarboro; J. S. Campbell, Washington; C. N. Brown, Winston-Salem; J. R. Ellington, Greensboro; C. H. Wallace, Washington; J. E. Deans, North Wilkesboro; C. F. Denny and L. H. Covert, Greensboro; W. H. Leonard, Salisbury; S. Schiffman, Greensboro; A. P. Staley, High

# WM S. HEDGES & CO.,

IMPORTERS AND CUTTERS OF

## DIAMONDS.

Precious Stones and Pearls.

170 Broadway, Corner Maiden Lane, New York.

27 Holborn Viaduct, London.

# Saunders, Meurer & Co. Cutters and Importers of

## DIAMONDS AND OTHER PRECIOUS STONES

FINE PEARLS A SPECIALTY.

65 Nassau St., cor. John St., Prescott Building, Telephone. 1613 Cortland. NEW YORK.

# Chas. L. Power & Co., Cutters and Importers,

## DIAMONDS

AND OTHER PRECIOUS STONES,

170 Broadway, corner Maiden Lane, NEW YORK.

27 Holborn Viaduct, London.

# GOODFRIEND BROS.,

IMPORTERS AND CUTTERS OF PRECIOUS AND IMITATION STONES.

Pearls

Rubies

Sapphires

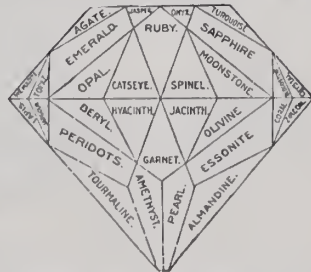

Tourmalines

Gem Corals

Opals

Emeralds

COPYRIGHT, 1895, BY GOODFRIEND BROS.

256 Westminster St., Providence, R. I.  
10 Rue Cadet, Paris.

Tel. No. 662 Cortl.

9-11-13 Maiden Lane, New York.

# CORAL

**BORRELLI & VITELLI,**  
CORAL MANUFACTURING COMPANY,

All kinds of Coral—DROPS, BUTTONS, LENTILLES.  
CORAL NECKLACES, Graduated and Uniform.

PINK AND WHITE CORAL A SPECIALTY.

GOLD MEDAL, ST. LOUIS, 1904.  
GRAND PRIX, LIÈGE, 1905.

3 Via Amedeo, Torre del Greco, Italy. 32 Rue d'Hauteville, Paris, France.

401 Broadway, New York.

Telephone, 5412 Franklin.

CORAL

CORAL

Point; R. C. Bernau, Greensboro; W. C. Correll, Concord; H. E. Vogler, Winston; J. T. Burke, Wilmington; O. V. Hutchins, Yadkinsville; J. W. McCulloch, Lexington; N. P. Cox, Asheboro, and J. A. Gentry, Winston.

### West Virginia Jewelers Organize at Parkersburg.

PARKERSBURG, W. Va., July 12.—A most important convention to the jewelry trade of West Virginia was held yesterday at the Chancellor Assembly Hall, in this city, and a State organization of jewelers, known as the West Virginia Retail Jewelers' Association, was formed. The meeting was called by C. Edmond Baab, the local secretary, and was originally to have taken place Tuesday, but was later postponed until yesterday.

The association elected the following officers for the ensuing year: President, A. Westmyer, Wheeling; first vice-president, C. A. Wernecke, St. Mary's; second vice-president, C. D. Springston, Spencer; general secretary, C. E. Baab, Parkersburg; treasurer, A. H. Setron, Parkersburg.

The most important resolutions adopted were similar to those adopted by the Pennsylvania jewelers (published on page 43).

### Michigan Society of Optometrists Hold Annual Convention—To Continue Agitation for State Law.

DETROIT, Mich., July 14.—The Michigan Society of Optometrists held its annual convention here July 11-12, the principal business session being on Wednesday. President Peter Scholler, of Hancock, was unable to be here, so Vice-President Evan Thomas, of this city, called the meeting to order. Mr. Scholler's address, reviewing the work of the year in Michigan, was read by Mr. Thomas.

The principal topic of discussion was "Our Optical Bill." There was unanimous approval of the plan again to go to the legislature next Winter, and work for a law creating a State board of examiners to pass upon the qualifications of opticians. The oculists vigorously opposed this bill a year ago last winter.

The programme of papers read was as follows: "Muscular Asthenopia," E. W. E. Paterson, Grand Rapids; "Spasm of Internal Strabismus," J. D. James, Detroit; "Michigan Society of Optometrists—Past and Future," Ernest Eimer, Muskegon; "Prisms," A. W. Kludt, Detroit; "Diagnosis of Error of Refraction by Skiascopy," N. K. Standart, Detroit; "Ocular Symptoms of Locomotor Ataxia," Dr. John S. Owen, Detroit; "Health Ray Lenses," Dr. Arthur C. Campbell, Topeka, Kan.

Officers were re-elected as follows: President, Peter Scholler, Hancock; vice president, Evan Thomas, Detroit; secretary-treasurer, Ernest Eimer, Muskegon; members of the Board of Directors—Albert W. Kludt, Detroit, and W. R. Stevenson, Holland. It was decided to hold the next annual meeting here in July in conjunction with the convention of the Michigan Retail Jewelers' Association.

Charles Djuiberg has sold his business at Turtle Lake, N. Dak.

### Michigan Jewelers Hold Annual Convention and With the Opticians Are Pleasantly Entertained.

DETROIT, Mich., July 11.—Two hundred and fifty-five members of the Michigan Retail Jewelers' Association and the Michigan Society of Optometrists, with the wives of many, were here, this week, attending their respective conventions. As 60 per cent. of them are both opticians and jewelers, the two conventions were in close harmony, members of both bodies taking in the boat ride to the St. Clair Flats, Thursday afternoon. This entertainment was provided by the Detroit Jewelers' Board of Trade, consisting of manufacturing and wholesale jewelers and opticians.

The jewelers attempted to hold a session on the steamboat, but there was too much amusement, and no business was transacted until Friday, when President P. J. Koke, of Grand Rapids, called the delegates to order in the Hotel Normandie convention hall.

The Hon. Sidney A. Bigney, of S. O. Bigney & Co., Attleboro, Mass., delivered an address, of an informal character, calling attention to the prosperous condition, not only of the jewelers, but of men in every class of industry. He vigorously advocated the strenuous life, especially in business, and heartily endorsed the organizing plans of the retail jewelers of the country.

Informal talks were also given by A. L. Sackett, of the Dueber-Hampden Watch Co., Canton, O.; L. Boyle, Chicago; R. L. Weyhing, of Weyhing Bros. & Co., Detroit; H. C. Carpenter, of the South Bend Watch Co., South Bend, Ind.; and W. B. Robertson, Detroit.

There was no contest over the election of officers, the following being chosen: President, Fred Russell, Mt. Pleasant; vice-president, Clark D. Gardner, Manistee; secretary-treasurer, Sidney D. Thompson, Shepherd; members of the executive committee: Wm. F. King, Jr., Adrian; E. R. Albaugh, Hillsdale.

Delegates to the Rochester convention were chosen as follows: A. B. Hull, Adrian; W. F. King, Jr., Adrian; Edward R. Roehm, Detroit; Max Jennings, St. Clair; E. R. Albaugh, Hillsdale; P. J. Koke, Grand Rapids; S. D. Thompson, Shepherd; E. E. Thomas, Detroit; C. D. Gardner, Manistee; Fred Russell, Mt. Pleasant; Frank Dyer, Caro; V. C. Morse, Ithaca; G. A. Foland, Mt. Pleasant; Joseph Siegel, Grand Rapids.

N. K. Standart, optician of Detroit, suggested that next year the two associations, which will again hold sessions here in July, be more closely allied; that they alternate forenoons for business, leaving the afternoons and evenings for entertainment. The executive committee are favorably disposed toward the proposition. The Detroit Jewelers' Board of Trade will be requested to give the excursion on the river on the last day, so as to keep all the delegates in the city.

The delegates are enthusiastic over the coming Rochester convention, and it is certain that Michigan, the mother state in the work of organization, will be well represented.

### South Carolina Jewelers Hold Convention at Charleston.

CHARLESTON, S. C., July 11.—A number of jewelers of the State took part in an interesting meeting yesterday, at which the South Carolina Retail Jewelers' Association was formally launched and officers elected for the coming year. The meeting was held in the banquet hall of the Charleston Hotel, and was called to order by R. H. Allan, of Jas. Allan & Co., who had acted as local secretary. Jas. Allan made a brief address in favor of the organization and the necessity of jewelers of this State following the example of those in other States in having a body that would represent their interests on questions which affect the trade.

A constitution and by-laws were adopted, and the following officers elected: Stephen Thomas, Charleston, president; S. Wolfram, Darlington, vice-president; R. H. Allan, Charleston, secretary; R. F. Fleming, Laurens, treasurer. Executive committee: Stephen Thomas, W. R. Bristol, S. Wolfram, R. F. Fleming, R. H. Allan, Gustav Sylvan and W. R. Thompson.

The secretary was ordered to notify all the jewelers of the State of what had been done at the meeting and extend an invitation to all to attend the next meeting, which will be held in September in this city.

The following were among the jewelers present who took part in the deliberations, and in addition the movement was indorsed in a number of letters received from jewelers in all sections of the State: W. A. Thompson, Sumter; H. W. Mabus, Charleston; S. Wolfram, Darlington; Fleming Bros., Laurens; Frank Duffy, Jr., Charleston; I. R. Duffy, Charleston; S. Thomas & Bro., Charleston; Stephen Baldwin, Charleston; Jas. Allan & Co., Charleston; Sylvan Bros., Columbia; R. S. Yeagin, Iva; J. F. O'Rourke, Charleston; W. R. Bristol, Beaufort.

### Retail Jewelers of Alabama Hold Large and Enthusiastic Meeting at Birmingham.

BIRMINGHAM, Ala., July 12.—A large and enthusiastic meeting of the retail jewelers of Alabama was held in the parlors of the Morris Hotel yesterday, and the Alabama Retail Jewelers' Association was organized.

The objects of the association are to unite in sentiment promotive of the highest welfare of the trade, to encourage the supremacy of standards of truth and honesty in all jewelry and related products, to promote legislation opposed to untrue or deceptive quality marks on jewelry manufactures and to co-operate in promoting improved conditions of education, apprenticeship and employment.

The following officers were elected: President, P. H. Linnehan, Birmingham; vice-president, R. Heine, Talladega; secretary and treasurer, Max Robinson, Birmingham.

The South Bend Watch Co., South Bend, Ind., closed its factory for one week, beginning June 30.

Mr. Roberts, Carlock, Ill., will shortly move to Danvers, in the same State. Mr. Roberts was the only watchmaker at the former place.

### Thieves Rob Three Jewelry Stores in Cleveland, O., and Escape.

CLEVELAND, O., July 14.—Last Sunday night three jewelry stores in this city were robbed and the fact was not discovered until Monday morning, when the police were notified. As the operations were identical, it is presumed that the same gang did the three jobs. Entrance was secured through the front transom in each instance and the goods taken were the best that could be found in the stores; no attempt was made to open the safes and the robbers had to be satisfied with what they could find outside and in the show cases.

The boldest piece of work was at the store of F. B. Guyon, in the Colonial Arcade, where a watchman is supposed to be on duty most of the time. The office of the Colonial Hotel also opens into this arcade. A number of watches, stick pins and other goods, amounting in all to about \$200 in value, were taken.

At the store of William J. Schwartz, 126 Superior Ave., several watches and rings and two revolvers were taken. He estimates the loss at about \$100.

Thirty-four gold watches were taken from the store of Nat. Ruggles, 431 Superior Ave., and all but six of them were solid cases. A lot of pins and other goods are missing from this store also.

Because of the time that elapsed between the robberies and the reports, there is little hope of getting any trace of the thieves. They seem to have escaped without leaving any trace. But it is believed from the manner in which they did their work that they are experienced in the business.

### Changes in Method of Assessment of Jewelers' League Proving Satisfactory.

The regular monthly meeting of the executive committee of the Jewelers' League of New York was held at the office on Wednesday of last week, the following gentlemen being present: President Street, Vice-presidents, Karsch and Gresson, Messrs. Hodenpyl, Wormser, of the committee, and Secretary Marsellus.

The usual routine of business was transacted, such as approving the treasurer's report, granting changes of beneficiaries, and admitting applicants. Payments were authorized to the beneficiaries of Frank W. Harmon, John W. Ruth, Reuben Harris, and Noah Mitchell, whose deaths occurred in the month of May.

The change in the method of assessment which went into effect on May 1, has given quite satisfactory results up to the present time, the officers say. They add that the lapse in membership, because of the change, was exceedingly low—less than one-half of what was anticipated—and, consequently, they feel most sanguine of a long and prosperous life for the organization.

The next regular meeting of the executive committee will be held Wednesday, Aug. 8.

The Paul-Gale-Greenwood Jewelry Co. was recently awarded the contract to supply the silverware to the Fairfax Hotel, Norfolk, Va.

ADDISON W. WOODHULL, President.  
FRANK K. HUFF, Vice-President.

GILBERT T. WOODHULL, Treasurer.  
WILLIAM J. McQUILLIN, Secretary.

# MOUNT & WOODHULL,

IMPORTERS OF

**DIAMONDS,  
OTHER PRECIOUS STONES,  
PEARLS, ETC.**

MAKERS OF

**FINE  
DIAMOND  
JEWELRY.**

26 Maiden Lane,

(Southwest Corner Nassau Street)

**NEW YORK.**

**PARIS ADDRESS:  
5 SQUARE DE L'OPERA.**

**BAGG, PERINE & CO.,**  
RARE SPECIMENS OF  
DIAMONDS AND OTHER  
PRECIOUS STONES,  
21 & 23 MAIDEN LANE, NEW YORK.  
Tel. No. 6228 Cortlandt.

**EMERALDS,  
DIAMONDS  
AND  
PEARLS.**

**RUBIES AND  
SAPPHIRES.**

**CABLE ADDRESS:  
MILBAGG.**

**Pearl Necklaces  
and Collarettes.**

**Mounted  
Diamond  
Jewelry**  
of every  
description.

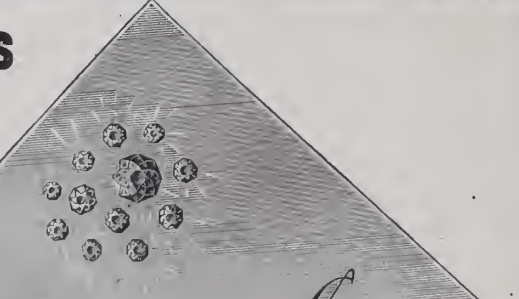

*Sinding-Nissen*

*Emil Knopf*  
*John W. Rueler*  
*Frank L. Wood*

**Large  
assortment  
of all kinds of  
very fine, fancy  
and rare gems,  
including Pearls,  
Diamonds, Rubies,  
Emeralds and Sapphires.**

182 & 184 BROADWAY  
NEW YORK

**Particularly Fancy  
Colored and Fancy  
Shaped Diamonds.**

## Death of Alfred Beit.

Head of the De Beers Consolidated Mines, Ltd., Expires in London.

A cable message received Monday from London announced the death in that city of Alfred Beit, the president of the De Beers Consolidated Mines, Ltd., a man who had been the associate of Jameson and Cecil Rhodes, and who has been rated as the richest man in England. Mr. Beit's death took place in his bachelor apartments. He was 53 years of age, and was a native of Hamburg, Germany.

That Mr. Beit was a most able assistant of Cecil Rhodes in early as well as in later stages of the development of South Africa accords with the testimony of all observers. An especially active part was taken by Mr. Beit in bringing the diamond industry into an orderly and systematic condition, and finally in organizing it into what has been declared to be the most complete monopoly in the world. While others did their share in the field work, yet it has been recognized that to Mr. Beit's commercial training and thorough business methods is due the fact that the business has been placed on a basis which has proved so satisfactory and profitable to those engaged in it for a number of years.

His labors were not limited to the diamond industry, however, as he took a prominent part in the development of the South African gold mines, and also in the building of railways and other enterprises, in many of which he was director and leading spirit. It has been said that he financed the Jameson raid. Before the Jameson commission Beit gave testimony favorable to Jameson.

Back in 1875 Mr. Beit, then an obscure buyer for the diamond firm of Lippert & Co., Hamburg, Germany, made his first appearance in the diamond field, where he soon became a prominent figure. After being on the ground a few years he established himself in business as a diamond buyer on his own account. An important change was made by him in 1882, when he joined the firm of Jules Porges & Co., of Paris, as their Kimberley representative. This firm, which had started business as diamond merchants in 1869, had from the beginning taken the keenest interest in the Rhodes schemes. In 1886 Mr. Beit became a partner in the firm. Three years later Mr. Porges retired, and the firm became Wernher, Beit & Co.

This firm is said to have assisted Rhodes more than did all others in bringing about the consolidation of the diamond interests. In speaking of Mr. Beit's share in the work Gardner F. Williams, long superintendent of the De Beers mines, said: "The great initiative and business capabilities of Mr. Beit were heartily recognized by Rhodes, Mr. Beit being largely instrumental in building up the diamond mining industries, and bringing the dreams of Rhodes into practical shape."

Beit had a university training as well as business experience to equip him for his South African work. When he reached that country not a foot of the 12,000 miles of railways had been laid, and he made the 400-mile trip from Cape Town to Kimberley in a bullock cart, along a road crowded

with madly rushing seekers after gold. He found the diamond business in a state of chaos. He saw that diamonds might become so cheap as to be profitless to mine, because of the tendency to dump the product on the market in too large lots. Aided by Cecil Rhodes, whom he preceded in South Africa by several years, he began carrying out his idea of cornering the diamond market and booming the prices by buying up scattered claims. Even before the advent of Rhodes he had become the first "diamond king." The coming of Rhodes greatly enhanced the opportunities and the fortune of Beit, and soon he became the largest individual owner of mines and land in South Africa.

He controlled the three great "cones" or mines in Kimberley, whence nearly all the diamonds of the world come. Beit amassed the largest individual fortune ever made out of gold and diamond mines. He himself could not estimate his wealth. Some people have called him a billionaire, and said that he was the richest man in the world, but in recent years a more conservative view of his great wealth has been taken.

Notwithstanding the fact that he owned or commanded the companies which owned the only diamond mines of importance in the world and controlled their output and their prices, he did not affect jewelry at all for personal adornment, and never wore diamonds.

This colossus of finance, like Rockefeller, was seldom seen, hardly known, except to the coterie of friends whom he entertained at his bachelor apartments, at 26 Park Lane, London.

His friends called him "Alf," and referred to him as the "Little Man." The following description of his personal characteristics has been given: He was undersized, bald, nervous and timid, of slender physique, with the large, luminous eyes of the dreamer, the broad head of the acquirer, the point of view of an optimist and the most amazing faculty of devising and executing schemes for getting everything he wanted. Like Rhodes, he was a man of big commercial ideas and a supreme gift of grat. He was a bundle of nerves, ill a large part of the time, and in times of excitement his nervous excitability was so distressing that it was impossible for him to sit still for a moment.

The gifts of Mr. Beit to charity in recent years are said to have been on a generous scale even for a man of his wealth. One of his latest gifts was \$500,000 to establish a hospital in Hamburg.

Three years ago at Johannesburg Mr. Beit suffered a stroke of apoplexy, since which time he has been practically an invalid.

**Market Price of Silver Bars.**

The following are the quotations of silver bars in London and New York, as reported by Zimmerman & Forshay:

	New York.	London.
July 10.....	\$.65	30 1-16d.
" 11.....	.65½	30 1-8d.
" 12.....	.65¾	30 1-8d.
" 13.....	.65¾	30 1-8d.
" 14.....	.65½	30 5-10d.
" 16.....	.65¾	30 7-16d.

**Court Refuses to Appoint Receiver for H. A. Kirby Co., But Permits Examination of Books.**

PROVIDENCE, July 11.—The case of Archibald Rutherford against the H. A. Kirby Co. and Henry A. Kirby, came up to-day in the United States Circuit Court in Providence, before Justice Brown. Jacob Fromme, of New York, and William J. Brown, of Providence, appeared for Mr. Rutherford, and Edward Bassett, of Providence, appeared for the Kirby Co. and Mr. Kirby. A hearing on oral testimony on Mr. Rutherford's motion for a receiver, and an inspection of the books of the H. A. Kirby Co., was given. The nature of the litigation was briefly outlined in last week's issue.

Mr. Rutherford commenced his action June 11, filing his bill of complaint and asking for an injunction, inspection and receiver. Mr. Rutherford claimed that he was a one-fifth owner of the \$150,000 capital stock of the H. A. Kirby Co., Mr. Kirby owning the other four-fifths. The H. A. Kirby Co. was incorporated in Rhode Island in September, 1896.

Mr. Rutherford's claims were explained as follows: "The company declared a scrip dividend in the year 1899 of \$150,000, showing that the profits were more than 100 per cent. in three years, and that Henry A. Kirby, by means of his ownership and the controlling interest in the stock of the defendant corporation, and of his position as president and treasurer thereof, wrongfully took to himself and assumed entire management and control of said corporation; that its property and assets have been and are being managed, used, and applied and absorbed by Mr. Kirby for his own use and benefit."

At the hearing it was admitted that at a special meeting called in 1905, all the property and assets of the H. A. Kirby Co. were sold to him for a promissory note of his own for \$500,000, payable in six years at four per cent., with the proviso, however, that he was to return the property intact to the company in six years, and was then to pay to the company all the surplus profits that he made over and above the four per cent. that he was to pay on his note.

The object of this transfer, it was said, was to obtain certain advantages arising from individual control of the business. The plaintiff claims that the transfer was in violation of his rights and was illegally effected.

The testimony indicated that two new stockholders were added, namely, Mr. Maher, the bookkeeper, who said that Mr. Kirby gave him 200 shares. Mr. Kirby testified that he sold 600 shares to Mr. Perkins.

Mr. Rutherford claimed that he had made a large proportion of the sales for the concern. He said that his sales were as follows: In 1897, \$119,334.31; in 1898, \$167,729.59; in 1899, \$178,227.07; in 1900, \$176,550.35; in 1901, \$183,801.25; in 1902, \$208,108.73; in 1903, \$248,445.06; in 1904, \$230,253.55; in 1905, \$250,138.24; and for the six months in 1906, about the same proportion.

It was claimed that Mr. Rutherford sold at least on an average of 40 per cent. of the whole output of the H. A. Kirby Co.,

and in 1905 and 1906, sold 50 per cent. of the output.

The court denied the application for a receiver on the ground that Mr. Kirby's financial condition is ample assurance of his ability to meet any claim against him that Mr. Rutherford may establish. An order was granted allowing Mr. Rutherford to examine all books and accounts.

**Schedules in Bankruptcy Filed by M. Sternberg, Savannah, Ga.**

SAVANNAH, Ga., July 16.—M. Sternberg, trading as M. Sternberg & Co., filed a schedule of liabilities amounting to \$46,907, with assets amounting to \$20,525, in involuntary bankruptcy proceedings, July 7. He claims a homestead exemption of \$1,600.

Following are the names of the principal creditors: State of Georgia and county of Chatham, for taxes due, \$109; city of Savannah, taxes and license, \$406; T. F. Johnson, \$575; Jacob Cohen, \$1,500; A. S. Cohen, agent, \$800; Weinman & Co., \$392; E. A. Cowan & Co., \$938; K. Marks & Co., \$810; Morris Sickels & Sons, \$118; Markowitz Bros., \$126; Wolfsheim & Sachs, \$205; H. Keck Mfg. Co., \$1,882; Rosenzweig Bros., \$153; S. Lazarus & Co., \$1,252; J. Ollendorff, \$600; Louis L. Grey & Co., \$234; H. Michelson, \$225; D. Gruen Sons & Co., \$355; Wallenstein, Mayer & Co., \$374; Empire Cut Glass Co., \$186; F. M. Whiting & Co., \$258; Fox Bros. & Co., \$380; *Morning News*, \$141; Mrs. J. Bell, \$600; Emma Muhlberg, \$10,685; Louis Muhlberg, \$5,800; Julius Rirsch, \$850; L. F. Cox, \$861; E. W. Sylvian, \$500; J. M. Rich, \$1,300; D. C. Foreman, \$100; Julius Kronkoff, \$138; Big Springs Distilling Co., \$595; J. & A. Frieberg, \$387.

Indorsed notes discounted by various banks amounted to \$10,745. The assets include stock, \$11,500; machinery, fixtures, etc., \$1,000; notes due, \$1,123; cash in hands of receiver, \$789; accounts good, \$1,000; accounts doubtful, \$5,000.

**Death of C. W. McAllister.**

Caldwell Warner McAllister, who had been at 49 Nassau St., New York, dealing in optical supplies, magic lanterns and stereopticons, under the style of Thomas H. McAllister, died Wednesday of last week in the Whittier cottage at Sea Gate in his 50th year. Death followed an operation for appendicitis.

Mr. McAllister was the son of Thomas H. McAllister, the original member of the old firm of McAllister & Bro., formed in 1853, which succeeded a business established in Philadelphia in 1793. In 1865 Thomas H. McAllister withdrew from the Philadelphia concern and came to New York, where he started the New York business. At first he manufactured and dealt in optical goods, to which he afterwards added microscopes, stereopticons, magic lanterns and other novelties. In 1879 the son, Caldwell W. McAllister, was admitted as a partner, the old style being continued.

Since the father's death in 1898 the son had conducted the business alone under the same style.

W. J. Brice, Green Bay, Wis., has started a retail business, but will continue to manufacture for the trade.

**EICHBERG & CO.,**

IMPORTERS AND CUTTERS OF

**DIAMONDS,**

65 NASSAU STREET, (Prescott Building.) NEW YORK.

**STERN BROS. & CO.,**

IMPORTERS AND CUTTERS OF

**DIAMONDS,**

CUTTING WORKS: 68 Nassau St.,  
138-142 West 14th St., N. Y. NEW YORK.  
CHICAGO, LONDON,  
103 State St. 29 Ely Place.

**LETTERS TO THE EDITOR.**

**Congratulations on the Stamping Law.**  
New York, July 12, 1906.

Editor THE JEWELERS' CIRCULAR—WEEKLY:  
At the last meeting of the Joint Committee of the Gold Bill it was unanimously voted that the thanks of the committee be extended to you for your valuable assistance in securing, by national legislation, a bill regulating the stamping of the gold product of the watch and jewelry manufacturers of the United States.

The committee realize that it is by reason of the principles that you have at all times advocated, and which are embodied in this bill, that are so just to all concerned, that the great difficulties that have always been met with in uniting the trade for a measure of this kind, have been overcome. It is these facts, and the most cordial co-operation of THE JEWELERS' CIRCULAR—WEEKLY, that made the victory possible, and thus secured for the trade a bill that we feel confident will meet with the approval of every honest manufacturer and retailer of jewelry in the country. For these reasons the committee most sincerely thank you for initiating the bill, as well as for your advice and assistance, in this very important matter.

Yours respectfully,  
(Signed) HIRAM A. BLISS,  
Chairman, Committee Federal Gold and Silver Stamping Law.

**Virginia Legal Authorities Criticised.**

DURHAM, N. C., July 11, 1906.  
Editor THE JEWELERS' CIRCULAR—WEEKLY:  
In the last issue of THE CIRCULAR—WEEKLY I notice what appears to be a most unjust criticism made against New York State's Governor by various citizens and officers of Virginia in regard to the case of John F. Kohler against W. B. Despard, who escaped in New York after he had been arrested on Mr. Kohler's complaint. In this case Mr. Kohler as well as the Governor of Virginia feels none too kindly toward the Governor of New York, owing to the fact that the authorities did not hold Despard sufficiently safe or long enough for the Virginia Governor to get him by requisition.

Now the writer has nothing to do with the matter referred to, and is unknown to Mr. Kohler, and while I wish the jeweler well in his efforts to get the man who robbed him, and like to see justice done, I would also like to call attention to the fact that the Virginia authorities are being "paid in their own coin" and receiving the same courtesy that officers of that State have offered to others in the past. I speak from experience, for I once had a similar case, where an employe who had robbed me of both goods and money took refuge in dear old Virginia, and I found that there he was as safe as if he had been in China. Though I was successful at last in getting him arrested in Virginia, the authorities did not see fit to hold him but for a few minutes and when the officers in this city got to Virginia the man was gone.

Their experience in the Despard case may serve to make the Virginia authorities more anxious to do the proper thing when a similar case arises within their jurisdiction.

NORTH CAROLINA JEWELER.

**G**EMFINDER is a finder, not only of Gems, but also of people who appreciate them.  
Among his clients are some of the most important houses in America.  
If they did not recognize his ability to supply their needs to the best advantage, they wouldn't be his clients.  
GEMFINDER is for the Trade, and the Trade only.

FREDERICK A. JEANNE,  
"Gemfinder,"  
5, Square de l'Opéra, PARIS, FRANCE

London: Chancery Lane Safe Deposits. New York: Maiden Lane Safe Deposit Co.

**A. ROSEMAN, 9-11-13 Maiden Lane, New York**

IMPORTER OF

**DIAMONDS**

Maker of Diamond Jewelry



TRADE MARK.

Established 1872

HEADQUARTERS FOR

**AMERICAN WATCHES**

IMPORTERS

CUTTERS

**DIAMONDS**

**Jacob Strauss & Sons**

14 MAIDEN LANE

NEW YORK

**SOHN and HYMAN**

IMPORTERS OF PRECIOUS AND IMITATION STONES

Crystals Engraved and Painted from Photo. Crests and Coats of Arms Engraved. Stone Seal Engravers and Incrusters. Lapidary Work a Specialty.

**JOBGING STONES A SPECIALTY**

47 and 49 Maiden Lane,

NEW YORK



# Our Traveling Representatives

John McCready, well known in the trade as a silverware salesman, has taken a position as traveler on the New England circuit for Fred H. Woodman, Boston, Mass.

Henry Freund, of Henry Freund & Bro., New York, was in Buffalo, N. Y., Saturday, on his way to the west. He said that business is good for the midsummer season.

Among the traveling representatives in Lancaster, Pa., recently, were: George Weiss, Schwarzkopf Mfg. Co.; Mr. Green, W. Green & Co.; J. Schwartz, Schwartz & Co.; S. Stern, S. Stern & Co.

The following traveling salesmen have been calling on the trade in Kansas City, Mo., during the past week: Mr. Hopkins, H. P. Sinclair & Co.; Fred M. Thanhauser, Wolfshelm & Sachs; E. R. Bennett, Waite, Mathewson & Co.

Mr. Bernskin, Tutthill Cut Glass Co.; Abel King, I. Emrich & Co.; C. T. Barbour, Wm. Bens Co.; G. W. Harder, Niagara Cut Glass Co., and A. M. Thanhauser, Wolfshelm & Sachs, were in Omaha, Nebr., last week, calling on trade.

The following traveling salesmen have been in Savannah, Ga., recently: O. J. Sommer, J. J. Sommer & Co.; John W. Steele, Jr., C. G. Alford & Co.; O. K. J. Alcom, Irons Normandy Co.; H. E. Slater, Whiteside & Blank; H. Abraham, S. Cohn & Co.

F. Perry, representing the F. H. Sadler Co., Providence, R. I.; George V. Wade, Wade Mfg. Co., Dundas, Ont.; C. M. Woodburn, E. F. Walter & Co., Montreal, and Mr. Strauss, of Backus & Strauss, London, Eng., called on the Toronto, Ont., trade, this week.

Among the representatives of wholesale houses recently in Detroit, Mich., were: W. J. Lawrence, National Steel & Copper Plate Co.; George Schwarzkopf, Schwarzkopf Mfg. Co.; Chas. H. Keif; J. T. Griffith, Jr., Carter, Howe & Co.; Chas. E. Bride, Bride & Tinckler.

Traveling representatives who paid a visit to the Cincinnati, O., trade, during the past week, included: Ike Price, Louis Strasburger's Son & Co.; Mr. Hulm, Potter & Buffinton Co.; W. A. Moore, F. W. Gesswein Co.; Sam Zimmern, Henry Zimmern & Co.; C. A. Wilkinson, C. A. Wilkinson & Co.; W. Sumner Blackinton, S. O. Bigney & Co.; N. S. Benford, W. F. Upham.

Travelling salesmen in Boston during the week, included: Harry Lissauer, Jacobson Bros.; Mr. Laurino, Saunders, Meurer & Co.; Mr. Childs, B. A. Ballou, R. W. Simpson, Jr., Riker Bros.; Mr. Royce, D. C. Dodd; John A. Lasell, Unger & Christl; Mr. Perley, Perley Bros.; C. F. Duffy, Enos Richardson & Co.; Fred Hoyt, Hoyt, Obrigg & Geiger Co.; D. D. Brokaw; Mr. Sandberg, Bergstein & Co.; Mr. Brown, Carter, Howe & Co.

## Optical Notes and Briefs.

The Berteling Optical Co. will soon move into its new store in the Cordes building, on Bush St., San Francisco.

G. H. Kahn, an optician, formerly of 105 Montgomery St., San Francisco, will soon be settled in a new store on Van Ness Ave., near Sutter St.

The Wollensak Optical Co., Rochester, N. Y., on July 7, gave a picnic at Grand View Beach, which was attended by 500 employes and many friends.

Arrangements are now complete for the annual convention which the American Association of Opticians will hold during the week of July 30 in Rochester, N. Y.

The Wisconsin Association of Optometrists held their sixth annual convention July 9-10 in Racine, and enjoyed a banquet given by the Milwaukee Optical Mfg. Co.

F. E. Luke, Toronto, Ont., has had his establishment, at 11 King St. West, completely remodeled and decorated. A private consulting room will be fitted up with modern instruments.

George H. Reynolds, of Winooski Park, Vt., recently returned from Philadelphia, where he had completed a post-graduate course in optics, and he has since opened optical parlors at 49 Church St.

John J. Bausch, head of the Bausch & Lomb Optical Co., Rochester, N. Y., was recently elected president of the Mechanics' Savings Bank, of which he has been a trustee for 30 years, being the oldest member of the Board.

J. C. Hutison, of the Hutison Optical Co., Omaha, Nebr., with his wife and children, will leave to-day for New York and Boston, to be gone a month. While in New York they will make their headquarters at the Hotel Navarre.

The Bentley Optical Co., 433 Main St., Springfield, Mass., has been sold to R. W. Morley, and will be conducted in connection with six other stores, now operating under the Morley system. The new management took possession last week, and Mr. Dodge, who has been connected with the Bentley Optical Co. since its inception, will act as local manager. Mr. Bentley, who will retain some stock in the new company, will retire from active management, and after a vacation will probably engage in the manufacturing business.

## Providence.

A. O. Ostby, of the Ostby & Barton Co., and E. C. Ostby, president of the same concern, are both enjoying vacations. E. C. Ostby is in Europe and A. O. Ostby is in the Adirondacks.

Among the imports at the Port of Providence last week were 20 packages of imitation precious stones from Bremen, 2 of imitation precious stones from Havre and one of jewelry from Southampton.

A fireman passing the refinery of John Austin & Son Sunday morning saw smoke issuing from the building and turned in an alarm. The fire proved, however, to be in the furnace and the firemen were not needed.

Herman G. Possner, Albert W. Possner and Clinton W. Brown have incorporated as the Art Die Cutting Co., with a capital

stock of \$50,000. The president is C. W. Brown, A. W. Possner is the secretary and H. G. Possner is the treasurer. The Lange & Fischer Mfg. Co. plant, recently purchased by H. G. Possner, will be used by the firm.

Ex-Lieut. Gov. W. T. Wardwells' place in Bristol was the scene of a pleasant gathering Sunday when three men who served with him as apprentices in the jewelry shop of Sackett, Davis & Williams, 52 years ago, called on him to pay their respects and exchange stories of the times of years gone by. In the party were E. R. Jones, now in the police department; R. L. Griffith, well known in manufacturing circles, and Frank L. Dimond, a retired business man. Dinner was served by Mr. Wardwell and other pleasures enjoyed.

## Columbus, O.

T. Mathison expects to leave in the near future for a three weeks' outing at Crab Lake, Wis.

Alvin Bonnet, secretary of the Frank F. Bonnet Co., has gone to Columbus Beach, Mich., for a two weeks' vacation.

John G. Gayman, secretary of the Hoffman Jewelry Co., accompanied by his wife, started Saturday for a visit at Niagara Falls and other eastern Summer resorts.

The State convention of jewelers of Ohio, to be held for the purpose of forming a State association, was not held yesterday, the date originally fixed. The Board of Trade has taken the matter up, however, and a later date may be selected.

Prof. George A. Rogers, of Chicago, who lectured before the Ohio State Opticians' Association recently, has opened a school in Columbus. With one other professor from his Chicago school he visits Columbus once a month, the remainder of the instruction being by mail. F. P. Barr, Lancaster, president of the Ohio association, also lectures occasionally before the school.

From the annual report of Referee in Bankruptcy Charles Rogers for the fiscal year ending June 30 it is learned that of the assets left by the officers of the defunct Merchants' Supply Co. but \$656.69 has been paid out in dividends, while fees, costs, commissions, etc., have amounted to \$2,570.80. This is the case in which after the company was forced into bankruptcy the officers immediately left the city and some goods and important books were missing from the office. Much of the cost bill is from an effort to locate these and untangle the business generally, many of the creditors having given consent to the expenditure of all the money due them in the case.

An attempt was made one night recently to break into the store of D. Leonheiser, Huron O. The burglar or burglars had started to cut the glass out of the front door, and finding that rather slow work, broke in one of the front windows. They were finally frightened away before securing any loot. A man was subsequently arrested near the Lake Shore flag station by Marshal Laboo, who released him upon finding no valuables in his possession. It is now believed that the released man was the culprit.

## Canadian Stamping Law Not to Go Into Operation for a Year.

TORONTO, July 11.—The gold and silver stamping bill received its third reading in the Canadian House of Commons yesterday, having previously passed the Senate. It does not go into operation for one year.

The Hon. W. S. Fielding, Minister of Trade and Commerce, explained that while the general principle of the bill had received the support of both manufacturers and dealers, there was some difference of opinion as to details. For this reason it was considered advisable to postpone the time when it shall take effect, so that various interests may make representations and any necessary changes may be permitted at the next session of Parliament.

# AMETHYSTS

THE POPULARITY OF THIS BEAUTIFUL VARIETY OF THE

## QUARTZ FAMILY

HAS CREATED A DEMAND WHICH IS OUTSTRIPPING THE SUPPLY.

WE HAVE A STOCK OF THE CHOICEST  
**URUGUAY, BRAZILIAN and AMERICAN  
ROUGH AMETHYSTS**

WHICH WE ARE PREPARED TO CUT INTO  
**BROOCH CENTERS and FANCY SHAPES**  
AT MODERATE PRICES.

WE ALSO HAVE A GOOD LINE OF FINE  
**SIBERIAN AMETHYSTS**  
IN EUROPEAN AND OUR OWN CUTTINGS.

## BUY FROM THE CUTTERS

**AMERICAN GEM & PEARL CO.**

14 & 16 Church St., NEW YORK

LONDON: 16 Holborn Viaduct

PARIS: 39 Rue de Chateaudun



TRADE-MARK.

## AZTEC TURQUOISES

Mines: MINERAL PARK, ARIZONA.



TRADE-MARK.

Of true CERULEAN BLUE, the rarest and most fashionable shade. Turquoises bearing Company's trade-mark are GUARANTEED. A new Turquoise will be given without question to replace any that discolors. The leading Jewelers of the World sell AZTEC TURQUOISES.

## THE AZTEC TURQUOISE COMPANY,

12-16 JOHN STREET, NEW YORK.

Telephone 4115 Cortland.

## LEO GOLDSMITH

IMPORTER OF

### DIAMONDS AND PRECIOUS STONES

Headquarters for RECONSTRUCTED RUBIES and SAPPHIRES. All Sizes and Forms.  
9-73 MAIDEN LANE, NEW YORK

## MAURICE BROWER

Largest Buyer and Seller of

## AMERICAN PEARLS

12-16 JOHN STREET

NEW YORK

THE BOSTON DIAMOND HOUSE

## JOHN B. HUMPHREY CO.

387 Washington St., Boston, Mass.

We are receiving Monthly Shipments of Diamonds from our Brazilian Mines, which are on exhibition at our Boston Office.

### New Stores and Enterprises.

F. X. Neuberger is a new jeweler in Spokane, Wash.

H. H. Turney recently began business in Claremore, I. T.

R. C. Bassett recently opened a jewelry store at Woonsocket, S. Dak.

Clarence Gordon has engaged in the jewelry business at Stroud, Okla. Ter.

Charles Ellis, of Menomonie, Wis., has started in the jewelry business at Elk Mound, Wis.

S. M. St. Johns & Co. recently began business in the Sanders building, on Main St., Dallas, Ga.

J. C. Larsen, of Taylor, Minn., has gone to Dodge Center, Minn., where he will engage in the jewelry business.

E. A. Wright, formerly with Millett & Stern, Lynn, Mass., has opened a jewelry establishment at Hartford, Me.

The Rocklyn department store of Davenport, Wash., has added a jewelry department to its list, and expects a shipment of goods this week.

Gilbert E. Tuttle, formerly with Mackenzie & Allen, Boston, Mass., and more recently in Conway, Mass., has established himself in business at Winsted, Conn.

M. Wohlfield has opened a new store in Massachusetts Ave., Indianapolis, Ind., with a stock of watches and jewelry, and will conduct an optical department in connection with his store.

Articles of incorporation were filed recently by the Swiss Dial Co., Waterbury, with a capital of \$2,000. The incorporators are Olga Wuest, Leon Schupbach and Chris Waremer, all of Waterbury, Conn.

The H. M. Stevenson Co. has just been incorporated to manufacture and deal in watches and jewelry with a capital of \$15,000. The incorporators are Arthur R. Jenkins, Louis E. R. French, Nelson S. Hallett, Buffalo, N. Y.

Oscar Caesar, Fort Henry, N. Y., will on Oct. 1 open a jewelry store at 470 Broadway, Saratoga, N. Y., in the premises now occupied by E. J. Vose. Mr. Caesar has had several years' experience in the business.

The Harvel Jewelry Co., Litchfield, Ill., was recently incorporated with an authorized capital of \$100,000. The following officers were elected: President, S. O. Harvel, Litchfield; vice-president, E. E. Burson, St. Louis; secretary, C. E. Randle, Mt. Vernon; treasurer, W. L. Wooster, Litchfield.

### Jewelers Gold Bars Withdrawn and Exchanged at New York.

Week Ended July 14, 1906.

The U. S. Assay Office reports:  
Gold bars exchanged for gold coin...\$1,195,740.90  
Gold bars paid depositors..... 144,977.78

Total .....	\$1,340,718.68
Of this the gold bars exchanged for gold coin are reported as follows:	
July 9.....	\$16,416.81
" 10.....	5,171.83
" 11.....	82,560.65
" 12.....	117,835.34
" 13.....	36,750.77
" 14.....	.....

Total .....

Total .....

R. Wickman, Oakland, Cal., has admitted a partner in the business, and the firm style is now Wickman & Van Vranken.

## News Gleanings.

Henry Peetz has discontinued his jewelry business in Davenport, Ia.

Robbers broke into Isaac's store, at Boone, Ia., on the night of July 6 and stole \$100.

S. J. Stieglitz, Crookston, Minn., has re-decorated his store and made improvements.

W. F. Tetro, formerly of Waterbury, Conn., has bought out Herbert L. Gould, Florence, Mass.

The West Silver Co., Taunton, Mass., is setting up a new boiler to increase the efficiency of its power plant.

An electric illuminated sign was hung outside his store, last week, by Elmer J. Faust, 728 Hamilton St., Allentown, Pa.

Fred Horning, Hillsboro, N. Dak., has gone to Grafton, N. Dak., to take charge of the business of his uncle, G. W. Foogman.

F. Weiland, Pitzville, Wash., died recently at his home. He had been in poor health for some time, but his death came unexpectedly.

W. S. W. Blake, who recently opened with a stock of jewelry at 3 E. Superior St., Duluth, Minn., is arranging to enlarge his stock.

G. K. Claxton, dealer in antiques and Oriental jewelry, will soon occupy a store on Van Ness Ave., near Sacramento St., San Francisco.

R. L. White, Greenwood, S. C., will move his jewelry store into the room now occupied by Mrs. A. J. Sproles as a millinery store, Sept. 1.

D. D. Sullivan, Fargo, N. Dak., advertises that he will close out his jewelry business, owing to the increase of business in the optical department.

A loss of \$800 was caused in the jewelry store of E. Waldmeier, Gulfport, Miss., by a fire which destroyed an entire business block at that place.

The Moultrie Jewelry Co. and the Moultrie Book Store, at Moultrie, Ga., have been consolidated, and will occupy the same store on N. Broad St.

All the factories in the Robinson estate buildings, Attleboro, Mass., will be forced to shut down Saturday for a week for annual boiler inspection.

Jacob Gruesen, a jeweler of Duluth, Minn., recently received a painful bruise from a transom falling while he was attempting to adjust it.

At Woonsocket, R. I., jewelers have joined with merchants in other lines in an agreement to close Thursday afternoon during July and August.

At Fargo, N. Dak., robbers recently broke into D. D. Sullivan's jewelry store. A number of men were arrested on suspicion, but were afterwards released.

I. Goodman, of the North Western Jewelry & Supply Co., Butte, Mont., has bought the remainder of the stock of the Tuttle-Greene Jewelry Co.

C. E. Edwards has moved his store in Ames, Ia., to new and larger quarters. John Keiting, of Boone, Ia., will open a jewelry stock in the room vacated by Edwards.

Wm. F. Newhall, Lynn, Mass., has returned from an enjoyable pleasure trip to Mediterranean countries. He was in Venice

just subsequent to the Vesuvian eruption.

Two watches were stolen, a week ago, from the store of J. B. Dayton, Williamsport, Pa. Edwin O'Brien, a colored man, who was arrested for theft, was held in \$500 bail.

H. K. Lee has bought the interests of his brother, K. K. Lee, Fosston, Minn., and will return to his old business. He will devote much attention to the optical business.

Charles Fales, of Fort Pierre, S. Dak., has returned from the Twin Cities after completing a course in watchmaking and jewelry. He will engage in business at once.

The custody of the children was awarded last week by the court to Mrs. Celia Wyman, who had obtained a divorce from Henry W. Wyman, jeweler, at Colorado Springs, Colo.

George J. Schaeffer, Baltimore, Md., for three years at 133 S. Broadway, has opened a store at Broadway and Pratt St., where he has associated with his brother-in-law, Louis H. Addison.

E. A. Thielans, New York, who was for many years, beginning in 1858, in the jewelry business in Mattoon, Ill., recently visited that town, where he was cordially greeted by old friends.

Geo. E. Wills, Auburn, Me., was acquitted in proceedings recently began charging him with driving with his automobile upon a sidewalk and killing a Scotch collie belonging to a resident of that place.

H. J. Webb & Co., jewelers, and the Harvey & Lewis Co., opticians, both of 360 Main St., Springfield, Mass., will close their places of business at 5 p. m., except Saturdays, during July and August.

Charles Haechlin, Colgrover, Cal., who was formerly a jeweler at St. Louis, Mo., was burned to death July 8 in a fire in the stable on his vineyard. He retired from the jewelry business several years ago.

F. M. Watts, Kirksville, Mo., was recently found unconscious on the bank of a pond near that place. The doctor pronounced it a case of morphine poisoning, and said that Mr. Watts would recover.

What remained of the stock of the Tuttle-Greene Co. was recently bought by I. Goodman, manager of the Northwestern Jewelry & Supply Co., Butte, Mont. The Tuttle-Greene Co., which was incorporated in 1901, went out of business in May, 1905.

Charles A. Fricker, of James Fricker & Bro., Americus, Ga., is at Hot Springs, Ark., where he is taking the baths and receiving treatment. He is accompanied by his wife, and expects to remain at the Springs until the latter part of August.

Included in the exhibition given during the week of July 9 by the Arts and Crafts Society, Dearfield, Mass., was a collection of work in engraving executed by Mrs. Agnes Wymne, and of jewelry and necklaces by Miss Madeline Gale Wynne and Miss Putnam.

The F. B. Rogers Silver Co. has, through Treasurer Arthur H. Williams, filed with the secretary of the Commonwealth of Massachusetts the following annual corporation report: Cash and debts receivable, \$124; profit and loss, \$49,876; capital stock, \$50,000.

Creditors of the M. E. Moore Bronze &

Plate Co., Kingston, N. Y., will meet next Monday at 10 A. M. in the office of Amos Van Etten, referee in bankruptcy, 22 Ferry St., Kingston, N. Y., for the purpose of passing upon the final report of the trustee and declaring a final dividend.

Le Roy Jones, a colored man, was arrested last week on the charge of stealing a watch valued at \$55 from the Paul store, Norfolk, Va., where he was formerly employed as a porter. It is said that he grabbed from the show case the watch, which was afterward found in Leviten's pawnshop.

Frost & Lyle, Lowell, Mass., have dissolved their co-partnership by mutual consent, Charles H. Frost retiring in order to enjoy rest and freedom from cares of trade in his advancing years. The business was established 28 years ago. J. Edwin Lyle, who has been a member of the firm for 13 years, will continue the business in his individual name.

At Eaton Rapids, Mich., the Business Men's Association is making arrangements with a company which is to manufacture self-winding clocks in that city. The proposition is for the association to donate \$15,000, and a site containing 10 acres of land. The company is then to build a factory with a capacity for employing 150 men. The names of the clock manufacturers have not been made public.

Charles T. Prescott, of Austin & Prescott, Batavia, N. Y., has bought the Clark building, at 92 Main St., in that village. Mr. Prescott has been in the building which he has just purchased more than 30 years. When he was only 16 years old he went to work there for Jerome B. Clark. When Mr. Clark died Mr. Prescott and Mr. Austin bought the business. There has been a jewelry store there since 1830. Austin & Prescott have occupied the store over 20 years.

Joe Eplan, pawnbroker at Atlanta, Ga., is accused of larceny as a result, it is said, of making a mistake in giving out pledged jewelry to the wrong persons. A man who pawned the jewelry was arrested in Montgomery on the charge of larceny. Before the trial a woman called on Eplan and, claiming that she was the rightful owner of the property, took it away with her. The charge of larceny against the man who had pledged the jewelry was not sustained. He transferred the pawn ticket to W. Baker, who caused the pawnbroker's arrest. The case is to be tried in a few days before Justice Landrum.

Wolfsheim & Sachs are now comfortably settled in their new store, 35 Maiden Lane, New York, and perhaps no more efficient stock system prevails than has been originated by this concern since the removal to the present location. A series of shelves and drawers, cased within handsomely finished oak panels, each numbered and classified, admits of finding a particular style or class of stock at a moment's notice. The show room and office, apart from the store, are attractively arranged and fitted up. The show window is illuminated with an electric reflector of modern construction, and altogether the new home is a decided improvement over the former, in both capacity and equipment.

# GORHAM SILVER

## DESK FURNISHINGS.

¶ The ever-increasing demand by people of taste and refinement for desk furnishings of solid silver has led the Gorham Company to pay special attention to the designing and manufacturing of attractive desk-sets of every description and degree of elaboration.

¶ These sets are adapted for the use of both men and women and include every article which can find a fitting place upon the desk or the writing-table. Ink Stands, Paper Racks, Blotters, Pen Racks and Holders, Paper Cutters, Calendars, Erasers, Paper Knives and Desk Pads may be had either separately or in appropriately arranged sets.

¶ To this popular line the attention of the Jewelry trade is particularly directed.

## THE GORHAM COMPANY,



CHICAGO,  
137 Wabash Ave.

Silversmiths and Goldsmiths

Fifth Avenue and 36th Street, New York.

BRANCHES:

NEW YORK,  
23 Maiden Lane.

SAN FRANCISCO,  
Temporary Office:  
1103 Broadway, Oakland, Cal.

LONDON,  
Ely Place.



WORKS: Providence and New York.

**THE JEWELERS' CIRCULAR**  
 THE HOROLOGICAL REVIEW,  
 THE JEWELERS' WEEKLY  
 THE JEWELERS' REVIEW

PUBLISHED EVERY WEDNESDAY BY  
**THE JEWELERS' CIRCULAR PUB'G CO.,**  
 11 JOHN ST. COR. BROADWAY, NEW YORK.  
 TELEPHONE: CABLE ADDRESS:  
 1148 CORTLANDT. JEWELAR NEW YORK

VOL. LII. JULY 18, 1906. No. 24.

Subscription in U. S., Canada and Mexico, \$2.00  
 Other Countries in Postal Union, - - \$5.00  
 Single Copies, - - - - - .10

Remit by check or money order. Remittances in money are at sender's risk.

Notices of changes in standing advertisements must be received one week in advance; new matter can be received up to Monday.

No attention paid to communications unless accompanied by full name and address of the writer. This is asked not necessarily for publication, but as an evidence of good faith.

**Index to Special Articles.**

Silver Statue Presented to the German Emperor. Illustrated on front cover; text on page.....	Page. 37
Exports of Jewelry, etc., from New York.....	37
Annual Meeting of New Jagerstontein Co.....	37
Report on a Uniform Carat Weight.....	37
Jewelers' League Interpleads to Settle Rival Claims.....	38
Imports at New York.....	38
Dr. Geo. F. Kunz's Report on Precious Stones.....	39
Thieves Arrested at Pittsburg Taken to Kansas City.....	41
J. J. Cerkoff Goes Into Bankruptcy.....	41
New Members of the Jewelers Security Alliance.....	41
Retail Jewelers Organize in Many States.....	43, 49
Pennsylvania.....	43
New York.....	43
Connecticut.....	45
Illinois.....	45
Tennessee (Jewelers and Opticians).....	47
Texas (Opticians).....	47
North Carolina (Jewelers and Opticians).....	47
Michigan (Optometrists).....	48
Michigan (Jewelers).....	49
South Carolina.....	49
Alabama.....	49
Thieves Rob Three Stores in Cleveland, O.....	49
Proceedings of Jewelers' League.....	49
Death of Alfred Beit.....	50
Court Refuses Receiver for H. A. Kirby Co.....	51
Schedules of M. Steinberg Filed.....	51
Death of C. W. McAllister.....	51
Letters to the Editor.....	52
Canadian Stamping Law Not to Go Into Effect for One Year.....	53
Bankruptcy Petition Against C. J. Leben.....	63
Diamond Markets.....	73
General Appraisers' Decisions.....	79
Patent Department.....	80, 81
Elsie Bee's Fashions.....	81
Watch Repairing—(Continued).....	83
A Rough Depthing Tool for Clockmakers.....	85
The History of Church Bells.....	85
New Observatory Planned by Waltham Watch Co.....	87
The Estimation of Vision in Infants and Children.....	91
The Ability to Prevent Errors of Refraction.....	91
Anatomy of the Nervous System—(Continued).....	93
Stories in Spectacles.....	93
One Jeweler's Experience at Advertising.....	94
An Up-to-Date Retail Jewelry Establishment in Lansing, Mich.....	95
General Appraisers Decide as to Duty on Fringes for Ornamenting Glass Lamp Shades.....	99
Recent Decisions as to Tariff on Porcelain Plaques, Statuary, etc.....	99
Greek Marble.....	99
Interesting Collection of Early American Silsmiths' Work in the Boston Museum of Fine Arts.....	101

**Stamping Legislation by State and Nation.** OWNING to the great number of inquiries upon the new Federal Law regulating the marking of the quality of gold and silver, which have been received by THE CIRCULAR-WEEKLY from retailers, wholesalers and manufacturers, both in the jewelry and other trades, we again call the attention of our subscribers to the fact that the new law has no provisions making it compulsory to stamp the quality upon any article made of the precious metals. It provides essentially that when the quality is stamped on an article, and the article is shipped in interstate commerce, the article must assay up to the stamp, within the limitations provided by the law in question. In other words articles of low grade gold, silver, or plate, bearing no marks that would indicate to the purchaser that they were of a particular quality of precious metal may be made and sold with impunity, but if the article is marked, the quality of the gold and silver therein must come up to the standard provided by law, or the seller or shipper in interstate commerce will be amenable to the Federal Statutes.

The law does not go into effect for a year after its passage, this having been done at the request of manufacturers who wish to have some time to adjust their business to meet its provisions. This consideration was undoubtedly given to their demand because the law essentially affects the manufacturer and wholesaler and not to any extent the retail jeweler, as it applies only to goods shipped in interstate commerce. That it will do much to stop the sale of spurious goods even within a State is evident from the fact that the jewelers and other dealers of but few States will be able to obtain goods that have not been shipped in interstate commerce and therefore have not become amenable to the provisions of the law at some time.

To absolutely protect the trade and public from all chances of fraud in the marking of gold or silver, the national law should be supplemented by State laws in all those commonwealths which to-day have no special provisions in their Penal Codes for the punishment of the man who sells or makes improperly or spuriously marked gold or silverware. While the States of New York, New Jersey, Massachusetts, Pennsylvania, Illinois, Ohio, Connecticut, Virginia, South Carolina, Rhode Island, New Hampshire, Missouri, Michigan, Maryland, Maine, Florida and Arkansas have statutes more or less broad regulating the sale and manufacture of improperly marked silverware, but three States—New York, Connecticut and Pennsylvania—have any statutory provisions relating to gold marking. That of Connecticut provides that all articles of gold must be marked, while that of New York and Pennsylvania compel no marking but provide that where the mark is placed on the articles it must assay up to the standard indicated, as defined by the statute.

It will be seen therefore that good work can be done now and in the future by the retail jewelers' associations that have been formed in the various States of the union, in connection with the question of State stamping legislation. In fact there are few more important subjects which a State

body and perhaps the national association can take up than the formation of State laws on gold and silver marking that will supplement the Federal Law in a way to make legislation on the subject uniform throughout the Union. There is little doubt that the legislatures of all States will give heed to the demand of the jewelers for any bill of this kind that will be in line with the Federal Law already enacted and merely extend the prohibitions of the latter beyond the manufacturer to the seller of spurious wares. It is pleasing to note that at nearly every convention of retail jewelers held recently the stamping legislation already enacted has been heartily endorsed, and the movement to continue the fight for perfect laws of this kind will doubtless meet with general approval.

**Jewelry Failures During June and Second Quarter.** THE general condition of business as indicated by the commercial failures during the first six months of the year ended June 30 was distinctly good. Commercial failures of all kinds numbered about 5,600 during the first half of 1906, as against about 6,200 in the first half of 1905, though the amount of the liabilities was somewhat larger this year than in the former period. Distinct improvement was shown in the statistics of manufacturing insolvencies wherein both the number and amount of liabilities greatly decreased, as compared to the figures of the first half of last year. For the second three months of the year the comparison in both manufacturing and trading lines is greatly in favor of 1906 both in number of failures and in the liabilities, as will be seen from the fact that 568 manufacturing failures were recorded in the second quarter of this year with liabilities of \$8,957,000, while 650 were recorded in the same time last year with liabilities of about \$11,400,000; and 1,838 trading failures occurred during the second quarter of this year with liabilities amounting to \$11,457,000, while 2,049 were recorded for the second quarter of 1905, with liabilities of \$12,557,000.

As far as the jewelry trade is concerned, the number of insolvencies during the second quarter of the year and the month of June are gratifyingly low. In the three months ended June 30, but 43 failures were recorded, with liabilities of \$452,662, or an average of \$10,527. According to the table of failures by branches of business compiled for *Dun's Review* there were 49 failures in the same period of 1905, with liabilities of \$650,246; 58 failures in 1904, with liabilities of \$278,107; 44 in 1903, with liabilities of \$318,219, and 46 in 1902, with liabilities of \$867,341. According to the same authority there were 13 failures among jewelry and clock dealers last month, with liabilities of \$77,237, or an average of \$5,941, as compared with 20 failures in June, 1905, with liabilities of \$119,431; 10 failures in 1904, with liabilities of \$71,982; 13 failures in 1903, with liabilities of \$41,679, and 18 failures in 1902, with liabilities of \$495,323.

Jos. Mayer & Bros., 359 Colman Building, Seattle, Wash., have increased their capital stock to \$200,000.

# Diamonds Wanted!



He swore by the bright stars  
above her.  
(You know how a lover can  
swear.)  
How he'd love her and love her  
and love her;  
And the stars twinkled down at  
the pair.  
(You know how a star can  
twinkle  
When maidens to lovers confess.)  
They want just one thing—A  
DIAMOND RING,  
"Shipped by the next express."  
An assortment of precious  
stones, loose or mounted; pins,  
rings, brooches, etc., will be  
sent to any jeweler on mem.

## CROSS & BEGUELIN

Importers and Cutters of Diamonds and Precious Stones

43 Rue de Meslay, PARIS Telephone, 2188 Cortlandt 17 Maiden Lane, NEW YORK



Do you always get perfect stone setting?

Did you ever lose a sale because your customer wouldn't wait till you could get the stone set?

Do your customers ever complain that points on their rings catch?

Did your setter ever chip a stone in getting his points down?

Then you need the **Arch Crown Mounting** with completed bearing, the only mounting ready to set.

The bearings and tips are fully completed, and it is only necessary to bring over and press down the tips. If the stone doesn't fit exactly, bend the arches in or out a little. That's all.

The tips are perfectly rounded and all are exactly the same size and shape. It's difficult to obtain such perfect setting in the old way.

Send for a sample on memo. if you wish, and try it **YOURSELF.**

### ARCH CROWN MFG. CO.

26 Camp Street, Newark, N. J.

## Last Week's New York Arrivals.

**THE CIRCULAR-WEEKLY** each day posts in its office a bulletin of the latest buyers visiting New York, which every member of the trade is cordially invited to copy.

CHICAGO, B. L. Sloan (Jos. Phillipson), Belvedere.  
CINCINNATI, O., G. Fox (The Gustave Fox Co.), Holland.  
HONOLULU, HAWAII, H. F. Wichman (H. F. Wichman Co.), Gorham Mfg. Co., 21 Maiden Lane.  
KANSAS CITY, MO., F. W. Gremmels (Emery, Bird, Thayer Dry Goods Co.), Grand.  
LOS ANGELES, CAL., Geo. A. Montgomery (Montgomery Bros.), Gorham Mfg. Co., 21 Maiden Lane.  
G. M. Williams, Imperial.  
NEW ORLEANS, LA., Leonard Krower, Grenoble.  
SCHENECTADY, N. Y., H. A. Miller (H. S. Barney Co.), 75 Spring St.  
SPRINGFIELD, MASS., F. E. Ladd (Smith & Murray), 55 White St.  
ST. LOUIS, MO., D. Fress, Gerard.  
W. Weidlich (Wm. Weidlich & Bro.), Imperial.  
TORONTO, CAN., A. C. Cuff (Ryrie Bros.), Imperial.  
TROY, N. Y., J. W. F. Podmore (Jones & Podmore), Albert.

## Newark.

M. W. Boyle, Broad St., reported to the police that an attempt had been made to rob his jewelry store Monday night of last week, but the intruders were frightened away by people living upstairs.

On the charge of swindling people by selling for \$5 and \$8 fraudulent watches a man giving the name of Andrew Burdell was arrested last Wednesday in Elizabeth. On his refunding the purchase price to complainants, Burdell was allowed to go by Judge Mahan.

Wm. C. Finck, of the Wm. C. Finck Co., Elizabeth, is one of the incorporators of the New Process Construction Co., which is to manufacture a new kind of artificial gas. The company has a capitalization of \$15,000, and is to supply the gas for the purposes of light, heat and power. Mr. Finck, who is the inventor of the process, says the company will begin by making small gas plants for private houses.

## Reappraisal of Clocks.

The following reappraisal of an importation of clocks was announced, last week, by the Board of United States General Appraisers, New York:

Clocks from Uhrenfabrik Villingen, A. G., Villingen, exported April 11, 1906, entered at New York (File No. 39827); findings of Fischer, G. A., No. 4287, gelwerk bez, No. 06842 75, bilder klockkopfen, entered at 2.40 marks each. Freight and packing included. Reappraised at 2.296 marks each, net, packed.

Taylor Bros., Houston, Tex., last week caused the arrest of H. B. Ruch, on the charge of obtaining a diamond ring costing \$80 by false pretenses. It is charged that Ruch represented himself as an employe of a prominent real estate firm, and obtained the ring as a present for his wife, promising to pay the first instalment of the purchase a couple of days later. Though making no payment, it is charged, he pawned the ring for \$20.

## New York Notes.

A fire caused a loss of \$125 to the stock of Henry Horowitz, 547 Broadway, Brooklyn, last Saturday.

Judgment for \$612 against Joseph Myers, and in favor of Fera & Kadison, 65 Nassau St., was docketed last week.

Edwin S. Simons, of Simons Bro. & Co., 13 Maiden Lane, is spending two weeks' vacation with his family in Canada.

S. Gans, of D. Lisner & Co., 140 Fifth Ave., arrived from Europe on Tuesday of last week, on the *Kaiser Wilhelm II.*

E. F. Keller, of Keller, Becker & Co., 51 Maiden Lane, left, last week, for a trip to Europe, on the *Kaiser Wilhelm der Grosse.*

Joachim Spiro, of Spiro & Hirsch, 65 Nassau St., accompanied by his family, left, recently, for their vacation to be passed in the Catskill Mountains.

A reward of \$500 is offered by Tiffany & Co. for the return of a string of pearls with a diamond clasp, lost between the Hotel Astor and Staten Island.

Reuben Mason, the vice-president of the Potter & Buffinton Co., and Mrs. Mason, have returned from a trip to Delaware Water Gap, where they enjoyed some good bass fishing.

Bernard Citroen, of Paris, against whom the government recently brought a suit to recover \$110,335 in customs duty on a necklace of pearls, has retained Alton B. Parker as counsel.

A. Eastwick Wood, representing Theodore W. Foster & Bro. Co., has been passing a few days with his wife and family at Asbury Park, N. J. He starts this week on his southern trip.

The friends of Charles H. Norton, advertising manager for Geo. Borgfeldt & Co., will be agreeably surprised to hear that he is to become a Benedict, Miss Adele Eddy Black being the young lady in the case.

A window smasher pitched a brick through the front glass window of Kahn & Co., 194 Broadway, some time during Monday night of last week, and stole eight pairs of pearl-handled opera glasses, valued at \$40.

Officers of J. Sheidig & Co., 50 Maiden Lane, were elected at the first meeting, recently, held by the corporation, as follows: Stephen Sheidig, president; John Sheidig, vice-president; W. A. Wirth, secretary and treasurer.

The Manhattan Watch Distributing Co. was recently incorporated with an authorized capital stock of \$100,000. The names of the directors are: A. Bruno, Brooklyn; F. C. Wheeler, New York; W. H. Osborne, Newark, N. J.

Jewelry valued at \$500, was taken by customs inspectors from the baggage of M. Witsma, of St. Louis, Mo., a passenger on the liner *Ryendam*, which arrived in New York on Tuesday of last week. The articles were sent to the public stores.

Incorporators of the Zaiden Coin Clock Corporation, recently formed, are Davis Zaiden, Estratius Glorgiddi, Morris Metzler and George S. Wheeler, all of New York. The company is to manufacture patented clocks. The amount of authorized capital stock is \$25,000.

Burnett Y. Tiffany, son of the late

Charles L. Tiffany, is to have an income of \$1,500 a month allowed him by the executors of his father's estate. He tried to get \$50,000 a year. The Appellate Division of the Supreme Court at New York last week sustained a decision of Surrogate Fitzgerald, which upheld the action of the executors.

At the regular monthly meeting of the directors of the Jewelers Board of Trade, held July 12, the following firms were unanimously elected to membership: Bates & Bacon, Attleboro, Mass.; Robert Gatter, New York; Hub Optical Case Co., East Dedham, Mass.; G. A. Veeck, New York; West, White & Christie, Pittsburgh, Pa.

Supreme Court Justice Truax last week rendered a decision in the case of the heirs of the late Ashley A. Vantine and the executors of his estate against the firm of A. A. Vantine & Co., dealers in Oriental goods at 879 Broadway, in which he denies the right of the heirs to prevent the company from using the name of Vantine.

P. A. Tower, the head of the Tower Mfg. & Novelty Co., 306 Broadway, recently gave a dinner in honor of Robert L. Lomas, Jr., who had resigned the office of vice-president and secretary, after an association with the company covering a period of more than 30 years. His friends presented to him a silver loving cup, a handsome silver and horn mounted cane, and an umbrella.

A story was published in a New York paper Monday in relation to the sale by a Paris jeweler of a pearl necklace to John D. Rockefeller. It was said that the jeweler took his best pearls to show to the American, and on exhibiting his finest necklace was almost afraid to ask \$100,000 for it. The head of the Standard Oil Co., it was said, abruptly ordered three necklaces of the same kind for \$300,000. The story is not believed.

The International Gem Co., Inc., has begun business at 12 John St., as lapidaries and importers. Horace A. Dwyer, the president, was for 11 years with Tiffany & Co., and for nine years with Garraud & Griser; the secretary and treasurer, Henry Casanova, was for 12 years with Tiffany & Co. H. O. Dreher, vice-president, was for two years with Shreve & Co., and for 12 years with Tiffany & Co. Besides cutting and polishing, the company is prepared to turn out special lines of work in drilling, engraving and slitting.

In a decision by W. B. Howell, the Board of United States General Appraisers ruled, last week, that decorated china from S. Tamai and K. Suzuki & Co., of Kobe, Japan, was heavily undervalued. The Board advanced invoice values 25 per cent., which with the accruing penalties bring the total advances up to 50 per cent. The merchandise consisted of fancy dishes, umbrella stands, vases, and berry sets. The Board required the importers of cloisonne vases from K. Sugawa, Kobe, to pay advanced duties amounting to 25 per cent.

Two more women, last week, complained to the Brooklyn police that they had been swindled of diamond earrings by men who exchanged for these articles glass imitations. In these, as in other cases, previously reported, glib-tongued strangers approached the women and exhibited earrings having large paste stones, which were rep-

resented as real diamonds. Mrs. Sophia Tannebaum, 104 Seigel St., said that she had exchanged a pair of earrings costing \$175 for worthless imitations. On her complaint, Samuel Greenbaum and Isaac Rosenberg, neither of whom would give his address, were arrested, and were held in the Manhattan Ave. Court in \$2,000 bail. A second complaint against Rosenberg was made by Mrs. Pauline Jacobs, 91 Marcey Ave., who parted with a pair of earrings, which, she says, were worth \$100, and also gave \$60 in cash in exchange for imitations worth a few cents.

James McGraw, who says that in old days he used to rob jewelry stores, banks, and hotels, called, one night last week, in the office of the *New York Sun*, and related his experiences to the extent of a column and a half, which was published the following morning. McGraw, who is now 51 years old, and has passed a large share of his life in prisons, said one of the first robberies in which he engaged, was in a jewelry store in Denver, where his gang took away stock to the value of \$12,000. In speaking of hotel robberies in the western cities, a number of years ago, he said that it was the practice of thieves to take only money and precious stones. The stones, he said, were sent to a fence in New York, the man being still alive. Watches were never taken, because sentimental attachments sometimes spur the owners to get them back at any cost. The old-time robber said that during much of his career, the thieves, with whom he was associated, acted in agreement with the police, dividing spoils. Nowadays he said, little of this is done, and the police are more honest than formerly. As for himself, he said, he had determined to live honestly for the remainder of his life.

Reports have been published in the last week in daily papers to the effect that the insurance companies are quite generally withdrawing their burglary policies. One report was that because of the prevalence of burglaries in Manhattan most of the companies would refuse to issue any more policies here. Another paper said that the companies have lost much less from the activity of burglars than as a result of the dishonesty of persons taking out policies, or the relatives of such persons. Interviews were given with officials of companies detailing experiences in which the companies were obliged to pay for losses when there were no real burglaries. The form of the policy was said to be almost an invitation to dishonesty in the case of persons inclined that way. Inquiries made by a reporter of THE JEWELERS' CIRCULAR-WEEKLY at the offices of the companies elicited the information that about the only withdrawal from the field of burglary insurances is on the part of the United States Fidelity & Guarantee Co., which is said to carry most of its business in this line outside of Greater New York. As far as can be learned, jewelers and other business men who desire burglary insurance are finding no unusual difficulty in getting it.

A man went into the store of Harry Zimmerman at 390 Columbus Ave., Monday, and, saying that he was a butcher up the street, whose name he gave, picked out a

IN THE HEART OF THE JEWELRY DISTRICT.

**Guardian Trust Company,**

170 BROADWAY, COR. MAIDEN LANE, NEW YORK.

Capital and Surplus - Over \$1,000,000

Equitable rates of interest allowed on surplus funds.

Collection of out-of-town items made on reciprocal basis.

FRANK W. WOOLWORTH, President.  
GEORGE W. FAIRCHILD, Vice-President.  
CHARLES L. ROBINSON, Vice-President.LATHROP C. HAYNES, Secretary.  
ALFRED M. BARRETT, Asst. Sec'y.Prominent Jewelers  
Among our Directors }  
LUDWIG NISSEN.  
A. K. SLOAN.  
LEOPOLD STERN.**THE ORIENTAL BANK.**

ESTABLISHED 1853.

182 and 184 Broadway, <sup>Corner</sup> JOHN STREET, NEW YORK.

Capital, - - - \$750,000.00.

Surplus and Profits, 1,100,000.00.

**ACCOUNTS FROM THE JEWELRY TRADE ARE SOLICITED.**R. W. JONES, Jr., President.  
NELSON G. AYRES, First Vice-President.  
GEO. W. ADAMS, CashierLUDWIG NISSEN,  
ERSKINE HEWITT, } Vice-Presidents.  
CHARLES J. DAY, }

R. B. ESTERBROOK, Assistant Cashier.

**The Market and Fulton National Bank of New York.**

ORGANIZED 1852.

81-83 FULTON STREET.

Capital, \$1,000,000.

Surplus, \$1,335,000.

ALEXANDER GILBERT, President.  
R. A. PARKER - - - Vice-President.  
T. J. STEVENS, - - - Cashier.  
JOHN H. CARR, - Asst. Cashier.**Invites the Accounts of Jewelers.**

Will extend every facility that good banking will justify.

**SAFE DEPOSIT VAULTS.****The Chatham National Bank**

Broadway and John Street, New York

H. P. DOREMUS, Cashier

GEORGE M. HARD, President

W. H. STRAWN, Ass't Cashier

**THE STATE BANK**

376-378 GRAND STREET, NEW YORK

**Capital and Earned Surplus, over \$1,100,000. Deposits over Fourteen Millions.**

Offers a favorable market for short and long time jewelry and diamond paper



The Officers and Directors of

**THE MERCANTILE NATIONAL BANK**

of the City of New York announce  
the removal of their banking rooms  
to their new quarters in the Western  
Union Building, 195 Broadway,  
corner of Dey Street, and invite your  
inspection of their equipment

**W. & S. B. ★**  
**Old Reliable 1-10**  
**Globe Filled 1-8**  
**CHAINS**

are sold only to the legitimate jewelry trade. Jewelers who handle them do not have to meet the competition of Department Stores or Retail Mail Order Houses.

The adoption of this policy is the result of a vote of the directors of the W. & S. Blackinton Co. to protect the rights of the retail and jobbing jewelry trade. In declining the trade of department stores we close many large accounts. However, we are convinced that this policy of protection to the retail jeweler and jobber will work to their best interests, as well as our own.

---

**W. & S. BLACKINTON CO.**

Manufacturers of Old Reliable W. & S. B. ★ Chains and Lockets

**NEW YORK, 14 Maiden Lane**

**Factory, North Attleboro, Mass.**

A selection package will be sent through any jobber whom the retailer may designate.

## New York Notes.

(Continued from page 59.)

couple of clocks to hang up in his market. Then he said he wanted to get a \$50 bill changed because a customer was waiting for it at the store. When Zimmerman said he couldn't change it, the purchaser said he wanted to borrow \$5 in change long enough to go back and square up with his customer. Zimmerman let him have the money, and then he grew suspicious. When the man tried to board a street car the jeweler overtook and arrested him. In the West Side police court a stationer said that the prisoner had obtained \$5 from him by means of the same trick a week ago. The prisoner, who said that he was Abraham Worthenschlag, 41 years old, was held in \$1,000 bail.

Machinery, office fixtures, furniture and safes of Schekerling & Co., bankrupt jewelry manufacturers, at 28 E. 22d St., New York, were sold at public auction last week for \$3,196. The auction was under the direction of Robert S. Morris, the trustee in bankruptcy.

Louis J. Gallaher, 356 Franklin Ave., Brooklyn, last Friday caused the arrest of Albert J. Bulger, on the charge of stealing watches and diamonds to the value of \$1,000. The complainant said that he had entrusted the merchandise to Bulger to sell.

Victor E. Benz, 51 Maiden Lane, has just returned from his vacation trip, which was spent aboard his private launch. He made several cruises along the New York coasts. R. E. Linnert, Charles Reitz and Joseph Landsann, jewelers in the same building, and also H. S. Deutch, of Hammel, Riglander & Co., were his guests for several days.

In the case of Joseph and Morris Klein, of Klein Bros. & Co., the bankrupt manufacturing corporation at 51 Maiden Lane, an application was made recently in the Court of General Sessions by their attorneys for a reduction in the amount of bail in which they are held to answer to eight indictments accusing them of grand larceny. A representative of the district-attorney's office opposed the application, saying that \$25,000 is not excessive, considering the nature of the charges. The court denied the application, but said that the district-attorney must give the prisoners a trial at as early a date as possible. The assistant district-attorney said that he could not bring the case to trial before the middle of August. The Kleins, in default of bail, were then remanded to the Tombs.

United States Commissioner Alexander was notified last week that the Treasury Department has denied the petition of Norman C. Hascall, of Jacob J. Freeman & Co., Toledo, O., to return to him the diamond brooch seized by a customs inspector on his return from Europe last year. The brooch had been for years the property of Mr. Hascall's wife, and the seizure was made because of a resetting of the stones in Europe. The case will now go to the courts, it is expected, on the question of forfeiture.

Detectives arrested last Wednesday a young man, giving the name of James Spellman, on the charge of being implicated in the robbery, in March, 1905, of jewelry

to the value of \$50,000 from M. Glattauer, of Glattauer Freres, Paris. The details of the robbery were published in THE CIRCULAR-WEEKLY, April 12, 1905, and another account appeared in the issue of Dec. 13 of the same year, when a portion of the missing property was found in New York pawnshops. Mr. Glattauer was followed by the thieves from this city, he believed, to Birmingham, Eng., where the robbery took place. On his arrest Spellman said that he was an engineer living at 18 Thames St., Brooklyn, and he denied having anything to do with the robbery. He was released in the latter part of the week, the police saying that the London authorities do not desire to extradite the man.

## Trans-Atlantic Voyagers.

### TO EUROPE.

E. F. Keller, of Keller, Becker & Co., New York, sailed last week on the *Kaiser Wilhelm der Grosse*.

Emanuel Arnstein, of Arnstein Bros. & Co., New York, and Mrs. Arnstein, sailed July 3 on the *Kronprinz Wilhelm*.

Christian Dorflinger, of C. Dorflinger & Sons, New York, and his grandson, Dwight C. Dorflinger, sailed recently on the *St. Louis*.

Herbert Cooper, of the Cooper Diamond Co., New York, accompanied by his wife and daughter, will sail Saturday on the *Campania*.

Albert F. Strasburger, manager of Wanamaker's jewelry department, New York, sailed recently on the *Philadelphia*.

J. Bernstein, New York, sailed last week on the *Kronland*.

John Frankel, of Joseph Frankel's Son's Co., New York, sailed recently on the *La Provence*; also on the same boat were C. Goldsmith, of the Steel & Taylor Co., New York, and Mrs. Goldsmith.

### FROM EUROPE.

Newton H. Rogers, of Hayden W. Wheeler & Co., arrived recently on the *St. Paul*.

C. F. Wood, of Chas. F. Wood & Co., returned Saturday on the *Kaiserin Augusta Victoria*.

Alvin L. Bauman, the president of the L. Bauman Jewelry Co., St. Louis, Mo., will sail Friday on the *Amerika* from Cherbourg.

A. F. Lowenthal, New York, returned last Tuesday on the *Kaiser Wilhelm II.*; also on the same boat S. Gans, of D. Lisner & Co., New York.

## Bankruptcy Petition Filed Against Ernest J. Leben, Americus, Ga.

AMERICUS, Ga., July 16.—An involuntary petition in bankruptcy was filed last week against Ernest J. Leben, who has been in business here less than two years. The usual allegations as to insolvency are made by the creditors. No statement as to his assets and liabilities has been made public.

He was formerly a member of a firm at Jennings, La. When he came here he leased part of a store occupied by a bric-a-brac concern, which he later bought out in order to protect the lease. The additional liabilities proved too heavy a strain for him, it is understood.

## Philadelphia.

F. W. Trewin, of the Keystone Watch Case Co., is at his home, seriously ill.

Charles Taney, 728 Chestnut St., is spending the Summer with his family at Wildwood, N. J.

A. L. Smyth, formerly of South St., has moved into his new store at Fiftieth St. and Baltimore Ave.

Albert Sauter, of E. Sauter, 2709 Girard Ave., has taken his family to Doylestown, Pa., for the balance of the summer.

Karl Kempter, Third and Poplar Sts., is receiving the sympathy of the trade upon the death last week of his infant son.

Carl Stratton, watchmaker, formerly with H. H. Knerr, Camden, accepted a position last week with Strawbridge & Clothier.

Alb Sickles and Ed. Sickles, of M. Sickles & Sons, spent a few days in New York last week buying goods for the Fall trade.

F. B. Wallen, one of Camden's most prominent retailers took his family to New York last week, where they will stay until August.

Charles Hamer, watchmaker, formerly with C. R. Smith & Sons, accepted a position last week with the Bailey, Banks & Biddle Co.

J. E. Caldwell & Co. were awarded the contract last week to furnish the prizes and trophies for the annual bowling tournament of the Schuylkill Navy.

The thief who robbed the retail jewelry store of W. A. Patterson, 1149 S. Twentieth St., was recently tried, convicted, and sentenced to jail.

H. Garman, Coatesville, Pa., admitted to partnership last week his son, who has been identified with the business for some time. The firm name will hereafter be H. Garman & Son.

Julius Windner, manufacturing jeweler, 717 Sansom St., lost an envelope last week containing 10 small diamond rings, in the heart of the city, and he has since offered a liberal reward for the return of the rings.

William Gibbons, 4030 Market St., has returned from a vacation of several weeks in the mountains. He will superintend the opening, shortly, of his new store on Fortieth St. south of Market St.

J. Walter Hazelton, with Charles H. O'Bryon, 735 Sansom St., who has been ill from injuries sustained in a fall following an attack of vertigo, returned last week to business completely recovered.

Mrs. A. Hassler, who for about half a century has conducted a retail store at 3418 Market St., during which time she has come frequently before public notice as the victim of thieves, sold out her store last week to Emil Moskovitch. Mrs. Hassler will retire from business.

Simon Reese, a young man who is charged with having robbed Joseph H. Deschamps, Seventh and Chestnut Sts., of \$1,200 worth of diamonds last April, was landed in a cell in this city last week and now awaits trial. Reese was a friend of Mr. Deschamps and stole his diamonds while he had free access to the establishment. After the robbery he fled to London, where he was captured. A detective from this city was sent to bring him home.

## Ball's Official Standard R. R. Watches

WHAT WOULD YOU GIVE FOR A LIFELONG CUSTOMER?

Try this plan:

Sell your next watch customer a "Ball."

Its reliable performance will convince him you are a dealer to be depended on—he'll keep coming back for other things.

The watch will win you his business and friendship for always.

*Write for booklet, and watch this space.*

We want to add a lot of new friends to the Ball family of railroad watch dealers.

### THE WEBB C. BALL WATCH CO.

CLEVELAND  
Ball Building

CHICAGO  
804-6-8 Railway Exchange



ESTABLISHED 1854.

INCORPORATED 1893.

JUERGENS & ANDERSEN CO.,  
DIAMONDS,  
MAKERS OF FINE JEWELRY,  
92 TO 98 STATE STREET,  
CHICAGO.

23-25 Looijersgracht, Amsterdam, Holland.

# THE HERMAN KECK MFG. CO.

## CUTTERS OF

# DIAMONDS.

### FOR SALE.

A complete diamond cutting outfit of twenty benches, European make, consisting of sawing machines, rounding machines, laps, tongues, dops, scouring stands, etc., all in first class condition. Will sell cheap, if sold in bulk at once, as we have replaced them with American tools.

MANUFACTURING JEWELERS, SILVERSMITHS.  
Recutting and Repairing of Diamonds.

17-19-21-23 West Fourth St.,  
CINCINNATI, O.

RUDOLPH NOEL

RUDOLPH NOEL & CO.

PHILIP NOEL

IMPORTERS OF

# DIAMONDS

2 Tulp Straat, AMSTERDAM

'Phone 1902 John

37-39 Malden Lane, NEW YORK



# WESTERN DEPARTMENT

Western Office:  
204 COLUMBUS MEMORIAL BUILDING,  
CHICAGO.

Telephone:  
4079 CENTRAL,  
CHICAGO.

VOL. LII.

CHICAGO, WEDNESDAY, JULY 18, 1906.

No. 24.

## Chicago Notes.

L. H. Shafer is spending his Summer vacation at Cleveland.

R. L. Jenkins is about to remove from Kewanee, Ill., to Amboy, Ill.

Paul Braude, of Emil Braude & Co., is out on a trip through Illinois.

Edward Lehman, of the Edward Lehman Jewelry Co., Denver, was here recently.

Wm. Barker, Jr., has started on a trip to the coast for R. Wallace & Sons Mfg. Co.

A. F. Smith, Omaha, Nebr., visited the Chicago trade for a day on his way east.

W. H. Peters and W. V. Ghislin, of the Gorham Mfg. Co., are now on their vacations.

E. A. Dorrance, with Simons, Bro. & Co., is occupying his Summer cottage at Antioch, Ill.

O. A. Starke, manager of the Star Watch Case Co., spent a few days of last week in this city.

George Kehl, of Frank H. Noble & Co., is back from his coast trip, and reports good business.

Fred H. Allen, of D. Wilcox & Co., is occupying his new Summer cottage at Long Lake, Wis.

E. Hewitt Griffin, optician, until recently located at 833 W. Congress St., will remove to Kincaid, Kans.

A. W. Sproehle, of Sproehle & Co., is off for a sojourn of a month or so among the northern lakes.

A. B. Paulsen is enjoying a vacation and adding to his stock of fish stories at Lauderdale Lake, Wis.

C. E. Child, of the C. M. Robbins Co., has just returned from a successful trip to Denver and the northwest.

Robert Wilson, with Stern Bros. & Co., and Sam Block, with Lyon Bros., are en a vacation to Eagle River, Wis.

Paul W. Serwich, Joseph C. Wilson and J. M. Hedden have started on their western trips for Wm. A. Rogers, Ltd.

George H. Spies, of Spies Bros., with S. C. Spies and wife, are making a short automobile trip through Wisconsin.

E. C. Wineburgh, L. Seligman and J. J. Wechter will start on their Fall trips this week for the L. Seligman Jewelry Co.

R. J. Hillinger, who has been in the northern woods for the past week, reports an excellent catch of bass and muscullonge.

J. M. Poole and J. N. Lane, of the American Silver Co., start on their western trips this week. Mr. Poole goes to the coast.

Sylvan L. Basch and Miss Irene Hirsch were united in marriage Wednesday last. The couple are now on their honeymoon.

E. D. Barnum, of the Chicago office of the Ansonia Clock Co., is on a pleasure trip through Canada and the east. He will be gone a month.

Dr. Warner, of Warner & Co., Mangum, Okla., was in Chicago recently selecting stock for his jewelry department. He was accompanied by Mrs. Warner.

R. O. Kandler is still in Germany in the interest of his school of engraving and designing. He proposes to visit the art centers of Europe before his return.

Louis Finkelstein, St. Paul, was in Chicago during this week, selecting a complete new stock on account of the fire of last month which totally destroyed his premises.

George N. Strawn, of E. A. Dayton & Co., recently made a business trip through Illinois and Iowa. He reports that crops in these sections never looked more favorable.

C. J. Williams, of A. L. Williams & Co., is on a vacation on a farm in the west. A. J. Williams, of the same firm, has now returned from his wedding trip through the east.

Clarence Woods, of the material department of C. H. Knights & Co., met with a severe accident in a bicycle race recently. He was confined to his home for a few days.

W. R. Stevens, the western manager of the Bay State Optical Co., is making a visit to the factory at Attleboro. He intends stopping at the meeting of opticians at Rochester on his return.

J. M. Stanley and Julius Mayer, representing the Mauser Mfg. Co. and S. Sternau & Co., will soon start on western trips. Mr. Stanley will go to the coast, and will be accompanied by Mrs. Stanley.

Frank T. Barton, who has just returned from a Pacific Coast trip, goes east this week, his principal objective point being his native city of Providence, R. I. Mr. Barton reports good business on the coast.

J. R. Parsons, the well-known founder of Parsons' Horological School, now of Jessup & Sons, San Diego, Cal., has been making a visit to Chicago for some days.

He returned to San Diego the latter part of last week.

George P. Marchall, with E. V. Roddin & Co., combined a vacation and a wedding trip all in one. Mr. Marchall has now returned to his desk in the Heyworth building, and his friends say that his smile is even more genial than ever.

Fred Spies, of Spies Bros., who has been confined to a hospital for over four months, is now reported doing well, with the prospect that he will be back at his desk this Fall. At one time it was considered doubtful if Mr. Spies would recover at all.

The partnership of Woollett & Jacob, which was formed two years ago, has been dissolved, John Woollett retiring from the firm. Ed C. Jacob will continue the business in the present quarters at 103 State St. The dissolution dates from July 14, and Mr. Jacob assumes all obligations of the old firm.

The estate of M. Lippert, who was a traveling jeweler, and who died in the latter part of April, this year, intestate, is being administered in the office of James Reddick, Public Administrator. A complete appraisal of the stock has not yet been made, but it will probably reach \$7,500. It would appear that all claims will be paid in full.

M. Bazzett & Co, whose offices were at 311-313 Wabash Ave., have sold their entire business, including stock, fixtures and leasehold to the American National Jewelry Co. for \$12,750. The retiring firm will close up all their book accounts and pay all outstanding obligations. M. Bazzett, who has been the leading spirit in the old firm, will remove to Seattle, where he will represent a line of china and glass ware. The American National Jewelry Co. started in business two years ago with offices in the Schiller building. Victor H. Brownscombe is secretary of the company and its manager.

Among the buyers in Chicago during the last week were the following: Adolph Hapke, Newman, Ill.; R. A. Woodward, Sandwich, Ill.; E. Raines, Denver, Colo.; W. D. Nelson, accompanied by Mrs. Nelson, Pierre, S. Dak.; Mr. Hanson, of the Hanson Jewelry Co., Princeton, Ill.; G. W. Flanders, Three Rivers, Mich.; M. Hainer, McComb, Miss.; Harry Dixon and wife, North Platte, Nebr.; C. A. Larson, Cedar Falls, Ia.; Dr. I. T. Gabbert, Caldwell,

# To the Jobbing Trade.



Quality, workmanship and desirable styles you want, at popular prices, we have them in

## Diamond Mounted Jewelry and Mountings



Kans.; M. Bigwood, Evansville, Ind.; A. Rovelstadt, Elgin, Ill.; S. D. Wones, Hiawatha, Kans.; M. Feinberg, Ironwood, Mich.; A. Weibking, Garden Prairie, Ill.; M. Fuerstein, Green Bay, Wis.; Miss Sadie Landsberg, Rock Springs, Wyo.

### Indianapolis.

Miss Emma Binsack, with Horace A. Comstock, last week entertained her nephew, Oscar Brill, San Francisco, a wireless telegraph operator in Governmental service.

Burglars, supposed to have been boys, entered the store of Robert Keller, East and Prospect Sts., last week, and carted off several hundred dollars' worth of stock, including 45 rings, several watches, fobs, silver spoons, plate ware and revolvers.

Among the out-of-town jewelers who visited the local jobbers and manufacturers last week were: Sol Pennington, Knights-town; J. A. Miessen, Cicero; D. S. Whitaker, Lebanon; J. A. Pickett, New Castle; H. Wheeler, Dana; J. F. Harding, Brownburg, and Aaron Pursel, Noblesville.

Back in April, Harry Camp, Chicago, came to this city and sought a room in which to open a new retail store. He selected a room in the Claypool Hotel building. The rent was \$2,500 a year, and he paid Manager Cunningham, of the hotel company, \$150. He then engaged decorators to beautify the room. Several hundred dollars' worth of fixtures were introduced, and the decorating work was to cost \$250. The opening was announced for June 1, then was changed to June 15, and later to July 1. Manager Cunningham now says that Camp has decided not to open a store in this city. He does not know what caused a change in plans.

### Detroit.

Burr, Patterson & Co. have rented additional space in the building at 73 W. Fort St., the old quarters being too cramped.

William Windish, Jr., with Noack & Gorenflo, was recently married to Miss Usmen. Hugo Stahl, of the same firm, was also married recently to the firm's stenographer, Miss Ida Drebs.

The Hon. Sidney O. Bigney, Attleboro, Mass., arrived too late to take in the excursion carrying 255 Michigan jewelers, but after they reached dry ground again he made himself very popular with them.

Hugh Connelly, the State St. jeweler, expects to have his stock in the remodeled and enlarged store the latter part of next week. For nearly two months he has been occupying cramped quarters on the third floor of the Hodges building.

The entertainment of the visiting jewelers by the Detroit Jewelers Board of Trade is in line with their policy of boosting Detroit as a growing trade center. The officers of this organization are: President, Frank Kennedy, of the Kennedy Optical Co.; vice-president, R. Rogers, of Kunz & Rogers; secretary, Chas. A. Berkey, of the Chas. A. Berkey Co.; treasurer, A. E. Patterson, of the Burr-Patterson Co.

Mrs. Anna Koppelman, Arenzville, Ill., recently disposed of her retail jewelry business to F. C. Ballhorst, Quincy.

## St. Louis.

D. P. Richards, of the Maschmeyer-Richards Silver Co., is on a visit to his mother at Columbia, Mo.

Barnum & Burton, opticians and photograph supplies, have removed from 609 Locust St. to 318 N. 8th St.

O. H. Kortkamp, president of the E. H. Kortkamp Jewelry Co., is spending his vacation at Elkhart Lake, Wis.

John A. Gerst, manager of the repair department of Whelan-Aehle-Hutchinson Jewelry Co., is on his vacation.

President Herman Mauch, of the Retail Jewelers' Association, of Missouri, announces a meeting of the association for next Wednesday.

L. P. Hebard, Sheffield, Ala., stopped over in St. Louis, one day last week, on business, while on his way to spend his vacation in the east.

M. M. Gumbiner, Luling, Tex., was in St. Louis, last week, on his way home from Chicago, where he was present at the wedding of one of his relatives.

Simon Van Raalte, 213 N. Seventh St., reported to the police, last week, that some person stole an open-face gold watch from his store in some unaccountable way.

J. T. Wells, Kansas representative, and S. L. Lowenstein, Missouri and Illinois representative of the Bamman-Massa Jewelry Co., start out this week on their regular trip.

Alvin L. Bauman, president of the L. Bauman Jewelry Co., will sail, July 20, from Cherbourg, on the Hamburg-American liner, *Amerika*, after an extended trip abroad.

Local jobbers received information of the death at Dardanelle, Ark., of Henry Vernon, who had been in the jewelry business there for many years. Heart failure was the cause of his death, on July 9.

H. M. Hubbard, Texas representative of the L. Bauman Jewelry Co., with headquarters in Fort Worth, stopped over in St. Louis on his way to spend his vacation in Detroit. He was accompanied by his wife and child.

C. L. Bates, diamond expert, with the F. W. Drosten Jewelry Co., accompanied by his family, is spending his vacation in Minneapolis and St. Paul. William Hocker, of that firm, has returned from his vacation.

William Weidlich, of William Weidlich & Bro., recently went to Bridgeport to attend the funeral of his brother, Charles E. Weidlich. E. C. Weidlich probably will not return to St. Louis until some time next month.

The name of James J. Burke, president, is being placed at the head of the signs of the Brooks Jewelry & Optical Co., Globe-Democrat building, instead of Brooks-Auer Jewelry Co., as erroneously published in a prior issue.

C. L. Stange, formerly with Norris, Alister & Co., Chicago, has been added to the staff of traveling representatives of the L. Bauman Jewelry Co., with territory in Missouri and Kansas. He will start on his first trip for this company on July 20.

Joseph Sammerschreuter, who was manager of the New York house of Mermod, Jaccard & King Jewelry Co., has now returned to the company's store in this city.

E. W. Bornmueller, buyer of the silver department of this company, is on his vacation.

F. W. Drosten, of the F. W. Drosten Jewelry Co., accompanied by Mrs. Drosten, will sail, July 30, from New York on the *Kronprinz*, for Europe, to remain six weeks abroad, combining business with pleasure. They will visit Amsterdam, Paris and London.

The *Republic* printed a first page interview Thursday with Goodman King, the president of the Mermod, Jaccard & King Jewelry Co., with reference to the work of restoration of the World's Fair grounds. Mr. King said that greater progress had been made here than in Paris.

Among the visiting jewelers in St. Louis, last week, were the following: William Krommeyer, Murphysboro, Ill.; M. J. Boydston, Albia, Ia.; L. A. Holdener, Belleville, Ill.; Charles Mosby, Batesville, Ark.; L. Hebard, Sheffield, Ala.; Fred Herold, Jerseyville, Ill.; H. D. Leffel, San Angelo, Tex.

## Cincinnati.

Frank Herschede is at business again after an attack of typhoid fever.

J. C. Miller, of the Miller Jewelry Co., has started on a business trip east.

William Pflueger, of Joseph Noterman & Co., is enjoying the fishing in Michigan.

C. C. Stoner, of Lindner & Co., is able to be out again and will be on the road Aug. 1.

A. Westhoff, with the Frank Herschede Co., with his family, is at Benton Harbor, Mich.

Lucian Bingaman, with Bingaman & Co., is taking an outing at Atlantic city and New York.

"Nate" Hahn, with Lindenberg, Strauss & Co., was in New York the past week on business.

Sturgis Lawrence, New York manager for the Rookwood Pottery Co., was in the city last week.

Otto Mehmert, with Joseph Mehmert, and his bride, are home from their honeymoon in the east.

G. H. Hansgen, Bethel, O., will close his store for the month of July and take a rest in Pennsylvania.

C. E. Richter, of Richter & Phillips, with his wife, left July 15 on a month's trip in the Rocky Mountains.

Louis Hummel, 9 Emery Arcade, is spending the hot months at his Summer home in New Richmond, O.

Joseph Phillips and M. D. Geigerman, of the Sterling Glass Co., have left on extended business tours east.

Henry Wiseman, recently of Milwaukee, Wis., but formerly with the Clemens Oskamp Co., has again connected himself with this company.

Sam Wagner, with George Simper, is home from a trip abroad and has much of interest to tell about the jewelry trade of the various European cities.

M. J. Greenwald, 33 Arcade, has completed improvements to his store and its new wall decorations now give his establishment a most pleasing appearance.

Considerable inconvenience and a discontinuance of work was suffered by the Wadsworth Watch Case Co. a part of last

week by the bursting of a water plug at the factory.

S. & H. Gilsey, recently added to their road force Joseph Herwin, who will travel among the southern trade. O. C. Tyson, formerly watchmaker with the Oskamp Jewelry Co., is now located with this house.

Adolph F. Schmidt, for many years a partner of Henry A. Dodt, 26 Emery Arcade, and well and favorably known here, has now succeeded Mr. Dodt and will conduct the business hereafter. Mr. Dodt is still in very poor health.

A. C. Thomas, Anniston, Ala., stopped here on his way to New York, where he has bought the Metropolitan Optical Parlors in the Metropolitan building, 1 Madison avenue. The Anniston business will be conducted by a brother, L. W. Thomas, and W. T. Thomas, another brother, will take charge of the store at Sistersville, W. Va.

Out-of-town dealers who were here making purchases last week included: Will Schaible, Troy, O.; John Selbert, Frankfort, Ky.; A. Clooney, Maysville, Ky.; O. J. Sherwood and wife, Falmouth, Ky.; C. F. Cross, Gadsden, Ala.; Joseph E. Smith, Lockland, O.; Mr. Gleason, Louisville, Ky.; M. K. Peck, B. H. Stief Jewelry Co., Nashville, Tenn.; Frank Horning, Brookville, Ind.; E. F. Starks, New Point, Ind.; H. Reed, Blanchester, O.; O. E. McWaters, Somerset, Ky.

The case of Mabel Hall and John Delaney, who sometime ago secured a diamond ring from the Oskamp Jewelry Co. and one from the Duhme Jewelry Co., was in court last week but the proceedings are not yet fully settled. The stolen goods will be returned to the concerns which lost them. Delaney was acquitted by the judge of the charge of receiving from Mabel Hall the jewelry obtained from these companies under false pretenses. The woman is still under indictment. She testified she had planned the stealing and did it herself. The woman did not implicate Delaney. She is said to have served a term in the penitentiary for similar offenses, though only about 22 years of age.

## Minneapolis and St. Paul.

R. G. Winter, of the R. G. Winter Jewelry Co., Minneapolis, has gone for a vacation at Annandale, Minn.

Lewis Finkelstein, St. Paul, who was burned out in the Ryan annex fire, has adjusted his loss with the insurance companies at \$23,000.

Axel E. Madsen, of Minneapolis, who represents Rettig, Hess & Madsen in the Northwest, recently returned from a vacation trip to Iowa, after which he went to Chicago.

L. Metzger, of S. Jacobs & Co., Minneapolis, presented to the participants in the automobile parade held in this city last week the club colors of the Minneapolis Automobile Club.

L. Peterson, the four-year-old son of P. C. Peterson, a retail jeweler of Waverly, Kans., was accidentally shot and severely wounded by a reckless handler of a shotgun at a chari-vary, at that place, recently.

## San Francisco.

### TRADE CONDITIONS.

The wholesale jewelers are busy these days arranging their new quarters and at the same time trying to keep up with the rush of business. The traveling men are now out and the heavy orders arriving here indicate that the percentage of the trade that went to other cities after the fire was not very large after all. Loyalty to San Francisco is shown by shopkeepers in interior towns who refused to give orders to travelers from other cities, preferring to send their orders here by mail and get goods later. The wholesale jewelers are experiencing hardships in sticking to their present quarters in the Kamm building, where almost all of them are located. The elevators are not in running order yet and all goods have to be carried up the stairway by hand or hauled up to the windows by means of block and tackle. The city trade continues good, as new stores are being added each week and all these require a heavy initial stock. Such stores as are now open for retail business are doing well. Within another month the new retail centers will be fully prepared for the shopping trade.

The Columbia Loan Office has a temporary location at 3 Stockton St.

W. R. Landrum, a manufacturers' agent, is to open offices soon in the Cordes building.

Schwartzkoff & Penniman, formerly located here, have gone into business in Los Angeles.

The Alexandra Jewelry Store, at Van Ness Ave. and Pine Sts., was opened July 10.

Raphael's Loan Office, formerly of 602 Kearny St., is now located at 1340 Fillmore St.

The Diamond Parlor Jewelry Co., formerly located at 722 Market St., now has a large store at 1429 Fillmore St.

Mr. Desenfant, a manufacturer's agent, who formerly had quarters in the Thurlow block, is now located on Van Ness Ave., near McAllister St.

H. C. Van Ness & Co., who are at present doing business at 1932 Baker St., will soon be located in the Cordes building at Bush St. and Van Ness Ave.

The Portland Jewelry Co. now has an office on its old site on Stockton St., and the United Loan & Trust Co., jewelers and pawnbrokers, are also in the same building.

George R. Moss, formerly in business at 116 Geary St., has sought other fields that seemed more attractive to him than the jewelry trade, and is now in the restaurant business in this city.

The Nathan-Dohrman Co. is now erecting a large store building on Van Ness Ave. near Pine St., and will soon open with their line of goods, which includes fancy cut glass and table silverware.

The Fleissner Marshall Co., formerly in the retail trade at 11 Geary St., is to go into the haberdasher business on Van Ness Ave., but may return to the jewelry business when conditions become more favorable.

Work on the Bohm Bristol Co.'s building at Sacramento St. and Van Ness Ave. is progressing rapidly, and this firm is now making active preparations to occupy it early in August instead of in September, as was at first planned.

The Baldwin Jewelry Co. will soon have one of the largest and most artistic stores in San Francisco. The building will be occupied exclusively by this firm. The interior fittings are among the finest installed

in San Francisco since the fire. A feature is its appearance of permanence.

Mr. Hammersmith, of Hammersmith & Field, says that they have had all the business they can attend to ever since the opening day. The repair department at the store is kept busy and an outside factory is being operated, much of the work being the restoration of silverware injured by the fire.

Shreve & Co.'s new store on Van Ness Ave. will be ready in about a month. Considerable repair work is being done at the temporary store on Jackson St., and also at the office that is being maintained at 12th St. and Broadway, Oakland. The headquarters of the firm are now in the Shreve building at Post St. and Grant Ave., and a fair stock of goods is for sale there now.

The Radke building, at the corner of Van Ness and Bush Sts., is completed, and Radke & Co. are now occupying their new store, although the fittings are not yet in place. This store is commodious and has an unusual length of display windows of which full advantage is being taken to call attention to the new stock. The same high class of goods will be carried here as was in the stores before the fire. Special attention is to be paid to the household silverware department. Mr. Radke has retained many of the old clerks. The store on Devisadero St. will be continued, and much of the repair work will be done there. An expert watchmaker will be employed in the new store also.

## Oregon.

E. C. Barkey & Co. have purchased the stock and business of V. R. Wilson, Coquille, Ore.

A Feldenheimer, Portland, Ore., has received a permit for the erection of a two-story frame residence on King St.

F. S. Weekly, Hood River, Ore., has opened a new jewelry store and repair shop in the real estate room with Onthank & Otten.

Arthur Clarke, who has been in the employ of Jaeger Bros., Portland, Ore., has located in Hood River, Ore., in Chas. Clarke's drug store.

A. Salzman, a jeweler of Roseburg, Ore., accompanied by his daughter and friends, have started for the Crater Lake country, on a pleasure trip. While Mr. Salzman is away, P. J. Pond, of Peel, will have charge of the jewelry store.

Diamonds valued at \$1,000 were stolen from the safe of the Astoria Loan Office, at 581 Commercial St., Astoria, Ore., at noon on June 29. A large safe at the back of the store was left open while Mrs. Tillie Grossman, the proprietor, was at dinner in her rooms in the rear of the store. It is supposed that the thief then sneaked into the place. The theft is believed to be the work of a gang.

D. D. Sullivan, Fargo, N. Dak., has closed out his jewelry business in order to devote more time to the practice of optometry.

The town of Wheeling, Nebr., on the Great Northern Railway, which is about seven weeks old, has already two newspapers and a jewelry store, besides several other establishments.

## Kansas City.

C. H. Rakeman, Sapulpa, Okla., was in Kansas City this week on his return from a trip to Wyoming.

C. P. Kionka, of Kionka & Kionka, left this week for a trip through Colorado, to last about four weeks.

Mrs. H. W. Walter Starcke, Junction City, Kans., has just started a course with the Kansas City Polytechnic Institute.

Sol Marks, Lawrence, Kans., stopped off in Kansas City this week while on his way home from a stay at Excelsior Springs, Mo.

Sam Bloom, representative of the Meyer Jewelry Co., will leave next Monday for an extended trip through Kansas, Nebraska and northern Iowa.

Dr. Warner, of Warner & Co., Mangum, Okla., was in the city this week, accompanied by his family, on their way to Colorado to spend the heated term.

B. R. Hottinger, Freetown, Ind., and Gust. Carlson, of the jewelry firm of Munter & Carlson, Lindsborg, Kans., have just enrolled with the Southwestern Optical College.

S. Randazzo, who has been the watch maker for Clem. B. Altman, has resigned and gone to Buffalo, N. Y., where he will engage in the commission and importing business.

A. Y. Boswell, Tulsa, Okla., was in the city several days, having placed his boy in the hospital here for an operation. They have gone home, the operation having been entirely successful.

A. Marks, a jeweler of Lawrence, Kans., and wife, were in Kansas City this week on their return from a trip to Fort Scott, Kans., where they went to attend the funeral of Mrs. D. Prager, wife of a jeweler of that city.

Mr. Kirkpatrick, of the Model Drug & Jewelry Store, Oklahoma, Okla., was in the city this week, looking for a man to take the place of Albert Fricke, who has been his watchmaker for a long while, but who has tendered his resignation in order to engage in business for himself.

The following retailers from the surrounding towns called on wholesalers in the past week: W. S. Noble, Drexel, Mo.; S. J. Huey, Excelsior Springs, Mo.; W. R. Pearce, Gardner, Kans.; A. J. Roeder, Higginsville, Mo.; H. W. Walter Starcke, Junction City, Kans.; H. E. Tucker, Higginsville, Mo.

The Kansas City *Journal* recently published an interview with Walter M. Jaccard, of the Jaccard Jewelry Corporation, who had just returned from his diamond-buying trip to Europe. He emphasized the advancing value of diamonds and the increasing difficulty of getting the most desirable sizes and qualities.

James Hanratty, who recently pleaded guilty to the charge of having robbed the jewelry store of Mathias Mamer, Chicago, last week, withdrew the plea before Judge Honore. Another charge of robbery, which had been stricken from the call, was ordered reinstated and the prisoner will be placed on trial within a few days. Policeman Cesar Benson had been accused of the store holdup, and he shot and killed Mamer and himself because of the affair.



INDEX TO ADVERTISEMENTS.

Alkin-Lambert Co. . . . .	101	Gorham Co. . . . .	56	Osmun Parker Mfg. Co. . . . .	22
Allsopp & Allsopp. . . . .	28	Gongeluum, Paul . . . . .	78	Ostby & Barton Co. . . . .	21
Alvin Mfg. Co. . . . . Inside front cover		Greenfield, Geo. I. . . . .	72	Page-Davis Co. . . . .	78
Amerleau Gem & Pearl Co. . . . .	54	Griffoul, August . . . . .	104	Pairpoint Corporation . . . . .	98
Amerleau Platinum Works. . . . .	104	Guardian Trust Co. . . . .	60	Passmore Gem Co. . . . .	76
Amerleau Ring Co. . . . .	31	Hagstoz, T. B. Ltd. . . . .	104	Patek, Philippe & Co. . . . .	88
Amerleau Silver Co. . . . .	25	Harris & Harrington. . . . . Outside back cover		Penfold, Wm. C., Co. . . . .	90
Amerleau Waltham Watch Co. . . . .	82	Hedges, A. J., & Co. . . . .	22	Percival, D. C., & Co. . . . .	76
Apollo Silver Co. . . . .	102	Hedges, Wm. S., & Co. . . . .	48	Pomfret Goldy School . . . . .	96
Arch Crown Mfg. Co. . . . .	58	Helitz Bros. . . . .	27	Potter & Bullinton Co. . . . .	32
Arnstein Bros. & Co. . . . . 14, Outside back cover		Heller, L., & Son. . . . .	42	Power, Chas. L., & Co. . . . .	48
Austin, John, & Son. . . . . Outside back cover		Herpers Bros. . . . .	96	Powers & Mayer. . . . .	13
Aztec Turquoise Co. . . . .	54	Hirsh & Hyman. . . . . Outside back cover		Prior, Charles M. . . . .	24
Bagg, Perline & Co. . . . .	50	Hodgmyl & Walker. . . . .	42	Prybil, P. . . . .	103
Ball, Webb C., Watch Co. . . . .	64	Hoe's, James C., Sons. . . . .	78	Pryor Novelty Co. . . . .	25
Baschkopf, Jacob . . . . .	78	Holtzer-Cabot Electric Co. . . . .	103	Racine, Jules . . . . .	88
Bassett Jewelry Co. . . . .	34	Honesdale Decorating Co. . . . .	98	Reichhelm, E. P., & Co. . . . .	96
Bates & Bacon. . . . .	20	Hotel St. James. . . . .	35	Renzielausen, W. F., Co. . . . .	104
Bealmear, H., & Co. . . . .	98	Howard, E., Clock Co. . . . .	96	Revell, A. H., & Co. . . . . Outside back cover	
Berge, J. & H. . . . .	104	Iraba, Louis W. . . . .	33	Rice's, Bernard, Sons. . . . .	102
Bignke & Eckert Co. . . . .	74	Humphrey, John B. . . . .	54	Ries & Armstrong. . . . .	76
Bigney, S. O., & Co. . . . .	4	Illinois Watch Co. . . . .	8	Rockford Silver Plate Co. . . . .	18
Billings, Chester, & Son. . . . .	46	International Gem Co. . . . .	72	Rockford Watch Co. . . . .	78
Bishop, R. W. . . . .	92	Jacot Metal Box Co. . . . .	102	Roger Williams Silver Co. . . . .	26
Blackinton, K., & Co. . . . .	15	Jeandheur, F., Jr. . . . .	76	Roseman, A. . . . .	52
Blackinton, W. & S., Co. . . . .	62	Jeanne, Frederick A. . . . .	52	Ross, Saltman & Anderson. . . . .	28
Blancard & Co. . . . .	103	Jewelers' League . . . . .	29	Rothschild Bros. & Co. . . . .	28
Borrelli & Vitelli. . . . .	48	Johnston, W. J., Co. . . . . 10,	11	Roy Watch Case Co. . . . .	88
Bowden, J. B., & Co. . . . .	21	Jurgens & Andersen Co. . . . .	64	Rubenstein, L. W. . . . .	17
Bradley Polytechnic Institute. . . . .	90	Juergensen, Jules . . . . .	89	Rudolph & Snedeker. . . . .	89
Brower, Maurice . . . . .	54	Kahn, L. & M., & Co. . . . . Outside back cover		Rumpp, C. F., & Sons. . . . .	102
Brühl Bros. & Henius Co. . . . . Outside back cover		Kassel, Abe . . . . .	100	Sadler, F. H., Co. . . . .	35
Bryant, M. B., & Co. . . . .	21	Keck, Herman, Mfg. Co. . . . .	64	Saunders, Meurer & Co. . . . .	48
Buckley, Sam'l, & Co. . . . .	25	Kent & Woodland. . . . .	23	Schiff, M. . . . .	27
Bunde & Upmeyer Co. . . . .	44	Ketcham & McDougall. . . . .	92	Schultz, Leiss & Co. . . . .	18
Cahoone, Geo. H., Co. . . . .	32	Kohlbusch, Herman, Sr. . . . .	96	Sessions Clock Co. . . . .	90
California Jewelry Co. . . . .	42	Kohn, Alois, & Co. . . . .	27	Seymour, Cassius W. . . . .	103
Carrington & Co. . . . .	22	Kohn, L. & M., & Co. . . . .	27	Shiman Bros. & Co. . . . .	66
Carter, Howe & Co. . . . .	23	Kohn & Co. . . . .	27	Smith, Alfred H., & Co. . . . .	40
Chatham National Bank. . . . .	60	Koshland & Italie Co. . . . .	29	Smith, E. H. H., Silver Co. . . . .	34
Chopard Frères . . . . .	74	Lackner & Ohl. . . . .	76	Smith, Frank W. . . . .	19
"Cloverette" . . . . .	16	Langendorf Watch Co. . . . .	88	Snow & Westcott. . . . .	24
Conley & Straight. . . . .	104	Larter & Sons. . . . .	38	Sohn & Hyman. . . . .	52
Cooper Diamond Co. . . . .	46	Lederer, S. & B., Co. . . . . 30,	34	Solidarity Watch Case Co. . . . .	30
Cottle, S., Co. . . . .	24	Lelong, L., & Bro. . . . . Outside back cover		Spencer, E. L., Co. . . . .	32
Crohn, M. . . . .	30	Levy, L. W., & Co. . . . .	100	Staninger, E. E. . . . .	78
Cross & Begnelin. . . . . 30,	58	Levy, Robert . . . . .	19	State Bank . . . . .	60
Crouch & Fitzgerald. . . . .	26	Lewy & Cohen. . . . .	24	Steiner, Louis . . . . .	102
Culman, C. . . . .	96	Libbey Glass Co. . . . .	100	Stern Bros. & Co. . . . . 52, Inside back cover	
Day, Clark & Co. . . . .	23	Lissauer & Co. . . . .	42	Sternau, S., & Co. . . . .	16
Depasse Mfg. Co. . . . .	22	Loeb, Wm., & Co. . . . .	100	St. Louis Silver Co. . . . .	28
De Selms Watch School. . . . .	89	Lorsch, Albert, & Co. . . . . Outside back cover		St. Louis Watchmaking School. . . . .	78
Diamond Point Pen Co. . . . .	102	Lowe, Edwin, & Co., Inc. . . . .	34	Strauss, Ignaz, & Co. . . . . Outside back cover	
Didisheim, Hipp., & Bro. . . . .	89	Luthy & Hine. . . . .	24	Strauss, Jacob, & Sons. . . . .	52
Donnelly, J. J. . . . .	96	Lyons Gem Co. . . . .	46	Street, Geo. O., & Sons. . . . .	26
Doran, Bagnall & Co. . . . .	33	Maebert & Reiss. . . . .	90	Sturdy's, J. F., Sons. . . . .	14
Dorfinger, C., & Sons. . . . .	98	Maple City Glass Co. . . . .	98	Tavannes Watch Co. . . . .	74
Dubois Watch Case Co. . . . .	78	Market & Fulton National Bank. . . . .	60	Thomas, Seth, Clock Co. . . . .	90
Dulk, Robt. . . . .	22	Mathy Bros., Mathez & Co. . . . . 104		Tivoli Art Glass Co. . . . .	100
Dunbar, Leach, Garner Co. . . . .	96	Mendes Cutting Factories. . . . .	92	Trenton Watch Co. . . . .	89
Durand & Co. . . . .	22	Mercantile National Bank. . . . .	61	Trout, Charles L., & Co. . . . .	22
Eichberg & Co. . . . .	52	Meyerowitz Bros. . . . .	42	Van Dam, Eduard . . . . .	46
Elgin National Watch Co. . . . .	84	Miller, Fuller & Whiting. . . . .	30	Wadsworth Watch Case Co. . . . . 6,	7
Eliassof Bros. & Co. . . . .	76	Moe, Chas. . . . .	46	Wagner Mfg. Co. . . . .	26
E. P. H. Chain Catch. . . . .	25	Moore & Sons. . . . .	26	Waite-Thresher Co. . . . .	33
Eye-Fix Remedy Co. . . . .	92	Mount & Woodhull. . . . .	59	Washburn, C. Irving. . . . .	28
Fahys, Joseph, & Co. . . . .	1	Myers, S. F., Co. . . . .	34	Wells, Chester H. . . . .	28
Falchild & Co. . . . .	98	Nebeling, Edmund R. . . . .	46	Wendell & Co. . . . .	5
Favre-Jacot, Georges, & Co. . . . .	86	New York Central Railroad. . . . .	92	Western Clock Co. . . . .	35
Feeley, W. J., Co. . . . .	24	New York Telephone Co. . . . .	96	Wheeler, Hayden W., & Co. . . . .	40
Forman Co. . . . .	102	Nissen, Ludwig, & Co. . . . .	50	Whiteside & Blank. . . . .	23
Forsinger, J. W. . . . .	86	Noel, Rudolph, & Co. . . . .	64	Whiting & Davis. . . . .	20
Foster, Theodore W., & Bro. Co. . . . .	36	Nonnenmann, A., & J. Aschenbrenner. . . . .	35	Whiting Mfg. Co. . . . .	9
Freund, Henry, & Bro. . . . .	31	Noterman, Jos., & Co. . . . .	78	Wightman & Hough Co. . . . .	33
Friedlander, R., L. & M. . . . . 14, Outside back cover		Ohan, G. . . . .	89	Witsenhausen, L. . . . .	26
Garraud & Griser. . . . .	46	Ollendorfer, I., Co. . . . .	31	Wodiska, Julius . . . . .	29
Gesswein, F. W., Co. . . . .	96	Oppenheimer Bros. & Veith. . . . .	40	Wolfsheim & Sachs. . . . .	98
Goldsmith, Leo . . . . .	54	Oppenheimer, H. E., & Co. . . . .	40	Wood, C. F., & Co. . . . . Outside back cover	
Goodfriend Bros. . . . .	48	Oriental Bank . . . . .	60	Wood, J. R., & Sons. . . . . 2,	3
		Orkin Bros. . . . .	34	Woodside Sterling Co. . . . .	12

## Special Notices.

Payable invariably in advance.

Rates 75c. per insertion for notices not exceeding 25 words; additional words, 2c. each.

SITUATIONS WANTED, 1c. a word each insertion; minimum charge, 25c.

Heavy type, 5c. a word; minimum charge, \$1.25. Display cards, \$2.00 per inch.

In all cases, if answers are to be forwarded, 10c. extra to cover postage must be enclosed.

*All answers to advertisements addressed care The Jewelers' Circular-Weekly, should be sent to the New York Office, unless the Chicago Office is specifically mentioned.*

## Situations Wanted.

ENAMELER, first class on jewelry and badge work, desires position. J. B. Davis, 924, E. 151st St., Bronx, N. Y.

SALESMAN, young man, 23, experienced, wishes to make a connection with A1 house. "V., 6909," care Jewelers' Circular-Weekly.

FIRST CLASS engraver and diamond setter desires a position by Sept. 1. Mr. Sereno W. Woodhull, 101 Marshall Ave., Gloversville, N. Y.

POSITION as watchmaker or general man; no engraver; 23 years' experience; age 37; married; competent to take charge. 141 Ross Ave., Hamilton, O.

ENGRAVER (26) wants steady position; can do some jewelry and clock repairing and wait on trade. E. R. Whiston, 224 S. Elm St., Greensboro, N. C.

SALESMAN, with over 20 years' experience on the road, in the south and far west, is open for position; highest testimonials. H. S., 98 Columbus Ave., New York.

SITUATION WANTED by young German; well acquainted with precious stone line and also thorough bookkeeper. Address "Young, 6932," care Jewelers' Circular-Weekly.

WANTED, POSITION as traveling salesman for manufacturing line; first class man for either eastern or western States. "New York, 6911," care Jewelers' Circular-Weekly.

YOUNG LADY, double entry bookkeeper; three years' experience in wholesale jewelry house; accurate and reliable. Address "Bright, 6908," care Jewelers' Circular-Weekly.

WANTED, A POSITION as engraver, bookkeeper, cashier and saleslady; good references; terms reasonable. Address "Enquirer, '5877," care Jewelers' Circular-Weekly.

FIRST CLASS designer and modeler on novelties and sterling silver hollow ware; artistic and practical; desires position. Address "A. B. C., 6881," care Jewelers' Circular-Weekly.

DIAMOND SETTER; young man wishes position as foreman setter, or to take charge of office and setting department; good experience; A1 references. "Setter, 6915," care Jewelers' Circular-Weekly.

REFRACTIONIST; good salesman; have latest instruments; thoroughly familiar with jewelry business; seven years' experience; best reference; age 23. "Ref., 6896," care Jewelers' Circular-Weekly.

FOREMAN, designer and thoroughly experienced jeweler, fine platinum mountings a specialty; fully able to manage small or large factory in all its details. Address "A. S., 6907," care Jewelers' Circular-Weekly.

BY MANUFACTURING JEWELER; had charge of shop for a number of years; expert in all branches of moulding and casting; city or vicinity preferred. Address "S., 6910," care Jewelers' Circular-Weekly.

YOUNG MAN, with six years' experience as first class jeweler and clock repairer; also understands coloring, polishing and make solutions; good references; desires permanent position. "S. H., 6928," care Jewelers' Circular-Weekly.

YOUNG MAN (19) desires position; three years' experience with wholesale jewelry house; two years as office assistant and stock clerk and one year as old gold clerk; salary, \$12. "Wholesale, 6934," care Jewelers' Circular-Weekly.

ASSISTANT WATCHMAKER would like position Aug. 15; small town near New York preferred; four years' experience; want to finish trade under good watchmaker; best reference. "Finish, 6933," care Jewelers' Circular-Weekly.

A WATCHMAKER of recognized ability; trained in London; 15 years' American experience; seeks position in first class firm as fine watchmaker and adjuster; highest references; have also New York optical diploma. "H. G., 6794," care Jewelers' Circular-Weekly.

YOUNG MAN, possessing seven years' experience in the wholesale jewelry business, desires position where hard; conscientious work will be appreciated; no objection to leaving city; unquestionable references. "Conscientious, 6927," care Jewelers' Circular-Weekly.

WATCHMAKER wants position by Aug. 15; 20 years' experience; familiar with railroad work and handling fine trade; sober and steady; good appearance; gilt edge references; tools; 30 years old; married; salary, \$25 per week. Address "Reliable, 6918," care Jewelers' Circular-Weekly.

SALESMAN, having 15 years' experience in Cosmopolitan district and on road; am thoroughly acquainted with jewelers, department store and jobbing buyers; novelties preferred; reference and character, and security A1; age 38; American born. "R. A. N., 6939," care Jewelers' Circular-Weekly.

AD. MAN and A1 correspondent desires position with jewelry or silverware concern (wholesale or retail); highest endorsements as to business ability, character, etc.; can show specimens from ad. campaign which "delivered the goods" and secured many new customers; salary, \$1,500. "Business, 6850," care Jewelers' Circular-Weekly.

ACCOUNTANT of large experience wishes to establish connections in the jewelry trade; books audited, statements taken off and bookkeeping systems established; terms \$5 per day in New York. Address, "S., 6900," care Jewelers' Circular-Weekly.

## Side Lines Wanted.

WANTED, AT ONCE, one or two first class manufacturer's lines on commission or salary; New York City or traveling. "S. W., 6801," care Jewelers' Circular-Weekly.

## Help Wanted.

WANTED, good, plain engraver; apply with references. Geo. O. Herrmann, Jeweler, Newport, R. I.

WATCHMAKER WANTED; must be good workman. Call at L. H. Keller & Co.; 64 Nassau St., New York.

AT ONCE, watchmaker and engraver; permanent position to a good man. "M., 6849," care Jewelers' Circular-Weekly.

WANTED, a good jeweler and engraver; permanent position for good man. Address M. E. La Vake, Princeton, N. J.

WANTED, two first class jewelry and silverware salesmen, for retail trade. Apply to Duhme Jewelry Co., Cincinnati, O.

JEWELERS WANTED, experienced men on fine platinum work, highest salaries. Lebolt & Co., 167 169 State St., Chicago, Ill.

YOUNG LADY wanted to make herself generally useful in wholesale jewelry house. L. S. Meyer & Bro., 38 Maiden Lane, New York.

JEWELER and plain diamond setter; steady position to capable man. Address Chas. G. Willson Manufacturing Jeweler, Reading, Pa.

WANTED, experienced salesman for established line of cut glass in New England and Middle West. Address Box 774 J, Corning, N. Y.

GOOD POSITION open for young lady, one who understands the wholesale jewelry line. Fred Kaufman & Co., 565 Broadway, New York.

GOOD POSITION open for young man; one who understands the wholesale jewelry line. Fred Kaufman & Co., 565 Broadway, New York.

WANTED, SALESMAN; watch and jewelry salesman; permanent, responsible position. "Salesman, 6915," care Jewelers' Circular-Weekly.

WANTED, a first class watchmaker; references required; apply by letter. The Bailey, Banks & Biddle Co., 1218 Chestnut St., Philadelphia, Pa.

SETTER WANTED, permanent position; give references, experience, age and salary in first letter. M. E. Nabstedt & Sons Co., Davenport, Ia.

WANTED, good all round jewelers, job and special order work; steady work; good pay. Weiss & Fassett, Globe Democrat Bldg., St. Louis, Mo.

AT ONCE, first class watchmaker and optician; steady position and good pay; must be capable of handling railroad watches. W. J. Gamm, Madison, Wis.

WANTED, young man as assistant watchmaker; must be fair workman and own tools; also sober; good chance for advancement. F. L. Herbert, Chatham, N. Y.

WANTED, watchmaker and engraver; permanent position; good wages. Address Little, Long Co., Charlotte, N. C.; or, M. J. Averbek, 19 Maiden Lane, New York.

WANTED, second watchmaker and repair man; salary, \$15 per week; steady position; send photograph and reference. Address Box 890, Charleston, W. Va.

WANTED, first class watch and clockmaker and engraver; must be A1 workman; no others need apply; steady job, \$20 per week. C. A. Tucker, Jeweler, Lincoln, Nebr.

SALESMAN; as a side line; must be acquainted with the engraving trade. Address Edward C. Muller, manufacturer of fine engraving tools, 35 Frankfort St., New York.

DESIGNER, one experienced in silver business, on hollow ware; state experience, salary expected, etc. T. F. Tuttle Silver Co., 337 Washington St., Boston, Mass.

WATCHMAKER WANTED in wholesale jewelry house; one who understands trade work; steady position to right man. L. S. Meyer & Bro., 38 Maiden Lane, New York.

WANTED, a first class watchmaker, jeweler, engraver and optician; permanent position at \$2.00 a week; only first-class men need apply. M. Hammerslough, Anaconda, Mont.

WANTED, ENGRAVER and salesman, one who can do some jewelry repairing or optical work preferred; steady position for a good man. A. D. Norton Co., Gloversville, N. Y.

WANTED, letter and monogram engraver and jewelry chaser; send sample of work, reference and salary with first letter. Address "A. D., 6884," care Jewelers' Circular-Weekly.

WANTED, young man with five or six years' experience in manufacturing jewelry shop; must be good jobber and be able to do some new work. Address E. C. Harpstrite, Wichita, Kans.

WANTED, a first class watchmaker and engraver, an all around good man; steady employment; send references and sample of engraving in first letter. Address S. Spitz, Santa Fe, N. Mex.

WANTED, WATCHMAKER, must be good salesman; experienced; salary based upon ability. Jules Ascheim, 37 Maiden Lane, New York; or, Southern Loan and Jewelry Co., Tampa, Fla.

WANTED, engraver and jeweler; send reference in first letter. Sylvan Bros., Columbia, S. C.

WANTED first class watchmaker and salesman. "Permanent, 6910," care Jewelers' Circular-Weekly.

WANTED, optician and engraver, with some knowledge of jewelry repairing. Sylvan Bros., Columbia, S. C.

WANTED, good combination watchmaker, engraver and salesman; wages \$22 weekly; permanent; hours, 8 to 6; all particulars and references in first letter. T. W. Morrison, Newburgh, N. Y.

**HELP WANTED.—Continued.**

**WANTED, WATCHMAKER,** must be skilled mechanic in all grades of high class work; good wages and permanent position to A1 man; send references. Henry Birks & Sons, Ltd., Montreal, Canada.

**WANTED, good engraver** who can do fine monogram, old English and script lettering; good salary; permanent job, young man preferred. H. C. Abbott & Bro., 1905 Second Ave., Birmingham, Ala.

**WANTED, CLOCKMAKER,** who is also an experienced letter and monogram engraver, send samples of engraving with references, and state salary wanted. "Samples, 6832," care Jewelers' Circular-Weekly.

**WANTED, first class retail jewelry salesman;** prefer one capable of designing jewelry; fine, steady position to a high class man; no others need apply. Frederics, 23 E. 20th St., seventh floor, New York.

**WANTED, good watchmaker;** must be capable of doing ordinary engraving and waiting on trade; permanent position to right man; good salary. Address Krauss & Sectors, 45 N. Illinois St., Indianapolis, Ind.

**WANTED, young man;** experienced salesman in general jewelry business; permanent position; must have best references; state full particulars and salary in first letter. Address P. O. Box 208, Cleveland O.

**WANTED, experienced watchmaker, engraver and salesman;** send sample of engraving, reference, age and salary expected; steady position and short hours. Address "Indiana, 6821," care Jewelers' Circular-Weekly.

**WANTED, watchmaker;** must be first class and be able to do high grade work on railroad and high grade watches; state what salary required and give references. "R. K., 6824," care Jewelers' Circular-Weekly.

**A FIRST CLASS ENGRAVER;** one who can do all kinds of lettering and monogram engraving; can use a good steady man at a good salary. Apply to A. Newsalt, Jeweler, cor. Fourth and Main Sts., Dayton, O.

**FIRST CLASS watchmaker and optician wanted,** good opportunity offered to right party; steady position; in one of the large cities in Pennsylvania; write at once. L. W. Rubenstein, 54 Maiden Lane, New York.

**WANTED, SALESMAN** for Chicago trade to sell jewelry and solicit special order and repair work; one familiar with manufacturing preferred. Address "Mfg., 6845," care Jewelers' Circular-Weekly, 103 State St., Chicago, Ill.

**FIRST CLASS watchmaker for American house,** in New York. Address "Permanent, 6784," care Jewelers' Circular-Weekly.

**JEWELRY REPAIRER and stone setter** for American house, in New York. Address, "Permanent, 6785," care Jewelers' Circular-Weekly.

**WANTED, a first class optician;** one who understands edge grinding preferred; steady employment and good wages to the right man; must come well recommended. Address "Central Connecticut, 6640," care Jewelers' Circular-Weekly.

**WANTED, AT ONCE, two first class men and one lady,** one watchmaker, jeweler, engraver and optician; one engraver and salesman; also one saleslady and engraver; give full particulars in first letter. B. L. Cates, 809 Second Ave., Seattle, Wash.

**WANTED, AT ONCE, a good watchmaker,** capable of handling fine watches; also able to do jewelry work; pleasant and steady position to the right man; must come well recommended; state full particulars in first letter. John W. Ware, Dunkirk, N. Y.

**RESPONSIBLE TRAVELERS** to take our line, consisting of fine Elk and gold jewelry, southeast and New England, also large and small cities in the entire west, as a side line on a commission basis; state territory. Schickerling Mfg. Co., 31 W. 31st St., New York.

**WANTED, first class watchmaker** to take in and deliver work and work at bench; must be good appearing and understand how to handle fine trade; also one fine bench watchmaker; highest wages to right parties. Address Lawrence L. Moore Co., Seattle, Wash.

**WANTED** for Virginia, salesman, young man about 25 years old, with practical experience preferred; permanent position; \$50 per month with chance to advance; send photo and recommendations in first letter. Address care Room 711, 2 Maiden Lane, New York.

**WANTED good watchmaker who can engrave;** good position for a first class man; permanent; address with references. Sylvester Engle, Hazleton, Pa.

**WANTED A1 watch repairer, one of experience,** with full set of tools; send references and wages expected in first letter. E. J. Brown, 214 Asylum St., Hartford, Conn.

**WANTED, AT ONCE, a thorough, competent watchmaker, jeweler and diamond setter;** one who can do some engraving preferred; must be sober and industrious; a permanent position to the right man; address, stating wages and references. W. T. Eisensmith, Box 358, Charleston, W. Va.

**EXPERIENCED watchmaker and clock repairer;** quick workman, for Washington, D. C.; fine French and chime clocks your special work; apply, stating years of experience and where, also age, and wages expected; life position to right man; hours, 8 to 6. "Box 6833," care Jewelers' Circular-Weekly.

**WANTED, strictly first class combination man** (watchmaker, jeweler and engraver); must be sober and well recommended; good salary and permanent position to good man; must be a willing worker, rapid and very thorough; state salary expected and send sample engraving in first letter, Thos. Van Auker & Co., 516 Pearl St., Beaumont, Tex.

**COMPETENT WATCHMAKER AND engraver** wanted for the Philippine Islands; salary \$125 per month; replies should mention full particulars. Address, "Opportunity, 6935," care Jewelers' Circular-Weekly.

**WANTED, salesman** for a leading American watch house to travel Pennsylvania and New York; an unusual opportunity; state experience and address in confidence, "Watches, 6930," care Jewelers' Circular-Weekly.

**WANTED WATCHMAKER;** Abraham & Straus, Brooklyn, can place in a permanent position at liberal salary a competent man who thoroughly understands watch repairing in all its details. Apply to Superintendent.

**WANTED first class diamond and precious stone salesman,** one who has experience with southern and western trade; excellent opportunity for a hustler; good salary and commission; answer by letter, stating experience, etc.; communications confidential. "C., 6690," care Jewelers' Circular-Weekly.

**TRAVELING WATCH SALESMAN** and watch inspector for one of the leading railroads in Mexico; must be practical man of experience, and well up in watches; single, good habits, best references and possessing ability to make friends and hold them; dealings with Americans, knowledge of Spanish unnecessary; Elgin and Waltham watches; good salary with excellent opportunity for advancement to right man; to travel in the best part of Mexico; climate unsurpassed, cool summers, warm winters; write fully in first letter, giving experience, age and references, with photo if possible. A. C. Smith, General Watch Inspector for the Railways of the Republic of Mexico. Apartado 2151, City of Mexico, Mexico.

**Business Opportunities.**

**FOR SALE,** very cheap, old established jewelry and optical store. T. J. Skidmore, 750 Fulton St., Brooklyn, N. Y.

**\$450.00 BUYS** jewelry store; New York State; manufacturing town of 6,000; best location; town will support a large stock. Address "Jewelry, 6917," care Jewelers' Circular-Weekly.

**\$2,500 BUYS** a well established jewelry and optical store in New York City; good neighborhood; reason interested in other business. Address "A. L., 6942," care Jewelers' Circular-Weekly.

**FOR SALE,** well equipped manufacturing jewelry shop, in rapidly growing western city of 40,000; good machinery; old established place; no competition. Address "F. G., 6860," care Jewelers' Circular-Weekly.

**FIRST CLASS manufacturing jeweler** will invest some capital and take active part as inside man with an established manufacturing jeweler, in or around New York. Address "Active, 6941," care Jewelers' Circular-Weekly.

**FOR SALE,** jewelry and optical business, doing good business in one of the best health and pleasure resorts of Colorado; invoice, \$4,000; can reduce or give time on part. "Resort, 6924," care Jewelers' Circular-Weekly.

**PAYING JEWELRY BUSINESS** in New Orleans; established over 50 years; best business location. For further details, address, Danziger & Tessier, 134 Carondelet St., New Orleans, La.

**I WANT YOU TO KNOW, Mr. Merchant,** that if you wish to retire from business I can turn your store into cash; my charges are a small commission if I sell your store; no charges if I do not; write me; all is held in strict confidence. Address Dan. I. Murray, Broker, 3 Maiden Lane, New York.

**MAN,** thoroughly experienced in the manufacturing of jewelry for the wholesale or retail trade; artistic designer and modeler, for the cutting of steel dies by machine; owner of a patent for the making of ornamented seamless bracelets and rings, hollow or solid, in plate or solid gold; wants a partner with capital to start a plant, which is not only promising but cannot fail to be successful. Address "Partner, 6830," care Jewelers' Circular-Weekly.

**CASH PAID** for entire jewelry stores and stocks; send us your surplus stock, and we will send you a check by return mail; if our offer is unsatisfactory we return your goods; we act quickly and strictly confidential. Jos. Brown & Co., Fifth Ave. and Madison St., Chicago, Ill.

**DO YOU WISH TO RETIRE?** We buy jewelry stores to any amount; also entire stocks of jewelry, diamonds, watches, silverware, fixtures, etc.; we are known all over the United States to pay highest spot cash; notify us, we will call on you at once; all business transacted we handle strictly confidential. Address Brooklyn Purchasing Syndicate, 608 Broadway, Brooklyn, N. Y., or Tel. 2328, Williamsburg.

**To Let.**

**DESK ROOM** or part of office to let. 3 Maiden Lane, Room 53, New York.

**TO LET,** an exceptionally desirable small office, with fine north light; seventh floor; 7 Maiden Lane. Inquire W. W. Young & Co., Room 74, 7 Maiden Lane, New York.

**TO LET,** part of an exceptionally desirable office, with fine north light; opportunity for precious stone business or manufacturer's agent. Room 48, Lorsch Bldg., 37 Maiden Lane, New York.

**WILL RENT** to desirable party, desk room with office privileges, in light, attractive office; manufacturer's representative or diamond dealer preferred. "Maiden Lane, 6931," care Jewelers' Circular-Weekly.

(Special Notices continued on page 72.)

*Now on Press*

1906-1907 EDITION

OF

THE JEWELERS'  
CIRCULAR-WEEKLY

# Buyers' Directory

OF THE

Manufacturers, Importers  
and Jobbers

IN THE

JEWELRY AND  
KINDRED TRADES

A Handy, Classified List for Desk or Pocket

*Price, 50 Cents*

*The Jewelers' Circular  
Publishing Co.*

11 JOHN ST. - NEW YORK  
(Corbin Building)

## Partnership Notice.

Notice is hereby given that the business heretofore conducted in the city of Fresno, county of Fresno, state of California, at No. 1119 J street, in the name of H. B. Oberlin, was, on the 1st day of June, 1906, changed to the name of Oberlin Bros., which said firm consists of H. B. Oberlin and C. S. Oberlin, who are equal partners therein, and who are each liable as partners for all indebtedness against said business, heretofore conducted by H. B. Oberlin, and they each of them will be personally liable under the laws of the state of California relating to partnerships for all outstanding indebtedness and for all that may be incurred hereafter in the conduct of said business.

## Practical Course in Adjusting

By THEO. GRIBI.

### COMPRISING

A review of the laws governing the motion of the balance and balance spring in watches and chronometers, and application of the principles deduced therefrom in the correction of variations of rate arising from want of isochronism, change of position and variation of temperature.

### ELUCIDATED AND DEMONSTRATED

by original experimental researches in the actual problem, never before published, showing the causes that are operative in the variation of rate, and leading to correct remedies. To which have been added chapters on

How to make a Balance Arbor with Modern Appliances; How to Clean a Watch Properly; and, the Lever Escapement—Some Current Defects in it and How to Remedy Them.

PRICE, \$2.50.

250 pages, including 18 diagram plates; Fine Paper; Large Type; Clear Illustrations; Systematically arranged; Solid Binding.

THE JEWELERS' CIRCULAR PUB. CO.  
Publishers

11 John St., cor. Broadway, New York.

## GEO. I. GREENFIELD

42 Maiden Lane, New York

DESIGNING, CHASING AND  
ETCHING FOR THE TRADE

CHASING ON HOLLOWWARE  
A SPECIALTY

HORACE A. DWYER, President.  
11 years with Tiffany & Co.  
9½ years with Garraud & Griser  
Awarded a Diploma by the  
Exposition at Chicago, 1893

HENRI CASENOVE, Sec. & Treas.  
12 years with Tiffany & Co.  
MINERALOGIST

H. O. DREHER, Vice-President  
12 years with Tiffany & Co.  
2½ years with Shreve & Co.  
Awarded a Medal and Diploma  
by the Exposition at Paris, 1900

"There is Nothing in the Art that we cannot do."

# The International Gem Co. Inc.

12-16 JOHN ST., NEW YORK

TELEPHONE, 1241 CORTLANDT

LAPIDARIES and IMPORTERS of PRECIOUS STONES

SPECIALISTS IN REPAIRING AND REPOLISHING RARE AND VALUABLE GEMS  
DRILLING - ENGRAVING - SLITTING

## Special Notices.

(Continued from page 71.)

### For Sale.

THREE DOZEN ring and jewelry trays; two watchmakers' lathes, one Seth Thomas calendar and antique clock; watch repair and spectacle case; for cash or exchange. Chas. Dreyer, 10-Suydam St., Brooklyn, N. Y.

AT 50 CENTS ON THE DOLLAR, a lot of bracelets, long chains, set tie pins, chatelaine pins, hair barrettes, hatpins, scaripins, necklaces; prices, 75 cents to \$3.75 dozen, fine 10 per cent. for cash; goods were manufactured for a jobber who failed; selection packages sent to well rated jewelers. Dan I. Murray, Broker, 3 Maiden Lane, New York.

\$48 TO \$58 PER CARAT for diamonds; sounds cheap, but I have a lot of ½ to ¾ carat fine white, old mine diamonds, bought this week from an estate; I will sell them at this price. don't wait a moment to write for them; wire to-day as I often sell out same day I buy, try me once for bargains in diamonds; sent on memorandum to well rated dealers; express paid on all bills of \$100 or over. Dan I. Murray, Broker, 3 Maiden Lane, New York.

AT 25 per cent. to 40 per cent. less than regular price, a job lot of real amber necklaces, fine cut jet brooches, jewel necklaces, French pearl necklaces and cut crystal hat-pins, all of German and French manufacture; must be sold at once; price, \$1.25 per dozen up to \$60 dozen, less 5 per cent. 10 days, net 30 days; selection packages on memorandum to well rated dealers; any one lot if you want ambers and jets at cut prices; be quick or you will regret it. Dan I. Murray, Importer, Broker, 3 Maiden Lane, New York.

### Wanted to Purchase.

WANTED, pair of hand rolls; flat and wire; also drilling lathe; must be a bargain. Address "H. D.," 776 Gates Ave., Brooklyn, N. Y.

WANTED, jewelers' safe, roll top bench, regulator clock, counters, cases, etc., cheap, for cash. "Roberts, 6844," care Jewelers' Circular-Weekly.

### TO LET.

## Three Desirable Light Lofts.

At 31 MAIDEN LANE, N. Y.,

One door from Nassau St. Prominent location, center of jewelry district. Address F. J. Whiton, 130 Broadway, New York; or, your own broker.

## WORKSHOP NOTES

(Third Edition)

For Jewelers and Watchmakers.

A collection of the latest practical receipts on the manufacture and repairing of watches, clocks and jewelry.

Price,  
**\$2.50**

300 pages  
(size 7½x  
10½ inches),  
bound in  
cloth, stiff  
covers.  
Should be  
on every  
workbench.

Published by

THE JEWELERS' CIRCULAR  
PUBLISHING CO.,

11 John St., Cor. Broadway, New York.

## Omaha.

Geo. W. Ryan, of the Mawhinney & Ryan Co., has returned from Lander, Wyo.

Miss Mary Hurst, with Brown & Borsheim, has returned from Denver and Manitou.

Arthur Stillman, of the Mawhinney & Ryan Co., is spending his vacation at Blue Lake, Ia.

Henry Copley, wife and daughter, will leave to-day for New York, and will stop at the Navarre Hotel.

Joseph P. Frenzer is making a trip through Oklahoma and Texas, to be absent from the city two weeks.

J. F. Mawhinney, of Mawhinney & Ryan Co., has moved into his new home, recently completed.

Chas. B. Brown, of Brown & Borsheim, accompanied by his wife, has gone to Buffalo, N. Y., on a pleasure trip.

Albin Kaas, of S. W. Lindsay, is spending his vacation in Chicago and the Lakes. Albert Winters, with the same firm, has gone to Beatrice.

Wm. Smith, of the Smith Jewelry Co., West Point, Nebr., was in the city last week calling on friends and replenishing his stock before returning home.

The following jewelers of Omaha are closing their stores at 5 p. m. during the months of July and August: Albert Edholm, Henry Copley, A. Standelberg, Brown & Borsheim, Fred Brodegaard & Co., T. L.ombs & Co., S. W. Lindsay, Mawhinney & Ryan Co., and Joseph P. Frenzer.

An employe of one of the South Omaha backing houses called at Albert Edholm's jewelry store last week, to ascertain the value of a diamond ring taken, he said, from the stomach of a cow, slaughtered at the yards. The ring was of a Tiffany setting, and Mr. Edholm placed a value of \$65 on it.

The out-of-town jewelers in the city last week purchasing stock included: John Crabbell, Plattsmouth, Nebr.; W. J. Legg, Hastings; K. C. Koons, Beatrice; J. A. Reuling, Wymore; Max Egge, Grand Island; W. W. Dwight, Niobrara; Mr. De Stonter, Palmer; B. F. Smith, Valley; Morris Barnes, Avoca, Ia., and J. H. Riffe, Craig, Mo.

## Buffalo, N. Y.

Roy Failing, of the Failing Optical Co., Main St., has nearly recovered from the effects of severe burns received in the explosion of a gas stove.

Frank Sutherland, who a few weeks ago established a jewelry store at 122 Broadway, has sold his stock and has gone to Asheville, N. C., where he will engage in watch repairing.

Frank Hammond, 54 Seneca St., came home Saturday from the Adirondacks, where he was a guest of E. Van Etten, vice-president of the New York Central Railroad Co. Mr. Hammond has just completed his inspection of watches of Boston & Albany Railroad employes.

A. E. Sipe, 8 Mooney building, heads a movement for closing the wholesale houses on Saturday afternoon during July and August. Mr. Sipe will go with his family, July 25, to the Thousand Islands, to be

absent several weeks. He will be joined here by his brother, George W. Sipe, Koko, Md., who will accompany him on the trip.

Paul Kinney, 16 years old, son of Jirch Kinney, jeweler at 92 Seneca St., was found lying insensible by the side of his bicycle in a highway about a mile from his home in East Aurora last Thursday. The boy had been thrown from his wheel, and had struck on his head. On Saturday he had not regained consciousness, and the family was much alarmed, fearing that his skull was fractured.

## Rochester.

Philip Present is spending a few days' vacation at Keuka Lake.

Elery A. Handy will shortly move into the quarters on State St. until recently occupied by Gooberlet Bros., dealers in leather novelties. The store is being altered, and some attractive improvements are being made. Mr. Handy will put in many new fixtures, and will carry an extensive line of watches and jewelry.

Little enthusiasm is being displayed by jewelers here in the coming national convention of the jewelers to be held in this city. Some say that it is immaterial to them whether a national association is formed or not. Others think that the attempt to organize will prove a failure. It might be supposed that with jewelers coming from all parts of the country local dealers would get together and show that they are not asleep. When the New York State association was formed, this city was not represented. Rochester could have an association—and a good one—if the jewelers would get together.

## New Orleans, La.

William Frantz & Co., 142 Carondelet St., have opened a branch store and repair shop in Rampart St., opposite the Union Station.

J. Julius Weinfurter will soon take a much-needed rest in the fine pine land country of the Ozone Belt, on the northern shore of Lake Pontchartrain.

Gabe Hausmann, of T. Hausmann & Sons, expects to leave for New York by steamer in a few days. Mr. Hausmann before his return home will travel extensively in the north and east.

## Pacific Coast Notes.

A. A. Poole, Santa Barbara, Cal., has moved into enlarged quarters in the Hopkins building.

J. D. Bennett, San Rafael, Cal., accompanied by his wife, is on a vacation in Los Angeles, Cal.

G. W. Weber, Long Beach, Cal., has moved from his former location at 130 W. Second St. to the room next door, 128 W. Second St. He has more room, and intends to improve the store.

The Business Men's Association of Scranton, Pa., of which several jewelers are members, has decided to close the stores in that city every Wednesday afternoon during July and August.

## The Diamond Markets.

ANTWERP, July 4.—The quiet condition of the diamond market at the present time is due to many merchants now being on their Summer vacations. There is no great demand for large stones nor for brown roses and six faces, but good *mêlée* find ready buyers at good prices.

A large number of foreign buyers visited the Diamond Club during the past fortnight. Among others: Mr. Hekster, Amsterdam; Messrs. M. Slabotsky, Mathiossian, Rouline, Eknoryan, Schiff, L. Von Moppes, E. Mayer, Sigaar, Bismuth, Haski, Slyper, Mitacoupolo, all of Paris; Messrs. Weinberg, Eisner, Bailey, Ben Rees, Hess, New York; Messrs. Goldberg, Robinson, Kauffman, L. Von Moppes, Rodrigues, Tufeld, London; Mr. Gorette, Rome; Mr. Lagowir, Moscow; Mr. Nocera, Naples; Mr. Winkler, Vienna; Messrs. Schaul and May, Atlanta, Ga.; Mr. Atlas, Philadelphia; Mr. Witta, Turin; T. Singer, Farlow; Mr. Abend, Berlin; Messrs. Agopovitsch and Ostarjean, Andrinople; Mr. Schatkin, Liverpool; Mr. Manskled and Mr. Weintraub, Warsaw; Mr. Mayers, Boston; Mr. Haningsberg, Berlin; Mr. Alfanari, Constantinople; Mr. H. Strauss, Hanau; Mr. Balaiche, Alger; Mr. Ribaconi, Buchard.

AMSTERDAM, July 4.—Business will continue rather quiet until the end of August when many merchants who are now on their vacation will return for active work. Good *mêlée* and very small brilliants are about the only varieties that find buyers readily. Rough goods have been more regular during the past fortnight.

The diamond factory of Mr. Deldan, Van Hall St., will be sold shortly. The factory has 56 mills. The new factory of Eduard Van Dam, which is to be erected very soon by architect Van Arkal, will be fully equipped, having about 300 mills.

PARIS, July 4.—The French market, like all other European markets, feels the absence of many of its prominent merchants, and it is expected that the market will be very quiet until the end of August, though there have been some good sales made in white roses and *mêlés* during the last week, as well as in two and three grain brilliants, the large brilliants not being asked for. There have also been a few buyers for white pearls, but sales in colored stones were of little importance.

Miss Belle Grunberg, daughter of Mr. Grunberg, a well-known diamond merchant, was married recently to Mr. Goldschmidt. Oscar Gerder was married to Miss D. Rosenthal, daughter of Mr. M. Rosenthal.

Mr. Vanderheyem left for Antwerp to-day and will return next week.

C. C. Minton, formerly in business in El Reno, Okla., has completed arrangements to move to Oklahoma City, Okla., where he has secured desirable quarters in which to continue in the jewelry business.

H. L. Frick, of Ford & Frick, Freeport, Ill., has purchased the interest of W. G. Ford, and will continue the business alone. The partnership was begun about 18 years ago. Mr. Ford, who has been engaged in the jewelry business for over 44 years, will take a much-needed rest.



## Bigalke & Eckert Co.

IMPORTERS OF WATCHES,

No. 1 MAIDEN LANE, NEW YORK

Single and Split Second Timers in Nickel and Gun Metal Cases.

Complete Assortment of Chronographs,  
Split Seconds and Minute Repeaters.

Ladies' and Gentlemen's Flat and Ultra Flat Watches.

Flat Calendar Watches.

SOLE AGENTS FOR

**Haus, Neveux & Cie.**

FINE GENEVA WATCHES.



## SAVE A TRIP TO PARIS

by calling at our office and looking over our line of the newest French Styles in

Combs, Brooches, Festoons, Hair Barrettes, Buckles, Crosses, Bracelets, in Jets and Metals

**CHOPARD FRERES,** Makers of Art Jewelry Novelties

PARIS, FRANCE—35 Rue des Trois Bornes

49 MAIDEN LANE, NEW YORK CITY

# A NEW MOVEMENT

THE O-SIZE 7 JEWELLED PENDANT SETTING

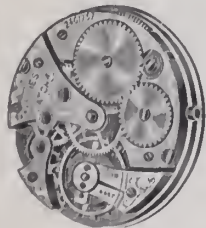

## **TAVANNES**

==== *Is* ====  
**Fully Guaranteed**

FOR SALE THROUGH THE JOBBING TRADE

## TAVANNES WATCH COMPANY

2 & 4 Maiden Lane, New York

**Connecticut**

Work has just been begun on the addition to the plant of the W. L. Gilbert Clock Co., Winsted.

N. L. Bradley has been re-elected director of the Connecticut School for Boys, formerly the State Reform School.

The S. L. & G. H. Rogers Co., Wallingford, have resumed work after the usual Summer shut-down. They are now running at full time.

The factory of the Sessions Clock Co., Forestville, resumed operations, July 12, after being shut down for 10 days while an inventory was taken.

In the Charles Parker Clock Co.'s factory, Meriden, Otto Schipke, an employe, was injured in the gear of a machine one day last week, his left arm being mangled.

The International Silver Co. has awarded the contract for an addition to its plant in Bridgeport, the plans calling for the erection of a one-story brick structure, 18 by 200 feet.

Work was begun this week just above the headgates of the R. Wallace & Sons Mfg. Co.'s race way, Wallingford, for the building of a copper dam, preparatory to putting new foundations for the head gates.

George D. Munson and Charles D. Morris have been elected directors of the Dime Savings Bank, Wallingford, and Clifford W. Leavenworth was elected to fill the vacancy caused by the death of his father, Col. Walter J. Leavenworth.

Edward Ingraham, a son of W. S. Ingraham, received word several days ago that he had passed his entrance examinations at Yale University. He will enjoy his vacation trip to Alaska all the more for the knowledge that came to him before starting.

Judgment for \$984 was awarded the plaintiff, last week, in the Court of Common Pleas, New Haven, in the suit of Barton & Co. against the Ford Co. The action was based on charges for engraving, and the defendant claimed that the bill had been paid.

In honor of the birthday anniversary of N. Burton Rogers, one of its members, the Fairmont Ave. Club, at Danbury, on July 10, gave a clambake at his country home at Ballas Pond. There were 25 guests. A handsome fishing rod and tackle were presented to Mr. Rogers.

Among the jewelry stores in Waterbury that have joined merchants in other lines in an agreement to close every Thursday from July 10 to August 28, inclusive, at 12 o'clock noon are the Lake & Strobel Co., Gaffney Jewelry Co., Frank P. Becton, the Union Jewelry Co. and others.

N. L. Bradley, D. W. Parker, W. F. Rogers, Wm. H. Lyon and C. P. Bradley, at a meeting last week, were elected directors of the City Savings Bank of Meriden. C. C. Rockwell, Clarence P. Bradley, D. W. Parker, V. L. Bradley, E. Miller, Jr., Wm. H. Lyons, C. F. Rockwell, Gilbert Rogers, C. B. Rogers and George H. Wilcox were elected trustees of the same bank.

The annual lawn party was held Wednesday afternoon of last week by the Sessions Foundry Co., Bristol. The lawn around the several shops was well filled with employes and friends, fully 4,000 persons be-

ing present. President Sessions and Director Eggleston were on hand to greet the people of the town. A band provided music and fireworks was a feature of the evening.

Franklin Terry, who has been superintendent of the movement department of the Sessions Clock Co., Forestville, for the last three years, has severed his connection with the company. His successor is Samuel Mink, who has been acting for some time as assistant superintendent. Another foreman to retire is Waldo Forbes, of the finishing department. His successor will be Arthur Roberts, of Plainville.

**Pittsburg.**

Sam F. Sipe has bought an automobile.

A number of local jewelers are preparing to leave the first week in August on their vacations.

C. L. Baird, Fairmont, has sold out his store to Mr. Scott, formerly of Marietta, O., who intends to make a number of improvements to the store.

W. J. Johnston, of the W. J. Johnston Co., left last Friday night, for Atlantic City, where he will stay two or three weeks.

The wholesale jewelers, who propose holding a banquet in this city, early next January, to which retail jewelers will probably be invited, are perfecting arrangements for this event. A meeting will be held shortly.

The following out-of-town buyers were in Pittsburg, last week, purchasing goods: Frank Worrel, Cannonsburg; J. V. Rosendahl, Irwin; A. Katzenmyer, Burgettstown; R. W. Kuhns, Youngwood; Frank Murdock, Ligonier; J. H. Hoffman, Latrobe.

The house of E. P. Roberts & Sons, Inc., last Monday opened its new store at 233 Fifth Ave. The quarters are handsomely lighted and finely decorated and furnished. The marble men are not yet through their work, and it will be several days before they finish. It will also be a week yet before the stock is finally arranged. The firm greatly increased its stock.

Wednesday last, while the "20 mule team borax" advertising wagons, which are making a tour of the country from California to New Jersey, was passing out Fifth Ave., quite a crowd collected to view the unusual sight. After the "team" left, Charles Witzel, son of A. Witzel, of Witzel & Pfaffenbach, who had been standing in front of the concern's store, missed his gold watch, fob and diamond-studded locket. The outfit is very highly prized by Mr. Witzel, as it was a token given him by the firm for his bravery in preventing the firm from being robbed of a tray of diamond rings valued at \$10,000. The watch was an open-face 14-k. engine-turned 16s case, and had the firm name stamped in the back lid. The case was number 44312. The movement, which has the firm's name and Pittsburg, Pa., on the dial and plates, is a 21-jewel, adjusted nickel, Number 1369891. The cap of the watch was engraved: "Presented to Charles Witzel by his Employers, Witzel & Pfaffenbach, Dec. 25, 1898." The fob was leather, gold trimmed; locket was square

in shape; ring on corner had engraved border with diamond in center. A liberal reward will be paid for the return of the above, especially the watch, owing to the sentiment connected with its presentation.

**Canada Notes.**

Albert S. Shadd, St. Catherine, has given a chattel mortgage for \$85 to A. Aikins.

Wm. R. Counter, Clinton, Ont., has given a renewal chattel mortgage for \$926 to C. Rumball.

Philip B. Crews, Kingston, Ont., has given a renewal chattel mortgage for \$11,554 to P. W. Ellis & Co., Ltd.

William Kaufmann, London, Eng., who has been on a trip around the world, passed through Toronto this week on his return homeward.

Ambrose Kent and Fred. Kent, of Ambrose Kent & Sons, Toronto, are enjoying a Summer vacation at Honey Bay, Parry Sound District.

C. A. Read, who was for 10 years with M. Cochenthaler, has gone into business for himself, opening a watchmaker's and jeweler's establishment at 54 St. Francois Xavier St., Montreal.

Out-of-town buyers calling on the Toronto trade last week included T. C. W. Watson, Newmarket, Ont.; George Hynds, Acton, Ont.; E. D. Wilcox, Uxbridge, Ont., and F. F. Sills, Brantford, Ont.

Joseph Dubuc, 19 years of age, of St. Hubert, Que., who was arrested a few days ago on a charge of attempting to steal a watch from the store of Theodore A. Grothe, Montreal, was sentenced to six hours in the cells, and a fine of \$10, or 15 days.

The continued considerable growth of Canadian import trade is seen in the fact that the customs revenue for the 12 months just ended amounted to \$46,204,731, an increase of \$4,669,858 as compared with the previous fiscal year. The Canadian stamp issue for the same period amounted to \$7,068,927, which is an increase of \$866,095 as compared with the previous fiscal year.

Everybody probably has heard of the cow jumping over the moon, while the dish ran away with the spoon—a robbery of silver plate with the cow acting in collusion. In the pound of Ville St. Louis, Montreal, is a cow which a few days ago dashed through the plate-glass window of Edgar Saulnier's jewelry store on Mount Royal Ave., and smashed a showcase besides kicking up a rumpus. Mr. Saulnier is now waiting for the owner of the cow, as he has a bill of damages for broken glass and jewelry.

At the annual meeting of the Toronto branch of the Canadian Manufacturers' Association, held in Toronto on the 10th inst., W. B. Tindall, the retiring chairman, in his address referred at length to the labor problem, saying that skilled help was never so difficult to procure or to retain as it is to-day. He feared the loss of the Northwest market to Canadian manufacturers unless they can get sufficient help to man their factories. Thomas Roden, of Roden Bros., was elected a member of the executive committee. W. K. George, Standard Silver Co., and W. K. McNaught, American Watch Case Co., were chosen as members of the Industrial Exhibition Committee.

# LATEST JEWELRY FOR SUMMER

CORRECT STYLES — SUPERIOR FINISH  
ARTISTIC DESIGNS

Embodied in Our

BRACELETS  
BACK COMBS  
LOCKETS

BUCKLES  
NECK CHAINS  
BROOCHES, Etc.

## DIAMONDS

Full Assortments in the Various  
Grades and Sizes

We strictly refuse to sell at retail, thus eliminating every  
element of possible competition with our customers

**D. C. PERCIVAL & CO., Inc.** 373 Washington Street  
BOSTON, MASS.

IMPORTERS OF DIAMONDS

MANUFACTURERS AND JOBBERS OF WATCHES, SILVERWARE  
CUT GLASS, ETC. COMPLETE MATERIAL DEPARTMENT

### ORNAMENTAL HAT PIN HOLDERS

A Useful and Artistic Conceit in  
SILVER DEPOSIT ON GLASS

that contributes greatly to  
the appearance of any dresser

MADE IN A VARIETY OF HIGHLY ARTISTIC DESIGNS

Splendid sellers during the vacation period

**LACKNER & OHL**

50 Columbia Street

NEWARK, N. J.



### “Perfect Yourself”

in ENGRAVING and EXPERT WATCH WORK.  
Take a Post-Graduate Course.

RIES & ARMSTRONG, Macon, Ga.

**F. JEANDHEUR, Jr.**  
Rear 17 John St., N. Y. Third Floor.

**Gold and Silver Plating**  
SPECIAL WORK AND COLORING  
IN ALL SHADES A SPECIALTY.

Established 1868.

Platina Plating.

**Flassoff Bros. & Co.**

IMPORTERS  
AND  
JOBBER'S OF

**DIAMONDS  
WATCHES  
JEWELRY**

9-11-13 MAIDEN LANE,  
NEW YORK.

100 STATE STREET,  
ALBANY, N. Y.



A LARGE ASSORTMENT OF DIAMOND  
MOUNTED JEWELRY CARRIED IN STOCK.

IF you have any stones in the rough—except diamonds—to be  
cut, our new cutting works will enable us to fulfill your every  
wish. All work guaranteed. Best results attained. Try us.

## PASSMORE GEM COMPANY,

LAPIDARIES, PRECIOUS STONES, ODD GEMS.

373 Washington Street,

Boston, Massachusetts.



## North Attleboro.

Charles Blackwell is the new foreman of Straker & Freeman.

J. F. Sturdy's Sons Co., J. J. Sommer & Co., and the George L. Paine Co., are working 13 hours a day.

Alton H. Riley, George W. Cheever, Alvin Chisholm and Andrew E. Morris have opened cottages for the Summer at Cottage City.

Tred Paye has now recovered sufficiently from his operation for appendicitis as to be able to attend to his duties at the factory of the Paye & Baker Mfg. Co.

John MacMillan on Friday resigned as southern salesman for C. Ray Randall & Co., and will conclude his services the latter part of this month. Walter Duncan will be his successor.

Among the salesmen to arrive in town during the past week were: K. L. Taylor, of Riley & French; Fred Carpenter and Louis Blackinton, of the W. & S. Blackinton Co.; Fred Cook, of Whiting & Davis, John MacMillan, of C. Ray Randall & Co.

It was announced, last week, that Riley & French were to build an addition, 42 by 28, to their Broad St. factory. At present the addition will be but one story, but it will be arranged so as to be extended up four floors later. The addition, which will have 1,200 square feet of floor space, will be utilized by C. Ray Randall & Co.

## Lancaster, Pa.

Harry Kiehl, of Louis Weber & Son, visited New York last week.

Frederick A. Wheeler, of the Non-Retailing Co., is home from the west.

George R. Hepp and family, of Lilitz, spent last week at Mt. Gretna, Pa.

Henry B. Cohn and bride, Philadelphia, have been the guests of Marcus Einstem, brother-in-law of Mr. Cohn.

W. W. Appel, who must vacate his store-room in the Wheatland Hotel by Aug. 1, is reducing his stock in order to remove to smaller temporary quarters.

S. Kurtz Zook was among the members of the Lancaster Board of Trade who were entertained Friday afternoon by William Martin at his country home near Lancaster, "The Hedges."

Among the jewelers visiting Lancaster last week were J. H. Sensenig, New Holland; S. H. Miller, Mt. Joy; C. E. Hiakle, Ephrata, and H. L. Oberlin, of H. S. Oberlin & Bro., Columbia.

Arthur P. Markley, a St. Louis jeweler who was taken ill on the train while en route to New York, and had to be removed to a Lancaster hospital, has so far recovered that he was able to leave for home on Saturday.

E. F. Miscally, of James Allan & Co., Charleston, S. C., came here last week to place his son Philip in the Ezra F. Bowman Technical School to learn watchmaking. Charles M. Bowman visited Penmar, Ind., last week.

Considerable attention was attracted last week to an exquisite necklace of 47 fine diamonds which was on exhibition in a show window of S. Kurtz Zook's establish-

ment, where it was made. It was of novel design, with cluster drop.

## Boston.

E. A. Cowan arrived home from Europe this week.

F. B. Chace has returned from a business trip through northern New England.

David Nonsner, salesman for E. A. Cowan, is on an outing at West Foxboro.

Walter B. Snow, of this city, has taken an interest with the Littlefield Silver Co., New Bedford.

Eugene O'Connor has been engaged by Harwood Bros. as inside salesman in their optical goods department.

M. B. Joseph, Chicago resident representative of Wilpelt & Saacke, has been in Boston during the week.

Reginald W. P. Brown, of the Nelson H. Brown clock house, is at Littleton, N. H., on his mid-summer outing.

Harry Orkin, formerly with B. J. Orkin, of this city, has started in business on his own account in Chelsea, Mass.

Edmund T. Glover, manager for Bigelow, Kennard & Co., returns this week from a fortnight's outing at Manomet, Mass.

Pierce Parker, for the past nine years in the material department at Henry Cowan's, has taken a similar position with Charles May & Son.

A. W. Armington, diamond buyer for Shreve, Crump & Low Co., has just returned from a trip to the principal diamond centers of Europe.

Affairs of the firm of Mackenzie & Allen have been settled by Mrs. Allen's retention of her late husband's interest in the business, which will continue under the same firm name as heretofore.

Charles H. Crump, of Shreve, Crump & Low Co., who had intended to remain abroad until October, has shortened his European tour considerably, and will sail for home on Aug. 3.

Buyers in town during the week included: E. Beaudrean, Marlboro; M. F. Wood and J. A. Filion, Lowell; Thomas Margetts, Hingham; Joseph Lajoie, Worcester; E. S. Eastman, Swampscott; A. J. Laliberte, Derry, N. H.

Elmer E. Knight, head salesman for A. S. Hirshberg, goes to Maine on a recreation trip this week, driving his blue-ribbon team from his home in Reading, Mass., to Berwick, and planning for a number of interesting carriage drives during his outing.

Albert Schaub, Detroit, Mich., who was the guest of Henry Cowan when in Boston last week, was the winner in a party of 16 who enjoyed a harbor fishing trip and dinner. Mr. Schaub caught an 11-pound cod and the \$5 pool went to him as a prize.

John Addison, of the Charlestown district, who is one of the heavyweights of the Boston jewelry trade, tipping the scales close to 240 pounds, has a country home at Wilmington, Mass., where he recently accomplished the feat of raking, loading and stowing six tons of hay in a day.

Exhibited in the store of H. Jackson, Williamsport, Pa., are a number of swords found in Libby Prison, several old American coins, old-fashioned spoons and other interesting relics. Curios are constantly being added to the collection.

## Attleboro.

### TRADE CONDITIONS.

A tour of the jewelry factories the past week brought to light an amazing rush for early July, help scarce in comparison with the demand, and the manufacturers constantly under mail and telegraphic pressure from all over the country to "hurry" this, that or the other order. Dealers in chemicals and supplies report an increase of 40 per cent. over this time last year, and one concern dealing in belting reports an increase of 65 per cent. Pasteboard box makers say they never were so driven.

E. S. Cobb, salesman for R. B. Macdonald & Co., is in New York State on a business trip.

Frank C. Miller, formerly of Leach & Miller, this town, now of Providence, married, last week, Miss Harriet C. Luther, of North Attleboro.

Fred M. Ellis, who recently took charge of the New York office of the S. & B. Lederer Co., Providence, has removed his home to the latter city.

The employes of the Watson & Newell Co. enjoyed, Saturday, their annual outing at Boyden Heights, R. I. The employes of the Torrey Jewelry Co. had, last week, their annual excursion, going to Lake Winnemacnet, Norton, Mass.

The Reed & Barton factory force, Taunton, have resumed work in every department after a shut-down for stock taking and repairs. The activity is unusual for this time of year. Three new buildings, allowing an extension in several departments, are in process of construction.

A semi-annual dividend of 2 per cent. for the six months ending July 1 has been declared by the R. F. Simmons Co. to its employes. It is the ninth semi-annual dividend for the employes. A total of \$1,880.15 will be distributed as compared with \$1,350 of a year ago. This is the largest distribution to the employes that the company has made in any July since it commenced the profit sharing scheme.

Hon. Sidney O. Bigney, of S. O. Bigney & Co., last week went to Detroit to address the Michigan Retail Jewelers' Association. The desire of his political associates to see him run for Congress dies hard, in spite of his repeated assurances that he intends to attend strictly to his jewelry business. Just before leaving for Detroit he was approached on the subject again, and his departing words were a reassurance that he is not in the field.

Albert S. Ingraham, of A. S. Ingraham & Co., with his family, has been visiting at Touisset, R. I. Charles H. Tappan, of the D. F. Briggs Co., with Mrs. Tappan, has gone to Maine to spend the period of hot weather. Captain George H. Sykes, of Sykes & Strandberg, has made Shawomet Beach his Summer home. Jesse Carpenter, of the traveling force of the Horton, Angell Co., has gone to Nantucket. George Simmons, of J. M. Fisher & Co., has installed himself and family at Silver Beach, Mass. Charles H. Allen, of C. H. Allen & Co., has gone to Niagara Falls. Fred A. Newell, formerly of the Watson & Newell Co., has opened his Summer home at Drownville, R. I. George Poole, of the Poole Silver Co., Taunton, is visiting relatives at Prince Edward Island.

J. C. Vines, Bessemer, Ala., has moved to larger quarters on Third Ave.

# JOS. NOTERMAN & CO. DIAMONDS

IMPORTERS AND CUTTERS

Recutting and Repairing odd shaped and chipped stones a specialty. Manufacturers of Mountings and Fine Jewelry. Special Designs Furnished.

CINCINNATI, OHIO.

## MOST COMPACT AND THINNEST DUST-PROOF OPEN FACE GOLD CASE

MADE IN THE WORLD FOR AMERICAN MOVEMENTS.

Made in all shapes, engine turned, engraved or plain.



Colby Patent, April 24, 1894.

## DUBOIS WATCH CASE CO.

21 Maiden Lane, New York.

**JAS. C. HOE'S SONS**  
 10 Liberty Place  
 Near Maiden Lane  
 NEW YORK

Manufacturers of High Grade Wall Show Cases and Jewelers' Fixtures

INTERIOR REFITTING of STORES and OFFICES A SPECIALTY

Write for Estimates  
 Finest references given if desired

Established 1820

**JACOB BASCHKOFF,**  
 DIAMONDSETTER,  
 LETTER AND MONOGRAM  
 ENGRAVER,  
 9-13 MAIDEN LANE,  
 NEW YORK.

Room 701  
 Jewelers' Bldg.

## Learn Watchmaking

Refined, profitable labor. Competent men always in demand. We teach it thoroughly in as many months as it formerly took years. Does away with tedious apprenticeship. Money earned while studying. Positions secured. Easy terms. Send for catalogue. Address

St. Louis Watchmaking School, St. Louis, Mo.

## The REX Cuff Button



**THE MISSING LINK**

ONE PIECE NO LEVER NO SNAP NO SPRING

Just A Cuff Button That Cannot Break

Shipped in individual cartons holding 1 doz. pairs. Ask your jobber for them; if he does not supply you, write us. Sample pair furnished jobbers on request.

## E. E. STANINGER

Sole Manufacturer

Hartford Bldg.

CHICAGO, ILL.

## LEARN JEWELERS ENGRAVING

**"The Engraving School that Graduates Experts."**  
 A fascinating, high-salaried and easily learned trade, taught thoroughly and practically by correspondence. Your instructor is the foremost authority and master workman in the world. We will teach the beginner better engraving by correspondence than he can gain in years of rigid apprenticeship. We will improve the skill of any engraver one hundred per cent. and make him master of the trade. The demand for competent engravers far exceeds the supply. Send for handsome, illustrated prospectus.  
**PAGE-DAVIS COMPANY,**  
 Suite 10, 90 Wabash Avenue, CHICAGO.



## A New Eyeglass Holder Prevents Loss of Glasses from Hook

PRACTICAL—SIMPLE—SAFE—SECURE

A new and novel idea which has overcome the possibility of loss once glasses are entrusted to it. Glasses attached to this hook can only be removed at will of wearer and in the simplest manner. The feature of this hook is a "HUMP" engaged by a "LOOP" making a secure connection.

PAUL GOUGELMAN, Manufacturer, 37-39 Maiden Lane, New York.



# Rockford Watches Speak for Themselves.

"Practical Course in Adjusting."

PRICE \$2.50.

ALL JOBBERS OR JEWELERS' CIRCULAR PUBLISHING CO.

### Recent Decisions by General Appraisers as to Jewelry, Precious Stones and Kindred Lines.

The Board of United States General Appraisers, recently rendered the following decisions in cases involving questions as to the customs duties on precious stones, jewelry and kindred lines:

**ORNAMENTS—PASTE BUTTONS—PINS.**—Protests of A. & H. Veith against the assessment of duty by the Collector at New York. G. A. 6,376 (T. D. 27,390), G. A. 6,130 (T. D. 26,653), G. A. 6,279 (T. D. 27,061), and *United States v. Garrison* (127 Fed. Rep., 1,022; T. D. 25,072) followed, relating to ornaments, paste buttons and pins.

**ORNAMENTS—TOY JEWELRY—CHAINS—PINS—CHAIN HOLDER—PASTE BUTTONS—STRUNG BEADS—BEADED ARTICLES—CHATELAIN BAGS—BON-BON BOXES.**—Protests of Samstag & Hilder Bros. against the assessment of duty by the Collector at New York. The decision related to 22 varieties of merchandise. The Board disposed of the questions raised on the authority of the following decisions: G. A. 6,374 (T. D. 27,382), G. A. 6,130 (T. D. 26,653), *Steinhardt v. United States* (113 Fed. Rep., 996), Abstract 5,635 (T. D. 26,248), G. A. 6,576 (T. D. 27,390), *Strauss v. United States* (T. D. 26,903), *Tiffany v. United States* (131 Fed. Rep., 398; T. D. 25,316), G. A. 6,330 (T. D. 27,255), and *United States v. Clark & Kaufman* (T. D. 27,093) relating to ornaments, toy jewelry, chains, pins, chain holder, paste buttons, strung beads, beaded articles, chatelaine bags and bon-bon boxes.

**ORNAMENTS—PINS—CHAINS—CHATELAIN BAGS—STRUNG BEADS.**—Protests of Abegg & Rusch against the assessment of duty by the Collector at New York. G. A. 6,374 (T. D. 27,382), G. A. 6,376 (T. D. 27,390), and *Tiffany v. United States* (131 Fed. Rep., 398; T. D. 25,316) followed, relating to ornaments, pins, chains, chatelaine bags and strung beads.

**PINS—ORNAMENTS—MANUFACTURERS OF METAL.**—Protests of Cohn & Rosenberger against the assessment of duty by the Collector at New York. The merchandise consisted of pins, ornaments, goods composed chiefly of metal and other articles. As claimed by the importers, they were held dutiable as manufactures of the component material of chief value.

**BRASS SNAPS.**—Protests of A. F. Fellheimer *et al.* against the assessment of duty by the Collector at New York. G. A. (T. D. 27,255) followed, relating to brass snaps.

**BRASS SNAPS—UNFINISHED JEWELRY.**—Protests of Manhattan Chain Co. *et al.* against the assessment of duty by the Collector at New York. The merchandise consisted of (1) snaps or swivel clasps of brass not plated nor washed with precious metals and (2) of necklet snaps and slides set with imitation precious stones and designed for use in the manufacture of cheap jewelry. The merchandise in the first class was held dutiable as manufactures of metal, as claimed by the importers. G. A. 6,330 (T. D. 27,255) followed. The merchandise comprised in the second class was held to have been properly classified under Par. 434, tariff act of 1897, relating to unfinished jewelry.

**RHINESTONE BUTTONS.**—Protest of Rothschild Bros. & Co. against the assessment of duty by the Collector at New York. G. A. 6,279 (T. D. 27,061) followed, relating to rhinestone buttons.

**RECONSTRUCTED RUBIES—IMITATION PEARLS.**—Protests of J. F. Allen against the assessment of duty by the Collector at New York. Protests sustained on the authority of G. A. 6,336 (T. D. 27,278) and G. A. 6,088 (T. D. 26,554), relating to reconstructed rubies and imitation pearls.

**RECONSTRUCTED RUBIES—IMITATION PEARLS—PEARLS—PRECIOUS STONES.**—Protests of Benedict & Warner *et al.* against the assessment of duty by the Collector at New York. G. A. 6,336 (T. D. 27,278), G. A. 6,088 (T. D. 26,554), G. A. 5,914 (T. D. 26,013), and G. A. 6,097 (T. D. 26,586) followed, relating to reconstructed rubies, imitation pearls, pearls and precious stones.

**PRECIOUS STONES—IMITATION PEARLS—RECONSTRUCTED RUBIES.**—Protest of Overton & Co. against the assessment of duty by the Collector at New York. G. A. 6,097 (T. D. 26,586), G. A. 6,336 (T. D. 27,278), and G. A. 6,088 (T. D. 26,554) followed, relating to precious stones, imitation pearls and reconstructed rubies.

**PIERCED IMITATION PEARLS.**—Protests of Cohn & Rosenberger against the assessment of duty by the Collector at New York. G. A. 6,088 (T. D. 26,554) followed, relating to pierced imitation pearls.

**BEADS.**—Protest of S. A. Frost's Son against the assessment of duty by the Collector at New York. The merchandise was held to have been properly classified as beads under Par. 408, tariff act of 1897.

**JEWELRY—WOODEN NECKLACES—CHATELAIN BAGS.**—Protests of Samstag & Hilder Bros. against the assessment of duty by the Collector at New York. The merchandise was classified as jewelry under Par. 434, tariff act of 1897, and was claimed dutiable as manufactures of the component material of chief value. This contention was sustained as to chatelaine bags on the authority of *Tiffany v. United States* (131 Fed. Rep., 398; T. D. 25,316), and it was overruled as to so-called necklets and wooden necklaces, which the Board held to be dutiable at the same rate as assessed under the provision in Par. 408 for beaded articles.

**INCUSTED STONES.**—Protests of Nordlinger & Mamluck against the assessment of duty by the Collector at Providence. Protests sustained on the authority of G. A. 6,342 (T. D. 27,292), relating to incusted stones.

**PRECIOUS STONES.**—Protest of Carl Blatt against the assessment of duty by the Surveyor at St. Louis. As claimed by the importer, the merchandise, which was invoiced as "Bohnische Runde, Fassgranat Rosen," was held dutiable as precious stones cut but not set, under Par. 435, tariff act of 1897.

**RECONSTRUCTED RUBIES—IMITATION PEARLS—PRECIOUS STONES.**—Protests of John F. Allen against the assessment of duty by the Collector at Providence. G. A. 6,336 (T. D. 27,278), G. A. 6,088 (T. D. 26,554), and G. A. 6,097 (T. D. 26,586) followed, relating to reconstructed rubies, imitation pearls and precious stones.

**PINS.**—Protests of Dieckerhoff, Raffloer & Co. against the assessment of duty by the Collector at New York. G. A. 6,139 (T. D.

26,679) followed, relating to pins. A similar decision was rendered on the protest of Jas. G. Johnson & Co.

**TOY JEWELRY—MANUFACTURES OF METAL.**—Protests of A. Strauss & Co. *et al.* against the assessment of duty by the Collector at New York. G. A. 6,297 (T. D. 27,156), G. A. 6,374 (T. D. 27,382), G. A. 5,617 (T. D. 25,213), and Abstract 10,016 (T. D. 27,114) followed, relating to toy jewelry and manufactures of metal.

**ORNAMENTS—BEADS—CHAINS—TOY JEWELRY—CHATELAIN BAGS—BEADED ARTICLES—UNFINISHED JEWELRY.**—Protests of A. Steinhardt & Bro. against the assessment of duty by the Collector at New York. G. A. 6,374 (T. D. 27,382), G. A. 6,130 (T. D. 26,653), *Steinhardt v. United States* (113 Fed. Rep., 996), Abstract 5,635 (T. D. 26,248), G. A. 6,376 (T. D. 27,390), *Strauss v. United States* (T. D. 26,903), *Tiffany v. United States* (131 Fed. Rep., 398; T. D. 25,316), G. A. 6,330 (T. D. 27,255), and *United States v. Clark & Kaufman* (T. D. 27,093) followed, relating to ornaments, beads, chains, toy jewelry, chatelaine bags, beaded articles and unfinished jewelry.

**ROCK-CRYSTAL BALLS.**—Protest of R. C. Hahn & Co. against the assessment of duty by the Collector at New York. Protest overruled on the authority of G. A. 6,301 (T. D. 27,160), relating to rock-crystal balls.

**GOLDSTONES.**—Protest of Rud. C. Hahn & Co. against the assessment of duty by the Collector at New York. Protest overruled on the authority of G. A. 6,089 (T. D. 26,555), relating to goldstones.

**IMITATION ROCK-CRYSTAL INTAGLIOS.**—Protest of Nordlinger & Mamluck against the assessment of duty by the Collector at New York. G. A. 6,367 (T. D. 27,346) followed, relating to imitation rock-crystal intaglios.

**FANS.**—Protest of Oberle & Henry against the assessment of duty by the Collector at New Orleans. Protest sustained on the authority of *Downing v. United States* (141 Fed. Rep., 490; T. D. 26,454), relating to fans.

**RECONSTRUCTED RUBIES.**—Protests of Rooney & Spence *et al.* against the assessment of duty by the Collector at New York. Protests sustained on the authority of G. A. 6,336 (T. D. 27,278), relating to reconstructed rubies. Similar decisions were rendered on the protests of Albert Lorsch & Co.; I. Gunzburger, R. H. Macy & Co., C. E. Sherwood and Joseph E. Judels.

**ORNAMENTS—JEWELRY.**—Protests of Abraham & Straus against the assessment of duty by the Collector at New York. G. A. 6,374 (T. D. 27,382) followed, relating to ornaments which were held to have been improperly classified as jewelry under Par. 434, tariff act of 1897. Similar decisions have been rendered on the protests of Abraham & Straus, A. Steinhardt & Bro.; A. H. Veith, Jules & Hugo Rosenberg and B. Blumenthal & Co.

Burglars recently entered the store of W. Herick, Glenfield, N. Y., and stole watches, rings, etc., valued at about \$500. Entrance was gained by removing the putty from a rear window and breaking out half of the window pane. The thieves are believed to have been professionals. None of the watches which had been left at the store to be repaired was taken.

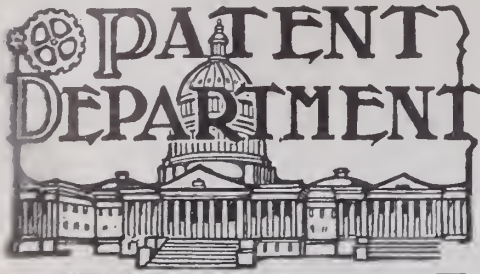

IN WHICH IS CONTAINED A LIST OF THE LATEST PATENTS GRANTED BY THE UNITED STATES AND GREAT BRITAIN, THE UNITED STATES PATENTS THAT HAVE EXPIRED AND THE REGISTERED TRADE-MARKS.

UNITED STATES PATENTS.

ISSUE OF JULY 3, 1906.

824,790. FOUNTAIN-PEN. STEWART W. JAMESON, Kansas City, Mo. Filed Oct. 4, 1905. Serial No. 281,356.

A fountain drawing-pen, comprising a font, a threaded plug portion fitted within the same, and having a projection at one end which is provided with an elongated opening, blades pivotally



mounted upon said plug portion, and a threaded shell fitted over said plug and adapted to frictionally engage the outer edges of said blades.

824,832. TEMPLE-WIRE FOR SPECTACLE FRAMES AND MOUNTINGS. LOUIS J. TELLER, Providence, R. I., assignor to Charles A. Wilkinson, Warwick, R. I., and Dutee Wilcox, Providence, R. I., trading as C. A. Wilkinson & Co. Filed Dec. 22, 1905. Serial No. 292,977.

The improved temple-wire herein described having the cylindrical stem portion A and the integral

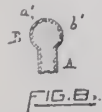

ball or tip B on one end thereof, all made of a compound stock consisting of a gold plate soldered on base metal, which temple-wire is so constructed that its exterior portion consists of said gold plate and the interior portion consists of said base metal.

824,715. BELT HOLDER. HENRY SALISBURY, Brooklyn, N. Y. Filed Aug. 8, 1905. Serial No. 273,273.

The combination with a garment, of a belt loop therefor comprising a strip having tongues at its ends engaged through the garment, the end por-

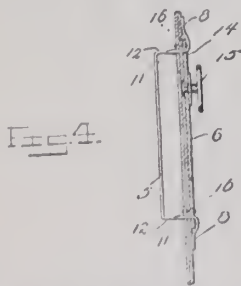

tion of the strip being bent to bring the central portion thereof into spaced relation to the garment for the passage of a belt between the loop and the garment, an attaching plate engaged with the tongues at the opposite side of the garment from the loop, said attaching plate having perforations in which the tongues are received and a suspender receiving device carried by the inner

face of the attaching-plate, said tongues being bent to extend away from each other over the inner surface of the attaching-plate.

825,153. PEN FOR FOUNTAIN-PENS. VICTOR L. OCHOA, Roseville, N. J., assignor of one-half to Benjamin A. Jackson, New York. Filed Sept. 23, 1905. Serial No. 279,777.

A pen having a longitudinal depression or groove in its upper surface extending from a slit to the

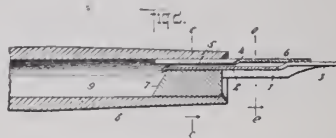

heel, in combination with a top piece having a grooved portion and an ungrooved portion forward of said grooved portion, a ridge at the under side of the grooved portion, said ridge entering the groove in the pen-body.

824,773. EARPIECE. EDWARD L. AIKEN, East Orange, N. J., assignor to the New Jersey Patent Co., West Orange, N. J. Filed June 12, 1905. Serial No. 264,754.

As a new article of manufacture, an ear-piece

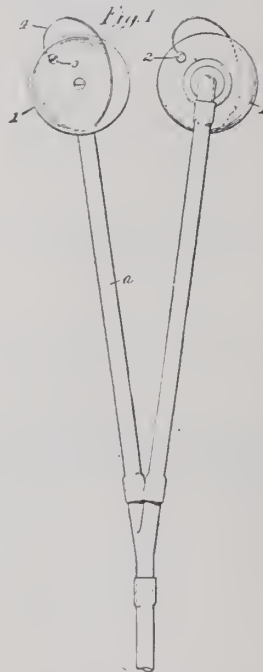

comprising a cup or disk having a central aperture, a tube in said aperture and a wire pinning said tube to said cup and curved to fit over the ear.

825,184. KEY-HOLDER. EDWARD J. BRANDT, Watertown, Wis., assignor to the Brandt Cashier Co., Chicago. Filed April 8, 1904. Serial No. 202,205.

In a key-holder, the combination with a plate having a minor portion of its periphery cut away, of a spring-tongue fast with said plate at one end



and overlying said cut-away portion of the plate to form an inclosed space, the free end of said tongue overlapping the plate at one end of said cut-away portion.

825,190. COMBINED SHOPPING BAG AND

SKIRT-HOLDER. GIROLAMO COMI Cobalt, Conn. Filed March 13, 1906. Serial No. 305,785.

The combination with a shopping-bag and means for supporting the same from the belt of the

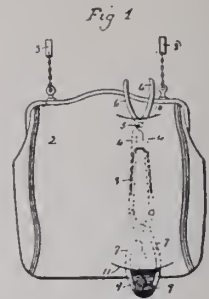

wearer, of a pair of levers pivoted to one side of said bag, said levers formed at their upper ends with operating-handles and connected at their lower ends with gripping-jaws.

825,212. NAIL-FILE. AUGUST HENKEL, Newark, N. J. Filed March 7, 1905. Renewed May 26, 1906. Serial No. 318,953.

A device of the class described, comprising a handle having a rigid back and a foldable blade, one of said parts being provided with an inclined

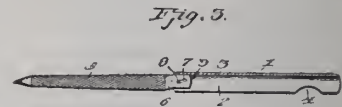

slot having a continuous marginal wall and the other a fixed pin entered through said slot for permanently attaching the blade slidably and pivotally to the handle, said slot serving through movements of the pin therein to positively move the blade transversely into and out of contact with the back of the handle.

DESIGNS.

38,111. RING. CHARLES H. PFEIL, Chicago.

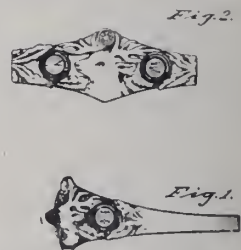

Filed March 26, 1906. Serial No. 308,181. Term of patent 14 years. The ornamental design for a ring as shown.

UNITED STATES PATENTS THAT HAVE EXPIRED.

[Reported especially for THE JEWELERS' CIRCULAR-WEEKLY by R. W. Bishop, Patent Attorney, Washington, D. C.]

Issued July 9, 1889.

- 106,435. CUFF-HOLDER. J. C. EMERSON, Waterbury Centre, Vt.
  - 106,513. WATCH. G. F. JOHNSON, Aurora, Ill.
  - 106,655. APPARATUS FOR TESTING WATCH BALANCES AND HAIR SPRINGS. JOHN LOGAN, Waltham, Mass.
  - 106,702. WATCH-WINDING MECHANISM. W. N. CLIFFORD, Waltham, Mass.
  - 106,735. FORK. D. J. HUCKINS, East Boston, Mass., assignor of one-half to F. D. Brevogle, same place.
  - 106,769. SIGNAL TRANSMITTER AND TIME INDICATOR. A. J. REAMS, El Dorado, Kans.
  - 106,816. WATCH CASE. E. C. CHAPPELLE, Philadelphia, Pa.
  - 106,811. CUP FOR MARMALADE PACKAGES. LAZARUS KOHNS, New York.
- Designs issued July 5, 1892, for 14 years.
- 21,680. STATUETTE. CELIA M. SMITH, New York.
  - 21,682, 21,683, 21,684 and 21,685. PLATES.

- C. E. HAVILAND, Limoges, France.  
**21,686.** CUP. C. E. HAVILAND, Limoges, France.  
**21,687.** COVER-DISK. C. E. HAVILAND, Limoges, France.  
**21,688.** BADGE. J. K. DAVISON, Philadelphia, Pa.  
**21,693.** KNIFE-HANDLE. F. J. KALDENBERG, New York.  
*Design issued July 11, 1899, for 7 years.*  
**31,171.** PENCIL-CASE. FRANK MCINTYRE, New York, assignor to the Eagle Pencil Co., same place.

**BRITISH PATENTS.**

(ABRIDGMENTS OF SPECIFICATIONS, 1905, FROM THE Illustrated Official Journal.)

ISSUE OF JUNE 27, 1906.

- 3,903.** TELESCOPES. W. OTTWAY, Ealing, London, W. Feb. 27.  
 Relates to a method of lighting-up the cross-wires in a sighting-telescope. The body of the telescope is fitted with a lateral and inclined tube *d m* which is an electric lamp, or other suitable source of light, the rays from which are concentrated by a lens *l* upon an aperture *n*. The rays passing through the aperture *n* are converged by a lens *m*, Fig. 4, so as to illuminate the center of the cross-wires only.

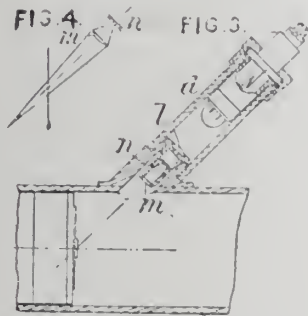

**3,998.** MAGIC-LANTERNS. W. H. EVERSON, Westminster, Feb. 25.  
 To produce stereoscopic effects in pictures projected on a screen from optical lanterns, a shutter is arranged to project alternately a pair of pictures in stereoscopic relation and to give between successive projections a period of total obscuration equal in time to that of a single projection. In the arrangement shown in Fig. 1, a revolving disk *D* provided with suitably spaced apertures is

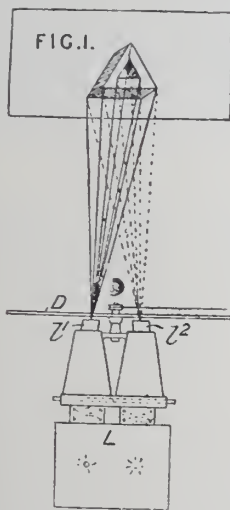

mounted in front of the lenses *P*, *P*<sup>2</sup> of a lantern *L*. Instead of a disk, moving endless bands provided with similarly spaced apertures may be employed; or disk or band shutters revolving in opposite directions may be used. The provisional specification states that a wheel, fan, shade, stop, drum, or cylinder may be used instead of the disks or bands, and that these may be applied to a double lantern or to two lanterns, or the light of the lantern may be "put out" and exposed alternately.

- 1,063.** TELESCOPES. W. OTTWAY, Ealing, London, W. Feb. 27.

Relates to panoramic eye-pieces for sighting telescopes, with illuminated cross-wires, such as are described in Specification No. 3903, A.D. 1905, in which the variation of the magnifying-power is obtained, without disturbance of the focus, by simultaneous and differential longitudinal move-



ments of the two lenses forming the erecting-system, and in which the focal plane of the object-glass is outside the eye-piece. To the rotatable sleeve *g* is fixed a tube *c* in which grooves *d, e* are formed. Within the tube *c*, which is enclosed by a longitudinally-slotted tube *m*, the sleeve *h*, carrying the erecting-lens *i*, is adapted to slide. Feathers *k, k*<sup>2</sup> on the sleeve *h* engage with the slots *l, e* respectively, while a feather *n* on the tube *m* engages with the slot *d*. As the sleeve *g* is rotated therefore, and with it the tube *c*, the lenses *k f* are traversed along the axis to adjust the magnifying-power without disturbing the focus. The eye-lens of the eye-piece is adjusted independently by a pin-and-slot action, similar to that described in Specification No. 9411, A.D. 1899. Reference is also made to Specification No. 17,843, A.D. 1897.

- 1,202.** TELESCOPES. G. N. SÆGMULLER, Washington, D. C., U. S. Feb. 28.

Fig. 1 shows a section of a telescope fitted with an eye-piece *m* in which the cross-wires *G* are mounted between two thick lenses *E* and are illu-



minated laterally through an opening *H*. The edges of the lenses *E* are silvered to throw light on to the cross-wires from all sides. The usual eye-lens is replaced by two achromatic lenses *F*. The necessary construction data for the lenses *F*, *E*, are given in the specification.

- 1,269.** BROOCHES. E. MURREL, London, March 1.

Brooches designed to support watches are

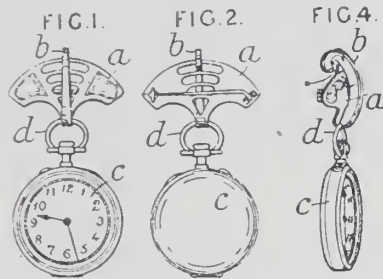

formed with spring hooks *b*, carried round to the back of the body *a* of the brooch and adapted to receive and hold securely the bow *d* of a watch *c*.

Complete specifications accepted June 20, 1906. 1905.

- 12,340.** VEIL RETAINER. FLETCHER.  
**12,604.** CLOCK. WETZEL.  
**16,125.** FIELD-GLASSES. BARTON.  
**21,377.** POCKET-KNIFE. MANDEWIRTH. 1906.

- 696.** UMBRELLA. MCGUIRE.

- 3,387.** MATCH BOX. REYNOLDS.

Applications filed June 11 to June 16, 1906.

- 13,527.** UMBRELLA-FRAME. RICHARD FAWCETT and W. L. HOLLAND, Manchester.

- 13,715.** MATCH BOX. GEORGE ARKINSTALL, Birmingham.

- 13,781.** HAIR-PIN. ANTON THISSEN, Flinsbury, London.

**ELSIE BEE'S FASHIONS.**

NOVELTIES SEEN IN A LADY'S RAMBLES AMONG THE JEWELERS.

FASCINATING little gold mesh purses just the size required for car fares are a very useful trinket to find place in the shopping bag.

Turquoise matrix is seen as the center for little pins, brooches or ornaments in conjunction with open work in diamonds.

Very beautiful is an extremely long string of round matched pearls which is finished with a clasp formed of four large diamonds.

One of the oddest brooches seen for some time is an oblong half-round turquoise set entirely free, with the exception of four diamonds, a single stone being at either end and at the top and bottom.

Of artistic character and essentially refined in expression is an exquisite ornament embodying an extremely large pear-shaped Oriental pearl as an important center for the surrounding fancy scrolls in diamond work, which form a most effective alliance.

A diamond collarette representative of one open style consists of a serpentine vine with each curve containing a single cluster of conventional leaves that fills but little of the space, effecting a darily severe conclusion. A row of diamonds at the top and bottom form the edges of the design.

Exquisitely manipulated in diamond work are some new designs that strike a distinctly original note in close effects. A subtle *cachet*, arrived at by means known to the elect, distinguishes this most delicate style. A notable example is shown in a pendant in which the central stone is a marquise shape framed in small diamonds and set in a figure which might well have been copied from some beautiful fine lacc.

A word or two about new designs in very thin, large watches. Delightfully novel are the cases, beautifully enameled in some fine conventional pattern, almost or entirely filling the space, in which two, three or more colors are employed. A unique feature consists of delicate enameled chains, in the new flat style, which are attached. These short chains are formed of very narrow, thin, enameled shapes with round or pointed ends connected by pegs or gold links and matching the case, as in the style of some small watches recently noted.

A necklace that is wholly individually and eminently stylish shows a very narrow, close, lace-like diamond band set with three diamond clusters spaced across the front. To each cluster is attached a single large diamond topping an ablong drop-stone. Two choice opals about an inch in length, with a somewhat longer one in the middle, the shapes being narrow at the top and closely attached to the diamonds from which they swing, complete this elegant new design.

ELSIE BEE.

# Mainspring Don'ts

## Simple Hints for Those Who Handle Mainsprings

---

Don't fail to provide yourself with the best mainspring winder that can be obtained. See that the hooks on all arbors of the winders are no longer than the thickness of the thinnest spring, and thus avoid kinking, and therefore unnecessary breaking of mainsprings.

Don't use a mainspring that is too long, because it fills the barrel and prevents that part, or the mainwheel, from making the required number of revolutions, with the consequence that the watch will not run as it should after each winding.

Don't use a mainspring that is too strong, because it will set, increase the percentage of breakage and injure the watch.

Don't use a mainspring that is too wide, and be sure that the tip and brace do not extend beyond the limits of the cover and barrel.

Don't forget that a mainspring should not occupy more than one-third the diameter of the barrel, thus leaving two-thirds to be divided between the arbor and winding space, to enable the watch to run about thirty-six hours.

Don't expect a mainspring to be flat if you put it in the barrel with the fingers. This method usually injures the spring, gives it a cylindrical form, and thereby increases the friction in the barrel.

Don't bend the inner or outer end of the mainspring with flat-nosed pliers, but provide yourself with specially made round-nosed pliers which will give a circular form to these parts, prevent short bends, contract the inner coil, and thus secure a closer fit to the barrel arbor without injuring the spring.

Don't expect other than a properly fitted flat mainspring with rounded edges to produce the least friction in the barrel, allow the greatest amount of power to the train, and give the best results as to time, service, etc.

Don't expect a mainspring to always endure extreme changes in temperature, or electrical disturbances, or straightening at full length, or neglect from lack of cleaning and oiling.

Don't expect a watch that needs cleaning or other repairs to run satisfactorily by merely putting in a new mainspring.

Don't expect a mainspring to plough through too much dirt.

---

## Waltham Watch Company

Waltham, Mass.

# THE HOROLOGICAL REVIEW.



## Watch Repairing.

By H. REINECKE.

(Continued from issue of June 6.)

A MOST convenient tool as a supplement to the turns described in the issue of June 6 is the Jacot tool, which is used for finishing pivots after they have been turned to the proper size and shape in the turns. It is also used by watch repairers for re-polishing pivots which have been injured by wear. While one pivot is centered on a fixture with a female centre corresponding in line with the rut or groove, where the damaged pivot is to be repaired, a suitable burnishing file does the work while the pivot is rotated by bow and pulley, or

the pivots only, the other for reducing their length and rounding up their ends. The end used for the first operation generally has nine facets on it, each having a compound groove in the center. The grooves intended for the final burnishing of the pivots are carefully graduated in size, their total number comprising the usual run of watch pivots. To use, first select one of the grooves sufficiently large and place it uppermost; then put the pinion or staff to be operated on against the female center, with the pivot to be finished lying in the groove of the opposite center, this being adjusted until it very nearly touches the shoulder; then lay the pivoting file on the pivot to keep in the groove, and with the

eter of the center, close against its end, forming a rest for the edge of the file.

In the hands of an experienced pivoter this guard piece has, no doubt, prevented many breakages, and he may dispense with the use of it except in special cases. The reverse end of the described one is generally protected by a brass cap, as it carries a very thin disc pierced on its edge with

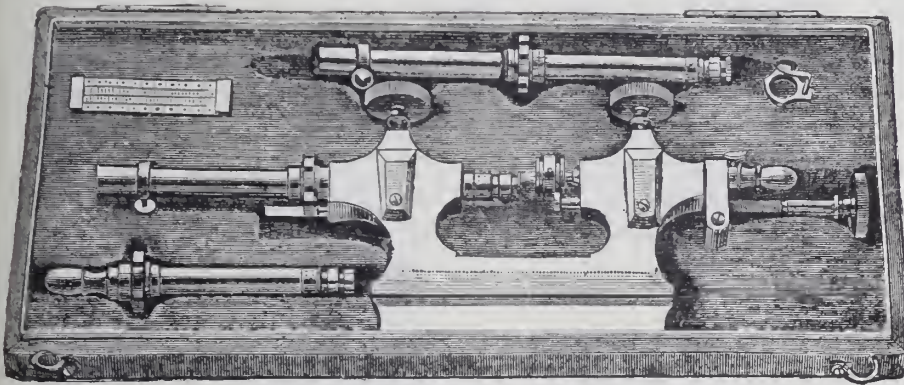

FIG. 1.

by a pulley fitted with a carrier as shown in the illustration, which represents the tool with all its accessories.

For finishing pivots on a new pinion or balance staff some watchmakers use only the turns, and finish them with the graver, finally using red stuff to polish them with. In the Jacot tool, however, it is usual to use a pivoting file, which has a very fine cut. With this the pivot is reduced in size and at the same time made quite parallel. While this is being done, the pivot does not rest in the final groove, where it is brought to accurate size by a burnisher shaped like the file, but without any teeth. It is then only expected to fit the number of the gauge corresponding to the number of the groove. This gauge is shown in the left upper corner of Fig. 1.

The Jacot tool has generally four centers or runners, two of which are useful at both ends. One end of each of these centers is used for treating the diameter of

drill bow revolve the pinion or staff, moving the file backwards and forwards. This is continued till the diameter is reduced to the level on which the file rests, and if it is desired to still further reduce the size of the pivot the facet must be moved to a division with a lower number, and so on, until it is finally the size required. In every case great care must be taken to keep the edge of the file in the corner of the pivot, so that the shoulder will be left square, and when the file is no longer needed the burnisher must be used, lubricated with a little thin oil, to finish the pivot. When the shoulder of the pivot is small and the file apt to slip along the staff, which might cause the pivot to break, it is customary to use a guard piece, which is sold with the Jacot tool. This guard piece is seen in the upper right-hand corner of Fig. 1. It is adjusted and fastened to the center by a set screw, and it has a small finger projecting just above the diam-

eter of the center, close against its end, forming a rest for the edge of the file. In the hands of an experienced pivoter this guard piece has, no doubt, prevented many breakages, and he may dispense with the use of it except in special cases. The reverse end of the described one is generally protected by a brass cap, as it carries a very thin disc pierced on its edge with

holes of graduated sizes corresponding to the numbers on the pivot gauge. In its use the pivots to be shortened and to have their ends rounded up are revolved in one of these holes with a little freedom, for which operation suitable tools are provided. The fourth center, seen in the left-hand lower corner of Fig. 1, is used only on one end, where it has four facets and grooves. These grooves are for the finishing of fourth wheel pivots, which carry second hands. They are made proportionally long, and so formed that the pivots finished on them are slightly tapering.

A convenient attachment, which may be made by an operator, is a loose steel pulley, fastened on a brass boss by a friction tight ring, which boss is threaded on its center for the purpose of being moved for-



FIG. 2.

# The Balance of Business

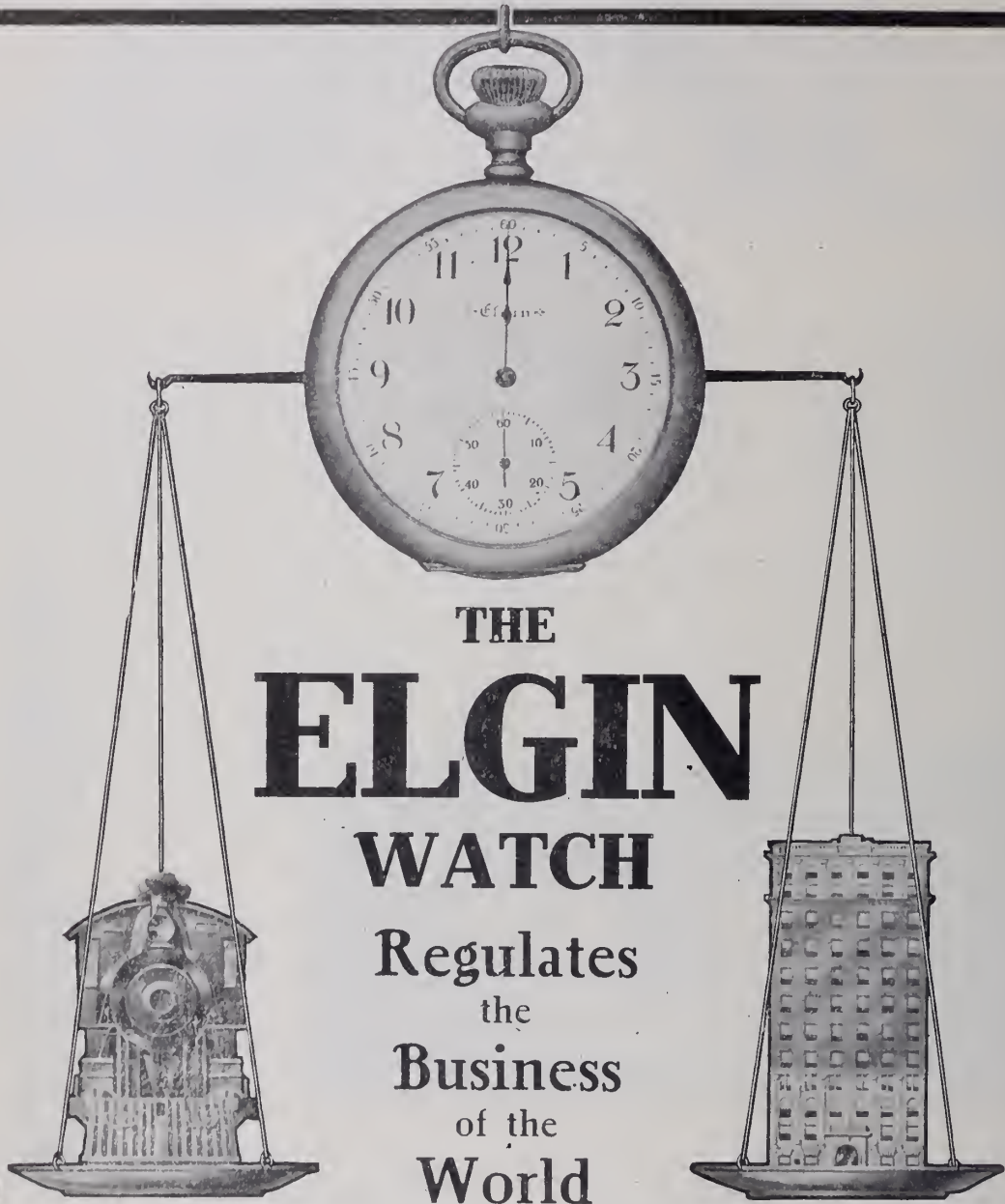

THE  
**ELGIN**  
 WATCH  
 Regulates  
 the  
 Business  
 of the  
 World

Indispensable to modern life, the Elgin Watch is ever in increasing demand—and the balance of business goes to the store that carries a full stock of Elgin Watches.

See Jobbers' list for prices or write the Company.

Every dealer is invited to send for the Elgin Art Booklet, "Timemakers and Timekeepers," illustrating the history and development of the watch.

## ELGIN NATIONAL WATCH COMPANY

Factories, Elgin, Illinois, U. S. A.  
 General Offices, 131 Wabash Ave., Chicago.

New York Office, 11 John Street.  
 San Francisco Office, 206 Kearny St.



ward or backward on a screw shank, forming a female center and fastened to the back runner of the tool; this brass boss is recessed on its back, to make room for a steel jam spring, which is also threaded in its center and may be set up against the brass boss, to prevent its shifting when the loose steel pulley with the carrier pins is revolved in finishing the pivot of a pinion with a wheel or a balance staff pivot with the balance attached. The runner, with this attachment, is shown in Fig. 2.

Fig. 3 represents a section of either a pivot file or burnisher for straight pivots,

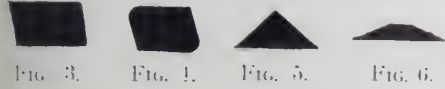

which may be had for either right or left-handed operators. In Fig. 4 is shown the same for conical pivots. Fig. 5 represents a section of a burnisher for cutting back shoulders, a tool seldom used. Fig. 6 is a section of a burnisher for rounding up and finishing the ends of pivots.

For shortening pivots a pivoting file or any other very smooth Swiss file may be used.

**A Rough Depthing Tool For Clockmakers.**

In a recent issue of the *London Horological Journal* the rough depthing tool illustrated below was described by Thomas Schmitt. It has been used in a more simple form for some time, and is a most useful tool for clock makers and repairers.

Speaking of the device, Mr. Schmitt said: "Some time ago I had to make a dead beat escapement for a regulator, and not having a suitable tool I invented this simple con-

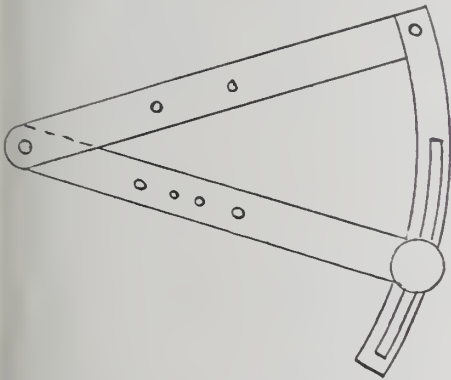

SIMPLE ROUGH DEPTHING TOOL.

trivance which, for pitting pallets, I consider more handy and convenient than the rather costly depth tool. I took two strips of brass, about seven inches long, and riveted them together at one end; at the other end I provided and united them with a segment of a circle with an adjusting screw.

"The use of this tool needs hardly any explanation. You drill holes at convenient places, adjust depth, measure it from center to center and transfer it to the clock plate. A similar tool may be adapted to examining the depthings of going barrels, center wheel pinions, etc.

Philip Diels, Marion, Ind., has moved into more commodious quarters in the Spencer building.

**The History of Church Bells.**

By C. W. COMBLE.



AS to the history of church bells, Polydore Virgilius records the hanging of bells in towers as originating under the patronage of Paulinus, Bishop of Nola, in Campania (Italy) in the fifth century. But Kraus informs us that church bells were first introduced into Europe during the ninth century. Monks were called to their devotions by the blowing of trumpets or the rapping with a hammer on the cell doors after the days of Constantine, who died A. D. 337; and clappers were employed in those days—not bells—in the eastern church. Some claim for Pope Sabinianus (A. D. 604) the origination. King's College, Cambridge, England, has the proud distinction of having the first reliable account of a peal of bells. This refers to Pope Calixtus III., in 1456, presenting that institution of learning with a peal of five bells.

With doubt surrounding the date and origin of the church bell itself, our knowl-

gether with the 28th Psalm. The bells are then anointed again exteriorly, in the form of a cross, seven times, and at four equal intervals with the "Oil of Chrism." Before this part of the ceremony the "oleum infirmorum" has been used. Incense is now put in the censer and placed beneath the bells. The antiphon "Deus in Sancto via tua," etc., is sung, several prayers are said, and then the deacon sings part of St. Luke (chapter 10). The ceremony is ended by the bishop making the sign of the cross on the bells.

But not every bell received such santonious rites, for we read that Marlborough's (England) big church bell, about 60 years ago, upon being recast was turned upside down and filled with beer for the country bumpkins to fill up on in company with the craftsmen who cast it.

One of the beautiful ancient customs was that of dedicating a certain bell to specific religious duties. Thus we have the "Sanctus" bell rung on the elevation of the Host, later named the "sacring" or "sacramental" bell; the "Lyche" or "Corse" bell was rung during the funeral procession; the "passing" bell was tolled to call for prayer of intercession on deathbeds. The large "sacring" bell has given place to the small "sanctus" bell rung by a priest's attendant in Catholic churches. It is hung in an outer turret, and calls for genuflexion.

And we must not forget the "Vesper" bell toning for evening prayer, or the "Angelus" (or Ave Maria) bell, which gives voice at the hours fixed for offering supplication to the Virgin. The "Complin" bell is used to summon the devoted to the day's final church service.

History tells us that potentates showed their anger and imposed punishment sometimes by taking away the peal of bells—a degradation much felt by that town's inhabitants. Mentioning this form of punishment reminds one of the story of the stern Oliver Cromwell, who, when he arrived before the antagonistically energetic town of Cork, ordered the removal of all the big bells and their conversion into artillery. Upon being remonstrated with for the harshness of such a sentence, he broke his naturally immutable austerity with a joke. Said he: "Since gunpowder was invented by a priest, the best use for bells is to make 'canons' of them."

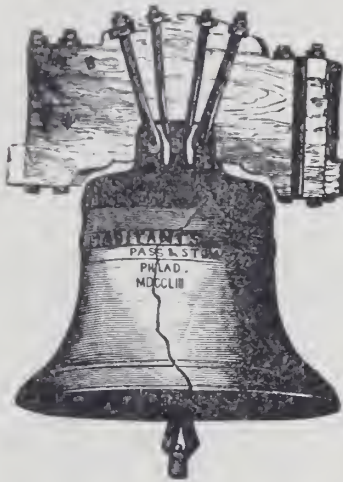

THE LIBERTY BELL.

edge extends to the fact that some time since its origination as an ecclesiastical church equipment the name of *campana* was given to the church tower bell, after the name of the tower where Nola was said to have started the custom. And the title *campana* has remained the designation of church bells ever since, in contradistinction to the *tintinnabula* (literally tinkling bells) or small bells for general use. Hence also we get the term *campanology* for the science of bell founding and ringing.

Well can we account for the odor of religious sanctity that surrounded the church tower's peal of bells when we bring back to memory the fact that these loud messengers of the Faith were christened under most formal ritual. Suppose we give an epitome of the Campana Baptismal rites for the benefit of those readers who feel a real interest in campanology. The ceremony commenced with the washing, by the Bishop, of the bells, both internally and externally, with a cloth dipped in holy water, while the choir sang the 145th and 146th and following Psalms. Next the bells were anointed with holy oil, the choir chanting the antiphon "Vox Domini super aquas multas"

As a representative of Meneely & Co., Troy, N. Y., informed the writer, in reply to the question whence to obtain particulars on the interesting but obscure subject of campanology: "There are books on bell founding written when the world was much younger than it is now, and what they say is of little practical use nowadays, for a great deal is legendary and cannot be relied on. Books that are written on this subject at all are generally written to describe some bell or bells. \* \* \* You might refer to any encyclopedia in a public library, and on reading several pages from each of two or three you will be convinced of the accuracy of our statements that books on the subject are not reliable."

However, the writer has "dug up" authentic information emanating from an up-to-date campanist and practical bell founder, with facts sufficient to appease most searchers after bell-founding secrets, and

## SPECIAL REQUIREMENTS IN WATCHES

**N**OT ONLY are these Offices equipped to meet the general needs of the Trade, but to supply such particular requirements as may arise from time to time. You will not be told that the movement you want is "not carried." You may have had that experience elsewhere. Every standard make of movement which is in demand is to be found here. Latest price lists on application.

### J. W. FORSINGER,

LEADING AMERICAN WATCHES AND MOVEMENTS

CHICAGO  
103 STATE ST.

NEW YORK  
2 MAIDEN LANE



# ZENITH

## MOVEMENTS

Give the

**RIGHT TIME  
EVERY TIME  
For a LIFE TIME**

**Grand Prize, Paris Exposition, 1900**

Made in O size, 12 size, 16 size, all grades  
Hunting or Open Face, Pendant Set

INTRODUCED FOR THE FIRST TIME IN AMERICA, THOUGH ONE OF  
THE BEST KNOWN WATCHES IN EUROPE FOR GENERATIONS

Manufactured by

**GEORGES FAVRE-JACOT & CO., Locle, Switzerland**

HIPP. DIDISHEIM & BRO., Sole Agents, 149 MAIDEN LANE, NEW YORK.  
COLUMBUS BUILDING, CHICAGO.

the fact of their exclusive character should certainly not detract from the merits of their enunciation.

Concerning the general laws pertaining to bell science a few axioms might be mentioned, such as follows:

The weight of the bell governs its tone; heavier bells have deeper, more majestic, dignified tone. The popular belief that the distance the bell vibrations carry increases in proportion to weight is strictly erroneous—the sharp, shrill sound from the small bell penetrates further proportionately than the mellow, low, "church-gong" tones of the big bell. A 100 or 200 pound school or factory bell often is heard from a much greater distance than a 1,000-pound bell in a church tower. As to distance records, the 22,000-pound bell (the largest ever cast in the United States) that hung in New York's City Hall till it was fractured, is said to have been heard as far as 13 miles up the Hudson. Bells of 4,000 pounds or over in open, unobstructed country location are often heard 10 or 12 miles away.

The encyclopedias and dictionaries state that the alloy for bell metal consists of three parts copper to one part tin mainly, but at times contains small amounts of zinc, lead, iron, silver, bismuth and even antimony. Experts in bell founding are these days unanimous and outspoken in their dictum that other metals than copper and tin are distinctly injurious to every qualification desirable in a church bell; that experiment proves silver to deaden the vibration and tone. Most bell founders declare that in their searches by analysis in old bells they have never found silver and rarely any metal beyond copper and tin, except possibly as impurity.

And now for a few trade secrets in bell founding. First as to measurements. A primary rule in designing of bells is that a bell of a given weight is of given diameter and thickness. A ton bell should have a diameter of four feet at the mouth, be three and a half inches thick at the "sound bow" (the thickest part of the bell; see sectional view). A hundredweight bell should be 18 inches in diameter and an inch and a quarter thick. This is considered by many, if not all, experts as an absolute rule. The bell having a uniform thickness throughout will produce unpleasant sounds. The "sound bow," or brim, must be the thickest point, tapering to perhaps a third of this.

Having worked out the design and dimensions, the next operation is to build the mould in which to cast the bell. The usual method is to dig into the ground and form what is known as the "pit." A "core" is next built up of bricks and loam the exact shape of the inner surface of the desired bell. This is dried in an oven and then placed in the pit. In similar fashion the "case" or "cope" is built to exactly represent in form and size the outer surface of the bell. On this "case" the inscription is formed. After thoroughly drying, the "cope" or "case" is lowered into the pit, thus leaving a space between "case" and "core" which exactly conforms in shape and size to the bell that will be cast when the molten metal is poured in.

The modern casting method differs from the old, inasmuch as it is done above ground

in iron perforated "venting" cases. The illustration graphically shows this improved apparatus, by which it is claimed a more perfect and solid casting is obtained and thereby greater perfection in tone.

A sectional view of a conventional church bell is shown herewith, affording readers a clear conception as to the location of the thick "sound bow," etc. The general law of proportion ruling is as follows: The



PERFORATED VENTING CASES.

"sound bow" is one-eighteenth the diameter in thickness; height of shoulder, 12 brims; width at shoulder,  $7\frac{1}{2}$  brims, or half width of mouth. All, of course, are subject to variation. And now, having our mould adjusted, wet let the molten stream fill up the narrow channel, and in a few short moments we have a casting that has cost days and even weeks to calculate and



SECTION OF BELL SHOWING VARYING THICKNESS.

prepare. Next we must wait for the metal to cool before taking the mould apart. A one-ton bell remains hot to the touch for two or even three days, while a hundredweight bell cools off quick enough to be dug out next day.

But our task is not by any means yet over, for while as a rare exception the tone of the newly cast bells may be correct, "tuning" is nearly always necessary. When a peal of bells is cast to the exact tone needed it is called a "maiden peal." And this "tuning" to correct deficiency is a secret supposed to be inviolable in the bell foundries. To make the tone flatter some of the thickest part of the bell's interior is shaved off. This can be done to the extent of flattening a half to even three-quar-

ters of a note without injury to the bell's qualities. In the case of chimes the necessity of perfect harmonizing of each bell is apparent, and the tuning operation is an exceedingly delicate one—so much so that in preference to sharpening a bell most foundries will place aside for stock a "flat" bell and cast another. The method of sharpening the bell's tone is to shave off the bottom or rim; it is generally a failure. For "tuning" the bells are fixed mouth upward and held with powerful vises.

Lastly, we have to select a hammer or clapper, which also must be done with method. The rule is: Ratio of hammer weight to its bell to bring out its full tone is one-fortieth. This cannot be safely exceeded. It is not necessary that chime hammers should be as heavy as this proportion.

This done, our bell is equipped, and CIRCULAR-WEEKLY readers have about all the knowledge they probably care for concerning the art and craft of campanology.

### New Observatory Planned by the Waltham Watch Co.

THE new observatory which is to be erected at the factory of the Waltham Watch Co., Waltham, Mass., will be equipped with all the latest improvements and the most delicate instruments which can be found in this country or abroad for obtaining the most accurate measurement of time.

Owing to the improvements which are now in progress at the plant, a change of site of the present observatory was necessary, and it now stands on its new location north of the steel wing. This is only temporary, however, and will be discontinued after the new observatory is erected.

### Great Clock for Norfolk, Va.

NORFOLK is to have a clock, said to be the largest in the world. It will be 140 feet from the ground, in a tower on the Garrett Winery. Its dials will be 25 feet in diameter, and they will be so arranged that the time may be told from any point in Norfolk harbor, the cities of Norfolk and Portsmouth or their suburbs for several miles around that part of Virginia.

No record can be obtained of a timepiece anywhere in the world as large as this will be. Plans for the clock tower are now being drawn.—Baltimore Sun

There is in the possession of the Czar a very remarkable watch. It was made by a Polish mechanic named Jules Curzon. The late Czar had heard some wonderful tales about the inventive ability of this man, and, wishing personally to test his skill, he sent him a parcel containing a few copper nails, some wood shavings, a piece of broken glass, an old cracked china cup, some wire and a few cribbage-board pegs. Accompanying this was a command to make them into a timepiece. Within a remarkably short time the Czar received them back in the shape of a watch. The case was made of china and the works of the other odds and ends. So pleased and astonished was the Czar that he sent for the man, conferred several distinctions on him, and granted him a pension.

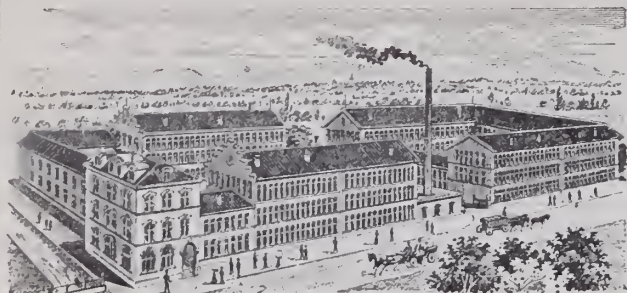

This illustration shows our main factory exactly as it exists, where 3,000 complete watches are made daily.

# LANGENDORF WATCH CO.

CHAUX-DE-FONDS, SWITZERLAND.

It will be of great interest to every jeweler to learn that we are devoting our full attention to this market. The existing conditions in the watch trade have convinced us that there is a long felt want for moderate priced, but accurate Swiss Watches.

We wish to call your attention to our LONVILLE MOVEMENT. It has a lever escapement and is being made in Os, 12s and 16s, fitting perfectly all American cases. This movement is salable and profitable. Our Watches and Movements will be introduced in this market bearing the following names:

- |          |          |
|----------|----------|
| SOLDALE  | HIGHMERE |
| BONDALE  | LONVILLE |
| CLAREFAX | NAMTOC   |
| PEARLHAM | LADY MAY |

SOLE AGENTS FOR UNITED STATES.

**BYRON L. STRASBURGER & CO.,**  
17 Maiden Lane, New York, N. Y.

# The Lady Racine

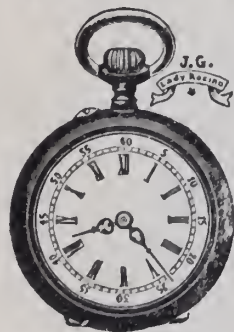

Positively the BEST chatelaine watch in the market.

**Machine Made**

10, 11, 12 and 13 Line; Cylinders and Levers; cased in Nickel, Gun Metal, Silver and Gold.

**Material on Hand.**

Write for prices.

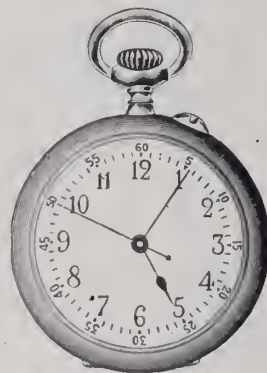

Lady Racine Nurse Watch.

**JULES RACINE & CO.,**  
103 STATE ST., CHICAGO. SOLE AGENTS 37 MAIDEN LANE NEW YORK.

For Sale by all Jobbers

## 46 out of 99 PRIZES

were awarded to

# PATEK, PHILIPPE & CO.

In the Timing Contest of the Astronomical Observatory in Geneva, for the year 1905, comprising: The only First Enlique Prize for Best Average Running; 2 First Prizes out of 3; 5 Second Prizes out of 10; 8 Third Prizes out of 18; 9 Fourth Prizes out of 24; 10 Honorable Mentions out of 23; 11 Simple Mentions out of 21. 11 Manufacturers participated.

68 NASSAU ST., NEW YORK.

GENEVA, SWITZERLAND.

IF IT'S A  
**ROY**

TRADE MARK  
IT'S STANDARD



O Size Bassine Engraved Cases, made from assayed Gold, quality as stamped.

## ROY WATCH CASE COMPANY,



21-23 Maiden Lane, NEW YORK.

SAN FRANCISCO.  
LONDON, ENG.

# Trenton Watches are Unequaled

For Beauty of Design, Perfection of Finish and Reliability Combined with Moderate Price



No. 100. Bridge Model, O Size, 7 Jewel, Hunting and Open-Face, Pendant Setting.

JOBBERS SELL TRENTONS

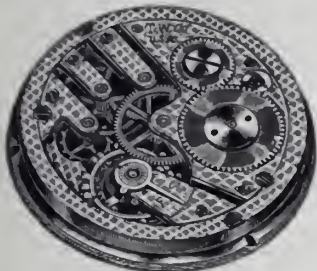

No. 320. Bridge Model, 13 Size, 7 Jewel, Hunting and Open-Face, Pendant Setting.

PRICE LIST on APPLICATION



No. 140. Bridge Model, 16 Size, 15 Jewel, Hunting and Open-Face, Pendant Setting.

A SAMPLE LINE is convincing. They are Pendant Setting in all Sizes, fitting Regular Pendant Setting Cases, Decorated Dials, and Louis XV Hands.

A Neat Sign or Advertising Booklet for the Asking

Manufactured and Guaranteed by the  
**TRENTON WATCH CO.**  
Trenton, N. J.

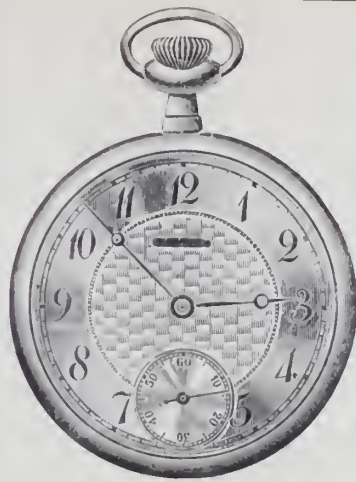

## THREE WINNERS

### The Lancet

15 and 17 jewel, adjusted, cased in 25-year Gold Filled hinge. The best and most attractive watch on the market.



### The Locust

7 jewel, lever.

Cased in 20-year Gold Filled. Screw back and bezel.



### The Carmen Watch Bracelet

Needs no comment.

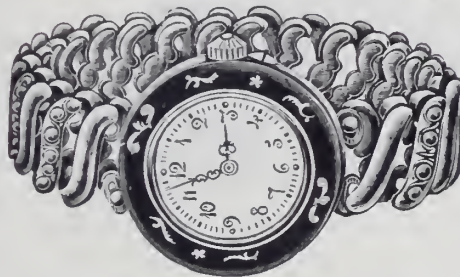
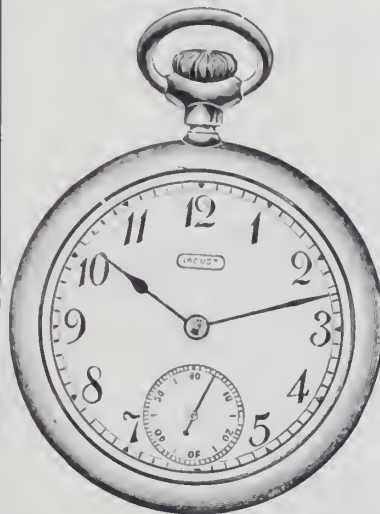

ASK YOUR JOBBER FOR THEM OR WRITE DIRECT TO

**HIPP. DIDISHEIM & BRO., 49 Maiden Lane, NEW YORK**

CHICAGO OFFICE, Columbus Building

### LEARN WATCHMAKING AT HOME

by THE De SELMS CHART SYSTEM, copyrighted and patented. The most simple, practical and up to the minute method of learning. Saves you time and money while learning and puts you in a position to more than double your income. 50 million timepieces to be repaired. Accurate time is a necessity in the business world. When time is money the watchmaker gets his share of profit. Positions for graduates. Booklet free. Write to-day.

The De SELMS WATCH SCHOOL,  
109 Perry Street, ATTICA, INDIANA.

### Expert WATCH and Chronometer REPAIRING FOR THE TRADE.

When others fail you we guarantee satisfaction. A trial will convince. Prices very reasonable.

List will be sent on request.

G. OHAN, 37-39 Maiden Lane,  
Lorsch Bldg., Room 27. NEW YORK.

## "Practical Course in Adjusting." Price \$2.50.

All Jobbers or Jewelers' Circular Publishing Co.

**JULES JÜRGENSEN**  
Watches and Chronometers

PARIS—"THE GRAND PRIX" - 1900

SOLE

RUDOLPH & SNEDEKER,  
65 Nassau St., New York

AGENTS

WHOLESALE

# DUEBER-HAMPDEN COMPLETE WATCHES

The conceded friend makers for the retail dealer. We are certain that we can help you make customers if you will write us for prices on Chains, Rings and all kinds of High-Grade Jewelry.



## WM. C. PENFOLD CO.

WHOLESALE JEWELERS

AND AGENTS FOR DUEBER-HAMPDEN WATCHES

818-820 Chestnut St., Philadelphia, Pa.

## SETH THOMAS CLOCK COMPANY.

Established 1813.

THE MADELEINE.



Wood Case, Adamantine Finish, Metal Columns, Gold Plated Caps and Bases. Superior 8-day Movement, Porcelain Dial, French Sash with Beveled Glass.

List Price, \$10.50; Height, 12 inches.

70 Wabash Avenue,  
Chicago.

Seth Thomas Clock Co.,

51 Maiden Lane,  
New York.

MAKERS OF  
**Tower and Street Clocks**

For particulars write us, mentioning The Jewelers' Circular-Weekly.  
**E. HOWARD CLOCK CO.,**  
EST. 1842. BOSTON, MASS., U. S. A.

**WATCH REPAIRS**  
FOR THE TRADE ONLY  
**WE BEAT THEM ALL!**  
in Prices and Quick Service  
**MAEBERT & REISS**  
71 and 73 Nassau Street - NEW YORK

**Horological Department,**  
**BRADLEY POLYTECHNIC INSTITUTE,**  
Formerly Parsons Horological Institute,  
PEORIA, ILLINOIS.  
Largest and Best Watch School in America.  
We teach Watch Work, Jewelry, Engraving, Clock Work,  
Optics. Tuition reasonable. Board and rooms near  
school at moderate rates. Send for Catalog of Information.



## Sessions Clocks

Superior finish. Reasonable prices.

Have you seen our

**New and Exclusive Designs**  
in Mantel and Hanging Clocks?

Write for Catalog and supplement.

**The Sessions Clock Co.**

Main Office and Factories,  
Forestville, Connecticut, U. S. A.

New York Salesrooms,  
37 Maiden Lane.



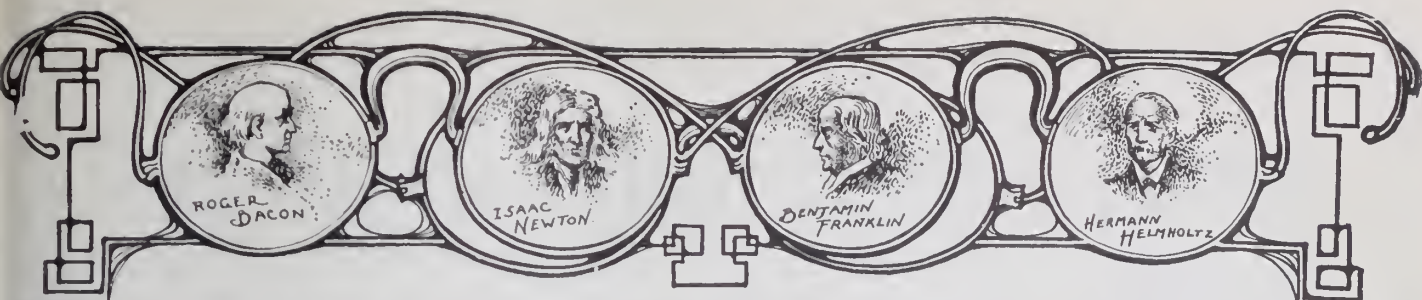

# OPTICAL DEPARTMENT

## The Estimation of Vision in Infants and Children.

**T**HOUGH it may be upon rare occasions that the optometrist is called upon to examine very young children's eyes, he is nevertheless at times in that position and should be familiar with the means for conducting such tests.

In the cases of infants, the requirements can only be to note whether or not the child sees at all. Of course, a child does not begin to "fix" ordinary objects until it is a few weeks' old at least, but experiments have shown that a baby only a few days old may respond to the flash test, if vision be there. The test is made in a dark room by flashing light from a mirror into the child's eyes. It is safe to assume that all children three months or more old who do not respond to the flash test are either imbecile or idiotic. Naturally there is no possibility of estimating the visual acuity in very young children.

In older children, however, say between the ages of one and five, the acuity of vision, it is claimed, may be approximated closely by ascertaining the distance at which familiar objects, as toys, for instance, can be recognized. Worth has devised a reasonably accurate means, employing five ivory balls, varying in size from one-half an inch to one and a half inches in diameter. These are first given to the child to play with, to whom they soon become familiar. This point gained, the balls are placed upon the floor, at a distance of 20 feet from the child, the largest first, and so on in order to the smallest. The child is told each time to go and pick up the ball. By careful observation the one making the test can readily tell by the manner in which the child starts off whether he really sees the ball before he starts or is only going to look for it. In making this test it is presupposed that the child can walk.

To the writer this does not seem a method that may be depended upon for exact findings, because though a patient often cannot name the letters on the normal line of type he can tell you that there are letters or some black characters there, and the child therefore may see the smallest ball well enough to start in its direction, but at the same time he may not see it clearly. In fact, the small ball would seem larger to the child with defective eyes than it would to the one with perfect eyes on account of the circles of diffusion that would be formed on the retinae of imperfect eyes.

It would seem, therefore, that no reliable subjective test can be made unless the child is old enough to count or read. Most chil-

dren learn to count orally before learning the alphabet or even before recognizing numerical characters, so it might be possible to approximate usual acuity by having the little one count how many dots there are in various groups, these dots to be graduated so far as possible on the basis of the five-minute angle.

The open or broken O test is a valuable one for children's cases. You can explain to the child that the O (through being broken it looks more like a C) is a fence and that the opening is a gateway; then by asking the child where the gate is in various sized lines of these broken Os, a really fair estimation of the visual acuity may be arrived at.

Skiascopy is, on the whole, perhaps, the most useful method of testing. To keep the child's attention fixed have it look at some bright object, as a red or green colored light, or use the method suggested by R. M. Lockwood in his latest book, "Skiascopy Without the Use of Drugs," wherein a second mirror is attached to your skiascopic mirror, in which the patient may look at some properly placed object which moves as you rotate the mirror and which, therefore, holds the attention remarkably fixed.

The ophthalmoscope is of little practical value in estimating any case, so in children, where the accommodation is very active it is often of no use. E. L. R.

## The Ability to Prevent Errors of Refraction.

**T**HE real optometrist is not only he who can correctly diagnose and overcome refractive errors but who is also endowed with a full sense of the importance of preventing these conditions. The report of the case of a boy living in Paterson, N. J., is at hand, stating that the boy has become totally blind from eating too much candy containing aniline compounds as coloring matter.

Innumerable cases of loss of vision from the use of tobacco and alcohol are known. Muscular imbalances, astigmatic conditions, contracted myopia, are often due to reading while lying down or sitting at a desk or table that is either too high or too low.

Attempts have been made by optometrists in many cities to impress the school authorities with the importance of providing adjustable desks and seats for pupils. These attempts have met with some but not general success, and no better means can be found for advancing these ideas than by educating the public, who will soon see to it that these conditions are improved. Therefore it behooves every optometrist to enlighten parents and impress upon their

minds the importance of making their children take and receive proper care of their eyes in these respects.

The dangers attendant upon the use of tobacco and alcohol, of wrong postures, of poor illumination, and of eating highly colored candies are a few of the facts that should be drummed into everyone, and in such a convincing way as to make this warning effective. Do not think that you have done your whole duty when you have provided the proper lenses for an existing refractive error, but tell your patient how he may help prevent further trouble and, if possible, tell him how his trouble originated so that he may guard his children or acquaintances against similar errors. Being naturally interested in eyes when he comes to you, give him all the data you can and he may be depended upon to disseminate that knowledge and thus enable you to be indirectly useful to mankind in a broader sense than you are when you help one single individual.

Take a broad view of your work; don't smile at harmful conditions and think "it will create more glass wearers and help my business." You will lose in the long run if you take that selfish, narrow view. It is well understood that the real work of the physician is to prevent not to cure diseases, and in China the physician is paid while he keeps a family in good health and while administering to the sick he receives no remuneration.

Taking the selfish, interested view of the matter—a normal man has no objection to helping mankind, if it costs him nothing; there is a pleasure in feeling that you have helped raise the general welfare without lowering your own. Well, then, the good that you can do by spreading this preventive knowledge will not be realized in this generation, therefore it will not reduce the number of glass wearers for you, it is the next generation of optometrists that will have a better class of eye conditions to contend with, but you can best afford to do your work manfully, honestly and thoroughly, and let the next generation of optometrists take care of themselves.

## Announcement.

A committee of New York optometrists has volunteered to gather and make at home all those leaving for Rochester from New York who do not come with delegations. A large party will leave the Grand Central Station on the 1.02 p. m., on the "Second Empire," Sunday, July 29. Every optician is requested to wear upon his lapel a small piece of blue ribbon, so that all may be easily recognized.

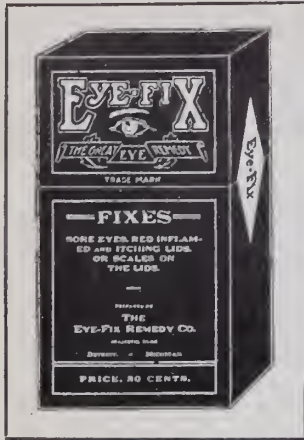

# Who Sells Eye-Fix?

**N**EARLY everybody in the trade. In less time than any other eye remedy on the market accomplished the same end, EYE-FIX has demonstrated its worth to jobbers, retailers and consumers. There is no just reason for prejudice against this article. Every dealer who wishes to best serve his own interests can handle EYE-FIX successfully. It sells on merit, invariably gives satisfaction and allows a big profit. Sales are going ahead by leaps and bounds. Why not share in this substantial prosperity? Get on the winning side of the eye remedy proposition. If you haven't already stocked EYE-FIX will you please tell us why?

**EYE-FIX REMEDY COMPANY, DETROIT, MICH. DEPT. 17.**



## It's the Little Things that count.

The dainty little things that appeal at once to the casual observer. If it's useful, as well as ornamental, so much the better. Here is a LITTLE THING, so very useful and so pretty in design and finish, that you have but to show one to make a sale, and it yields a BIG PROFIT. It is called

## The Automatic Eye-Glass Holder

Can be used as well for a Pencil Holder. It is made in Enamel, Gold, Silver and Rolled Plate, in a variety of artistic designs. We fully guarantee every Holder. We mean it, and will replace any Holder that fails to satisfy. Samples sent upon request. Send for catalogue.

Est. 1832. **Ketcham & McDougall, Manufacturers,**  
37-39 MAIDEN LANE, NEW YORK.  
ALSO MAKERS OF THE LEADING LINE OF THIMBLES.



## "PERFECTION"

The diamond pointed lens drill that has proven itself, beyond question, the best lens drill on the market is patented. Made in three qualities and sizes.

X \$5.00. XX \$6.00 XXX \$7.00.

MENDES CUTTING FACTORIES

12-16 John St.

'Phone 6605 Cort.

NEW YORK.



## THE THOUSAND ISLANDS

will be more attractive than ever this season. The New York Central Lines Four-Track Series No. 10, "The St. Lawrence River from the Thousand Islands to the Saguenay," contains the finest map ever made of this region. Copy will be sent free, postpaid, on receipt of a two-cent stamp by George H. Daniels, Manager, General Advertising Department, Room 61A, Grand Central Station, New York.

THE



REACH THE THOUSAND ISLANDS FROM EVERY DIRECTION

C. F. DALY, Passenger Traffic Manager, New York.

## PATENTS

obtained on inventions and designs. Trade-marks, prints and labels registered.

**R. W. BISHOP,**  
ATTORNEY AT LAW,

908 C Street N.W., Washington, D. C.



## Optical Department.

### Anatomy of the Nervous System.

(Lecture recently delivered before the Rochester Optical Society by DR. RALPH H. WILLIAMS.)  
(Continued from issue of July 4.)

THE diagram shows the source of a nerve impulse in the skin through the double branched sensory fibre which originates in the bipolar cell of the posterior root. You will note that there is no continuity of fibres, but a contiguity. The tracts of nerve fibres in the cord are divided into two classes, according to the direction in which they degenerate on section, in tracts of ascending and descending degeneration.

The tracts of ascending degeneration are those which arise from cells towards the periphery, and are transmitting impulses either to the brain or to higher levels in the cord. They are, in other words, the sensory columns.

The tracts of descending degeneration are those which arise from cells either in the brain or upper levels in the cord and are transmitting afferent impulses, that is, impulses to the periphery. The tracts of descending degeneration are practically confined to the tracts on each side known as the crossed and direct pyramidal tract and the antero-lateral descending. The cross pyramidal tract is located just in front of the posterior horn of the gray matter.

The direct pyramidal tract is situated next to the anterior median fissure of the cord. These two tracts originate from cells in the cortex of the brain and as they pass downward the greater part of them cross over in the medulla coming to the opposite side and forming the crossed pyramidal tract, the balance coming down on the same side as the direct pyramidal tract, but crossing over to the opposite side of the cord at various levels lower in the cord, so that they really supply structures of the same side of the body as are supplied by the crossed pyramidal tract of the other side.

The antero-lateral descending column is a large mixed column, not all of its fibres passing in the same direction, and it is believed that this column contains fibres which connect together various levels of the cord without penetrating direct to the brain or to the periphery.

The tracts of ascending degeneration are four in number, on each side: the columns of Goll and Burdach, which lie between the posterior horn of the gray matter and the posterior median fissure, the column of Goll lying internally and increasing in size from below upward, and the direct and ventral cerebellar tracts which lie around the outer portions of the anterior and lateral aspects of the cord.

The columns of Goll and Burdach carry sensory impulses from the periphery into the cord, throwing off laterals at various levels and finally terminate around cells in the funiculus cuneatus and gracilis at the medulla oblongata, which I have already described. The fibres of the column of Goll are comprised principally of fibres from the legs having started in the column of Burdach and by degrees having passed into the column of Goll.

Before mentioning the direct cerebellar tract I must call attention to a column in

the gray matter of the cord known as Clark's column. It is indicated on the diagram and consists of a large number of cells around which are arborizations from the fibres of Goll and Burdach, sensory fibres. From these cells, fibres are given off, which pass directly to the cerebellum and it is these fibres which form the direct cerebellar tract. It is in this way that sensory impressions which are received are transmitted to the cerebellum, the great co-ordinating center of the body.

The ventral cerebellar tract is also a column containing fibres, communicating between various levels of the cord and by a system of relays, with the cerebellum of the opposite side. This brings us to the consideration of a point in regard to the conduction of sensations of pain, heat and cold. It has been demonstrated that the sensory nerve may be severed and even the sensory columns in the cord be degenerated and yet sensations of heat, cold and pain will remain. In some way not now understood these sensations arrive in the gray matter of the posterior columns and are transmitted up by an infinite system of relays through the cells of the gray matter of the cord and into the optic thalamus or funiculus cuneatus or gracilis, and thence through the usual channels to the brain. We are now in a position to trace intelligently a nerve impulse through the nervous system from the periphery to the brain and back again. This brings us to the general question of reflexes.

A reflex action is looked upon as an operation of the nervous system independent of the central nervous system. The structures necessary for a reflex act are a sensory nerve to carry an impulse to the cord or controlling center and an afferent nerve to carry the resulting co-ordinated impulse to the periphery. The diagram here shows the course of such a nervous operation. The impulse is carried from the skin, we will say, to the spinal cord, where its nerve trunk ends in an arborization around a cell in the anterior horn of the gray matter of the cord. This termination need not be the final end of this nerve, which, as we have seen, will pass on up the cord to end in the medulla, but simply a branch from it. This cell in the anterior horn is capable of co-ordinating the impulse carried to it and of initiating a new impulse which it sends out along its nerve fibre to the surface, causing muscular activity. The subject of reflexes is a broad and interesting one. The frog has been used most extensively in studying this interesting phenomenon, but lack of time necessitates our confining ourselves to a few of the more pronounced ones in man.

The brain, that is, the cerebrum, exerts an inhibitory influence upon reflex activity, the section of the cord permitting greater activity of the centers below that point. This is also illustrated in locomotor ataxia. This is a disease which causes the degeneration of the columns of Goll or Burdach, thus cutting off from the brain the impulses for that portion of the body affected by the degeneration. So long as the reflex arc which I have illustrated remains intact the reflexes will be increased on account of the elimination of the will.

There are two forms of reflexes, the

superficial or true, and the deep or false reflex. The important superficial reflexes are the planter, wherein the foot is withdrawn on tillation of the sole of the foot; the gluteal reflex, the contraction of the muscles of the buttocks when the skin over them is stimulated, the cremasteric reflex, which causes the contraction of the testicle when the skin on the inner side of the thigh is stimulated; the abdominal reflex, i. e., the contraction of the muscles of the abdomen as a result of stroking of the sides of the abdominal wall.

The most important reflex of the cranium is the one of which I have already spoken, the conjunctival reflex which causes a closure of the lids as a result of the slightest irritation to the surface of the eyeball. There is also the reflex of the iris with which you are acquainted, provoked by exposure to light. There is also a reflex manifested in the dilatation of the iris on stimulation of the skin of the neck.

The deep or tendon reflexes represented by the knee jerk with which you are all familiar is not a true reflex for the reason that it is largely due to local or direct stimulation of the muscle itself. The fact that this is lost in advanced ataxia is due to the fact that the condition of the muscles is such that they have lost their irritability and first refuse to respond to local stimuli. Thus while it is necessary that the reflex arc be intact to make this reflex possible, this is but a necessary accompanying condition and not a direct factor in the action.

(To be continued.)

### Stories in Spectacles.

THERE is no doubt that spectacles are not dashing. They may give their wearer a learned look, but they can never make him the *beau sabreur*. We are reminded of this painful fact by a paragraph in a morning paper, which points out that there is no record in fiction of the hero having worn spectacles. We are not able to verify this statement, as our reading has not embraced the whole of fiction, but certainly, at the moment, we cannot recall any spectactled hero.

There is a big fortune waiting for the astute novelist who is first in the field with a volume in which the principal character suffers from astigmatism and takes the only sensible way of relieving it. It is estimated that a very considerable portion of the population of the United Kingdom wears glasses; and all these unfortunates would, beyond a doubt, pay their four shillings and sixpence for "The Man in Spectacles" or "Through a Pair of Glasses Darkly," or whatever the novel might be called. We can imagine the subject treated in a variety of ways.

Sir A. Conan Doyle might give us a mystery, with Sherlock Holmes, his eyesight permanently damaged by injections of cocaine, wearing spectacles in his search for clues. Anthony Hope would make his spectactled hero lean back in his chair and say good things. We commend the idea to our novelists.—*London Globe*.

Dr. Manasse, oculist and optician, is now located at 1203½ Turk St., San Francisco, Cal.



That this department shall prove mutually beneficial to our readers, it is desirable that the members of the trade generally communicate with THE JEWELERS' CIRCULAR-WEEKLY regarding any advantageous device or plan which they are utilizing in connection with their business.

### One Jeweler's Experience at Advertising.

(A paper read by S. M. STRAIN, at the convention of the Illinois Retail Jewellers' Association, at Springfield, July 11, 1906.)

THE old saying "competition is the life of trade" is a thing of the past, in so much as it does not cover the whole ground; the new and more modern saying that will cover the ground with the old one is, *Advertising is the life of trade*; the new adage will undoubtedly be disputed by numerous merchants, but there remains the trial to be made. It is my opinion that those who try it (not in a small way, but with liberality in the advertising appropriation) will agree in this.

In the four years that I have conducted my business I have been an ardent advertiser, I have preached and practiced advertising in the most liberal form, and results have been entirely satisfactory to me.

The time was, even within my own short memory of things, when advertising was a despised and down-trodden asset to the average business house, being used only on occasions of special sales when the merchant was overstocked with goods or needed cash; then it was that every merchant gave recognition to the good in advertising, for when publicity is needed then the advertising portion of the expense appropriation is added to. At the present time the advertising department is one of the most important in any business, it is well groomed, kept well oiled and ready for use at all times.

Advertising occupies an important place in the modern business house no matter how large or how small the house may be. The publicity department, which every successful store must have, may be considered as a silent but efficient partner in all successful up-to-date stores, drawing trade and holding the customers which it attracts.

Spasmodic advertising will bring good, profit-paying results only for a short time; it is the fellow who sits in the game all the time that will get money in return for his money expended. Take for example two clerks, one will be always found at the show case ready to serve the patrons, the other will be sitting in the back room and will come forth when his services are needed. Which one will sell the most goods? Which one will have the most friends? Which one will patrons call for when they come in? The answer is obvious, and you all well know which one

will be the most valuable to your store. So it is in advertising, the people will soon learn that the fellow who is constantly advertising is always ready and waiting for them, and will pass by the other man in the same line, to go to the wide awake store.

People have come to judge a man and his business by his advertising; for example we have in our county a number of dealers in pianos, of which I am one. But one other beside myself advertises in papers from out of his own town; his ads. are left standing year in and year out without a change; the one he now has is to the effect that he is moving to a new location and that he is expecting a car load of pianos at once; now the fact is that he moved six months ago, and has had the car load of pianos five months; there are a number of interpretations to be placed on his ad. Does he mean to say that he is so slow that it has taken him all that time to get his stock of pianos transferred to the new location, or does he imply that the stock is so large that it has taken him six months to make the move? Has he been so busy that he has not had the time? The proper interpretation is this: That he is not a successful advertiser and had just as well not use the space: It shows a lack of enterprise and to the present up-to-date class of people looks bad.

I have advertised in the same papers, and have changed the copy each two weeks, and the results show that the new methods are the ones that are taking with the people, for I am selling instruments right along in territory that at one time was indisputably my competitor's.

Advertisements should be made to sound like the advertiser talking. If you are very guarded in your language, write the ads. so, if you are given to slang, put a little of it in, but be careful as too much will not do. In this as well as other mercantile matters it is necessary to please all classes of people. And all kinds of ads. are as essential as all qualities of stock.

We are now face to face with the indisputable fact that every merchant is not a versatile and successful ad. writer. This is a drawback, but it can be overcome; for "where there is a will there is a way." Keep your eye open for good ads., look for them at all places and at all times, look for them in the daily papers, look for them in the magazines, look for them in the circulars that come to you. Some of these are

written by good writers, and are the kind that are calculated to bring results. Use them. But, you say, they will not one in 10 fit our own individual case. We will acknowledge that to be a fact and will tell you how to overcome it. There is the sacred privilege in the United States to change them if we are not satisfied, work them over, this is an easy matter if you have the knack. A Chicago jobber at one time sent out a circular headed as follows: "AFTER IT GETTING IT KEEPING IT"

Then an explanation followed as to what the IT was; my competitor picked it up and used it as follows

*"After it, getting it, keeping it,*  
GEO. N. BLANK, Jeweler."

It soon came to be the talk of my friends that there was no meaning to it whatever and people could not understand what he was driving at. So I saw and took up the opportunity to show the real meaning of the copy. I secured the space next to his and inserted the following:

"WE'VE BEEN AFTER IT, WE'VE GOT IT, WE WILL KEEP IT.

"Do you know what IT is? We will whisper it to you. IT is the jewelry trade of the vicinity. STRAIN, Reliable Jeweler. Nekomis and Witt."

I have one here that I found last week, and have prepared it for use, in order to show the possibilities of a worked over ad. I will read it first as I found it, then will give you my own version of it.

This ad. worked over is in my perfect language, and will be taken as original. I will get the credit of the authorship of it, while in reality some one else has been the guilty party.

Original ads. are the best for many reasons, they are set out to fill the place that is vacant, they are written for the purpose of calling attention to your own business, and they assuredly do so more perfectly than those which are copied or written by others. So be original if you can.

The length of time an ad. should be allowed to run is very short, I have seldom let one pass over two weeks, no matter how good I considered it to be; they soon go dead, and a dead advertisement is indicative of a dead business.

Different views are entertained as to what is the space to use. I am a user of newspapers, circular letters, bill boards, signs, and a feature of the weekly change in show windows; I cannot say which is the best in the production of results, but

**Storekeeping Department.**

the use of all kinds promises the reaching of all classes of the trade, and that is the desired result.

There prevails among some jewelers the idea that the repairing is as good an ad. as they are in need of. True it is that the repairing is a very good way of gaining the public confidence, but it alone will not suffice. In these days of catalogue and department houses, when we are constantly reminded that our patrons can buy goods cheaper elsewhere, it is our duty to hold

tised in a great many different ways and have just squandered my money for the returns are not as they should be." Then that is your fault, the ads. have been wrong and people have not taken them seriously; you have been standing in your own light.

Stop and think out the trouble; perhaps your competitor is better at the advertising game than you, perhaps you have let the ads. run too long and they became stale; get down to the root of the evil and try to rectify it. Make the ads. so that people cannot help noticing them; make them interesting, readable, argumentive. Successful advertising is the life of the present day business and if you will use it properly, intelligently, telling of, and arguing truthfully for your goods and methods I can say from experience they will positively bring abundant results, and all the money

**An Up-to-Date Retail Jewelry Establishment in Lansing, Mich.**

**T**WO views of the establishment of Dodge & Whitney, Lansing, Mich., are shown herewith. The store is 40 feet deep, 19 feet wide in front and 20 feet wide in the rear. There is a partition at the end of the store, eight feet high and covered with green tapestry to harmonize with the side walls, which are of the same material. Back of this partition is a room 12 feet deep, divided in the center, making an optical room on the left side and a workshop on the right.

The establishment has a steel ceiling and a floor of mosaic tiles. The show cases, five in number, are of plate glass and solid walnut and are each 10 feet long.

All the woodwork in the store is of the



FRONT OF DODGE & WHITNEY'S STORE.



INTERIOR OF STORE OF DODGE & WHITNEY, LANSING, MICH.

spent on the silent partner of your business—advertising—will repay you many fold in increased business, profits and prestige.

**Ideas and Schemes.**

In the show window of the store of Taylor & Gregory, Derby, Conn., there was recently exhibited under a glass case a black snake three and a half feet long. The odd display attracted a great deal of attention.

A unique window display consists of showing a number of watches with real money—the amount for which they can be purchased being placed alongside of each watch. The display is a temptation to thieves, and hence should be carefully guarded.

Ebb N. Zell, Reading, Pa., was taken into custody about a week ago, on a charge of receiving stolen goods. Zell was arrested at the instigation of a woman who declared that her nephew stole trinkets and disposed of them through the jeweler.

same wood. The head watchmaker's bench is located at the south end of the store and close by are two 10-foot wall cases, with a three-foot beveled-edge plate glass mirror between them and a large safe at the end.

At the north end of the store there is an attractive wall case, five feet high, for the display of cut glass, etc.

On either side of this case are large panels, which are made by tacking square pieces of black cloth on the wall and covering the edges with gold beading. In these panels are erected bracket shelves, on which clocks, etc., are displayed to good advantage. Back of this there is another five-foot wall case for hand-painted china, while a similar case adorns the end of this side of the room.

The store is steam-heated and brilliantly illuminated with incandescent lights. All the wall cases, as well as the show cases, are made up with plate glass.

The show windows are enclosed with one solid piece of plate glass, with ball-bearing slide doors at the bottom.

to our trade and increase it as much as possible. Is it not a fact that our trade has suffered more from advertising done by the large houses in the cities than from any other competition? Is it not a fact then that the only effective way we have of fighting these business leeches is in the advertising of our business?

To have your trade increase, to have your sphere of influence increase, you must tell the people that you have the goods and are very anxious to exchange them for their money and then to make them believe it profitable for them you must advertise constantly, honestly and without stint.

"Well," says some one, "I have adver-

What Tool is of More Importance to THE MAKERS OF FINE JEWELRY than

**A FIRST CLASS SAW ?**

**SHARP—TRUE—UNIFORM  
—PERFECTLY TEMPERED**



Such is the **ZEUNER SAW.**  
TRY THEM, for "Only the Best are Good Enough," and only the Best are Cheap.  
Trial orders promptly filled under guarantee of perfect satisfaction, which applies also to our "AMERICAN SWISS FILES."

**E. P. REICHELME & CO.,** 23 JOHN STREET, NEW YORK.

**HERPERS BROS..**  
MAKERS OF  
**BRACELET SETTINGS**  
IN 10, 14 AND 18 KARAT GOLD AND IN PLATINUM.  
ALSO A COMPLETE LINE OF GALLERIES AND FINDINGS.  
OFFICE AND FACTORY NEWARK, N. J. U. S. A. NEW YORK BRANCH 41-43 MAIDEN LANE

**GALLERIES**  
12 NEW PATTERNS

**CULMAN BALANCE CHUCK**

For Refinishing Balance Pivots, without removing the Hair-spring or Roller, and protecting them while the pivots are being polished. ONCE TRIED, ALWAYS USED. FREE ON 10 DAYS' TRIAL.  
OVER 1000 SOLD THE FIRST YEAR. PRICE, \$3.50.  
C. CULMAN, 316 N. Sixth Street, ST. LOUIS, MO.

**ROLLED GOLD PLATE  
SEAMLESS WIRE AND TUBING**  
DUNBAR, LEACH, CARNER CO.,  
ATTLEBORO, MASS. MANUFACTURERS,

**HERMAN KOHLBUSCH, Sr.,**  
ESTABLISHED 1859.  
Manufacturer of Fine Balances and Weights for every purpose where accuracy is required.  
Office and Salesroom, 194 BROADWAY, NEW YORK. Tel. 370 Cortlandt.

**DAY CLASS | ENGRAVING | NIGHT CLASS**  
THE SCHOOL FOR THOSE WITH MODERATE MEANS  
**POMFRET-GOLDY SCHOOL OF JEWELRY ENGRAVING**  
SEND FOR PROSPECTUS 319 HEED BUILDING, PHILADELPHIA, PA.

**Telephone Calls**  
only 5c. each  
**Extension Stations**  
only \$6 per year

These are only two of the many attractive features of the new telephone rates, effective July 1st.

Contracts now being taken.  
Call nearest Contract Office for full information.

**NEW YORK TELEPHONE COMPANY**  
Contract Offices: Telephone No.:  
15 Dey Street 9010 Cortlandt  
115 West 38th Street 9040 38th  
220 West 124th Street 9000 Morningside  
916 East 150th Street 9020 Mel-osc

**GLARDONS' SWISS FILES**  
are the HIGHEST STANDARD of Excellence.  
We are Sole Agents for the United States and Canada.  
**F. W. Gesswein Company,**  
Established 1868. Incorporated 1890.  
WILLIAM DIXON, PRES.  
Dealers in Fine Tools and Supplies,  
39 John Street, New York.

**JAMES J. DONNELLY,**  
Gold and Silver Electro Plater,  
Fire Gilder and Colorer,  
41 and 43 Maiden Lane, New York.  
Prompt Attention Given to Mail Orders.

"PRACTICAL COURSE IN ADJUSTING."  
Price, \$2.50.  
All Jobbers or Jewelers' Circular Publishing Co.



[Answers are also solicited from our readers to the questions published on this page.]

**QUESTION No. 1609.—Gold Polish.**—How can I make a polish that I can use on gold and plated jewelry? G. P.

**ANSWER:**—A good gold polish is made with rock alum (burnt and finely powdered), five parts; levigated chalk, one part. Mix and apply dry with a brush.

**QUESTION No. 1610.—To Polish Ivory.**—What is the best thing to use for polishing ivory? I. P.

**ANSWER:**—Fine pumice stone and putty powder are very good for polishing ivory. If used with a leather buff, then it is necessary to moisten the powder enough with oil to prevent them from flying away.

**QUESTION No. 1611.—Substitute for Platinum.**—Is there any metal that can be substituted for platinum? The cost of platinum is so expensive that I have often wondered why some cheaper substitute has not been brought out. S. F. P.

**ANSWER:**—Only recently a substitute for platinum was discovered by a Mr. Birmingham, Baltimore. The new metal is said to melt at about 3,636° F., to be malleable and ductile, and to be unaffected by acid. It is capable of being rolled into sheets or made into wire, and is said to become soft and workable at a temperature far below its melting point. No particulars are given as to its constitution, but it is said that the price will be about half that of platinum.

**QUESTION No. 1612.—To Restore Green Copper Solution.**—I use a cyanide of copper solution that has turned green. How can I restore it to a lighter color? T. R.

**ANSWER:**—If a cyanide of copper solution turns green, add a small amount of cyanide and it will be brought back to the natural color.

**QUESTION No. 1613.—Acidless Solder Flux.**—Will you kindly give us a formula for a flux for soft solder, containing no acid? We are having considerable trouble with penknives, etc., which rust after having gold sides soldered on them. R. L.

**ANSWER:**—A flux for soft solder which contains no acid is composed of chloride of zinc and alcohol, with sometimes an addition of a solution of salammoniac in distilled water. Any surface to be soldered with soft solder ought to have its pores opened a little; polished surfaces do not make a strong joint. Steel not to rust after soldering ought to be heated somewhat, rinsed in chemically pure alcohol and dried in hot boxwood sawdust.

**QUESTION No. 1614.—Porous Holes in Soldering.**—Can you give us any information as to how porous holes may be avoided on plain jewelry, such as lockets and bracelets? Whenever the articles are soldered it often happens that porous holes show up, especially where joints are. Can

you give an alloy of solder that will solder clean and will not allow porous holes to be seen? S. & W.

**ANSWER:**—Porous holes left by soldering may be caused by different conditions. Successful soldering requires cleanliness, skill, experience and good solder. Porous holes will appear principally owing to excessive or undissolved borax, and next from the fact that solder does not run quick enough, as protracted heat causes the solder to oxidize in part.

**QUESTION No. 1615.—Ink for Polished Metal.**—What kind of ink can I use for writing on polished metal? I. P. M.

**ANSWER:**—We know of no ink for that purpose in the market. To make an ink that is very good for polished metal surfaces, dissolve 20 parts of resin in 150 parts of alcohol and add one part of methylene blue. In a separate dish dissolve 35 parts of borax in 250 parts of water, and add to the first liquid. The ink can be used at once.

**QUESTION No. 1616.—Ink for Writing on Glass.**—Please give me a formula for making an ink that I can use for writing on glass. A. W. G.

**ANSWER:**—Dissolve in 500 grammes of water 36 grammes of sodium fluoride and seven grammes of sulphate of potash. Make another solution of 14 grammes of zinc and 65 grammes of chlorhydric acid in 500 grammes of water. When ready for use mix equal parts of the two solutions and write on the glass with a pen or pencil. In half an hour an inscription will appear.

**QUESTION No. 1617.—Silver Plating Steel Knives.**—Kindly give me a safe formula for silver plating steel knives and forks? S. P. S.

**ANSWER:**—There are several ways of silver plating knives. One way is to first lightly copper them, and the other to place the deposit directly on the steel, the latter method being the most difficult. The best success is had with this method when large quantities are plated and everything is in proper condition. When one does not silver plate very many steel goods it is best to slightly copper them first. The following is also a much used formula: Have a striking solution containing cyanide of potassium, which should stand 3° Baume. As an anode copper is used. This is intended to produce evolution of hydrogen. The second solution is cyanide and contains one-eighth to one-fourth ounce of silver to the gallon, and should stand 5° Baume. A copper and a small silver solution are used and will produce a pinkish film of silver. The next solution used is the regular silver solution, which should stand at 5° to 6° Baume and contains one-half ounce or more of silver. When the knives are chemically

clean they are placed in the first solution for about half a minute, and without rinsing put into the second for the same length of time, and finally into the third solution, where they are left until finished.

**QUESTION No. 1618.—Distilling Gold.**—Will you inform me if there is any way to distil gold by electricity? D. G.

**ANSWER:**—The American Inventor recently printed the following on distilling gold: "M. Moissan, to whom we owe so much of our knowledge of the behavior of chemical elements at a high temperature, has found that there is no difficulty in distilling gold in an electric furnace, and that the liquid condenses on a cold surface in minute crystals and threads, which we have exactly like ordinary gold in a finely divided state. The boiling point of gold is higher than that of copper or tin, but lower than that of lime, so that on distilling alloys of gold with copper or tin a fractional separation is effected, the gold being the last to pass over. When an alloy of gold and tin is distilled with lime, the distillate, consisting of a mixture of gold, oxide of tin and lime has the beautiful color and other characteristics of the well known purple Cassius used for coloring glass and porcelain. Hitherto this substance has only been produced by wet methods, such as treating a solution of gold in aqua regia with solution of the chloride of tin, and the new dry method of preparing it may be found of commercial importance."

**QUESTION No. 1619.—Writing on Zinc.**—Please give me a formula for making a black ink for writing on zinc. W. Z.

**ANSWER:**—Make a mixture of verdigris, one part; salammoniac, one part; chimney black, one-half part. Mix these well together before using and use a quill pen in writing. This ink must be handled with care as it is a poison.

**QUESTION No. 1620.—Cleaning Aluminum.**—How can I restore the brilliancy to tarnished articles of aluminum? C. A.

**ANSWER:**—Aluminum can be cleaned by immersing in water which has been acidulated with sulphuric acid. Or brush over with a soft brush, water and a little carbonate of soda.

**QUESTION No. 1621.—Brush Finish on Brass.**—How can I produce a brush finish on brass articles? The objects are already polished. B. F. B.

**ANSWER:**—The brush brass finish is produced with a brass wire scratch brush, which should revolve about 800 revolutions per minute. It is best to use a four or six row brush, from six to eight inches in diameter. While brushing, apply some moistened powdered pumice. The pieces are then treated like other brass finishing by washing, drying and lacquering.

A complete change in the method of transmitting power in operating the machines in the different departments of the Illinois Watch Co.'s factory, Springfield, Ill., was made during the vacation which was given to the employees, ending last Monday. Steam was supplanted by electricity for motive power. Thirteen electric motors were installed, of 135 horsepower each. The plant is now regarded as one of the finest equipped in the country.

**C. DORFLINGER & SONS,**  

---

 36 MURRAY STREET, NEW YORK.

Manufacturers of plain  
 and cut Table Glassware  
 of the highest quality.

*Works, White Mills, Wayne Co., Penna.*



No. 3399.—Loving Cup. Height, 10 inches.

**The Pairpoint  
 Corporation.**

Send for Catalogue showing  
 our complete line of

**Prize Cups  
 and Trophies.**

BRANCHES :

38 Murray Street, New York City  
 36 St. Antoine Street, Montreal, P. Q.  
 717 Market Street, San Francisco, Cal.

FACTORY : NEW BEDFORD, MASS.

**Have You  
 Received Our  
 New Catalog?**

**Maple City Glass Co.,  
 CUT GLASS TABLEWARE,  
 Hawley, Pa.**

SALESROOMS :

- New York—H. B. Stites, 253 Broadway.
- Baltimore—Green & Thomas, 33 S. Charles St.
- Boston—Sweetser-Bennett Co., 101 Tremont St.
- Buffalo—J. R. Stadlinger, 685 Main St.
- Indianapolis—J. A. Dugan Co., 22 S. Capitol Ave.
- Duluth—Duluth Crockery Co., 6th Ave. and West St.
- Denver—Western Selling Co., 1617 Lawrence St.

**REMOVAL NOTICE**

We now occupy the new store of

**The Lorsch Building, 35 Maiden Lane, N. Y.**

**WOLFSHEIM & SACHS**

MAKERS OF

Fine Boxes, Trays and Novelties for Jewelers and Silversmiths

**35 MAIDEN LANE, N. Y.**

Telephone, 3518 John.

Factory, 10 Gold Street.

**FAIRCHILD & COMPANY**

225 to 233 Fourth Ave.

NEW YORK CITY.

Manufacturers of GOLD PENS, PENCILS,  
 PENHOLDERS, SEGAR CUTTERS, SPECIALTIES,  
 PENCILS SET WITH JEWELS.

*Style, quality and workmanship acknowledged  
 the very best.*



*We may not be alone  
 making good gold  
 decorated glass, but  
 our kind, certainly  
 is the best that  
 can be made  
 Write for our cata-  
 logue.*

*The Honesdale Decorating Co.  
 Honesdale, Pa*

**C**LOCKS, BRONZES  
 COMMUNITY SILVER  
 CUT GLASS, NOVELTIES

SEND FOR CATALOGUE

**H. BEALMEAR & CO.**  
 234-236 Park Ave.  
 Baltimore, Md.

# THE CONNOISSEUR

*Devoted to Art Pottery, China, Marbles, Bronzes, Cut and Decorated Glass Ware, Bric-à-Brac, Lamps, Art Metal Wares, Fancy Goods and Kindred Lines.*

Greek Marble.

## General Appraisers Decide as to Duty on Fringes for Ornamenting Glass Lamp Shades.

FRINGES designed for ornamenting lamp shades, composed of glass tubes gilded or silvered for ornamental purposes, or beads strung on cotton cords and attached to cotton webbing, are dutiable at the rate of 60 per cent. ad valorem under a decision announced last week by the Board of United States General Appraisers, overruling a protest of Moller, Kokeritz & Co. against an assessment of duty by the collector at New York.

General Appraiser Sharretts in his opinion says:

"These protests cover certain fringes designed for ornamenting lamp shades. They are composed of glass tubes (each from 1 to 4 inches in length) and beads strung on cotton threads and attached to cotton webbing. These articles were returned for duty by the collector at 60 per cent. ad valorem under Par. 408 of the tariff act of 1897 as beaded trimmings.

"We have some doubt as to whether fringes of this character are included in the tariff enumeration of trimmings; but, inasmuch as the tubes forming some of the fringes are decorated by gilding or silvering, we overrule the claim in the protests that the merchandise is dutiable at 45 per cent. ad valorem under Par. 112, holding that it is dutiable at the rate assessed thereon by the collector, either as beaded articles under Par. 408 or under Par. 100 as articles composed in chief value of glass, gilded or silvered for ornamental or decorative purposes, the collector's decision in each case standing affirmed."

## Recent Decisions as to Tariff on Porcelain Plaques, Statuary, Etc.

DECISIONS by the Board of United States General Appraisers, New York, in cases involving duties on porcelain plaques and statuary, were announced last week as follows:

**PORCELAIN PAINTINGS—PLAQUES.**—Protest of Charles H. Wyman & Co. against the assessment of duty by the surveyor at St. Louis. The articles in controversy were reported by the collector to consist of so-called earthenware plaques and tile pictures. They were classified under Par. 88 and Par. 95, tariff act of 1897, relating, respectively, to "tiles, \* \* \* ornamental, handpainted," etc. and to "plaques \* \* \* painted." The importers contended that duty should have been assessed under the provision in Par. 454, tariff act of 1897,

for "paintings in oil or water colors \* \* \* not specially provided for." Waite, General Appraiser: The official sample forwarded as representative of the articles in question is a slab of what appears to be porcelain, rectangular in shape, measuring about 12¾ by 8 inches, entirely covered with a hand painting representing a half-length human figure, with a foreground of masonry, drapery, etc.

**MANUFACTURES OF MARBLE—STATUARY.**—Protest 179665 of F. B. Vandegrift & Co. against the assessment of duty by the collector at New York. Protest overruled on the authority of G. A. 6346 (T. D. 27302) and G. A. 5462 (T. D. 24758), relating to articles composed of marble, which were held not to be statuary as defined in Par. 454, tariff act of 1897.

## REAPPRAISEMENTS.

Decorated china from O. & E. Gutherz, mark 7196, Bodenbach, exported Nov. 4, 1905, to March 20, 1906, entered at New York (File Nos. 37434, 37685, 37763, 37832, 37885, 38026 and 39558); findings of Waite, G. A.: Dinner sets, 100 pieces, 1103, L1 and L2, entered at 21.50, advanced to 22.50 crowns per set; do., 1101, entered at 22.75, advanced to 25.25 crowns per set. Discount, 3 per cent. Add casks. Mayonnaise, white china, 1149, entered at 6 crowns per dozen; do., olives, 1242, entered at 2.50 crowns per dozen; do., 1243, entered at 3.75 crowns per dozen; soups, 1173, entered at 2 crowns per dozen; fern pots, 666, entered at 5.40 crowns per dozen. And similar goods. Discount, 3 per cent. Add casks. All white china advanced 5 per cent.

Japanese porcelain from M. Yomeda, Kobe, exported Jan. 19, 1906, entered at Chicago (File No. 39107); findings of Hay, G. A.: Bishu cups and saucers, 3¾ inch, 1550, entered at .75, advanced to .85 yen per dozen. Add casks and packing.

## Lease of the Pearl Fisheries of Colombia.

THE lease of the Colombian pearl fisheries is now being considered by the Central Bank of Colombia, which has the power to transact matters concerning the administration and management of property belonging to the Government.

A public auction was called for the purpose of awarding the lease of the rights to fish pearls, corals, etc., on the Colombian coasts of the Atlantic and Pacific oceans. The lease is to go into effect on Aug. 1, 1906, and is to last five years in the hands of the most desirable bidder, who must transact affairs in strict conformity with the rules and requirements laid down by the Central Bank of Colombia.

Turner and Edgar Braley, Pulaski, Tenn., have purchased the business of H. H. Harris & Bro., at Columbia, in the same State. The business will be continued under the name of Braley Bros.

A REPORT from Consul George Horton at Athens indicates reviving interest in the ancient marble quarries of Greece.

Among colored Greek marbles of great beauty may be mentioned those of the Island of Skyros; the green marbles of Tinos; the Cipolino marbles of Euboea, of two shades of green that blend in broad, wavy lines that run through the stone; and the red marbles of Mani, known as *Rosso Antico*. This latter is of a blood-red color, often traversed by veins of white, or sometimes found in solid red.

A British company owns the whole of the white and blue quarries on the Penteli Mountain Range and have spent money lavishly in developing them. The private railway of the company extends 15 miles from the inclined plain of Mount Pentelicus. Blocks weighing 20 tons are taken to the company's fashioning works, whence they are conveyed to the Athens railway, a distance of about eight miles, also over a private line owned by the company. Work at the Penteli quarries is kept in full swing day and night and about 1,000 men are on the pay roll. It is the aim of the company to place marble on the market at less prohibitive prices than those which have prevailed hitherto. Blocks weighing as high as 40 tons have been taken down to the port at Piræus and loaded on ship-board for export. The Penteli marble is almost pure carbonate of lime, but there is more sparkle in the crystals than is found in Italian marble. Its close texture and high purity of color have given it an undeniable claim to its description as a "white" marble.

But of all the white marbles of the world perhaps the most beautiful is the finely grained and spotlessly pure Parian marble of the island of Paros. The celebrated statues of Venus de Milo, the Venus de Medici, the Venus Capitoline, were made of this marble. These quarries, as well as those of the adjoining island of Naxos, have been taken over by this same English company.

At the annual meeting of the S. T. Little Jewelry Co., Cumberland, Md., held June 25, the following officers were re-elected: President and manager, R. W. Little; vice-president, P. J. Seaver; treasurer, C. G. Smith; secretary, John G. Lynn, Jr. The directorate is composed of the above and Robert MacDonald, Harry E. Weber and James W. Thomas. A six per cent. dividend was declared.

**THE  
World's Best**

The man who wants to own a Kentucky thoroughbred will not be satisfied with a broncho merely because the price is lower.

There is cheap cut glass in plenty—cheap almost as the pressed product.

But Libbey perfection can only be bought under the Libbey brand—and quality considered Libbey is not only the world's best, but the world's best value.

**The Libbey Glass Co.**  
TOLEDO, OHIO  
New York Salesroom, No. 57  
Park Place.

*Libbey*  
"THE WORLD'S BEST"

LOOKING FOR  
THE NAME

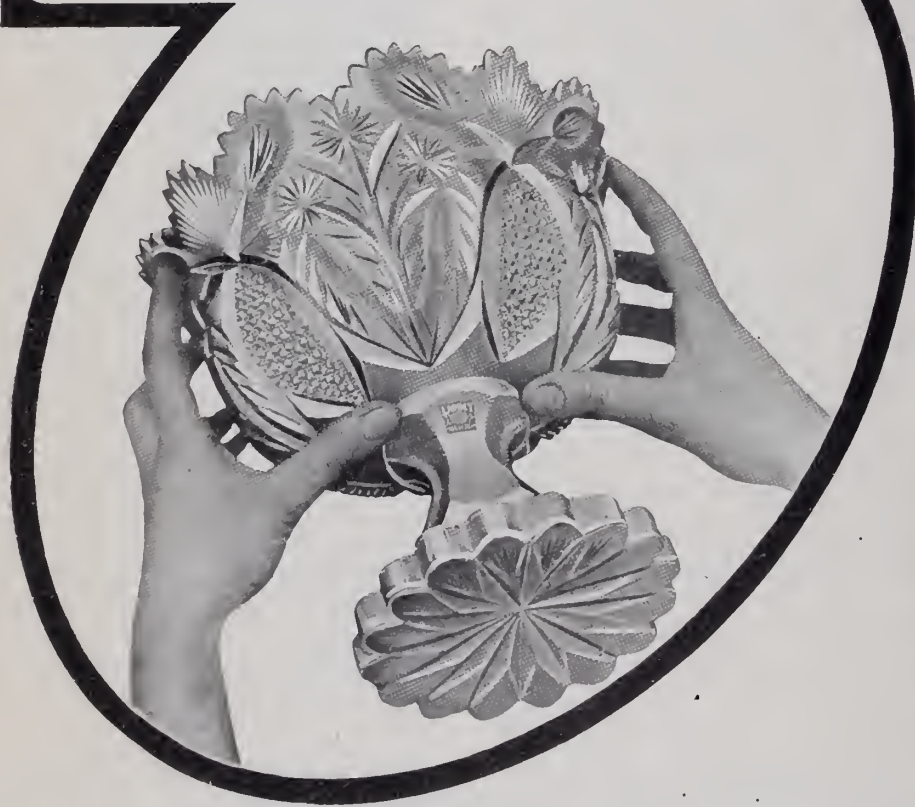

**Tivoli Art Glass Co.**

(L. ADLER & SON)  
General Agents

Makers of High Art Iridescent  
and Decorated Glassware

87 MAIDEN LANE . NEW YORK  
Telephone 2054 John.

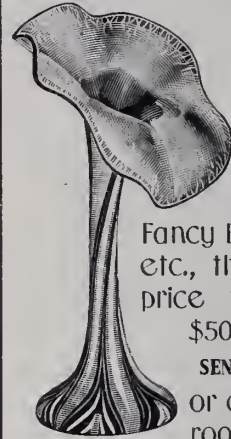

GLASSWARE  
showing "The  
Colors of the  
Rainbow." Our  
line is complete  
with Vases,  
Fancy Bowls, Novelties,  
etc., that range in  
price from \$1.00 to  
\$50.00 each.

SEND FOR A SELECTION,  
or call at our show  
rooms. The selling  
quality is in the sheen and colors;  
cuts cannot show its beauty.



Real Seal Bags with inside purse, size of  
bag 8 x 6 inches

PRICE, \$36.00 A DOZEN  
High Class—Best Value in the Market

**L.W. Levy & Co.**

580-582 Broadway, New York City

LEATHER GOODS, NOVELTIES  
OF ALL SORTS, METAL,  
GLASS, CHINA, GUN METAL, Etc.

**WE HAVE WHAT YOU WANT!**

A COMPLETE LINE OF

**Jewelry and Silverware Cases**

SHOW CASE AND WINDOW DISPLAYS

**ABE KASSEL**

671-3-5 HUDSON ST.

NEW YORK

**RINGS**

**WM. LOEB & CO.**

101 Sabin St.,

Providence, R. I.

New York Office, 37 Maiden Lane.



### Interesting Collection of Early American Silversmiths' Works in the Boston Museum of Fine Arts.

A MOST interesting article on the subject of a new collection of old American silver recently gathered by the Boston Museum of Fine Arts appeared in the *Evening Post*, New York, recently, in the form of a letter from R. T. H. Halsey. The facts contained therein will be of such general interest as well as so instructive to jewelers that it is herewith published in full. The letter reads:

"SIR—In the Museum of Fine Arts, Boston, there has been gathered for exhibition during the Summer and Autumn months a collection of silver, 365 separate pieces, the work of 120 of our American silversmiths of the 17th and 18th centuries. As a purely æsthetic display, the exhibition cannot fail to give pleasure to every visitor. The silver has been arranged in seven large central cases and three side cases in one of the main galleries in the museum. Its setting against white linen backgrounds is most appropriate, and the effect of the mass of silver vessels scintillating in the sunlight and here and there reflecting the colors of the Flemish tapestries, which cover the walls of the room, is most pleasing. The silver is of the period when the ancient geometrical shapes held sway among craftsmen; when purity of form and perfection of line were preferred to elaborateness of design; when dignity and weight were considered superior to quantity, and when the beautiful white metal was allowed to take its colors from its surroundings, rather than serve as a medium for excessive decoration by workers in metals.

"Nearly all of the Massachusetts silversmiths are in evidence. Hull & Sanderson (1653), Jeremiah Dummer (1660), whose two sons served the Commonwealth for many years—one Colonial agent in London, another as Lieutenant-Governor and acting Governor of the province; J. Cony (1690), John Dixwell (1700), the son of the regicide, Col. John Dixwell, who lived and died in retirement in New Haven; Andrew Tyler (1700), Edward Winslow (1702), K. Leverett (1720), the Burts, the Hurds, both father and son; Paul Revere, and numerous others are lavishly represented. New York is in evidence in pieces by Adrian Bancker (1731), Myer Myers (1786), George Ridout (1750), Richard Van Dyke (1753), Cary Dunn (1765), and Jacob Halsey (1785).

"To those interested in the development of the arts and crafts in this country the exhibition is of extraordinary interest. The collector of American coins can view there the splendid work in silver of Hull & Sanderson, who, in 1652, were empowered to coin the money of the Province of Massachusetts. Those interested in the history of paper money in America may view the handicraft of John Cony, who, in 1690, engraved the first paper money for the colony. Students of the history of American engraving—for all early engravers were silversmiths—can find much to enjoy in the beautifully engraved cartouches, inscriptions and armorial devices on numerous vessels, the work of the Hurds and Paul

Revere, and others. Collectors of American book-plates cannot fail to recognize many of the Jacobean, Chippendale, and Adams designs, which were used to adorn both silver and book-plate at this time.

"Many pieces of the 17th century church silver in Boston have been loaned for the exhibition. The collection is possibly strongest in its array of 35 tankards, and the various styles of these highly cherished and almost obsolete drinking vessels form an interesting study. The evolution of the teapot is fully illustrated, beginning with a little bell-shaped teapot of the Queen Anne period made by Bancker of New York, and carrying us down to the round, pear-shaped and oval teapots of the latter part of the 18th century. Forty porringers, with their flat openwork handles, testify to the devotion bestowed on New England children. Mugs and cans of various shapes abound. Candlesticks from the shops of Jeremiah Dummer, Leverett, and Ridout are impressive in their beauty of workmanship. A coffee pot by Revere, engraved with the Warren arms, stands out in stately prominence. Braziers by Revere and Hurd show the forerunner of the chafing dish. In the collection of spoons there can be traced the sequence of shapes and designs of this useful article of tableware.

"The art of Paul Revere, that active son of liberty, immortalized by Longfellow, is demonstrated by 40 pieces from his workshop, and his patriotism is recalled by a tiny three-legged salt cellar engraved with "The illustrious 92," made at the time (1768) when all the colonies were singing the praises of the illustrious 92 members of the Massachusetts Assembly, who, against orders from their King, had voted not to rescind a circular letter sent by them to the various Colonial Assemblies, suggesting united action against the measures of the British Ministry. More interesting still is a splendid punch bowl, also by Revere, bearing the names of the 15 original owners, all members of the Sons of Liberty in Boston, inscribed: 'To the Memory of the Glorious Ninety-two Members of the Honbl. House of Representatives of the Massachusetts Bay, who undaunted by the insolent Menaces of Villains in Power, from a strict Regard to Conscience and the Liberties of their Constituents on the 30th of June, 1768, voted Not to Rescind.'

"The other side is embellished with a crude design, in which appears the name of John Wilkes, his symbol No. 45, the Liberty Cap, and a torn parchment labeled 'General Warrants.'

"No such forcible demonstration of the artistic conception and handiwork of the 17th and 18th century silversmiths has been given before in this country. To Americans it has a deeply added interest in that it represents the craftsmanship and tastes of the forefathers by whose efforts our republic was founded.

"R. T. H. HALSEY."

The retail jewelry establishment of Ernest Karthaus' Sons, Huntsville, Ala., was looted early one morning recently, and several gold watches worth about \$300 were taken. The thief broke the plate-glass display window and was severely cut, leaving behind him a trail of blood.

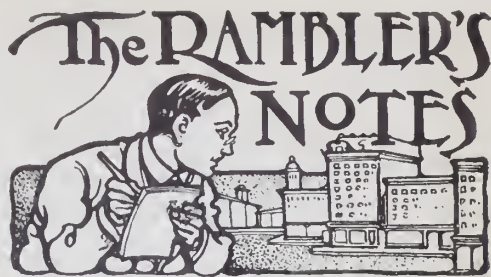

NEW offices and salesrooms are now occupied by Samuel Buckley & Co., in the addition to the building at 100 William St., New York, in which they have been located, their address remaining the same. The new quarters are large and bright, giving increased facilities for the display of English novelties. There have recently been received a number of new tantulus sets in which decanters and glasses, cut in hobnail and diamond patterns, are placed in handsome cases made of various kinds of wood in metal mountings. There are bottles of a plain design in which the panels are adapted for monogram engravings. Some of the decanters and bottles have the upper or lower half cut and the other portion plain. Other glass ware includes vases blown with purple, and green ornamentation. There are rose bowls in various delicate patterns. In ribbonette designs a variety of large and small vases is seen. Another line comprises glass of an odd shade of green blown in pretty shapes. There is a collection of rare pieces of glass ware, each notable for richness in coloring or ornamentation or for pleasing effects in form. Some of these pieces are in the antique styles that are highly prized. Among the novelties in china and silver are tete-a-tete sets in which the cups and saucers are of Royal Worcester china, while the tray, sugar, cream and coffee pot is of sterling silver. A mistletoe set is of solid silver with ivory handles. The "White Mice" earthen ware includes an attractive assortment of vases and bowls, the patterns representing an owl in chase of sprightly white mice. The assortment of silver and silver plated ware is larger than in any preceding year. It includes numerous reproductions of old silver patterns. Some of the reproductions come in antique finish so that they can scarcely be distinguished from the original except by experts. There is also much to be admired in the modern silver sets. Among other novelties are small silver mounted clocks standing two or three inches high.

Among the first and most important articles imported into Guatemala from the United States are those made of glass-ware. The exports of New York to Guatemala, which average about \$75,000 per month, include watches and jewelry.

THE RAMBLER.

The year of 1905 showed no marked advance in the gold mining industry of Venezuela. Before extending their operations many capitalists and mine owners are awaiting legislation which will grant the industry lighter taxation than heretofore.



## For the FALL TRADE

We have prepared many NEW ARTICLES  
in our famous

# "Metal and Glass" and Copper

VISITING BUYERS are invited  
to inspect our new

## Electroliers, Desk Sets, Etc., Etc.

### APOLLO SILVER CO.

BERNARD RICE'S SONS  
PROPRIETORS

544 BROADWAY, NEW YORK

WRITE  
FOR  
BOOKLET



Made in the  
"APOLLO STUDIOS"

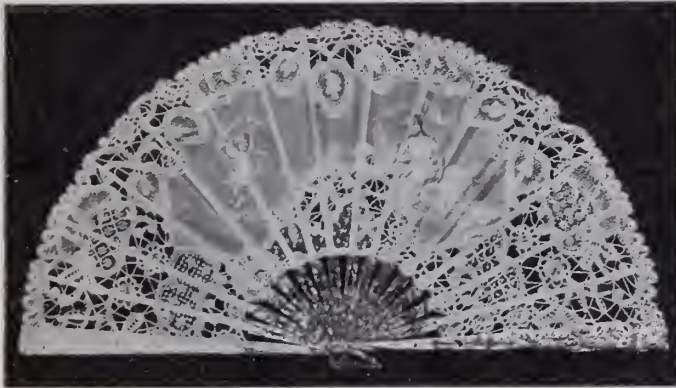

## FANS

Headquarters  
for the most ex-  
c'usive line in  
this country.

SPECIALY.  
DESIGNED  
FOR THE FINE  
JEWELRY  
TRADE

## SIGNS

WE make the kind that peo-  
ple notice. Silent speakers  
that are always telling abo st  
you. Fac-simile of signatures  
sawed from metal for cement-  
ing to windows. "No trouble  
to ship out of town."

THE FORMAN CO.  
SIX LIBERTY PLACE  
NEAR MAIDEN LANE . . . NEW YORK

## NECKLACES

Imitation Pearl and Fancy Bead, in all newest shades and exquisite  
colorings. Write for Samples, mentioning price.

LOUIS STEINER, Importer, 520 & 522 Broadway  
NEW YORK

JACOT MUSIC BOX CO.,  
IMPORTERS.

Stella and Ideal Music Boxes,  
39 UNION SQUARE, N. Y.



Established  
1850

## C. F. RUMPP & SONS

Manufacturers of

### Fine Leather Goods

PHILADELPHIA

NEW YORK SALESROOMS - - 683 and 685 Broadway

Send for Catalogue.



Emergency Case.

## THE "E-Z-FILL" SELF-FILLING FOUNTAIN PEN

FILLS INSTANTLY BY TOUCHING SPRING ON SIDE OF BARREL WITH PATENT PUSH PIN.

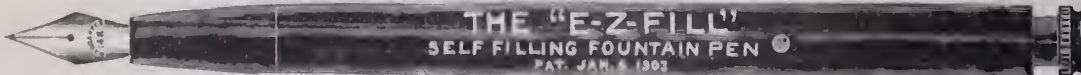

Pat'd in Europe Jan. 3, 1903.  
U. S. Patent Jan. 6, 1903.  
Other Patents Pending.

Retails at \$1 00

Every Pen Warranted 14-Karat Solid Gold. No complicated parts to get out of order. Large profits to Jobber and Retailer.  
The only safe and practical Self-Filling Fountain Pen ever offered at a popular price. Made only by

DIAMOND POINT PEN CO. - 100-102 Beekman Street, New York

Largest Manufacturers of Popular Price Fountain Pens in the United States

INFRINGERS WILL BE STRICTLY PROSECUTED

Send for large illustrated price list

# A Jewelers' Electric Lathe Motor

This illustration shows one of the eight different styles and sizes of Jewelers' Electric Lathe Motors, manufactured by **The Holtzer-Cabot Electric Co.**

Every Holtzer-Cabot Jewelers' Lathe Motor is backed by an absolute guarantee of one year.

which has passed through the experimental stages and which, through a careful elimination of defects, has become practically perfect.

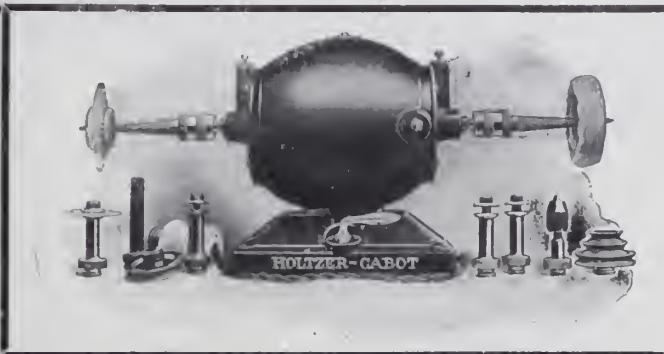

In using **Holtzer-Cabot Jewelers' Electric Lathe Motors** you receive the benefit of their **thirty years' experience** in the building of electrical apparatus, and you get a motor which has had **four years' trial** in practically all classes of buffing, grinding, polishing and kindred uses.

Send for our special circular No. 409, regarding our offer of "A Jewelers' Lathe Motor on Trial."

MAIN OFFICE,  
BOSTON (Brookline), Mass.

## The Holtzer-Cabot Electric Co.

CHICAGO OFFICE,  
395 & 397 Dearborn St.

**CASSIUS W. SEYMOUR,**  
37-39 Malden Lane, New York.  
ALLOW ME TO CALL ON YOU IN THIS WAY



**Jewelers' Stationer and Printer**  
Jewelers' Cards,  
Tissue Paper,  
Tags,  
Blank Books, etc.

**ROLL AND FLAT PAPERS.**

Estimates cheerfully given. Mail orders promptly attended to. Let us quote you our prices on manifold books and sealing wax.

# BLANCARD & CO.,

96 MAIDEN LANE,  
NEW YORK.

WELL MADE GOLD FINDINGS.

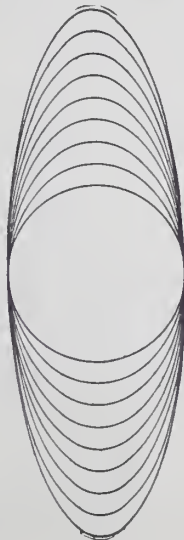
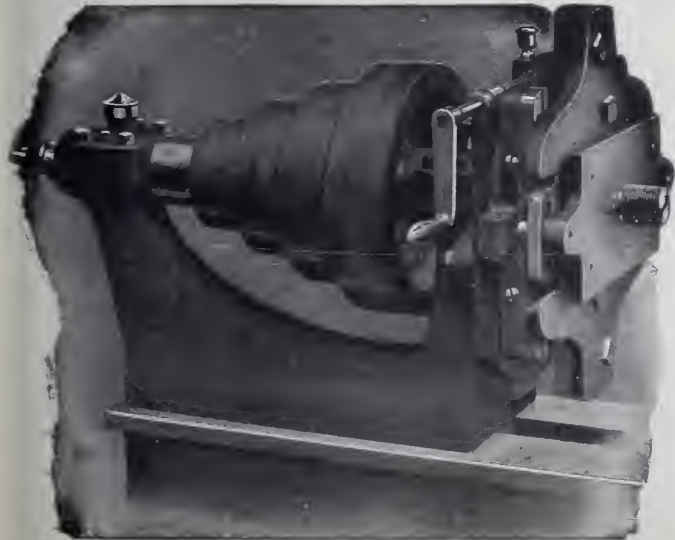

## Our Oval Spinning and Turning Lathe.

Our cuts show headstock of Lathe and variety of elliptics produced on same, retaining minor axis.

Write for our Catalogue of Spinning Lathes.

**P. PRYIBIL,**  
520 W. 41st Street, New York

*Mercantile Fountain Pen*

**The Best Self-Filling Attachment**

made and guaranteed by the

**AIKIN-LAMBERT COMPANY, 19 Malden Lane, NEW YORK.**

**Retail Price:**

**\$3.00**  
**\$3.50**  
**\$4.50**

Send for Price Lists and Discounts.

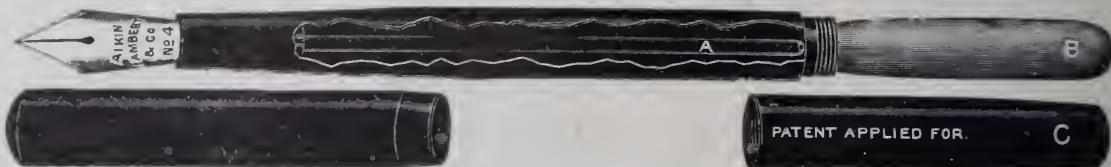

These well-known Razors, the quality of which is warranted, possess this great advantage, that they may be used for ten years before they require actual sharpening. Before using them it is necessary to rub them on good leather strop. Le Coultre's Strops (to be had with the Razors) should be used in preference to others.

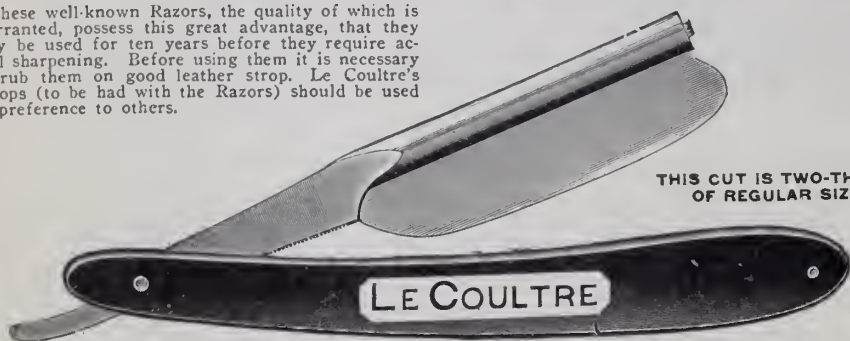

THIS CUT IS TWO-THIRDS OF REGULAR SIZE.

"SPECIAL"—Single Razors for Jewelers' Travelers at trade price.

**MATHEY BROS., MATHEZ & CO.**

Send for Price-list.

Sole Agents, 21 & 23 MAIDEN LANE, N. Y.

**WM. F. RENZIEHAUSEN CO.,**

**GOLD and SILVER REFINERS**

Sweep Smelters, Assayers and Analytical Chemists

Rolling of FINE AND STERLING SILVER a Specialty.

Long Distance Telephone, 3759-R.

45-49 Oliver Street, NEWARK, N. J.

**"PRACTICAL COURSE IN ADJUSTING."**

PRICE \$2.50.

ALL JOBBERS OR JEWELERS' CIRCULAR PUB. CO.

**-: Comparison :-**

ofttimes leads to better returns. We invite investigation and guarantee satisfaction.

Send us a trial order.

**CONLEY & STRAIGHT,**

Gold and Silver Refiners,  
Assayers and Sweep Smelters,

236 EDDY STREET, - PROVIDENCE, R. I.

Dealers in Fine Gold,  
Silver and Copper.

All kinds of Gold  
and Silver Anodes.

**CRUCIBLES.**



Jewelers' Supplies,  
Etc.

Established 1850.

**J. & H. BERGE,**  
95 John Street,  
NEW YORK.



**CASTINGS**

Gold, Silver, Bronze, Brass,  
German-silver, Copper & Iron,  
Supply Jewelers, Silversmiths,  
Die-makers, Mould-makers, etc.

Unbreakable Bronze Forces. Hard Bronze Engraving  
Plates. Cast Iron Forces for making Steel Dies.  
Chandler, Undercut Work, Statuary.

**AUGUST GRIFFOUL,** 313 HALSEY STREET,  
NEWARK, N. J.

**Encyclopedia-Dictionary**

and reference hand-book of the Ophthalmic Sciences.  
Price, \$2.50.

The Jewelers' Circular Pub. Co., 11 John St., N. Y.



**WE BUY**

Old Gold and Silver Filings, Polishings, Sweeps, Hand Washings, etc. We will make accurate valuations and hold consignment subject to your acceptance. If valuation is not satisfactory, we reship to you at our expense.

**WE PAY FOR OLD GOLD:**

22 K. 88c. per dwt.	12 K. 48c. per dwt.
20 K. 80c. " "	10 K. 40c. " "
18 K. 72c. " "	8 K. 32c. " "
16 K. 64c. " "	6 K. 24c. " "
14 K. 56c. " "	4 K. 16c. " "

MARKET RATES FOR SILVER AND PLATINUM.

Try us and you will appreciate our Squareness, Promptness and Accuracy.

**T. B. HAGSTOZ, Ltd.** Main Office, 709 Sansom St., Philadelphia, Pa.  
SMELTERS, ASSAYERS, REFINERS.

**WE SELL**

Gold, Silver and Platinum, various qualities, rolled flat or drawn to wire of any gage.

**PRICES OF ALLOYED GOLD:**

10 K. 48c. per dwt.	14 K. 64c. per dwt.
12 K. 56c. " "	16 K. 72c. " "
18 K. 80c. per dwt.	

Gold and Silver Solder, either from formulas furnished or our own. "T. B. H." Alloy, 25c. per oz. Guinea Gold, 75c. per lb. Shot Copper, 40c. per lb. We will send tables for alloying without charge. They save figuring.

**PLATINUM AMERICAN PLATINUM WORKS**  
NEW YORK OFFICE 41 Cortlandt Street NEWARK, N. J.

## Special Features of the BROOKLYN BRISTOL CASE.

- ☞ Best 25 year case on the market.
- ☞ A binding guarantee as to wearing qualities.
- ☞ All new designs made by the most experienced artisans.
- ☞ A new one-piece pendant, eliminating all solder.
- ☞ Solid gold ball bearing bow.
- ☞ Made in full line open face and hunting, screw bezel and back and screw bezel and solid back.
- ☞ Engraved or plain.
- ☞ New green and yellow gold color effects.

JOSEPH FAHYS & CO.

# The Only Middlemen



KNOWN TO THE CUSTOMERS OF

## J. R. Wood & Sons,

DIAMOND CUTTERS,

2 Maiden Lane,

NEW YORK.

# PROGRESS

New York's New Under-ground Railroad Built by "the Ring."

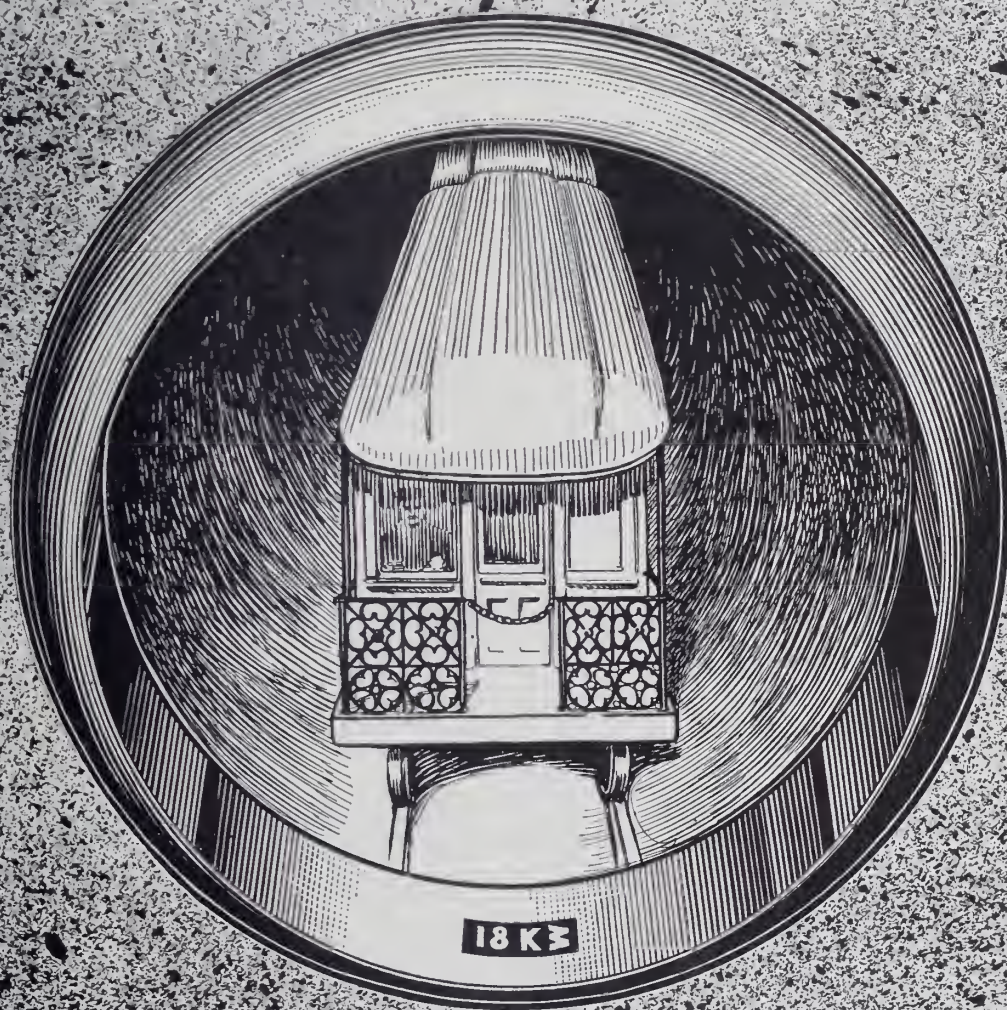

Makers of Plain Rings for Over 50 Years

2 Maiden Lane

NEW YORK

# Design, Workmanship, Quality and Durability

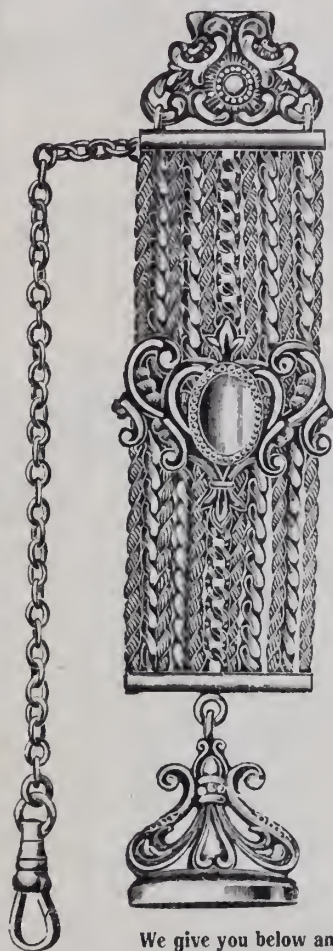

are the four factors which have made the

## BIGNEY CHAINS

the most popular in the market to-day. They are handled and worn by more people than any other make.



We give you below an exact copy of an assay of chains manufactured by the leading chain makers of the United States.

1-10 GOLD FILLED WATCH CHAINS, MINUS BAR AND SWIVEL.

Number	Gross Weight		Fineness Gold 1000ths	Value	Maker	Chain Number	Cost
	Ounces	Dec.					
15		71	29 1/4	\$0.43	S. O. Bigney & Co. - - - -	1155	\$2.85
16		75	50	.775		482	3.08
17		81	34	.57		3005	2.73
18		76	23 1/2	.37		9533	2.97
19	1	00	16 1/2	.34		83	2.14
32		52	49 1/2	.53		213 X	2.83
34		73	34 1/2	.52		733	2.41
46				.58		5011	3.82

1-8 CHAINS, MINUS BAR AND SWIVEL.

Number	Gross Weight		Fineness Gold 1000ths	Value	Maker	Chain Number	Cost
	Ounces	Dec.					
35		57	68	\$0.80	S. O. Bigney & Co. - - - -	1604	\$3.96
36		60	65 1/4	.81		7015	3.75
37		60	63	.78		4324	4.00
47		49	79	.80		2726	4.00

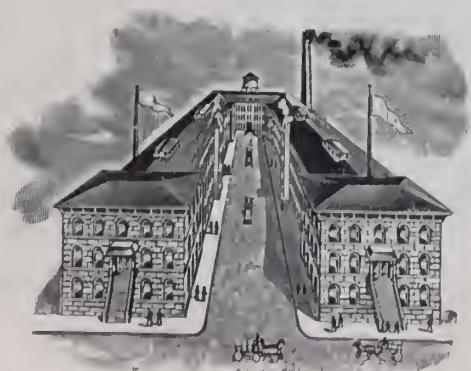

# S. O. Bigney & Co.

NEW YORK OFFICE,  
3 MAIDEN LANE.

FACTORY, Attleboro, Mass.





# Watch Case Makers, Remodelers and Repairers.



How an English Case Came to Us.



How it was Remodeled for Amer. S. W. Movement.

SPECIAL CASES MADE TO ORDER FOR ENGLISH, SWISS AND AMER. MOVEMENTS.

MELTING OLD GOLD CASES AND MAKING OVER INTO NEW CASES (USING SAME GOLD) A SPECIALTY.

ENGLISH CASES CHANGED TO FIT AMERICAN S. W. MOVEMENTS WITHOUT ALTERING OUTSIDE APPEARANCE.

KEY WIND CASES CHANGED TO STEM WIND.

HUNTING CASES CHANGED TO OPEN FACE.

OLD WATCH CASES REPAIRED AND RENEWED.

## Wendell & Co.,

2  
WONDERFUL SHOPS:  
103 & 105 William St.,  
NEW YORK.  
57 Washington St.,  
CHICAGO.

# New Claws on Diamond Rings.

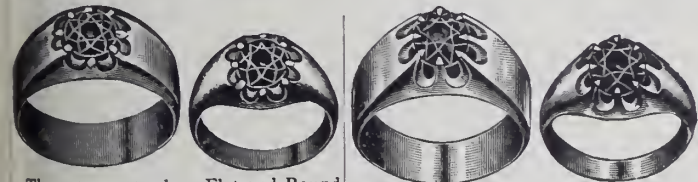

These two cuts show Flat and Round Belcher Rings as received, with claws badly worn off and too low to permit resetting stones again.

These cuts show the same rings with new high claws, stones securely reset, and entire rings refinished like new.

Price for six new claws, resetting stone and refinishing ring like new .....\$1.50 to \$3.00, list.  
Price for eight new claws, resetting stone and refinishing ring like new .....\$2.00 to \$4.00, list.

We retip or put new claws on diamond Tiffany, Belcher, Tooth and rings of every description, to cost from \$1.50 to \$4.00, list, according to the condition of ring and number of claws on setting.

## Wendell & Company,

103 and 105 William St., NEW YORK. 57 Washington St., CHICAGO.

For 22 years we have been doing

# Gold and Silver Plating.

Sterling and Plated Ware Repairing for the Trade.

Do we do yours?

Our plating rooms are the best equipped in the country for job work.



How It Came In.



How It Went Out.

### WE REPAIR

any article in the silverware line; making new parts to match the old ones that have been melted or broken off, the same as new.

### WE REPLATE

any metal article in gold, silver, nickel, bronze, brass, oxidized silver, old bronze, statuary bronze, and all antique finishes.

## Wendell & Company,

Repairers and Special Manufacturers for the Retail Jewelry Trade  
TWO WONDERFUL SHOPS:  
103 and 105 William Street, NEW YORK. 57 Washington Street, CHICAGO.



# Stone-Setting.

We carry a most complete stock of Precious and Semi-Precious Stones for special work and replacing lost sets. We import them direct from the cutters in Europe, and furnish them to the trade in single stones at dozen and gross prices.

Have your stone-setting done in our shops and save from thirty-five to fifty per cent.

We employ first class setters, and turn out work very promptly. No job too small to receive our careful attention.

## Gold Chains Refilled, Renewed and Repaired.

Old Chains made over into new patterns, using same gold.

GOOD WORK. LOW PRICES. PROMPT ATTENTION.



Sample Job as Received.



As Delivered.



Fancy Link Chain as Received for Renewing.



As Delivered.

## Wendell & Company,

The Special Manufacturers for the Retail Jewelry Trade.  
TWO WONDERFUL SHOPS:  
103 and 105 William Street, NEW YORK. 57 Washington Street, CHICAGO.





These illustrate a few of the dozens of New Patterns we



are making in our Pilot Cases for this Fall delivery



## The Wadsworth Watch Case Co.

CHICAGO  
Columbus Building

SAN FRANCISCO  
717 Market St.

NEW YORK  
49 Maiden Lane

FACTORY, DAYTON, KY.





Do the retail jewelers appreciate what they were paying for 12 Size movements before our 12 Size was on the market?

Do the retail jewelers appreciate what they were paying for O Size movements before our O Size was on the market?

Do the retail jewelers stop to consider what they would be paying for movements if there was not an independent watch company manufacturing a complete line of superior watches?

ILLINOIS WATCH COMPANY  
SPRINGFIELD



**S**ILVERWARE destined for the general service and adornment of the table should, in order to be wholly satisfying, possess not only a markedly decorative effect, but an opulent dignity and a well defined individuality of design.

¶ It is the belief of the Whiting Company that in their new Louis Quatorze pattern, which has been applied to every article suitable for table use, these essentials of success are very prominently displayed.

¶ With the confidence born of this belief, therefore, they beg to call attention to their novel and original treatment of one of the most popular, as it is one of the most effective, of historical styles.



**WHITING MFG. CO., SILVERSMITHS**  
 Broadway and 19th Street, New York.

## **Dueber Watch Cases**

### **Hampden Watch Movements**

“Dueber-Hampden” stands for honesty, integrity and consistency. Added to these qualities the talent and energy devoted to the development of

#### **DUEBER-HAMPDEN WATCHES**

have earned for them the enviable reputation of

## **The**

# **Leading American Watch**

Made in all sizes and sold only as complete watches in 3,0 size and 12 size, cased in solid gold and gold filled cases of the most artistic designs.

## **The W. J. JOHNSTON COMPANY,**

Wholesale Agents of the Leading American Watch Companies,

**Fifth Avenue and Market Street, Pittsburgh, Pa.**

# **The W. J. JOHNSTON COMPANY,**

Wholesale Agents of the Leading American Watch Companies,

**Fifth Avenue and Market Street, Pittsburgh, Pa.**

---

---

## **Hamilton Watches**

## **Illinois Watches**

Made to be sold by live, progressive, American Retail Jewelers who realize the credit to be gained from selling reliable, accurate time pieces.

---

---

Protection to the Retail Jeweler is the "watchword" of The Hamilton Watch Co and The Illinois Watch Co., and every effort will be made to restrict the sale of these watches to the Legitimate Retail Jeweler.

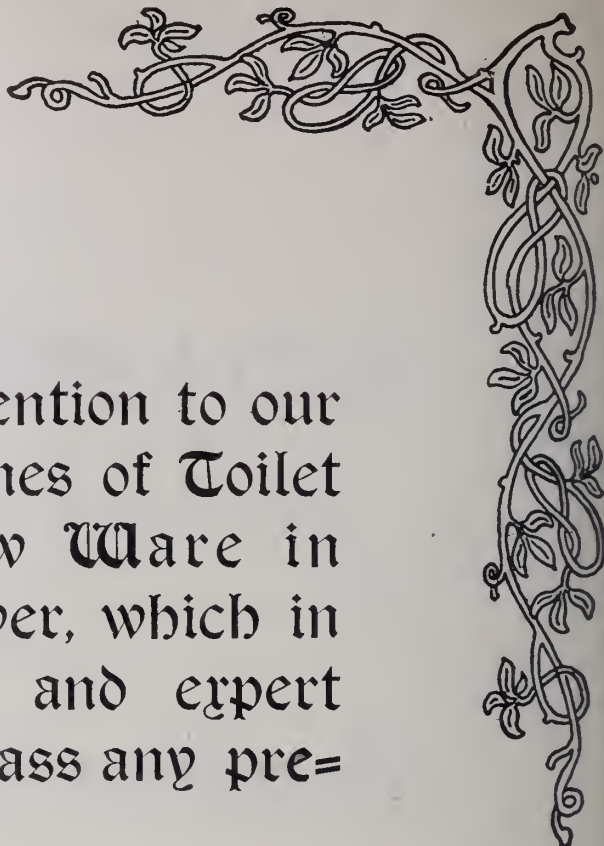

**W**E direct attention to our new fall lines of Toilet and Hollow Ware in sterling silver, which in artistic conception and expert craftsmanship surpass any previous display.

Owing to the novel character of our Toilet Sets we will be unable to show same until about July 20, but we are sure you will agree that these sets are a radical departure from anything heretofore attempted. They will be illustrated shortly on this page.

**Woodside Sterling Co.**

Silversmiths

192 Broadway, New York

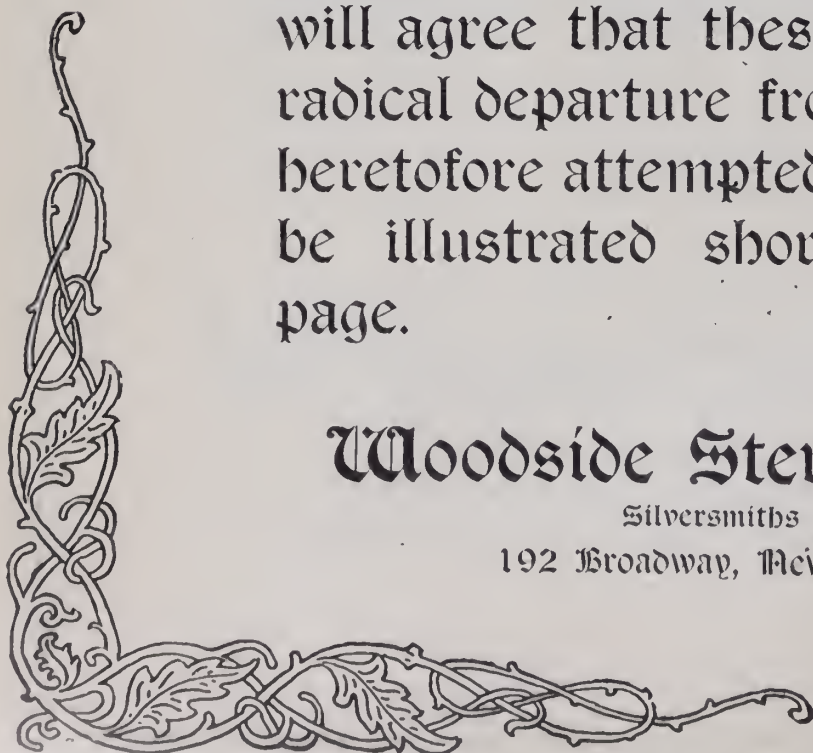



*"We never follow the Fashion, the Fashions Follow Us."*

MAURICE L. POWERS.



JOSH W. MAYER.

## INVITATION.

WE desire to say that in three weeks our exhibition of magnificent Jewels will be open to the Jewelers of this country. We extend a most cordial invitation to anybody that contemplates a visit to this city between August 13th and 18th, inclusive, to call and view this remarkable display.

We are at your service with information as to transportation and any reservation of rooms that you desire to make in this city.

The impressiveness and grandeur of this display will no doubt create such a feeling in your mind that you will regard our future exhibitions as one of your annual anticipations of pleasure and instructiveness.

One thing we can feel very positive about, and that is, after viewing this exhibition you will find it most important to view all our others.

Once a visit always a visit.

## POWERS and MAYER,

Makers of Diamond Mounted Jewelry THAT SELLS.

258-260 Fifth Avenue,  
NEW YORK.

We are always pleased to ship goods on memorandum when satisfactory references are given.

**In 1847**, or about sixty years ago, the three Rogers brothers, Asa, William and Simeon, discovered the process and began the electro-plating of spoons, forks, &c., in Hartford, Conn.

**Fifty-five years ago**, the Meriden Britannia Co. was formed by Horace C. and Dennis C. Wilcox, I. C. Lewis, W. W. Lyman, Lemuel J. Curtis, John Munson and James Frary at Meriden, Conn.

**Forty-five years ago**, the "Rogers Bros." business was moved to Meriden, merged with that of the Meriden Britannia Co. and goods made under the supervision of Rogers Bros. Imitations having appeared, "1847" was then made a part of the trade-mark to identify the genuine. **Up to ten years ago, no trade-mark used on silver plated ware (other than that used by this company) had a date as any part of it.**

**Forty years ago**, general advertising in daily papers and weeklies was commenced by the Meriden Britannia Co.

**Thirty years ago**, this company introduced sample boards on which were arranged spoon blanks in various stages, from the sheet metal to the finished article, showing "the evolution of a spoon."

**Twenty years ago**, a more general advertising campaign was inaugurated, and such publications as Youth's Companion and other household periodicals began to be systematically used.

**Thirteen years ago**, was originated the phrase "Silver Plate that Wears," referring to "1847 Rogers Bros." flat-ware and Meriden Britannia Co. hollow-ware. **This phrase has not apparently been improved by the many attempts of others.**

**Ten years ago**, assistance in the shape of electrotypes of complete advertisements was furnished the trade handling "1847 Rogers Bros." goods, and the importance of pushing a well-advertised line was demonstrated. Specimens of advertisements being used in general mediums were sent to the trade.

**Seven years ago**, the "drag test" was shown in a **copyrighted** booklet issued by the Holmes & Edwards Silver Co., **and a picture of the machine, and illustrations showing the results of the test, have been in continual use in their literature since that time.**

Most of these original ideas and plans introduced by us regarding trademarks, publicity, selling, etc., are now being used by makers of brands unknown five or ten years ago, simply confirming one of the best known and most widely quoted of the apothegms written by Caleb C. Colton in "The Lacon" during the early part of the Nineteenth Century.

#### INTERNATIONAL SILVER CO.

Meriden, Conn., July 18, 1906.

# SIMMONS EYE GLASS CHAINS

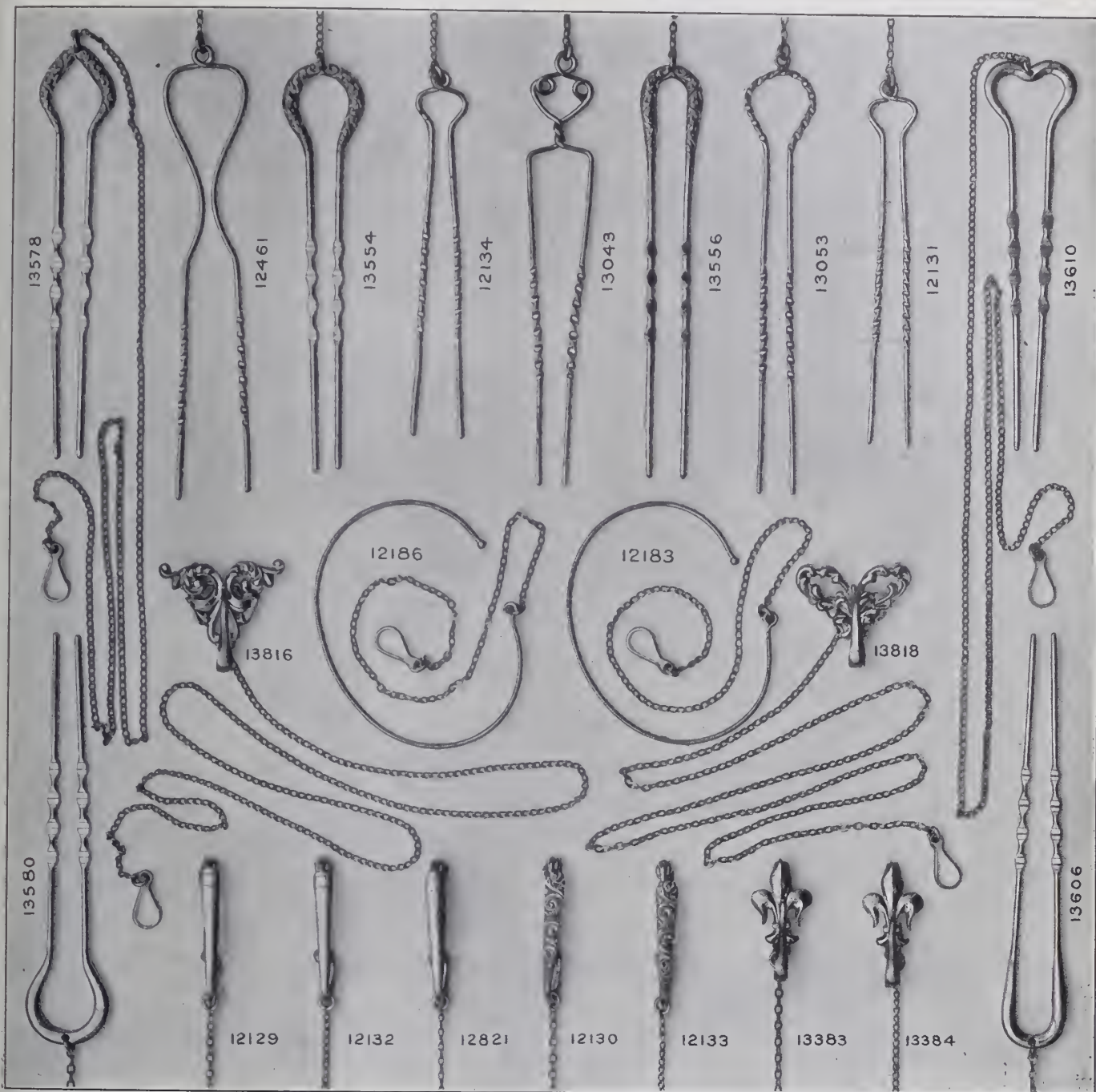

**S**IMMONS Eye Glass Chains are good, safe and sure sellers—  
 attractive, of high and dependable quality, absolutely guaranteed  
 —certain to afford all-round satisfaction to both dealer and customer.

Be sure to visit the Simmons Exhibit, if you attend the Rochester Convention; if you  
 don't—make it a point to see the Simmons line of Eye Glass Chains at your jobbers.

**R. F. SIMMONS COMPANY, Main Office and Works, ATTLEBORO, MASS.**  
 Salesrooms, 9-13 Maiden Lane, New York, 42 Madison Street (Heyworth Building), Chicago.



No. 929.

# The New 4 IN ONE ASH-RECEIVER FOR SMOKERS

This cut represents the Four-in-one Ash-receiver with parts separated. When the parts are nested, one complete ash-receiver is formed. It is especially adapted for a party of gentlemen who require more than one ash-receiver. Made in Brass, Nickel-plate, Copper and Silver-plate. Our catalogue of Smoking Articles sent on request.

*"If it Burns Alcohol, We Make it."*

New York Showrooms:  
Park Place, cor. Broadway,  
Opposite Post Office.

**S. STERNAU & CO.**  
*Makers of Coffee Machines, Chafing Dishes and Their  
Accessories, Fancy Kettles, Trays, Smoking Sets, etc.*

Office and Factory:  
195 Plymouth Street,  
Brooklyn, N. Y.

## The CLOVERETTE



The  
**Cloverette**  
(CLOSED)

PAT PENDING.



The  
**Cloverette**

(OPEN)

PATENT PENDING.

Every piece bearing  
**TRADE MARK**

A GUARANTEE FOR QUALITY AND FINISH

# Our Zimmerman Head

Made by **THE GUSTAVE FOX CO.**



**CINCINNATI  
OHIO**

We have had such unbounded success with the above Head that we have launched a mid-get size and are now manufacturing it in 3 sizes. Its beautiful appearance and high quality have placed it foremost in the line of Elk Jewelry. Look for our trademark



these Heads, send direct to

**The GUSTAVE FOX CO.,** 14-16 East Fourth Street  
CINCINNATI, O.

# Our Hagenbeck Head

The Head below was placed on the market several months ago and its success was instantaneous. Its appearance is lifelike, it being a reproduction of Mr. Hagenbeck's Prize Elk. Every



feature is perfectly modeled and its realism, fidelity to nature, artistic execution

and admirable adaptation to all forms of Elk Jewelry cannot be disputed. If your jobber does not carry both of

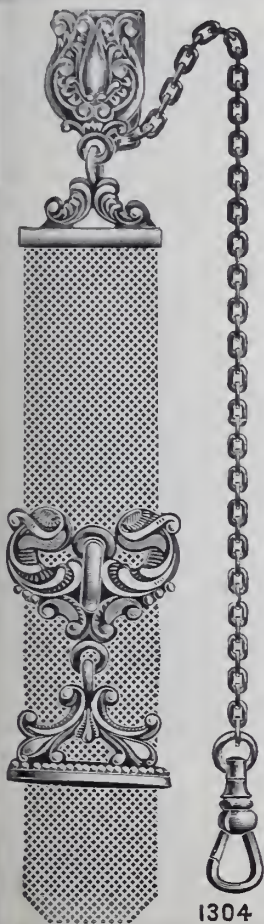

1304

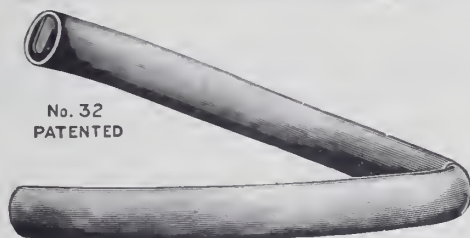

No. 32  
PATENTED

## The New "Bates" Bracelets

"Kant-Kum-Off"

Made in Seven Sizes

Ask your jobbers for THE BATES BRACELETS and you get the BEST



No. 43  
PATENTED

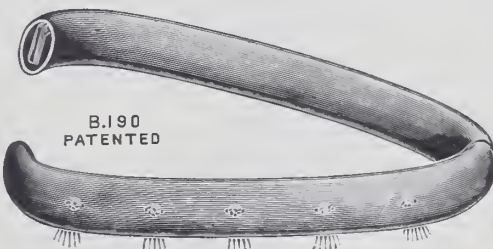

B.190  
PATENTED

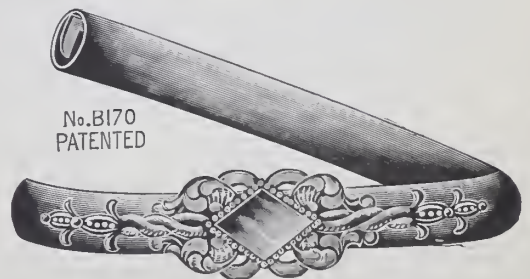

No. B170  
PATENTED

## BATES & BACON

Attleboro, Mass.

Makers of HIGH GRADE CHAINS

The BEST SAFETY FOB is one of our specialties; Gent's Vests, Dickens, Lorgnettes, Secret Locket Chains, Lockets and Chatelaines.

OFFICES:

NEW YORK,  
9 Maiden Lane.

CHICAGO,  
103 State Street.



TRADE MARK  
925-1000 Fine

## SMITH SILVERWARE



TRADE MARK  
925-1000 Fine

appeals to that class of buyers who appreciate *distinctiveness* and *quality*. Our line of Hollow Ware and Flatware embraces designs well known to the representative retail houses throughout the country.

### Frank W. Smith Co.

Manufacturers of Sterling Silverware  
Gardner, Mass.

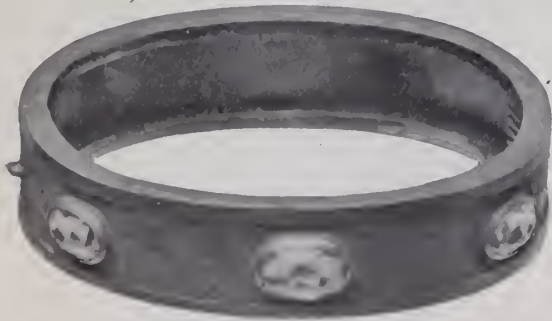

## THE Bracelet Hit OF THE Season.

THE illustrations, which are exact size, show two of the best selling Bracelets of a big bracelet season.

Made of Rolled Plate, Pierced, Engraved—a neat, strong joint and catch—with and without stones, from  $\frac{1}{2}$  to  $1\frac{1}{4}$  inches wide.

Our line offers an unsurpassed range of styles.

ASK YOUR JOBBER—HE HAS THEM.

**WHITING & DAVIS, Plainville, Mass.**  
NEW YORK OFFICE, 7 MAIDEN LANE.



# Tortoisene Combs

Mounted with 10-K. hand-work patterns. Every design is characteristic of originality and every detail is significant of superior workmanship.

*Tortoisene* is hard to detect from the real tortoise shell, having a rich effect that pleases the most skeptical in artistic hair treatment.

This cut represents a few of our patterns, actual size.

Combs will be much in demand throughout the year and orders should be in advance to insure prompt attention.

Prices on request.

## Schultz, Leiss & Co.

OFFICES

New York, 14 John St. Chicago, 103 State St.

FACTORY

Cor. McWhorter and Oliver Sts., Newark, N. J.



Cuff buttons always sell. Every man must wear them, consequently every man buys them.

We make a line so complete as to satisfy the most fastidious.

Hundreds of patterns in dozens of sizes. Mounted or unmounted.



- Locketts, Cigar Cutters, Fobs,
- Buttons, Penknives, Tie Clasps,
- Bracelets, Match Boxes, Heart Charms,
- Brooches, Scarf Pins, Bead Necks, Etc.

**10K. that is 10K.**

Send for Selection Package, Dept. C

Manufacturing Jeweler

Green and Columbia Sts., Newark, N. J.

# ROBT. LEVY,

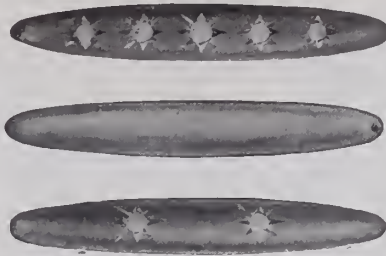

Quality and Finish Consistent  
with twenty years' experience.  
Original and Exclusive Designs.

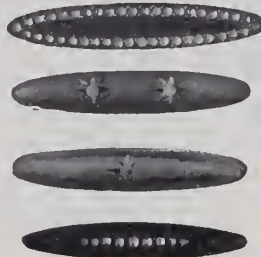

# MOORE & SON,

ESTABLISHED  
1886.

NEWARK, N. J.

INCORPORATED  
1903.



# BRACELETS

Carved,

Engraved,

Plain or

Mounted.

C. P. GOLDSMITH & CO.,

33-43 Gold Street,

NEW YORK.



# SIGNET RINGS



TRADE  MARK

Geo. O. Street  
& Sons

Est. 1837

24 John St., New York.  
103 State St., Chicago.

# ROSARIES



Of Foreign and our own Manufacture,  
\$2.40 per Dozen up.  
**SIGNET JEWELRY** A SPECIALTY.  
*Memo. Orders Solicited.*

**L. Witsenhausen**

47-49 Maiden Lane,  
New York.

Manufacturers of **MODERN JEWELRY**  
Chicago, 405 Masonic Temple.  
(L. KATLINSKY.)

THE CROMB PATENT SAFETY GUARD



For Scarf Pins. The most practical and only adjustable one invented. Price, \$1.50 per doz. For sale by all wholesale jewelers and material houses. Sample by mail, 25c. In 10k. gold, \$1.00; 14k., \$1.25. M. CROMB, Maker and Inventor 48 and 50 Maiden Lane, N. Y.



"GRIP"  
The King of all card games, price 25c; sample pack 16c., two 30c., eight \$1.00. Sent prepaid at once (only on receipt of price). See last week's issue of Circular for prices of my Ring Adjusters which every jeweler should have in stock. Order 1 doz. asst. Enclose the amount. Mention order No. J and I will forward a sample pack of grid extra. Order them to-day.

CHESTER H. WELLS, Jeweler, Meshoppen, Pa.



GOLD  
**RINGS**

BROOCHES AND MOUNTINGS

Also GOLD FILLED RINGS, including the popular THREE CROWN

Ostby & Barton Company respectfully announce to the jobbing trade that their fall line comprising many new and original designs is now ready.

OSTBY & BARTON COMPANY

New York, 13 Maiden Lane  
 Chicago, 103 State Street

PROVIDENCE, R. I.

**The Allsopp Rings**

THE UP-TO-DATE LINE OF

**SIGNET AND SET RINGS**



In twenty years we have built up a business second to none in Rings exclusively. ALLSOPP QUALITY, DESIGN and WORKMANSHIP appeal to the most fastidious. It will pay you to examine a selection package.

A ★  
 TRADE-MARK.

ALLSOPP BROS., ALLSOPP BUILDING, Newark, N. J.

**The Bowden Rings**

ARE COMPLETE IN VARIETY, CORRECT IN QUALITY AND PERFECT IN FINISH. WE MAKE EVERY VARIETY OF FINGER RINGS.

J. B. BOWDEN & CO.,

1 Maiden Lane.

NEW YORK.

# finest Mountings at fair Prices



EXPERIENTIA  
DOCET

THE REPUTATION of Durand Mountings reflects their decided superiority. Priced at lowest figures consistent with quality. For example:

Ring Mountings,	-	from \$3.75 up.
Sleeve Link Mountings,	"	6.00 "
Lorgnette Chain Mountings,	"	20.00 "
Brooch Mountings	"	6.00 "



EXPERIENTIA  
DOCET

**Durand & Company,**

49-51 Franklin Street,  
Newark, N. J.



TRADE **14** MARK

**OSMUN-PARKER MFG. CO.**

MAKERS OF

*Fine Pearl and Diamond Goods*

338 Mulberry Street

NEWARK, N. J.



Fancy Designs in  
*Jewelry* OF ALL KINDS.

Collarettes, Brooches,  
Scarf Pins, Buttons,  
Necklaces, Hatpins, Etc.

**A. J. Hedges & Co.,**

Makers of Exclusive Designs  
in 14K. Jewelry,

**14**  
**K.**

14 John Street, New York.

TRADE-MARK

ESTABLISHED  
1871.

Factory and Office: Newark, N. J.

INCORPORATED  
1900.

**CARRINGTON & CO.,**

*Patent Pocket Match Box*

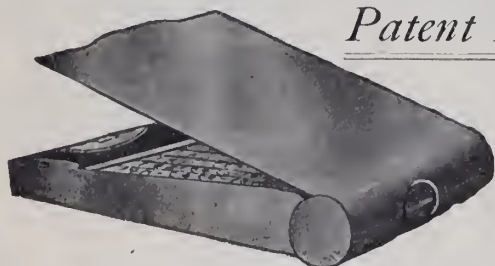

14K. ONLY IN STOCK.

Book Safety Matches with  
Steel Cigar Cutter.  
(Patented.)

**14**

Sale Agent:  
7 Maiden Lane,  
NEW YORK.

**18**

**SHAFER & DOUGLAS**

Ring Makers

**HAVE REMOVED**

their Office and Factory to

**9 & 11 Franklin Street, Newark, N. J.**

OPPOSITE NEW CITY HALL



**Adjustable  
Glove**

**Garters**

IN  
**GOLD AND SILVER**

**Gold Jewelry**

14K. in 10K.

Plain, Chased, Engraved, Diamond Set

**BRACELETS, BROOCHES,**

**LINKS, LOCKETS, ELK**

**BUTTONS, ETC.**

**Chas. L. Trout & Co.,**

15 MAIDEN LANE, NEW YORK.



## Some Glances Ahead

THE SATISFACTORY filling of your orders later, is preceded by painstaking preparation now.

There is no lowering of standards here from season to season. The quality of the past justifies high expectations for the future. These expectations will not be disappointed.

In a few days the Fall lines will be ready to reward your inspection, which is respectfully invited.

## Day, Clark & Company

14 KARAT  
ONLY



25  
Maiden Lane  
New York

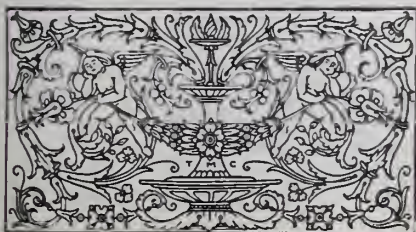

## WHITESIDE & BLANK Bangles



This house has now placed upon the market for their Fall trade a line of Bangles and Bracelets.

In this, as in their long established lines, the jewelry critic will find, both in character of design and unique mode of construction, features strikingly unusual when compared with anything heretofore shown in arm ornamentation.

*Platinum and Diamonds.*

*Rose Gold and Fancy Stones.*

NEWARK, N. J.,  
Lafayette and Liberty Streets.

NEW YORK,  
14 and 16 John Street.

ESTABLISHED 1841.

## Carter, Howe & Co.

TRADE



MARK

MANUFACTURERS OF

## Gold Jewelry,

9, 11, 13 MAIDEN LANE, NEW YORK.  
FACTORY, NEWARK, N. J.

A. CARTER.

G. R. HOWE.

W. T. CARTER

W. I. GOUGH.

## "THE BRACELET HOUSE." KENT & WOODLAND,

BRACELETS FOR EVERY WOMAN AND MISS.

16 John Street, New York.

San Francisco Office,  
Care JULIUS A. YOUNG.

"Nothersole Bangles,"  
Plain and with Stones.

"Pinhole" Secret Snap,  
with and without pre-  
cious and semi-precious  
stones.



# S. Cottle Co.

GOLD AND SILVER BAGS AND PURSES, NEW STYLES AND DESIGNS—ALL OF SUPERIOR WORKMANSHIP.

31 East 17th Street,  
New York.

## Bridesmaids' and Ushers' Pins

We would suggest something with color. Brooches, Scarf Pins and Handy Pins with Amethysts, Topazes, Garnets, Peridots, Aquamarines, Jades and Baroque Pearls. We have a large variety of patterns at moderate prices.

REGARDING OUR FOBS WE HAVE NOTHING TO SAY—THEY SPEAK FOR THEMSELVES.

## SNOW & WESTCOTT,

Makers of Good Jewelry for Over Seventy Years,

21 MAIDEN LANE, NEW YORK.

ADOLPH LUTHY.

## LUTHY & HINE,

PERCY W. HINE.

13 EAST 30TH STREET, NEW YORK.

MANUFACTURERS OF

### Artistic Gold and Platinum Mounted Diamond Jewelry.

Odd and Exclusive Patterns in NECKLACES, BROOCHES, BRACELETS, RINGS, RIBBON COLLARETTES, Etc.

MOUNTED WITH AQUAMARINES, PERIDOTS, AMETHYSTS AND OTHER PRECIOUS STONES.

(DIAMOND MOUNTED COMBS A SPECIALTY.)



12-in. high, \$19.50

## Supremacy in Silver Deposit Ware

Illustration shows our new Chocolate Pot, of Silver Deposited Frost Ware in Cobalt Blue. The design and workmanship of our line have never been equalled.

## Deposit Ware Exclusively

Representative Jewelers are invited to send for a selection of

FANCY BASKETS, CHOCOLATE SETS, WHISKEY JUGS, EXCLUSIVE NOVELTIES, ETC.

## DEPASSE MFG. CO.

41-43 Malden Lane, New York

## SAM'L BUCKLEY & CO.

English Fancy Goods.



Carry in New York a full line of ENGLISH PLATED WAITERS.

118-122 Holborn, E. C., London, England.

100 William St., New York.

## CROUCH & FITZGERALD



### Jewelry Trunks and Cases

177 Broadway, Bet. Cortlandt and Dey Sts.  
688 Broadway,  
723 6th Ave.,  
New York.

## DESIGNS For Silverware, Novelties and Jewelry . . . FINE ETCHING

Do not fail to have some etching in your line. We'll do the etching for you in first-class style.

CHARLES M. PRIOR (PHONE 1224 HARLEM) 1683 Madison Ave., New York



The Rosary  
In Fine Jewels

Fine Rosaries in pure and imitation stone. Mounted in solid gold and rolled gold-plate

ALL COLORS.

Our special illustrated catalogue will give interesting advice regarding prices and discounts.



MADE BY

The **W. J. Feeley Co.**  
Providence, Rhode Island,  
Ecclesiastical Art Metal Workers.

10K R 14K



**THE LOCKET HOUSE**

**ROTHSCHILD BROS. & CO.**

51-53 MAIDEN LANE, N.Y.

An Unlimited Line of Patterns of

- |                       |              |                  |
|-----------------------|--------------|------------------|
| LADIES' LOCKETS       | UNMOUNTED    | BROOCH MOUNTINGS |
| MEN'S LOCKETS         | MOUNTED WITH | LINK BUTTONS     |
| LOCKETS FOR EVERYBODY | DIAMONDS     | BRACELETS        |
|                       | OR ROSES     | RIBBON FOBS      |

**"TOPPY AND ORIGINAL"**

- |             |             |             |
|-------------|-------------|-------------|
| Bracelets   | A<br>&<br>V | Handy Pins  |
| Barrettes   |             | Scarf Pins  |
| Brooches    |             | Pendants    |
| Pearl Snaps |             | Collarettes |

**ALLSOPP AND ALLSOPP**

'PHONE 4075W

18 COLUMBIA ST.

NEWARK, N. J.



OUR BUYERS have just returned from European markets which they have ransacked in search of novelties for the jewelry trade.

Our line of FANS for the coming fall possesses such charm that it will satisfy the most exacting buyer.

We also present the latest Novelties in

- BROOCHES
- MOUNTED COMBS
- NECKLACES
- CHAINS
- BUCKLES, Etc.

A call at our show-rooms is imperative to a visiting buyer.

**LEWY & COHEN**  
IMPORTERS,  
530 BROADWAY, NEW YORK

**The Comb House**

We manufacture a complete line of

**FINE MOUNTED COMBS**

in 14 K., 10 K., Sterling Gilt and Gold Filled.

Also all kinds of PLAIN, REAL and IMITATION TORTOISE SHELL COMBS.

Selection Packages sent to Responsible Jewelers.

**Wagner Manufacturing Co.**

41 Union Square,

Repair Work  
a Specialty.

**New York.** Factory, Lorimer St. and Throop Ave., B'klyn, N. Y.

# TRIED AND PROVEN

## FOR 29 YEARS THE JEWELERS' LEAGUE

have been in continuous and successful operation. During this period they have paid to the beneficiaries of their members over

**\$3,134,000.00**

without disputing or compromising a single claim.

To-day, with adequate rates, they are in the full blast of vigor and prosperity.

Those desiring life insurance protection for their wives, or those dependent upon them, should investigate the new monthly table of rates, which offers maximum insurance at minimum cost.

**Death Benefits, - \$1,000 to \$5,000**  
**Age limit of applicants, 21 to 44 years**

For full particulars, address the Home Office, 12 John St., New York City

GEO. W. STREET,  
President.

F. A. MARSELLUS,  
Sec'y and Treas.

# COMBS and BRACELETS

WILL BE THE LEADING SELLERS THIS FALL



Those here shown are but a few of our complete line in both Gold and Filled. There is not a poor seller in our stock. Our line of

**Gold and Diamond Rings and Jewelry, Gold and Filled Chains, Festoons, etc.**

is more complete than ever before. A card to us will bring our representative to you when in your vicinity.

*Selection packages sent on request*

**JULES ASCHEIM**  
37 Maiden Lane, New York



## SOLID GOLD CHAINS

Gold Chains that don't have to first pay the heavy expenses of traveling salesmen, before a selling price is placed on them, are chains that to-day are interesting the careful and exacting buyer.

WE are the makers of just such  
**SOLID GOLD CHAINS**



Are YOU one of these careful and exacting buyers?

For 56 years critical Jewelers have found our Chains ready sellers, very profitable to handle and most durable in service.

We have no salesmen, and our prices are therefore very low. We will be pleased to send you a selection package.

1850 1906

**ALOIS  
KOHNS  
& CO.**

Makers of  
**SOLID GOLD  
CHAINS**  
of every kind.

16-18 Maiden Lane  
New York

## BRACELETS

In addition to my line of Mountings, Lockets and Buttons, I am making a full line of 10 and 14 K. Gold Bracelets.

Can make to order any style and size Bracelet at very short notice.

**M. SCHIFF,**  
82-84 Nassau St., New York.  
Established 1876. Phone, 801 John.

# The Salable MOUNTING



Pat. Oct. 24, 1905.

It gives light and brilliancy to the stone

- EARSCREWS
- EARRINGS
- STUDS
- SCARF PINS
- and RINGS

of every description made in Platinum, 18k., 14k., all sizes.

**Julius Wodiska**  
40 John St., New York

Manufacturer of a general line of

**PLATINUM**  
18k. and 14k.  
**MOUNTINGS**

Prompt attention given to special order work.

Estimates and designs submitted.

Diamonds recut and repaired.



## The Unquestioned Success of Our Line

*is no surprise to those who have seen it.*

*For many years there had been an opening for a very high-grade 10K. line, and we believe that we have satisfied the demand.*

*No finish like this, nor such designs were ever before seen short of high-grade 14K. jewelry.*

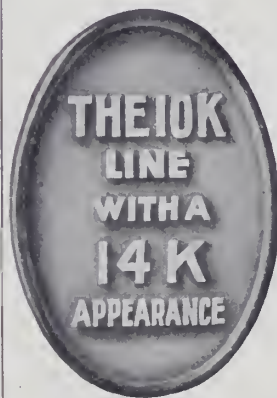

*Kohn & Co*

Camp and Orchard Streets, NEWARK, N. J.

## • HEINTZ BROTHERS •



• We Make the Largest Line of Solid Gold Set Rings in America for the Retail Trade •

# Koshland & Italic Co.

702 Chestnut Street,

PHILADELPHIA, PA.

¶ Not how **CHEAP**  
but how **GOOD** is the  
principle we follow  
in selecting the goods  
we offer for sale.

**Diamonds, Watches and Jewelry**

## ART and SENTIMENT or SIGNET PHOTO-LOCKET RINGS

as Manufactured by

**CHAS. M. LEVY**

90 William St., N. Y.

Send for Illustrated Catalogue of

**RINGS and LOCKETS**

Showing an  
Exclusive Line in

**Square Quality**



No. 1752.



No. 1710.



**DATTELBAUM & FRIEDMAN,**

Makers of Gold Rings of All Descriptions.

45 JOHN STREET, TELEPHONE 1347 JOHN, NEW YORK.

Our Trade-Mark "D.F." in all our Rings is the guarantee of quality.  
Send for Catalogue.



**D**AME Fashion is nothing if not strenuous. The vogue which bracelets have acquired is simply marvelous. No jeweler's stock is complete without a good assortment. It is what the majority of customers ask for to-day. We have been constantly increasing our line and show them in practically every style in which they are made—plain as well as set with diamonds and other stones. If you have a call for something particularly fine write us for selection. You will make the sale beyond a doubt.

**Henry Freund & Bro.**

"SELLERS OF SELLERS,"

71 Nassau St., New York.



"Our Trade-Mark"



"The Rose."

Elk and F. O. Eagle Goods  
a specialty.

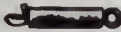

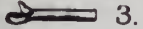
-  1. Snap complete.
-  2. Outside of Snap.
-  3. Inside of Snap.

## The E. P. H. Patent NON-PULL-OUT Neck Chain Snap

*Is a patented snap that insures the wearer against loss of*

**CHAIN or CHARM**  
for it positively will not pull out

Made in 10 and 14 Karat Gold and  
In Gold Filled.

Can be had of the following *Whole-  
sale Selling Agents:*

- Messrs. W. Green & Co.,  
81 Nassau St., New York.
- |                           |                   |
|---------------------------|-------------------|
| M. Sickles & Sons,        | Philadelphia      |
| E. A. Cowan & Co.,        | Boston            |
| E. & J. Swigart,          | Cincinnati        |
| Swartchild & Co.,         | Chicago           |
| Nordman Brothers,         | San Francisco     |
| Leonard Krower,           | New Orleans       |
| A. Walker Co.,            | Providence, R. I. |
| Bauman-Massa Jewelry Co., | St. Louis         |

### PRICES.

- 14 Karat—Small, \$7 per doz. net
- Large, \$7.50 per doz. net
- 10 Karat—Small, \$6 per doz. net
- Large, \$6.50 per doz. net
- Gold Filled—Small, \$2 per doz. net
- Large, \$2.25 per doz. net

## THE WASHBURN SECURITY MAGIC NUT

**Automatic Holder** for ear studs, scarf-pins, etc.  
for all sizes of scarf-pin wire. Guaranteed.



**EAR WIRES**  
for unpierced ears.



### SAFETY CATCH

For brooches, etc.  
Can be applied to any work where pin tongues are used.



Open.



Closed.



Open.



Closed.

Descriptive Circular on Application.

Pearl Drilling and Adjusting a speciality.

Special Order Work and Repairing.

C. IRVING WASHBURN, 12-16 John St., N. Y.

## ROBERT DULK, DESIGNER,

Etching in Gold and Silver,  
Telephone, 3960 Chelsea.

No. 70 5th Avenue, NEW YORK

# LOCKETS

Better Than The Best  
"VERIBEST"

We're proud to bring them right up front, proclaim them as our product by stamping each locket with our **Star Quality** merit mark.

Locketts of different designs, shape and size to satisfy all demands.

Look inside for  when buying.



Locket, Stone Set, Nos. 3968 and 3969. Locket, Plain, No. 3967

Each Locket stamped on the inside



Insist on "Star Quality," this Trade-Mark



MADE IN HIGHEST GRADE GOLD FILLED QUALITIES  
For the Jobbing Trade Exclusively.

## S. & B. LEDERER CO.

NEW YORK CITY  
9-11-13 Maiden Lane

Providence, R. I.  
100 Stewart St.

CHICAGO, ILL.  
131 Wabash Avenue

## EGYPTIAN PEARLS

—  
FINEST  
OF  
ARTIFICIAL  
PEARLS.

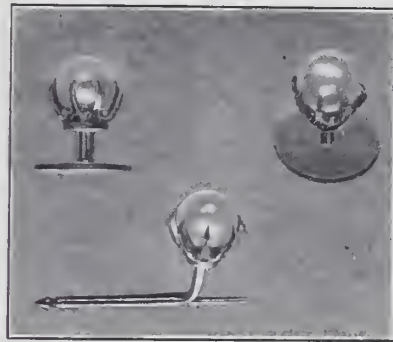

## EGYPTIAN PEARLS

—  
MOUNTED  
IN  
POPULAR  
JEWELRY.

THE PEARL has always symbolized Beauty and Value. Nature's product is most closely approximated in the handsome "EGYPTIAN" Pearls. The iridescence, weight and color of natural Pearls are retained; and inspection of the "EGYPTIAN" Pearls will demonstrate their pre-eminence. The results attained are possible only by a special process, supplemented by expert workmanship. The articles of Jewelry to which "EGYPTIAN" Pearls are applied are artistic creations meriting your attention.

## GEORGE H. CAHOONE COMPANY,

Makers of Artistic Jewelry,

PROVIDENCE—7 Beverly Street.

NEW YORK—9 Maiden Lane.

## LOCKETS ONLY

Satisfy your customers by using the recognized standard of excellence in this specialty

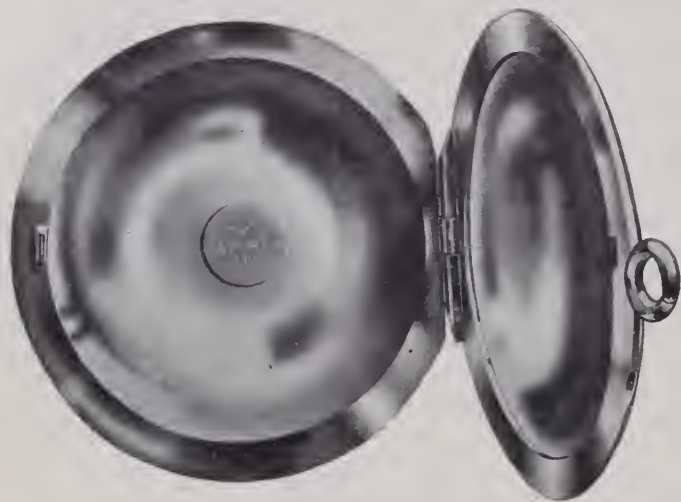

None genuine without **TRADE-MARK** stamped inside

ESTABLISHED FIFTY YEARS

**Wightman & Hough Co.**

New York Office  
3 Maiden Lane

Main Office and Factory { 7 Beverly Street  
Providence, R. I.

## ORDERS PROVE OUR GOODS SELL

We make for the Jobbing Trade the following lines of Solid Gold Jewelry :

*Rings, Scarf Pins, Studs, Brooches, Charms,  
Baby Pins, Handy Pins, Chain Sets,  
Link Buttons, Hair Barrettes,  
Crosses, etc.*

Insist upon seeing the designs of Gold Jewelry made by the

**E. L. SPENCER CO.**

95 Chestnut Street,

PROVIDENCE, R. I.

New York Office, 9-11-13 Maiden Lane.

SAMPLES ONLY.

**W**ait

**A**nd See

**I**n the "Celebrated Case"

**T**his Season's New Goods.

**E**very one a Seller

**T**here

**H**ave always been

**R**easons:—

**E**stablished reputation,

**S**taple Patterns,

**H**igh Quality,

**E**ndless Variety,

**R**ight Prices,

**'**  
**S**

**G**  
**O**  
**O**  
**D**  
**S**

**S**  
**E**  
**L**  
**L**

**Waite-Thresher  
Company**

61 PECK ST., PROVIDENCE, R. I.

7 Maiden Lane,  
NEW YORK.

1203 Heyworth Bldg  
CHICAGO, ILL.

# Crosses

are as popular as ever. The demand for them this year will be heavy.

See that your stock is complete by adding

The P. & B. Co.'s Line.

No stock is complete without THEM.

Waist Sets, full line.

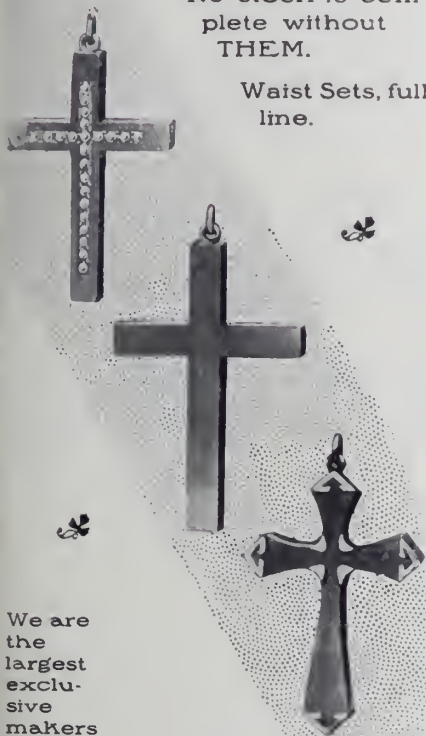

We are the largest exclusive makers of 10 karat jewelry

Ask your Jobber for the P. & B. Co. Lines of

Locket, Cuff Buttons, Tie Clasps, Scarf Pins, Baby Pins, Hat Pins, Bracelets, Brooches, Bead Necks, Fobs, Waist Sets and Crosses.

## Potter & Buffinton Co.,

Providence, R. I.

New York Office, 65 Nassau St.

San Francisco Office, 206 Kearny St.

Established 1855.

# ADAMS & SINGLETON,

Successors to BROOKS & PIKE,

Manufacturers of

## Fine Diamond Mountings.

Special Attention Given to Order Work.

364 Washington Street, Boston, Mass.

EVERYTHING IN LOCKETS AND CHAINS.

THE BASSETT JEWELRY CO.,

PROVIDENCE, R. I.



### The "Opera"

works with a spring and gracefully fits any wrist. Invisible joint, and the peer of all. The best seller of the season.

Made of gold plate, in all the popular finishes and sizes, with and without stones.

Ask your jobber to show you this new creation.

MANUFACTURED BY

## CASTIGLIONI & CAPALDI CO.

Successors to T. F. GREENWOOD CO.

9 Callender St. Providence, R. I.

Manufacturers of Novelties in Bracelets, Brooches, Hat Pins, Scarf Pins, Barrettes, etc., of highest grade, that defy competition

WM. SMITH & CO., Office, 9-13 Maiden Lane, N. Y. Factory, 61 Peck St., Providence, R. I.

Established 1854.

## GOLD AND SILVER CHAINS,

Gold, Silver and Plated Chain Trimmings, Also GOLD AND SILVER KEY CHAINS AND BRACELETS.

"Watch us" always for anything you wish in the "Watch" line.

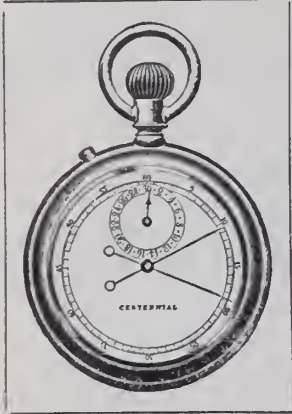

Timer is 1/8 Larger than cut



Timer is 1/8 larger than cut

THE OLD RELIABLE  
**Centennial**

SPLIT SECOND TIMER

"None better made"

Suitable for Racing and Mechanical Purposes.

**CROSS & BEGUELIN, Manufacturers, New York.**



**BROOCHES**

OUR new line shows many designs, highly artistic and attractive, that will prove rapid sellers. The highest class of workmanship is characteristic of all our lines.

- Combs Baby Pins
- Brooches Crosses
- Scarf Pins Waist Sets
- Bracelets Hat Pins
- Barrettes Collarettes
- Buttons Silver Novelties



TRADE MARK  
ALWAYS ON THE GO

LOOK FOR THE TRADE-MARK

**MILLER, FULLER & WHITING, MANUFACTURING JEWELERS**  
N. Y. Office, 9-11 Maiden Lane NORTH ATTLEBORO, MASS.



**Ladies' Fancy Stone Rings and Stone Scarf Pins in 10K. that defy competition.**

Our reputation for making the finest and most complete line of 10-K. gold band rings is still maintained—ask your jobber.

THE **EDWIN LOWE & CO., Inc.**

F.W. BODWELL, V.-Pres. and Gen. Mgr.,  
116 Chestnut St., PROVIDENCE, R. I.  
New York Representative, E. T. Wilson, 180 Bway.  
Western Representative, S. H. Brower.

**MR. RETAILER:**

Did you ever see a picnic party "hiking" for seats aboard an excursion boat? Well, that's the way the Watch Jobbers came at us this season for Solidarity gold cases. "Hide and Seek" will be the popular game this Fall, so far as our cases are concerned. You *won't* find them in the "job lot" trays—you *may* not find them in the "top trays," but insist on seeing the "SOLIDARITY TRAYS" and you shall have them.

**Solidarity Watch Case Co.**

ESTABLISHED 1885

GENERAL SELLING AGENTS  
JOHN W. SHERWOOD FRANK E. HARMER

**3 Maiden Lane, New York**



THE TRADE

desirous of keeping in touch with modern, profit-producing methods, should always consult the 500 pages of

OUR BIG CATALOGUE, with its 30,000 illustrations and long list prices. We send this splendid book free on request.

**S. F. Myers & Co.**

Headquarters for Lueber-Hampden Watches.

WHOLESALE JEWELERS

The New S. F. Myers Bldg. 476-49 Maiden Lane New York.

**THE PREMIER REPAIRING HOUSE OF NEW ENGLAND**

JEWELERS, SILVERSMITHS, STONE, METAL, SEAL ENGRAVERS AND INCRUSTERS.

LAPIDARIES AND DEALERS IN PRECIOUS AND IMITATION STONES

We Cut Stones

We Repair Stones

We Drill Stones

We Engrave Stones

We Incrust Stones

We Set Stones

**H. E. ALSTERLUND & CO.,**

387 WASHINGTON ST. AND 12 BROMFIELD ST., BOSTON, MASS.

All work positively Done in Our Own Factory.

Write us for terms and information.

35 Years Manufacturing

**CHAINS**

**S. & B. Lederer Co.**

11 Maiden Lane New York      Factory: Providence, R. I.      131 Wabash Ave. Chicago

**RINGS**

**WM. LOEB & CO.**

101 Sabin St.,

Providence, R. I.

New York Office, 37 Maiden Lane.

**WORLD BRAND SILVER**

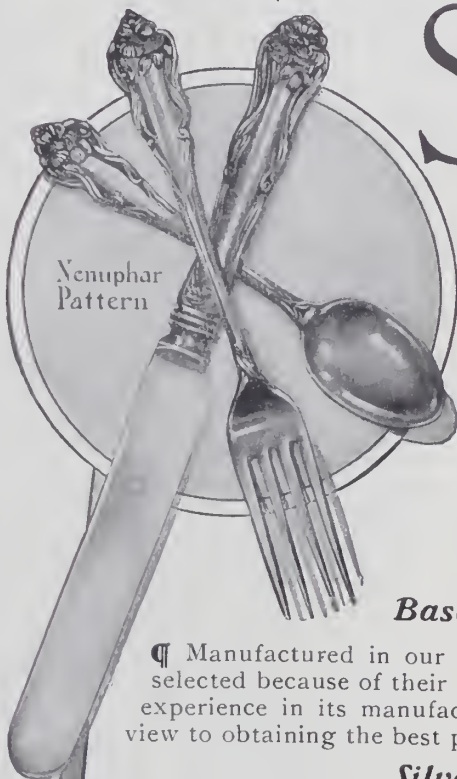

**Base Metal**

Manufactured in our own factory by workmen selected because of their knowledge and practical experience in its manufacture and use and with a view to obtaining the best possible results.

**Silver**

Not Less Than 50 per cent. heavier plate than the regular "Standard." Made in two grades, six and fourteen ounce plate.

**Designs**

Six fancy patterns—original in design and unexcelled in execution. Also four plain patterns.

**Prices**

As low as consistent with quality.

Write for catalogue and prices.

**THE AMERICAN SILVER COMPANY**

BRISTOL, CONN.

46 West Broadway, New York.

Silversmiths' Building, Chicago, Ill.,

**AT LAST!**



PATENTED

KEY RING,

Silver, \$9.00 Doz.

**KEY RING PROBLEM SOLVED!**

THE ring illustrated herewith does the trick. You can put on and take off one dozen keys in less time than you could take one off any other make. We can also supply patent key rings in 10 and 14K. gold.

See our fall line before you place your order for Sterling Silver, Picture Frames, Card Cases, the new style Pocket Book, Toilet Ware, Manicure Articles, Buckles, Match Safes, Child's Cups and other hollow ware.

**PRYOR NOVELTY COMPANY**

New York Office: 7 Maiden Lane

Factory and Office: 473-475 Washington Street, Newark, N. J.

**F&B**  
MADE IN U.S.A.



The  
**Gypsy**

Another of our new patterns in Toilet and Manicure goods.

Take particular notice of the new shape of Bonnet Mirror, which will be appreciated by every lady who uses one, it is so convenient. The regular shape can be furnished a little later if it is desired.

Our new line of Sterling Silver silk-lined Jewel Cases is especially attractive, and we are showing a great many Novelties which we will have illustrated in our new Catalogue, H, now in the hands of the publishers.

Owing to the phenomenal demand for

**"The Armlet,"**

the **F&B** invisible joint bracelet, it has been impossible to keep pace with the orders, but we now believe we shall soon be able to make prompt shipments.

See our full lines of gold-filled Locketts, Charms, Crosses, Pendants, Chains, Fobs, Neck Chains, Collarettes, Pins, Brooches, Earrings, Link Buttons, Scarf Pins, Hat Pins, Barrette Pins, Belt Pins, Waist Sets, Buckles, Hair Chain Mountings, Ribbon Book Marks and a large line of Sterling Silver Novelties.



# Theodore W. Foster & Bro. Co.

Manufacturing Jewelers and Silversmiths 100 Richmond Street, Providence, R. I.

New York Salesroom  
31 Maiden Lane

Chicago Salesroom  
Heyworth Building, Wabash Avenue and Madison Street

Canadian Salesroom  
350 King Street, Kingston, Ont.

## Diamond Mining in Brazil.

### United States Consul Reports on Alleged Frauds Perpetrated on American Public.

WASHINGTON, D. C., July 14.—Consul George E. Anderson, of Rio de Janeiro, reports that it is a little dangerous to generalize too much on conditions surrounding diamond mining in Brazil, but the activity of a number of promoters of such enterprises now in the United States, and the consequent increase in the number of inquiries received at that consulate-general, renders it necessary to lay down some general limits to the prospects of the industry. Mr. Anderson continues:

In offering general discouragement as to mining propositions, I wish to be understood as not reflecting upon all the enterprises now on foot to develop Brazilian mining properties. It is possible, and even probable, that some of them will result profitably, and the reports of mining experts on the country in general are such as to indicate that the country will probably some day produce great returns on mining investments. At the same time the country is full of schemes, which are either out and out frauds or which are based upon claims and facts so slight as to make them little less than frauds.

The United States and Great Britain, especially New York, Chicago and London, are the chief fields of operations for a number of promoters who have never done any mining but what they have done in these cities, and there are a number of so-called mining companies now soliciting stock subscriptions in the United States whose officers are not even certain where their property, or land they claim as property, lies. The president of a diamond mining company, having its offices in New York, wrote me a letter within the past week to ask how near a city of Brazil, near which his company claims property, was to a railroad. And yet this company is probably selling stock upon statements which give a most glowing account of the country in general, the special claims of this property in richness and accessibility, and other representations which are in no way true. On the other hand, there are several reputable companies in the field, the representatives of some of whom are in touch with this consulate-general, who are working claims in good faith and which may succeed. It is a notable fact, however—a fact which is certified to me by men who have had long experience in matters relating to the Brazilian mining fields, that not a single mining company operating in what is known as the gold and diamond fields of Brazil has paid a dividend. There may be exceptions to this rule, but as yet I have been unable to locate them.

#### INACCESSIBILITY OF MINING REGIONS.

Assuming that a mining enterprise having property or claiming to have property in Brazil is pushed in the United States or elsewhere in good faith, there are several elements to be considered in addition to those which may be said to exist in all mining enterprises. Chief among these, perhaps, may be cited the special difficulties attending operations in a tropical, mountainous country where there is no railway

communication with the mining country for distances representing from 5 to 50 days' journey on mule back. The reports of mining experts indicate that there are diamonds and there is gold to be found in a large territory in Brazil. The diamonds, however, are not found as they are in South Africa in certain large pockets or pipes, the structure and working of which is so well understood. In Brazil the diamonds are found in small pockets covering perhaps many thousand square miles of territory. Little of this territory has been worked with modern machinery, but enough of it has been worked with modern machinery to establish certain facts.

The first of these facts is that it is impossible to count upon the value of a property by preliminary surveys or guesses by engineers. The second is that practical mining operations in the Brazilian field must be done with machinery which can not only be readily transported in parts or otherwise on mule back to the first point of operations, but which can later be changed about readily in rough country, in unfavorable rainy seasons, in a country without roads, bridges, supplies or anything else in the way of conveniences of civilization. It is evident that when one of these small pockets are worked out it must be practicable to move the plant elsewhere at a minimum cost to try fortune in a new pocket. It is evident also that this involves large expenditures, and large capital is required to work such properties. Assuming that a company is formed in good faith, that it owns the property in the diamond country it claims it owns, and that it is managed not only by honest men but by men who know their business, it is evident that many thousands of dollars must be expended before the owners of the property know whether they really have anything or not.

#### UNCERTAIN LAND TITLES.

Another great trouble in these enterprises is in the fact that there is constant litigation over the matter of titles to land in this country. Brazilian mining laws are very incomplete and unsatisfactory. Immense quantities of land can be had in the mining country for very little money; but generally it so happens, as soon as anything valuable is discovered or developed upon the land taken, that some one else has a prior claim to it, and the company or individual whose energy has developed this value either is robbed of the fruits of energy and expenditure of capital or is compelled to fight for them at an additional expenditure of both. One of the most reliable American concerns now working up country has been compelled to cease work within the past month under an order from a Brazilian court. This company leased certain mining country from a company which claimed to own it and which was able to establish a good prima facie title. It went to work, established its machinery, and was fairly successful in work. It now appears that the company from which it leased its property bought the property from certain parties for a certain sum of money and certain stock; that this stock is in a company which has not been properly registered, and is therefore worthless under Brazilian law, and that therefore the

original owners now want the property, which has been shown to be more valuable than it was when first sold. In the meanwhile the American concern has idle men on its hands, costly machinery idle, and its sole efforts are being devoted to securing what it thought it already possessed.

#### POINTS TO BE GUARDED.

I think it fair to say, generally, that there should be no investments in mining enterprises in Brazil which do not provide—

First, a large amount of actual cash for capital for prospecting the proposed country. General assurances, even from mining engineers of repute, under Brazilian conditions are good only for a speculation or a gamble as to whether paying property can be struck. There are no "snaps" to be handled with small capital.

Second, a careful investigation, not only of the country to be worked, but of the title to any and all property to be acquired. A requirement of this sort ought to be unnecessary with sensible business men, but the present situation in mining affairs in Brazil demonstrates that there is special need of a warning on this point.

In all this there is especial need of an investigation of the good faith of the mining proposition under consideration. It is a lamentable fact that a large proportion of Brazilian mining enterprises are frauds, and that there are men now in the United States with enterprises which represent nothing more than the money they can get from the American public.

#### Wm. B. Durgin Co. Purchases Business of Goodnow & Co., Boston, Mass.

Boston, Mass., July 20.—It has just been authoritatively announced that the business of Goodnow & Co., silversmiths, 38 Stanhope St., has been purchased by the William B. Durgin Co., Concord, N. H., and that probably the factory will be removed from Boston to the Durgin plant at Concord.

In this connection it will be recalled that the firm of Goodnow & Co. succeeded Goodnow & Jenks, and that Mr. Jenks, of the latter firm, is now the president of the Wm. B. Durgin Co., so that the purchase of this business will place Mr. Jenks in a position to renew his old connection with this line.

The business just bought by the William B. Durgin Co. was established in 1893 by Walter R. Goodnow and Barton B. Jenks, Mr. Goodnow having previously been a member of the firm of Bigelow-Kennard & Co., while Mr. Jenks was an experienced silversmith. The firm continued without change until the dissolution caused by Mr. Jenks becoming the president of the Durgin concern. Since that time Mr. Goodnow has continued the business alone.

As Louis O. Stevens, Macon, Ga., was crossing the railroad tracks of the Central Railroad of Georgia, something happened to the machine and the vehicle stopped with the rear wheels between the rails on which a freight train was approaching. In order to save his life, Mr. Stevens was obliged to jump from his automobile, which was a few moments later struck and wrecked by the train.

# STRAIGHT TALK

We want to do business with every wide-awake retail jeweler of good standing in the United States.

We know that our various lines of gold jewelry are unquestioned as to quality, price and construction.

Therefore we do not hesitate to stamp our registered Trade-Mark on every piece as a guarantee of the above facts.

We make rings for man, woman and child. All kinds of 14k gold sleeve buttons, lockets, Larter shirt studs and Larter vest buttons.

If our travelers do not reach you, may we send you the Fall edition of the Larter Gold Book now in process of publication? A postal will bring one.

4  
over  
40  
years  
Ring Makers

Larter & Sons

21-23  
Maiden Lane  
New York



Registered Trade-Mark.

## A Notable Gold Racing Trophy of the Early Part of the Last Century.

A RACING cup that dates back to the early days of the turf in the United States is now on exhibition at the Gorham Co.'s store, Fifth Ave. and 37th St., New York. This is said to be the only gold racing cup in existence, commemorating the glories of horse racing in South Carolina in the early part of the last century. It was awarded, as indicated by the inscription, at the "Charleston, South Carolina, races, Feb., 1820," to Colonel Richard Singleton, whose racer, "Kosiesko," defeated "Mark Anthony," a horse belonging to a Mr. Richardson. Since then the cup has remained continuously in the Singleton family. From Colonel Singleton it descended as an heirloom to his daughter, Angelica Singleton, who became the bride of Major Van Buren, a son of President Martin Van Buren. She was one of the noted brides of the White House, and later, upon the death of the President's wife, became the mistress of the mansion. From Mrs. Angelica Singleton Van Buren, the cup passed to General James W. Singleton, and from him to the present owner, James J. Singleton.

Several weeks ago, Riley Bros., Buckingham, W. Va., were instrumental in getting the owner's permission to have the cup publicly exhibited, and it was for some time shown at their store, whence it was brought to New York.

The cup bears the names of the makers, Rundell, Bridge & Rundell, "auriferes to the Prince and Princess of Wales, London, England." The hall mark shows the cup's quality and indicates that it was fashioned in 1812 and finished in 1819.

The cup is of simple construction with handles and a cover. On one side is represented a racing scene in which three horses and riders are contesting. On the other side is the inscription.

### Death of Benjamin F. Watts.

ANN ARBOR, Mich., July 18.—Benjamin F. Watts, ex-city treasurer and former coroner, who died of apoplexy Friday last, was well known in the jewelry trade, having followed his craft for over half a century. The funeral, which was held Sunday, was largely attended, and was under the auspices of the Masonic fraternity, in which Mr. Watts had long been prominent.

Mr. Watts was for many years manager of the jewelry store of his brother, J. C. Watts, and succeeded the latter as proprietor to the business in 1882; four years later he sold out to J. C. Watts & Co., and from that time he devoted his almost entire attention to repair work, in which he was noted for his skill and ability. Outside of his work in the jewelry trade his principal interests were in Masonic work, and in this fraternity he had risen very high, having been elevated to the office of Grand High Priest, of the Grand Chapter of Michigan, in 1882.

He is survived by a widow and a son, W. W. Watts, of Detroit.

J. M. Davis, Waynesville, N. C., has just completed extensive improvements in the exterior of his store.



**Dr. George F. Kunz's Report.**

**Production of Precious Stones in 1905**  
 Published by the United States  
 Geological Survey.

[The publication of this Report was commenced in THE JEWELERS' CIRCULAR-WEEKLY, July 18, 1906, and will be continued in this and succeeding issues until completed.]

**NEW YORK.**

*Diamonds in Drift.*—In the article of Prof. William H. Hobbs, on "The Diamond Field of the Great Lakes," published in 1899,<sup>1</sup> emphasis was laid on the desirability of careful search for diamond occurrences on the moraine line east of Ohio—in Pennsylvania and New York—as a further guide to locating the original northern starting point. No similar discoveries have since been made, except those in central Indiana, until recently a report has appeared of one or perhaps two diamonds being found near Syracuse, N. Y. An account of these and a discussion of the bearings of the whole subject were given by Philip F. Schneider, of that city, in the *Syracuse Herald*<sup>2</sup> of Dec. 24, 1905. The topic had been presented previously, by Mr. Schneider and others, at the October meeting of the Onondaga Academy of Sciences. Unfortunately the facts are not capable of positive proof at the present time. The owner of the gravel-pit in the southern part of Syracuse claims to have found a diamond therein several years ago and to have subsequently sold it for \$1,700 to a person living at Springfield, Mass. The purchaser has since died and his relatives are in Europe, so that it is not possible at present to verify the account. The same owner also reports finding another smaller diamond, which he still retains; but Mr. Schneider questions its reality, and suspects it to be only a quartz crystal.

The geological interest of such an occurrence and its inherent probability in connection with the western diamonds of the drift make these unverified reports worth recording.

In Mr. Schneider's article he also treats of the possible relation of these diamonds, if such should prove to be, with the peridotite dikes in and around Syracuse. It will be remembered that this rock, altered to serpentine, was identified by the late Prof. H. Carvill Lewis with the rock at Kimberley, South Africa, and with that in Elliott County, Ky., all three being included under his name of kimberlite.

This close relationship to the South African diamond-bearing rock has led to speculation and may lead to possible diamond production at the Kentucky and the Syracuse localities, especially as both these latter have yielded pyrope garnets similar to those freely obtained at Kimberley, and there known as "Cape rubies." No diamonds, however, have been definitely found as yet at either of the American kimberlite occurrences; but if any should really be obtained near Syracuse, the question may be raised whether they are derived from the drift or from the kimberlite dikes of the vicinity.

**CANADA.**

*Search for Diamonds.*—Dr. H. M. Ami, of the geological survey of Canada, has given careful instruction to 100 or more parties that are surveying for the Transcontinental Railroad, immediately north of the Great Lake region, how to look for the diamonds in the hope of their locating the source of the diamonds which have been found in the glacial deposits of Wisconsin, Michigan, Ohio and Indiana.

**SOUTH AFRICA.**

*De Beers Consolidated Mines.*—The most prominent feature in the 17th annual report of the De Beers Consolidated mines, for the year ending June 30, 1905, laid before the meeting of the shareholders at Kimberley, in November, is doubtless the retirement of Gardner F. Williams from the office of general manager, which position he has held and administered with signal ability and success for the last 19 years. He has for some time desired to be relieved from the cares of his position, and he will now be succeeded by his son, Alpheus F. Williams, who has been assistant manager for several years, is thoroughly familiar with the situation, and has ably conducted the working of this great mine in the several absences of his father in the United States.

In regard to the output of the year, it presents no very marked differences from that of the year 1904. There is some advance in total production, due to the increasing yield of the two newer mines, the Bultfontein and the Dutoitspan; but the old mines show a continued falling off. On the other hand, the Bultfontein and Dutoitspan have developed a sudden advance in richness, the yield per load of these two mines taken together being some 40 per cent. above that of the year before. The other mine, previously known both as the Premier and the Wesselton, remains about the same in rate of production. This mine is spoken of in the present report only as the Wesselton, the name Premier being apparently discarded, and wisely so, in view of the prominence assumed by the great Premier mine near Pretoria in the Transvaal.

The combined data for the De Beers and Kimberley mines are as follows:

**PRODUCTION OF DE BEERS AND KIMBERLEY MINES IN 1904 AND 1905.**

	1904.	1905.
Loads of blue hoisted.....	2,440,895	2,447,850
Loads of blue washed.....	2,401,099	2,418,158
Carats of diamonds found <sup>1</sup> ..	1,303,525	1,108,980
Value of diamonds found <sup>1</sup> ..	£3,192,798	£2,929,589
Number of carats per load..	0.54	0.46
Value per carat <sup>1</sup> .....	48s. 11d.	52s. 10d.
Value per load <sup>1</sup> .....	26s. 7d.	24s. 3d.
Cost of production per load <sup>1</sup> ..	7s. 4d.	7s. 8d.
Loads remaining on floors...	2,175,079	2,204,771

It will be seen from these figures that the continued rise in value has again failed to counteract the decrease in richness, as shown by the diminished value per load. The quantity of blue ground reported as in sight in 1904 in these two mines was 9,987,908 loads; in 1905 it was 8,026,400 loads—a decrease of about one-fifth.

Of the three newer mines the Wesselton furnished the maximum quantity of blue ground, 2,068,278 loads; and it yielded also one diamond of 187½ carats, the largest yet found in this mine. The Bultfontein leaped from a yield of 0.29 carat per load in 1904 to an average of 0.41 in 1905. This yield rose further during the latter half of the year, and a test from the east end of the mine area gave, in 32,122 loads, an average as high as 0.523 carat. The Dutoitspan mine more than doubled its former average yield, having risen from 0.12 to 0.26 carat per load. In quality the diamonds from this mine are far above those from any other. All three are still worked more or less as open mines.

The data for these mines for the last two years are as follows:

**PRODUCTION OF THE WESSELTON, BULTFONTEIN AND DUTOITSPAN MINES IN 1904 AND 1905.**

	Wesselton.		Bultfontein.		Dutoitspan.	
	1904.	1905.	1904.	1905.	1904.	1905.
Loads hoisted.....	1,919,304	2,068,278	429,729	605,730	39,914	311,499
Loads washed.....	2,134,903	2,032,582	514,385	611,491	24,359	65,784
Diamonds found (carats) <sup>1</sup> ..	605,241	578,152	148,219	249,002	3,032	17,121
Value of same <sup>1</sup> .....	£1,055,269	£1,067,475	£219,711	£434,902	£6,457	£59,847
Carats per load.....	0.28	0.284	0.29	0.41	0.12	0.26
Value per carat <sup>1</sup> .....	34s. 10d.	36s. 11d.	29s. 7d.	34s. 11d.	(?)	69s. 11d.
Value per load <sup>1</sup> .....	9s. 10d.	10s. 6d.	8s. 6d.	11s. 2d.	(?)	18s. 2d.
Cost per load <sup>1</sup> .....	3s. 7d.	3s. 10d.	5s. 9d.	5s. 10d.	(?)	12s. 3d.
Loads on floors.....	1,356,260	1,391,956	397,503	391,742	15,555	261,270

<sup>1</sup>Fractions of pounds, carats and pence omitted or approximated. <sup>2</sup>Data not given.

The quantity of blue ground in sight at these mines was estimated as amounting to 51,300,300 loads. This amount being added to that given above for the De Beers and Kimberley—8,026,400—the entire total foots up 59,326,700 loads. Beyond this, however, there are of course the unexplored resources of the three newer mines which have only been opened to depths from one-fourth to one-third those of the older mines.

The recovery of diamonds from tailings and debris has continued, though on a scale somewhat less than in the previous year, which was the maximum. In 1905 1,616,030 loads were washed, mostly from the De Beers mine, and there were obtained 257,059 carats of stones, valued at £311,030.

Even with the higher rate realized for rough diamonds, the earnings of the De Beers Co. were 15 per cent. less than in 1903, as the average yield of rough diamonds from the De Beers and Kimberley mines has fallen from 0.76 carat per load in 1902 to 0.61 carat per load in 1903 and to 0.46 carat per load in 1905. Great quantities of the poorer diamond earth were treated. The total sum re-

alized from the sale of diamonds was £4,802,844; the expenditures were £2,937,509; the profits were £1,865,335. Out of the profits £1,800,000 were paid in dividends, the dividends being 20s. per preferred share as against 27s. 6d. in 1903 and 1904. The reserve was \$846,783. The entire sales in 1905 were made "rough" by the syndicate, and this is to continue in 1906, on account of the lower yield and on account of the great demand. This is in spite of the fact that the price of rough stones was raised twice, five per cent. each time, during the year 1905; but the diamond syndicate makes these advances because there are less diamonds found to-day than there were found 15 years ago, while the demand for them has greatly increased.

*Premier (Transvaal) Mine.*—The increased output of the Premier (Transvaal) mine has caused great interest in the production of diamonds and the finding of the largest known diamond, the Premier or Cullinan, weighing 3,024 carats, and of several other large stones, one of which weighed over 600 carats and another 340 carats, has given this mine the greatest record for producing material of exceptional size.

*Orange River Colony Mines.*—The extensive development of diamond mining in the Orange River Colony is well shown in the Annual Report of the Mines Department of that Colony for the year ending June 30, 1905. This report, by Burnet Adams, acting chief inspector of mines, tells of steady increase in the diamond output of the colony and describes the condition of the producing mines, besides the Vaal River alluvial diggings, and of more than 50 prospects and partially developed undertakings. In regard to these latter, many have proved disappointing, but some have yielded good diamonds and may prove to be valuable properties.

The seven mines that have actually yielded more or less successfully are (1) the New Jagersfontein (the old celebrated mine reorganized under the new government); (2) the Koffyfontein; (3) the Ebenhaezer; (4) the Lace Diamond Co.; (5) the Monastery; (6) the Kaalvallei; (7) the New Driekeopjers. Of these, the last is now closed and for sale, and two or three of the others are partially suspended and either engaged in testing or in awaiting improved appliances. The Jagersfontein is much the most important and has been steadily advancing, both in equipment and in production. Heretofore it has been carried on as an open working, but steps are now being taken to change to the underground system, as was done with such success in the De Beers and Kimberley mines.

The diamond output of the colony for the year

covered by the report is given in a tabular form by months, from July, 1904, to June, 1905, inclusive. These show some variations, but maintain a fairly uniform average. The product is given as a whole, without distinguishing the mines, but the Jagersfontein far exceeds all the rest together.

**OUTPUT OF DIAMONDS IN ORANGE RIVER COLONY, FISCAL YEAR ENDING JUNE 30, 1905.**

Loads washed.....	3,556,000
Carats of diamonds found.....	320,548½
Value of same.....	£938,617, 15s. 6d.
Carats per load.....	0.0899
Value per carat.....	58s. 8d.
Value per load.....	5s. 3d.

Subsequent data for the month of July, 1905, show but slight differences from the average of the month preceding. The cost of mining per load is not given in the report.

(To be continued.)

J. E. Eckert, Marengo, Ia., has bought F. B. Downard's stock of jewelry, and will consolidate it with his own.

<sup>1</sup>Jour. Geol., Vol. 7, No. 4, May-June, 1899.

<sup>2</sup>Syracuse Herald, Dec. 24, 1905.

<sup>1</sup>Fractions omitted or approximated.

# OLD RELIABLE W. & S. B. ★

We extend our greetings to the members of the American Retail Jewelers' Association and the American Association of Opticians, as they assemble in convention.

In view of some matters that are to be considered at both conventions, we offer the following suggestions:

Don't waste valuable time reflecting on the inroads made in your business by Department Stores and Retail Mail Order Houses. Buy the Old Reliable line and avoid this kind of competition. Our Old Reliable W. & S. B. ★ 1-10 and Globe Filled W. & S. B. ★ 1-8 chains are not sold to either Department Stores or Retail Mail Order Houses.

Bunch your buying. If you buy a little here and a little there you gain the regard of no one and your account has no value. Concentrate your purchases on the Old Reliable line and participate in the opportunities offered by our premium plan.

We invite your inspection of Old Reliable goods at our booth in the exhibition hall. We shall have some special things to show you and a very interesting booklet for you to read.

Old Reliable W. & S. B. ★

---

## W. & S. BLACKINTON CO.

Manufacturers

NEW YORK, 14 Maiden Lane

Factory, North Attleboro, Mass.

Let us send a selection package through  
any jobber you may designate.

## London Letter.

LONDON, July 12. I recently referred to the inaugural meeting of the British Watch and Clock Makers' Guild, and incidentally to the fact that the National Association of Goldsmiths was not represented thereat. At the annual convention and reunion of the association which was recently held at Glasgow the question came up as to the position of the N. A. G. with regard to the newly formed Guild, and while the retiring president and the organizing secretary stated that they had no objection to the new society, it was quite evident from the remarks passed by both that they felt a bitter antagonism. As a result, a very long discussion took place, and in the end, and only after very hard pressing, the executive agreed to meet representatives of the Watchmakers' Guild.

\*

The convention was, viewed from the business standpoint, a dead failure. A number of items were placed upon the agenda with no other object, apparently, than that of creating trouble and friction. One most important matter, that of the hall-marking of foreign watches, was simply referred to in the report, and Mr. Steward, the editor of the *Watchmaker*, endeavored to draw the sub-committee on the subject. At last year's convention the National Association of Goldsmiths passed a unanimous resolution to the effect that they were in entire agreement with the decision of Justice Channell, viz., that watch cases containing movements, coming into Great Britain, were not plate within the meaning of the act, and were, therefore, not within the law which compels all plate, British or foreign, to be sent to the British assay offices to be marked. From facts which had come to the knowledge of Mr. Steward it would appear that the sub-committee had overridden the unanimous decision of the annual congress, and had informed the Worshipful Company of Goldsmiths that they disagreed with Justice Channell's decision, and yet they refused to inform the annual congress at Glasgow what steps they were taking, after having had a clear mandate to uphold, in every way, the judicial decision of Justice Channell.

The National Association of Goldsmiths has undoubtedly done a considerable amount of good work, but it has been a one-man business and many of the members are beginning to "kick over the traces." Certainly his autocratic actions have brought him into trouble with several members of his executive committee, while his attempt to run his own nominees for the vacant executive places being frustrated by the nomination of two Scotch members, and their being elected at the top of the poll, shows him that he cannot hold the same respect which for so long had been accorded the honorable organizing secretary; and as I write I learn that Thomas Field, the organizing secretary, is declaring that he will not be dictated to and, consequently, is resigning his position, but as he has threatened this for a number of years past, few take him seriously.

However, the position is a very acute one, and, viewed from a democratic standpoint, a very serious one; for it is obvious that an association which is "bossed" by one indi-

vidual cannot last very long, and with the dissatisfaction expressed on every side unless something of a radical nature takes place the National Association of Goldsmiths will come to an end.

\*

There is being produced at Barkentien & Krall's, Regent St., W., a very handsome altar which is destined for one of the big churches in Philadelphia. It is being made to the order of Mr. Wanamaker. It is just seven feet long by three feet two inches deep, and has for its central feature a finely modeled figure of the Madonna and Child. This is flanked on either side by four columns which consist of six series of smaller columns or pillars, all different, each of which is filled with a Biblical figure, making in all 144 separate figures, each bearing a name. The pillars are all hand made. Between the columns are 12 modeled panels representing Biblical parables and subjects, as, for instance, the Annunciation, the Turning of Water into Wine, etc. In the capitals of the columns are angels kneeling in various positions, each holding a different mystical instrument. The eight columns are bifurcated by a band which runs round, and is set with a variety of precious stones, each one being in a gold setting. The whole is of silver, weighing about 4,000 ounces, and is surmounted by a fine marble slab. It may be asked how it comes about that a British firm should be producing this work, while in America you have such prominent firms as Gorham and Tiffany, let alone others of high standing, although perhaps not so world famous. Anyway, the firm which is producing this piece of work, while not well known, employs some of the finest London workmen.

There is one point with regard to this which is being queried, and that is as to whether it will pass the United States Custom House without having to pay a duty. It is a question of art or commerce.

\*

Trade here is by no means good, and while our Board of Trade returns are going up, there appears little opportunity for doing much—at any rate, in the jewelry and allied lines.

\*

The British Optical Association some time since applied for the grant of a royal charter, which is only granted by the Privy Council with the consent of His Majesty. The British Medical Council objected to the granting of a charter, and I understand that the Society of Chemist-Opticians also raised objections. Anyway, the British Optical Association will not get its charter, the Privy Council refusing to recommend the King to grant the same.

The Sight-Testing Bill before Parliament is in no better position than when I last wrote, and the attempt to get the British Optical Association to fall into line with the General Board of Opticians has so far not borne any good fruit.

ST. GEORGE.

When Otto Scheidt, Joliet, Ill., arrived at his store a few mornings ago, he found traces of a circle cut in each of the two front plate glass windows. Whoever did the cutting, was evidently frightened away before he had time to remove the glass.

## Clocks, Watches, Jewelry, Etc., Shipped to Alaska, Porto Rico, Hawaii and the Philippines.

WASHINGTON, D. C., July 19.—The following figures show the commerce of the United States, with its non-contiguous territories, for comparative periods of time, in jewelry, clocks, watches, etc.

ALASKA.—Clocks to the value of \$4,768 were shipped to Alaska during the 11 months ending May, 1906, as against a value of \$4,457 for the same period of 1905. The watch shipments increased from \$767 during the 11 months of 1905 to \$1,431 during the same period this year. Jewelry shipments amounted to \$10,710 in May, 1905, declining to \$3,667 in May this year. During the 11 months' period, however, the shipments increased from \$36,309 in 1905 to \$58,661 this year. Plated ware shipments amounted to \$5,728 in 1905, and \$7,370 in 1906.

HAWAII.—During May, 1905, clocks to the value of \$1,199 were shipped to Hawaii, increasing to \$1,509 in May of this year. During the 11 months' period the shipments increased from \$8,633 in 1905 to \$11,686 this year. No watches were shipped to Hawaii either in May a year ago or in May last. The value for the 11 months of 1905 was \$1,785, increasing to \$2,196 during the same period of 1906. A remarkable decline is noted in the shipments of jewelry in May a year ago and in May last, the figures being \$21,650 and \$1,350, respectively. During the 11 months' periods the shipments fell from \$166,034 in 1905 to \$83,421 in 1906, while plated ware shipments fell from \$51,917 to \$24,859 during the same periods.

PORTO RICO.—During May, 1905, clocks to the value of \$590 were shipped to Porto Rico, increasing to \$740 in May last, while during the 11 months' periods the shipments likewise increased from \$2,872 to \$5,353. During these same periods watch shipments increased from \$63 to \$185, and from \$2,222 to \$3,485. Jewelry shipments likewise show a healthy growth, the value for May, 1905, being \$295, increasing to \$1,136 in May last, while the values for the 11 months' periods were \$7,991 in 1905 and \$14,298 in 1906. Shipments of plated ware increased from \$6,022 to \$8,294 during the 11 months' periods.

PHILIPPINE ISLANDS.—Clock shipments to the Philippines amounted in value to \$2,050 during May, 1905, decreasing to \$1,432 in May last, while during the 11 months of 1905 the shipments were valued at \$4,453, increasing to \$4,837 this year. On the other hand, there were no watches shipped to the Philippines in May last, as against \$25 worth in May a year ago. The shipments for the 11 months' periods decreased from \$1,759 in 1905 to \$924 this year. Jewelry shipments increased from \$760 in May, 1905, to \$1,759 in May last, and from \$2,317 to \$3,905 during the 11 months' periods. Plated ware shipments increased from \$1,624 to \$4,926 during the last-mentioned periods.

H. Bealmear, Baltimore, Md., has leased the building at 25 W. Baltimore St., now occupied as a ticket office by the Western Maryland Railroad Co., and will conduct a jewelry store.

# HAYDEN W. WHEELER & CO.

## MOUNTED DIAMONDS

We are making up many new pieces in mounted diamonds for our Fall stock and will show new ideas and a larger and finer stock than ever.

Besides mounted diamonds, we have a large stock of loose diamonds, colored stones and pearls.

NECKLACES, BRACELETS AND LA VALLIERES ARE AMONG THE PREVAILING FADS AT PRESENT.



Trade-Mark  
Registered.

AMSTERDAM  
2 TULP STRAAT



Trade-Mark  
Registered.

LONDON  
50 HOLBORN VIADUCT

2 MAIDEN LANE, NEW YORK

TELEPHONE  
7365 CORTLANDT

ORDER

# DIAMONDS

ON MEMORANDUM FROM

## ALFRED H. SMITH & CO.

170 BROADWAY, NEW YORK.  
Corner Maiden Lane.

London.  
6 Holborn Viaduct.

Chicago,  
103 State Street.

## Oppenheimer Bros. & Veith, Cutters of Diamonds,

65 NASSAU ST. (PRESCOTT BUILDING), NEW YORK.

AMSTERDAM,  
2 Tulp Straat.

LONDON,  
40 Holborn Viaduct.

CUTTING WORKS,  
Cor. Union & Nevins Sts., Brooklyn.

## HENRY E. OPPENHEIMER & CO.,

51 Holborn Viaduct, London.  
50 Rue de Chateaudun, Paris.  
7 Place Loos, Antwerp.

Tel. 621 Cortlandt.

3 MAIDEN LANE, NEW YORK.

DIAMONDS, PEARLS AND PRECIOUS STONES.

MEMORANDUM ORDERS SOLICITED.

## Robbery Clearly Planned.

**Four Thieves Steal Diamonds Worth \$2,500 from Store of Edward Wineburgh & Sons, Utica, N. Y.**

UTICA, N. Y., July 18.—One of the boldest daylight robberies which has taken place in Central New York for some time was reported to the local police yesterday by Joseph Wineburgh & Sons, 21 Genesee St., who said that four crooks, evidently expert show case thieves, got away with a tray containing 24 solitaire rings worth \$2,500. Two men charged with being the thieves have been apprehended, but the man who carried off the diamonds has escaped. The boldness of the daylight raid staggered the clerks in the Wineburgh store, but they immediately got in com-

blue serge sack suit, a soft black hat, and displayed a conspicuous scarfpin of diamonds and emeralds.

No. 2—Man about 35 years old and giving his name as Albert Young, also under arrest. He is about 5½ feet high, face sunburned and sharp-featured, and has a slight impediment in his speech.

No. 3—Man about 30 years old, 5 feet 10 inches, slim build, smooth face, and the operator who stole the diamond tray. He wore a dark brown slouch hat, a dark gray suit and a straw hat.

No. 4—Man about 25 years old, who stood on guard outside the store; rather stout and wore a dark-blue suit and stiff straw hat.

All the men had the appearance of having lived an outdoor life. Their faces were

o'clock and went to the rear part to get a box. He was compelled to go into the cellar for one. This was a part of the plan, as the thieves got Mr. Price out of the way.

The scar-faced man picked out a clock simultaneously, and Mr. Wineburgh went to the rear to pack it up. This gave thief No. 3 the opportunity, and it is believed while Mr. Wineburgh and Mr. Price were in the rear that he slipped around the diamond case, opened the door and removed the diamond tray, placing it under the folds of his sack coat. Charles H. Livingstone, Mr. Wineburgh's brother-in-law, was in the rear part of the store reading a paper, but he could not see the third thief. The young chap—thief No. 4—was guarding the door.

While the theft was in progress the boy Dunn returned from dinner, but the outside worker, No. 4, detained him in conversation for a few minutes, until the first two thieves had gotten their clocks and the trio had started for the door and the street. Soon after entering the store, young Dunn noticed the open show case, and the discovery was made.

The local police were at once notified, descriptions of the men had, and the depots and hotels all watched. It was learned that the men had been stopping at the Lewis House, in Bagg's Sq., near the Wineburgh store. Chief Cleveland sent descriptions to neighboring places and the larger cities.

About 2.30 o'clock Bliss and Young registered at Stanwix Hall, in Rome, secured a room and changed their clothing. Then they left. They were seen on the principal streets, and later it was ascertained that they had left the city, walking in a westerly direction. The police got on their track, and about an hour later they were arrested near Greenway, a small station west of Rome.

Thief No. 3, the man who sneaked the tray, it was learned, reached Rome on the same trolley car with Young and Bliss. He was seen later in Uvanni's saloon, but when he saw an officer coming he went out through a rear door and escaped.

The young man who stood guard at Wineburgh & Sons' door got away without being detected, and it is believed he left the other three in this city.

Edward Wineburgh and Mr. Price positively identified Bliss and Young, who were arraigned here to-day and held for examination, July 26. Bliss and Young protested their innocence. Both men were very nervous when arraigned in court to-day and refused to plead until they had consulted counsel.

Two gold watches are offered by Ralph B. Cohen, Steubenville, O., one for the member of the local baseball team who obtains the highest batting average, the other for the member who first hits Mr. Cohen's sign on the right field fence with a batted ball during a regular game.

T. W. Gurley, Meyersdale, Pa., was recently notified that his father, L. F. Gurley, Hazen, Md., had been severely injured, having fallen from the top of a wagon load of sheaf wheat, striking head foremost on a fence post. The elder Mr. Gurley is slowly recovering from his injuries.



JOHN W. BLISS.

ALBERT YOUNG.

Two of the four men accused of carrying out the daring daylight robbery in the store of Joseph Wineburgh & Sons, at Utica, N. Y.

munication with Chief of Police Cleveland and his men and work on the case was begun at once.

The robbery happened about 1.15 p. m., and the absence of the diamonds was noticed five minutes later. Had the thief who worked the show case closed the door, the quartette might have got an hour's lead on the police. Frank Dunn, a boy employed in the store, noticed the opened show case and the absent tray. He notified Hyman Wineburgh, senior member of the firm, who saw at once that the house had been made the victim of an unusually daring daylight robbery.

The Wineburgh store is laid out in good shape for the robbery so successfully made yesterday. It is L shaped, the diamonds and more expensive jewelry being located in front of the store and near the entrance, while the office and packing counter is in the rear part and out of view of the front part of the store. The layout had been carefully studied by the diamond thieves.

The thieves are described as follows: No. 1—Man about 32 years of age, giving his name as John Bliss, and now under arrest. It is believed that Bliss engineered the diamond steal. Bliss is about 5 feet 5 inches in height, and weighs about 130 pounds. He has two scars on the left side of his face, one on the cheek and the other on the lower part of the jaw. Bliss wore a

sunburned and their general appearance indicated that perhaps they have been following race track horses or working Summer resorts.

The robbery was exceptionally well planned. The scar-faced man, who says his name is Bliss, was the first to enter the store about 12.30 p. m. Hyman Wineburgh waited upon him. He asked for diamond scarfpins, but could not find one to suit him. After looking about but making no purchases, he left the store, and about that time Mr. Wineburgh left for lunch. Bliss said he wanted to seek the opinion of a friend before buying a scarfpin which he fancied. Bliss returned to the store about 12.55 o'clock, and Edward Wineburgh waited upon him. He was again shown the tray of diamond pins. Then he asked to see some ladies' pins, and later some loving-cups and clocks.

While Bliss was occupying Edward Wineburgh's attention the man supposed to be Young and the third thief entered the store, and James E. Price, the bookkeeper, waited upon them. They wanted to look at some clocks. Young accompanied Mr. Price toward the rear of the store, while the third man leaned on a case near the diamond counter and toward the door. Young finally picked out a cheap clock and asked that it be packed up in a box for shipment. Mr. Price set the clock at 1.15

# Mr. ABE A. HELLER

is now in charge of our European offices, with headquarters at  
**39 Rue de Chateaudun, PARIS.**



BIRDSEYE VIEW OF PARIS.

Many years of studying the Jewelry trade here have given our Mr. Abe A. Heller an intimate knowledge of the wants of the American Manufacturer, which will be of great advantage in selecting the right goods for the American Market.

## *L. Heller & Son*

Importers of Precious and Imitation Stones.

New York, 51 Maiden Lane      Providence, 212 Union Street  
 Paris, 39 Rue de Chateaudun      Idar, 14 Hauptstrasse

TELEPHONE 219 JOHN.

GEORGE H. HODENPYL.

WALTER N. WALKER.

# DIAMONDS

AND

DIAMOND JEWELRY

# HODENPYL & WALKER

Unique  
and  
Staple Patterns

**170 Broadway, New York**  
 Corner of Maiden Lane  
 TELEPHONE, 1898 CORTLAND

Repairing and Recutting  
 Diamonds  
 a Specialty

OUR  
**40th**  
 YEAR

IN  
 BUSINESS

1866=1906

**DIAMONDS**  
 LOOSE AND MOUNTED

**CASES and MOVEMENTS**  
 ALL MAKES AND GRADES

**JEWELRY**  
 GOLD AND PLATED

ORDERS SOLICITED FROM RESPONSIBLE JEWELERS.      GOODS SENT ON SELECTION.

All our goods are either direct importations, our own manufacture or bought for cash, enabling us to offer special inducements in prices and terms.



EST. 1866.  
*Lissauer & Company*  
 Importers.

2 TULPSTRAAT,  
 AMSTERDAM.

12 MAIDEN LANE,  
 (ONE FLIGHT UP)

P. O. Box, 1625,

**NEW YORK.**

## SAVE A TRIP TO PARIS

by calling at our office and looking over our line of the newest French Styles in

Combs, Brooches, Festoons, Hair Barrettes, Buckles, Crosses, Bracelets, in Jets and Metals

**CHOPARD FRÈRES,** Makers of Art Jewelry Novelties

PARIS, FRANCE—35 Rue des Trois Bornes

49 MAIDEN LANE, NEW YORK CITY

**Death of Capt. Chas. G. Browne.**

BOSTON, Mass., July 19.—Capt. Charles G. Browne, well known in the jewelry trade, with which he had been identified from his youth until last March, when he engaged in business in other lines, died suddenly while on a yachting cruise last Monday night. He was one of the judges, acting fleet captain, and a member of the regatta committee of the Boston Yacht Club, whose squadron was on its way to Portland, Me., when he was stricken with paralysis. He was removed from the yacht to the Maine General Hospital on arrival at Portland, and died there a few hours later. Captain Browne's most recent connection with the jewelry trade was in the employ of Foster & Co., retailers, on West St., this city. When a boy he worked for Shreve, Crump & Low, subsequently learning the trade of diamond cutter with the veteran Henry D. Morse. Later he went to New York, and was with Howard & Co. as salesman, both in their New York and Paris establishments. He was in business for himself in New York for three years, but in 1898 returned to Boston and engaged with Foster & Co., with whom he remained as head of their diamond department for nearly eight years. He was about 49 years of age, and leaves two children, a son and a daughter.

Funeral services were held to-day at his residence, 760 E. 4th St., South Boston. Foster & Co. and former associates of Mr. Brown there sent a handsome floral tribute in token of their esteem. The interment was in Forest Hills Cemetery.

**Death of Andrew K. Jobe.**

JACKSON, Tenn., July 18.—The death Friday of Andrew Krecken Jobe caused deep regret and profound sorrow, not only to his many friends and business acquaintances in this vicinity, but to the jewelry trade throughout the south, in which the deceased had been long one of its most prominent members. Death was due to typhoid fever, from which he had suffered for two weeks. He, as well as his three sons, were stricken with the disease, but the sons recovered, while Mr. Jobe grew gradually worse until the end.

Andrew K. Jobe's interests in the jewelry trade were widely spread, and he had not only one of the most prominent stores in Jackson and the vicinity, but also owned an establishment at Water Valley, Miss., and was the head of the Jobe-Rose Jewelry Co., of Birmingham, Ala. He was 40 years old and had been in business in this city since 1888, having come here from Columbus, Miss., in that year. From the start he was prosperous, his energy, industry and ability as a business man bringing him a clientele that assured to him a successful career. As his business grew he opened a store in Water Valley as a branch of the establishment here, and later, in 1902, with J. N. Rose, opened another store in Birmingham, Ala., under the style of Jobe-Rose Jewelry Co.; this business he incorporated subsequently with a capital of \$20,000, becoming its president and treasurer. Mr. Jobe was also for a time interested with George H. Geer, of the Jackson Loan & Jewelry Co., but sold out his interests in the latter in 1905, and of recent years had

devoted almost all his time and attention in building up the business here, and at Water Valley.

The deceased is survived by a widow, a daughter, three sons and a mother.

**Massachusetts Labor Bureau Reports on Jewelry Pledged at Boston.**

That hundreds of thousands of dollars worth of jewelry finds its way into the hands of Boston pawnbrokers has long been realized, but the Massachusetts Bureau of Statistics of Labor has just concluded a detailed study of the subject. In making an investigation of the subject of uncollectable debts the Bureau's men were met far and wide with the complaint that the principal reason for these debts was the wage earners' Saturday night visits to saloons, forcing the family on Saturdays and Mondays to pawn articles of value to get the necessities of life.

To test the truth of this an exhaustive examination was made of the Boston pawnbrokers' records. It was confined to a study of the pledges taken in Saturdays and Mondays for the entire year. The report is filled with elaborate tables, but the gist of them is that on the 52 Saturdays 29,578 pieces of jewelry were pawned by needy Bostonians, who thus raised \$151,416.88. On the 52 Mondays they pawned 32,011 pieces, raising \$181,812.73; the total being 61,589 pieces of jewelry, which raised \$333,229.61.

The number of pieces of jewelry pledged was 50.28 per cent. of all the goods pledged in Boston for the entire year, and the amount loaned on it by the pawnbrokers was 78.41 per cent. of their total output for the year.

The concluding table shows the details of this Saturday and Sunday surrender of jewelry by its owners:

**Death of Abraham Jaffee.**

Abraham Jaffe, of A. Jaffe & Son, wholesale jewelers, 179 Henry St., New York, died Wednesday of last week at his home at the same address. Mr. Jaffe was 52 years of age. He was born in Russia and came to New York a number of years ago, starting in the jewelry business in a small way at 152 Henry St., subsequently removing to his present address. In May of last year Mr. Jaffe's son, Isaac Jaffe, was admitted into partnership, and a branch office was opened at 54 Maiden Lane in charge of the son.

Mr. Jaffe was a man of industrious habits, and in a comparatively few years built up a considerable business, at the same time winning the respect of the people with whom he was brought in association. The funeral took place at his home Thursday at 1 o'clock and was largely attended by friends.

**Retail Jewelers of Oklahoma Organize Association at El Reno.**

GUTHRIE, Okla., July 18.—Retail jewelers of Oklahoma have effected a State organization and will send delegates to the convention to form a national organization, which will be held in Rochester next month. The Oklahoma association was formed at a meeting held in El Reno July 12, and has as its object the protection of its members against the competition of mail order houses, the retailing by jobbers, etc., as well as the aiding in the enforcement of the gold and silver stamping laws, and encouraging the movement to obtain the same in this State.

The association elected as president J. F. N. Lloyd, Pond Creek, and as secretary, E. W. Eisfelder, Lamont.

Articles.	Saturday.		Monday.	
	Number of pledges.	Amount.	Number of pledges.	Amount.
Badges .....	14	\$56.60	6	\$13.50
Bracelets .....	80	275.00	62	254.90
Bracelets and chains.....	9	71.75	5	65.00
Bracelets and rings.....	12	55.00	17	59.50
Chains .....	1,043	4,762.74	1,190	4,306.35
Chains (fob) .....	34	98.80	24	53.20
Chains and charms.....	146	653.40	164	690.40
Chains and lockets.....	110	511.50	119	744.55
Chains and pins.....	18	90.20	11	108.50
Chains and rings.....	61	159.55	61	326.50
Charms .....	51	172.75	63	194.50
Cuff buttons .....	132	217.50	188	248.35
Cuff buttons and pins.....	6	17.00	13	41.75
Cuff buttons and rings.....	17	76.00	21	61.42
Diamonds .....	29	1,736.50	38	2,811.25
Earrings .....	53	320.85	41	331.15
Earrings (diamond) .....	36	1,427.50	43	1,711.50
Locketts .....	59	110.50	56	255.75
Locketts (diamond) .....	31	420.50	36	587.50
Pins .....	442	638.15	495	832.50
Pins (diamond) .....	289	2,834.50	303	3,657.30
Rings .....	6,737	9,720.61	7,208	10,138.18
Rings (diamond) .....	1,924	36,073.40	1,888	44,944.40
Rings (diamond and other).....	172	2,870.00	184	4,123.63
Rings (wedding) .....	630	1,065.00	616	1,212.50
Rings and earrings.....	12	29.25	9	18.50
Rings and pin.....	50	193.55	50	158.10
Studs .....	19	49.15	18	19.40
Studs (diamond) .....	103	1,692.75	122	3,839.00
Watches .....	14,519	63,166.20	15,500	64,822.70
Watches and chains.....	1,701	10,650.50	1,920	14,430.28
Watches, chains and charms.....	70	705.50	77	933.25
Watches, chains and lockets.....	15	323.00	24	476.25
Watches, chains and rings.....	42	450.00	51	934.75
Watches and charms.....	15	85.65	10	69.25
Watches and pins.....	54	437.85	36	338.50
Watches and rings.....	191	1,659.05	223	2,277.95
Other jewelry .....	652	7,538.78	1,119	15,720.72
Totals .....	29,578	\$151,416.88	32,011	\$181,812.73

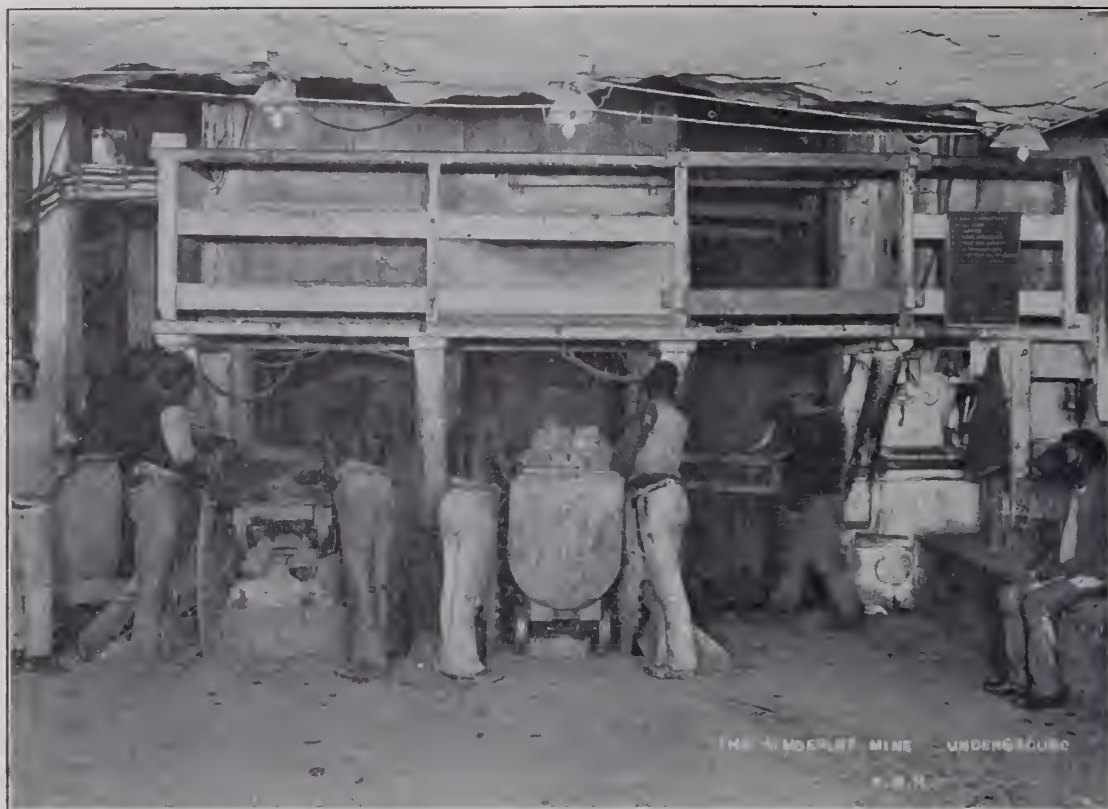

*Copyright Applied For.*

**O**UR MR. RICHARD FRIEDLANDER is now in Europe making heavy purchases of diamonds.

¶ We are now prepared to show our new importations, which will comprise a full line of

# DIAMONDS

of all grades.

¶ Large dealers will find it to their advantage to call and inspect these goods.

---

**R., L. & M. FRIEDLANDER,**  
IMPORTERS OF DIAMONDS.

30 Maiden Lane,

New York.

97 Hatton Garden, London, Eng.



**Two More Jewelry Robberies at Cleveland, O.—Brunner Bros. Co. Lose Stock Worth \$1,000 from Show Case.**

CLEVELAND, O., July 21.—A most daring robbery occurred about noon Saturday, when the street show case of the Brunner Bros. Co., in the Standard building, was robbed of about \$1,000 worth of stock. Of this almost half was recovered, having been dropped by one of the thieves in his flight.

Stories differ as to the number of persons engaged in the robbery. Some think three men were engaged in the job, while others say there was but one. The case was opened with a piece of wire and a duplicate key. The first thing people on the street noticed was that a clerical-looking young man was removing the goods from the top shelf of the case. He was working as if that was a part of his business. A man passing along the street did not like the looks of things, and watched the fellow. At that he ran down a blind alley at the side of the J. L. Hudson Co.'s store, and, though pursued, found a way into the Arcade and thence out on Superior St., where he was lost in the crowd. He left his hat behind, however, and this may form a clue to his identity.

Several diamond rings, a diamond stud, several brooches set with diamonds and some watches made up the main part of the goods taken. The doorman at the J. L. Hudson Co.'s store had been guarding the case, but he was called to the basement for something, and the robbery took place while he was gone.

The description of the man, as given by two men who saw him, is as follows: About 22 to 24 years of age, 5 feet 9 inches tall, light hair, face thin, light and smooth shaven, light blue eyes, narrow aquiline nose, and ears which stand out. He wore a blue coat and light trousers.

Some who saw part of the robbery say that there were three men, and that this one passed a portion of the goods to the others, who disappeared in the crowd and were lost to view. No descriptions of these men were given. It is also said that one of the men stood with his back against the case while the other opened it with the key. The boldness of the plan threw people off their guard or the man might have been caught easily.

A man giving his name as Lewis B. Smith, of Hamilton, O., was arrested early Thursday morning. He had marked out a square on the display window of Harry Goldberg, in the Cuyahoga building, with a glass cutter, and was beginning to tap out the piece when the watchman of the building stepped out. Smith took to his heels and around the corner ran into the arms of two patrolmen. In the police court he claimed to be a farmer, but his hands did not prove his assertion. He said that he had purchased a watch in Cincinnati which proved to be brass, and that he intended to take one of the watches he saw in Mr. Goldberg's window and replace it with his brass timepiece. He was bound over to the Grand Jury. The police officers believe that he is new to the burglary business.

After the burglary of the three jewelry stores, reported in THE CIRCULAR—WEEKLY last week, the police made eleven arrests.

Three of the men they found provided with revolvers and a bottle of nitro-glycerine. One of these is a man from Canton, who was in trouble at Columbus some months ago. The police believe they have the leaders of a gang of burglars.

**Daring Theft of Pearl Studs from New York Jeweler Followed by an Arrest.**

James McCrosson, 26 years old, who says that he lives in W. 66th St., New York, was arrested last Wednesday, charged with stealing three pearl studs from the counter of A. Frankfield & Co., at 38 W. 34th St., Manhattan. After McCrosson was locked up in the W. 30th St. police station he was brought before Magistrate Barlow, of the Jefferson Market Court, who held him in \$1,500 bail.

McCrosson, who is said to have almost as many other names as he had pawn tickets in his possession, is believed to be the same man who visited the Gorham

detective Cassasa and Patrolman Bull later arrested McCrosson.

Numerous pawn tickets, bearing various names, were found in the prisoner's possession. These tickets showed that three pearl studs had been pledged with a West Side pawnbroker. It is said that the tickets bore the date on which the pearls were missed.

Mr. Frankfield visited all the pawnshops in the vicinity and notified them, after the robbery, that the gems were stolen, and that he wished to be informed in case anyone called to pawn the pearls, which he described.

Mr. Frankfield, accompanied by a detective, went to the pawnbroker with whom the pearl studs had been pledged. The pawnbroker refused to allow Mr. Frankfield to examine the pearls. The detective, however, succeeded in examining the gems, and he noted the numbers on their backs. It is said that these numbers corresponded to the numbers of the stolen articles, but the jeweler has not yet recovered his property.

It was said that the Bailey, Banks & Biddle Co., Philadelphia, Pa., are looking for a man of McCrosson's description, and two associates, whose names were given as McDonald and Brennan.

After McCrosson was arrested several jewelers who were robbed in similar fashion went to the station to see whether they could recognize the man. One jeweler from Brooklyn was asked to pick out the man who he thought had robbed him. McCrosson was picked out of a crowd by this man. When the Brooklyn jeweler appeared in court on Thursday he was uncertain as to the identity of the prisoner.

**Death of Geo. E. Lowen.**

CHARLESTON, S. C., July 18.—Few deaths that have occurred in the jewelry trade in this vicinity for some time past have occasioned greater sorrow than did that of George E. Lowen, recently, the deceased having been extremely popular both in trade and social circles.

Mr. Lowen was a native of Ireland, and was born in Dublin in 1852. After learning the printing business in a large establishment owned by his father, he later moved to London, and had his interests directed to the jewelry trade through the fact that his brother was a secretary to the Goldsmiths' Co. Later he went to New York, and after spending five years in that city, moved to Charleston in the latter part of 1886 and entered the employ of James Allen & Co., with whom he remained for several years. About 1892 he left that firm to engage in business for himself, and from that time until his death conducted a store at his home, 82 Smith St., this city.

Deceased is survived by a widow and three sons, one of whom will continue the business.

Edgar A. Fitz, a jeweler of Columbus, O., filed a petition in bankruptcy in the District Court of the United States Wednesday, giving liabilities as \$757.35, with no assets.

McNichol & Pethick, Stratford, Ont., removed recently to Fort William, Ont., Canada.



JAMES MCCROSSON, CHARGED WITH ROBBING A. FRANKFIELD & CO.

Co.'s store on Fifth Ave., July 17, where he was carefully watched because he resembled another man known to be a jewelry thief. After the supposed crook left he was followed by Store Detective Larkin. The man made his way to Frankfield's. The detective told his suspicions to Mr. Frankfield. The supposed crook left without anything more happening.

On the following day a man said to be McCrosson entered Frankfield's, but was not recognized as the suspected man at once, because he had on a different suit and hat. He asked that some pearl studs be shown to him, and a salesman took out a tray of pearl studs which had been carefully examined by the stock clerk a short time before. After looking at the pearls the visitor remarked that he would call again with his brother, who wished to select the gems. The visitor then started to leave the store.

Looking over the tray, the salesman saw that three pearl studs were missing. De-

# Chester Billings & Son

1840 Successors to Kandel, Barmore & Billings 1906

**Importers of Diamonds  
Other Precious Stones, and  
Pearls, Diamond Jewelry**

1840, Kandel & Barmore; 1866, Kandel, Barmore & Co.; 1880, Kandel, Barmore & Billings; 1897, Chester Billings & Son

New York, 58 Nassau Street, 29 Maiden Lane  
London: 22 Holborn Viaduct, E. C. Paris: 53 Rue de Chateaudun  
Amsterdam: 2 Tulp Straat

# My Specialty

**W**HEN a house is known to excel its competitors in any one attribute, it becomes recognized as "a specialist." I will pay a better cash price for jewelry and precious stones that your customers wish to dispose of, and you do not care to purchase yourself, than any other concern. Send me a trial selection and be convinced.

*Entire Stocks and Estates Bought*

*Bank References Given*

*Everyone knows that I pay more for*

**AMERICAN PEARLS**

*than any other firm.*

**Maurice Brower**

12-16 John St., New York

Telephone, 6233 Cortlandt

## COOPER'S

### SUN RAY DIAMOND

HAS 100 per cent. more brilliancy than any other style of cutting.

***We Challenge the World.***

Send your old mine and yellow diamonds to be recut; if the effect is not 100 per cent. better, **NO CHARGE.**

### COOPER DIAMOND

Cutting and Polishing Industry of America

49 MAIDEN LANE, NEW YORK.

Factories, 8th Ave. & 18th St., Brooklyn.



# EDUARD VAN DAM

# DIAMOND CUTTER

## AMSTERDAM NEW YORK ANTWERP

### Gorham Mfg. Co. to Abandon Stock Transfer Plan—Meeting to Act on New Plan for Selling Affiliated Companies.

Officers of the Gorham Mfg. Co. have concluded to abandon the project for selling the several affiliated companies to the Silversmiths Co. of New York, whose capital stock, under the proposed plan, was to be enlarged. A meeting of the Gorham Mfg. Co.'s stockholders has been called for Aug. 1 to take action formally abandoning the project, and also to act on a new plan for the sale of capital stock in other corporations now owned by the Gorham Co.

The following circulars sent out to the stockholders from the offices at Providence, R. I., explain the situation:

To the Stockholders of the Gorham Mfg. Co.:

Enclosed please find a notice of a special meeting called for the purposes stated in said notice.

In order that you may more fully understand the reason for and subject of the proposed special meeting, I am directed to make the following statement:

The plan heretofore presented to you that the Gorham Mfg. Co. first enlarge the capital stock of the Silversmiths' Co. of New York and thereafter sell to the enlarged company shares of the capital stock, owned by the Gorham Mfg. Co. of certain other corporations, has been attacked in the courts by Mr. George H. Robinson as a stockholder, and has been enjoined by the Court of First Instance upon grounds, among others, that the Gorham Mfg. Co., under its present charter, is a manufacturing corporation, and that its powers to hold shares of stock in other corporations are only incidental to its main or primary purposes, of manufacturing gold, silver and other goods.

Our counsel have advised that, under all circumstances, the views of the court in so far as these views are unfavorable to the aforesaid plan attacked should be adopted, and therefore, that the plan that the Gorham Mfg. Co. first enlarge the capital stock of the Silversmiths' Co., and thereupon sell to such enlarged company the shares of the capital stock of certain other corporations owned by the Gorham Mfg. Co. should be abandoned.

Because of this advice, and because of the apparent limitations of our charter, and also for business and financial reasons, it has been decided by the board of directors to sell and convert into cash for the benefit of your treasury the shares of capital stock owned by this company of the other companies named in the enclosed notice.

In order that the directors might recommend to you a price at not less than which these stocks should be sold, your directors have made careful investigation as to the value of the stocks proposed to be sold, and have concluded that the fair and adequate value and the price at not less than which the aggregate of said stocks should be sold, is the sum of \$1,627,410.

Your directors have received a definite and reliable offer to purchase this capital stock at the foregoing price, and with a condition that, if the purchase is made at the price above mentioned, all stockholders of the Gorham Mfg. Co., without distinction as to class, may come in and participate in the purchase, pro rata, according to their several holdings.

The report of the committee of the directors appointed to ascertain the value of the capital stock proposed to be sold, and the opinion of counsel, as to the course which should be pursued by this company under the circumstances, are both on file with the secretary of this company, and are subject to inspection by any stockholder of the company during business hours on application to the secretary.

All of which is respectfully submitted.

J. F. P. LAWTON, Secretary.

By order of the Board of Directors.

To the Stockholders of the Gorham Mfg. Co.:

A special meeting of the stockholders of the Gorham Mfg. Co., will be held at the office of the company, in Providence, Rhode Island, on Wednesday, the first day of August, 1906, at 3 o'clock, to take action upon the following recommendations of the Board of Directors:

"That the plan that the Gorham Mfg. Co. first to enlarge the capital stock of the Silversmiths' Co.

of New York, and thereafter sell to such enlarged company the shares of the capital stock owned by this, the Gorham Mfg. Co., of other corporations, be abandoned.

"That all of the shares of the capital stock, owned by this, the Gorham Mfg. Co., of the following corporations:

"Whiting Mfg. Co., the Silversmiths' Co. (of New York), the Silversmiths' Co. (of New Jersey), William B. Durgin Co., and the William B. Kerr Co., be sold for not less than the price of \$1,627,410 in the aggregate; and that, if sold for not more than the price above mentioned, the sale be upon the condition that the purchaser permit all stockholders of the Gorham Mfg. Co., without distinction as to class, to participate, if they so desire, in the purchase.

"That the sale be made at such a time and in such manner as the stockholders may direct, in order to realize the best price obtainable, and to transact such further business as may properly come before the meeting.

"Dated, Providence, R. I., July 20, 1906.

"J. F. P. LAWTON, Secretary

"By order of the Board of Directors."

### Death of Christian Strobel.

WATERBURY, Conn., July 23.—Christian Strobel, president and treasurer of the Lake & Strobel Co., died last Friday after an illness of two years from bronchial tuberculosis, at his home, 114 N. Willow St.

Christian Strobel was born in Wittenberg, Germany, Dec. 25, 1866, the son of George John and Lucia (Schlegel) Strobel. He came to Waterbury with his parents when six months of age. Practically his whole life was spent in this city.

His only education was that of the public schools of the city, which he attended until he was 10 years of age. He then entered the employ of the City Manufacturing Co., where he worked for two years. At the age of 12 he signed with E. A. Locke, William Weeden and George Merritt, who had organized the Waterbury Watch Co., as an apprentice watchmaker. He served here for three years, when he changed his service to that of D. C. Callender & Co.

At the age of 19 he purchased Mr. Callender's interest in the business, which was located in the same building it now occupies, under the name of the Lake & Strobel Co.

George T. Lake joined with Mr. Strobel in forming the co-partnership of Lake & Strobel. In 1896 the Lake & Strobel Co. was organized, with Mr. Strobel owning practically all of the stock.

One of the enterprises in which he took an active interest during the last years of his life was that of the Woodbury Electric Railway. Much of his time was taken up, with that of three others, in securing rights of way and charter rights for this road. He was also more or less interested in the development of Lake Quassapaug as a pleasure resort.

Mr. Strobel was one of the most popular young men in the city. He was a man of kindly and charitable impulses, helping many others effectively and without ostentation. In business he displayed rare capacity, and his advice was frequently sought by others.

The deceased leaves one brother, George J., and one sister, Emma. His father, George J., died about eight years ago, and his mother, Lucia Schlegel, about six years ago. There are no other near relatives.

The funeral took place yesterday from his residence, the Rev. Mr. Lewis officiating. Burial was in Riverside Cemetery.

### The Aikin, Lambert Co. Reorganized—Report of Combination Denied.

Announcement was made last week of the reorganization of the Aikin, Lambert Co., 19 Maiden Lane, New York, manufacturers of gold pens, fountain pens, etc. The change in no way affects the Aikin, Lambert Jewelry Co.

The old charter of the Aikin, Lambert Co. was obtained under New Jersey laws, and recently when it expired the business was reincorporated under the laws of New York. On the reincorporation two members of the old company, H. A. Lambert and John B. Shea, sold their interests. Mr. Lambert, who is now on a western trip, will continue to give his attention to the business until the end of the year. Mr. Shea, who had been connected with the business more than 40 years, and has been the superintendent of the factory for a long time, retired in order to take a rest, which his associates feel he had abundantly earned.

James C. Aikin is the president of the reorganized company, and, it is announced, he will continue so indefinitely. It is further said that the changes were made because officers of the old company, getting along in years, felt that they were entitled to a little more ease, and that an infusion of new blood would be desirable.

Mr. Shea's interests were sold to W. I. Ferris, of the L. E. Waterman Co. No announcement was made as to whom Mr. Lambert sold his stock. Reports that the Waterman Co. had secured control of the Aikin, Lambert Co. and that this was the beginning of a combination in the gold pen and fountain pen business were denied by members of both companies. It was said that Mr. Ferris had bought Mr. Shea's stock purely as an investment, with no other movement to influence him.

An interesting incident which occurred just before Mr. Shea's retirement from the factory was a present to him in behalf of the employes of an individual silver loving cup. He lives on Vanderwater St., and has been active in educational work, filling the position of School Commissioner in his district.

### Death of Harry Helms.

STEUBENVILLE, O., July 18.—The sudden death of Harry Helms, the well-known jeweler, was the subject of much comment and sorrow among his many friends last week, Mr. Helms having passed away suddenly Thursday morning. He was discovered by his brother lying at the foot of the bed in his night robe, and it is supposed that he died of heart failure.

The deceased was 40 years old, and had been in the jewelry business since 1888. He continued until 1896, when he met with reverses and was succeeded by his father, A. M. Helms, for whom he worked for some time. Last December, with his brother, Edward, he purchased his father's interests in the business, and the two continued it from that time under the style of Helms' Jewelry Store. Mr. Helms was widely known in the vicinity and well liked. He had been in poor health for some time.

Hollins Bros., Crowley, La., have dissolved, Edward J. Hollins continuing.

# WM S. HEDGES & CO.,

IMPORTERS AND CUTTERS OF

## DIAMONDS.

Precious Stones and Pearls.

170 Broadway, Corner Maiden Lane, New York.

27 Holborn Viaduct, London.

Saunders, Meurer & Co. Cutters and Importers of

## DIAMONDS AND OTHER PRECIOUS STONES

FINE PEARLS A SPECIALTY.

65 Nassau St., cor. John St., Prescott Building, Telephone, 1613 Cortland. NEW YORK.

Chas. L. Power & Co., Cutters and Importers,

## DIAMONDS

AND OTHER PRECIOUS STONES,

170 Broadway, corner Maiden Lane, NEW YORK.

27 Holborn Viaduct, London.

## GOODFRIEND BROS.,

IMPORTERS AND CUTTERS OF PRECIOUS AND IMITATION STONES.

Pearls

Rubies

Sapphires

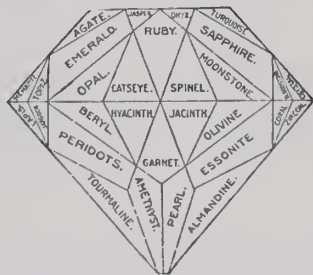

Tourmalines

Gem Corals

Opals

Emeralds

COPYRIGHT, 1895, BY GOODFRIEND BROS.

256 Westminster St., Providence, R. I.  
10 Rue Cadet, Paris.

Tel. No. 662 Cortl.

9-11-13 Maiden Lane, New York.

## CORAL

**BORRELLI & VITELLI,**  
CORAL MANUFACTURING COMPANY,

All kinds of Coral—DROPS, BUTTONS, LENTILLES.  
CORAL NECKLACES, Graduated and Uniform.

PINK AND WHITE CORAL A SPECIALTY.

GOLD MEDAL, ST. LOUIS, 1904.  
GRAND PRIX, LIEGE, 1905.

3 Via Amedeo, Torre del Greco, Italy. 32 Rue d'Hauteville, Paris, France.

401 Broadway, New York.

Telephone, 5412 Frankln.

CORAL

CORAL

## Diamonds Set Without Cost

Means a lot of money saved during the year. This you can do very easily if you have your settings done by a first-class setter. Your diamonds will improve in value more than three times the money you pay for setting them. At the same time your mountings improve greatly. Your customers are satisfied with all the orders you turn out. You can compete with all others who are slow in grasping the importance of these facts, by giving me all your settings. I am sure you will make no mistake as I will prove these facts.

I make a specialty of setting fine Platinum Mountings, Watch Cases, Lockets and Gypsy Settings.

### RUDOLF BRETTNER

65 Nassau Street NEW YORK

MAIL ORDERS RECEIVE PROMPT ATTENTION

Established 1883

Telephone 2547 Cortlandt

### REMOVAL NOTICE!

## THE LYONS GEM CO.,

Have Removed to

35 Maiden Lane, New York.

A FULL AND COMPLETE LINE OF PRECIOUS, SEMI-PRECIOUS AND IMITATION STONES ALWAYS IN STOCK.

Our Specialty is Scientific Rubies.

Local and out of town jobs promptly attended to at reasonable prices. Send us your mountings to be set with matched stones. A trial order will convince you that our prices are right, and our goods select.

### EDMUND R. NEBELING Diamond Setter

49 Maiden Lane - NEW YORK  
Telephone, 5039 John

Gypsy and Platinum Work a Specialty. Mail Orders promptly attended to. Write us for references

### Encyclopedia-Dictionary

and reference hand-book of the Ophthalmic Sciences.  
Price, \$2.50.

The Jewelers' Circular Pub. Co., 11 John St., N. Y.

**Programme of Conventions at Rochester, N. Y., of American Association of Opticians and of State Organization.**

ROCHESTER, N. Y., July 23.—Arrangements are practically completed for the convention of the American Association of Opticians which will be held in this city July 30 and 31, Aug. 1 and 2. The arrangement committee has for the past several weeks led a strenuous life in securing accommodations for the guests. Realizing that hotels and boarding houses would not be adequate, rooms have been secured in private houses, and there is no doubt that all visitors will be taken care of in the very best manner.

The committee on exhibits has been obliged to refuse many applicants for space. It is said by those who have visited other conventions that the exhibits this year will be far ahead of those at previous meetings.

The convention of the Optical Society of the State of New York will probably consist of the necessary routine business meeting and the election of officers. It will be held here on July 30, morning and afternoon.

The following programme has been arranged:

Monday, July 30, 11 A. M.—Opening session Optical Society of the State of New York. 2 P. M.—Second Session State Society. 8 P. M.—Opening session of American Association of Opticians. Address of welcome by Mayor James G. Cutler and response by John C. Eberhardt, Dayton, O. Annual address by B. B. Clark, national president. Reports of the secretary, William E. Huston, Kansas City, Mo.; and the treasurer, J. K. Stebbins, Ashtabula, O.

Tuesday, July 31, 8.30 A. M.—Meet at Convention Hall to start for visit to E. Kirstein's Sons Co., Court St. 9.30 A. M.—Business session. Addresses by Dr. Arthur O. Campbell, Topka, Kans., "Health Ray Lenses;" E. LeRay Ryer, New York, "The American Optometrical Academy;" R. E. Lockwood, New York, "The Eye an Imperfect Optical Instrument;" E. C. Bernheim, Providence, R. I., "Errors in the Business of the Optician;" Ernest Eimer, Muskegon, Mich., "The Physiological Section, Past and Future." 1 P. M.—Meet at Convention Hall to start for visit to Bausch & Lomb factory. 8 P. M.—Eye testing clinic, conducted by Physiological Section; demonstrator, Prof. Samuel S. Grant, Montreal, president Physiological Section. Muscle testing clinic in charge of librarian of section, C. M. Jenkins, Richmond, Ind.; demonstrators, Dr. John H. Ellis, South Bent, Ind., and John C. Eberhardt, Dayton, O.

Wednesday, 8.30 A. M.—Business session of Physiological Section. Addresses by John Eberhardt, Dayton, O., "Monocular Amblyopia Due to Congenital Corneal Asymmetry;" Geo. W. McFatrigh, M.D., Chicago, "Correction for Myopes;" Edward E. Arrington, "Legislation;" H. P. Holmes, Des Moines, Ia.; Samuel S. Grant, Montreal, "The Eye in Comparative Anatomy." 1 P. M.—Meeting of members and visitors at Convention Hall to start for Eastman Kodak Works, Kodak Park. At the conclusion of visit to Kodak Park a trolley and steamboat trip. The official photograph will be taken at Kodak Park. 8 P. M.—Addresses by C. M. Jenkins, Richmond, Ind., "Some Diseases Essential for the Optometrist to Recognize;" Chalmers Prentice, M.D., Chicago, "The Soul and Its Immortality Proven by Science;" Earl J. Brown, M.D., Chicago, "Mechanism of Accommodation," illustrated by stereopticon; H. L. DeZeng, Philadelphia, "The Illumination of the Eye by Direct and Oblique Methods;" E. Culverhouse, Toronto, Can., B. O. A., "Things in General."

Thursday, 9 A. M.—Visit to Taylor Bros.' thermometer factory. 11 A. M.—Address by Chalmers Prentice, M.D., "The Eye in Relation to Health." During this address a free clinic will be held, demonstrating the effect of lenses in cases of stammering, partial deafness, St. Vitus dance and shaking palsy. 1.30 P. M.—Unfinished business. Vote on next meeting place. Election of officers. Evening—Banquet.

The Physiological Section will conduct an eye testing room during the convention, where all the latest improved instruments and methods will be explained. Ernest Eimer, Muskegon, Mich., will be in charge. Prof. R. M. Lockwood, of New York, will act as demonstrator.

The association is indebted to the Bausch & Lomb Optical Co., the Eastman Kodak Co., Taylor Bros. Co., and E. Kirstein's Sons Co. for the entertainment and banquet to be furnished its members and visitors.

The present officers of the American Association of Opticians are: B. B. Clark, president; Briggs S. Palmer, Boston, first vice-president; W. C. Sommers, Springfield, Ill., second vice-president; J. K. Stebbins, Ashtabula, O., treasurer; William E. Huston, Kansas City, secretary.

Executive Committee—George Bausch, Rochester; S. B. Millard, Minneapolis; Alexander Martin, Philadelphia; H. J. Cook, Knoxville.

Regents—E. Culverhouse, Toronto; Clarence S. Hart, Lynn, Mass.; W. Eisensmith, Charleston, W. Va.

Physiological Section—Samuel S. Grant, Montreal, president; Ernest Eimer, Muskegon, Mich., secretary; C. M. Jenkins, Richmond, Ind., librarian.

**Chicago Jeweler Holds Two Robbers at Bay Until the Police Arrive.**

CHICAGO, July 23.—An attempt to hold up a jeweler last night resulted in the tables being turned upon the robbers, who were held captive until turned over to the police. The prisoners described themselves as Thos. Titik and Jas. Koster, 22 years old, both of whom the police claim to know. The man whom they attempted to rob, but who proved to be too much for them, is Anton Butka, a jeweler at 591 Blue Island Ave. The men are locked up in the Canal Port Ave. Station.

According to the police reports, Butka was alone in his store when the two men entered and asked to be shown some diamond rings. Suspecting them at once the jeweler placed a tray of rings before them, but while they were making a selection quietly secured a revolver. Suddenly one of the men started to draw a pistol while the other seized the tray of rings and tried to back out of the store. This was what Butka was expecting, and quickly covering the men with his revolver he bolted the door, and, keeping the "drop" on his prisoners, held them while his wife telephoned to the police.

**Death of Allan Garretson.**

DETROIT, Mich., July 23.—Allan Garretson, aged 71, formerly one of Detroit's well-known jewelers, died last week after an illness of seven months. He was born 71 years ago in Logan, O. After serving in the Civil War he came to Detroit and entered the jewelry trade with M. S. Smith, the firm name being M. S. Smith & Co. Garretson, in his younger years, was active in politics, being a close friend and staunch supporter of Senator R. A. Alger.

The funeral was largely attended. Interment was in Woodmere.

The business conducted by Chas. B. Collins, Groton, S. Dak., has been incorporated as the C. B. Collins Co., with an authorized capital of \$18,000.

**Programme of the National Convention of Retail Jewelers to be Held at Rochester, N. Y.**

ROCHESTER, N. Y., July 20.—There is considerable speculation here, both among jewelers and hotel keepers, as to how many out-of-town members of the trade will be in this city Aug. 3 and 4 as a result of the convention of the American Retail Jewelers' Association, to which will be sent delegates from the many State associations which have been formed recently, for the purpose of organizing a representative national association of retail jewelers of the United States.

The convention, which will be held at Haines Hall, is expected to begin promptly at 9.30 A. M., Aug. 3, when the first session will be held. This session will be opened to jobbers, manufacturers and retailers. It is expected that a large number of jobbers and manufacturers will be represented here, but inasmuch as the convention of the American Association of Opticians will be held just previous to the opening of the jewelers' convention, it is generally expected that a large number of the jeweler-opticians who come to the former will stay for the latter, if only to take part in those sessions of the jewelers which will be open to every legitimate member of the retail trade, without regard to whether he is affiliated with or belongs to any organization.

The interest evinced by the local jewelry trade in the convention has not been as great as would naturally be expected, but it is thought that greater consideration may be given the project when the time of the meeting draws near.

The final programme of the convention has been made public, and is as follows:

1. Address of welcome, President Max Jennings.
2. Report of Secretary E. R. Roebm.
3. "Advertising Value of Jewelers' Show Windows," Mack A. Hurlhut.
4. "Federal Control of Interstate Commerce," Hon. E. B. Vreeland.
5. "Organization—Its Difficulties and Its Possibilities," A. L. Sackett.
6. "Organization from the Standpoint of the Manufacturer," S. O. Bigney.
7. "The Growth of Organizations," W. B. Roberson.
8. "Local Association Experiences," J. M. Nabstedt.
9. "A Few Reasons Why We Are Here," F. W. Jameson.
10. Closed session.

[Temporary adjournment of the American Retail Jewelers' Association into a "Committee of the Whole." This session will be closed to all except regular, legitimate retail jewelers. Every retail jeweler at the convention, whether or not he is a member of the American Association or any other jewelers' association, is invited to participate in this "general session" for the purpose of recommending the best manner to effect a peaceful and harmonious union of all the jewelers' associations now in existence.]

11. Session of the American Retail Jewelers' Association to consider the recommendation of the "Committee of the Whole."
12. Reports of committees.
13. Election of officers.
14. "Retail Advertising."
15. "Retail Mail Order Question."
16. "The Retailing Jobber."
17. "Fake Auction Sales."
18. Remarks for the good of the order.
19. General Trade Topics.
20. Resolutions.
21. Adjournment.

*WE are receiving weekly shipments of desirable goods in all sizes and grades, at prices that will interest large buyers.*

---

---

**ARNSTEIN BROS. & CO.,**

*Importers and Cutters of*

**DIAMONDS,**

*65 Nassau Street, Corner John, NEW YORK.*

*LONDON, Audrey House, Ely Place. AMSTERDAM, 6 Tulp Straat.*

SEND TO US ANY QUANTITY OF

**AMERICAN PEARLS**

WE BUY FOR CASH.

Send by registered mail or express; we will make an offer by return mail. We will also buy any quantity of

**BAROQUE PEARLS (SLUGS).**

**BUNDE & UPMAYER CO.,**

Mack Block,

MILWAUKEE, WIS.

### Progress Made by the Pennsylvania Retail Jewelers' Association.

PITTSBURG, Pa., July 18.—From present appearances it looks as if the Pennsylvania Retail Jewelers' Association, organized in this city July 10, was not only going to be a success, but would soon have on its roll a large proportion of the leading jewelers of every city in the State. Letters of congratulation have been coming in to the officers, and the interest evinced in the organization shown not only by Pittsburgers but those in other cities who could not attend the convention, and, in fact, knew nothing about it until after the organization took place, indicates that the movement will have the support of a very large part of the jewelry trade. C. S. Wiley, this



C. S. WILEY, SECRETARY PENNSYLVANIA RETAIL JEWELERS' ASSOCIATION.

city, the secretary of the association, has received letters from many firms who wish their names added to the roll of members. The complete list of charter members is as follows:

A. Katzenmeyer, Burgettstown; D. L. Cleeland, Butler; H. G. Phillips, Vandergrift; E. Krone, Clarence; John Forschner, Jeryn; C. H. Jaquette, Scottdale; C. C. Jaxtheimer, New Wilmington; G. M. Smeigh, Milroy; N. W. Pinkerton, Mannheim; F. M. Langnecker, New Brighton; Carl Revinus, Ebensburg; J. J. Considine, Lebanon; Jerry Benninghoff, Greenville; Archibald Thistle, Washington; John F. Beyerle, Reading; L. J. Resnor, Allegheny; R. S. Bush, Coudersport; C. E. Penman, Hazleton; John Yenny, East Pittsburg; C. W. Parker, Westfield; Charles H. Hamer, Philadelphia; William Haines, Philadelphia; Frank R. Coe, Pittsburg; Joseph Bickart, Wilkinsburg; V. Cowles, Point Marion; I. E. Isaacs, Pittsburg; T. H. McNary, Washington; Philip Rupecht, Sharpsburg; F. E. Leitzell, Scottdale; W. S. Roe, Allegheny; Frank L. Wells, Marion Center; J. Frank Blosser, New Kensington; P. C. Yester, McKeesport; G. A. Spies, Pittsburg; A. C. Graul, Sharpsburg; J. P. Steinmann, W. F. Steinmayer, C. S. Wiley, Pittsburg; S. S. Snyder, Dayton; A. Redfoot, Mt. Jewett; A. L. Gettys, Buffalo Mills; E. A. Malsberry, Rockwood; N. H. Thompson, Scotch Hill; E. Mouillesseaux, Towanda; Frank E. Burr, Carbondale; Fred Quartier, Saltsburg; H. Held, Pittsburg; T. S. Hoffman, Derry Station; Stewart & Son, Huntingdon; Robert Gestrich, Pittsburg; Roger Gray and C. E. Snyder, Allegheny. Many others will join.

SHARPSBURG, Pa., July 21.—A. C. Graul, of this city, president of the Pennsylvania

Retail Jewelers' Association, has announced the appointment of the following standing committees for the association:

COMMITTEE ON TRADE INTERESTS.—C. W. Parker, Westfield; Chas. H. Hamer, Philadelphia; W. F. Steinmayer, Pittsburg.

COMMITTEE ON LEGISLATION.—D. L. Cleeland, Butler; T. H. McNary, Washington; Wm. S. Roe, 1254 Beaver Ave., Allegheny.

COMMITTEE ON QUALITIES.—J. P. Archibald, Blairsville; Frank R. Coe, Pittsburg; F. E. Leitzell, Scottdale.

COMMITTEE ON MEMBERSHIP.—P. C. Yester, McKeesport; Vet Cowles, Point Marion; Wm. Haines, Philadelphia.

COMMITTEE ON DECEASED MEMBERS.—G. A. Spies, Pittsburg; Philip Rupecht, Sharpsburg; J. Frank Blozier, New Kensington.

### Death of Max Goldsmith.

WASHINGTON, D. C., July 19.—The funeral of Max Goldsmith, senior member of the firm of M. Goldsmith & Son, took place this morning from his late home, 1910 Calvert St. Rabbi Simon and Rabbi Stern officiated, and a large number of friends and business associates gathered to pay the last honors to the deceased. The interment was in Washington Hebrew Congregational Cemetery. Mr. Goldsmith passed away suddenly Monday evening after an attack of heart trouble.

The deceased was a native of Germany, and was 67 years old. He came to the United States when 11 years old, and first settled in New York before going to Washington. He started in the jewelry business over 30 years ago, and formed the firm of Prince & Goldsmith in 1874. This firm being dissolved in 1879, Mr. Goldsmith continued alone until August, 1890, when he admitted his son, Charles A., under the style of M. Goldsmith & Son. The firm continued without change up to the present time, the business growing until their store at 9-11 Pennsylvania Ave., N. W., became one of the most important as well as one of the best known in the city.

Mr. Goldsmith was prominent in Masonic circles, being a member of the Federal Lodge No. 1, Eureka Chapter, and was a 32d degree Scottish Rite Mason and a member of the Mystic Shrine. He was identified with several Hebrew fraternal organizations, and a prominent member of the Washington Hebrew Congregation, as well as the Royal Arcanum and National Union. Besides his son, who was associated with him, Mr. Goldsmith is survived by a widow.

A number of jewelers of Grand Rapids, Mich., have agreed to close their places of business at noon each Thursday during the months of July and August, giving their employes a half holiday on those days. The success of the movement is due to the work of the members of the J. C. Herkner Jewelry Co., 57 Monroe St., who were the first to sign and to circulate the petition. The jewelers who signed are: J. C. Herkner, E. J. Hervey, F. W. Wurzburg, P. J. Koke, J. J. Thompson, Joseph Siegel, A. Zierleyn, Vander Muelen & Son, W. D. Werner, F. C. Steglich, J. E. Ryan, A. Preusser, Cars-ten Bros., E. O. Prange, R. J. Warn, A. Open Dyke, A. Siegel, Pritchard & Price.

### A Notable Sale of Jewels at London.

Cable messages from London say that the principal jewel sale of the season at Christie's took place July 11. A total of £70,178 (\$350,890) was realized from the sale of 175 pieces and lots. Toward this £10,000 (\$50,000) was contributed for a necklace of 47 large pearls with a single brilliant clasp.

At the sale of this necklace, Mr. Drayson open the bids with £3,700 (\$18,500), and at £7,000 (\$35,000) C. Thompson, of Agnew & Son, stepped in and remained to the end, though the final bid came from Mr. Holdaway. Mr. Tannenbaum secured a pearl rope, composed of 191 pearls, for £3,700 (\$18,500).

The same property included many more pieces of considerable value, notably a five-row pearl necklace, for which Mr. Mallett gave £2,500 (\$12,000); a pair of fine cabochon emerald and diamond earrings, bought for £1,350 (\$6,750) by Mr. Graham; an emerald and brilliant collet necklace, bought for £1,250 (\$6,250), and a fine oblong sapphire mounted collet border of brilliants as a brooch for £1,020 (\$5,100) by Mr. Hamilton, and three fine black pearls mounted as studs, bought for £1,000 (\$5,000) by Mrs. J. Phillips.

The late Lady Montgomery's necklace of 76 pearls went to Mr. Lyon for £780 (\$3,900). The same price was paid by Mr. Mallett for a collet necklace composed of 49 graduated brilliants and an oval brilliant snap. The miscellaneous properties included a five row pearl necklace, composed of 417 pearls of fine Orient, well matched and graduated, and with an oval brilliant clasp of foliage design. The hammer fell at Mr. Lowe's offer of £4,800 (\$24,000), Mr. Robinson being the under bidder.

To Mr. Lindenbaum fell for £2,350 (\$11,750) a necklace composed of three rows of 219 graduated pearls, with a pearl and brilliant cluster snap, while Mr. Tannenbaum gave £3,400 (\$17,000) for a necklace of 55 graduated pearls, with a square brilliant snap.

### A New Eye Shade That Is Becoming Popular.

A NEW feminine vanity is the "maissette," a device for shading the eyes from the sun, made fashionable by the new Queen of Spain. It is an elaborate trifle of gold, pearl, carved tortoise-shell, etc., and is mounted on a long handle like the familiar lorgnette, says a daily exchange. English women are carrying the "maissette" to polo matches and race meetings. It is of course much less in the way than a parasol, yet saves the eyes from glare and wrinkles.

Another device carried for the same purpose is the automobile parasol, which is a tiny thing of silk and lace, set on a small jointed folding stick of pearl and ivory; and of less use for motoring than for garden parties or the church "parade."

Nathan Thomas, associated in business with his brother, E. L. Thomas, in Phoenixville, Pa., is at present confined in a hospital suffering with typhoid fever.

ADDISON W. WOODHULL, President.  
FRANK K. HUFF, Vice-President.

GILBERT T. WOODHULL, Treasurer.  
WILLIAM J. McQUILLIN, Secretary.

## MOUNT & WOODHULL,

IMPORTERS OF

DIAMONDS,  
OTHER PRECIOUS STONES,  
PEARLS, ETC.

MAKERS OF

FINE  
DIAMOND  
JEWELRY.

26 Maiden Lane,  
(Southwest Corner Nassau Street)

NEW YORK.

PARIS ADDRESS:  
5 SQUARE DE L'OPERA.

**BAGG, PERINE & CO.,**  
RARE SPECIMENS OF  
DIAMONDS AND OTHER  
PRECIOUS STONES,  
21 & 23 MAIDEN LANE, NEW YORK.  
Tel. No. 6226 Cortlandt.

EMERALDS,  
DIAMONDS  
AND  
PEARLS.

RUBIES AND  
SAPPHIRES.

CABLE ADDRESS:  
MILBAGG.

## CROSSMAN COMPANY

☞ Be sure and keep us in mind before buying your Fall line of Necklaces and Pendants. We are getting out a nobby line of Necklaces and Pendants set with Baroque Pearls and Colored Stones.

☞ We also have a nice line of Baroque Pearl Rings, Brooches, Collars, Ear Studs, Scarf Pins, Lorgnette and Neck Chains always on hand. Memo. business will receive prompt attention.

3 Maiden Lane - New York

## FREDERICK A. JEANNE

"GEMFINDER"

5 SQUARE de l'OPÉRA, PARIS, FRANCE

Extends to the trade a cordial invitation to make his office their headquarters when visiting Europe for the purchase of Precious Stones. In order that his customers may enjoy the favorable opportunities that arise when they are not in the market, "Gemfinder" will, on his own account, pick up any desirable goods obtainable in European markets at attractive prices. His customers shall have the benefit of his expert selections at a mere commission above the purchase prices.

## Boston.

F. W. Bird, with Foster & Co., has gone to Torbrook Mines, N. S., for an outing.

Sam Mendelssohn, of the Washington building, is on a three weeks' business trip in Maine.

William L. Clark & Co., jobbing jewelers in the Washington building, have given up their headquarters here, and Mr. Clark has gone to Memphis, Tenn.

W. E. Stormont soon leaves the employ of C. S. Blake, where he has been for the past four years, to take a position in the finishing department at the Waltham Watch Co.'s factory.

Harold B. Carruth, with Nelson H. Brown, is in camp at Fort Rodman with the 1st Regiment, M. V. M., of which he is a member. F. M. Rollins, inside salesman for Nelson H. Brown, is touring this week in southern Maine.

Work was resumed last week at the Waltham Watch Co.'s factory after the annual vacation, during which needed repairs were made. The company now employs about 3,600 hands, and is entering upon what promises to be a very busy season.

The Bentley Jewelry Co., of this city, through Treasurer Fred B. Guild, has filed with the Secretary of the Commonwealth the following annual corporation report: Leases, \$53,924; merchandise, \$10,468; good will, \$5,357; capital stock, \$50,000; accounts payable, \$6,425; surplus, \$7,745; profit and loss, \$5,579.

Harry Levison, charged with stealing jewelry valued at \$1,239 from Louis Sonnabend, was arraigned July 17 in the Superior Court, and held in continuance, with bail fixed at \$2,500. The articles alleged to have been taken include 30 watches, worth \$25 each, 30 rings worth \$5 each, three rings worth \$50 each, and 27 chains worth \$7 each.

Walter B. Snow, who was recently elected president of the Littlefield Silver Co., whose factory is at New Bedford, Mass., severed his connection with the Poole Silver Co., of Taunton, last week. He had been the Boston selling agent of the latter concern since its formation about 15 years ago, having an office in the Jewelers' building, which he will retain and make the headquarters of the Littlefield company in future.

## New Orleans, La.

Coleman E. Adler has been in New York for the past week attending to matters having to do with the magnificent silver service which is to be presented to the battleship *Louisiana*. Mr. Adler has given the contract for the work to the Frank W. Smith Co., Gardner, Mass. The committees appointed under Mayor Behrman are still hard at work on their task of raising funds and gratifying results have already been achieved. Out of the 58 country parishes of the State, all have shown a readiness to respond to the call for funds with the exception of Avoyelles and Sabine parishes. Work on the service will be rushed and everything will be in readiness for the presentation when the vessel comes to New Orleans in October or November, according to the present plans.



# Our Traveling Representatives



J. F. Dean, a traveling salesman for Reed & Barton, Taunton, Mass., has been spending a week at New York.

Frank H. Chace, Chas. M. Robbins Co., Attleboro, Mass., left Saturday for a trip to the far west, with his samples.

W. R. Cobb, of W. R. Cobb & Co., has been ill, at the Baltimore Hotel, Kansas City, Mo., for several days, but will continue his trip.

F. J. Bross, of the traveling force of L. Bauman Jewelry Co., St. Louis, Mo., has returned from an extended visit to Lake Minnetonka. Mr. Bross claims to have caught an eight-pound pike.

Among the representatives of wholesale houses who, recently, visited the trade at Detroit, Mich., were: B. J. Hirshom, Brown & Dean Co.; W. H. Cushman, Woodman-Cook Co.; Mark Franklin, Bradley Ring Co.

E. H. Ray, the Texas representative of the Edwards & Sloane Jewelry Co., Kansas City, Mo., was in Kansas City, Mo., this week, getting his trunks. He is the last of the representatives to get out on the road.

Julius Newman, of the Aller-Newman-Wilmes Jewelry Co., St. Louis, Mo., departed, Monday, for a trip through Missouri, and W. F. Wilmes, of the same firm, for a trip over his territory in Kansas and Oklahoma.

H. F. Wells, who travels for the Woodstock-Hoefer Jewelry Co., Kansas City, Mo., in Iowa and Minnesota, has been home for a week. E. C. Cleveland, who travels for the same company, has just started out on his Nebraska territory.

Among the traveling representatives in Lancaster, Pa., recently, were: Max Bauman; William H. Rowland, Meriden Britannia Co.; Charles Mclehor, Aikin, Lambert & Co.; Allen Felencer, N. H. White & Co.; C. H. Mountjoy, C. F. Rump & Sons; Thomas D. Bailey, Robert S. Gatter; A. Pretzfelder, L. W. Levy & Co.

Among the traveling representatives to visit Buffalo, N. Y., last week, were the following: H. P. Coulter, Libbey Glass Co.; Mr. Reed, Reed & Barton; H. H. Bönnel, Henry Ginnel & Co.; J. W. Cough, Hull Bros. Umberlla Co.; Alberto J. Schweizer, Ansonia Clock Co.; Benj. Schloss, A. Wallach & Co.; Thomas D. Bailey, Robt. S. Gatter; W. J. McKenna, Kelly & Steinman.

Among the traveling salesmen who called on the trade in St. Louis, Mo., last week, were the following: Robert E. Kehl, F. H. Noble & Co.; Alberto S. J. Schweizer, Ansonia Clock Co.; E. J. Haasm, Adolphe Schwob; W. K. Helmbold, National Optical Co.; W. A. Moore, F. W. Gesswein Co.; O. F. Samuelson, Towle Mfg. Co.; A. T. Hatch, S. B. Champlin Co.; L. Strauss, C. P. Goldsmith & Co.; Lewis P. Cook, S. Sternau & Co.

Traveling representatives who called on the Cincinnati, O., trade, during the past week, included: Fred Foster, Unger Bros.; W. M. Gibbs, J. Hoare & Co.; Mr. Lorenzo, Saunders, Meurer & Co.; C. W. Reynolds, C. W. Reynolds & Co.; F. C. Seues, Bates & Bacon; Mr. Cobb, W. R. Cobb & Co.; George R. Sweet, R. F. Simmons Co.; Arthur Bradshaw, International Silver Co.; Charles Untermeyer, Charles Keller & Co.; J. M. Torbert, Simeon L. & George H. Rogers Co.; A. M. Liebman, E. P. Reichelm & Co.

The following traveling salesmen have been calling on the trade in Kansas City, Mo., during the past week: H. W. Raymond, Worthington & Raymond; Abel King, I. Emrich & Co.; T. B. Ross, John Russell Cutlery Co.; D. N. Weil, Electric City Box Co.; Harry S. Aicher, Alvin Mfg. Co.; Edgar Huhn, Potter & Buffinton Co.; H. F. Chapman, Rockford Silver Plate Co.; Samuel Jacobson, Jacobson Bros.; Mr. Townsend, Kreis & Hubbard; W. A. Moore, F. W. Gesswein Co.; Robert E. Kehl, F. H. Noble & Co.

The following traveling representatives visited Omaha, Nebr., last week: Abel King, I. Emrich & Co.; A. I. Duval, H. C. Fry Glass Co.; C. Dominick, H. F. Hahn & Co.; J. Mednikow, J.

Mednikow & Co.; G. W. Milligan, Quaker City Cut Glass Co.; P. A. McCourt, Julius H. Brauer, Alfred M. Tanhauser, Wolfsheim & Sachs; H. W. Raymond, Worthington & Raymond; Hlugh E. King, Queen City Silver Co.; Mr. Clark, Oncida Community, Ltd.; W. H. Torrance, Leys, Christie & Co.; J. M. Pool, American Silver Co.

## Providence.

The Art Die Sinking Co. has engaged Edwin Scott, well known here and in the Attleboros as a skilled workman, as foreman.

Among the imports at the port of Providence last week were four packages of imitation precious stones from Bremen and one from Hamburg.

The following have been in town during the past week looking for novelties: Mr. Berg, New York; Miss Rosenbaum, Chicago; Miss Graff, New York, and Miss Roe, Chicago.

George Sylvester, who was an employe of the Ostby & Barton Co., was fined in the District Court last week for the theft of 12 rings, valued at \$40. He pleaded guilty when arraigned, and was sentenced to the Providence County jail for three months.

Last September, while on her way to the Agawam Hunt Club in an auto, Mrs. Stephen O. Metcalf lost a gold pin set with pearls and diamonds. The other day a Portuguese offered it for sale at a Bristol jewelry shop, and the police took possession of the circlet when they learned that the man had found it. Later it was returned to the owner.

Reed & Barton have filed a suit in the Superior Court against Charles E. Paine, of this city, alleging that the plaintiff was the owner of 25 dozen oyster spoons, 50 dessert spoons and a lot of other tableware, and that the defendant converted the same to his own use June 18, 1906. The damages are placed at \$800, though the price of the goods is alleged to have been \$844.80.

## Jewelers Gold Bars Withdrawn and Exchanged at New York.

Week Ended July 21, 1906.

The U. S. Assay Office reports: Gold bars exchanged for gold coin.....\$387,182.12 Gold bars paid depositors..... 87,864.77

Total .....	\$475,046.89
Of this the gold bars paid depositors are reported as follows:	
July 16.....	\$9,214.04
" 17.....	4,492.34
" 18.....	26,839.54
" 19.....	11,039.36
" 20.....	30,293.59
" 21.....	5,985.50
Total .....	\$87,864.77

## Market Price for Silver Bars.

The following are the quotations of silver bars in London and New York, as reported by Zimmerman & Forshay:

	New York.	London.
July 17.....	\$.65 $\frac{3}{4}$	30 1-4d.
" 18.....	.65 $\frac{1}{2}$	30 1-4d.
" 19.....	.65 $\frac{1}{4}$	30 3-16d.
" 20.....	.65 $\frac{1}{4}$	30 3-16d.
" 21.....	.65 $\frac{1}{2}$	30 5-16d.
" 23.....	.65 $\frac{1}{2}$	30 5-16d.
" 24.....	.64 $\frac{7}{8}$	.30d.

A horse tied to the street clock of L. T. Dillon & Co., Litchfield, Minn., became frightened and pulled away, wrecking the clock.

## ELSIE BEE'S FASHIONS.

NOVELTIES SEEN IN A LADY'S RAMBLES AMONG THE JEWELERS.

A GOLD hunting-horn, winding once around an opal ball, is a peculiar and original design in scarf pins.

A necklace of uncut stones is said to be one of the latest ideas.

A fancy ring top shows an open design outlined in diamond scroll work and enclosing a fine, round pearl.

An otherwise plain gold basket for sweets has an ornamental top handle, embellishing the pretty trinket.

Diamond tiaras and diamond-topped back combs are sometimes pointed with clusters alone, or in alternation with the single diamond points.

The little foxes, that gnaw the vines, form an appropriate ornament for the handle of gold or silver grape shears, simulating the twisted vine.

Beautiful round pearls set high in the surrounding diamond work catch and retain the eye most pleasantly in a charmingly simple, but expensive, brooch.

A locket of unique effect is of perfectly plain, bright gold, in heart shape, with a good-sized turquoise framed with the same small gems as a central ornament.

An eminently chic appearance is imparted to a corsage ornament by a large, square-cut emerald, which simulates the knot in a costly ribbon bow, in diamond work, showing a pattern in the ribbon.

Pendant brooches are a pleasing variation on the usual styles, some being extremely ornate with pendants varying in size. In a design recently seen, the brooch of somewhat triangular form displayed a fine green tourmaline elaborately framed in diamond work, with square pendant, hanging cornerwise from the brooch itself. The pendant, being slightly smaller than the brooch, was composed of a similar green stone set about with diamond work.

One is perforce obliged to notice again the insistent bracelet which still proclaims itself a favorite of Dame Fashion; whether in styles extravagantly elegant or extravagantly simple, it matters not. In a recent display of the ever-popular gold-band bracelets and bangles, styles ranged from the slightest plain half-round models, through the twisted ropes, the chains, the perforated half-inch bands, the heavy half-round and inch-wide bands in gold filigree—plain, or set with stones, or perhaps set with a tiny watch. A pretty bracelet for a child shows squares of pink tourmalines framed in fine gold filigree, connected at top and bottom with a short row of round pearls.

The Josten Mfg. Co., Owatonna, Minn., has been incorporated with \$25,000 capital stock to manufacture watches and clocks, jewelers' fittings and tools.

# EICHBERG & CO.,

IMPORTERS AND CUTTERS OF

## DIAMONDS,

65 NASSAU STREET, (Prescott Building.) NEW YORK.

# STERN BROS. & CO.,

IMPORTERS AND CUTTERS OF

## DIAMONDS,

CUTTING WORKS: 68 Nassau St.,  
138-142 West 14th St., N. Y. NEW YORK.  
CHICAGO, LONDON,  
103 State St. 29 Ely Place.

HORACE A. DWYER, President.  
11 years with Tiffany & Co.  
9½ years with Garreaud & Griser  
Awarded a Diploma by the  
Exposition at Chicago, 1893

HENRI CASENOVE, Sec. & Treas.  
12 years with Tiffany & Co.  
MINERALOGIST

H. O. DREHER, Vice-President  
12 years with Tiffany & Co.  
2½ years with Shreve & Co.  
Awarded a Medal and Diploma  
by the Exposition at Paris, 1900

*"There is Nothing in the Art that we cannot do."*

## The International Gem Co. Inc.

12-16 JOHN ST., NEW YORK  
TELEPHONE, 1241 CORTLANDT

### LAPIDARIES and IMPORTERS of PRECIOUS STONES

SPECIALISTS IN REPAIRING AND REPOLISHING RARE AND VALUABLE GEMS  
DRILLING — ENGRAVING — SLITTING

# CHAS. S. CROSSMAN & CO.

The "Old Mine" Diamond House

Are always ready to make cash offers on Diamonds, Fine Antique  
Jewelry of all descriptions, Pearls and Precious Stones.

ESTABLISHED 1880 ESTATES A SPECIALTY  
3 MAIDEN LANE.

N. B.—Our Baroque Pearl Jewelry Manufacturing Business has been  
incorporated as the CROSSMAN COMPANY



TRADE MARK.

## AZTEC TURQUOISES

Mines: MINERAL PARK, ARIZONA.



TRADE-MARK.

Of true CERULEAN BLUE, the rarest and most fashionable shade. Turquoises bearing Company's trade-mark are GUARANTEED. A new Turquoise will be given without question to replace any that discolors. The leading Jewelers of the World sell AZTEC TURQUOISES.

THE AZTEC TURQUOISE COMPANY,  
12-16 JOHN STREET, NEW YORK.

## Philadelphia:

John Oberholtzer, with J. B. Bechtel & Co., is spending a vacation at Atlantic City.

Wm. Long, 1619 South St., started last week on a vacation trip to the White Mountains.

Bernard Harburger, of Harburger Bros., has returned from a month's trip through Europe.

Emil Bracher, 929 Chestnut St., returned last week from an extended trip through New York State.

Gus. Dorn, 834 Market St., Camden, is spending midsummer with his family in New York State.

A. Hoppis, watchmaker, with Walter Engle, 4233 Lancaster Ave., is spending a vacation at Atlantic City.

Dan Douglas, representing the William C. Penfold Co., recently returned home from a six months' trip in the south and west.

George A. Bowen, of the firm of T. H. Bowen & Co., Bridgeton, N. J., stopped off in Philadelphia last week on his way home from a pleasure trip to Boston.

Paul J. Kugler, watchmaker for John Lang, Atlantic City, but formerly of this city's trade, is receiving the congratulations of friends in the trade upon his marriage last week.

Edward Williams, head of the goldsmithing department of M. Sickles & Sons, charged Abraham Lawrence, one of the employes, last week, with the theft of gold clippings worth about \$500. Lawrence was arrested and held in \$600 bail for trial. It is not believed that any other employe have been guilty of peculations.

A card was brought back to the trade of this city by a tourist of Canada last week and exhibited as a novelty. It was that of F. Clarke & Son, Warkworth and Stirling, Ontario, who style themselves "watchmakers, jewelers and opticians. Issuers of marriage licenses." Just how the firm happens to get in the marrying business is what puzzles the trade here.

Wm. H. Dawson, for many years with Maiden Lane houses, has accepted the position as salesman and stock clerk for M. Sickles & Sons. Mr. Dawson is reputed by years of experience to be especially experienced as a stock clerk. The position he occupies now with M. Sickles & Sons is a new one, made to facilitate the constantly increasing business of this firm.

Frank Thoman, formerly a Camden retailer, a brother of Horace Thoman, of Woodbury, N. J., and a well-known watchmaker, is receiving the condolences of the trade upon the death last week of his wife. He had taken her to California, but was forced to bring her east again. Mr. Thoman is now at Glassboro, N. J., but expects to re-engage soon in business in this city or Camden.

Max Polak, of M. Sickles & Sons, has been advanced to the position of traveling salesman, and will hereafter represent the firm in New Jersey, Delaware, Maryland and West Virginia. Mr. Polak will call on the trade, beginning Aug. 1. Walter S. Davis, city salesman for M. Sickles & Sons, is spending vacation days at Cape May. Nat. Kinckiner is at Kimberton, Pa., with his family, and James McMillan is away.

### News Gleanings.

S. A. St. Cyr, Clinton, Ia., moved recently to Peterson, Ia.

J. M. Dunn, Elizabethton, Tenn., has gone to Jonesboro, Tenn.

Staples & Selner, Fosston, Minn., have dissolved partnership.

Charles E. Barker, formerly of Peterson, Ia., is now at Royal, Ia.

R. W. Wilson has bought out William Strickler, Miller, S. Dak.

O. F. Rohwedder has sold out his jewelry store in Sherburne, Minn.

A. W. & E. J. Hyde, Gowanda, N. Y., have been succeeded by C. D. Barnes.

Wm. L. Kitchell, Hempstead, N. Y., has given a bill of sale to his mother.

Mrs. C. H. Lickford, Winona, Miss., has been succeeded by N. W. Lickford.

Smith & Ward, Greenfield, Ind., have dissolved, J. Henry Smith continuing.

N. W. Frantz has purchased the business of Mogle & Means, Winfield, Kans.

The stock of Charles E. Fullwood, Galeton, Pa., will be sold by the sheriff.

S. M. St. John, Calhoun, Ga., moved recently to Dallas, in the same State.

Mr. Shorey has retired from the jewelry firm of Reuch & Shorey, Glendora, Cal.

E. M. Nelson's store in Williston, N. Dak., was robbed of \$300 worth of goods.

Elmer Hartman, Bowbells, N. Dak., is erecting a building for his jewelry business.

Rudisill Bros., Altoona, Pa., have dissolved, W. W. Rudisill continuing as heretofore.

J. F. Kenly, Caldwell, Idaho, has sold out his interest, at that place, to Charles A. Green.

Harris & Esterly, Duluth, Minn., have dissolved partnership, E. E. Esterly succeeding.

Evington & Wilson have succeeded to the jewelry business of G. L. Evington, Lebanon, Mo.

Ristrom & Erickson, Braham, Minn., have dissolved, S. E. Erickson continuing the business.

The Ontario Silverware Co., Muncie, Ind., will close down for a short time in August for repairs.

W. J. Starks now has his jewelry repair business in the Post Office building at Ellijay, Ga.

Staats, Raynes & Adams have succeeded to the business of Charles Whitcomb & Co., Clinton, Ind.

Charles G. Kay, father of Charles B. Kay, of Charles L. Crawford & Co., Peoria, Ill., died last week.

Sassowsky & Amadee have purchased the business of the LaFourche Jewelry Co. in Thibodeaux, La.

Mr. Renkle, with W. G. Wood, Swainsboro, Ga., has moved his family from Atlanta to that city.

M. H. Borden, Cookeville, Tenn., has admitted a partner, and the firm style will be Dodson & Borden.

J. W. Kegrice, Ida Grove, Ia., has gone to Canada to look over the country with a view to buying land.

Cilley's drug store in Mediapolis, Ia., was recently entered and a number of watches were stolen.

Lindenberg & Fox, Cincinnati, O., expect to have their new catalogue ready to mail the trade about Aug. 1.

The business conducted by Charles L. Taylor, Camilla, Ga., has been incorporated as the City Jewelry Store.

Walter Luhrsen has sold his jewelry business at Laona, Wis., and has bought a stock in Red Lodge, Mont.

M. Greenwald, Tuscon, Ariz., has admitted Mr. Adams into the business under the style of Greenwald & Adams.

E. H. Wanamaker's new store at 723 Hamilton St., Allentown, Pa., will be ready for occupancy in a few days.

Philip Diels has fitted up rooms at 4th and Adams Sts., Marion, Ind., where he has installed his stock of jewelry.

Ehrenberg & Wurkheim, Oakland, Cal., have dissolved partnership. The business will be continued by S. Wurkheim.

Frank E. Dumas will carry on the business of Cooper & Dumas, Kewanna, Ind., that firm having dissolved recently.

The firm style of the business formerly conducted by Saunders, Martin & Co., Bonham, Tex., is now Saunders Drug Co.

Watches and chains to the value of \$125 were stolen, one night last week, by burglars from the store of T. A. Shearin, South Hill, Va.

C. F. Godfrey, for a long time manager of the Shoe City Jewelry Co., Brockton, Mass., has resigned and has been succeeded by C. M. Jeffs.

Geo. F. W. Bewig, Selma, Ala., has merged with Schweizer Bros., of the same place, under the style of the Schweizer, Bewig Jewelry Co., Inc.

George Wooley, Carthage, N. Y., has lost his false teeth, and thinks that he has swallowed them, but an X-ray examination fails to reveal them.

A hearing will be given, August 4, in the United States District Court, Texarkana, Ark., on a motion to grant to George A. Wheeler a discharge in bankruptcy.

A valuable collection of aquamarines, the property of S. H. C. Renolds, is being exhibited in the show window of the Bangor Jewelry & Optical Co., 71 Main St., Bangor, Me.

The August Bruder Co. was recently incorporated to carry on the business of August Bruder, Fort Wayne, Ind., with an authorized capital stock of \$40,000, all paid in.

H. Bealmear & Co. have leased the building at 25 W. Baltimore St., Baltimore, Md., now occupied as a ticket office by the Western Maryland Railroad Co., and will conduct a jewelry establishment.

Frank Stannard, who for the past five years has been employed by the Geneva Optical Co., Geneva, N. Y., left last week for Omaha, Nebr., where he has accepted a position with the Columbia Co., of that city.

Wm. H. Lewis, who for years conducted a jewelry store at River St., near Broadway, Albany, N. Y., died recently at his home in that city in his 63d year. He was a native of New York City. Four sons and a daughter survive.

J. H. Sohn, Ocean Park, Cal., has bought the jewelry and optical business of G. L. Webber, Pier Ave., and has taken charge of the establishment. Mr. Webber will remain with Mr. Sohn and devote his entire time to the optical department.

At Northboro, Mass., last week, Sumner

Goddard, a retired jeweler, died at the home of Mrs. Walter Brigham. Mr. Goddard was born in Boston, Feb. 18, 1826, and was educated in that place. He had lived in Ashland, Keene, N. H., and Worcester.

At Gloversville, N. Y., a man living over the A. D. Norton Co.'s store, recently attempted suicide by setting fire to his bed clothing, after saturating nearly everything in the room with kerosene oil. The blaze was extinguished before the flames reached the store.

J. C. Mellichamp is to open his finely equipped new store at 70 Whitehall St., Atlanta, Ga., Aug. 15. Mr. Mellichamp has recently returned to Atlanta after a visit to New York, where he bought stock. The store has been thoroughly renovated and refitted in an attractive manner.

At the annual meeting of the stockholders of the Middletown Silver Co., Middletown, Conn., these directors for next year were elected: Charles Fountain, Joseph Merriam, F. L. Sage and Eddie S. Davis, Middletown, and Minn S. Cornell, Brooklyn, N. Y. The old board of officers were re-elected.

Conforming to the rigid laws of Massachusetts, the jewelers' association of that State has filed a report with the Secretary of the Commonwealth, saying that during the last session of the Legislature its official agent at the State house was the law firm of Sughrue & Chase, serving without salary.

In Ira N. Clawson's jewelry store, Watkins, N. Y., a man giving his name as A. A. Hurd, of Montour Falls, last Wednesday told a hard luck story and pawned his watch and chain for \$2. A short time afterward, the jeweler says, the man returned, and, claiming that he had the \$2 to redeem the timepiece, grabbed it from the jeweler, who caused the man's arrest.

Mrs. Rebecca Small, wife of Moses Small, jeweler, at 510 Exchange St., Geneva, N. Y., died Saturday at the family home, 12 Elmwood Ave. Mrs. Small was 38 years of age, and had been ill only a few days of diabetes. Mr. and Mrs. Small moved to this city about four years ago from Waterloo, where Mr. Small was formerly engaged in the jewelry business. The funeral took place Monday from her mother's home in Syracuse.

At Asheville, N. C., the large plate glass show window in Mrs. M. Alexander's store was broken last Sunday morning by thieves, who took a number of articles. The store is on a principal business street, and in a glare of electric lights. The glass was broken with a brick, which was found inside, and the thief, reaching in his arm, took everything he could grab. The hole in the glass is about the size of a small watermelon.

After carving through a panel in the rear door of the Sarbach Jewelry Co.'s store, 231 N. 9th St., Lincoln, Nebr., burglars made a thorough search of the premises. When Mr. Sarbach and his assistants opened the store next morning they found that 47 dozen rings had been taken, in addition to studs, watch fobs and jeweled combs. The burglars did not succeed in finding the more costly jewelry. The loss will exceed \$200. The safe was opened and papers scattered about.

# AMETHYSTS

THE POPULARITY OF THIS BEAUTIFUL VARIETY OF THE

## QUARTZ FAMILY

HAS CREATED A DEMAND WHICH IS OUTSTRIPPING THE SUPPLY.

WE HAVE A STOCK OF THE CHOICEST

**URUGUAY, BRAZILIAN and AMERICAN  
ROUGH AMETHYSTS**

WHICH WE ARE PREPARED TO CUT INTO  
**BROOCH CENTERS and FANCY SHAPES**  
AT MODERATE PRICES.

WE ALSO HAVE A GOOD LINE OF FINE

**SIBERIAN AMETHYSTS**  
IN EUROPEAN AND OUR OWN CUTTINGS.

## BUY FROM THE CUTTERS

### AMERICAN GEM & PEARL CO.

14 & 16 Church St., NEW YORK

LONDON: 16 Holborn Viaduct

PARIS: 39 Rue de Chateaudun

**A. ROSEMAN, 9-11-13 Maiden Lane, New York**

IMPORTER OF

## DIAMONDS

Maker of Diamond Jewelry



TRADE-MARK.

Established 1872

HEADQUARTERS FOR

## AMERICAN WATCHES

IMPORTERS

## DIAMONDS

CUTTERS

### Jacob Strauss & Sons

14 MAIDEN LANE

NEW YORK

**SOHN and HYMAN**

IMPORTERS OF PRECIOUS AND IMITATION STONES

Crystals Engraved and Painted from Photo. Crests and Coats of Arms Engraved. Stone Seal Engravers and Incrusters. Lapidary Work a Specialty.

**JOBGING STONES A SPECIALTY**

47 and 49 Maiden Lane,

NEW YORK

THE BOSTON DIAMOND HOUSE

## JOHN B. HUMPHREY CO.

387 Washington St., Boston, Mass.

We are receiving Monthly Shipments of Diamonds from our Brazilian Mines, which are on exhibition at our Boston Office.

**TRADE-MARKS** OF THE JEWELRY AND KINDRED TRADES.  
Over 4,000 Marks. Second Edition. Price, \$3.00.  
The Jewelers' Circular Pub. Co., 11 John St., N. Y.

## Buffalo, N. Y.

J. H. Ullenbruch, with his wife, goes to Detroit next week for a visit with relatives.

Frank Harns, in charge of Meyer Brown's watchmaking department at 136 Seneca St., is ill at his home.

J. Ansteth, of the Mooney-Brisbane building, and wife are enjoying a vacation trip to Albany, Troy and Cohoes.

W. W. Berry, for two years in charge of the optical department in C. F. Chouffet's jewelry store, 379 Main St., has located in Escanoba, Mich., where he is manager of an optical store.

Robert Ritter's jewelry store at 857 Seneca St. was damaged to the amount of \$2,500 by fire last Thursday afternoon. An overheated gas stove in the rear of the store ignited the woodwork. The loss is fully covered by insurance. Mr. Ritter's loss was wholly on stock.

T. C. Tanke, whose store is at Main and Eagle Sts., is on his way to Holland. He will go from Holland to Germany, which he will tour, and then go to England by way of France, returning to America in the middle of September. His son, Eugene Tanke, came home in May from an extended trip to the Holy Land. Charles Beer, for many years with Mr. Tanke's retail store, is in New York for his vacation.

Jireh Kinney, a pioneer jeweler, now at 92 Seneca St., whose home is in East Aurora, is most anxious concerning the condition and fate of his son Paul, aged 17 years. On the evening of July 9 Paul Kinney was found in a public highway a mile from his home in an insensible condition. By his side was his bicycle, the front forks of which were broken. The young man has been unconscious continuously since he was found, being asleep most of the time. Specialists from Buffalo say the young man's skull is not fractured, and they regard his condition as being most unusual. They believe, however, that in time the young man will fully recover.

Walter M. Wilson, one of the leading pawnbrokers of this city, doing business at 327 Main St., was thrown from an automobile on the Williamsville road Friday afternoon and killed. His brains were dashed out by his head striking against a pile of railway ties. Mrs. Wilson, who was also thrown from the automobile, landed in a cornfield, 100 feet from the point where the machine struck a telephone post. One of her legs was broken, she was badly bruised, and it is feared she sustained grave internal injuries. She was not informed of her husband's death until yesterday. At her request the body of Mr. Wilson will be incinerated in this city. Mr. Wilson was 38 years old, and he was one of the most popular young men of the city. The funeral was held Monday afternoon.

An addition is being made to Chas. E. Gifford & Co.'s store, Fall River, Mass. A two-story brick structure 29 x 30 feet in square dimensions will be constructed at the back of the present store. The addition is to be handsomely finished, and both floors are to be used for the display of stock. An elevator will be one of the improvements.

## Connecticut

The New Haven Clock Co., New Haven, resumed work at its factory last week.

Auxiliary fire alarm boxes are to be installed by the International Silver Co. in its Meriden plants.

Richard Walkley, for many years employed at the International Silver Co.'s factory, Shelton, died last week.

Hon. E. B. Dunbar and Walter A. Ingraham have just been re-elected vice-presidents of the Bristol Savings Bank.

Chris. Waremer was, last week, elected president of the Swiss Dial Co., Waterbury. Leon Schupbach is treasurer and Olga Wuest, secretary.

Albert T. Hill, employed in the casting department at E. Miller & Co.'s factory, Meriden, was knocked down by a bicycle scorcher last Thursday evening, and severely bruised.

William J. Smith and Samuel Hume, foremen at Landers, Frary & Clark's factory, New Britain, have returned from a trip abroad. They traveled in England, France and Italy.

George D. Munson and Chas. D. Morris have been elected members of the finance committee of the Dime Savings Bank of Wallingford. Mr. Morris is also a member of the bank's loaning committee.

Arthur E. Hobson, superintendent of the Barbour Silver Co.'s factory, Meriden, returned on Saturday on the steamship *Cambania* after a five weeks' business and pleasure tour of Europe. This was his 14th trip to Europe.

R. S. Gardner, of the Gardner & Hall Co., and family, Derby, are spending the last two weeks of July on Block Island. Mrs. S. W. Hall, of Derby, with her two daughters, has gone to Cape Cod for July and part of August.

Two handsome sterling silver cups have been presented by C. H. Leonard, jeweler, Winsted, to the Greenwood Country Golf Club. The cups will be awarded to the winners of gentlemen's and ladies' tournaments to be played probably in September.

Albert Seilinger, an employe in the factory of the C. F. Monroe Co., Meriden, has brought suit for \$100 damages against James Zuellt, who was formerly employed in the same factory. The plaintiff was stabbed by the defendant last March, it is claimed, and was incapacitated for some time from working.

A writ in replevin was obtained last week against Emil Mendil, 77 Broadway, New Haven, in an action brought against him by the Moline Jewelry Co., Iowa City, Ia., to recover \$200 claimed to be due as the purchase price on a sale of merchandise. The suit is returnable to the City Court to-morrow in the City Court.

According to the certificate of incorporation of the Munson Co., Hartford, filed last week, it is to deal in silverware in addition to various other lines. The amount of capital stock authorized is \$50,000, and it is to start business with \$10,000. The incorporators are E. H. Warner, F. H. Williams, Jr., and C. E. Ripley, all of Hartford.

Twenty-five young women clerks are reported in a sensational story sent out to a New York paper to be implicated in the systematic robbery of a department store in

Waterbury. It was said in the report that they took cut glass, jewelry and other articles, and that one of the girls, about to be married, had collected a most comprehensive and handsome trousseau.

N. Schneider, Meriden, one of the old employes at the International Silver Co.'s main factory, sailed, last Thursday, on the *Kaiserin Auguste Victoria*, for a trip to Germany. Wm. Fitzgerald, employed in Factory H, Meriden, has been elected vice-president of the Central Labor Union of Meriden. Joseph D. Wright, employed at the office of factory E, Meriden, will sail with his brother, Robert Wright, of Yonkers, N. Y., on the *Germania*, July 31, for Europe.

After being in business for 29 years in Stamford, Clasen W. Hoyt, last week, sold out to Frederick W. Karsch, of New York. For some time Mr. Hoyt has been desirous of enjoying a period of rest and he took advantage of an opportunity to sell his store to a personal friend of long standing. Mr. Karsch is being introduced to Mr. Hoyt's trade as a practical watchmaker and jeweler. The new comer is to make a specialty of an optical department, and at the same time to keep the jewelry lines up to a high standard.

The Brainard & Wilson Co., manufacturers of silver plated novelties, last week, began operations in its new plant on Thorpe St., in Danbury, having abandoned its cramped quarters on Montgomery St. The main building of the new plant is a brick structure, 32 by 144 ft., two stories high. The factory has two wings, one of which, the casting room, is 28 by 40 ft., and the other, the plating room, is 32 by 56 ft. The engine house is 24 by 26 ft. The new plant will enable the company greatly to increase its output, and its force of employes will be materially augmented.

## North Attleboro.

Frank M. Whiting & Co. and F. S. Gilbert closed on Saturday until Aug. 6.

An accident to a blower compelled the George L. Paine Co. to close Friday of last week.

Frank Kennedy, New York representative of the Paye & Baker Mfg. Co., and William B. Peckham, of J. H. Peckham & Co., were at the factory this week.

Work commenced this week on the addition 40 by 28 which is to be added to the Riley & French building for the convenience of C. Ray Randall & Co. The addition must be complete in four weeks.

Owing to the great increase in business during the past year, R. Blackinton & Co. have been obliged to secure additional rooms. Consequently the owners of the Whiting factory wherein they are located have given out the contract for an addition 36 by 48 feet on the south side. The extra floor space will be utilized by the engravers and die cutters and part of it by the packing room help. The contract calls for the work to be done within a month.

The promoters of the new manufacturers' jewelry factory that will be erected on Elm St. have practically come to an agreement upon the plans and the figures of the contractors. The contract is expected to be given out within a few days and actual

building will start immediately. The building, it is announced, will be a three-story brick structure of mill construction and will have approximately 35,000 square feet of floor space. It will be shaped like a letter L, and will be built of red brick, and will have a grass course of granite around the entire building. It is anticipated that the H. D. Merritt Co., W. G. Clark & Co., estate of O. M. Draper, E. I. Franklin & Co., and the Bugbee & Niles Co. will engage space in the building.

## Attleboro.

The Bliss Bros. Co. will close its factory July 28 for two weeks.

Fred W. Lincoln, of J. M. Fisher & Co., is spending his vacation at Capitol Island, Me.

Maxy W. Potter, with J. M. Fisher & Co., back from five weeks in the central west, is more than ever sanguine that this will be the banner year in the jewelry trade.

James E. Blake, of the James E. Blake Co., last week voluntarily gave the town a long strip of land to widen and benefit the appearance of one of the central business streets.

Official announcement was made last week that the annual shut-down of two weeks in the large group of jewelry factories owned by Charles H. and William C. Tappan, will not take place. In past years, when these were the property of Joseph M. Bates, this was a custom which enforced a vacation on a score of firms and over 1,000 workers. Additions to the power facilities and the great rush of work at this time caused a suspension of the practice.

Charles M. Robbins of the Chas. M. Robbins Co., lost his wife last week, Mrs. Robbins yielding to a long illness. Among those to whom the family was personally known, Mr. Robbins is the object of deep and sincere sympathy in his loss owing to the general recognition of the deceased's sterling qualities. In jewelry and other business circles Mr. Robbins has the sympathy of associates and acquaintances. At the funeral the employes of the company sent a handsome floral tribute. The bearers included David E. Makepeace, of the D. E. Makepeace Co.; Willard Rounseville, Frank Mossberg, of the Frank Mossberg Co.; John M. Fisher, of J. M. Fisher & Co., and Edward P. Clafin, formerly of Fontneau & Cook.

The various rating and reports of the Jewelers Board of Trade, including the confidential weekly sheet, are a subject of much favorable comment on the part of the members who write from time to time expressing their appreciation of the work. In a letter received by the Board last week the Towle Mfg. Co., Newburyport, Mass., says: "It is a constant surprise to us to note how perfect and complete are the ratings of the Board of Trade. There is not anything that depends upon the human mind that is absolutely perfect; we all make slips and omissions and errors, but there are so few in the Board of Trade and the general range of the ratings is so good and so near correct that to the writer it is an ideal commercial agency."

# GORHAM SILVER

## BEAUTY, ORIGINALITY AND FITNESS

¶ In no direction is Gorham proficiency in design and dexterity in fashioning more prominently displayed than in the Cups, Vases and Trophies which have this season been prepared as prizes for summer sports and pastimes.

¶ From the simplest of cups to the most elaborate of emblematical special pieces, they bear alike the stamp of originality and significant fitness for their purpose.

¶ Individuality and exclusiveness, qualities so insistently desired by the average prize committee, are characteristic in a marked degree of these, as of all other Gorham productions.

## THE GORHAM COMPANY,

Silversmiths and Goldsmiths

Fifth Avenue and 36th Street, New York.

BRANCHES:

CHICAGO,  
137 Wabash Ave.

NEW YORK,  
23 Maiden Lane.

SAN FRANCISCO,  
Temporary Office:  
1103 Broadway, Oakland, Cal.

LONDON,  
Ely Place.

WORKS: Providence and New York.





PUBLISHED EVERY WEDNESDAY BY  
**THE JEWELERS' CIRCULAR PUB'G CO.,**  
 11 JOHN ST. COR. BROADWAY, NEW YORK.  
 TELEPHONE: CABLE ADDRESS:  
 1148 CORTLANDT. JEWELAR NEW YORK

VOL. LII JULY 25, 1906. No. 24

Subscription in U. S., Canada and Mexico, \$2.00  
 Other Countries in Postal Union, . . . \$5.00  
 Single Copies, . . . . .10  
 Remit by check or money order. Remittances in  
 money are at sender's risk.

Notices of changes in standing advertisements  
 must be received one week in advance; new mat-  
 ter can be received up to Monday.

No attention paid to communications unless ac-  
 companied by full name and address of the writer.  
 This is asked not necessarily for publication, but  
 as an evidence of good faith.

**Index to Special Articles.**

	Page.
A Notable Gold Racing Trophy of the Early Part of Last Century. Illustrated on front cover; text on page.....	36
Alleged Frauds in Diamond Mining Companies in Brazil .....	35
Wm. B. Durgin Co. Purchases Business of Goodnow & Co., Boston, Mass.....	35
Death of Benjamin F. Watts.....	36
Dr. Geo. F. Kunz's Report on Precious Stones —(Continued) .....	37
London Letter .....	39
Clocks, Watches, Jewelry, etc. Shipped to American Possessions .....	39
Four Thieves Steal Diamonds Worth \$2,500 from Utica, N. Y., Jewelers.....	41
Death of Capt. Charles G. Browne.....	43
Death of Andrew K. Jobe.....	43
Massachusetts Lahor Bureau Reports on Jew- elry Pledged at Boston.....	43
Death of A. Jaffe.....	43
Retail Jewelers of Oklahoma Organized.....	43
Thieves Steal Stock Worth \$1,000 from Show Case of Brunner Bros., Cleveland, O.....	45
Daring Theft of Pearl Studs from New York Jewelry Store .....	45
Death of Geo. E. Lowen.....	45
Gorham Mfg. Co. to Abandon Stock Transfer Plan .....	47
Death of Christian Strobel.....	47
The Aikin, Lambert Co. Reorganized.....	47
Death of Harry Helms.....	47
Programme of Optical Conventions at Roch- ester, N. Y. ....	49
Chicago Jeweler Captures Thieves Who Try to Rob Him .....	49
Programme of Jewelers' National Convention at Rochester, N. Y. ....	49
Death of Allan Garrettson.....	49
Progress of the Pennsylvania Retail Jewelers' Association .....	51
Death of Max Goldsmith.....	51
A Notable Sale of Jewels at London.....	51
Elsie Bee's Fashions .....	53
Patent Department .....	79
Trade-Mark Law of Australia.....	81
Jewelry, etc., Exported from New York.....	81
Lecture on Lever Escapement by C. T. Higgin- botham Before the Convention of the Ret- ail Jewelers' Association of Illinois.....	83-85
The Preservation of Drills.....	87
The Optometrist's Catechism—(Continued)...	92
A Means of Saving Time When Refracting...	93
A Case of Defective Eyesight Treated Without Glasses .....	93
How the Jeweler Can Meet Competition of the Mail Order House.....	94
Anent the Business Letter.....	94
A Novel Style of Price Card.....	94
An Attractively Furnished Jewelry Store in Columbia, S. C. ....	95
The Melting of Small Beads of Gold and Silver.	97
A British Criticism of Our Customs Laws Re- lating to China and Pottery.....	99
Some Interesting Facts About the Exposition at Reichenberg, Bohemia .....	99
Working Model of Traction Engine Built by a Missouri Jeweler .....	101

**O**WING to the greatly increased size of THE JEWELERS' CIRCULAR-WEEKLY, it is absolutely necessary that all changes in advertisements be received one week in advance of date of publication if proof is desired. Positively no change can be made after Friday noon for the next Wednesday's issue.

**Stock Swindles in Diamond Mines.** THE continued increase in the price of diamonds during the past few years coincident with the great increase in the supply of gem stones, and the increase in the demand for them in the American market, has produced a condition so unusual as to attract the attention of promoters and investors outside of the jewelry trade. With the fact dawning upon the financial and commercial world that even the natural monopoly of the De Beers Consolidated Mines, Ltd., does not give the company the opportunity to supply all the gems that could be used, the search for diamond fields in other sections of the world besides South Africa goes on with renewed interest and vigor. Everything in the way of a discovery that might in any way, even remotely, lead to the location of a diamond field is heralded abroad in the papers of the world and is read with avidity by people in all countries. Naturally, therefore, the stock jobber and promoter, ever ready to organize in lines which have public attention, has seen in the great publicity given to the diamond situation an opportunity not to be lost, and he is not losing it.

While some attempts have been made without success to organize mining companies for developing properties in regions where alleged discoveries of gems have been made, the shrewder promoters have taken up the old diamond fields in Brazil where diamonds to some extent are still found, as the section in which to locate the companies whose stock they wish to unload upon the public. Their chances of success have been increased by the fact that some legitimate companies are operating in Brazil, though not very successfully as far as authentic reports go. Even members of the jewelry trade have been solicited to take stock in these, and to them we call attention to the note of warning sent from Rio de Janeiro, Brazil, by Consul Geo. L. Anderson, whose report is published in another column of this issue.

In effect Consul Anderson says that although there is much gold and a good many diamonds in the country, and while there are some mines that are being worked by reputable companies and in perfect good faith, there are a vast number of wild-cat speculations that are being floated in London, New York and Chicago that are frauds of the worst sort. He says that the land titles are bad, and if a company buys

ground for a mine it is likely to buy a lawsuit along with it. The diamond mines, he says, are of a totally different character from the well understood mines of South Africa, being in small pockets scattered over a vast extent of territory, and it not only takes expensive machinery to work them, but when one pocket is worked out it is an expensive matter to prospect for a new location and move the machinery. He says the consulate is constantly in receipt of all sorts of letters showing that the very promoters of the companies know little about the country that they are dealing in, and he advises investors to be very careful about putting their money into enterprises with which they are not perfectly familiar.

The report of Consul Anderson was brought forth, owing to the number of inquiries received at the Consulate-General from all over the world.

**Many Jewelry Robberies Reported.** **D**ESPITE the fact that this is generally considered the dull season of the year with jewelers, and one in which the thieves are not usually active because the merchant and his clerks have plenty of time to watch every transaction of suspected customers, nevertheless an unusual number of jewelry robberies are reported in many sections of the country. In addition to the jewelry robberies in Cleveland recently noted in these columns, two more are reported this week, while others, which showed both cleverness and daring on the part of the thieves, occurred in Manhattan, New York, and Utica, N. Y., not to speak of many smaller robberies and attempts at robbery in other parts of the country. From Chicago comes the news of an unsuccessful attempt to hold up a small jeweler, an unusual feature of the news being the report that the would-be thieves had been captured, having been held at bay at the point of the revolver by the jeweler until the police arrived.

Altogether the news of the past few weeks should make jewelers more than usually cautious and impress upon them the fact that at no season of the year are they immune from the operations of the cleverest of crooks. This point cannot be too strongly impressed upon clerks and other employees.

William I. How moved recently from Pont-terville, Mich., to Lansing, Mich.

# Diamonds Wanted!



He swore by the bright stars  
above her.  
(You know how a lover can  
swear.)  
How he'd love her and love her  
and love her;  
And the stars twinkled down at  
the pair.  
(You know how a star can  
twinkle)  
When maidens to lovers confess.)  
They want just one thing—A  
DIAMOND RING,  
"Shipped by the next express."  
An assortment of precious  
stones, loose or mounted; pins,  
rings, brooches, etc., will be  
sent to any jeweler on mem.

## CROSS & BEGUELIN

Importers and Cutters of Diamonds and Precious Stones

48 Rue de Meslay, PARIS Telephone, 2188 Cortlandt 17 Maiden Lane, NEW YORK.



IMPROVED

### ARCH CROWN MOUNTINGS WITH COMPLETED BEARINGS

Represent the highest state of perfection yet attained in the art of mounting making and excel in beauty, strength, quality and ease of setting stones. Samples cheerfully submitted.



### ARCH CROWN MFG. CO., 26 CAMP STREET, NEWARK, N. J.

Cross & Beguelin, New York.  
Kossuth Marx Jewelry Co., New York.  
D. C. Percival & Co., Boston.  
Jos. Noterman & Co., Cincinnati.

M. Schussler & Co., San Francisco.

Schrader-Wittstein Co., Chicago.  
Leonard Krower, New Orleans.  
Chas. Wathen & Co., Denver.  
Eisenstadt Mfg. Co., St. Louis.

### Last Week's New York Arrivals.

THE CIRCULAR-WEEKLY each day posts in its office a bulletin of the latest buyers visiting New York, which every member of the trade is cordially invited to copy.

- ALLIANCE, O., A. E. Oyster, Broadway Central.  
BRIDGETON, N. J., J. A. Bowen (T. H. Bowen & Co.), Hotel Astor.  
CHICAGO, R. Newman, Broadway Central.  
I. J. Fiddling (J. P. Phillipson), Albert.  
P. N. Lackritz, Herald Sq.  
CINCINNATI, O., A. Herschede (Frank Herschede), Murray Hill.  
W. S. P. Oskamp (Oskamp, Nolting & Co.), Imperial.  
CONNELLSVILLE, PA., A. P. Kurtz, Broadway Central.  
EUFULA, ALA., J. B. Whitlock, Park Ave.  
FORT WORTH, TEX., Geo. B. Moning (Moning Dry Goods Co.), Albert.  
GADSDEN, ALA., C. F. Cross (Chas. F. Cross & Bro.), Grand.  
KANSAS CITY, MO., M. Berman, Raleigh.  
KNOXVILLE, TENN., H. J. Cook (H. J. Cook Co.), Imperial.  
MINNEAPOLIS, MINN., A. E. Paegel (Paegel Jewelry Mfg. Co.), Albert.  
C. E. Fisher (W. Donaldson & Co.), 2 Walker St.  
PÉKIN, ILL., H. Birkenbusch, Herald Sq.  
PITTSBURG, PA., A. Rosenbaum (Rosenbaum Co.), Netherland.  
PORT JERVIS, N. Y., H. J. Pippett, Astor House.  
QUINCY, ILL., Thos. A. Brown, Hotel Astor.  
READING, PA., Miss A. Lambert (Divcs, Pomeroy & Stewart), Earlington.  
ST. LOUIS, MO., D. G. Braham (Stix, Baer & Fuller Dry Goods Co.), Wellington.  
S. Van Raalte (S. Van Raalte & Co.), Imperial.  
SPRINGFIELD, ILL., H. Pierik (J. C. Pierik & Co.), Herald Sq.  
SPRINGFIELD, MASS., F. L. Sturtevant (Forbes & Wallace), Herald Sq.  
WHEELING, W. VA., H. Sheff (Sheff Bros.), Navarre.

### Trans-Atlantic Voyagers.

TO EUROPE.

Elof Benson, Youngstown, O., sailed this week on the *Scandinavia*.

A. Frankfield, of A. Frankfield & Co., sailed recently on the *Umbria*.

FROM EUROPE.

M. C. Eppenstein, Chicago, sailed from Europe on the 17th on the *Koenigin Luise*.

B. Harburger, of Harburger Bros., Philadelphia, returned last week from a month's pleasure trip to Europe.

Charles L. Power, of Charles L. Power & Co., New York, and Mrs. Power, returned yesterday on the *Vaderland*.

Nelson Anderson, retailer, Schenectady, N. Y., who was formerly located at 619½ State St., has purchased the jewelry business of E. F. Barnes at 465 State St. and will hereafter be located at that place, having moved his entire stock from the old stand.

Col. W. A. Moore, vice-president of the North American Watch Co., Mansfield, O., has leased his handsome residence in Warwick, R. I., to Dean Lawrence, of the Wire Sewing Co., East Greenwich, retaining his old homestead in the latter village for his family and week-end visits from New York.



## New York Notes.

Herman Alexander, 1812 Amsterdam Ave., has recently renewed the lease of his store.

Maurice Brower, 12 John St., left last week for a 10 days' trip to the pearl fisheries of the Wabash River.

Sam Hoehhaus, who started recently as an importer of diamonds, is now settled in his new quarters at 71 Nassau St.

Chas. L. Power, of Chas. L. Power & Co., accompanied by Mrs. Power, arrived from Europe yesterday on the *Vaderland*.

Alfred Stevens, western representative of Enos Richardson & Co., 21 Maiden Lane, is in the country recovering from illness.

A. Frankfeld, of A. Frankfeld & Co., sailed recently on the *Umbria* for Europe, intending to return by the end of August.

G. Marcus, of the California Jewelry Co., San Francisco and New York, is now in Amsterdam in charge of the company's European office.

Mr. and Mrs. William M. Dachtera, of Dachtera Bros., opticians, are now at the Rip Van Winkle Hotel, Pine Hill, in the Catskill Mountains.

Leo Cahn, formerly a clerk in the employ of Jacob Strauss & Sons, left Monday on his first trip as a salesman for Meyerowitz Bros., 37 Maiden Lane.

It is reported that a man who has been for some time connected with Abraham & Straus, Brooklyn, is about to establish a factory in Sidney, N. Y.

Robert Dieges, the 14-year-old son of Charles J. Dieges, of Dieges & Clust, 23 John St., saved a girl from drowning while at St. Bartholomew's Camp at City Island last week.

Abraham A. Heller, of L. Heller & Son, 51 Maiden Lane, who has been in Europe for three months, in charge of the Paris branch of the concern, is to remain permanently at that point, it is announced.

Harry Levinson, the salesman who was arrested in this city on the charge of stealing his samples from his employer, Louis Sonnanbend, 15 Elm St., Boston, Mass., was last week taken back to that city.

Under the new Brazilian tariff, according to an announcement sent out from Washington, the impost duty on a number of lines of merchandise, including watches, which that country buys from the United States is reduced 20 per cent.

Wm. McAdie, with the International Silver Co., 9 Maiden Lane, is advertising for the owner of a ladies' gold watch found June 30 at South Beach, S. I. The repair numbers on the inside of the case are as follows: X 31742 P—13757 X—E 255212—2380.

The firm of Louis L. Grey & Co. was dissolved yesterday by mutual consent. Louis L. Grey, who assumed all liabilities, will continue business at 71 Nassau St. Under the style of L. & B. Lehr, a manufacturing business will be conducted at 49 Maiden Lane by Louis and Benjamin Lehr, the former having retired from Louis L. Grey & Co.

The private offices of Joseph Fahys & Co. have been moved from the eighth floor front of the Fahys building, 54 Maiden Lane, to the third floor front. L. W. Rubenstein, who formerly occupied the third

floor front, has moved to the rooms on the eighth floor front. Other offices of Joseph Fahys & Co., now on the eighth floor, will later be moved to the fourth floor front.

George H. Robertson, former vice-president of the Gorham Mfg. Co., heads the directors' ticket recently put in the field by dissatisfied stockholders of the Wells-Fargo Express Co., who are making a demand for a larger distribution of earnings. Friends of the present management say that the object of the movement is not so much to obtain larger dividends as to get control of the business.

Oscar Wilhelm and Alexander Beck, for many years with F. Schneider, 68 and 68½ Bowery, New York, have formed a partnership and will continue the jewelry and optical business heretofore conducted by W. J. Roberts at 1576 Fulton St., Brooklyn. Both are members of the New York Watchmakers' Society, Mr. Beck also being a member of the Optical Society of the City of New York. The firm will be known as Wilhelm & Beck.

G. L. Sloan, the manager of the London branch of the L. E. Waterman Co., is now in this country. Frank D. Waterman, president of the company, entertained Mr. Sloan in New York last week. J. B. Tukey, representing the company, is about to start for Kansas to take orders for the Fall. Other salesmen are in their territories, W. J. Chaplin now visiting the trade in Washington, Baltimore and Philadelphia, and C. A. Crist making a trip through New York State.

Samuel Heller, of L. Heller & Son, 51 Maiden Lane, was among those present at the meeting called last week by Upton Sinclair for the purpose of establishing a co-operative settlement near New York. One of the daily papers reported Mr. Heller as casting his lot with the new company, and saying that as a business man the project looked to him entirely practicable. To a representative of THE CIRCULAR-WEEKLY Mr. Heller said that while he had sufficient interest in the movement to attend the meeting, yet he had not expressed the sentiments attributed to him.

Creditors of the I. G. Dillon & Son Co., Wheeling, W. Va., are quite generally signing the acceptance of an offer of 40 per cent. to be paid in cash. A meeting of the creditors was held one day last week in the rooms of the Jewelers Board of Trade, New York, at which the offer was made as a composition in bankruptcy. The committee of creditors who have been investigating the company's affairs recommended an acceptance of the proposal, and those who were present, representing almost a majority in the amount of indebtedness, unanimously voted to accept.

An offer of 40 cents on the dollar, made by Simon Robinson, who had stores at 1283 Broadway, Manhattan, and 1029 Broadway, Brooklyn, has been accepted in the last week by a number of his creditors, and there is said to be a likelihood that a composition will be formally effected on this basis. The creditors filed a petition in bankruptcy several weeks ago. Mr. Robinson then offered 25 per cent., and subsequently increased this offer to 33½ per cent. The creditors quite generally rejected both offers, and at a meeting a resolution was adopted suggesting

that he pay 40 per cent. At first he did not seem prepared to do this, but after consideration he accepted the terms which were proposed.

Henry Steck, 365 E. 61st St., New York, who had been employed by the L. E. Waterman Co., was recently arrested and is now held in \$1,500 bail to await the action of the grand jury, on the charge of grand larceny. Recently Harry Stafford was arrested in Coney Island as he was selling Waterman fountain pens at \$1 each. The company recovered more than \$100 worth of stolen pens from several stores on the Bowery. In nearly every case the articles were traced back to Steck, it is said. Steck, it is alleged, by means of a skeleton key, opened the vault where the stock is deposited, and helped himself to pens. The losses were at once noticed by the officers of the company. After investigation they concluded that Steck was the thief. His method, it is said, was to distribute the goods to others, who sold some of the highest priced pens at a low figure.

Beginning Aug. 13 and continuing until Aug. 18, Powers & Mayer will give an exhibition of mounted diamond stock in their salesrooms, 258-260 Fifth Ave. Their invitations have been answered by jewelers from various parts of the country who will attend and also by some South American merchants. The exhibit will include many new and original designs executed as hair ornaments, collars, necklaces, bracelets, brooches, rings, etc. Exhibitions of this kind are given annually by Powers & Mayer and the coming one will be the fourth. It has taken seven months to complete the articles that are to appear in the exhibit. Mr. Mayer said that displays of this kind, where buyers may see a greater variety of goods than in any other way, are growing more popular. "The number of jewelers," he said, "who signified their intention to be present at the coming exhibit exceeds that of any other year."

In the suit of J. Finkel, of Locketz & Finkel, jewelry manufacturers at 218 E. Houston St., against the Brooklyn Watch Chain Co., 275 Bowery, the trial took place recently in the Municipal Court, Seventh District, Brooklyn. The action is to recover \$45, the purchase price of a number of slides. The defense is that the slides did not come up to the guarantee of 14 karat gold. The testimony of assayers was heard and considerable time was consumed in the examination of witnesses, who were required to explain methods of testing and assaying. The court reserved decision. Sol. L. Youngentob, counsel for the plaintiff in this suit, recently began another action against Maurice J. Blumen and J. Jacoves, of the Brooklyn Watch Chain Co., for \$10,000 damages for alleged malicious prosecution. This case, like the other, grows out of the sale of the slides. After the sale the watch chain people summoned Mr. Finkel to the Essex Market Court, charging him with a violation of the New York Gold Stamping law. It was claimed by the Messrs. Blumen and Jacoves that the gold in the slides assayed less than 13 karats in fineness. That complaint was dismissed by Magistrate Finn. Thereafter another summons was obtained

IN THE HEART OF THE JEWELRY DISTRICT.

**Guardian Trust Company,**

170 BROADWAY, COR. MAIDEN LANE, NEW YORK.

**Capital and Surplus - Over \$1,000,000**

Equitable rates of interest allowed on surplus funds.

Collection of out-of-town items made on reciprocal basis.

FRANK W. WOOLWORTH, President.  
GEORGE W. FAIRCHILD, Vice-President.  
CHARLES L. ROBINSON, Vice-President.LATHROP C. HAYNES, Secretary.  
ALFRED M. BARRETT, Asst. Sec'y.Prominent Jewelers  
Among our DirectorsLUDWIG NISSEN.  
A. K. SLOAN.  
LEOPOLD STERN.**THE ORIENTAL BANK.**

ESTABLISHED 1853.

**182 and 184 Broadway, <sup>Corner</sup> JOHN STREET, NEW YORK.****Capital, - - - \$750,000.00.****Surplus and Profits, 1,100,000.00.****ACCOUNTS FROM THE JEWELRY TRADE ARE SOLICITED.**R. W. JONES, Jr., President.  
NELSON G. AYRES, First Vice-President.  
GEO. W. ADAMS, CashierLUDWIG NISSEN,  
ERSKINE HEWITT, } Vice-Presidents.  
CHARLES J. DAY, }

R. B. ESTERBROOK, Assistant Cashier.

**The Market and Fulton National Bank of New York.**

ORGANIZED 1852.

**81-83 FULTON STREET.****Capital, \$1,000,000.****Surplus, \$1,335,000.**ALEXANDER GILBERT, President.  
R. A. PARKER - - Vice-President.  
T. J. STEVENS, - - - Cashier.  
JOHN H. CARR, - Asst. Cashier.**Invites the Accounts of Jewelers.**  
**Will extend every facility that good banking will justify**  
**SAFE DEPOSIT VAULTS.****The Chatham National Bank**

Broadway and John Street, New York

H. P. DOREMUS, Cashier

GEORGE M. HARD, President

W. H. STRAWN, Ass't Cashier

**THE STATE BANK**

376-378 GRAND STREET, NEW YORK

**Capital and Earned Surplus, over \$1,100,000. Deposits over Fourteen Millions.****Offers a favorable market for short and long time jewelry and diamond paper**

The Officers and Directors of

**THE MERCANTILE NATIONAL BANK**

of the City of New York announce  
the removal of their banking rooms  
to their new quarters in the Western  
Union Building, 195 Broadway,  
corner of Dey Street, and invite your  
inspection of their equipment



# Bigalke & Eckert Co.

## Importers of Watches,

No. 1 Maiden Lane, New York.

Single and Split Second Timers in Nickel  
and Gun Metal Cases.

Complete Assortment of  
Chronographs, Split Seconds and  
Minute Repeaters.

Ladies' and Gentlemen's Flat and Ultra Flat Watches.  
Flat Calendar Watches.

SOLE AGENTS FOR

**Haus, Neveux & Cie.**

FINE GENEVA WATCHES.

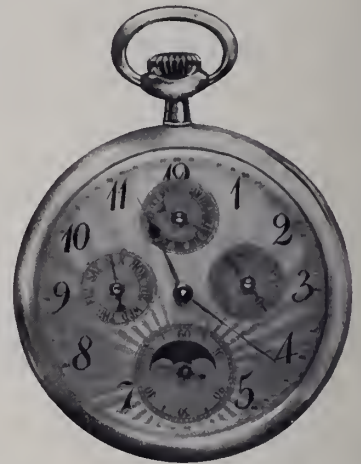

# JOS. NOTERMAN & CO.

## DIAMONDS

IMPORTERS AND CUTTERS

Recutting and Repairing odd shaped and chipped stones a specialty. Manufacturers of Mountings and  
Fine Jewelry. Special Designs Furnished.

CINCINNATI, OHIO.

# A NEW MOVEMENT

THE O-SIZE 7 JEWELLED PENDANT SETTING

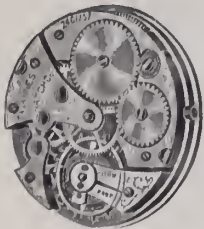

**TAVANNES** *Is*  
**Fully Guaranteed**

FOR SALE THROUGH THE JOBBING TRADE

## TAVANNES WATCH COMPANY

2 & 4 Maiden Lane, New York

**New York Notes.**

(Continued from page 61.)

against Mr. Finkel in an effort of the watch chain people to reopen that case, and in this they were unsuccessful.

Creditors of David Hartstein, 4 Ave. C, have accepted the composition of 40 cents on the dollar which he offered recently, and he will continue the business.

The S. Kaplan Co. has been incorporated to deal in jewelry with a capital of \$25,000. Incorporators are: A. Bamday, S. Kaplan and D. W. Peters, all of New York.

Claudius Miller, 58 years of age, a silversmith, employed at Tiffany & Co.'s works, near Forest Hill, Newark, was struck and instantly killed Monday by a train on the Greenwood Lake Division of the Erie Railroad, near Forest Hill, Monday. The victim was on his way to work at the time, and did not see the train.

Attorneys for Joseph and Morris Klein, of Klein Bros. & Co., bankrupt manufacturers at 51 Maiden Lane, last Friday, obtained from Judge Rosalsky an order reducing their bail to \$6,000 for Joseph and \$4,000 for Morris. The amounts originally fixed were \$15,000 and \$10,000 respectively, and the Kleins, being unable to furnish a bond in that amount, had been detained in the Tombs. They obtained bonds for \$10,000 as soon as the court consented to the reduced bail, and received their freedom. They are to appear for trial about the middle of August, it is expected.

**Newark.**

A new corporation was formed last week under the style of Kollmar, Rauch & Co., to manufacture jewelry. The incorporators are Robert and Henry Kollmar and Julius C. Rauch, all of Newark. Robert Kollmar was formerly in business here. The authorized capital is \$100,000, of which \$20,000 is paid in, according to the certificate.

Leiman Bros., of 139 Centre St., manufacturers of jewelers' machinery, are to erect a factory in Brill St., to cost about \$10,000. The plans as drawn by T. Cecil Hughes call for a two-story reinforced concrete building, to cover an area of 46 x 85 feet. The Joseph Sharpe Construction Co., of Paterson, will do the masonry, and John W. Vliet the carpentering.

Albert E. Lee, western representative of Robert Levy, manufacturer at Green and Columbia Sts., has recently formed a partnership under the name of Lee & Wheeler. The new firm has opened an office in San Francisco, where it will represent Mr. Levy and other manufacturers. Joseph Levy, traveler for Robert Levy, recently passed a brief vacation in Bradford, Pa., visiting his mother.

The Wheeler Jewelry Co. was incorporated last week to carry on the business conducted up to this time by a partnership under the same style at 24 Boudinot St. The certificate of incorporation authorizes the company to manufacture gold-mounted combs and other novelties. The amount of capital stock is \$15,000; incorporators, Ar-

thur L. Phillips, South Orange, N. J.; Frank Mead and Richard F. Faux, Newark, N. J.

An extension, to cost about \$12,000, is to be made to the plant of the Newark Watch Case Material Co., at 17 and 19 Ward St. The structure will be a three-story brick addition, to measure 45 x 60 feet. The new building will be equipped with a freight elevator. Contracts for the mason and carpenter work have been awarded to William B. Gordon and Edward I. Oakley, respectively. Richard W. Erler drew the plans.

Burglars broke into William Carslake's store at Church St., in Bordentown, on the night of July 16, and rifled the cash register of \$65 in money, besides carrying away a quantity of ladies' and men's gold watches and chains, finger rings, cuff buttons and other jewelry to the value of \$35. Entrance was obtained through a window leading to the cellar, and thence through a door leading into the store. A young man about 20 years of age, who was seen loitering in the vicinity of the store, is suspected.

An article descriptive of the Trenton Watch Co.'s plant at Trenton, N. J., was published in the last issue of the *Weekly Advertiser*, of that city. The writer said that under the direction of John M. Cutter the company is making steady progress, 400 persons being now employed in the factory, about one-half being women and girls. The output is given as 500 watch movements per day, and it is said that the orders ahead are sufficient to assure steady work for a year. Speaking of the character of the employes, he says: "The employes are sober, industrious, ingenious craftsmen, good citizens as can be found anywhere. Germans and Frenchmen are to be found in the place as well as a few Swiss, but the majority are native born, though they may have in many cases parents who were born under a different flag than the Stars and Stripes of their adoption."

**Clocks, Watches, Jewelry and Gems Imported Into Canada.**

TORONTO, Can., July 19.—The monthly report of the Canadian Department of Trade and Commerce for April, just issued, shows the value of imports for home consumption in the jewelry and kindred trades as follows:

	Month of April,		Ten months ended	
	1905.	1906.	April 30,	1906.
<b>Clocks:</b>				
Great Britain.....	\$1,284	\$454	\$10,057	\$8,417
United States.....	19,081	23,615	202,348	220,005
Germany.....	2,486	1,916	33,600	31,442
Other countries.....	357	297	11,193	13,276
<b>Totals.....</b>	<b>\$23,208</b>	<b>\$26,282</b>	<b>\$257,198</b>	<b>\$273,140</b>
<b>Watches:</b>				
Great Britain.....	\$2,997	\$1,176	\$21,108	\$22,960
United States.....	54,878	47,929	552,146	578,552
Switzerland.....	7,777	11,252	153,928	139,718
Other countries.....	1,923	110	25,408	38,622
<b>Totals.....</b>	<b>\$67,575</b>	<b>\$60,467</b>	<b>\$752,590</b>	<b>\$779,852</b>
<b>Jewelry:</b>				
Great Britain.....	\$8,817	\$7,918	\$67,240	\$67,377
United States.....	45,001	58,208	576,133	598,450
Germany.....	5,282	3,627	46,672	43,136
Other countries.....	1,859	2,081	27,490	25,427
<b>Totals.....</b>	<b>\$60,959</b>	<b>\$71,834</b>	<b>\$717,535</b>	<b>\$734,390</b>
<b>Gold and silver and manufactures of:</b>				
Great Britain.....	\$5,682	\$24,365	\$88,288	\$134,287
United States.....	27,821	21,833	270,942	253,605
Other countries.....	2,412	3,499	51,695	47,865
<b>Totals.....</b>	<b>\$35,915</b>	<b>\$49,697</b>	<b>\$410,925</b>	<b>\$435,757</b>
<b>Precious stones of all kinds and imitations of (dutiable):</b>				
Great Britain.....	\$2,666	\$1,460	\$10,216	\$7,722
United States.....	4,862	1,641	18,516	19,489
Other countries.....	1,015	1,699	15,148	20,382
<b>Totals.....</b>	<b>\$8,543</b>	<b>\$4,800</b>	<b>\$43,680</b>	<b>\$47,593</b>
<b>Precious stones of all kinds and imitations of (free):</b>				
Great Britain.....	\$40,782	\$73,355	\$219,417	\$403,564
United States.....	24,009	17,514	105,634	149,964
Holland.....	5,239	33,458	195,319	257,748
Other countries.....	59,347	35,467	536,400	362,142
<b>Totals.....</b>	<b>\$129,377</b>	<b>\$159,794</b>	<b>\$1,056,770</b>	<b>\$1,173,418</b>

**Optical Notes and Briefs.**

Spence's Optical Co. has opened at 1020 Fillmore St., San Francisco, with a full line of goods.

The Sunset Photo Co., of 43 Third St., San Francisco, has opened on Van Ness Ave., near Geary St., and have added an optical department.

Dr. Holzberg, formerly located at 877 Market St., San Francisco, will soon open on Van Ness Ave., near Turk St., with a full line of optical goods.

A patent for a safety hook for eyeglasses was recently granted to Mrs. May C. Horton, wife of State Senator C. H. Horton, Woonsocket, R. I. The hook is designed to prevent glasses from slipping off when the wearer stoops.

Articles of incorporation have been filed by the California Optical Co., Oakland, with a capital stock of \$60,000. The directors are: Henry L. Davis, W. D. Fennimore, A. R. Fennimore, all of San Francisco; John W. Davis, San Mateo, and Charles L. Hogue, Oakland.

C. H. Gottschalk Sons, who formerly conducted an old-established jewelry business at 507 California St., San Francisco, are now temporarily located at 1636 Post St.

# Warning to the Trade!



Retailers are being called upon by a man who is selling twenty-one chains on a cloth for \$18, with swivels stamped "S. O. B. & Co.," and with a duplicate tag of ours bearing our trade-mark, attached to same. The chains are nothing more or less than brass shaded over, and will not stand acid for a single moment.

Jewelers with any experience ought to be able to discover the difference between a finished article and a rotten one.

Anyone who has been swindled by this man will please notify our house, as we want all the evidence possible, and we will do the rest.

Localities where goods have been disposed of are Pittsburg, Allegheny, McKeesport and surrounding towns.

We have two chains now in our possession that were sold by this man.

S. O. BIGNEY & CO.

We give you below an exact copy of an assay of chains manufactured by the leading chain makers of the United States.

1-10 GOLD FILLED WATCH CHAINS, MINUS BAR AND SWIVEL.

Number	Gross Weight		Fineness Gold 1000ths	Value	Maker	Chain Number	Cost	
	Ounces	Dec.						
15		71	29½	\$0.43	S. O. Bigney & Co. - - - -	1155	\$2.85	
16		75	50	.775		482	3.08	
17		81	34	.57		3005	2.73	
18		76	23½	.37		9533	2.97	
19	1	00	16½	.34		83	2.14	
32		52	49½	.53		213 X	2.83	
34		73	34½	.52		733	2.41	
46				.58			5011	3.82

1-8 CHAINS, MINUS BAR AND SWIVEL.

Number	Gross Weight		Fineness Gold 1000ths	Value	Maker	Chain Number	Cost
	Ounces	Dec.					
35		57	68	\$0.80	S. O. Bigney & Co. - - - -	1604	\$3.96
36		60	65½	.81		7015	3.75
37		60	63	.78		4324	4.00
47		49	79	.80		2726	4.00

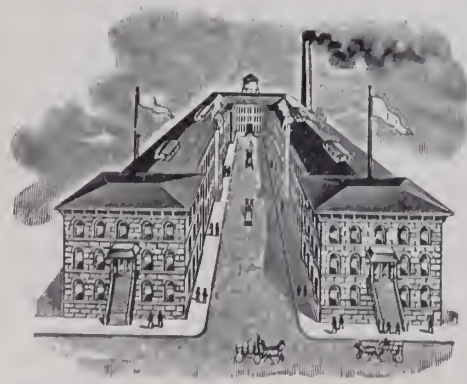

## S. O. Bigney & Co.

NEW YORK OFFICE,  
3 MAIDEN LANE.

FACTORY, Attleboro, Mass.



# Manning, Bowman & Company, MERIDEN, CONNECTICUT.

NEW YORK.

CHICAGO.

---

## NICKEL AND SILVER PLATE.

THE BEST, LATEST AND MOST COMPLETE LINE ON THE MARKET.

“METEOR”  
Circulating  
Coffee Percolators  
Save One-Third.



No. 2393. Percolator Set.

“IVORY” ENAMELED  
FOOD PAN.

Patented May 23, 1899.

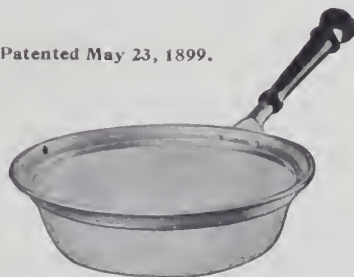

The Greatest Improvement Ever Made  
in a Chafing Dish.

Pure, clean, durable. It is so constructed that food can only come in contact with the Ivory Enameled Dish. The top rim being plated, the complete Chafing Dish has the same appearance as when made entirely of metal.

CHAFING DISHES

with Patent

Seamless “IVORY” Enameled Food Pan.

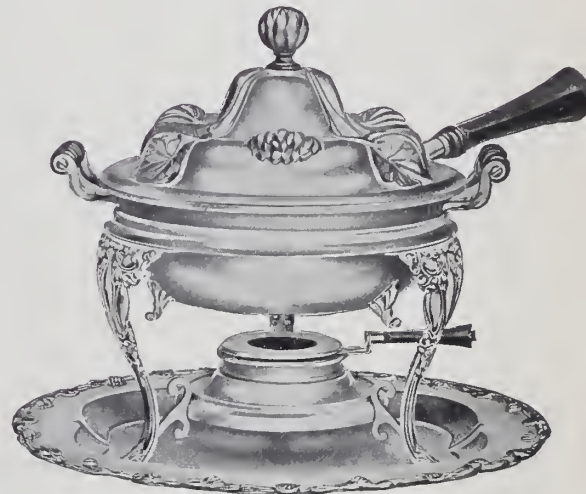

No. 286. Chafing Dish.

No. 4314. Waiter.

## “METEOR”

Circulating Coffee Percolators afford the best known method for producing Coffee or Tea of the finest flavor.

---

## PRIZE TROPHIES.

English Pewter, Also Solid Copper with English Pewter Mountings.

---

TEA WARE, TABLE KETTLES, HOTEL WARE, BAKING DISHES, ETC.

Catalogue No. 40 J. will be sent on request.

## Ball's Official Standard R. R. Watches

WHAT WOULD YOU GIVE FOR A LIFELONG CUSTOMER?

Try this plan:

Sell your next watch customer a "Ball."

Its reliable performance will convince him you are a dealer to be depended on—he'll keep coming back for other things.

The watch will win you his business and friendship for always.

*Write for booklet, and watch this space.*

We want to add a lot of new friends to the Ball family of railroad watch dealers.

### THE WEBB C. BALL WATCH CO.

CLEVELAND  
Ball Building

CHICAGO  
804-6-8 Railway Exchange



ESTABLISHED 1854.

INCORPORATED 1893.

JUERGENS & ANDERSEN CO.,  
DIAMONDS,  
MAKERS OF FINE JEWELRY,  
92 TO 98 STATE STREET,  
CHICAGO.

23-25 Looijersgracht, Amsterdam, Holland.

**THE HERMAN KECK MFG. CO.**  
CUTTERS OF  
**DIAMONDS.**

MANUFACTURING JEWELERS.

SILVERSMITHS.

Recutting and Repairing of Diamonds.

17-19-21-23 West Fourth Street,

CINCINNATI, O.

RUDOLPH NOEL

RUDOLPH NOEL & CO.

PHILIP NOEL

IMPORTERS OF

**DIAMONDS**

2 Tulp Straat, AMSTERDAM

'Phone 1902 John

37-39 Malden Lane, NEW YORK





# WESTERN DEPARTMENT

Western Office:  
204 COLUMBUS MEMORIAL BUILDING,  
CHICAGO.

Telephone:  
4079 CENTRAL,  
CHICAGO.

VOL. LII.

CHICAGO, WEDNESDAY, JULY 25, 1906.

No. 25.

## Chicago Notes.

Tom Stanek visited the Twin Lakes of Wisconsin last week.

The Lewis Schaffer Jewelry Co., Madison St., has discontinued business.

Leon Gross, of the Knickerbocker Silver Co., goes on his western trip this week.

Tony Seriewicz is on a visit to the Dueber-Hampden factories at Canton, O.

J. W. Stoneburner is spending his vacation at his native town of Edinburg, Va.

M. C. Eppenstein and wife sailed for the United States, July 17, on the *Koenigen Louise*.

Joe Manheimer and family will return from the Yellowstone National Park about Aug. 1.

Herbert Rosensteal, of B. H. Davis & Co., New York, visited trade here during the week.

Max Mayer, of the Western Watch Case Mfg. Co., is on a trip to Yellowstone National Park.

Ed. Moore has secured the western agency for the American Ring Co., Providence, R. I.

Paul Juergens, of the Juergens & Andersen Co., is spending the Summer at Powers Lake, Wis.

S. Newman and L. Eisenbach, of A. Hirsch & Co., leave shortly on their Fall trips to the west.

S. Buchsbaum, of S. Buchsbaum & Co., is having an outing with his family at Brown's Lake, Wis.

C. A. Wilkinson, of Chas. A. Wilkinson & Co., Providence, R. I., visited the optical trade in Chicago last week.

H. Eyster, of Seattle, visited Chicago trade on his way home from Providence, Attleboro and eastern points.

E. C. Bell has been engaged by A. Max Holzheimer to travel for the Omega Watch Co.'s western selling agency.

Lem Whitney Flershem, of Lapp & Flershem, has been confined to his home for some time with rheumatism.

F. Goodholm and wife, Lindsborg, Kans., who have been spending some time in Chicago, returned home last week.

Chas. Lesser, with the Chicago office of the Wadsworth Watch Case Co., underwent an operation last week for abscess of the jaw.

Charles S. Hungerford, an old-time jewelry salesman, visited Chicago last week. He has been in Southern California for some time.

Joe H. Ehrlich, who recently severed his connection with Goldman Bros., contemplates going into business for himself at Detroit, Mich.

Jos. Brown & Co. have opened a retail jewelry store at 90 State St., on the premises formerly occupied by the Fidelity Trust & Receivers Co.

Will G. Andersen, of the Juergens & Andersen Co., sailed recently on the *New York* from Southampton. Mr. Andersen has been absent about three months buying.

J. T. Brayton, of the Julius King Optical Co., is spending his vacation at his Summer cottage at Lake Kenkenosha, Wis., where his family has been installed for some time.

John H. Mather, western manager of the Geo. H. Fuller & Son Co., has returned from an eastern trip, which included a swordfishing expedition on Mr. Fuller's steam yacht.

William Strickler, Miller, S. Dak., has sold his business at that place to W. H. Wilson. He was in Chicago recently getting together a new stock, and proposes to locate in Idaho.

Victor Paltrovitch, 66 State St., and L. C. Goldsoll, of 134 State St., have opened a new jewelry store next to the northwest corner of State and Van Buren Sts. under the firm name of the Jackson Jewelry Co.

James L. Woolson, a former clerk in the collection department of Loftis Bros. & Co., was charged last week with being short something over \$100 in his accounts. He was apprehended by the Bankers' Surety Co., who had bonded him.

Frank H. Mooney & Co. are increasing the capacity of their factory, which is located in Chicago. The following salesmen of this company left July 15 for the Fall trips: Henry J. Hauk, C. L. Turley, A. L. Sanderson, E. O. Flanders and R. J. Rhodes.

Among the buyers in Chicago during the week were: E. Paegel, Paegel Jewelry Mfg. Co., Minneapolis, Minn.; C. Liebenow, Manitowoc, Wis.; A. H. Frandsen, Monmouth, Ill.; John Armbruster, Cedarburg, Wis.; George C. Schreiber, Lincoln, Ill.; C. E. Axt, Rockford, Ill.; F. L. Taylor, Aurora, Ill.; Theo. Leaf, DeKalb, Ill.; C. Q.

Erismann, Lafayette, Ind.; Henry E. Volkman, Kankakee, Ill.

Alfred Despres, who died July 16 of Bright's disease at his home in Chicago, at the age of 49, was very well known among the jewelry trade in the west, having been connected with the firm of H. F. Hahn & Co. as traveling salesman for 18 years. At his death he was in the wholesale liquor business under the firm name of Despres & Co. Deceased was a brother of Emil Despres, of Despres, Bridges & Noel.

The Illinois State Rifle Association will hold its tournament at Camp Logan, Sept. 15-16. The genial manager of the Julius King Optical Co., J. T. Brayton, with Lieut. Cols. Healy and Barnett, are working for the success of the meet, which is to open to all members of the association and the Illinois National Guard. In all 12 to 18 matches will be held, and a big list of valuable trophies and medals, as well as money prizes, will bring out the crack shots of the two organizations.

On July 5, Edwin C. Day, the receiver for the Cash Buyers' Union of Chicago, filed his report in court and turned over the affairs of that concern to the trustee, Charles L. Billings, who was appointed June 1. Receiver Day's report showed receipts since April of this year of \$109,827.48, with expenditures of \$109,826.15 and bills contracted by him but unpaid of \$5,713.12. The inventory made by order of the receiver shows stock, figured at cost, amounting to \$298,295. Trustee Billings has advertised for bids covering the entire assets, consisting of the stock as inventoried, good will and all the fixtures in the eight-story building occupied by the concern. In court on Thursday he stated that he had received some fair bids, but asked leave of the court until July 26 for further time to negotiate with the parties bidding. He is of the opinion that a satisfactory bid will be made when the affairs of this unfortunate enterprise will be closed. The original schedule of the Cash Buyers' Union shows debts totaling \$337,099.38. This includes office expenses, money received on orders not filled, and the unsecured claims of creditors. The assets aggregate in this schedule \$1,690,183.98, of which sum over a million and a quarter is placed as the value of stock and fixtures, with debts due on open account of \$320,200.

# To the Jobbing Trade.

**WE HAVE**



in quick-selling popular-price Diamond Jewelry and Mountings.

**Diamond Bunch Rings  
a Specialty.**



## St. Louis.

Al. Cline is now with J. W. Cary & Co. J. C. Wieser, Roodhouse, Ill., is visiting his son-in-law, George F. Longnecker, Winchester, Ill.

H. M. Carle, agent for the Keystone Watch Case Co., Chicago, Ill., was in St. Louis last week.

Mrs. Zeitler, wife of John F. Zeitler, 2013 Salisbury St., and children are making an extended tour of the west.

Joseph J. McKenna, of the Bauman-Massa Jewelry Co., has gone on a fishing trip with J. A. Allison, of Rolla, Mo.

Charles Gonterman, Granite City, Ill., was the chairman of the arrangements committee of an outing given by the merchants of that city.

Among the visiting jewelers in St. Louis last week were the following: J. Harvell, Litchfield, Ill.; Winfield C. Davis, Thayer, Mo.; Fred Simon, Collinsville, Ill.; M. Roberts, Troy, Ill.

L. W. Waldecker, manager and buyer of the silverware department of the F. W. Drost Jewelry Co., goes Saturday for an extended visit east. He goes from here direct to New York.

Simon Van Raalte left Monday for New York and other eastern resorts. He will sail soon from New York for Europe, and will visit Egypt and other Oriental lands before going to join Mrs. Van Raalte in Holland, where she is visiting.

The Mermod, Jaccard & King Jewelry Co. displayed in their window last week cups, trophies and medals to the value of more than \$2,000, which were contested for in the regatta of the Southwestern Rowing Association at Creve Coeur Lake. Besides two cups, 38 medals of the value of \$700 were manufactured this year. The medals are of the fineness and size of a \$20 gold piece.

The Retail Jewelers' Association of Missouri, at the last regular meeting on Wednesday, decided not to give the annual picnic this season, but to direct all their energies toward making the annual meeting in February a success. In line with the idea advanced at the annual banquet held last February, it was decided to have a three days' session, and jewelers from all over Missouri will be invited to be present.

Upon complaint of the Michaels Loan & Mercantile Co., 900 Franklin Ave., August Rothenheber, 1913 Belt Ave., was last week arrested by the police. It is alleged that Rothenheber purchased a diamond ring and a garnet ring valued at \$77, paying for same with a check drawn on the City National Bank, which concern said the check was no good, as the signer had no account there. Rothenheber said that he did have an account at the institution some time ago, and had intended to deposit enough the next day to cover the amount of the check.

Wm. B. Bellamy, Warsaw, Mo., has disposed of his interests at that place and moved to Kansas City, Mo.

N. C. Anderson, Fargo, N. Dak., has been succeeded by the N. C. Anderson Co., H. V. Warnock, of Los Angeles, Cal., buying an interest. Mr. Anderson will go east some time in September to buy goods.

## San Francisco.

### TRADE CONDITIONS.

Trade conditions are now so rapidly improving that in some lines of business they may be regarded as being about normal again. It may seem strange to some to learn that a ruined city is now buying so many goods that the transportation companies are unable to handle all the consignments. Such is the case at present in San Francisco. The old-time facilities have proven inadequate and immediate steps are being taken for their enlargement. At present the congestion of freight is without parallel here and wholesalers and retailers are greatly inconvenienced. The wholesale jewelry trade, in common with others, is affected by the delay in receiving freight, and as large quantities of goods are being sold before they reach here, the enforced delay is also felt directly by the retailer. The traveling men who are out now are sending in unusually heavy orders for this time of the year. Crops are heavy and prices high, making times prosperous, and the great increase in population during the last year, owing to eastern emigration, is adding to the volume of business.

The jewelry store of M. Zacharias is now located at 2808 Fillmore St.

G. Aronsou's Loan Office has been located at 2438 Sacramento St., and a line of new goods installed.

J. S. Dinkelspiel has opened an office at 2408 Fillmore St., where he is continuing his business as dealer in precious stones.

The Diamond House, formerly located at 1034 Market St., and also at 56 Sixth St., has opened a large store at 1121 Van Ness Ave.

Schulz & Bernzatt have opened a jewelry store at 579 Hayes St., and have a watchmaking and optical department in conjunction with it.

Werner Bros., jewelers and watchmakers, located at 2106 Fillmore St., have been very busy since the fire, and have increased the stock of goods usually carried by them.

The Macey Jewelry Co. has secured a location for a store at Post and Fillmore Sts., and is now engaged in installing the fittings. An optical department will be operated as well as the regular jewelry business.

H. C. Hackett, who was formerly with Brittain & Co., at 120 Geary St., has now branched out for himself and has secured a location at 2506 Mission St. As this district escaped the conflagration, its business is going on as before. In fact, people are said to be patronizing as never before the neighborhood stores. While this may not continue long, the rapid growth of the Mission district makes this field a particularly inviting one.

The Baldwin Jewelry Co. opened this week on Van Ness Ave. in a new building of its own, and the store at 1521 Sutter St., that had been occupied ever since the fire, was abandoned. The firm expects a heavy trade, and has made preparations with a large stock of goods and a large force of salesmen. The new store resembles the one destroyed in the James Flood building in its interior arrangement, there being a balcony all around and the show cases in the center of the room.

Although the new store of Shreve & Co. at Sacramento St. and Van Ness Ave. is still far from completion, their factory building in the rear on Sacramento St. has been finished and work in this line is being resumed as fast as the necessary machinery can be installed. Notwithstanding the fact that so many jewelry stores have started

up in the regular retail districts, an increased business at the salesrooms both on Jackson St. and at Post and Grant Ave. is reported. It will probably be two months yet before the new store is finished, as the interior fittings are quite elaborate.

Radke & Co. opened their large jewelry store on Van Ness Ave. last week, and despite the fact that the store was as yet incomplete, did a large business. The stock embraces the entire line of goods kept formerly at the Sutter and Geary St. stores, and also articles that are more in the line of necessities, such as silver tableware, toilet articles, etc. The Devisadero St. store is to be continued for a time at least as a branch establishment, and if the trade there warrants it will be kept up permanently. The new store is fitted with a first-class repair department. Mr. Radke says that there is a great deal of this work since the fire.

## Pacific Coast Notes.

W. Dupen, Jr., Sacramento, has been visiting in Woodland, Cal., with his wife.

M. Noack has moved into a portion of the store occupied by the Wiley B. Allen Co., at Santa Rosa, Cal.

A. Protsch, Redondo, Cal., has been appointed watch inspector for the Los Angeles and Redondo Railway.

A. E. Howell, formerly of Kansas City, has moved to Phoenix, Ariz., and will accept a position with the Crescent store, which succeeded to the business of H. F. Vantiburg, in the latter place.

Geo. H. Cook, of Geo. H. Cook & Co., has sold his interest in the firm's business in Prescott, Ariz., to his partner, O. A. Hesla, who will continue at the old location. Mr. Cook sells because of the state of his health.

Rosa Eppstein, 16 years old, charged with stealing a diamond ring from R. C. Mathew's store, 419 San Pablo Ave., Oakland, Cal., was before Police Judge Smith last week, but hearing was adjourned a few days, no complaint having been filed against the girl. The gem was recovered by boys who say that the girl threw away the circlet while she was being pursued in her flight from the store.

## Omaha.

Curtis Lindsay has taken a position with his father in the jewelry business.

W. G. Sheppard has removed from Cambridge, Nebr., to Indianola, Nebr.

Herbert Hakan, formerly of Omaha, who had been in business at Sedalia, Mo., has sold out.

A. F. Smith, of the A. F. Smith Co., has gone on the Commercial Club's excursion to the Black Hills.

Grover Peterson, with the Sol. Bergman Jewelry Co., has returned from a two weeks' trip out west.

S. M. Thomas, of Tabor, Ia., came to Omaha last week in his automobile. Owing to a heavy rain, he was compelled to leave the machine here and take the train home.

C. O. Booth, of the Mawhinney & Ryan Co., with his family, have returned from a visit to Beaver Dam, Wis. N. C. Wheeler

has returned from Vermillion, S. Dak. W. B. Lodge has gone to Worland, Wyo.

P. E. Flodman and John Hendrickson, of the P. E. Flodman Co., is on a fishing trip to the Chisayo Lakes, Minn.

## Kansas City.

F. W. Meyer is about to start to Colorado on a vacation trip.

Clarence Owen, Vinita, Okla., is now taking a course at the Kansas City Polytechnic Institute.

I. D. Simmons, Grand Saline, Tex., has accepted a position as watchmaker for the Green Jewelry Co.

Julius Donnell, after an absence of several years, has re-entered the employ of the Meyer Jewelry Co.

Chas. Moll, Gardner, Kans., was in the city this week, on his way to Excelsior Springs, where he will take a short rest.

Garrett Owen, who had been a watchmaker for Gurney & Ware, recently resigned to take a similar position with Clem. B. Altman.

Morris Brown, of Kionka & Kionka, left this week for a vacation of a couple of weeks. His place will be filled during his absence by John Miller.

Henry Melliush, Tucson, Ariz., who had been visiting relatives in Ottawa, Kans., has come to Kansas City to take a course in the Southwestern Optical College.

Mrs. C. W. Bowen, Brunswick, Mo., who recently took the watchmaking course with the Kansas City Polytechnic Institute, has returned to take the course in engraving.

Tovie Brenner, a pawnbroker, who is charged with buying six diamond rings stolen from the show window of Grim & Smith, and only reporting two of them, has been arrested.

C. B. Norton, of the C. B. Norton Jewelry Co., will leave the city Aug. 1, accompanied by his family, for a fishing trip to Minnesota. About the middle of August, Ward Lewis, of the same company, will take his family and go to the same State for a fishing excursion. Five of the house force are now away on vacations.

The following jewelers from the surrounding country have been visitors to this market during the past week: L. S. Slocum, Corning, Kans.; G. B. Douglas, Pleasant Hill, Mo.; Frank Burgy, Brunswick, Mo.; E. M. Crelin, Chillicothe, Mo.; Leslie Hutton, Lebanon, Kans.; J. D. Russell, Canon City, Colo.; Mr. Todd, of Powell & Todd, Mena, Ark.; E. S. Proper, Ames, Ia.; I. Eller, Richmond, Mo.

L. S. Cady, of the Cady & Ohmstead Jewelry Co., reported to the police several weeks ago that a diamond worth \$150 had been taken from his store by a shoplifter. Pictures from the rogues' gallery were sent him. He picked out the picture of one woman who, he said, was the thief. The police arrested the woman and another who associates with her. They are being held. Mr. Cady says that the thief substituted a paste stone for the diamond.

Frank D. Kernochan, 17 North St., Middletown, N. Y., has been appointed official watch inspector of the Ontario & Western Railroad. The territory extends from Livingston Manor to Cornwall.

## Cincinnati.

M. Schwab, of A. G. Schwab & Bro., with his wife, is at Atlantic City for a month.

Harry Gilsey, of S. & H. Gilsey, left last week for a three weeks' stay at Atlantic City and New York.

F. C. Taylor, Carlisle, Ky., was here last week on his way to Michigan, where he will stay two weeks with his family.

The engagement of D. Gutmann, of L. Gutmann & Sons, and Miss Edna Mosler, daughter of Max Mosler, president of the Brighton German Bank, has been announced.

Mabel Hall, who last week was tried for obtaining goods under false pretenses from the Oskamp Jewelry Co. and the Dulme Jewelry Co., has been sentenced to the penitentiary, though as yet no time limit has been set for the sentence to run.

A. E. Axman, Franklin, O., was here last week purchasing new stock for the new store at Middletown, O., where he will be located in the future. He has discontinued his store at Franklin, in which town he conducted business for 20 years.

Mayo Loeb, of Herman & Loeb, while alighting from a street car last week, slipped and sprained his ankle. This has detained him from his road business for a week. A. Herman, of this firm, left last week for his regular trip through West Virginia and Ohio.

Oskamp, Nolting & Co., July 14, were granted a charter as a stock company with a capital of \$200,000. The incorporators are Charles A. Nolting, for many years manager of the concern; William H. Oskamp, Frederick Schaefer, Louis F. T. watchman and Emil A. Bose. The new company retains the old firm name.

Out-of-town dealers who replenished their stock here during the past week included: C. C. Ackerman, Connersville, Ind.; J. H. Bovard, Newcastle, Ky.; H. A. Sturgen, Bancroft, W. Va.; Frank B. Carey, Lebanon, O.; Nicholas Sanning, Walton, Ky.; L. C. Diefenbaugh, Lewisburg, O.; Mr. Balsler, Blue Ash, O.; John Robinson, Mt. Sterling, Ky.; E. B. Scott, Batavia, O.; Mr. Blumberg, Chattanooga, Tenn.

A well-dressed and fine-appearing man, giving the name of H. E. Rose, called at the Oskamp Jewelry Co.'s store last week and selected a \$65 watch. As payment he gave a check which when presented at the bank proved to have been forged. Rose represented himself as a traveling salesman for the Mosler Safe Co. He also produced credentials and recommendations from prominent Cincinnati business men. Several other stores were visited by the swindler. A man answering to the de-

scription of Rose was arrested on suspicion at the Horning Hotel, but it proved to be mistaken identity and he was released.

## Minneapolis and St. Paul.

Miss Bacheller, with Johantgen & Kohl, Minneapolis, has gone for a fortnight's vacation.

Henry Birkenhauer, of H. Birkenhauer & Co., Minneapolis, has been laid up for several days.

W. F. Renich, of Kirchner & Renich, Minneapolis, has gone to Dakota on a recreation trip.

L. H. Nichols, Minneapolis, has gone to Williston, N. Dak., where he has a position with Fred H. Smith.

The Geneva Optical Co., Minneapolis, has just filed articles of incorporation with a capital stock of \$15,000. The object is to deal in optical, photographic and electrical goods. The incorporators are Fred H. Smith and Percy M. Smith, of Chicago, and A. D. Hayes, Minneapolis.

Recent visitors in the wholesale houses of the Twin Cities included John Saxine, Prescott, Wis.; Ed. Carow, Dayton, Minn.; M. J. Ludwig, Spooner, Wis.; S. C. Hilleman, Murdock, Minn.; O. Larsen, Bowdle, S. Dak.; L. H. Bruns, Anoka, Minn.; W. S. Blake, Duluth, Minn.; J. D. Pederson, Echo, Minn.; M. D. David, Paynesville, Minn.; B. T. Nedland, Hillsboro, N. Dak.; R. F. Lussier, Cass Lake, Minn.; A. L. Mealey, Delano, Minn.; Paul Hunziker, Jordan, Minn.; Chas. Swedberg, Hopkins, Minn.

## Detroit.

Mathauer & Koester, wholesale jewelers, 106 Woodward Ave., are enlarging their store and will put in more wall and floor cases.

Frank G. Smith, formerly of F. G. Smith, Sons & Co., quietly celebrated his 78th birthday this week. He is the only living charter member of Ashlar Lodge, No. 91, F. & A. M., which will celebrate its golden anniversary in January by issuing a gold medal bearing Mr. Smith's profile.

A chap who gave his name as Isadore Michael, Toledo, drifted into town this week and bought liberally of local wholesale jewelers. At the Chas. A. Berkey Co.'s office his bill was about \$100. He also placed a good-sized order with Noack & Gorenflo. Then he gave his check, signing it Isadore Michalls. He claimed to be a clothing dealer and gave his supposed business address. The goods were to be sent by express. Inquiry by 'phone developed the fact that there is a clothing dealer

there named Michael, but he does not contemplate putting in a line of watches and jewelry, as the chap who came here said. The checks were worthless and no one is out anything, except one of the jewelers who entertained the fellow at dinner, and who says that the time was wasted.

## New Stores and Enterprises.

G. R. Filmer, formerly of Aitkin, Minn., is a new jeweler in Mondak, Mont.

George W. Pinchon has recently opened a repair shop with J. C. Miller, at Ligonier, Ind.

A. J. Wippenman, jeweler of Idaho Falls, Idaho, contemplates opening a branch store in Rigby, Idaho.

J. F. Sumner & Son have opened a jewelry establishment at 17 S. Main St., Middleborough, Mass.

A. J. Laliberte, formerly with J. A. Filion, Lowell, Mass., has started on his own account at West Derry, N. H.

T. Goodman, formerly of San Francisco, Cal., recently engaged in the jewelry business at 112 E. Main St., Stockton, Cal.

S. L. Baxter & Son, Newton, Mass., have opened a branch store in Wellesley, Mass., of which the junior Mr. Baxter has charge.

Albert P. Myer, formerly watchmaker for Swan Swanson, Minneapolis, Minn., will shortly open a repair business on 7th St., S., in the same city.

Fred H. Towne, of Minneapolis, Minn., recently purchased a building at Mt. Henry, N. Dak., where he will establish himself in the jewelry business.

A. F. Frickie, formerly manager of the jewelry department of the Model Drug & Jewelry Store, Oklahoma City, Okla., has gone into the jewelry business there.

The H. M. Stevenson Co. has been incorporated at Buffalo with a capital of \$15,000 to deal in jewelry. The directors are Arthur R. Jenkins, Louis E. R. French and Nelson S. Hallett.

The Gem Diamond Mining & Development Co., 124 9th St., East Orange, N. J., was incorporated last week with a capital of \$125,000. The incorporators are: Albert L. Barney, Dr. C. A. Hegeman and E. A. Monfort, New York.

The Dinkelman-Rubert Co. was recently incorporated in Baltimore, Md., to deal in jewelry and kindred lines, with a capital of \$20,000. The directors are: Charles H. Dinkelman, Herman H. Rubert, Charles H. Rubert and William G. Post.

The Crown Optical Co., Rochester, N. Y., was recently incorporated to manufacture lenses and camera supplies with an authorized capital of \$5,000. The directors are: A. E. May, A. H. Hatmaker and C. E. Barber, all of Rochester, N. Y.



# A. C. BARD & CO.

IMPORTERS AND  
CUTTERS OF

# DIAMONDS

Loose or mounted goods on memo. to responsible dealers.

103 STATE ST., CHICAGO.

COLUMBUS MEMORIAL  
BUILDING.

## Pittsburg.

Charles O'Brien, of O'Brien & Co., spent last week in New York on business.

George B. Barrett left, last week, for North Bay, Canada, to spend several weeks.

Samuel C. Hall and Chester Hall, of Hall Bros. & Co., have gone on the road for Hall Bros. & Co., the new wholesale firm which recently opened a store in the Fulton building, 6th St. and Duquesne Way.

J. Alexander Hardy, of the Hardy & Hayes Co., is in Maine with his family. The Hardy & Hayes store has been renovated and the handsome clock in front of the Fifth Ave. store has been repaired and redecorated.

W. R. Hill, Fayette City; J. J. Schmidt, Turtle Creek; A. Katzenmeyer, Burgettstown; Fred A. Clough, Mt. Vernon; B. E. Brown, Monessen; Frank Bloser, New Kensington, were among the out-of-town merchants who were in Pittsburg last week on buying trips.

Detective Rothrauff, of Braddock, last week, arrested a colored man who gave the name of William Banks, and who said that he had recently been in Youngstown and Cleveland. The negro had some jewelry in his possession and the man is being held until his record can be inquired into.

The annual outing and picnic of the employes of Heeren Bros. & Co. was observed last Saturday, when 125 employes went to Ross Grove in special trolley cars and spent the day. The outing is given every year by members of the firm. Refreshments were served and all kinds of sports indulged in, such as racing, bowling and ball playing. Harry Heeren left this week for Somerset to spend his vacation.

W. W. Wattles, Sr., of W. W. Wattles & Sons, is summering at Bemus Point, Lake Chautauqua, with his family. C. W. Wattles and his family goes there next week, where the senior Wattles has a cottage. From there he will make a trip to the Thousand Islands. W. M. Fowler, of the same firm, is at Mt. Clemens, Mich. H. W. Bilke, of the Wattles house, is in the mountains at Uniontown.

W. O. Harrison, formerly with the Geo. B. Barrett Co., has associated himself as a partner with the Marsh, Brown & Mather Co., which has been incorporated with a capital of \$75,000. James R. Brown is president and C. C. Marsh is secretary. Mr. Harrison was a confidential man at the Barrett house, where he had been employed for a number of years. The directors of the new company are: Cassius C. Marsh, James R. Brown, William W. Mather, William W. Mather, William O. Harrison, Louis B. Mather.

Creditors of Pauline L. Lowenthal, Bradford, Pa., have received from Referee in Bankruptcy Jos. M. McClure notices to the effect that the report of the trustee of the bankrupt estate shows that he has in hand awaiting payment of dividends, \$1,206.73. A meeting of the creditors will be held at Mr. McClure's office in Bradford July 30, 1906, at 10 A. M., for the purpose of passing on this report and declaring a final dividend for the creditors.

Before taking to Kansas City, Mo., Fredrick H. Decker and Hugh Roman, the two men who confessed to robbing Smith &

Grin's jewelry store in that city, Detective J. Orford, of Kansas City, made a trip to New York and had a talk with the father of Decker, who is a Brooklyn banker. When arrested, Decker told the police how he and his companion robbed the store and pawned some of the jewelry here. When Decker's father learned of his son's arrest, he sent a private detective who met the Kansas City officer on his arrival. Detective Orford went back with the New York detective, to see the boy's father. The elder Decker, Orford said, arranged with him to redeem all of the stolen plunder and to make good any other jewelry that is missing when this amount is ascertained by the firm from whom the goods were stolen. It is reported, that through this action on the part of the elder Decker, both young men may get off without prosecution.

## Harrisburg, Pa.

The wife and son of I. S. Ricker, 817 N. 3d St., are on a month's trip through the northern part of the State.

Four burglars broke the glass of a window in the store of A. B. Winters, in Jermy, Pa., recently, and helped themselves to a quantity of jewelry and other articles, making good their escape. Two young men who surprised the burglars in the robbery were intimidated by threats of shooting.

The gold and bronze key to lock and unlock the great bronze doors at the new Capitol has been received. It weighs over a pound and is engraved with the names of the architect, the makers of the doors and the builder of the Capitol on a double key-stone in the center of the wreath. It will be used in the dedicatory ceremony Oct. 4.

Easton (Pa.) City Councils have passed ordinances licensing transient retail merchants by the payment of \$100 each month during the continuation of their sale; and peddlers, auctioneers and drummers by the payment of \$2 for one day's business; \$10 for one week, \$25 for three months, and \$100 for one year.

G. M. Huston, a retired jeweler, in company with his wife and son, Lewis, arrived in this city on the evening of July 15, after having covered exactly 30,940 miles in an automobile. It is his intention to make a trip covering 50,000 miles, and he expects to traverse the balance of the distance by Dec. 1, 1906. He left Chicago May 26, 1905, and toured through the northwest into Canada, and later returned to his home. On June 15 he started out again and came east to Wheeling, W. Va., and then on through to Atlantic City, where he remained seven weeks. Aug. 28 he left Atlantic City and toured through the New England States and back to Washington via Montreal and Niagara Falls. From Washington he toured through the south to Jacksonville. The return trip was started May 7, coming via Macon and Gettysburg. From here the party went to Atlantic City, and later to the Pacific Coast. They have had many thrilling experiences.

A labor paper at Cleveland recently published a half column editorial criticising the factory of the North American Watch Co., Mansfield, O., claiming that the conditions were unsanitary and making other complaints not warranted by the facts.

## Lancaster, Pa.

T. Wilson Dubbs and family are home from a visit to the seashore.

F. A. Peters, of the H. S. Meiskey Co., has been visiting Atlantic City.

Fred Wheeler, of the Non-Retailing Co., has returned from a trip to Vermont.

H. A. Romig, salesman for Benjamin Lichtenstein, was in Reading, Pa., last week.

Walter A. Stamm, a well-known silver worker, died last Thursday, after a brief illness.

William Y. Sever, a director of the Hamilton Watch Co., and his family have gone to Europe.

The Lancaster jewelry stores are observing a Friday half-holiday, and will continue it until September.

The Hamilton Watch Co.'s factory has resumed operations after being closed two weeks to give its employes a vacation.

Simon Mishler, a watchmaker, has gone to Baltimore, expecting to open a jewelry store in one of the towns near that place.

Christian Hershey, watchmaker for Charles J. Kinzer, Bluefield, W. Va., is at his home in Lancaster, owing to ill-health.

Thomas C. Mullenberg, who travels for the H. S. Meiskey Co., has gone to Atlantic City and the Thousand Islands for two weeks.

Among the jewelers visiting this city last week were S. H. Miller, Mount Joy; H. F. Andrews, Strasburg; H. L. Oberlin, of Howard L. Oberlin & Bro., Columbia; S. R. Stibgen, Marietta.

H. A. Platt, with Rees & Yankauer, paid his first visit to Lancaster last week, as did E. L. Mumford, of Miller, Fuller & Whiting, North Attleboro.

## Rochester.

Louis M. Derby, Albion, N. Y., is holding an auction sale.

David M. Finkelstein, alias "Dr. Fink," alias "Dr. B. A. Raff," wanted in this city to answer a charge of grand larceny, second degree, for misappropriating and converting to his own use \$161, the personal property of Abraham Rapaport, a jeweler of this city, was arrested recently in Baltimore through information furnished by the Rochester police department. Finkelstein, it is claimed, came to this city some time ago and opened up offices. He practised under the name of Dr. B. A. Roff and quickly made friends, building up a large practice. About a month ago he went to Rapaport, who conducts a jewelry store on Stephany Pl., and asked to be shown a gold watch, diamond ring, also a chain and charm. He gave Rapaport his professional card and asked to be permitted to take the jewelry on approval. Rapaport agreed and says that was the last he saw of Finkelstein and the jewelry.

The shipment of moss agates and rose quartz from the vicinity of Deadwood, S. Dak., to Germany has revived interest in that product again. The rose quartz is used for parasol handles and jewelry. The shipment weighed 3,500 pounds, and was valued at \$700.

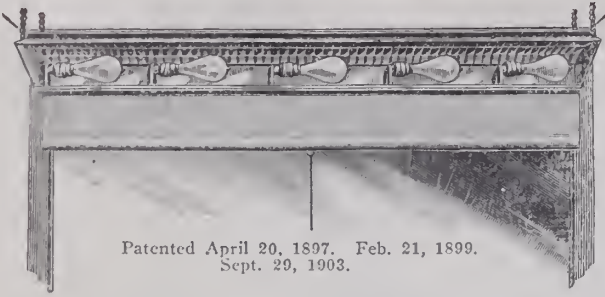

Patented April 20, 1897. Feb. 21, 1899.  
Sept. 29, 1903.

# IMPROVEMENT

to their stores is the uppermost thought in the minds of many merchants at this time. Perhaps you are planning to bring yours into the line of modern, well-equipped shops. If so, the first thoughts will naturally be given to the front—the store's introduction—and in connection therewith, the lighting. **FRINK'S SPECIAL PATENT WINDOW REFLECTOR** is successfully meeting the fullest requirements of thousands of particular business men. Efficient, economical and durable. The cost of equipping your windows may be less than you suppose. We will appreciate telling you what it is.

Gorham Co., New York.  
Harris & Co., Washington, D. C.  
F. A. Robbins, Springfield, Mass.  
Theo. A. Kohn, New York.

Marcus & Co., New York.  
F. Bucher, Baltimore.  
Wiss & Son, Newark, N. J.  
Wm. Barthman, New York.

Mauser Mfg. Co., New York.  
Lewis & Co., Ogden, Utah.  
Castleberg, Washington, D. C.  
Lambert Bros., New York.

Dominick & Haff, New York.  
Hennegan & Bates, Baltimore.  
Simons & Co., New Haven.  
Frankfield & Co., New York.

And many others whom you know, use Frink Reflectors. Our printed matter is interesting.

**I. P. FRINK, 551 Pearl Street,**

**NEW YORK.**



## Black Leather Mugs

Silver Plated Mountings  
Gold Lined

Send for Catalogue

A complete line in our New York Office:

25 West Broadway

Style 607,  
List \$12.50.



Style 600, List \$7.50.

**St. Louis Silver Company**

ST. LOUIS, U. S. A.



5,600 America Alarms are shipped our dealers every day —Getting your share of this profit?

# The REX Cuff Button

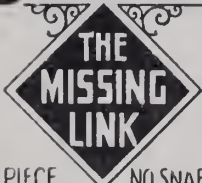
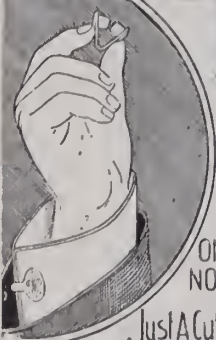

ONE PIECE NO LEVER NO SNAP NO SPRING

Just A Cuff Button That Cannot Break

Shipped in individual cartons holding 1 doz. pairs. Ask your jobber for them; if he does not supply you, write us. Sample pair furnished jobbers on request.

**E. E. STANINGER**

Sole Manufacturer

Hartford Bldg.

CHICAGO, ILL.

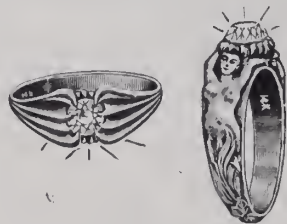

Manufacturer of Diamond Mountings and Diamond Set Jewelry  
Importer of Diamonds and Precious Stones

**A. S. Hirshberg,**

373 Washington Street, Boston, Mass.

Cable Addresses: { Ashir, Boston. Hochschüler, Antwerp.

## GARREAUD & GRISER

38 & 70 Nassau St., New York.

**LAPIDARIES.** PRECIOUS STONES.  
GEMS in Unique Cuttings

**A. Nonnenmann & J. Aschenbrenner,**  
114-118 East 23d St., New York.

**Original Designers** for Platinum, Gold and Silver Jewelry. Artistic Designs for Silverware and Novelties furnished at shortest notice.

The Western Clock Mfg. Co.

LA SALLE, ILL.

INDEX TO ADVERTISEMENTS.

Adams & Singleton	31	Friedlander, R. L. & M. H.	Outside back cover	Ohan, G.	78
Alkin-Lambert Co.	103	Frink, I. P.	74	Oppenheimer Bros. & Voith	40
Allsopp & Allsopp	25	Garrunet & Griser	74	Oppenheimer, H. E., & Co.	40
Allsopp Bros.	21	Gesswein, F. W., Co.	96	Oriental Bank	62
Alsterlund, H. E., & Co.	33	Goldsmith, C. P., & Co.	20	Osmun-Parker Mfg. Co.	22
Alvin Mfg. Co.	Inside front cover	Goodfriend Bros.	48	Ostby & Barton Co.	21
American Gem & Pearl Co.	56	Gorham Co.	58	Patek, Philippe & Co.	90
American Platinum Works	101	Gongelman, Paul	102	Potter & Buffinton Co.	31
American Silver Co.	33	Griffoul, August	104	Power, Chas. L., & Co.	48
American Waltham Watch Co.	82	Guardian Trust Co.	62	Powers & Mayer	13
Apollo Silver Co.	100	Hagstoz, T. B., Ltd.	104	Prior, Charles M.	24
Arch Crown Mfg. Co.	60	Harris & Harrington	Outside back cover	Prybil, P.	104
Arnsteln Bros. & Co.	50, Outside back cover	Hedges, A. J., & Co.	22	Pryor Novelty Co.	33
Aschelm, Jules	26	Hedges, Wm. S., & Co.	48	Racine, Jules	89
Austin, John, & Son	Outside back cover	Heintz Bros.	27	Reichhelm, E. P., & Co.	96
Aztec Turquoise Co.	51	Heller, L., & Son	42	Reinzihausen, W. F., Co.	104
Bagg, Perle & Co.	52	Hepers Bros.	102	Revel, A. H., & Co.	Outside back cover
Baker, Geo. M.	Outside back cover	Hirschberg, A. S.	74	Rice's, Bernard, Sons	100
Ball, Webb C., Watch Co.	68	Hodenyyl & Walker	42	Ries & Armstrong	89
Bard, A. C., & Co.	72	Hoe's, James C., Sons	102	Rockford Watch Co.	75
Baschkopf, Jacob	78	Hotel St. James	100	Roger Williams Silver Co.	100
Bassett Jewelry Co.	31	Howard, E., Clock Co.	87	Roseman, A.	56
Bates & Bacon	17	Hruba, Louis W.	98	Rothschild Bros. & Co.	26
Bealmear, H., & Co.	98	Humphrey, John B.	56	Roy Watch Case Co.	90
Berge, J. & H.	103	Illinois Watch Co.	8	Rudlen, J. W., & Co.	78
Bigalke & Eckert Co.	64	International Gem Co.	54	Rudolph & Suedeker	90
Bigney, S. O., & Co.	I, 66	International Silver Co.	14	Rumpp, C. F., & Sons	103
Billings, Chester, & Son	46	Jacot Music Box Co.	98	Saart, W. H., Co.	102
Bishop, R. W.	102	Jeanneur, F., Jr.	104	Saunders, Meurer & Co.	48
Blackinton, W. & S., Co.	38	Jeanne, Frederick A.	52	Schiff, M.	26
Blancard & Co.	103	Jewelers' League	26	Schultz, Leiss & Co.	19
Borrelli & Vitelli	48	Johnston, W. J., Co.	10, 11	Sessions Clock Co.	89
Bowden, J. B., & Co.	21	Juergens & Andersen Co.	68	Shifer & Douglas	22
Bradley Polytechnic Institute	78	Juergensen, Jules	90	Shiman Bros. & Co.	70
Brettner, R.	48	Kahu, L. & M., & Co.	Outside back cover	Simmons, R. F., Co.	15
Brower, Maurice	46	Keck, Herman Mfg. Co.	68	Smith, Alfred H., & Co.	40
Brühl Bros. & Henius Co.	Outside back cover	Keit & Woodland	23	Smith, E. H. H., Silver Co.	103
Buckley, Sam'l., & Co.	24	Ketchum & McDougall	98	Smith, Frank W., Co.	18
Bunde & Umpver Co.	50	Klipper Bros.	88	Smith, Wm., & Co.	31
Cahoone, Geo. H., Co.	29	Kohlbusch, Herman, Sr.	102	Snow & Westcott	24
Carrington & Co.	22	Kohn, Alois, & Co.	26	Sohn & Hyman	56
Carter, Howe & Co.	23	Kohn & Co.	27	Solidarity Watch Case Co.	32
Castiglioni & Capaldi Co.	31	Kohland & Italle Co.	28	Spencer, E. L., Co.	30
Chatham National Bank	62	Lackner & Ohl	100	Staninger, E. E.	74
Chopard Frères	42	Langendorf Watch Co.	90	State Bank	62
"Cloverette"	16	Larter & Sons	36	Steiner, Louis	98
Conley & Straight	103	Lederer, S. & B., Co.	29, 33	Stern Bros. & Co.	54, Inside back cover
Cooper Diamond Co.	46	Lees & Sanders	104	Sternau, S., & Co.	16
Cottle, M.	20	Lelmann Bros.	96	Stiven, John S.	104
Cross & Beguelin	32, 60	Leong, L., & Bro.	Outside back cover	St. Louis Silver Co.	74
Crossman, Chas. S., & Co.	54	Levy, C. M.	28	St. Louis Watchmaking School	87
Crossman Co.	52	Lewy & Cohen	19	Strauss, Ignaz, & Co.	Outside back cover
Crouch & Fitzgerald	34	Lissauer & Co.	42	Strauss, Jacob, & Sons	56
Dattelbaum & Friedlan	38	Loeb, Wm., & Co.	33	Street, Geo. O., & Sons	20
Day, Clark & Co.	33	Lorsch, Albert, & Co.	Outside back cover	Tavannes Watch Co.	64
Dederick's Sons, James H.	104	Loth, Joseph, & Co.	100	Thomas, Seth, Clock Co.	88
Depasse Mfg. Co.	24	Lowe, Edwin, & Co., Inc.	32	Tivoli Art Glass Co.	100
De Selms Watch School	78	Luthy & Hine	24	Trenton Watch Co.	88
Diamond Point Pen Co.	100	Lyons Gem Co.	48	Trout, Charles L., & Co.	22
Digshelm, Hipp., & Bro.	89	Maebert & Reiss	89	Van Dam, Eduard	46
Donnelly, J. J.	96	Manning, Bowman & Co.	67	Wadsworth Watch Case Co.	6, 7
Dorfinger, C., & Sons	98	Maple City Glass Co.	98	Wagner Mfg. Co.	25
Dubois Watch Case Co.	87	Market & Fulton National Bank	62	Waite-Thresher Co.	30
Dulk, Robert	29	Mendes Cutting Factories	102	Washburn, C. Irving	29
Dunbar, Leach, Garner Co.	96	Mercantile National Bank	63	Wells, Chester H.	20
Durand & Co.	22	Meyerowitz Bros.	75	Wendell & Co.	5
Eichberg & Co.	54	Miller, Fuller & Whiting	32	Western Clock Co.	74
Elgin National Watch Co.	84	Moore & Sons	20	Wheeler, Hayden W., & Co.	40
Eliassof Bros. & Co.	102	Monnt & Woodhull	50	Whiteside & Blank	23
E. P. H. Chain Catch	29	Myers, S. F., Co.	33	Whiting & Davis	18
Fahys, Joseph, & Co.	1	Nebeling, Edmund R.	48	Whiting Mfg. Co.	9
Fairchild & Co.	103	Newburgh, R.	88	Wightman & Hough Co.	30
Favre-Jacot, Georges, & Co.	91	New England Watch Co.	86	Witsenhausen, L.	20
Feeley, W. J., Co.	25	New York Central Railroad	102	Wittnauer, A., Co.	90
Forman Co.	98	New York Telephone Co.	96	Wodiska, Julius	27
Forsinger, J. W.	91	Noel, Rudolph, & Co.	68	Wolfshelm & Sachs	78
Foster, Theodore W., & Bro. Co.	34	Nonnenmann, A., & J. Aschenbrenner	74	Wood, C. F., & Co.	Outside back cover
Fox, Gustave, Co.	17	Noterman, Jos., & Co.	64	Wood, J. R., & Sons	2, 3
Freund, Henry, & Bro.	28	Novelty Engineering Ass'n	96	Woodside Sterling Co.	12

# Rockford Watches Speak for Themselves.

MEYEROWITZ BROS.,

IMPORTERS OF **DIAMONDS,** 37-39 MAIDEN LANE, NEW YORK CITY

A Complete Line of Precious, Semi-Precious and Imitation Stones. Mail orders promptly attended to.

## Special Notices.

Payable invariably in advance.

Rates 75c. per insertion for notices not exceeding 25 words; additional words, 2c. each.

**SITUATIONS WANTED, 1c. a word each insertion; minimum charge, 25c.**

Heavy type, 5c. a word; minimum charge, \$1.25. Display cards, \$2.00 per inch.

In all cases, if answers are to be forwarded, 10c. extra to cover postage must be enclosed.

*All answers to advertisements addressed care The Jewelers' Circular-Weekly, should be sent to the New York Office, unless the Chicago Office is specifically mentioned.*

## Situations Wanted.

**BOOKKEEPER**, of good experience; in or out of town; salary, \$20. "R. H. S., 7000," care Jewelers' Circular-Weekly.

**POSITION WANTED**; high class watchmaker; A1 on railroad watch work; best of references. Address Lem Clarke, 265 S. Pryor St., Atlanta, Ga.

**AN EXPERIENCED** young man desires a position in a wholesale jewelry house. Address "Unquestionable References, 6972," care Jewelers' Circular-Weekly.

**TEN YEARS** in wholesale jewelry business; young man, 23 years old, wishes position as salesman or to work inside. "Box 7003," care Jewelers' Circular-Weekly.

**SALESMAN** of experience, and well acquainted with trade in middle west, would like to connect with a manufacturer. "Reliable, 6969," care Jewelers' Circular-Weekly.

**YOUNG LADY**, good engraver, jeweler and A1 saleslady, wishes position Sept. 1; southern States; best of references; state salary. Address 698 S. Pryor St., Atlanta, Ga.

**ENGRAVER**, jeweler and salesman; good workman; married; wishes position in western States; samples and references given. "Western, 6951," care Jewelers' Circular-Weekly.

**WANTED, A POSITION** as engraver, bookkeeper, cashier and saleslady; good references; terms reasonable. Address "Enquirer, 6877," care Jewelers' Circular-Weekly.

**BY WATCHMAKER** and engraver as second man; can do some clock and jewelry repairing; prefer eastern States; will answer all letters. "H., 6977," care Jewelers' Circular-Weekly.

**WANTED, by a young man**, engraver's position at once; can do jewelry repairing; long experience; samples and references on request. Address "G., 6959," care Jewelers' Circular-Weekly.

**DIAMOND SETTER**; young man wishes position as foreman setter, or to take charge of office and setting department; good experience; A1 references. "Setter, 6945," care Jewelers' Circular-Weekly.

**ETCHER** on sterling, soft metal, etc., familiar with latest processes; wants position as head of department making his own designs. Address "Etching, 6976," care Jewelers' Circular-Weekly.

**FIRST CLASS** watchmaker, 25 years' experience, wants position; take charge of store; also optician and salesman; in New York City only; best of references. "City, 6978," care Jewelers' Circular-Weekly.

**MANUFACTURING JEWELER**, stone setter and engraver, wants good position; can take charge of shop or repair department of store; good references. Address "Jewel, 6979," care Jewelers' Circular-Weekly.

**COMPETENT** watchmaker and adjuster, jeweler, engraver, optician, to change Sept. 1; good habits; splendid references; capable of taking charge. Address "A. B. C., 6967," care Jewelers' Circular-Weekly.

**FOREMAN**, designer and thoroughly experienced jeweler; fine platinum mountings a specialty; fully able to manage small or large factory in all its details. Address "A. S., 6907," care Jewelers' Circular-Weekly.

**FIRST CLASS** watchmaker, optician and salesman, competent to take charge of department; Colorado preferred; 25 years' experience; strictly temperate; steady position wanted; references. "A., 6975," care Jewelers' Circular-Weekly.

**DESIGNER** and jeweler; first class and experienced on platinum diamond mountings, artistic gold jewelry and fraternity jewels, wants position where he can work up and carry out his own designs. "D. & J., 6986," care Jewelers' Circular-Weekly.

**A WATCHMAKER** of recognized ability; trained in London; 15 years' American experience; seeks position in first class firm as fine watchmaker and adjuster; highest references; have also New York optical diploma. "H. G., 6794," care Jewelers' Circular-Weekly.

**A1 WATCHMAKER**, graduate optician; fine letter and monogram engraver; 21 years' experience; good appearance; no bad habits; A1 references; lathe, modern tools and trial case; Indiana or Illinois; would not go east of Indiana. Address "C. W., 6963," care Jewelers' Circular-Weekly.

**FIRST CLASS** watchmaker, engraver and optician; good salesman, etc.; will be open for a position about Oct. 1; capable of taking full charge of store; only a steady position at a good salary will be considered; reference furnished. Address "E. F. O., 6995," care Jewelers' Circular-Weekly.

**ENGRAVER**, a mechanic and executive of known ability, just finishing contract, desires a change; all kinds of ornamental work, surface, relief or pierced; specialty Masonic and emblem work; cutting for enamel, chasing and die cutting pertaining to same; thoroughly reliable, best of reference; only A1 position with reliable firm will be considered. Address "Gravure, 6988," care Jewelers' Circular-Weekly.

**ACCOUNTANT** of large experience wishes to establish connections in the jewelry trade; books audited, statements taken off and bookkeeping systems established; terms \$5 per day in New York. Address, "S., 6900," care Jewelers' Circular-Weekly.

## Side Lines Wanted.

**WANTED**, gold line of jewelry; gold rings, gold chains; representative firms make of goods; to sell on commission in conjunction with my diamond business for cities, Philadelphia, Baltimore and Washington, D. C. Address E. M. Bracher, 929 Chestnut St., Philadelphia, Pa.

## Help Wanted.

**A YOUNG MAN** as assistant watchmaker and engraver, at once. Thos. L. Bell, Americus, Ga.

**WANTED, AT ONCE**, a good optician who can also assist at watch work. W. C. Bryant, Bangor, Me.

**WANTED**, optical clerk living in New York or suburbs. R., L. & M. Friedlander, 30 Maiden Lane, New York.

**WANTED**, first class jeweler for small town in Pennsylvania. Address "L. B., 6964," care Jewelers' Circular-Weekly.

**AT ONCE**, watchmaker and engraver; permanent position to a good man. "M., 6849," care Jewelers' Circular-Weekly.

**WANTED**, a good jeweler and engraver; permanent position for good man. Address M. E. La Vake, Princeton, N. J.

**WANTED**, two first class jewelry and silverware salesmen, for retail trade. Apply to Duhme Jewelry Co., Cincinnati, O.

**WANTED**, a young man to repair American clocks, with reference. Apply W. E. Taylor, 7 Cortlandt St., New York.

**FIRST CLASS** watchmaker wanted for permanent, good position; salary, \$25. Apply to N. Salzman, Galveston, Tex.

**WANTED**, salesman, watchmaker; all around man; description and full particulars in first letter. W. M. Tobin & Co., Pittsburg, Pa.

**WANTED, AT ONCE**, watchmaker, jewelry jobber and clock repairer; wages, \$15; permanent position. J. H. Lepper, Mason City, Ia.

**WANTED**, experienced salesman for established line of cut glass in New England and Middle West. Address Box 774 J, Corning, N. Y.

**WANTED**, optician who understands testing eyes; good salary and chance for advancement. A. Kahn, 935 F. St., N. W., Washington, D. C.

**WANTED**, young lady, double entry bookkeeper, with some knowledge of typewriting. Answer, Frolichstein, England & Klein, 32 Fulton St., New York.

**PERMANENT POSITION** for thoroughly competent watchmaker; state salary and give references in first letter. Eugene V. Haynes Co., Atlanta, Ga.

**WANTED**, an experienced shipping clerk for wholesale jewelry house; good prospects for the right party. S. Davis & Co., 723 Liberty Ave., Pittsburg, Pa.

**AT ONCE**, first class watchmaker and optician; steady position and good pay; must be capable of handling railroad watches. W. J. Gamm, Madison, Wis.

**WANTED**, young man who understands the repairing of watches and clocks; steady position to good man. Address "W., 6950," care Jewelers' Circular-Weekly.

**WANTED**, first class watch and clockmaker and engraver; must be A1 workman; no others need apply; steady job, \$20 per week. C. A. Tucker, Jeweler, Lincoln, Nebr.

**WATCHMAKER WANTED**, a first class man, used to receiving and delivering, to work at front bench. Address or apply to Rowe Bros., 28 Washington St., Chicago, Ill.

**BOOKKEEPERS**, exceptional openings with some of the 20,000 firms we serve for thoroughly competent men; \$700-\$1,500; write us to-day. Hapgood's, 305 Broadway, New York.

**EXPERIENCED** young lady as stock and entry clerk, by Maiden Lane wholesale jewelers; must be quick and accurate at figures. "Accurate, 6971," care Jewelers' Circular-Weekly.

**WANTED, WATCHMAKER**, must be good salesman; experienced; salary based upon ability. Jules Asheim, 37 Maiden Lane, New York; or, Southern Loan and Jewelry Co., Tampa, Fla.

**WANTED**, engraver and jeweler; send reference in first letter. Sylvan Bros., Columbia, S. C.

**WANTED** first class watchmaker and salesman. "Permanent, 6910," care Jewelers' Circular-Weekly.

**WANTED**, optician and engraver, with some knowledge of jewelry repairing. Sylvan Bros., Columbia, S. C.

**WANTED**, good combination watchmaker, engraver and salesman; wages \$22 weekly; permanent; hours, 8 to 6; all particulars and references in first letter. T. W. Morrison, Newburgh, N. Y.

**WANTED, WATCHMAKER**; must be skilled mechanic in all grades of high class work; good wages and permanent position to A1 man; send references. Henry Birks & Sons, Ltd., Montreal, Canada.

**WANTED**, good engraver who can do fine monogram, old English and script lettering; good salary; permanent job; young man preferred. H. C. Abbott & Bro., 1905 Second Ave., Birmingham, Ala.

**WATCHMAKER**, experienced in fitting and selling watchmaker's materials and tools; permanent position for the right man; call or correspond; reference. Aisenstein & Woronock, 22 Eldridge St., New York.

**WANTED, CLOCKMAKER**, who is also an experienced letter and monogram engraver; send samples of engraving with references; and state salary wanted. Address C. L. Byrd & Co., Memphis, Tenn.

**WANTED**, high class jeweler and diamond setter to take charge of a fine shop, in a retail store; highest wages; permanent position; references required. Address "M. J., 6973," care Jewelers' Circular-Weekly.

**WANTED, WATCHMAKER** with some or no experience, wishing to finish or learn the trade; can work with expert; term of 10 months, \$150; satisfaction guaranteed. Wm. A. Landt, 126 State St., Chicago, Ill.



**HELP WANTED.—Continued.**

WANTED, experienced watchmaker, engraver and salesman; send sample of engraving, reference, age and salary expected; steady position and short hours. Address "Indiana, 6821," care Jewelers' Circular-Weekly.

A FIRST CLASS ENGRAVER; one who can do all kinds of lettering and monogram engraving; can use a good steady man at a good salary. Apply to A. Newsalt, Jeweler, cor. Fourth and Main Sts., Dayton, O.

FIRST CLASS watchmaker and optician wanted; good opportunity offered to right party; steady position; in one of the large cities in Pennsylvania; write at once. L. W. Rubenstein, 54 Maiden Lane, New York.

FOREMAN WANTED, with practical and executive ability, to take charge of a factory in Newark, N. J., making high class 14 K. jewelry; must understand alloying and coloring. "Foreman, 6954," care Jewelers' Circular-Weekly.

FIRST CLASS watchmaker for American house, in New York. Address "Permanent, 6784," care Jewelers' Circular-Weekly.

JEWELRY REPAIRER and stone setter for American house, in New York. Address, "Permanent, 6785," care Jewelers' Circular-Weekly.

WANTED, stock clerk, a job clerk, male or female, and one errand boy for wholesale jeweler. Chas. L. Trout & Co., 15 Maiden Lane, New York.

WANTED, a first class optician; one who understands edge grinding preferred; steady employment and good wages to the right man; must come well recommended. Address "Central Connecticut, 6640," care Jewelers' Circular-Weekly.

WANTED, by a Chestnut St. jewelry house, a young man experienced in selling diamonds and fine gold jewelry; when replying state past experience; want a Philadelphia man who controls some trade. "C., 6952," care Jewelers' Circular-Weekly.

WANTED, first class watchmaker to take in and deliver work and work at bench; must be good appearing and understand how to handle fine trade; also one fine bench watchmaker; highest wages to right parties. Address Lawrence L. Moore Co., Seattle, Wash.

WANTED for Virginia, salesman, young man about 25 years old, with practical experience preferred; permanent position; \$50 per month with chance to advance; send photo and recommendations in first letter. Address care Room 711, 2 Maiden Lane, New York.

WANTED, jewelry engraver for Winnipeg; permanent position and good wages. Apply to R. Wallace & Sons Mfg. Co., 131 Wabash Ave., Chicago, Ill.

WANT WATCHMAKER and optician, one who understands diamond setting and waiting on trade; none but those thoroughly qualified for the above position need apply; must furnish A1 references as to honesty and qualifications; salary, \$20 to start. S. W. Tasch, Danbury, Conn.

WANTED, AT ONCE, a thorough, competent watchmaker, jeweler and diamond setter; one who can do some engraving preferred; must be sober and industrious; a permanent position to the right man; address, stating wages and references. W. T. Eisensmith, Box 358, Charleston, W. Va.

WATCHMAKER; must be fine workman; experienced on fine and complicated watches; competent to handle customers and take charge of watch department; salary, \$25 per week; permanent position, in large store; city in New York State. Address "J., 6981," care Jewelers' Circular-Weekly.

EXPERIENCED watchmaker and clock repairer; quick workman, for Washington, D. C.; fine French and chime clocks your special work; apply, stating years of experience and where, also age, and wages expected; life position to right man; hours, 8 to 6. "Box 6333," care Jewelers' Circular-Weekly.

ABRAHAM & STRAUS, Brooklyn, need in the repair section of their jewelry department a young woman to care for the clerical work; knowledge of jewelry is essential; apply to superintendent.

A JEWELRY foreman wanted in a first class ring factory; a fine opportunity for man who thoroughly understands the business; applications considered confidential. M. B. Bryant & Co., 7 Maiden Lane, New York.

COMPETENT WATCHMAKER AND engraver wanted for the Philippine Islands; salary \$125 per month; replies should mention full particulars. Address, "Opportunity, 6935," care Jewelers' Circular-Weekly.

WANTED, salesman for a leading American watch house to travel Pennsylvania and New York; an unusual opportunity; state experience and address in confidence, "Watches, 6930," care Jewelers' Circular-Weekly.

TWO MEN WANTED; we need two combination men to fill the following positions, jeweler, watchmaker, engraver, diamond setter and graduate optician; each applicant must be reliable and furnish references as to his ability to fill two or more of the above positions; state salary expected. Ignatius Fried, Jeweler and Diamond Expert, Mobile, Ala.

WANTED, a first class watchmaker and engraver; one who understands jewelry jobbing; good salary to strictly first class man; none other need apply; address with references. Cooper Queen Consolidated Mining Co., Bisbee, Ariz.

A STRICTLY first class, all around workman; single man of good address and practical experience; watchmaker, jeweler, engraver (including monogram), optician and salesman; competent and willing in any capacity; man must be strictly honest, sober, reliable and no gambler; I will pay good wages and must get conscientious service; cannot use man worth less than \$25 a week; will pay a percentage on optics; I have complete trial case and dark room; send references, samples of engraving and full particulars in first letter. Chas. E. Rose, Telluride, Colo.

**Business Opportunities.**

FOR SALE, very cheap, old established jewelry and optical store. T. J. Skidmore, 750 Fulton St., Brooklyn, N. Y.

AT A BARGAIN, jewelry stock and fixtures; invoice, \$950; only stock in town of 900; three brick plants, two coal mines; good trade. Oleson Bros., Lehigh, Pa.

FOR SALE, well equipped manufacturing jewelry shop, in rapidly growing western city of 40,000; good machinery; old established place; no competition. Address "F. G., 6860," care Jewelers' Circular-Weekly.

FOR SALE, jewelry and optical business, doing good business in one of the best health and pleasure resorts of Colorado; invoice, \$4,000; can reduce or give time on part. "Resort, 6924," care Jewelers' Circular-Weekly.

I WANT YOU TO KNOW, Mr. Merchant, that if you wish to retire from business I can turn your store into cash; my charges are a small commission if I sell your store; no charges if I do not; write me; all is held in strict confidence. Address Dan. I. Murray, Broker, 3 Maiden Lane, New York.

DO YOU WISH TO RETIRE? We buy jewelry stores to any amount; also entire stocks of jewelry, diamonds, watches, silverware, fixtures, etc.; we are known all over the United States to pay highest spot cash; notify us, we will call on you at once; all business transacted we handle strictly confidential. Address Brooklyn Purchasing Syndicate, 608 Broadway, Brooklyn, N. Y., or Tel. 2328, Williamsburg.

MAN, thoroughly experienced in the manufacturing of jewelry for the wholesale or retail trade; artistic designer and modeler, for the cutting of steel dies by machine; owner of a patent for the making of ornamented seamless bracelets and rings, hollow or solid, in plate or solid gold; wants a partner with capital to start a plant, which is not only promising but cannot fail to be successful. Address "Partner, 6830," care Jewelers' Circular-Weekly.

QUICK ACTION by corresponding with us; we buy your entire stock; or send us your surplus stock of watches and diamonds; we originated this method and have twenty years of quick action and good service to our credit. Joseph Brown & Co., Fifth Ave. and Madison St., Chicago, Ill.

**For Sale.**

QUARTERED OAK, French plate glass wall and umbrella cases for sale cheap; write for particulars. C. J. Rueffer, 18 S. Main St., Wilkes-Barre, Pa.

FOR SALE, machinery for manufacturing jewelers; turning lathe; round, flat and square rollers; slower, melting furnace, shafting, pulleys, belting, etc.; will sell by piece or bulk; write for further information. Walter Hulsick, 217 N. 6th St., St. Louis, Mo.

**Wanted to Purchase.**

WANTED, to purchase, established jewelry or optical business. C. Bart, 7 Fifth Ave., New York.

WANTED, second hand bench for four setters; curved style, in good condition. Isidor Stern, 51-53 Maiden Lane, New York.

ANTIQUÉ JEWELRY WANTED; we are always ready to make cash offers on any antique jewelry containing mosaics, cameos, seed pearls, etc.; also filigree, enameled or etruscan jewelry, either all gold or set with diamonds or other stones. Chas. S. Crossman & Co., The "Old Mine" Diamond House, established 1880, 3 Maiden Lane, New York.

**To Let.**

DESK ROOM or part of office to let. 3 Maiden Lane, Room 53, New York.

TO LET, an exceptionally desirable small office, with fine north light; seventh floor; 7 Maiden Lane. Inquire W. W. Young & Co., Room 74, 7 Maiden Lane, New York.

**Miscellaneous.**

FREE; we will send to you free the July 11th number of this magazine which illustrates two new ideas for jewelers' window exhibits, both of which you can duplicate in the main; also construct many other exhibits of equal merit, by sending us \$3 for devices; your money back if you are not delighted. The Window Exhibitor Co., 74 Cortlandt St., New York.

**TO LET.****Three Desirable Light Lofts**

At 31 MAIDEN LANE, N. Y.,

One door from Nassau St. Prominent location, center of jewelry district. Address F. J. Whiton, 130 Broadway, New York; or, your own broker.

**TRADE-MARKS**

OF THE

**JEWELRY and KINDRED TRADES,**

PRICE \$3.00.

THE JEWELERS' CIRCULAR PUB. CO.,  
11 John St., Cor. Broadway, New York.

## Boxes and Trays THAT GIVE SATISFACTION



Velvet, Plush and Morocco  
Cases of Every  
Description for  
JEWELRY and SILVERWARE.

Special Pieces Made to Order.

We make a Specialty of Fine  
Blocks and Stands for  
WINDOW DISPLAYS.

Travelers Trays and Cases in  
all Sizes.

Visiting Buyers will find it  
advantageous to inspect our  
stock while in town.



**Wolfsheim & Sachs**  
35 MAIDEN LANE  
NEW YORK

Factory  
10 GOLD ST.

Telephone  
3518 John

### GENERAL WATCH CASE REPAIRING.

Gold and  
Silver  
Plating,  
Satin  
Finishing,  
Engraving  
and  
Engine-  
Turning.



Old  
English  
and Swiss  
Cases  
changed  
to fit  
American  
Stem-  
Wind  
Move-  
ments.

**J. W. RUDLEN & CO.,**  
90 State St., CHICAGO, ILL.

### Horological Department, BRADLEY POLYTECHNIC INSTITUTE, Formerly Parsons Horological Institute, PEORIA, ILLINOIS.

Largest and Best Watch School in America.  
We teach Watch Work, Jewelry, Engraving, Clock Work,  
Optics. Tuition reasonable. Board and rooms near  
school at moderate rates. Send for Catalog of Information.

### Expert WATCH and Chronometer REPAIRING FOR THE TRADE.

When others fail you we guarantee satisfaction.  
A trial will convince. Prices very reasonable.

List will be sent on request.

**G. OHAN, 37-39 Maiden Lane,**  
Lorsch Bldg., Room 27. NEW YORK.

### LEARN WATCHMAKING AT HOME

by THE De SELMS CHART SYSTEM, copyrighted and patented. The  
most simple, practical and up to the minute method of learning.

Saves you time and money while learning and puts you in a position to  
more than double your income.

60 million timepieces to be repaired. Accurate time is a necessity in the  
business world. When time is money the watchmaker gets his share of  
profit. Positions for graduates. Booklet free. Write to-day.

The De SELMS WATCH SCHOOL,  
109 Perry Street, ATTICA, INDIANA.

**JACOB BASCHKOPF,**  
**DIAMOND SETTER,**  
LETTER AND MONOGRAM  
**ENGRAVER,**  
9-13 MAIDEN LANE,  
NEW YORK.  
Room 701  
Jewelers' Bldg.

### Practical Course in Adjusting

By THEO. GRIBI,

#### COMPRISING

A review of the laws governing the motion of the  
balance and balance spring in watches and  
chronometers, and application of the principles  
deduced therefrom in the correction of vari-  
ations of rate arising from want of isochronism,  
change of position and variation of temper-  
ature.

#### ELUCIDATED AND DEMONSTRATED

by original experimental researches in the actual  
problem, never before published, showing the  
causes that are operative in the variation of  
rate, and leading to correct remedies. To  
which have been added chapters on

How to make a Balance Arbor with  
Modern Appliances; How to Clean a Watch  
Properly; and, the Lever Escapement—  
Some Current Defects in it and How to  
Remedy Them.

PRICE, \$2.50.

250 pages, including 18 diagram plates; Fine  
Paper; Large Type; Clear Illustrations; System-  
atically arranged; Solid Binding.

**THE JEWELERS' CIRCULAR PUB. CO.**  
Publishers

11 John St., cor. Broadway, New York.

*Now on Press*

1906-1907 EDITION

OF

THE JEWELERS'  
CIRCULAR-WEEKLY

# Buyers' Directory

OF THE

Manufacturers, Importers  
and Jobbers

IN THE

JEWELRY AND  
KINDRED TRADES

A Handy, Classified List for Desk or Pocket

*Price, 50 Cents*

*The Jewelers' Circular  
Publishing Co.*

11 JOHN ST. . NEW YORK

(Corbin Building)

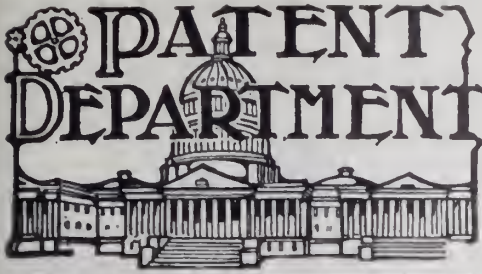

[IN WHICH IS CONTAINED A LIST OF THE LATEST PATENTS GRANTED BY THE UNITED STATES AND GREAT BRITAIN, THE UNITED STATES PATENTS THAT HAVE EXPIRED AND THE REGISTERED TRADE-MARKS.]

UNITED STATES PATENTS.

ISSUE OF JULY 10, 1906.

825,314. EYEGGLASS-GUARD. WILLIAM G. HAHN, San Francisco, Cal. Filed July 25, 1902. Serial No. 117,013.

An article of the class described consisting of a V-shaped member formed with diverging legs and having the outer extremity of one leg secured to the lens, the opposite leg being bent backward

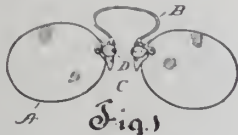

out of the plane of said first-mentioned leg and having its free extremity bent to form an angle with the remaining portion and in a plane approximately at right angles with said first-mentioned leg, and a bearing-button secured to said terminal portion of the opposite leg, said V-shaped member being formed of flat resilient material.

825,316. HOLDER FOR COMMUNION-CUPS. CALVIN P. HARRIS, New York, assignor to Reed & Barton. Filed July 24, 1905. Serial No. 270,959.

A pew-rack for communion-cups consisting of a strip or board adapted to be attached edgewise to the back of a pew, said strap having a vertical

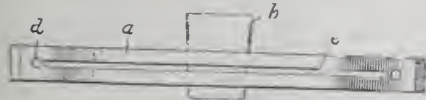

opening therethrough adapted to hold a communion cup when set therein, and said strip having a horizontal slot or kerf cut into one edge thereof and extending therein beyond the cup-holding openings, whereby the rack is rendered noiseless.

825,319. SUN-DIAL. EDWARD G. HEWITT, New York. Filed April 20, 1905. Serial No. 256,650.

In a sun-dial, the combination of a horizontal base having means for securing it to a support and permitting partial rotation of the base in a horizontal plane, standards at opposite sides of the base, a slotted, arc-shaped carrier, having ears de-

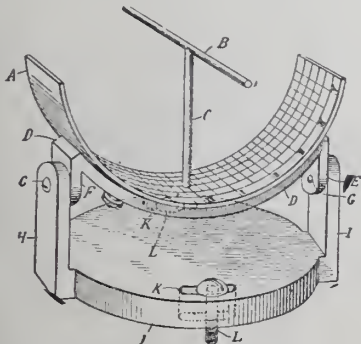

pending from its ends and pivoted to the standards whereby the carrier may be adjusted in the

plane of the meridian to correct for latitude, an arc-shaped dial member loosely mounted in the carrier and provided with clamping-screws extending through the slots in the carrier, whereby the dial member may be rotatively adjusted about its axis and clamped in adjusted position, to correct for longitude or equation of time, and a gnomon supported at the axis of the dial member.

825,347. ALARM-CLOCK. WILSON E. PORTER, New Haven, Conn., assignor to the New Haven Clock Co., New Haven, Conn. Filed Dec. 4, 1902. Serial No. 133,922.

The combination with the time-train of a clock-movement; of an alarm-operating train; a plurality of checking devices; a plurality of rotary mem-

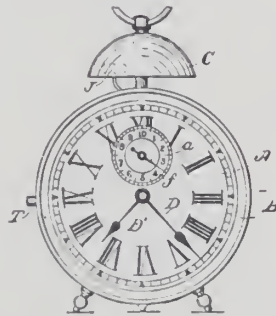

bers operated by the time-train and each actuating an alarm-checking device and one of said rotary members carrying an indicator-hand; and means for releasing one of said checking-devices independently of its corresponding actuating member.

825,391. SAFETY-HOOK. MARY C. HORTON, Woonsocket, R. I. Filed Nov. 23, 1905. Serial No. 288,723.

The improved safety-hook herein described, consisting of a single piece of tempered metal and comprising a pin-tongue and a double spring-coil,



a body portion extending substantially parallel to the pin-tongue and provided with an intermediate outwardly-projecting closed loop and also with a pin-catch, a U-shaped bend whose inner upper end is in contact with or in close proximity to said loop, and a curved terminal bend continuous with the first-named bend and having its outer end curved inwardly into proximity with said spring-coils.

825,403. PIN-TONGUE AND HINGE-JOINT. EUGENE W. MOREHOUSE, Providence, R. I., assignor to B. A. Ballou & Co., Providence, R. I. Filed March 27, 1905. Serial No. 252,360.

A pin-tongue for hrooches and similar articles pointed at one end and bent at an angle near its



other end and terminating in a circular portion the axis of which is substantially parallel with said bent portion.

825,483. SPECTACLE END PIECE. RUDOLPH RISER, Chicago. Filed March 8, 1906. Serial No. 304,887.

The herein-described blank for a temple end



piece comprising an arm, ears at the ends thereof to bear on opposite sides of the lens, a pair of

temple-ears projecting laterally from the arm at the base of one of the end ears, and a pair of ears near the temple-ears projecting laterally from the arm, to bear on the edge of the lens.

825,442. FOUNTAIN-PEN. FREDERICK W. BENDER, Hoboken, N. J. Filed Feb. 26, 1906. Serial No. 302,841.

In a fountain-pen, a reservoir, a pen-section, carried at the forward end of said reservoir, an elastic tube, shorter than said reservoir and closed

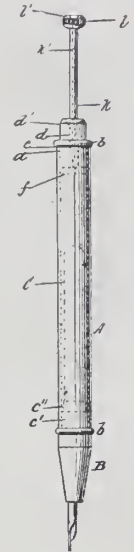

at the rear end, mounted on said pen-section, and lying within said reservoir, a piston mounted in said reservoir at the rear of said tube, an operating-rod carried by the said piston, passing through the rear end of said reservoir, and means for admitting the air between said tube and piston at any position of the piston.

825,596. COLLAR-BUTTON. WILLIAM L. FROSS, Seattle, Wash. Filed May 8, 1905. Serial No. 259,276.

In combination with a button comprising a foot carrying a shank with a head hinged to the shank, a supplemental head formed of a piece of material



of substantially the same size as said foot and centrally provided with an opening receiving said shank to enable said supplemental head to be moved to engage the hinged head and to be tilted in unison therewith, and an inwardly-movable tongue on the shank having its bottom edge spaced from said foot.

825,605. DISTANCE INSTRUMENT. WACLAW LASKA, Lemberg, Austria-Hungary. Filed Sept. 8, 1905. Serial No. 277,561.

A distance instrument comprising a telescope,

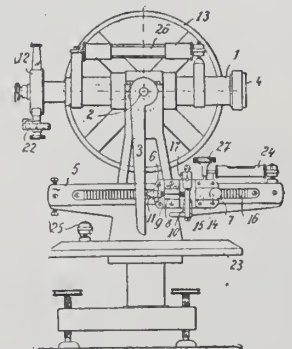

a fixed wire therein, an arm rigidly connected to the telescope-axis and standing vertical when the telescope is horizontal, a horizontal bar, a slide adjustable thereon, and a knife-edge adjustable

on the said slide and movable on it to a constant extent, the said arm resting against the said knife-edge.

**825,644. BRACELET.** JAMES A. FULLER, Providence, R. I., assignor to Hamilton & Hamilton, Jr., Providence, R. I. Filed Oct. 30, 1905. Serial No. 285,079.

A two-part hinged bracelet having means for pivotally securing the parts together, and means for holding the parts in the closed position consisting of a snap comprising a rigid member formed from a strip of sheet metal, bent U-shape and constructed to have oppositely-disposed side notches and a neck on the face of the member adjacent the bent end of the same, and a spring member formed of spring-wire bent U-shape forming spring-arms with inwardly-bent L-shaped ends, and means for securing the members of the snap in the closed position.

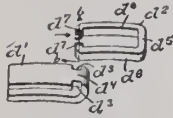

sisting of a snap comprising a rigid member formed from a strip of sheet metal, bent U-shape and constructed to have oppositely-disposed side notches and a neck on the face of the member adjacent the bent end of the same, and a spring member formed of spring-wire bent U-shape forming spring-arms with inwardly-bent L-shaped ends, and means for securing the members of the snap in the closed position.

**825,650. EYEGLASS-GUARD.** LEWIS A. HINES, Savannah, Ga. Filed April 3, 1905. Serial No. 253,509.

The combination with an eyeglass-frame, of a main guard secured to the frame and provided with a pivot-car, a self-adjusting guard also hav-

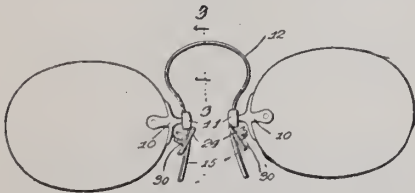

ing a pivot-car, a pivot-stud connecting said car, the length of the stud being parallel with the nose-engaging surfaces of the guards, and interengaging means on the pivot-cars for limiting independent movement of the pivoted guard.

**825,676. LOCKET.** EDGAR A. PHILLIPS, Providence, R. I., assignor to Hamilton & Hamilton, Jr., Providence, R. I. Filed Feb. 27, 1906. Serial No. 303,259.

In a locket, a concealed hinge comprising outer and central hinge-knuckles, a pintle extending through the outer and central hinge-knuckles, and

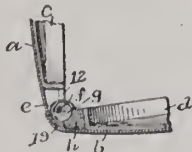

rotatable means intermediate the central hinge-knuckle and the pintle whereby the pintle is adapted to have a rotary and an eccentric motion with respect to the axis of rotation of said means in opening and closing the locket.

**825,780. EYEGLASS ATTACHMENT.** HORACE B. WOOD, New Haven, Conn. Filed Nov. 15, 1905. Serial No. 287,506.

As an article of manufacture, a covering for the

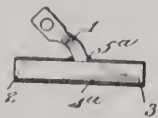

contact member of the nose piece of eyeglasses, comprising a tubular member of rubber provided with a peripheral molded opening.

**825,798. THERMOMETER.** MILLARD F. BECTON, Jersey City, N. J. Filed March 27, 1906. Serial No. 308,307.

A thermometer comprising a body of substantially triangular shape in cross-section, said body being formed adjacent the apex with a mercury-bore and in rear of said bore with a longitudinally-arranged opening, and a light reflecting scale-rod, carrying scale marks inserted in said opening,

the side of the strip next the bore being convex, and scale-finders of a contrasting color relative to

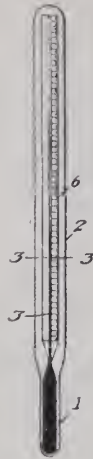

the strip disposed to define the edges of the strip when in position.

**825,833. ELECTRIC CLOCK.** ROBERT L. HIGHT, Decatur, Ill. Filed Aug. 31, 1905. Serial No. 276,593.

In an electric clock, an escapement mechanism an actuating-spring therefor, a rotary electric motor

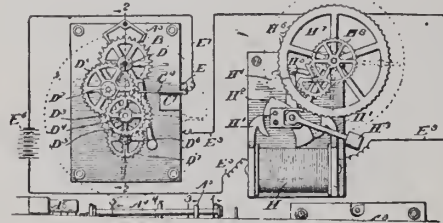

for intermittently rewinding said spring, current-controlling means for said motor carried by said escapement mechanism, and an automatic brake operatively connected to said motor and in circuit therewith and with the current-controlling means.

**825,875. CLOCK.** MARTIN WORTMANN, New York. Filed Jan. 24, 1905. Serial No. 242,512.

The combination of a winding-arbor, a spring-barrel rotatively mounted thereon, a mainspring connecting the barrel and arbor, a barrel-gear, an arbor-gear, and intermediate differential gears

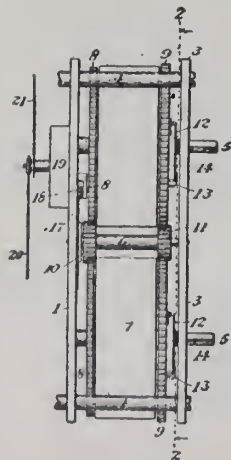

meshing with the barrel-gear and the arbor-gear, the arbor-gear being mounted concentrically with the arbor and so as to rotate concentrically relatively to the arbor and connected to the arbor to permit movement of the arbor relatively to the arbor gear during the winding operation, the bearing for the arbor-gear including a flanged sleeve upon the arbor providing a flat bearing for the arbor-gear, a ratchet clamped in fixed position relatively to the flanged sleeve and also providing a flat bearing for the arbor-gear, the two flat bearings being at opposite faces of the arbor-gear, and

a pawl secured to the arbor-gear and engaging the ratchet.

DESIGNS.

**38,126. HAT OR STICK-PIN.** GEORGE M. MEREDITH and JAQUELIN M. MEREDITH, JR., Norfolk, Va. Filed April 25, 1906. Serial No. 313,720. Term of patent 3 1/2 years.



folk, Va. Filed April 25, 1906. Serial No. 313,720. Term of patent 3 1/2 years.

BRITISH PATENTS.

(ABRIDGMENTS OF SPECIFICATIONS, 1905, FROM THE Illustrated Official Journal.)

ISSUE OF JULY 4, 1906.

**4,366. TELESCOPES, ETC.** J. AITCHISON, London. March 2.

In telescopes, binoculars, and like glasses, the ratio of aperture to focal length is increased by the use of combinations of two or more lenses of larger diameter mounted near together in place of single object-glasses. Such a combination

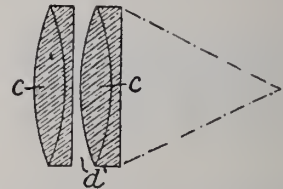

of two lenses c with an intermediate air space d is shown in the figure. It is stated that, by a proper selection and arrangement of lenses, spherical and chromatic aberrations may be more perfectly corrected. The curves, axial thicknesses, and optical constants of the component lenses of one system are given in the specification.

**4,502. DRESS PINS.** T. C. KIRTON, Leigh, Lancashire. March 4.

A retainer for hat and scarf-pins consists of a hollow casing a containing a piece b of india-

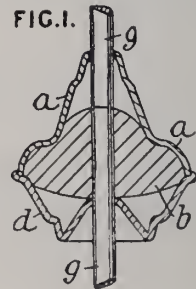

rubber pierced with a longitudinal hole through which the pin g passes. In a modification, the lower part d of the casing is dispensed with. The retainer may be secured to the head of the pin by a chain.

**4,514. WALKING-STICKS, ETC.** F. W. PARNELL, Devonport. March 4.

Flexible walking-sticks, canes, or hunting-crops are constructed with a core a of steel, cane, or other suitable material, covered with two layers



b, c, the inner of which may be of hemp, flax, cotton, etc., and the outer of plaited whipcord, twine, catgut, etc.

[Reference has been directed under Patents Act, 1902, to Specifications No. 290, A.D. 1890; No. 2183, A. D. 1895, and No. 1855, A.D. 1902.]

**4,513. CLOCKS.** F. A. CHANDLER, Leamington, and B. BONNIKEN, Coventry, both in Warwickshire. March 4.

Electric Clocks.—In secondary clocks having a rocking armature B, Fig. 4, on a center C, rotary

ratchet motion is imparted by an attached anchor E, acting on a wheel G with teeth made of the form shown. Each pin F or F' of the anchor ad-

FIG. 4.

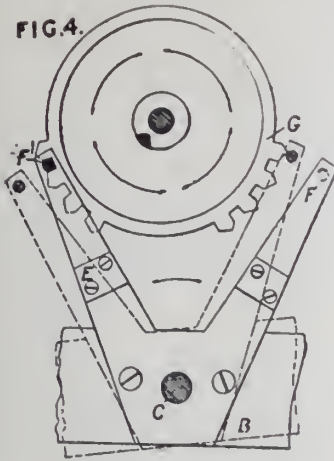
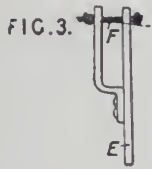

FIG. 3.



vances the wheel half a tooth and then locks it. To get silent working, catgut forks, Fig. 3, may replace the steel pins.

**4,711. CIGAR, ETC., HOLDERS.** W. M. WALKER, Goswell Road, E. C., and C. A. PETRE, Islington, both in London. March 7. No patent granted (sealing fee not paid).

A spring clip is added to a cigar or cigarette tube to enable the cigar or cigarette to be entirely consumed. The clip may be made from two strips

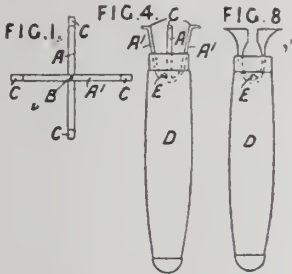

A, A', of metal riveted together at B. The clip is then bent into the required shape and inserted into the tube D as shown in Fig. 4, the ends C of the strips being turned over to prevent the clip from being pressed too far in. A pin E is let into the tube to prevent it from being withdrawn. Fig. 8 shows a modified form of clip made from a single blank.

**4,872. NECKTIE RETAINERS.** R. RIETHMULLER, Hanover, Germany. March 8.

The retainer, which is attached to the collar stud, consists of two wire arms a, b, brought to-

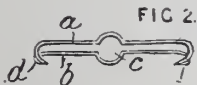

gether at their ends d into points directed towards each other. These arms are bent out so as to leave a circular space c in the center of the retainer, through which the head of the stud is introduced. The cravat is tied in the usual manner, and is held in position by the turned-up points of the retainer engaging in the material.

Complete specifications accepted June 27, 1906. 1905.

- 17,077. TIME RECORDER.** MACMASTER.
- 19,268. FIELD GLASSES.** BARTON.
- 19,487. LOCKET FASTENING.** SMITH.

**25,350. ELECTRICAL CLOCK-WINDING MECHANISM.** TRILKE.

**25,876. HAIR-PIN.** PRYCE-JONES.

Applications filed June 18 to June 23, 1906.

**13,941. FOUNTAIN-PEN.** H. L. TOOD, Finsbury Park, London.

**13,948. SPECTACLES.** R. W. E. WHITEHEAD, London.

**14,144. CUFF-HOLDER.** CHARLES WHITE, Dorking, Surrey.

**14,215. STUD.** THOMAS MORTON, Birmingham.

**14,234. TIME RECORDER.** J. F. KIELY, London. Complete specifications.

**14,356. HAIR-PIN.** ENGELBERT RATING, London. Complete specification.

**14,380. HAIR-FASTENER.** JAMES ORCHARD, Birmingham.

**14,415. TEAPOT.** C. H. HITCHEN, London.

**14,424. POCKET-KNIFE.** CARL VOM EIGEN, London. Complete specification.

**UNITED STATES PATENTS THAT HAVE EXPIRED.**

[Reported especially for THE JEWELERS' CIRCULAR-WEEKLY by R. W. Bishop, Patent Attorney, Washington, D. C.]

Issued July 16, 1889.

**406,923. METHOD OF ORNAMENTS SURFACES WITH MOLTEN METAL.** W. H. MARSHALL, Chelsea, Mass.

**406,999. METHOD OF DECORATING METAL SURFACES.** NELLIE C. DUNCOMBE, New York.

**407,015. CANE OR UMBRELLA HANDLE.** AUGUST KESSLER, New York.

**407,040. BOX FOR REPEATING-WATCHES.** HENRI SANDOZ, Locle, Switzerland, assignor to Adolphe Schwob, New York.

**407,055. POCKET-KNIFE.** WILLIAM BREDE, Hamakua, Hawaii.

**407,096. SNAP-HOOK.** C. A. MANN, Buffalo, N. Y., assignor of one-half to A. C. and Frank Knothe, New York.

**407,216. UMBRELLA-RUNNER.** GUSTAVUS JOSEPHS and E. I. O'NEILL, Philadelphia, Pa.

**407,243. WATCH.** HENRY REMPE, Houtzdale, Pa.

**407,282. SHOW-CARD.** J. W. DAVIES, Worcester, Mass.

**407,305. PROCESS OF DECORATING BASE METALS, GLASS, ETC., WITH PRECIOUS METALS.** FRANZ ROESSLER, Perth Amboy, N. J.

Designs issued July 12, 1892, for 14 years.

**21,700. SPOON.** G. L. CROWELL, JR., Arlington, N. J., assignor to Dominick & Haff, New York.

**21,705. GLASS VESSEL.** T. G. HAWKES, Cornwall, N. Y.

**21,709. BRUSH-BACK.** G. L. CROWELL, JR., Arlington, N. J., assignor to Dominick & Haff, New York.

**21,711. BOTTLE.** B. I. MOTT, Brooklyn, N. Y.

Designs issued July 18, 1899, for 7 years.

**31,221. CHAIN.** W. C. EOGIE, Newark, N. J.

**31,222. PENHOLDER.** OTTO HUBER, New York, assignor to Eagle Pencil Co., same place.

**31,224. SPOON HANDLE.** H. L. WALLACE, Wallingford, Conn., assignor to R. Wallace & Sons Mfg. Co., same place.

**The Trade-Mark Law of Australia.**

THE Australian Commonwealth trade-mark act came into force on April 27 last. The stamp duties are double those under the new English law. The trade-mark law extends to the whole Commonwealth, and any trade-mark already registered in any of the States of Australia can be extended to the whole of Australia, unless previously applied for in any other State by another party.

As (subject to extremely strong proof of superior right by another party) the first

applicant will be considered the rightful owner of the trade-mark, and in other countries firms have lost valuable trade-marks through others registering their marks first, it is desirable that all firms wishing to have their trade-marks registered in Australia should apply promptly.

**Jewelry, Clocks, Watches, Silverware and Kindred Lines Exported from New York.**

WASHINGTON, D. C., July 18.—The following were the exports of jewelry, silverware and optical goods, clocks, watches and kindred lines from the Port of New York for the week just ended:

- Amsterdam: 3 packages diamond cutting machinery, \$350.
- Barcelona: 2 packages jewelry, \$160.
- Berlin: 37 packages clocks, \$1,863.
- Bremen: 1 package optical goods, \$250; 4 packages plated ware, \$390; 2 packages watches, \$248.
- Brussels: 1 package optical goods, \$555.
- Calcutta: 6 packages plated ware, \$672; 26 packages clocks, \$561; 21 packages clocks, \$259; 3 packages watches, \$3,360; 24 packages clocks, \$372; 7 packages plated ware, \$1,177.
- Ceara: 4 packages watches, \$1,858; 5 packages jewelry, \$1,154; 26 packages clocks, \$522.
- Christiania: 8 packages clocks, \$362.
- Glasgow: 55 packages clocks, \$481.
- Gothenberg: 5 packages clocks, \$148.
- Hamburg: 1 package optical goods, \$160; 1 package watches, \$2,740; 3 packages clocks, \$125; 1 package jewelry, \$120; 10 packages jewelers' supplies, \$3,500.
- Havana: 4 packages plated ware, \$113; 11 packages clocks, \$128.
- Havre: 10 packages clocks, \$550; 1 package jewelry, \$500; 1 package optical goods, \$352; 1 package stereoscopic views, \$200.
- Kingston: 2 packages watches, \$113.
- Liverpool: 2 packages silverware, \$280; 1 barrel sweepings, \$175; 227 packages clocks, \$3,100; 4 packages jewelry, \$1,272; 3 packages silverware, \$1,918; 1 package plated ware, \$125.
- London: 2 packages silverware, \$100; 112 packages clocks, \$906; 12 packages scopes and views, \$606; 4 packages plated ware, \$304; 1 package optical goods, \$350; 3 packages clocks, \$132; 28 packages and views, \$1,274; 2 packages silversmiths' sundries, \$390; 21 packages watches, \$2,942; 2 packages plated ware, \$490; 6 packages scopes and views, \$233; 1 package ivory, \$250; 51 packages clocks, \$1,905; 1 package plated ware, \$111; 8 packages optical goods, \$2,082; 20 packages watches, \$3,091; 4 packages scopes and views, \$988; 2 packages silverware, \$100; 4 packages scopes and views, \$988; 2 packages silverware, \$100; 4 packages scopes and views, \$250; 20 packages watches, \$3,195; 3 packages silverware, \$2,000; 125 packages clocks, \$3,654; 7 packages optical goods, \$462.
- Oporto: 42 packages clocks, \$481.
- Port Alegre: 16 packages clocks, \$226.
- Port of Spain: 1 package jewelry, \$103.
- Rio de Janeiro: 1 package watches, \$194; 65 packages clocks, \$1,615; 3 packages jewelry, \$434.
- Southampton: 2 packages watches, \$1,280.
- St. Johns: 7 packages clocks, \$204.
- Stockholm: 1 package jewelry, \$350.
- St. Michaels: 21 packages clocks, \$280.
- Sydney: 36 packages clocks, \$345.
- Vera Cruz: 12 packages plated ware, \$1,598; 41 packages clocks, \$502.

Ten watches were stolen recently from the store of Abraham Pollock, 630 Broadway, Paducah, Ky. The owner of the establishment was in St. Louis on business at the time of the theft.

Albert M. Greer's store in Iowa City, Ia., was recently robbed of several hundred dollars' worth of jewelry. Entrance was gained by removing a pane of glass from a window. The safe containing several thousand dollars' worth of diamonds was not opened, although the combination was battered so that the owner could not get it open and had to call in an expert.

# Mainspring Don'ts

## Simple Hints for Those Who Handle Mainsprings

---

Don't fail to provide yourself with the best mainspring winder that can be obtained. See that the hooks on all arbors of the winders are no longer than the thickness of the thinnest spring, and thus avoid kinking, and therefore unnecessary breaking of mainsprings.

Don't use a mainspring that is too long, because it fills the barrel and prevents that part, or the mainwheel, from making the required number of revolutions, with the consequence that the watch will not run as it should after each winding.

Don't use a mainspring that is too strong, because it will set, increase the percentage of breakage and injure the watch.

Don't use a mainspring that is too wide, and be sure that the tip and brace do not extend beyond the limits of the cover and barrel.

Don't forget that a mainspring should not occupy more than one-third the diameter of the barrel, thus leaving two-thirds to be divided between the arbor and winding space, to enable the watch to run about thirty-six hours.

Don't expect a mainspring to be flat if you put it in the barrel with the fingers. This method usually injures the spring, gives it a cylindrical form, and thereby increases the friction in the barrel.

Don't bend the inner or outer end of the mainspring with flat-nosed pliers, but provide yourself with specially made round-nosed pliers which will give a circular form to these parts, prevent short bends, contract the inner coil, and thus secure a closer fit to the barrel arbor without injuring the spring.

Don't expect other than a properly fitted flat mainspring with rounded edges to produce the least friction in the barrel, allow the greatest amount of power to the train, and give the best results as to time, service, etc.

Don't expect a mainspring to always endure extreme changes in temperature, or electrical disturbances, or straightening at full length, or neglect from lack of cleaning and oiling.

Don't expect a watch that needs cleaning or other repairs to run satisfactorily by merely putting in a new mainspring.

Don't expect a mainspring to plough through too much dirt.

---

## Waltham Watch Company

Waltham, Mass.

# THE HOROLOGICAL REVIEW.

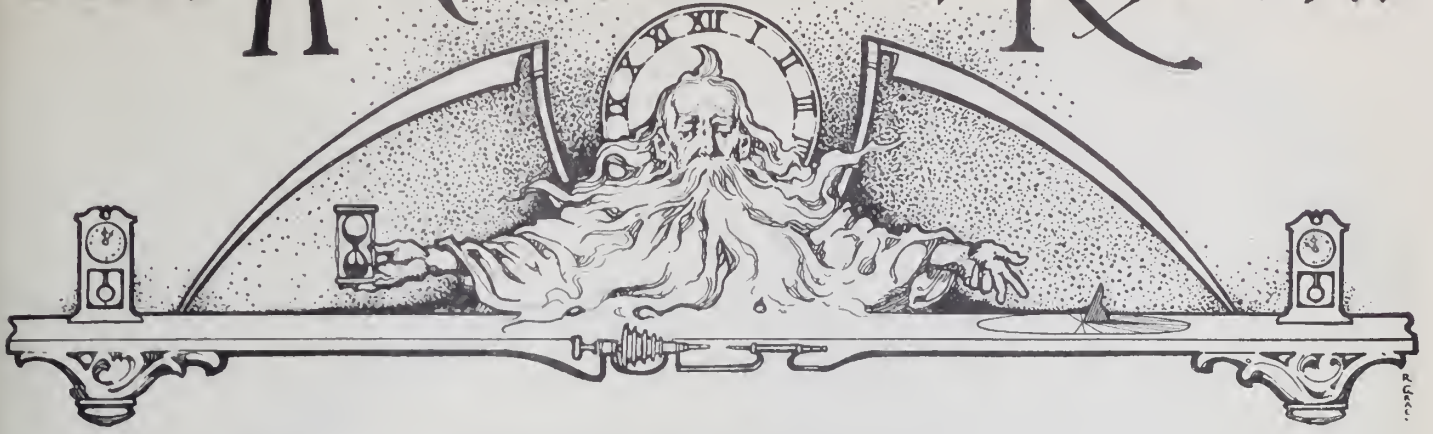

## POINTS *on the* LEVER ESCAPEMENT.

Address of C. T. HIGGINBOTHAM, Supt. of the South Bend Watch Co., before the Convention of the Retail Jewelers' Association of Illinois.

WHEN, 400 years ago, Peter Henlem, of Nuremberg, essayed to manufacture watches, the best available device he could find for regulating the motion of the train wheels was a verge escapement carrying a steel balance, to which was attached a piece of catgut, or its motion controlled by a projecting bristle against which one of the arms struck. This crude contrivance was little better than a mechanical toy, compara-

would have been impossible for him to have secured the results recorded had it not been that he introduced a remontoire attachment to the train, which wound the third or fourth wheel at short intervals.

The possibilities of accurate timepieces for use at sea turned the attention of horologists to the subject of escapements, and many inventions followed each other in rapid succession, many of which have gone entirely out of use. The principal escapements were the cylinder, the duplex, the dentent or chronometer and the lever; of these the detached lever has stood the test and proved itself best adapted to a pocket timepiece. It is this form of escapement to which I desire your attention.

The lever escapement has undergone many changes since its first introduction by Mudge in 1763. In these changes certain fixed principles have been established: (1) The number of the escape-wheel teeth has been fixed at 15; (2) the extent of the span of the pallets at  $3\frac{1}{2}$  teeth; (3) exposed pallets have been almost universally adopted; (4) the lift of the pallets or oscillation of the fork has been fixed approximately at 10 degrees of a circle. The old controversy as to the respective merits of the long and the short fork may be considered virtually settled, the roller impulse having been determined at approximately 30 degrees. This is to say, the distance from the center of the balance staff to the face of the roller or impulse pin is about one-third the distance from the center of the balance staff to the center of the pallet arbor.

There are, however, still a few points in dispute. I shall endeavor in a fair and impartial manner to present the arguments for and against these disputed points, allowing you to judge of their respective merits.

I would first call your attention to the question of equi-distance lockings as compared with equi-distance centers. In the former the locking faces of the pallet stones are equally distant from the center of oscillation, which in this case is the center of the pallet arbor; the advantage claimed is that an equal draft is thus secured. To

secure an equal impulse it is necessary to form the impulse faces of the pallet stones at widely different angles, the discharging stone forming the most obtuse angle with respect to the locking face. The disadvantage of this form is that there is a somewhat greater loss of power from side shake owing to the conditions produced by the impulse of the receiving stone, commencing, as it does, at the same distance from the center that the discharge does, but, unlike it, approaching the center in receiving its impulse. This loss is in proportion to the diminished distance of the impulse face of the receiving stone, as compared with the discharging stone. In the equi-distance center's escapement the center of the impulse faces are equally distant from the center of

FIG. 1.



FIG. 2.

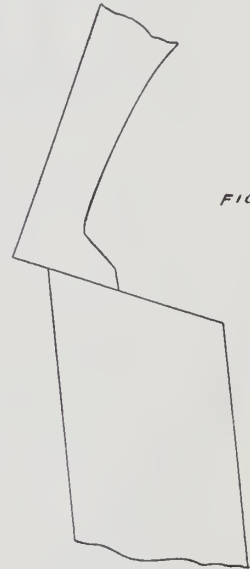

tively useless as a timepiece. It carried but a single indicator, an hour hand (the minute hand would have been a useless superfluity). It was not until 25 years later, and the fusee was invented, that the minute hand was added. About 150 years after the fusee had been applied the hairspring was invented, and it was now discovered that the verge escapement was too sensitive to the slightest variation in power to be satisfactory as a governing device. Still, up to the middle of the 18th century, nothing better had been devised; in fact, the celebrated chronometer with which John Harrison took the English prize of £20,000 had an improved form of verge escapement, and it

oscillation. This secures the advantage of an equal loss of power from side shake. To overcome the disadvantage of unequal draft, the stones are set at different angles in the pallet. Either of these forms is capable of excellent results.

Another point of dispute is as to the best form of impulse faces, both for the pallets and for the escape teeth. One method is to make the pallet stone impulse face a perfectly flat plane, and to curve the impulse face of the escape teeth transversely with the face of the wheel. Another method is to curve the impulse face of the pallet stone transversely with the face of the pallet and fork, and to make the impulse face of the

Where  
Time is Money



Every-  
where

that accurate time is valued the Elgin Watch is needed. Every man who requires exact time in the execution of his business is a prospective customer for the dealer who carries

# ELGIN WATCHES

Every Elgin Watch is fully guaranteed against original defect, insuring satisfaction to both buyer and seller.

See Jobber's list for prices, or write the Company.

Every dealer is invited to send for the Elgin Art Booklet, "Timemakers and Timekeepers," illustrating the history and development of the watch.

## ELGIN NATIONAL WATCH CO.

Factories, ELGIN, Illinois, U. S. A.  
General Offices, 131 Wabash Ave., Chicago.

NEW YORK OFFICE,  
11 John St.

SAN FRANCISCO OFFICE,  
206 Kearny St.

Where  
Time is Life





escape wheel tooth a flat plane. Still another method is to make the impulse face of the escape wheel curved longitudinally with the face of the wheel, the impulse face of the stone being curved transversely. The object of all these forms is to present as small a contact of surfaces as possible—not, as may be supposed, to lessen friction, as friction has nothing to do with the extent of surfaces, but to lessen cohesion caused by oil between the surfaces.

Still another disputed point is the table roller as compared with the double roller, and here let me say that the double roller is by no means a new device. We are all aware that it was in use more or less 50 years ago, but it is not generally understood that the earliest lever escapements were of this type. In considering the merits of the two devices, it must be remembered that the guard pin and roller action is entirely one of safety. It is a misuse of this action to employ it for the correction of other errors that may exist in the escapement.

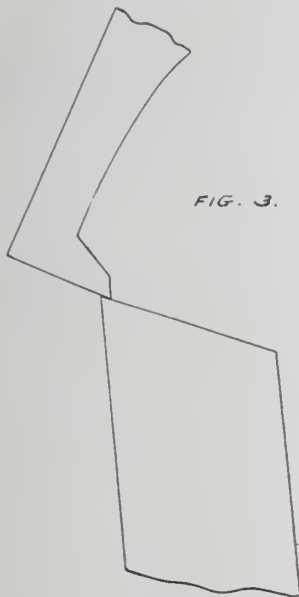

the terms are not synonymous. A watch that overbanks is one where the extent of vibration of the balance is so great that the roller pin passes entirely around and strikes the outside edge of the fork, thus causing acceleration of time. When the guard pin passes the edge of the roller so that the fork slot will not be in position to receive the roller pin, it is said to be out of action.

The claim for the double roller escapement is additional safety against going out of action. This is secured by a deeper penetration of the guard piece into the path made by the outside of the roller, and as a consequence less wedging action when the guard piece impinges against the edge of the safety roller. Its disadvantages are that it becomes necessary to make the fork somewhat heavier to form this guard piece. This, by increasing the weight of the fork, increases the loss by impact. It must be borne in mind that the fork comes to a rest immediately on delivering its impulse to the balance, and remains in this condition until released by the roller pin on its return. The inertia of the fork is overcome by the balance striking it while at its greatest speed.

The difference between imparting motion to a piece by applying gradually increasing power or by sudden impact will be readily understood if you will imagine attempting to move a train of cars by bringing a locomotive at full speed against its rear end. This on a small scale is what a balance has to accomplish in imparting sufficient motion to the fork to provide the unlocking of the escapement. Another disadvantage in the double roller is that for an extent of 15 to 20 degrees at each side of the impulse the safety action does not take place between the edge of the roller and the point of the guard piece, but, instead, between the jewel pin and fork horns.

The advantages claimed for a table roller is that the safety action under all circumstances takes place between the guard pin and the roller edge. The horns of the fork may be entirely dispensed with without impairing its efficiency; also the fork may be made lighter than in the other form. The disadvantage is that the guard pin penetrating a less distance into the path of the roller edge will, when thrown against it, impinge with a more wedging action, and for this reason it requires more careful adjustment.

A correctly designed and properly adjusted escapement will produce just as accurate results as to time without as with this safety action. In ordinary use, if the escapement is so designed and adjusted, the guard pin or guard piece will not touch the roller twice in the course of a year except when the train is reversed by setting the second hand backward.

I have here a watch without any safety device. The guard pin has been removed. This watch was not especially prepared in any other particular for the test to which it was subjected. It was merely selected from stock, and the guard pin broken off. It has been carried for a long period in the pocket in ordinary use, on street cars, bicycles, horseback and railway trains. It has just completed a journey of 2,500 miles, one night having been spent by its wearer in an upper berth immediately over the trucks of a sleeping car. During this time it has never gone out of action, even though it has dropped to the full length of the chain by which it was attached to the wearer's vest three or four times. I have used the term "out of action" instead of overbanked, as is sometimes done, for the reason that

I will now ask your attention to simple instructions for the adjustment of a detached lever escapement. We will assume that the escapement being treated has been originally correctly designed, and has simply become deranged by accident or otherwise. First try the action of the escape-wheel tooth as it passes over the impulse face of the pallet stone. When it slides from the locking face both impulse faces should form a slight angle of the divergence, the locking corner only of the escape wheel being in contact with the pallet stone (Fig. 1). As it passes along the impulse face this angle should gradually decrease until the faces are practically parallel (Fig. 2), and, before leaving, the other corner only of the escape-wheel tooth should be in contact with the pallets (Fig. 3). As to the locking, there should always be an angle of divergence between the locking face of the escape-wheel tooth and that of the pal-

let stone, the locking corner only of the escape-wheel tooth being in contact with the locking face of the stone (Fig. 4). Drawing out the receiving stone increases the angle of impulse and draft. Drawing out the discharging stone decreases the angle of impulse and draft, and *vice versa*. This point should be steadily and carefully borne in mind.

Having secured the proper action of impulse, see that the locking is just sufficient for safety, the usual amount being three-quarters of one degree of a circle; also, that as the escape-wheel tooth is released from one pallet stone and another tooth drops to the other stone, that the drops on the receiving and the discharging are equal. This will be the case if the escapement has originally been perfect; if not, a slight alteration can be made by pressing one or the other stone toward the inside or outside in its slot, care being exercised that the amount of movement shall not be sufficient to derange the impulse or draft action. Now close the banking so that the instant the escape wheel drops the slide of the fork

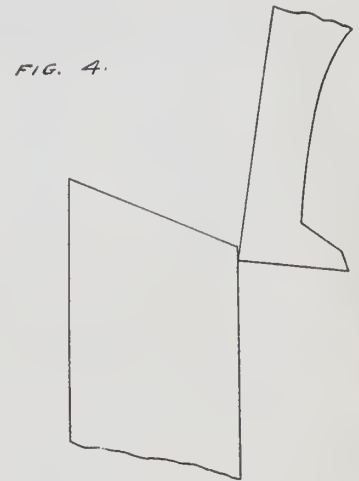

shall strike the banking pin; now try the draft by lifting the fork slightly from each banking to see that it returns promptly.

Having thus secured the proper adjustment of the escape wheel and pallet action, we will proceed to the fork and roller action. First see that the guard pin is perfectly central with the fork slot, and upright. Now, by moving the banking screws adjust the fork so that when it strikes each pin there shall be just sufficient freedom to allow the edge of the roller to pass the guard pin. If it is found that in this condition the escape wheel will escape from one pallet stone and not from the other, swing the pallets on the pallet arbor, changing their position with the fork so that it will escape on both sides. Should it be found that it escapes on neither side, move the guard pin slightly forward and open the bankings. If it is found that after the escape-wheel tooth has dropped on the locking face it still slides up a distance on that face, move the guard pin backward and close the banking. You will now have what is known in watch factory parlance as "a watch banked to drop."

It will be necessary finally to determine whether the roller pin is at the correct distance from the center of the roller. To determine this, move the balance slowly



Is Your  
 "Middle Case"  
 Empty?



In watches, Mr. Jeweler, there are three classes necessary to serve all customers—to make up a complete stock. The high-priced watch, the *medium-priced* watch and the low-priced watch. The *medium-priced* watch is the *one important* class from the *profit standpoint*. That is why the

# New England

THE WATCH FOR THE GREAT AMERICAN PEOPLE

fills the most important place in the jeweler's stock. It is built for the great mass of buyers of medium-priced goods. It is the highest grade, medium-priced watch made.

With both Ladies and Men New England Watches are sellers, but far more, they are without competition; they have the medium-priced field all to themselves; they are indispensable to *your* "middle case," Mr. Jeweler.

And there's another point of vital interest. We are talking New England Watches to the public, and are going to talk them convincingly again this Fall *through extensive advertising*. We are widening their already wide and exclusive field and making them more necessary to you. Frankly, the results are showing in doubled sales. But they will do better.

Remember, the jeweler handling the New England line will get the trade this Fall and this Christmas and ever afterwards. Advertising is going to do it.

If *your* medium-priced case is empty; if *you* don't handle the New England Watch, this is a mighty favorable time to take the matter up with us. Write us for details of our carefully worked out plans for bringing you business. Let us help you.

Address,

DEPARTMENT OF PUBLICITY

**NEW ENGLAND WATCH CO., Waterbury, Conn.**

until an escape-wheel tooth drops on the locking face, then move it slightly backward but not quite sufficient to unlock. Holding the balance in this position, grasp the fork with the tweezers and try the shake. If the roller pin is fairly embraced by both sides of the fork slot, this shake will be found normal. If it is not, it will be found excessive. In this case move the roller pin slightly forward until the desired result is secured. If it is found that the roller pin will not pass out of the slot of the fork, move the pin slightly backward. By no means attempt to remedy this defect by opening the banking. Finally open the bankings just sufficient to give about the same amount of slide on the locking faces of the stones that there is lock, and the escapement will be perfectly adjusted.

**The Preservation of Drills.**

WHEN a drill catches, the defect is generally attributed to all possible causes except the right one, which often is to be found in the defective construction of the tool, says a writer in the Almanach de l'Horlogerie et de la Bijouterie. A few remarks may not be useless if put in practice, for there are numerous artisans who need instruction.

When the extremity of a piece of round steel is forged, the form represented in Fig. 1 is obtained. It may at once be perceived that the diameter, according to the line *a b* is greater than the distance between the points *c d*, situated at the angle of the

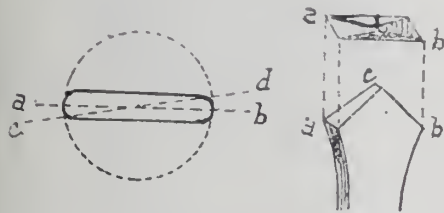

Fig. 1

Fig. 2.

plane and round surfaces. For a drill worked by the bow, that is, designed to cut in both directions, it is quite advantageous that the edge should be taken on the greatest width of the piece of flat steel; that is, according to the line *a b*. If, on the contrary a drill is desired which shall turn in a single direction only, that is, designed to be worked by the wheel, it is necessary to commence by filing the round portion on each side, so that it shall not exceed the angles which are to be cut. It is in the neglect of these rules that sins are often committed.

For the second class of drills it is necessary to file according to Fig. 2, so that the edges *a b*, which are to serve for cutting, shall project. A tool thus prepared will respond to what is required of it, while if this detail is neglected it will catch, scarcely engaging in the hole, and if it is forced it will not move until broken. A drill of this kind may also be employed with the bow, provided the cutting edges are in good condition, as seen in Fig. 2. It is evident that such a drill, actuated by the bow, does not cut during its movement backward, but on the contrary removes the

shavings with less tendency to become blunt.

More advance will, therefore, be made than with the drill which works in both directions—which shaves, rather than cuts, the substance. The latter ought to have a point at its extremity, while the other, the one designed to cut in a single direction, has a small edge, as seen at *c*, in Fig. 2.

Besides, it often happens that the thickness of the edge of the drill is not proportioned to its length. Drills are often employed of about two and a half millimetres, which are only five, four, or even three-tenths of a millimetre in thickness. This thickness does not permit of obtaining a good result. The edge yields and does not cut well; or, what is more serious, it breaks and the particles detached are so fine that they are easily pressed into the substance. Every one has had experience of the difficulty and of the loss of time in extracting these small fragments.

The exact proportion for small drills should be one to three, and for large drills one to three and a half. A drill measuring 0.6 millimetre will, therefore, be 0.2 millimetre in thickness. Another designed to perforate a hole of 3.5 mm. should be 1 mm. in thickness. By observing these data tools may be secured with which work can be done rapidly, provided that the tempering and annealing have been properly conducted. Such drills will rarely break and will not be subject to become dulled quickly.

**Horological Notes.**

The clock at the entrance to Lord Ellesmere's estate at Worsley strikes 13 at 1 o'clock. The peculiarity is due to the last Duke of Bridgewater. Noticing many of his workmen loitering around after the noon hour one day, he made inquiries and was told they had not heard the clock strike one. So he had it fixed so that it would strike 13.

A watch that is attracting much attention whenever shown has recently been added to the New England Watch Co. It is called the "Skeleton" and has the dial and plates so removed that the entire movement is visible, crystals being used both in the front and back of the case. It is thus possible to look right through the watch and see the "wheels go round." The "Skeleton" is well made and is proving itself very valuable for a window display. It will probably be pictured in all the leading magazines this Fall as a feature of the national advertising campaign the New England Watch Co. is now planning. This advertising is interesting as showing what can be accomplished by judicious publicity. It is estimated that fully one-third of the people in the entire United States will be reached by it during the Fall and Christmas seasons.

William Taylor Peters, of Eureka, Kans., was married the other day in Fall River, Kans., to Miss Leo Blackman. They are now at home to their friends in Eureka.

Katherine and Cornelia S. Ludwig have succeeded to the jewelry business belonging to the Ludwig estate, Lexington, Mo., and are operating as the Ludwig Jewelry Store.

**MOST COMPACT**  
 AND THINNEST  
 DUST-PROOF  
**OPEN FACE**  
**GOLD CASE**  
 MADE IN THE WORLD  
 FOR  
 AMERICAN MOVEMENTS.

Made in all shapes, engine turned, engraved or plain.

Colby Patent, April 24, 1894.

**DUBOIS WATCH**  
**CASE CO.**  
 21 Maiden Lane, New York.

MAKERS OF  
**Tower and Street Clocks**

For particulars write us, mentioning The Jewelers' Circular-Weekly.  
**E. HOWARD CLOCK CO.,**  
 EST. 1842. BOSTON, MASS., U. S. A.

**Learn Watchmaking**

Refined, profitable labor. Competent men always in demand. We teach it thoroughly in as many months as it formerly took years. Does away with tedious apprenticeship. Money earned while studying. Positions secured. Easy terms. Send for catalogue. Address

**St. Louis Watchmaking School, St. Louis, Mo.**

# SETH THOMAS CLOCK COMPANY.

Established 1813.

THE MADELEINE.



Wood Case, Adamantine Finish, Metal Columns, Gold Plated Caps and Bases. Superior 8-day Movement, Porcelain Dial, French Sash with Beveled Glass.

List Price, \$10.50; Height, 12 inches.

70 Wabash Avenue, Chicago. **Seth Thomas Clock Co.,** 51 Maiden Lane, New York.

## Greatest Traveling and Desk Watch

Exact Size.



Runs eight days with one winding. Anchor movement and fine timepiece. Back flies open and stands firm. Can be closed and put in pocket. Come cased in Gun Metal—Artistic German Silver and Damaskeened.

ALSO NOVELTIES IN WATCH BRACELETS in SILVER, GOLD FILLED and SOLID GOLD

Write us for information if interested in the new season's offerings.

**KLIPPER BROS.**

59 Maiden Lane - NEW YORK

A Complete Line of the Celebrated

# NARDIN WATCHES

Thin Minute Repeaters, Split Seconds, Movements fitting American Cases, Ship Chronometers and Torpedo Boat Watches can be secured through

**R. NEWBURGH**

Sole Agent

12-16 John Street

NEW YORK

Manufacturer of the Current Grade Colbert Watch

# Trenton Watches are Unequaled

For Beauty of Design, Perfection of Finish and Reliability Combined with Moderate Price



No. 100. Bridge Model, O Size, 7 Jewel, Hunting and Open-Face, Pendant Setting.

JOBBERS SELL TRENTONS

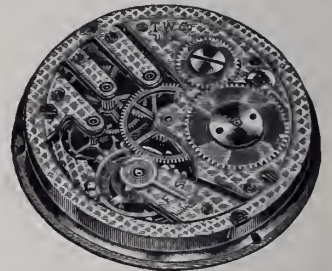

No. 320. Bridge Model, 1 1/2 Size, 7 Jewel, Hunting and Open-Face, Pendant Setting.

PRICE LIST on APPLICATION



No. 140. Bridge model, 16 Size, 15 Jewel, Hunting and Open-Face, Pendant Setting.

A SAMPLE LINE is convincing. They are Pendant Setting in all Sizes, fitting Regular Pendant Setting Cases, Decorated Dials, and Louis XV Hands.

A Neat Sign or Advertising Booklet for the Asking

Manufactured and Guaranteed by the

**TRENTON WATCH CO.**

Trenton, N. J.

**Guinand's Reliable Split Timers and Split Chronograph Watches.**

**in Nickel, Gun Metal, Silver and Gold Filled Cases.**

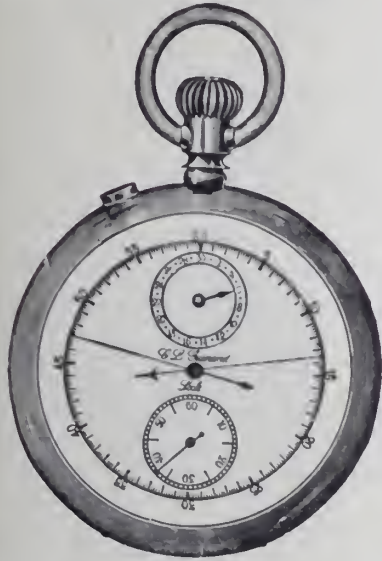

**JULES RACINE & CO.,**  
EXCLUSIVE IMPORTERS.

Chicago Office, New York Office,  
103 State Street. 37 Maiden Lane.

For Sale By All Jobbers.

**WATCH REPAIRS**

FOR THE TRADE ONLY  
**WE BEAT THEM ALL!**  
in Prices and Quick Service

**MAEBERT & REISS**  
71 and 73 Nassau Street - NEW YORK

**"Perfect Yourself"**

in ENGRAVING and EXPERT WATCH WORK.  
Take a Post-Graduate Course.  
**RIES & ARMSTRONG, Macon, Ga.**

"PRACTICAL COURSE IN ADJUSTING."  
Price, \$2.50.

All Jobbers or Jewelers' Circular Publishing Co

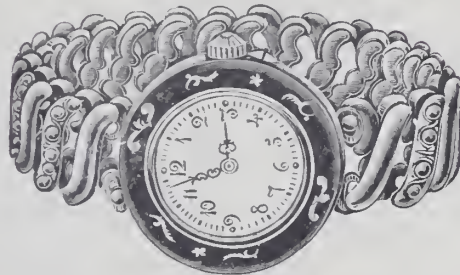
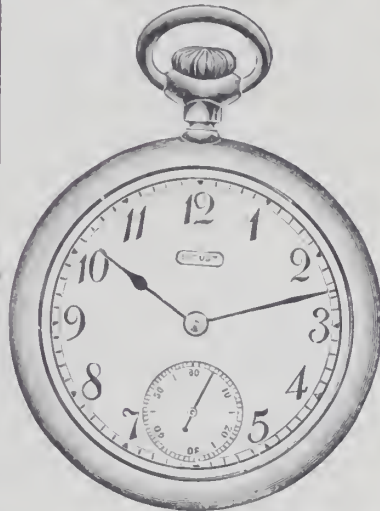
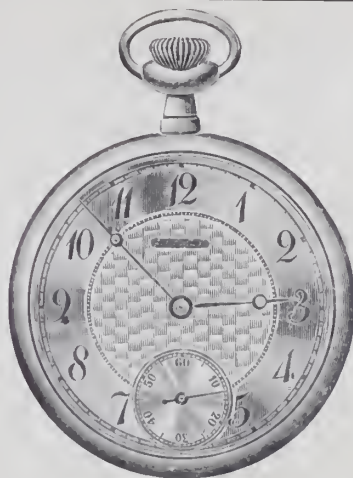

**THREE WINNERS**

*The Lancet*

15 and 17 jewel, adjusted, cased in 25-year Gold Filled hinge. The best and most attractive watch on the market.



*The Locust*

7 jewel, lever. Cased in 20-year Gold Filled. Screw back and bezel.



*The Carmen Watch Bracelet*

Needs no comment.

ASK YOUR JOBBER FOR THEM OR WRITE DIRECT TO

**HIPP. DIDISHEIM & BRO., 49 Maiden Lane, NEW YORK**

CHICAGO OFFICE, Columbus Building

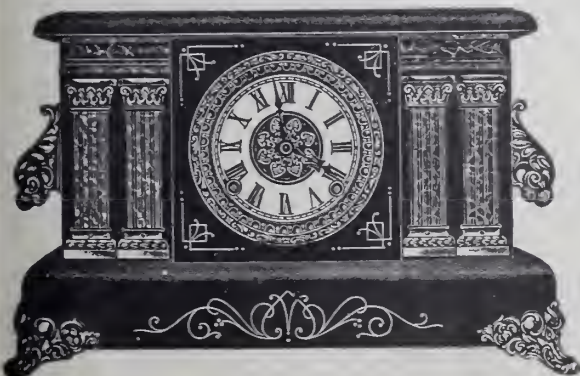

**Sessions Clocks**

Superior finish. Reasonable prices.

Have you seen our  
**New and Exclusive Designs**  
in Mantel and Hanging Clocks?

Write for Catalog and supplement.

**The Sessions Clock Co.**

Main Office and Factories,  
**Forestville, Connecticut, U. S. A.**

New York Salesrooms,  
**37 Maiden Lane**



## Be Sure To Ship Us L's Make

**L** **G** **O** **O** **D** **S** Ever since we are in a position to supply Watches and Movements FROM THE **LANGENDORF WATCH CO.**



We read in our daily mail that the customers ask us specially to ship them L's Make only.

**W** **H** **A** **T** advantage is there in L's Make prompting our customers to add above request to their orders?

**C** **A** **N** **I** **T** **B** **E** **P** **O** **S** **S** **I** **B** **L** **E** that so large a number of them have already noticed increased profits and great satisfaction when handling this new line?

This week it is the "NAMTOC" Watch. Ask for a sample. It is just what your customers want, a thin model Gent's Gilt Metal open face Watch. Remember it is L's MAKE.

SOLE AGENTS FOR UNITED STATES,  
**BYRON L. STRASBURGER & CO.,**  
17 Maiden Lane, New York, N. Y.

## 46 out of 99 PRIZES

were awarded to

## PATEK, PHILIPPE & CO.

In the Timing Contest of the Astronomical Observatory in Geneva, for the year 1905, comprising: The only First Unique Prize for Best Average Running; 2 First Prizes out of 3; 5 Second Prizes out of 10; 8 Third Prizes out of 18; 9 Fourth Prizes out of 24; 10 Honorable Mentions out of 23; 11 Simple Mentions out of 21. 11 Manufacturers participated.

68 NASSAU ST., NEW YORK.

GENEVA, SWITZERLAND.

## AUDEMARS, PIGUET & CO.,

BRASSUS and GENEVA.

Manufacturers of Superior

## Plain and Complicated Watches.

Represented by

### A. WITTAUER CO.,

9-11-13 Maiden Lane,

NEW YORK.

## JULES JÜRGENSEN

Watches and Chronometers

PARIS—"THE GRAND PRIX" 1900

SOLE

RUDOLPH & SNEDEKER,  
65 Nassau St., New York

AGENTS

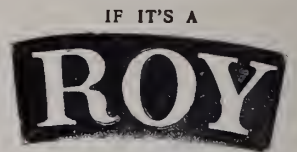

TRADE MARK  
IT'S STANDARD



O Size Bassine Engraved Cases, made from assayed Gold, quality as stamped.

## ROY WATCH CASE COMPANY,

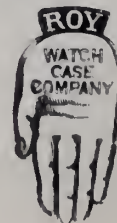

21-23 Maiden Lane,  
NEW YORK.

SAN FRANCISCO.  
LONDON, ENG.

## THE COMMERCIAL MEANING OF "SERVICE"

**T**HE WORD "Service" is being used very widely in business. It means more than the mere exchanging of goods for money; it applies to certain convenient methods of conducting business, which add to the customer's satisfaction without necessarily increasing the cost to him. Good products plus good service mean the highest efficiency. As applied to watches, such efficiency is here afforded.

CHICAGO  
103 STATE ST.

**J. W. FORSINGER,**  
LEADING AMERICAN WATCHES AND MOVEMENTS

NEW YORK  
2 MAIDEN LANE



# ZENITH

## MOVEMENTS

Give the

**RIGHT TIME  
EVERY TIME  
For a LIFE TIME**

**Grand Prize, Paris Exposition, 1900**

Made in O size, 12 size, 16 size, all grades  
Hunting or Open Face, Pendant Set

**INTRODUCED FOR THE FIRST TIME IN AMERICA, THOUGH ONE OF  
THE BEST KNOWN WATCHES IN EUROPE FOR GENERATIONS**

Manufactured by

**GEORGES FAVRE-JACOT & CO., Locle, Switzerland**

HIPP. DIDISHEIM & BRO., Sole Agents, { 49 MAIDEN LANE, NEW YORK.  
COLUMBUS BUILDING, CHICAGO.

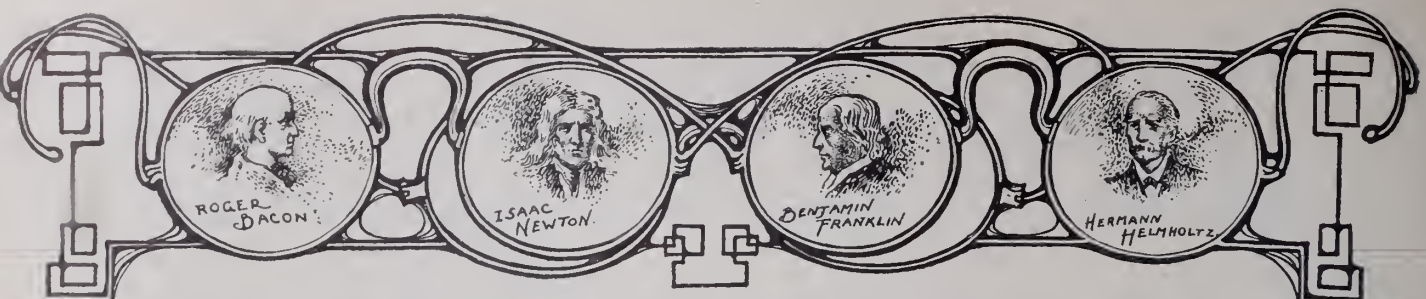

# OPTICAL DEPARTMENT

## The Optometrist's Catechism.

A SERIES OF QUESTIONS AND ANSWERS ON ELEMENTARY OPTICS, IN CATECHETICAL FORM.

By E. Lo Roy Ryer.

Copyright, 1903, by THE JEWELERS' CIRCULAR PUBLISHING Co.  
(Continued from issue of July 11.)

(Answer to Question 656 Continued.)

### THE NEW OR DIOPTRIC SYSTEM.

As recognized authorities give different values it has been deemed advisable at this point to collect the leading tables so that a comparison and choice may be made. Thus the following tables, by Jackson and Chas. F. Prentice, respectively, will be seen to differ from the foregoing by Landolt and from each other:

JACKSON TABLE.			
Number by dioptries.	Focal distance in millimeters.	Focal distance in inches.	Numbers in old series.
0.12 (0.125)	8,000	315.0	...
0.25	1,000	157.5	114
0.37	2,667	105.0	100
0.50	2,000	78.7	72
0.62	1,600	63.0	60
0.75	1,333	52.5	48
0.87	1,143	45.0	...
1.00	1,000	39.37079	10
1.12	889	35.0	36
1.25	800	31.5	30
1.37	727	28.6	...
1.50	667	26.2	21
1.75	571	22.5	...
2.00	500	19.7	20
2.25	444	17.5	18
2.50	400	15.7	16
2.75	361	14.3	11
3.00	333	13.1	...
3.25	308	12.1	12
3.50	286	11.2	11
4.00	250	9.8	10
4.50	222	8.7	9
5.00	200	7.9	8
5.50	182	7.2	7
6.00	167	6.5	6
7.00	143	5.6	5½
8.00	125	1.9	5
9.00	111	1.4	4½
10.00	100	3.9	4
11.00	91	3.6	3½
12.00	83	3.3	...
13.00	77	3.0	3
14.00	71	2.8	2¾
15.00	67	2.6	2½
16.00	62	2.4	...
17.00	59	2.3	2¼
18.00	55	2.2	...
19.00	52	2.1	...
20.00	50	2.0	2

PRENTICE TABLE			
Focal distances, centimeters.	Metric system, dioptries.	Inch system, approximates.	Focal distances, U. S., standard inches.
100.0	0.25	160	157.12
200.0	0.50	80	78.34
133.3	0.75	53	52.12
100.0	1.00	40	39.38
60.0	1.25	32	31.12
66.7	1.50	26	26.11

57.1	1.75	22	22 1-2
59.0	2.00	20	19 11-16
44.4	2.25	18	17 1-2
40.0	2.50	16	15 3-4
36.4	2.75	14	14 5-16
33.3	3.00	13	13 1-8
30.8	3.25	12	12 1-8
28.6	3.50	11	11 1-4
25.0	4.00	10	9 7-8
22.2	4.50	9	8 3-4
20.0	5.00	8	7 7-8
18.2	5.50	7	7 1-8
16.7	6.00	6½	6 9-16
15.4	6.50	6	6
14.3	7.00	5½	5 5-8
12.5	8.00	5	4 15-16
11.1	9.00	4½	4 3-8
10.0	10.00	4	3 15-16
9.1	11.00	3½	3 9-16
8.3	12.00	3¼	3 9-32
7.7	13.00	3	3 1-32
7.1	14.00	2¾	2 13-16
6.7	15.00	...	2 5-8
6.3	16.00	2½	2 7-16
5.5	18.00	2¼	2 3-16
5.0	20.00	2	1 31-32
2.5	40.00	1	63-64

A careful study of the above tables will enable the reader to see that while the dioptric values always agree, the inch values and "old system" numbers vary considerably, making one more point in favor of the dioptric system. Furthermore, there is a uniform difference between each division of the dioptric system: that is, one-eighth .125, or  $\frac{12\frac{3}{4}}{100ths}$  of a meter difference, 0.125, 0.25, 0.375, 0.50, etc. But in the old or inch systems there is no uniformity in the graduations; for instance, between a seven and eight inch lens there is a 1/56 difference, while between a 11 and 12 inch lens there is a difference of 1/132.

In studying the various tables it must be kept in mind that the "old inch system" is not the same as a new inch system would be. This accounts for the fact that a 0.25 dioptre lens is sometimes marked a 144-inch and at other times a 160-inch. The old system would have claimed it to be a 144-inch lens because it had a radius of curvature of 144 inches, whereas by taking into consideration the refractive index the new method of estimating would be to divide the 0.25 dioptre into 10 to get the inch value, which equals in that case 160. It must also be remembered that slight fractional variations are neglected; thus a 3.25 dioptre lens is really a  $12\frac{8\frac{1}{2}}{100}$ -inch, but the fraction in this case is dropped completely;

in other cases, if it comes near a quarter or a half, it is called so; that is, a 16.00 dioptre equals really a  $2\frac{7\frac{1}{2}}{100}$ , but is called a 2½-inch lens. These differences make so little practical difference that they may be treated thus with impunity. Employ the dioptric system for numerating and there will be no irregular fractions like the above to deal with, although even in the dioptric system we often call a meter 40 instead of 39.37 inches, and here again it makes little or no appreciable difference in ordinary calculations, but in most cases the writer prefers the use of the more exact equivalent, i. e., 39.37 instead of 40, if the calculations are being made on paper, but where they are made mentally use 40 by all means.

Q.—(657) Which of the four synonymous terms, dioptre, diopter, dioptré and dioptric, should be used to express the unit of measurement of the metric system of numbering lenses, and why?

A.—With the advent of the dioptric system an unfortunate circumstance crept in that could easily have been avoided at the time, but which has now reached such proportions as to make one hesitate before attempting a reformation. The fault was that no definite form was given to the spelling of the unit, the very cornerstone of the dioptric system itself. Various forms were used, and now no thought seems given the subject by even well-known writers, who use indiscriminately diopter, dioptré, dioptré (as a noun) and dioptre. Now all may be considered variants of the same word, but one must be best, and at any rate one should be adopted so that a uniformity would exist. We fully realize that usage is the supreme factor in establishing the spelling of any word, and all that even the best dictionary can do is to record what spelling receives the most usage. In the instance of the dioptric unit, however, one form is used about as much as the other, and therefore to settle which is the best we must take into consideration not alone how many use it, but who are or are apt to be the more carefully scientific writers.

Selecting from a wide range of works the following tabulation was made which seems to give a fair idea of how the term is used:

*Dioptre* is used by the Ophthalmological Society; Landolt, "Refraction and Accommodation of the Eye"; Bates, "Ocular Refraction and the Shadow Test"; Tscherning, "Physiologic Optics"; Prentice, "Ophthalmic Lenses"; Swanzy, "Diseases of the Eye," and Valk, "Errors of Refraction."

*Diopter* is used by Knowles, "Encyclopedia - Dictionary of the Ophthalmic Sciences"; Cross, "A System of Ocular Skiametry"; Henderson, "Lessons on the



## Optical Department.

Eye"; Thorington, "Refraction and How to Refract"; Rainey, "Eye Strain in Health and Disease"; Brown, "Opticians' Manual."

*Dioptré* is used by Lockwood, "Principles of Optometry"; Weeks, "Diseases of the Eye"; Tiffany, "Anomalies of Refraction"; Maddox, "Ocular Muscles."

*Dioptric* is used (as a noun) by Roosa, "Defective Eyesight"; "Century Dictionary."

Thus the vote taken of the above authorities shows: *Dioptry*, seven; *dioptré*, six; *dioptric*, four, and *dioptric*, two. The "Standard Dictionary" mentions all four terms so it would not change the result if added, yet it, as well as the "Century," gives "dioptré" as a "leveling instrument consisting of a plank, etc." Thus *dioptré* is a term with a double meaning and should be eliminated from optometrical matter, as it is better suited to describing the leveling instrument. *Dioptré* is not a good form, as it is too apt to be confused with the adjective. This leaves *dioptré* and *dioptriv*, and as *dioptré* is merely the French form of *dioptré*, the field seems won by *dioptry*.

Not only the number but the weight of authority also favors the form *dioptry*, and it is high time the proper term was proclaimed and employed. The plural for *dioptry* is *dioptries*, thus 1.00 *dioptry* or 3.00 *dioptries*. The abbreviation is *D*.

Q.—(658) Which of the terms, *dioptric* and *dioptral*, should be used as the adjective from the noun *dioptry*?

A.—There exists some confusion in relation to the form of the adjective. Prentice used "dioptral" as the adjective, and says: "The choice of this adjective would seem justifiable, since the unit 'dioptry' has been chosen in distinction to 'dioptric,' which, though related, has another significance. Thus, a 40-inch telescope lens is a member of a dioptric system, whereas a one-diopter lens is specifically a member of the dioptral system. In the English language we have an analogy to *dioptry* and *dioptral* in the spelling of ancestry and ancestral."

So not only does the form of the noun demand attention, but the form of adjective is also unsettled, though *dioptric* has gained such a firm hold as the adjective that it would be difficult to establish *dioptral* in its place, even though it were proven that *dioptral* was the more appropriate term. No such advantage lies with the noun, however, and in its case, propriety and uniformity should be maintained and *dioptry* used in all cases where reference is made to the unit of measuring optometrical lenses.

Q.—(659) What systems are employed in measuring and numbering optometrical prisms?

A.—Three systems are in use, viz.: Prentice's method, Dennett's method and a method based upon the angle of deviation of the two faces of the prism.

(To be continued.)

Harvey W. Freeze, Brownsville, Ore., is closing out his stock and preparing to go east. Mr. Freeze has arranged to put in a year under Chicago and Boston tutors in post-graduate work in ophthalmology, after which he will return to Oregon.

## A Means of Time Saving When Refracting.

By H. P. LAKIN, M.D., in the *Ophthalmic Record*.

**A**FTER placing the correction obtained by use of the test lenses, stenopaic-slit, ophthalmoscope, retinoscope (which I prefer), or any other means, in the test-frame upon the patient's face, it has been my custom to increase and then decrease first the spherical and second the cylindrical portion of this combination, and finally change both at the same time by means of the cross-cylinder.

At first I used lenses taken out of the test case and replaced again. As these were often needed in the frame, after a time I got extra test-lenses + 0.25 D. and - 0.25 D. spheres and cylinders. Several years ago I added a plano to be placed between the other two, thus using three test-lenses held in the hand and passed before the correction in the test-frame. This Summer I had Messrs. McIntire, Magee and Brown, of this city, make for me, in both

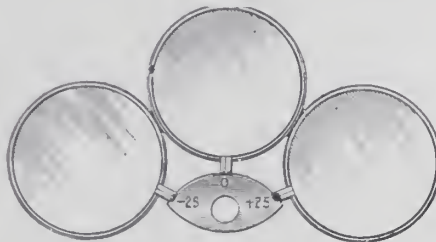

USEFUL LENS COMBINATION FOR TESTING.

spheres and cylinders, sets of the two lenses and planos fastened in one handle. These are of the strengths 0.12 D., 0.25 D. and 0.50 D. They have proven very convenient and great time savers.

Let the patient wearing the combination obtained by any means read the lowest line possible on the test-card. Then taking the spherical set, pass in succession before the correction in the test-frame the plus, plano and minus lenses, having the patient read with each, giving an indication, according to which of the three gives best vision, to increase, let alone or decrease the spherical portion of the combination. Make the alteration indicated, and so continue until the plano gives best vision, showing an indication to leave the spherical portion unchanged. Then taking the cylindrical set, hold it so that the axis of the first lens is coincident with that of the cylinder in the test-frame and pass the three test-lenses before it in a similar manner.

Make the alteration indicated and so continue until the plano gives best vision, indicating no further change of the cylindrical portion. Then take Dr. Edward Jackson's cross-cylinder (which increases the strength in one direction and decreases that at right angles to the former) and proceed as usual with it until no change is indicated by this means. Now the correct combination has been obtained.

The method of increasing and decreasing the strength of the sphere and cylinder, after the combination has been placed in the test-frame, is in very common use by oculists. I merely call attention to the convenience of having the three test-lenses set in one handle instead of taking each one separately from the test-case when needed

and then replacing it, and to the increased rapidity of testing resulting from their use. The device of my colleague, Dr. J. N. Rhoads, which works by first using a plus, then a minus and finally neutralizing to obtain the effect of a plano, is on the same principle, but is much more complicated in its construction.

## A Case of Defective Eyesight Treated Without Glasses.

**D**R. EDWARD G. LORING, for many years before his death a leading eye specialist in New York, had plenty of humor, says the *New York Sun*.

One morning a club friend of his of bibulous habits made his appearance in the doctor's consulting room complaining that his eyes were failing him and expressing fear that he must prematurely take up the use of glasses. He had not connected his defective sight with his alcoholic propensities.

Dr. Loring put him through all the paces of an oculist's examination, showed him alphabets of different sizes, made him peek into all kinds of mysterious holes, peered at his eyes through many uncanny looking instruments, asked him innumerable questions and finally gave his opinion as follows:

"Well, Roddy, you won't have to wear glasses yet a while. Nothing's the matter that we can't cure. Take this prescription and follow its directions. Don't open it until just before you are going to your dinner at the club," and he wrote out and handed over the prescription.

"Thanks, awfully, old man. You don't know how much you have relieved my mind," said Roddy. "How much is it?"

"My fee for examination and prescription is \$20," said the doctor.

Roddy opened his eyes a little, but handed over the money and went out, his respect for his friend greatly increased as he sized up the crowd in the anteroom and figured in his mind what they would amount to in dollars.

That evening as he sat ordering his dinner with a cocktail before him he opened and read the prescription, which ran as follows:

**R** One cocktail per day. E. G. L.

Roddy took his cocktail and never tired after that of offering to bet that he had paid more for a single drink than any other man in the room.

J. Herbert Neve, an optician formerly at 15 Temple Place, but now at 367 Massachusetts Ave., Boston, was fined \$100 in the Municipal Court, July 13, for practicing medicine without registration. The State Board of Registration in Medicine received complaints against Neve, it is sad, and as a result a plan was prepared to send a man with no apparent physical defects to the office of the doctor. After an extensive examination of the man's heart and other parts of his anatomy, according to the testimony, he was told that he needed a pair of spectacles which would cost him \$11. This was reported to Dr. Harvey, of the State Board, and the conviction before Judge Parmenter followed.



That this department shall prove mutually beneficial to our readers, it is desirable that the members of the trade generally communicate with THE JEWELERS' CIRCULAR-WEEKLY regarding any advantageous device or plan which they are utilizing in connection with their business.

**How the Jeweler Can Meet Competition of the Mail Order House.**

**M**ERCHANTS have been so slow in saying anything to their customers, either personally or in print, about mail order houses, for fear of advertising the fact that the mail order house has had ample opportunity to pound into the consumer all its strong arguments without opposition, and now the retail merchant must not only educate his trade to the advantage of trading at home, but must advance a world of good reasons to overcome the sentiment already formed in favor of the mail order house.

The time has come for the retailer to begin an active campaign against the mail order houses. His future business depends upon it, also the future prosperity of his town, for there will be no need of small stores if the mail order houses get to handling the business of the country, as they expect to handle it through the rural delivery and parcels post.

It will be the object of this series of articles to give the retailer ammunition with which to fight the common enemy. There are many reasons why your neighbor should trade with you, but you seldom tell them. The mail order house never stops drumming ideas into your neighbors, and you must learn to do likewise. Make use of this ammunition in your circulars and newspaper advertising. Keep everlastingly at it and you will soon see results. It will not hurt the advertising of most merchants to say a few lines less about staples and to put in several good paragraphs about mail order houses, or even to devote all the space to the fight for awhile, if good judgment dictates such a policy, or if there is something particularly appropriate offered.

One line of business must be quick to take up the good things other lines have found, and thus work every good idea as hard as possible, while it is fresh. How is the following idea likely to work with your neighbors, if you carry it out right?

A Kansas jeweler recently adopted a novel method of showing the advantages of trading at home, and he states that his thorough advertising of this one idea has caused a wonderful falling off in the amount of mail orders going out of his town.

He pinned a slip of paper to the back of a dollar bill, and on the top of it was printed the request that every person receiving the bill should sign his name to the slip, to show how often it changed hands.

In two weeks that bill came back to him again, and it had changed hands 24 times. He got out a circular telling of the experiment, and gave a list of the names signed to the slip. He tried to place one of these circulars in every house in his section of the country. He also received the aid of the publisher of the local paper, who was only too glad to show the people the advantage of keeping their money in the community. There was a long article in the local paper. The idea appealed to the people. It was a good example of what one dollar would do in the way of keeping money in motion. This was easily appreciated.

You can do this for yourself. Your brother merchants will help you, and while you may not be able to show such a large list of transfers, you can make a good showing with a little effort, and the argument is good.

Suppose you then start your circular by calling attention to the great scarcity of money a few years ago, when every one was hoarding gold on account of the fear of free silver. It made money hard to get in all parts of the country. Sending money out of the county for goods which can be bought at home has the same result, except that it makes plenty of money where the big mail order houses are located. It makes it scarce at home all the time, and there is less to pay debts with and to buy with. The story of what a dollar did may follow such an argument, and then have a paragraph showing how little help that dollar would have been to the community if spent with a mail order house. This would make a circular which would cause thought. It is an argument which should be brought to the attention of every person in every community. Try it.

(To be continued.)

**Anent the Business Letter.**

**B**RUSKNESS and brevity—that is the general idea of what constitutes a business communication. As far as it goes, it is correct; but the brusqueness must go beyond curttness and the brevity beyond ambiguity. A gracious word or two, or an explanatory clause, will often place in an entirely different light what might otherwise impress the recipient as rudeness or obscurity.

In order to avoid the latter possibility it is best, before dictating an important letter,

to make notes of the points to be covered, or even a rough draft of the entire letter. Clear thinking is absolutely essential to clear writing; and the average business man cannot think clearly while a typist sits chewing her stylus in uneasy anticipation of the next attack upon the paper.

It is perhaps superfluous to state that a business letter calls for an immediate reply. If it is impossible to reply in full, send along an acknowledgment of the receipt and an assurance of early attention. When the reply is ready, make it clear and definite; arrange your statements in systematic order.

It is a pleasing fact that the majority of business men are becoming as particular about their writing paper as the daintiest debutantes. They want the best, and price is a secondary consideration. The use of cheap and nameless stock is supposed to have about the same effect upon the recipient, as if the writer were to make a personal call in a ragged coat and soiled linen.

**A Novel Style of Price Card.**

**I**N decorating a show window much depends on the method of pricing the articles. In this question of selecting price cards two prime factors enter which must, of course, be religiously adhered to. One is that the cards be of sufficient size to permit of figures large enough to be read easily. The other is that those figures or price denominations be in characters free from any ornamentation that tends to hide the numeral.

A valuable *additional* advantage over and beyond the two above-mentioned cardinal points may be gained by having the most artistic, novel and attractive price cards available.

If specially attractive price enumeration is desired, the old method of using crisp new greenbacks on the goods is very effective. But often the even dollar or dollars are unavailable on account of lower denominations figuring in the price. In such cases a very novel and attractive effect is gained in the following way: Take slightly larger cards, and on a spare space, with the aid of a pot of liquid glue, stick the equivalent in coin. For instance, if 35 cents is required, glue a quarter and a dime on the card.

Of course, fresh, bright, newly minted specie are necessary to give a truly brilliant effect. You can get them from your bank.

**Storekeeping Department.**

**An Attractively Furnished Jewelry Store in Columbia, S. C.**

THE attractive and cleverly designed jewelry establishment illustrated herewith is located in Columbia, S. C., where the enterprising owners, Sylvan Bros., enjoy a prosperous business. Seventeen years ago, Gustaf and Johannes Sylvan emigrated to this country from Höganas, Sweden, the place of their birth, and in 1897 began in Columbia the business which has since been considerably developed by dint of energy and enterprise.

The present quarters are in the concern's own building, known as the Sylvan building. The location is an ideal one, the frontage on Main St. being 34 feet and that on Plain St. 75 feet. The main entrance is just on the corner, giving the store a display window 14 feet long on Main St. and another 60 feet long on Plain St. These windows, moreover, have a depth of eight feet, and in them are fitted show cases, between which are erected large columns trimmed with plate glass mirrors, making the general effect very beautiful.

The perspective of the interior of the store presents a striking view, with the long graceful plate glass show cases and wall cases extending far back to the rear. The doors, fixtures, etc., are of mahogany. The floor is of mosaic tiles. The ceiling is paneled with heavy plaster beams in squares, with a 16 candle-power light in the center of each square.

The opening seen in the center of the ceiling forms a kind of balcony and is 10 feet wide and 35 feet long. Here is located the workshop, the ceiling of which is fashioned in a manner similar to that of the store below. Three massive brass chandeliers are suspended from the upper

ceiling and extend down through the opening. This workshop is well lighted by day and night, having eight windows for the admission of light and fresh air.

The machine room, back of the workshop, has two windows. In the machine room is

a two horse-power motor for running the polishing machine, rolling mills, sand blast, lathes, etc.

Altogether the establishment is so complete and handsomely equipped that the owners have just reason to take pride in it.



VIEW SHOWING GALLERY FLOOR, ON WHICH IS LOCATED SYLVAN BROS.' WORKSHOP AND REPAIR DEPARTMENT.



EXTERIOR AND INTERIOR OF THE HANDSOME STORE OF SYLVAN BROS., COLUMBIA, S. C.

What Tool is of More Importance to THE MAKERS OF FINE JEWELRY than

A FIRST CLASS SAW ?

SHARP—TRUE—UNIFORM  
—PERFECTLY TEMPERED



Such is the **ZEUNER SAW.**

TRY THEM, for "Only the Best are Good Enough," and only the Best are Cheap. Trial orders promptly filled under guarantee of perfect satisfaction, which applies also to our "AMERICAN SWISS FILES."

**E. P. REICHELME & CO.,** 23 JOHN STREET, NEW YORK.

**THE REMINGTON RING EXPANDER.**

The most useful implement a jeweler can own.

PRICE \$7.00 NICKEL PLATED INCLUDING A STEP MANDREL AND EIGHT ROLLS

IT WILL EXPAND FLAT OR OVAL, PLAIN AND SET RINGS, OR ANY RING THAT IT IS POSSIBLE TO ENLARGE.

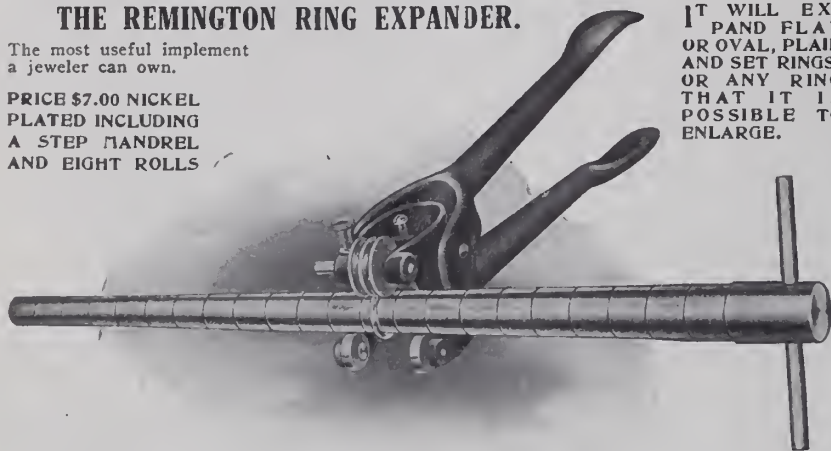

IF YOUR JOBBER CANNOT SUPPLY YOU WRITE TO US DIRECT.  
SPECIAL FEATURES OF THE REMINGTON RING EXPANDER.

A MANDREL WITH STEPS SQUARED and 1/2 size variation is used to prevent tapering of the ring. THE FOUR SMALL ROLLS ON THE LOWER JAW OF THE TOOL (see cut) PREVENT FRICTION, and make it possible to use any amount of pressure WITHOUT ROUGHING THE MANDREL. THE PRESSURE IS CONTROLLED BY THE HAND and it is not necessary to use a vise or other implement when operating the REMINGTON.

Manufacturers of Patent Tools and Machinery.

NOVELTY ENGINEERING ASSOCIATION, FITCHBURG, MASS.

Reduced Rates for Telephone Service

throughout Greater New York are effective from July 1st. Contracts now being taken at new rates.

Call nearest Contract Office for full information.

NEW YORK TELEPHONE COMPANY

<i>Contract Offices:</i>	<i>Telephone No.:</i>
'15 Dey Street	9010 Cortlandt
115 West 38th Street	9040 38th
220 West 124th Street	9000 Morningside
916 East 150th Street	9020 Melrose

**LEIMAN'S NEW SAND BLAST.**

SIMPLE. EFFECTIVE. ECONOMICAL.

NEW FEATURES—Let us tell you about them.  
RESULTS—Let us show you samples of work done.

**Improved High Pressure Blower**

NOISELESS. INEXPENSIVE.

Delivers Greater Volume at Higher Pressure Than Any Other Made.

**LEIMAN BROS.,**

Jewelers', Silversmiths' and Metal Workers' Machinery, Tools and WORK BENCHES,

141 Centre Street, NEW YORK.

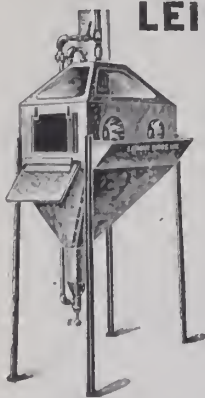

PATENTED.



PATENTED.

**GLARDONS' SWISS FILES**

are the HIGHEST STANDARD of Excellence.

We are Sole Agents for the United States and Canada.

**F. W. Gesswein Company,**

Established 1868. Incorporated 1896.  
WILLIAM DIXON, PRES.

Dealers in Fine Tools and Supplies,  
39 John Street, New York.

ROLLED GOLD PLATE  
**SEAMLESS WIRE AND TUBING**

DUNBAR, LEACH, GARNER CO.,

MANUFACTURERS,

ATTLEBORO,

MASS.

**JAMES J. DONNELLY,**  
Gold and Silver Electro Plater,  
Fire Gilder and Colorer,  
41 and 43 Maiden Lane, New York.  
Prompt Attention Given to Mail Orders.

"PRACTICAL COURSE IN ADJUSTING."  
Price, \$2.50.

All Jobbers or Jewelers' Circular Publishing Co.



[Answers are also solicited from our readers to the questions published on this page.]

**QUESTION No. 1622.—Tin Plating.**—*I have some copper coffee pots which I want to plate on the inside with tin. Kindly tell me how to make such a solution for an electric current.* T. P.

**ANSWER:**—Make your solution with phosphate of soda, two ounces; chloride of tin, one ounce; water, one gallon. This solution can be poured into the cleaned copper pots and connected with the current; bob into it a tin anode. This requires only a light current, and the solution of tin must be kept at full strength by adding a saturated solution of chloride of tin.

**QUESTION No. 1623.—German Silver Alloy.**—*I am about to make a line of German silver candlesticks, and wish you would give me the composition of an alloy that will work well and not tarnish very easily.* J. G. S.

**ANSWER:**—German silver varies very much in composition. One very good kind that will polish well and which is useful for nearly all sorts of articles, is composed of copper, 50 parts; zinc, 25 parts, and nickel, 25 parts. The alloys vary, according to the use to which they are to be put; from 50 to 60 parts copper, 19 to 31 parts zinc, 13 to 18 parts nickel. A very good substitute, very much used, which gives a silver white luster and suitable for artistic purposes, called argazoid consists of: Copper, 55 parts; zinc, 23-198 parts; nickel, 13-101 parts; tin, 4.035 parts, and lead 3.544 parts.

**QUESTION No. 1624.—Reclaiming Metal from Dross.**—*How can I reclaim the metal in tin dross without a great deal of heating. I burn down the tin and britannia dross several times, but it requires so much heat that it burns the metal so that it is unfit to use again for good castings. If there were some method of regaining this metal without overheating, a large saving would be the result. I know many manufacturers who are in the same fix as myself.* R. M. D.

**ANSWER:**—Tin and britannia dross may be treated so that all the metal therein is separated without overheating and burning. The lumps and cakes of dross should be melted down in the regular way, and all the black appearing dust should be placed in what the miners call a stamp. This is an iron round bottom pot, which has a cover that is secured with screws or clamps to the top of the pot. Through the center of the cover is a hole through which runs an iron rod. This rod is connected with a running shaft above, and an iron ball is secured to the end in the pot. The pot is half filled with the dross and the shaft is started, arranged in such a manner so that the ball will pound up and down, thus pulverizing the dross into a fine powder. The result will be that in a little while most of the metal will

gather at the bottom of the pot. This pulverized mass can be separated by having a blower or fan blow away the dust, and the metal will remain. This method is much used in Germany for the separation of the dross from the metal, and the result is that the metal can be used again for good castings.

**QUESTION No. 1625.—Hardening Britannia Metal.**—*How can I temper or harden britannia metal?* H. B. M.

**ANSWER:**—Britannia can be hardened by merely subjecting the metal to a degree of heat, slightly below the melting temperature of the metal. This is usually done after the rolling or blanking, and in a muffler or on an iron plate. After the heating the metal should be cooled as quickly as possible. If there is only a sheet this can be left to cool, but if a stack of blanks have been heated it is best to separate them after the heating so that the cool air will pass over them.

**QUESTION No. 1626.—Lathe Attachments.**—*How and what attachments to a lathe are necessary to mill out true the hole between the two plates of a watch that contain the winding pinion and arbor? I have Universal head, slide rest and wheel cut attachment, but the milling cutter must of necessity be run at a right angle of 90 degrees to the lengthwise of the lathe bed. What attachment must the milling cutter be held in, the hole to be milled out with the plates screwed together, of course?* R. P.

**ANSWER:**—There is no attachment made to any American lathe commonly for sale, by means of which you can perform the operation which you describe in your letter. The original Hopkins Pivot Polisher, made in the year 1872, might readily have been adapted to your use, but it is questionable whether one could now be obtained. The next best which may be adapted is the Webster-Whitcomb milling tool made for lathe No. 2, but such adaptation will require considerable work. A slide rest with three motions, one of which is a perpendicular one, would do the business with the least alterations. A face plate with a vertical slide may also do the work with some minor attachments. A tool similar to this is sometimes used in the factory.

**QUESTION No. 1627.—Making a Dust Bag.**—*What do you mean by "powder from a dust bag?"* L. X.

**ANSWER:**—A dust bag is a bag made of some coarse cotton web or other texture that will allow emitting of marble powder or even some coarser dusty substance when subjected to friction or beating.

**QUESTION No. 1628.—Puzzling Watch Variations.**—*I have repaired, recently, for one of my customers a 15-jewel move-*

*ment which I have regulated by carrying same in my pocket and it did not vary more than one minute per week; yet, when my customer carries the watch he complains that it runs eight minutes fast per week. He brought back the watch for the third time, always with the same complaint, and I have carried it again, and it does not vary more than one minute per week.*

L. D.

**ANSWER:**—It may be inferred from the tenor of your letter that the 15-jewel movement is claimed to be an adjusted one. If so, some of the adjustments may be out of order. We would suggest that a third party carry the watch two days, or so, and note the variations; next inform yourself well in regard to the use of the watch by the individuals who have carried it. This may lead you in the shortest manner to the detection of the cause of the irregularity in the running. In case this plan should prove unsuccessful in giving the desired information, a thorough examination of the adjustments is the only alternative. Such an examination ought to include a test for magnetism. Some matter was published June 27, on p. 97, concerning a similar experience, which we suggest that you read.

### The Melting of Small Beads of Gold or Silver.

(Translated from the Deutsche Goldschmiede Zeitung.)

THE ordinary melting of small beads of gold or silver on a piece of charcoal by a blowpipe may be a very convenient operation when done on a small scale, but when the manufacture of such beads or pearls is to be done in quantities a more comprehensive system has to be employed. This is done as follows: Gold or silver wire, after having been alloyed with a small proportion of chemically pure zinc, is drawn into a thin wire, which is coiled in spiral form around a thin wire, preferably of steel. When prepared in this manner it is cut into single coils, representing small eyelets, by some easily constructed pair of nippers which will work automatically. These eyelets are then boiled in a 15 per cent. solution of borax until the water has been evaporated, by which operation all of them have been covered equally with the borax.

The bottom of a graphite crucible of liberal size is to be covered with charcoal dust to the thickness of about 2 cm., which is to be pressed down to a level. This surface is to be covered with a number of eyelets in such a manner that they do not touch each other. After covering these with a second layer of charcoal dust and eyelets, these operations are to be repeated till the crucible is moderately filled.

An experienced melter will be able to do the rest and see to it that these eyelets do not run together, but are heated sufficiently to produce beads which will all be of an equal size and will only need pickling to be used in the manufacture of the best filigree jewelry.

Herbert Hakan, who for the past two or three years conducted a jewelry and loan office under the name of the Queen City Loan Office, Sedalia, Mo., has discontinued business.

**C. DORFLINGER & SONS,**

36 MURRAY STREET, NEW YORK.

*Works, White Mills, Wayne Co., Penna.*

Manufacturers of plain and cut Table Glassware of the highest quality.

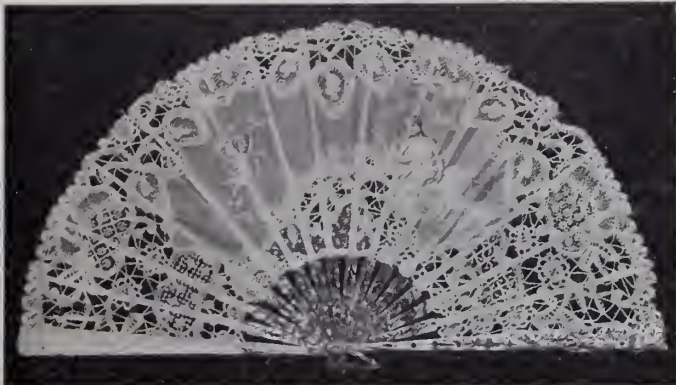

**FANS**

Headquarters for the most exclusive line in this country.

SPECIALLY DESIGNED FOR THE FINE JEWELRY TRADE

**NECKLACES**

Imitation Pearl and Fancy Bead, in all newest shades and exquisite colorings. Write for Samples, mentioning price.

**LOUIS STEINER, Importer,** 520 & 522 Broadway NEW YORK

*The Thimble House.*



No. 149.

Thimbles are not a side line with us—They are our main business. We study Thimbles, our designers study thimbles, our workmen study thimbles—The result is the finest and largest line of Thimbles on the Market.



No. 136.

**KETCHAM & McDUGALL,**

Manufacturers.

37 & 39 Maiden Lane, New York.

Send for Catalogue.

Established 1832.

ALSO MAKERS OF THE NEW AUTOMATIC EYE-GLASS HOLDERS.

**SIGNS**

WHEN fixing your store, don't neglect the most important part—your SIGN. There's a great deal in getting your name before the public in the right way.

"No trouble to ship out of town."

**THE FORMAN CO.**  
SIX LIBERTY PLACE  
NEAR MAIDEN LANE ··· NEW YORK.

**LOUIS W. HRABA, Fine Leather Goods,**

29 East 19th St, New York.

Manufacturer of

Exclusively for the Jewelry Trade.

**JACOT MUSIC BOX CO., IMPORTERS.**

Stella and Ideal Music Boxes,  
39 UNION SQUARE, N. Y.

**C**LOCKS, BRONZES  
COMMUNITY SILVER  
CUT GLASS, NOVELTIES

SEND FOR CATALOGUE

**H. BEALMEAR & CO.**  
234-236 Park Ave.  
Baltimore, Md.

# THE CONNOISSEUR

*Devoted to Art Pottery, China, Marbles, Bronzes, Cut and Decorated Glass Ware, Bric-à-Brac, Lamps, Art Metal Wares, Fancy Goods and Kindred Lines.*

## A British Criticism of Our Customs Laws Relating to China and Pottery.

CUSTOMS laws of the United States are declared by a contributor to a recent issue of the *Pottery Gazette* of London to be unsatisfactory to the pottery trade. He holds that the administration of the laws is not fair to the American importer. The writer also makes a suggestion that English potters must make feldspar china if they desire to compete with Germany's cheaper products. The English writer's views are set forth as follows:

"The United States Customs Law, from the point of view of jurisprudence, in a very unsatisfactory condition. It states that the goods should be invoiced at market value, and the decision of the appraisers has been that this means that the goods must be entered at such prices as they are sold in the home market. An importer buys a certain quantity, and in many cases very large quantities of goods. Manufacturers in this trade doing a large business to the United States know very well that orders given by large houses in the United States are for very large quantities, and are in most cases supplied cheaper than similar goods would be for the home trade where no house is able to buy those quantities. How can it be expected that an American house who purchases goods in the European market can know the prices at which the same manufacturer would sell to a home trade house?"

"When information is got by the appraisers that certain articles are sold in the home trade at a certain higher price, the goods on entry are raised; and here is the injustice of the law, that for every 1 per cent. the goods are raised there is a fine inflicted automatically of 1 per cent., as you state, and no proof that the purchase is a legitimate one, and no testimony on the part of the manufacturer that these are the proper prices which he receives and that he gets a fair profit by these transactions, are of any avail when it comes to a re-appraisal.

"For some years past the American Manufacturers' Association have, as you correctly state, made complaints to the United States Custom House that goods are undervalued by many Continental manufacturers, and the state of the law has been used as a lever for thus making imports more difficult, and many goods have been raised and importers have been fined for what are perfectly legitimate purchases.

In the French dinner ware trade there has been made a positive scale by the United States Custom House under which nothing can be imported, and whatever a manufacturer may be able to do in selling goods below this price at a good profit, the goods

are raised when they come to the Custom House at his price, and the importer is fined. If such actions are indorsed by the trade paper of the potteries it can only lead to British manufacturers being treated in the same manner, for the United States manufacturers find more competition among British earthenware manufacturers than among German or French china manufacturers.

"The important trade to the United States is done in the potteries by comparatively very few houses, who are known to everybody. You only need to inquire from them whether their prices for their large United States orders are not considerably below any such orders they can take in the home trade, and whether they would consider it just if their goods were treated in a similar manner on arrival, and what injury it must do to that trade if such actions would be considered correct.

"As to the question of this action having any material effect upon the largely growing German trade and a beneficial effect upon the trade of Longton, the sooner British manufacturers are alive to the actual course of the large growth of the German pottery the better it must be for our trade here. The growth of the German potting trade is entirely due to the manufacture of feldspar china, which has many facilities; the materials are considerably cheaper than even those of English earthenware, the glaze is out of proportion less, and, as compared with English china, the materials and glaze combined are about one-third of the cost. The firing comes considerably cheaper. The molds in Germany are practically one-quarter of the cost, and this is all apart from the cheaper labor.

"Many articles can be manufactured in feldspar china cheaper than they can in earthenware, and if England wants to keep a great part of this trade for the future there is only one way, and that is by establishing feldspar china potteries here, with up-to-date methods; but to indorse the action of the United States Potters' Association, and by this means to get inconvenient competition out of the way, is a method which will only recoil upon themselves."

Carl Schwartz has returned to Merton A. Gaskell's store, Rochester, Minn., after a vacation spent in Winona, Minn.

Thomas A. Baden, lately with Pyl & Wykkel, Kalamazoo, Mich., has bought the business of Randall A. Buckmaster, 152 St. Burdick St., with whom he was formerly associated. Mr. Baden is the watch inspector for the Michigan Central, Grand Rapids & Indiana and Lake Shore railroads.

## Some Interesting Facts About the Exposition at Reichenberg, Bohemia.

IN a recent report Consul-General McFarland describes the Reichenberg Exposition, which is now in progress in that Austrian city, saying in part:

"In its setting the Reichenberg Exposition is certainly unique, surrounded as it is by mountains, with a large artificial lake. It brings together for the first time the varied products of north Bohemia, or the so-called Deutsch-Böhmen. The exposition was intended to cover only the products of the German or Austrian born people of this section, the Czechs or Bohemians being strictly excluded. This has naturally shut out some of the prominent local firms, such as the glass works conducted at Neuwelt by Count Harrach, who is a Bohemian. The line was also drawn against American, German or other foreign concerns whose products compete with those of Bohemia, the idea being to exploit only the products of the Austrians who have built up the manufacturing industries of north Bohemia. It is also true that some prominent Austrian firms, actuated partly by motives of economy but chiefly by fear of imitation of their especial products, are not represented. At the same time the exposition is fairly representative, and the exhibits show collectively and for the first time the beautiful rugs and textiles, the glass in its raw state and its perfect utilization, the Gablonz specialties in imitation stones and jewelry, and the porcelain and china from the neighborhood of Carlsbad.

"Notwithstanding the strict rules, and under cover of Bohemian agencies, quite a number of American exhibits, somewhat disguised, have crept in. The American typewriter and cash register are everywhere, the Singer Sewing Machine Co. has a complete exhibit, American roll-top desks and office furniture are exhibited through a local firm, the Northrop loom is shown by the Austrian Textile Works, and American agricultural machinery, exhibited through local agents, of course, dominates that section. Of all the exhibits, however, excluding Bohemian glass, the textile section is the most interesting, for here are found the fine cloths which seem to reach only the European markets and are celebrated in Vienna, Dresden, Paris and London, but which appear to reach the American markets only as the finished goods of some foreign modiste, with all charges added. In this section are also exhibited the hand-woven rugs and tapestries, rivaling Turkey and Persia.

In glass, both cut and decorated, no such collection was ever before brought together.



**For the FALL TRADE**

We have prepared many NEW ARTICLES  
in our famous

**"Metal and Glass" and Copper**

VISITING BUYERS are invited  
to inspect our new

**Electroliers, Desk Sets, Etc., Etc.**

**APOLLO SILVER CO.**

**BERNARD RICE'S SONS**  
PROPRIETORS

WRITE  
FOR  
BOOKLET

544 BROADWAY, NEW YORK



Made in the  
"APOLLO STUDIOS"



**JAM KETTLE**

of Silver Deposit on Crystal Glass.

A decidedly attractive and appropriately ornamented item in a big line noteworthy for its variety and the beauty, originality and workmanship of every article comprising it. Write for particulars.

**LACKNER & OHL**

Manufacturing Silversmiths  
OFFICE AND FACTORY:  
51-55 Columbia Street NEWARK, N. J.

**Tivoli Art Glass Co.**

(L. ADLER & SON)  
General Agents

Makers of High Art Iridescent  
and Decorated Glassware

87 MAIDEN LANE NEW YORK  
Telephone 2054 John.

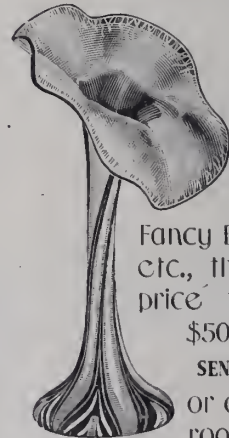

GLASSWARE showing "The Colors of the Rainbow." Our line is complete with Vases, Fancy Bowls, Novelties, etc., that range in price from \$1.00 to \$50.00 each.

SEND FOR A SELECTION,  
or call at our show rooms. The selling quality is in the sheen and colors; cuts cannot show its beauty.

**Roger Williams Silver Co.,**

PROVIDENCE, R. I., AND NEW YORK, 860 BROADWAY.

**Sterling Only.**

RICH DESIGNS :: :: :: Photos on Application.

**Ribbons**

in stock and special designs **MADE TO ORDER**, in large or small quantities, to use with medals and for club purposes. ✂ ✂ Correspondence invited.

JOSEPH LOTH & CO., Manufacturers, 65 Greene Street, New York.

**The ST. JAMES**

Corner Walnut and Thirteenth Streets  
PHILADELPHIA, PA.

**The Ideal Hotel of Philadelphia**  
European Plan EUGENE G. MILLER, Mgr.

**THE "E-Z-FILL" SELF-FILLING FOUNTAIN PEN**

FILLS INSTANTLY BY TOUCHING SPRING ON SIDE OF BARREL WITH PATENT PUSH PIN.



Every Pen Warranted 14-Karat Solid Gold. No complicated parts to get out of order. Large profits to Jobber and Retailer. The only safe and practical Self-Filling Fountain Pen ever offered at a popular price. Made only by

**DIAMOND POINT PEN CO.** - 100-102 Beekman Street, New York

Largest Manufacturers of Popular Price Fountain Pens in the United States INFRINGERS WILL BE STRICTLY PROSECUTED Send for large illustrated price lists

Other Patents Pending.  
Retail at **\$1.00**



**Working Model of Traction Engine Built by a Missouri Jeweler.**

THE recent unveiling of the statue of the founder of the Baldwin Locomotive Works, Philadelphia, recalled the fact that Mr. Baldwin began life as a manufacturing jeweler, and built his first engine while engaged in that business, later going into locomotive building. That Mr. Baldwin was not the only jeweler whose talents have been turned toward engine building is apparent from the fact that S. M. Coffman, a jeweler of Braymer, Mo., recently completed a most unique working model of a traction engine containing 3,100 pieces, which has attracted considerable attention locally, and has been the subject of some comment in technical papers.

An illustration of the engine is shown



S. M. COFFMAN AND HIS MODEL OF A TRACTION ENGINE.

her, with, together with a portrait of Mr. Coffman, which will give an idea relatively of the size of the model. Mr. Coffman recently described his work in making this engine in an article contributed to *Popular Mechanics*, as follows:

"Back of my jewelry store and optical parlor, in the city of Braymer, Mo., I have fitted up a little factory where every evening I spend a couple of hours in manufacturing horological tools of my own invention and doing model work. Here I built my complete working model of a traction engine, which in every detail is like the big 12-horsepower engines of its type. The equipment of my factory includes a 5-horsepower gasoline engine, a 2-kilowatt compound generator, two motors, a screw-cutting lathe, two watchmakers' lathes, and a number of other special machines, such as milling and grinding machines of my own design and make.

"My work in this line began with a great desire to become a finished mechanic. Fourteen years ago I made a watchmaker's bench, composed of 2,500 pieces, and lathe, and began repairing watches and clocks.

From that time I have been a reader of the best horological and scientific papers, but I never worked as an apprentice in my life.

"In building this traction engine model I experienced many difficulties. It is nearly all built-up work, the three elbows in the steam pipe being the only castings used. It is built to the exact scale of a 12-horsepower engine—1½ inches to the foot, or ¼ size—and is composed of 3,150 pieces—882 pieces in the two rear wheels, 41 pieces in the differential gearing, 30 flues, water and steam gauges, governor, safety valve, lubricator, pump and whistle. Many special tools were required in its construction, all of which I made on the lathe.

I could not procure a glass tube 1-16 inch in diameter for the water gauge, and so had to draw one out of a ¼-inch tube. The engine that this model represents is

set to carry 130 pounds pressure to the square inch. It would have been much easier to have made this steam gauge register 130 actual pounds to the square inch, but it was not desirable to carry such a high pressure on the model, so I concluded to increase the registration as many times as I decreased the size of the gauge, which is ⅛, or to about the size of a dime. This gauge is of the drawn-tube type, and the tube is drawn very thin. The internal diameter is 1-1,000 inch by 3-32 inch, and even then it was necessary to use compound rack and pinions, so when the gauge shows 130 there is 16¼ pounds actual pressure, and the pop valve acts. The differential gearing was quite a difficult piece of work, as I made the milling machine and wheel cutters to make all of the gears. The time occupied in building the model, including the many dies and gigs, was about 10 months, working at odd times and after lamplight."

Albert E. Weber, of Winnebago, Minn., has removed to Lakefield, Minn., where he will engage in the jewelry business again.

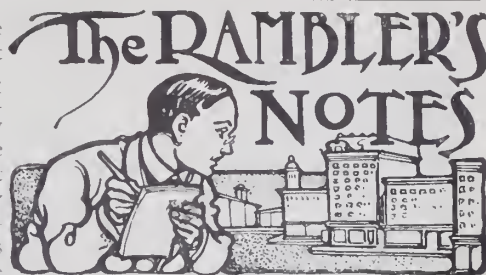

DOULTON WARE SHOWN IN NEW QUARTERS.

THE new show-rooms of Wm. S. Pitcairn, at 44 Murray St., New York, have been fitted up and are now among the most spacious and most handsome to be seen in the pottery district. Two floors are occupied in the display of Royal Doulton china and earthenware, and the third floor is used as a packing room. Mr. Pitcairn has recently been receiving samples from England adding to the existing large display. In the service plates and tea sets the variety is greater than ever. The reproduction of those patterns whose popularity has stood the test of generations comprises a considerable part of the exhibit, and to these lines are added the best of the new designs. One of the novelties which was introduced several years ago and has maintained its hold on a considerable part of the trade is Dutch earthenware, coming in green and yellow shades with typical scenes from the land of dykes. The "Automobile," "Friar" and "Isaak Walton" specialties have been selling well in the last season and new patterns are being added to each.

NEW EFFECTS IN LIMOGES CHINA.

QUITE a number of new designs in Limoges china have recently been received by Bawo & Dotter, 26 Barclay St., New York. In china finished in an ivory body and ornamented with heavy flat and relief gold there is an especially wide variety of fancy pieces, including plates, bowls, chocolate pots, sugar and creamers, and cups and saucers. A dainty set that is much admired has gold borders in lace effects interspersed, among which are roses of soft and delicate effects. Some plates have wide and heavy gold borders, while just inside the outer band are quite soft and delicately colored circlets.

COOK POTTERY CO. ACQUIRES NEW PLANT.

THE Cook Pottery Co., Trenton, N. J., recently arranged with the Colonial Trust Co., of Pittsburg, for the control of the plant of the Pennsylvania China Co. at Kittanning, Pa. The Cook Co. will operate the newly acquired plant as a factory for its Western trade. It is expected that work will be resumed at the Kittanning pottery in a week. It is expected that about 400 persons will be employed, several of whom may go from Trenton. The Cook Pottery Co. now has 27 kilns. The officers of the company are: Charles Howell Cook, president and treasurer; F. G. Mellor, vice-president, and James H. Mulheron, secretary.

THE RAMBLER.



**HERPERS BROS..**  
MAKERS OF  
**BRACELET SETTINGS**  
IN 10, 14 AND 18 KARAT GOLD  
AND IN PLATINUM.  
ALSO A COMPLETE LINE OF  
GALLERIES AND FINDINGS.

OFFICE AND FACTORY NEW YORK BRANCH  
NEWARK, N. J., U. S. A. 41-43 MAIDEN LANE

GALLERIES  
12 NEW PATTERNS

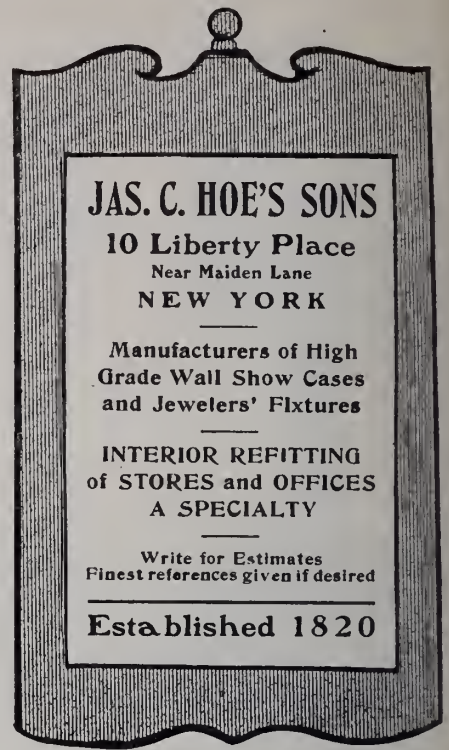

**JAS. C. HOE'S SONS**  
10 Liberty Place  
Near Maiden Lane  
NEW YORK

Manufacturers of High  
Grade Wall Show Cases  
and Jewelers' Fixtures

INTERIOR REFITTING  
of STORES and OFFICES  
A SPECIALTY

Write for Estimates  
Finest references given if desired

**Established 1820**

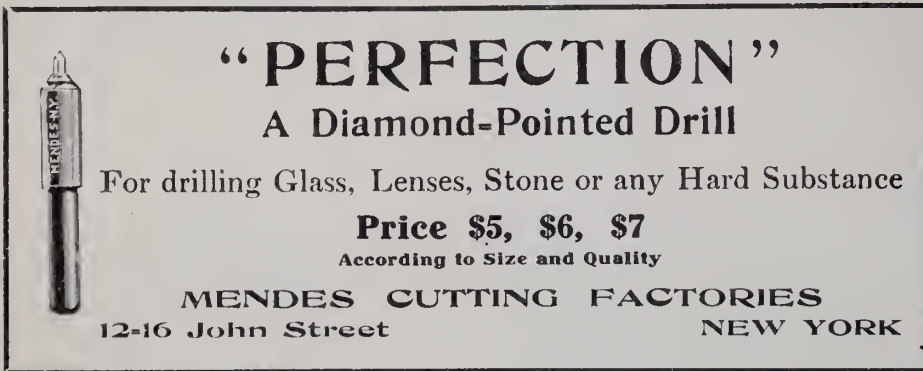

**"PERFECTION"**  
A Diamond-Pointed Drill  
For drilling Glass, Lenses, Stone or any Hard Substance  
Price \$5, \$6, \$7  
According to Size and Quality  
**MENDES CUTTING FACTORIES**  
12-16 John Street NEW YORK

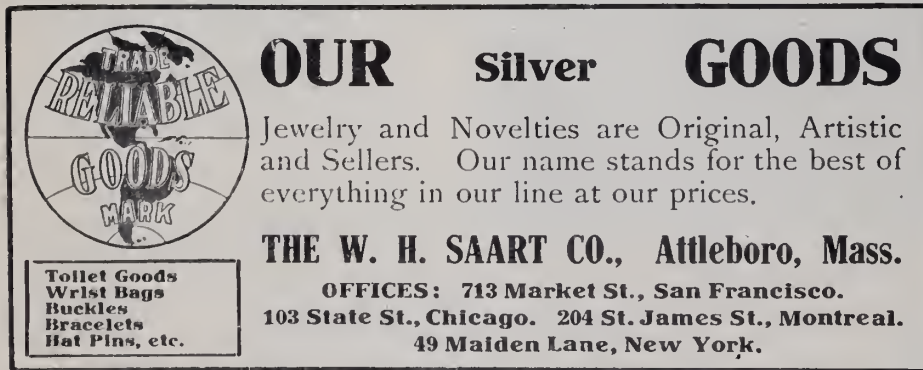

**OUR Silver GOODS**  
Jewelry and Novelties are Original, Artistic  
and Sellers. Our name stands for the best of  
everything in our line at our prices.  
**THE W. H. SAART CO., Attleboro, Mass.**  
OFFICES: 713 Market St., San Francisco.  
103 State St., Chicago. 204 St. James St., Montreal.  
49 Maiden Lane, New York.

Tilet Goods  
Wrist Bags  
Buckles  
Bracelets  
Hat Pins, etc.

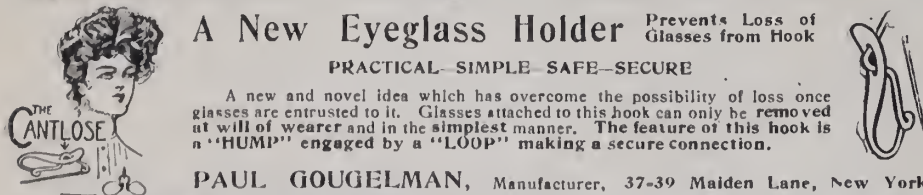

**A New Eyeglass Holder** Prevents Loss of  
Glasses from Hook  
PRACTICAL—SIMPLE—SAFE—SECURE  
A new and novel idea which has overcome the possibility of loss once  
glasses are entrusted to it. Glasses attached to this hook can only be removed  
at will of wearer and in the simplest manner. The feature of this hook is  
a "HUMP" engaged by a "LOOP" making a secure connection.  
PAUL GOUGELMAN, Manufacturer, 37-39 Maiden Lane, New York.



**HERMAN KOHLBUSCH, Sr.,**  
ESTABLISHED 1859.  
Manufacturer of Fine Balances and Weights  
for every purpose where accuracy is required.  
Office and Salesroom, 194 BROADWAY, NEW YORK:  
Send for Price List. Tel. 370 Cortlandt.

**THE THOUSAND ISLANDS**

will be more attractive than ever  
this season. The New York Central  
Lines Four-Track Series No.  
10, "The St. Lawrence River from  
the Thousand Islands to the  
Saguenay," contains the finest map  
ever made of this region. Copy  
will be sent free, postpaid, on re-  
ceipt of a two-cent stamp by  
George H. Daniels, Manager,  
General Advertising Department,  
Room 61A, Grand Central Sta-  
tion, New York.

THE **NEW YORK CENTRAL LINES**

REACH THE THOUSAND ISLANDS FROM EVERY DIRECTION

C. F. DALY, Passenger Traffic Manager,  
New York.

**PATENTS**  
obtained on inventions and designs. Trade  
marks, prints and labels registered.  
**R. W. BISHOP,**  
ATTORNEY AT LAW,  
408 C Street N.W., Washington, D. C.

**Eliassof Bros. & Co.** IMPORTERS AND JOBBERS OF **DIAMONDS WATCHES JEWELRY**  
A LARGE ASSORTMENT OF DIAMOND MOUNTED JEWELRY CARRIED IN STOCK.

9-11-13 MAIDEN LANE, NEW YORK.  
100 STATE STREET, ALBANY, N. Y.





Hand Bag.

Established 1850

**C. F. RUMPP & SONS**

Manufacturers of

**Fine Leather Goods**

**PHILADELPHIA**

NEW YORK SALESROOMS - 683 and 685 Broadway

Send for Catalogue.



Emergency Case.



THE OAK.

**E. H. H. SMITH SILVER CO.**

BRIDGEPORT, CONN.

Silversmiths' Building,  
CHICAGO, ILL.



Manufacturers of

**Sterling Effects in Plate**

Write for our new catalogue.

**:- Comparison :-**

ofttimes leads to better returns. We invite investigation and guarantee satisfaction.

Send us a trial order.

**CONLEY & STRAIGHT,**

Gold and Silver Refiners,  
Assayers and Sweep Smelters,

236 EDDY STREET, - PROVIDENCE, R. I.

Dealers in Fine Gold, Silver and Copper. All kinds of Gold and Silver Anodes.

**BLANCARD & CO.,**

96 MAIDEN LANE,  
**NEW YORK.**

**WELL MADE GOLD FINDINGS.**

**CRUCIBLES.**

Jewelers' Supplies, Etc.

Established 1850.

**J. & H. BERGE,**  
95 John Street,  
NEW YORK.

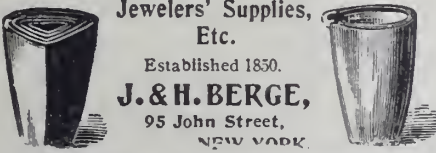

**Encyclopedia-Dictionary**  
and reference hand-book of the Ophthalmic Sciences.  
Price, \$2.50.  
The Jewelers' Circular Pub. Co., 11 John St., N. Y.

**FAIRCHILD & COMPANY**

225 to 233 Fourth Ave. NEW YORK CITY.

Manufacturers of GOLD PENS, PENCILS,  
PENHOLDERS, SEGAR CUTTERS, SPECIALTIES,  
PENCILS SET WITH JEWELS.

Style, quality and workmanship acknowledged  
the very best.



*Mercantile Fountain Pen*

**The Best Self-Filling Attachment**

made and guaranteed by the

**AIKIN-LAMBERT COMPANY,**

Retail Price:  
**\$3.00**  
**\$3.50**  
**\$4.50**

Send for Price Lists and Discounts.

19 Malden Lane,  
**NEW YORK.**



PATENT APPLIED FOR.

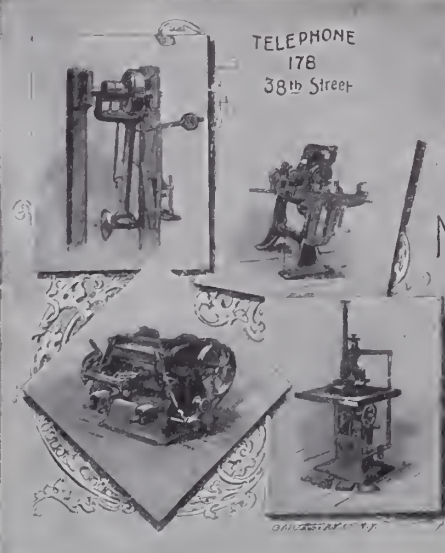

TELEPHONE  
178  
38th Street

# P. PRYIBIL,

512 to 524 West 41<sup>st</sup> Street,  
NEW YORK.

Manufacturer of  
**WOOD WORKING MACHINERY.**  
BRASS, IVORY.  
HORN WORKING,  
SPECIAL MACHINERY.  
SHAFTING,  
PULLEYS & HANGERS.

**WM. F. RENZIEHAUSEN CO.,**  
**GOLD and SILVER REFINERS**  
Sweep Smelters, Assayers and Analytical Chemists

Rolling of FINE AND STERLING SILVER a Specialty.

45-49 Oliver Street, NEWARK, N. J.

Long Distance Telephone, 3759-R.

**JOHN S. STIVEN,**  
Gold and Silver  
Chaser.

Room 219, Electrical Exchange Building,  
136 LIBERTY STREET. NEW YORK.

**F. JEANDHEUR, Jr.**  
Rear 17 John St., N. Y. Third Floor.

**Gold and Silver Plating**  
SPECIAL WORK AND COLORING  
IN ALL SHADES A SPECIALTY.

Established 1868. **Platina Plating.**

Frank Dederick. *Established 58 Years.* James E. Dederick.

## James H. Dederick's Sons,

Assayers and Bullion Dealers.

All qualities of Gold and Silver, in Plate, Square and Round Wire, Rolled to any gauge.

ALL QUALITIES OF GOLD AND SILVER SOLDER.

16 Maiden Lane, .. .. NEW YORK.

*We buy Old Gold and Silver.*

**CASTINGS** Gold, Silver Bronze, Brass  
German-silver, Copper & Iron,  
Supply Jewelers, Silversmiths,  
Die-makers, Mould-makers, etc.

L. D. Tel. 2072 L.

Unbreakable Bronze Forces. Hard Bronze Engraving Plates. Cast Iron Forces for making Steel Dies. Chandelier, Undercut Work, Statuary.

**AUGUST GRIFFOUL,** 313 HALSEY STREET,  
NEWARK, N. J.

**THREE WEEKS' DELAY! YES, BUT MUCH HIGHER RETURNS!**

**ESTABLISHED IN 1870. LEES & SANDERS BIRMINGHAM, ENGLAND.**

**WE CAN SEND YOU NAMES ON YOUR SIDE**

**WE ARE NOT MERELY COLLECTORS BUT THE ACTUAL SWEEP SMELTERS**

**WHO HAVE TRIED US AND ARE SATISFIED**

HONEST AND

**PROMPT RETURNS FOR YOUR OLD GOLD, SILVER FILINGS, SWEEPINGS & C.**

**WE BUY**

Old Gold and Silver Filings, Polishings, Sweeps, Hand Washings, etc. We will make accurate valuations and hold consignment subject to your acceptance. If valuation is not satisfactory, we reship to you at our expense.

**WE PAY FOR OLD GOLD:**

22 K. 88c. per dwt.	12 K. 48c. per dwt.
20 K. 80c. " "	10 K. 40c. " "
18 K. 72c. " "	8 K. 32c. " "
16 K. 64c. " "	6 K. 24c. " "
14 K. 56c. " "	4 K. 16c. " "

MARKET RATES FOR SILVER AND PLATINUM.

**WE SELL**

Gold, Silver and Platinum, various qualities, rolled flat or drawn to wire of any gage.

**PRICES OF ALLOYED GOLD:**

10 K. 48c. per dwt.	14 K. 64c. per dwt.
12 K. 56c. " "	16 K. 72c. " "
18 K. 80c. per dwt.	

Gold and Silver Solder, either from formulas furnished or our own. "T. B. 11." Alloy, 25c. per oz. Guinea Gold, 75c. per lb. Shot Copper, 40c. per lb. We will send tables for alloying without charge. They save figuring.

*Try us and you will appreciate our Squareness, Promptness and Accuracy.*

**T. B. HAGSTOZ, Ltd.,** Main Office, 709 Sansom St., Philadelphia, Pa.  
SMELTERS, ASSAYERS, REFINERS.

**PLATINUM AMERICAN PLATINUM WORKS**  
NEW YORK OFFICE  
41 Cortlandt Street  
NEWARK, N. J.

# *Fahys*

¶ Fahys Cases are not manufactured by a trust or sold by any trust method.

¶ They are independent of any combination and are sold on their merits—hence their popularity.

JOSEPH FAHYS & CO



## The Way We Get on "Top"

is by cutting the diamonds ourselves. The way we keep it "going" is by selling the goods in the most inexpensive way.

If you want your business to reach the "top" notch of prosperity, don't pay out your good money for jobbers' profits and salesmen's salaries and expenses.

### J. R. WOOD & SONS

DIAMOND CUTTERS

2 Maiden Lane  
New York

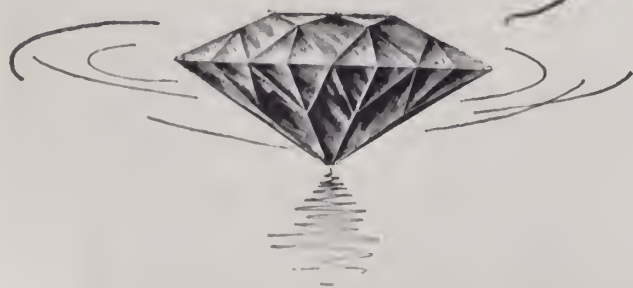



## Cupid Does Not Sleep

Consequently wedding rings are always in demand.  
Our wedding rings are the best that can be manufactured.

The prices we ask for them, the lowest.

Please bear this in mind, Mr. Retail Jeweler, the next time you order wedding rings.

---

**J. R. WOOD & SONS**

RING MAKERS

2 Maiden Lane

-

New York

# Warning to the Trade!



Retailers are being called upon by a man who is selling twenty-one chains on a cloth for \$18, with swivels stamped "S. O. B. & Co.," and with a duplicate tag of ours bearing our trade-mark, attached to same. The chains are nothing more or less than brass shaded over, and will not stand acid for a single moment.

Jewelers with any experience ought to be able to discover the difference between a finished article and a rotten one.

Anyone who has been swindled by this man will please notify our house, as we want all the evidence possible, and we will do the rest.

Localities where goods have been disposed of are Pittsburg, Allegheny, McKeesport and surrounding towns.

We have two chains now in our possession that were sold by this man.

S. O. BIGNEY & CO.

We give you below an exact copy of an assay of chains manufactured by the leading chain makers of the United States.

1-10 GOLD FILLED WATCH CHAINS, MINUS BAR AND SWIVEL.

Number	Gross Weight		Fineness	Value	Maker	Chain Number	Cost
	Ounces	Dec.	Gold 1000ths				
15		71	29½	\$0.43	S. O. Bigney & Co. - - - -	1155	\$2.85
16		75	50	.775		482	3.08
17		81	34	.57		3005	2.73
18		76	23½	.37		9533	2.97
19	1	00	16½	.34		83	2.14
32		52	49½	.53		213 X	2.83
34		73	34½	.52		733	2.41
46				.58		5011	3.82

1-8 CHAINS, MINUS BAR AND SWIVEL.

Number	Gross Weight		Fineness	Value	Maker	Chain Number	Cost
	Ounces	Dec.	Gold 1000ths				
35		57	68	\$0.80	S. O. Bigney & Co. - - - -	1604	\$3.96
36		60	65½	.81		7015	3.75
37		60	63	.78		4324	4.00
47		49	79	.80		2726	4.00



## S. O. Bigney & Co.

NEW YORK OFFICE,  
3 MAIDEN LANE.

FACTORY, Attleboro, Mass.

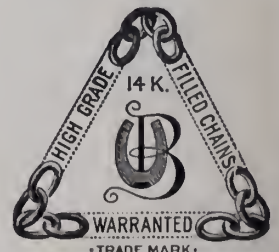



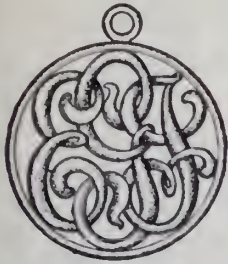

No. 301.



No. 302



No. 305



No. 308.



No. 300.



No. 3.



No. 18.



No. 11.



No. 14.



No. 18.



No. 317.



No. 306.



No. 196.



No. 307.



No. 318.



No. 209.



No. 322.



No. 208.

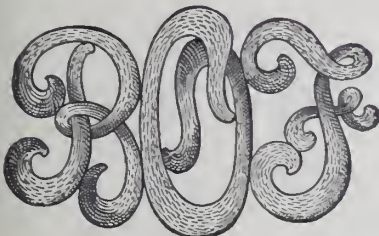

No. 316.



No. 321.



No. 320.

# Wendell & Company

MAKE

## GOLD MONOGRAM CHARMS, FOBS, SLIDES, BROOCHES AND RINGS.

SILVER MONOGRAMS for BROOCHES, BELT ORNAMENTS and CLASPS; also for LEATHER BAGS, PORTFOLIOS, MUSIC ROLLS AND ALL KINDS OF EBONY, IVORY AND TORTOISE SHELL GOODS.

ALL ORDERS PROMPTLY EXECUTED.

103 and 105 WILLIAM STREET } 2 FACTORIES: { 57 WASHINGTON STREET  
NEW YORK } CHICAGO

---

---

## Watch Case Satisfaction

---

THE MOST POPULAR CASES on the market, no doubt, are the 25-year lines. They fall within the class of "high grade" cases, which satisfy self-respecting men. Twenty-five years seems a reasonable time.

---

### The Wadsworth "Pilot" (25-year) Watch Case

*"A Quarter of a Century"*

---

WE INVITE COMPARISON between this line and other makes of 25-year cases—compare Shapes, Decorations, General Appearance, Prices, etc. Then use your own judgment and buy on business principles—on merit without prejudice.

---

---

### *The* Wadsworth Watch Case Co.

CHICAGO  
Columbus Building

SAN FRANCISCO  
717 Market St.

NEW YORK  
49 Maiden Lane

FACTORY, DAYTON, KY.



These illustrate a few of the dozens of New Patterns we



are making in our Pilot Cases for this Fall delivery



## The Wadsworth Watch Case Co.

CHICAGO  
Columbus Building

SAN FRANCISCO  
717 Market St.

NEW YORK  
49 Maiden Lane

FACTORY, DAYTON, KY.



?

?

?

Do the retail jewelers appreciate what they were paying for 12 Size movements before our 12 Size was on the market?

Do the retail jewelers appreciate what they were paying for O Size movements before our O Size was on the market?

Do the retail jewelers stop to consider what they would be paying for movements if there was not an independent watch company manufacturing a complete line of superior watches?

ILLINOIS WATCH COMPANY  
SPRINGFIELD

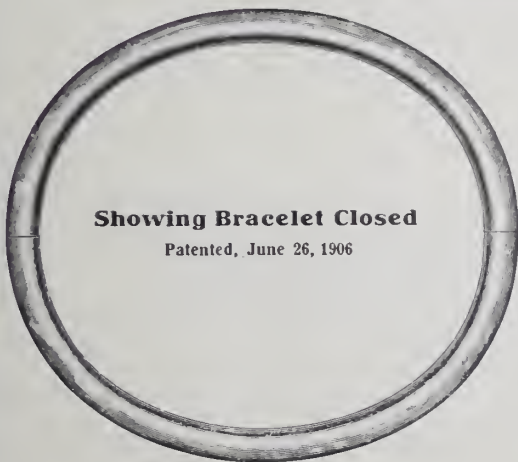

**Showing Bracelet Closed**

Patented, June 26, 1906

**DIRECTIONS**

To Open

Take hold in centre of both sides and pull evenly.

To Close

Press in from the centre of both sides evenly.

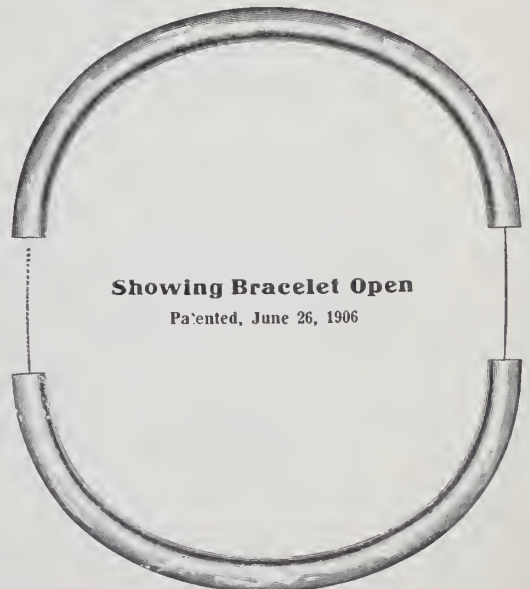

**Showing Bracelet Open**

Patented, June 26, 1906

**The  
"Hamilton"**

**The Most Popular Bracelet of the Day**

Adjustable Safety. No Hinges to Break. Slides on Steel Springs with Invisible Catches.

Made in Best Quality Gold Filled

**HAMILTON & HAMILTON, Jr., PROVIDENCE RHODE ISLAND**

## **Dueber Watch Cases**

### **Hampden Watch Movements**

“Dueber-Hampden” stands for honesty, integrity and consistency. Added to these qualities the talent and energy devoted to the development of

#### **DUEBER-HAMPDEN WATCHES**

have earned for them the enviable reputation of

## **The**

# **Leading American Watch**

Made in all sizes and sold only as complete watches in 3/0 size and 12 size, cased in solid gold and gold filled cases of the most artistic designs.

## **The W. J. JOHNSTON COMPANY,**

Wholesale Agents of the Leading American Watch Companies,

**Fifth Avenue and Market Street, Pittsburgh, Pa.**

# **The W. J. JOHNSTON COMPANY,**

Wholesale Agents of the Leading American Watch Companies,

**Fifth Avenue and Market Street, Pittsburgh, Pa.**

---

---

## **Hamilton Watches**

## **Illinois Watches**

Made to be sold by live, progressive, American Retail Jewelers who realize the credit to be gained from selling reliable, accurate time pieces.

---

---

Protection to the Retail Jeweler is the "watchword" of The Hamilton Watch Co. and The Illinois Watch Co., and every effort will be made to restrict the sale of these watches to the Legitimate Retail Jeweler.

# OLD RELIABLE

## W. & S. B. ★

We extend our greetings to the members of the American Retail Jewelers' Association and the American Association of Opticians, as they assemble in convention.

In view of some matters that are to be considered at both conventions, we offer the following suggestions :

Don't waste valuable time reflecting on the inroads made in your business by Department Stores and Retail Mail Order Houses. Buy the Old Reliable line and avoid this kind of competition. Our Old Reliable W. & S. B. ★ 1-10 and Globe Filled W. & S. B. ★ 1-8 chains are not sold to either Department Stores or Retail Mail Order Houses.

Bunch your buying. If you buy a little here and a little there you gain the regard of no one and your account has no value. Concentrate your purchases on the Old Reliable line and participate in the opportunities offered by our premium plan.

We invite your inspection of Old Reliable goods at our booth in the exhibition hall. We shall have some special things to show you and a very interesting booklet for you to read.

Old Reliable W. & S. B. ★

---

## W. & S. BLACKINTON CO.

Manufacturers

NEW YORK, 14 Maiden Lane

Factory, North Attleboro, Mass.

Let us send a selection package through  
any jobber you may designate.



*"We never follow the Fashion, the Fashions Follow Us."*

MAURICE L. POWERS.



JOSH W. MAYER.

## SPECIAL.

WE extend to the Jewelers of this country a most cordial invitation to our FOURTH ANNUAL EXHIBITION of Diamond Jewelry, to be held in our offices between August 13th and 18th inclusive.

During the past few months we have specified in this journal what this remarkable display will consist of and we desire to say that every statement will be fully verified by a wonderful exhibit of the most marvelous stock of mounted goods ever shown in this country; not alone in the enormous quantity, but in the wonderful variety of magnificent and exclusive designs. Jewelers will be shown the effects that will be worn during the season of 1906-7.

If you intend coming here during these dates, kindly advise us whether we can be of service to you in securing accommodations at any of the hotels or in any other way.

As the time is now approaching for this exhibition, we shall be very glad, indeed, to have you bear in mind to bring with you any odd stones you may have lying around in your safes, that you do not know what to do with. You will find here thousands of the newest and latest suggestions for mounting them, and they will become a source of revenue to your establishment.

Once a visit always a visit.

## POWERS and MAYER,

Makers of Diamond Mounted Jewelry THAT SELLS.

258-260 Fifth Avenue,  
NEW YORK.

We are always pleased to ship goods on memorandum when satisfactory references are given.

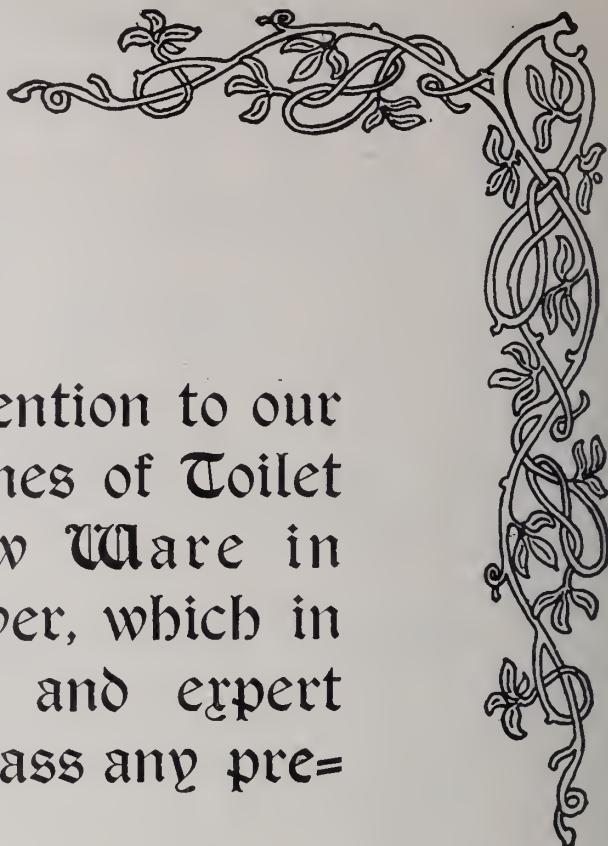

**W**E direct attention to our new fall lines of Toilet and Hollow Ware in sterling silver, which in artistic conception and expert craftsmanship surpass any previous display.

Owing to the novel character of our Toilet Sets we will be unable to show same until about July 20, but we are sure you will agree that these sets are a radical departure from anything heretofore attempted. They will be illustrated shortly on this page.

**Woodside Sterling Co.**

Silversmiths

192 Broadway, New York

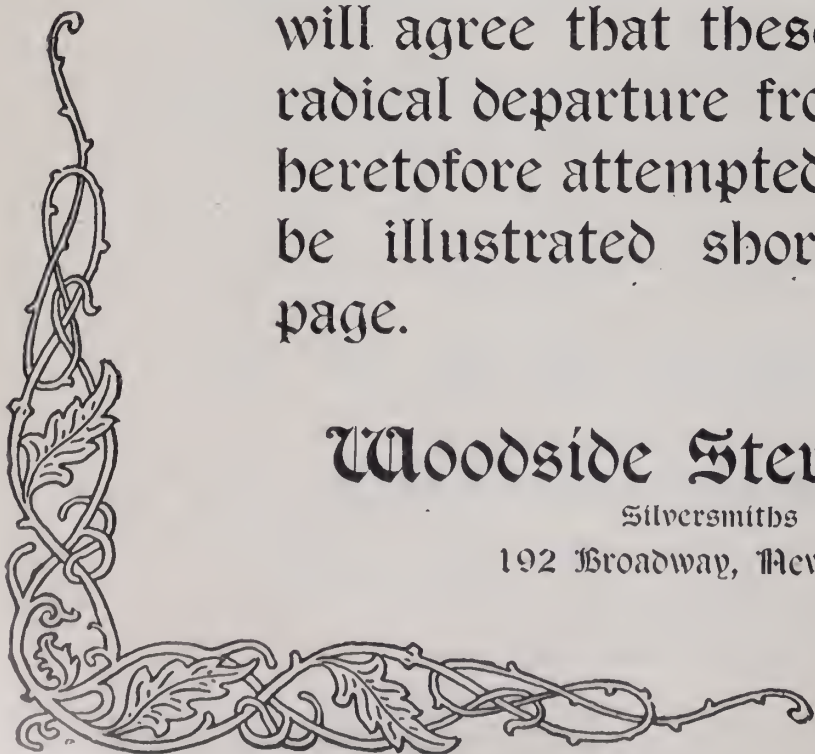

# The Adam Pattern



## AN ORIGINAL NOVELTY IN FLATWARE.

**T**HE WHITING COMPANY take pleasure in confidently directing the attention of the Jewelry Trade to the prepossessing qualities of their radically new departure in flatware design, now introduced as the Adam pattern.

**R**ECOGNIZING the insistent demand for a line of table silverware that shall fitly harmonize with the increasingly popular Adam Furniture and Decoration, the Company have originated a pattern designed in accord with the principles formulated by those celebrated Eighteenth Century architects, the brothers Robert and James Adam.

**A**FURTHER claim to consideration may be advanced on its behalf: The elegance of its form and the delicacy of its low relief ornamentation, emphasized by the simplicity of the back, unadorned save by the characteristic "swedge," combine to ensure its welcome by all people of taste and refinement.

**A**COMPLETE line of the Adam pattern, including Individual and Serving Pieces, is offered and ready for delivery Sept. 1st.

## The Whiting Mfg. Co.

SILVERSMITHS  
Broadway and 19th Street  
New York



# Our New Engraved Pattern

One of the three  
New and Artistic  
Effects  
that we are  
showing  
this season.



TRADE  MARK.

The demand for engraved effects in Toilet Ware and Manicure Sets of heavy weight is increasing. Our engraved pattern, as illustrated, was originated to meet the call of the coming season. The Mirrors and Hair Brushes are made in two sizes and may also be had in plain pattern, from which engraving is eliminated. A complete price list is ready for mailing, and we will be pleased to send it to you upon request.

*Card Cases*

*Photo Frames*

*Combinations in Toilet and Manicure Sets, arranged in handsome silk lined cases.*

*Baskets*

*Jewel Cases*

*Shirred Wrist Bags*

*Sterling Novelties*

## R. BLACKINTON & CO.

ESTABLISHED 1861

3 MAIDEN LANE, NEW YORK

FACTORY, NORTH ATTLEBORO, MASS.



Posed by Chorus from "His Honor the Mayor."

# THE CORRECT TIME

to inspect our extensive line of 10 and 14 Kt. Rings **IS NOW.** No superior assortment, quality, design and workmanship considered, has ever been shown than is contained in our present offerings. We ask your especial attention to our creations in **EMBLEM RINGS.** The official seal of every order artistically and prominently displayed. We are known as "The Emblem Ring House of the United States."



Send to-day for our New Illustrated Catalogue, showing Designs and Prices; it will be mailed promptly.

**L. W. RUBENSTEIN,** 54 Maiden Lane  
New York City

*If It Burns Alcohol We Make It*

# THE TOURING CHAFING DISH

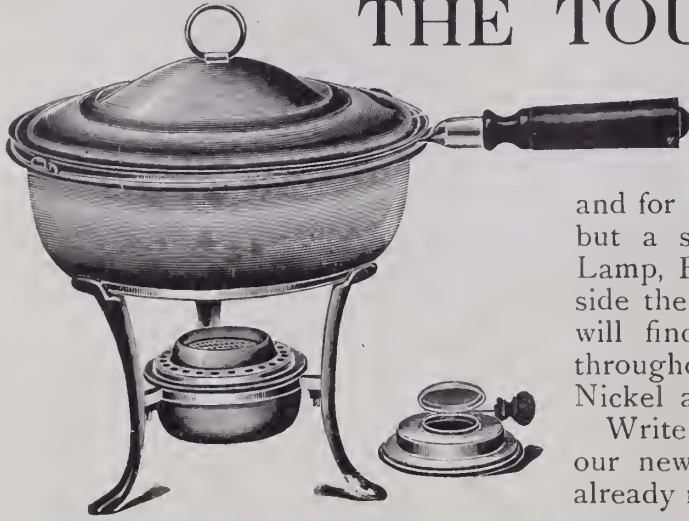

VIEW OPEN—READY FOR USE.

is especially adapted for travelers and for outings, as it is compact and occupies but a small space when closed. The Stand, Lamp, Extinguisher, Handle and Dish are inside the hot-water pan when closed. Jewelers will find this specialty to be a ready seller throughout the vacation period. Made in Nickel and Silver Plate.

Write us for further information. Send for our new catalogue, No. 21, if you have not already received it.

**S. STERNAU & CO.**

New York Salesrooms:  
Broadway, cor. Park Place,  
Opposite Post Office

*Makers of Coffee Machines, Chafing Dishes and their accessories, Trays, Smoking Sets, Fancy Kettles, etc.*

Office and Factory:  
195 Plymouth Street  
Brooklyn, N. Y.

## ASK YOUR JOBBER FOR *The Wonder of the Bracelet World*



PAT PENDING.

A Positive Secret Joint and Catch

MAKERS OF

- American Lever
- Cuff and Collar Buttons
- Scarf Pins
- Links
- Studs
- Fobs
- Erooches
- Handy Pins
- Hat Pins
- Chains

Satisfaction Guaranteed or New One Given in Exchange

ALL GOODS



BEAR THIS TRADE-MARK



PATENT PENDING.

**PARKS BROS. & ROGERS, Providence, R. I.**

Sole Agents for  
KREMENTZ ONE-PIECE COLLAR BUTTONS

New York Office, 20 Maiden Lane

# Smith Silverware.

The "Georgian" line of hand-chased Hollow Ware represents the very highest achievement of the most skilled Silver Workers. Like all Smith Silverware it is characterized by its dis-



TRADE MARK  
STERLING 925  
1000

distinctiveness of design, substantial weight and excellence of finish. Made in complete dinner service.

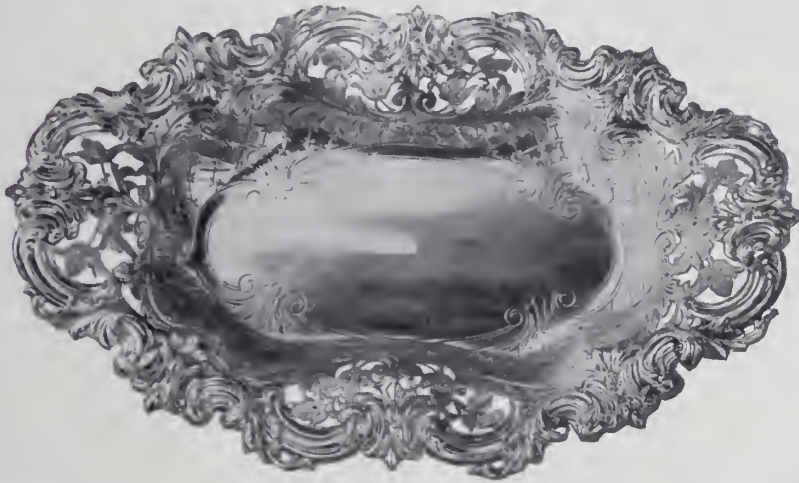

## FRANK W. SMITH CO.

Manufacturers of Sterling Silverware

Gardner Mass.



There is a great satisfaction in knowing you have the best production of the leading manufacturer.

The goods we make are designed by skillful artists and executed by expert workmen; besides, the prices are positively the lowest consistent, and the reputation of our house vouches for the quality.

Write for selection.

- |            |                |                  |
|------------|----------------|------------------|
| LOCKETS,   | CIGAR CUTTERS, | FOBS,            |
| BUTTONS,   | PENKNIVES,     | TIE CLASPS,      |
| BRACELETS, | MATCH BOXES,   | HEART CHARMS,    |
| BROOCHES,  | SCARF PINS,    | BEAD NECKS, Etc. |



No. 800. No. 801.



No. 804. No. 805.

**10K. that is 10K.**

# ROBT. LEVY,

Manufacturing Jeweler

Green and Columbia Sts., Newark, N. J.

# THE Bracelet Hit OF THE Season.



THE illustrations, which are exact size, show two of the best selling Bracelets of a big bracelet season.

Made of Rolled Plate, Pierced, Engraved—a neat, strong joint and catch—with and without stones, from 1/2 to 1 1/4 inches wide.

Our line offers an unsurpassed range of styles.

ASK YOUR JOBBER—HE HAS THEM.

**WHITING & DAVIS, Plainville, Mass.**  
NEW YORK OFFICE, 7 MAIDEN LANE.

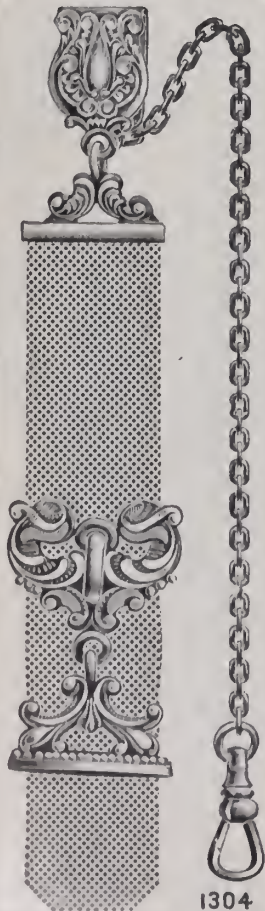

1304

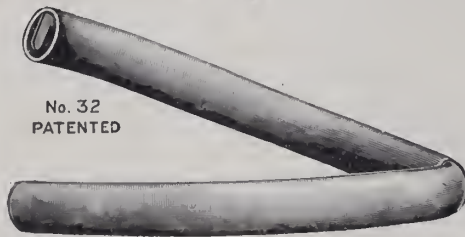

No. 32  
PATENTED

## The New "Bates" Bracelets

"Kant-Kum-Off"  
Made in Seven Sizes

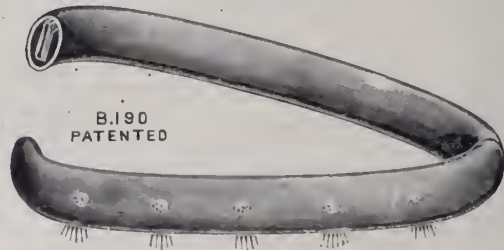

B.190  
PATENTED

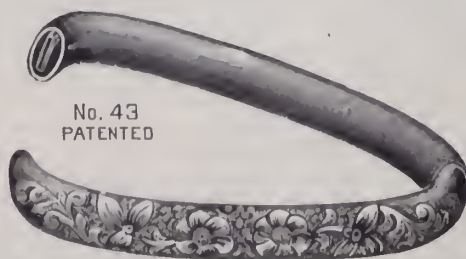

No. 43  
PATENTED

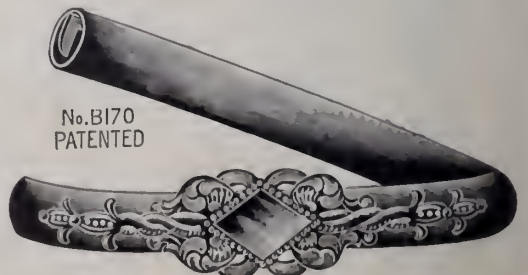

No. B170  
PATENTED

# BATES & BACON

Attleboro, Mass.

Makers of HIGH GRADE CHAINS

The BEST SAFETY FOB is one of our specialties; Gent's Vests, Dickens, Lorgnettes, Secret Locket Chains, Lockets and Chatelaines.

OFFICES:

NEW YORK,  
9 Maiden Lane.

CHICAGO,  
103 State Street.

Ask your jobbers for THE BATES BRACELETS and you get the BEST





# Tortoisene Combs

Mounted with 10-K. hand-work patterns. Every design is characteristic of originality and every detail is significant of superior workmanship.

*Tortoisene* is hard to detect from the real tortoise shell, having a rich effect that pleases the most skeptical in artistic hair treatment.

This cut represents a few of our patterns, actual size.

Combs will be much in demand throughout the year and orders should be in advance to insure prompt attention.

Prices on request.

## Schultz, Leiss & Co.

OFFICES

New York, 14 John St. Chicago, 103 State St.

FACTORY

Cor. McWhorter and Oliver Sts., Newark, N. J.



**T**HE hum of industry is heard throughout the land and especially in the jewelry factories. They are busy turning out our new lines for the Fall Season and the results will be a source of surprise to those of the trade who do not fully appreciate our ability in this direction and a matter of course to our regular customers who expect better stocks from us each season. This expectation we usually live up to and for the Fall of 1906 we have managed to increase our lines of "Sellers" in Jewelry and Watches so that we may truthfully say that they are "The Best Ever."

If one of our representatives does not call on you we shall be pleased to send a selection package.

Our trade-mark "The Rose"  stands for excellence and our guarantee and established reputation of over forty years are back of same.

## HENRY FREUND & BRO.

Diamonds, Watches and Jewelry

Elk and F. O. Eagle Goods a Specialty

71 Nassau St.,

NEW YORK





Quality and Finish Consistent  
with twenty years' experience.  
Original and Exclusive Designs.

**MOORE & SON,**  
ESTABLISHED 1886. NEWARK, N. J. INCORPORATED 1903.



**Standard American  
Watch Movements  
Speak for Themselves**

Our efforts to please have resulted in an endorsement of the adage, "Play fair, and win confidence at least." It has always been our aim to carry the best at a reasonable price, and to protect our customers in every way.

**"We cover the country"**

From our  
New York Office:  
H. OLLENDORFF  
M. OLLENDORFF  
H. GOLDSTEIN

From our  
Pittsburg Office:  
W. S. BICKART  
J. S. BICKART  
W. E. PARISH  
S. A. REUTER

**Special Southern Representative:  
O. J. SOMERS.**

The above salesmen are on the road at present, and one of them may call upon you in the near future. If so, examine his line; it will repay you. Or send us your order for your immediate wants; it will receive our usual prompt and careful attention.

**I. OLLENDORFF CO.**  
JOBBER IN  
Watches, Diamonds and Jewelry  
NEW YORK PITTSBURG, PA.  
54 Maiden Lane Cor. Liberty Ave. & 6th St.  
ESTABLISHED 1868.

**"TOPPY AND ORIGINAL"**

Bracelets Handy Pins  
Barrettes Scarf Pins  
Brooches Pearl Snaps  
A & V  
Pendants  
Collarettes

**ALLSOPP AND ALLSOPP**  
'PHONE 4075W  
18 COLUMBIA ST. NEWARK, N. J.

**Geo. O. Street & Sons.**



We have been identified with the making of fine 14 karat jewelry since 1837. Our specialties—Seal Rings, Sleeve-links, Fobs and Seals.

24 John St., New York.  
103 State St., Chicago.

TRADE  MARK

**CASSIUS W. SEYMOUR,**  
37-39 Maiden Lane, New York.  
ALLOW ME TO CALL ON YOU IN THIS WAY



**Jewelers'  
Stationer and Printer**  
Jewelers' Cards,  
Tissue Paper,  
Tags,  
Blank Books, etc.

**ROLL AND FLAT PAPERS**  
Estimates cheerfully given. Mail orders promptly attended to. Let us quote you our prices on manifold books and sealing wax

GOLD  
RINGS

BROOCHES AND MOUNTINGS

Also GOLD FILLED RINGS, including the popular THREE CROWN

Ostby & Barton Company respectfully announce to the jobbing trade that their fall line comprising many new and original designs is now ready.

OSTBY & BARTON COMPANY

New York, 13 Maiden Lane  
Chicago, 103 State Street

PROVIDENCE, R. I.

The "Bryant" Rings.

WE have made the **Bryant Rings** for 50 years, and know how to make first class goods. The stone setting—which every retailer knows is a very important part of the work—we give special attention to. The **Bryant Rings** will help your reputation as a first class Jeweler.



TRADE-MARK.

M. B. BRYANT & Co., No. 7 MAIDEN LANE,  
NEW YORK.

The Bowden Rings

ARE COMPLETE IN VARIETY, CORRECT IN  
QUALITY AND PERFECT IN FINISH. WE  
MAKE EVERY VARIETY OF FINGER RINGS.

J. B. BOWDEN & CO.,

1 Maiden Lane.

NEW YORK.

# finest Mountings at fair Prices



THE REPUTATION of Durand Mountings reflects their decided superiority. Priced at lowest figures consistent with quality. For example:

- Ring Mountings, - from \$3.75 up.
- Sleeve Link Mountings, " 6.00 "
- Lorgnette Chain Mountings, " 20.00 "
- Brooch Mountings " 6.00 "



**Durand & Company,**

49-51 Franklin Street,  
Newark, N. J.



## A COMPLETE LINE

of some of our handy pins. Made in all colors, sizes and finishes.

**A. J. HEDGES & CO.,**

Makers of Exclusive Designs in 14k. Jewelry.  
14 JOHN STREET, NEW YORK

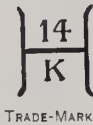

## Adjustable Glove Garters

IN GOLD AND SILVER

### Gold Jewelry

14K. in 10K.

Plain, Chased, Engraved, Diamond Set

- BRACELETS, BROOCHES,
- LINKS, LOCKETS, ELK
- BUTTONS, ETC.

**Chas. L. Trout & Co.,**  
15 MAIDEN LANE, NEW YORK.



## OSMUN-PARKER MFG. CO.

MAKERS OF

*Fine Pearl and Diamond Goods*

338 Mulberry Street  
NEWARK, N. J.

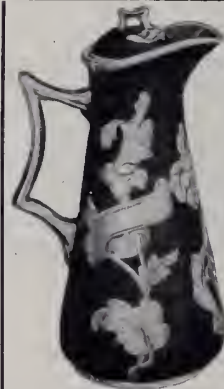

### Supremacy in Silver Deposit Ware

Illustration shows our new Chocolate Pot, of Silver Deposited Frost Ware in Cobalt Blue. The design and workmanship of our line have never been equalled.

12-in. high, \$19.50

### Deposit Ware Exclusively

Representative Jewelers are invited to send for a selection of

- FANCY BASKETS, CHOCOLATE SETS,
- WHISKEY JUGS, EXCLUSIVE NOVELTIES, ETC.

### DEPASSE MFG. CO.

41-43 Maiden Lane, New York

#### THE CROWN PATENT SAFETY GUARD



For Scarf Pins and Studs and Lace Pins. The most practical and only adjustable one invented. Price, \$1.50 per doz. For sale by all wholesale jewelers and material houses. Sample by mail, 25c. In 10k. gold, \$1 00; 14k., \$1.25. M. CROWN, Maker and Inventor, 43 and 50 Maiden Lane, N. Y.

ESTABLISHED 1871.

Factory and Office: Newark, N. J.

INCORPORATED 1900.

## CARRINGTON & CO.,

### Patent Pocket Match Box



Book Safety Matches with Steel Cigar Cutter. (Patented.)

Sales Agent:

7 Maiden Lane, NEW YORK.



14K. ONLY IN STOCK



**SOLID GOLD CHAINS EXCLUSIVELY**

The best workmanship, plump quality, most attractive designs and very lowest prices are characteristic of our **SOLID GOLD CHAINS**



For 56 years exacting Jewelers have found our Chains ready sellers, very profitable to handle and most durable in service.

We have no salesmen, and our prices are therefore very low. We will be pleased to send you a selection package.

1850 1906

**ALOIS KOHN & CO.**

Makers of

**SOLID GOLD CHAINS**  
of every kind.

16-18 Maiden Lane  
New York

**BRACELETS**

In addition to my line of Mountings, Lockets and Buttons, I am making a full line of 10 and 14 K. Gold Bracelets.

Can make to order any style and size Bracelet at very short notice.

**M. SCHIFF,**  
82-84 Nassau St., New York.

Established 1876.

'Phone, 801 John.

**WHITESIDE & BLANK Bangles**



This house has now placed upon the market for their Fall trade a line of Bangles and Bracelets.

In this, as in their long established lines, the jewelry critic will find, both in character of design and unique mode of construction, features strikingly unusual when compared with anything heretofore shown in arm ornamentation.

*Platinum and Diamonds.*

*Rose Gold and Fancy Stones.*

NEWARK, N. J.,  
Lafayette and Liberty Streets.

NEW YORK,  
14 and 16 John Street.

ESTABLISHED 1841.

**Carter, Howe & Co.**

TRADE MARK

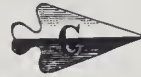

MANUFACTURERS OF

**Gold Jewelry,**

9, 11, 13 MAIDEN LANE, - NEW YORK.

FACTORY, NEWARK, N. J.

A. CARTER.

G. R. HOWE.

W. T. CARTER

W. T. GOUGH

"THE BRACELET HOUSE."

**KENT & WOODLAND,**

BRACELETS FOR EVERY WOMAN AND MISS.

16 John Street, New York.

San Francisco Office,  
Care JULIUS A. YOUNG.

"Nethersole Bangles,"  
Plain and with Stones.

"Pinhole" Secret Snap,  
with and without pre-  
cious and semi-precious  
stones.



# S. Cottle Co.

GOLD AND SILVER BAGS  
AND PURSES, NEW STYLES  
AND DESIGNS—ALL OF  
SUPERIOR WORKMANSHIP.

31 East 17th Street,  
New York.

## Bridesmaids' and Ushers' Pins

We would suggest something with color. Brooches, Scarf Pins and Handy Pins with Amethysts, Topazes, Garnets, Peridots, Aquamarines, Jades and Baroque Pearls. We have a large variety of patterns at moderate prices.

REGARDING OUR FOBS WE HAVE NOTHING TO SAY—  
THEY SPEAK FOR THEMSELVES.

## SNOW & WESTCOTT,

Makers of Good Jewelry for Over Seventy Years,

21 MAIDEN LANE, NEW YORK.



OUR BUYERS have just returned from European markets which they have ransacked in search of novelties for the jewelry trade.

Our line of FANS for the coming fall possesses such charm that it will satisfy the most exacting buyer.

We also present the latest Novelties in

BROOCHES  
MOUNTED COMBS  
NECKLACES  
CHAINS  
BUCKLES, Etc.

A call at our show-rooms is imperative to a visiting buyer.

### LEWY & COHEN

IMPORTERS,  
530 BROADWAY, NEW YORK

## SAM'L BUCKLEY & CO.

English Fancy Goods.



Carry in New York a full line of  
ENGLISH PLATED WAITERS.

118-122 Holborn, E. C.,  
London, England.

100 William St., New York.

ADOLPH LUTHY.

PERCY W. HINE.

## LUTHY & HINE,

13 EAST 30TH STREET, - NEW YORK.

MANUFACTURERS OF

### Artistic Gold and Platinum Mounted Diamond Jewelry.

Odd and Exclusive Patterns in NECKLACES, BROOCHES, BRACELETS,  
RINGS, RIBBON COLLARETTES, Etc.

MOUNTED WITH AQUAMARINES, PERIDOTS, AMETHYSTS  
AND OTHER PRECIOUS STONES.

(DIAMOND MOUNTED COMBS A SPECIALTY.)

## DESIGNS For Silverware, Novelties and Jewelry . . . FINE ETCHING

We etch sports, figures, animals, scenes, etc., on silver.  
Veritable works of art, at a reasonable price.

CHARLES M. PRIOR (PHONE 1224 HARLEM) 1683 Madison Ave., New York

## CROUCH & FITZGERALD



### Jewelry Trunks and Cases

177 Broadway,  
Bet. Cortlandt  
and Dey Sts.

688 Broadway,  
723 6th Ave.,

New York.

# The Salable MOUNTING



Pat. Oct. 24, 1905.

It gives light and brilliancy to the stone

- EARSCREWS
- EARRINGS
- STUDS
- SCARF PINS
- and RINGS

of every description made in Platinum, 18k., 14k., all sizes.

**Julius Wodiska**  
40 John St., New York

Manufacturer of a general line of

**PLATINUM**  
18k. and 14k.  
**MOUNTINGS**

Prompt attention given to special order work.

Estimates and designs submitted.

Diamonds recut and repaired.



## THE SEASON'S FOREWORD

**Day, Clark & Company**

14 KARAT ONLY



23 Maiden Lane New York

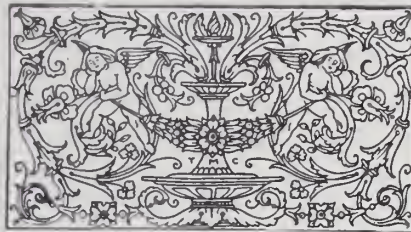

THE FIRST STEP in wise selection of your stock for the Fall Season is to look over the new showings made by this house.

The Trade is familiar with our distinctive specialties. In these lines comparison is challenged. You will find them richly inviting—sure prophecies of demand.

There is artistic effectiveness in every item. They will do you credit and be profitable.

## The Comb House

We manufacture a complete line of

**FINE MOUNTED COMBS**

in 14 K., 10 K., Sterling Gilt and Gold Filled.

Also all kinds of PLAIN, REAL and IMITATION TORTOISE SHELL COMBS.

Selection Packages sent to Responsible Jewelers.

**Wagner Manufacturing Co.**

41 Union Square,

Repair Work a Specialty.

**New York.** Factory, Lorimer St. and Throop Ave., B'klyn, N. Y.



## JAM KETTLE

of Silver Deposit on Crystal Glass.

A decidedly attractive and appropriately ornamented item in a big line noteworthy for its variety and the beauty, originality and workmanship of every article comprising it. Write for particulars.

**LACKNER & OHL**

Manufacturing Silversmiths

OFFICE AND FACTORY:

50-55 Columbia Street NEWARK, N. J.

10K ® 14K



**THE LOCKET HOUSE**

**ROTHSCHILD BROS. & CO.**  
51-53 MAIDEN LANE, N.Y.

An Unlimited Line of Patterns of

LADIES' LOCKETS  
MEN'S LOCKETS  
LOCKETS FOR EVERYBODY

UNMOUNTED  
MOUNTED WITH  
DIAMONDS  
OR ROSES

BROOCH MOUNTINGS  
LINK BUTTONS  
BRACELETS  
RIBBON FOBS

EVERYTHING IN LOCKETS AND CHAINS.

THE BASSETT JEWELRY CO.,  
PROVIDENCE, R. I.

**TIE CLASPS  
LAPELS**

OUR new line shows many designs, highly artistic and attractive, that will prove rapid sellers

The highest class of workmanship is characteristic of all our lines.

- Combs
- Baby Pins
- Brooches
- Crosses
- Scarf Pins
- Walst Sets
- Bracelets
- Hat Pins
- Barrettes
- Collarettes
- Buttons
- Silver Novelties



TRADE MARK  
**ALWAYS ON THE GO**

LOOK FOR THE TRADE-MARK

**MILLER, FULLER & WHITING, MANUFACTURING JEWELERS**

N. Y. Office, 9-11 Maiden Lane

NORTH ATTLEBORO, MASS.

**Boxes and Trays**  
THAT GIVE  
**SATISFACTION**



Velvet, Plush and Morocco Cases of Every Description for **JEWELRY and SILVERWARE.**

Special Cases Made to Order.

We make a Specialty of Fine Blocks and Stands for **WINDOW DISPLAY.**

Travelers' Trays and Cases in all Sizes.

Paper Boxes, Tags, Cards, Cotton, etc.

Visiting Buyers will find it advantageous to inspect our stock while in town.





**Wolfsheim & Sachs**  
35 MAIDEN LANE  
NEW YORK

Factory  
10 GOLD ST.

Telephone  
3518 John

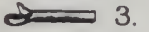

-  1. Snap complete.
-  2. Outside of Snap.
-  3. Inside of Snap.

## The E. P. H. Patent NON-PULL-OUT Neck Chain Snap

*Is a patented snap that insures the wearer against loss of*

**CHAIN or CHARM**  
for it positively will not pull out

Made in 10 and 14 Karat Gold and  
in Gold Filled.

Can be had of the following Wholesale  
Selling Agents:

- Messrs. W. Green & Co.,  
81 Nassau St., New York.
- |                           |                   |
|---------------------------|-------------------|
| M. Sickles & Sons,        | Philadelphia      |
| E. A. Cowan & Co.,        | Boston            |
| E. & J. Swigart,          | Cincinnati        |
| Swartzchild & Co.,        | Chicago           |
| Nordman Brothers,         | San Francisco     |
| Leonard Krower,           | New Orleans       |
| A. Walker Co.,            | Providence, R. I. |
| Bauman-Massa Jewelry Co., | St. Louis         |

**PRICES.**

- 14 Karat—Small, \$7 per doz. net
- Large, \$7.50 per doz. net
- 10 Karat—Small, \$6 per doz. net
- Large, \$6.50 per doz. net
- Gold Filled—Small, \$2 per doz. net
- Large, \$2.25 per doz. net

## THE WASHBURN SECURITY                      MAGIC NUT Automatic Holder            for ear studs, scarf-pins, for all sizes of scarf-            etc. pin wire. Guaranteed.



**EAR WIRES**  
for unpierced ears.



**SAFETY CATCH**  
For brooches, etc.  
Can be applied to any  
work where pin tongues  
are used.

Open.            Closed.            Open.            Closed.

Descriptive Circular on Application.  
Pearl Drilling and Adjusting a specialty.

Special Order Work and Repairing.  
C. IRVING WASHBURN, 12-16 John St., N. Y.



**Try Wells' Perfect Ring Adjusters**  
1 doz. asst. sizes 10k gold filled (gold on  
front twice as thick as on back), \$2.00.  
1 doz. asst. sizes solid 10k gold, \$3.75.  
1 doz. asst. sizes metal, 85c. Ask your  
jobber for them, or I will send, prepaid,  
at once (only on receipt of price), two  
samples—one small and one medium  
large gold filled and one metal adjuster  
for 50c. Address

CHESTER H. WELLS, Jeweler Meshoppen, Pa.

# About Clinching Sales.



*When a customer of taste,  
but slender purse, looks at  
a pretty 14K. Brooch, at  
\$5.00, and can afford to  
spend only \$3.00—and will  
not consider your regula-  
tion 10K. goods—you must  
not let her say that she  
will wait, etc., etc.*

*Be prepared for these frequent  
emergencies by carrying the most  
modern 10K. line on earth,  
and clinch all sales.*



Camp and Orchard Streets, NEWARK, N. J.

## HEINTZ BROTHERS.



• We Make the Largest Line of Solid Gold Set Rings in America for the Retail Trade •

# "THE" MACHINE for TAGGING RINGS, &c.

PRICE COMPLETE  
**\$5.00** Net

Hand Pliers are useless for Tagging Rings

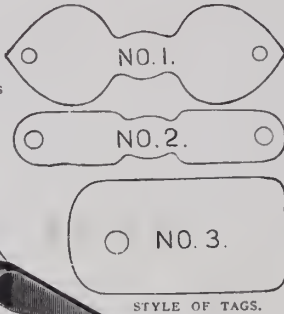

STYLE OF TAGS.

COMPLETE OUTFIT CONSISTS OF

**Our Eyelet Machine**  
**1000 Celluloid Tags**  
**1 Bottle Ink**

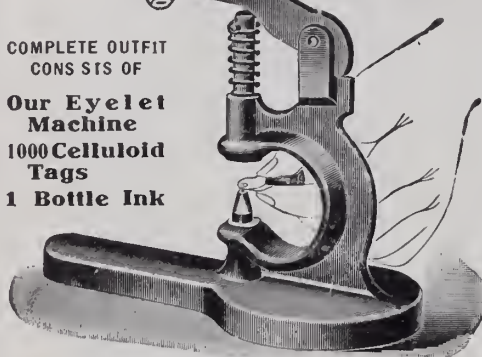

Patented June 16, 1906.

# The HOLD-ON CLUTCH

BEST  
SAFEST  
SIMPLEST

YOU slide the  
Clutch on—  
IT does the rest.

A SPLENDID  
SELLER,  
RETAILING AT  
50 CENTS

Patented May 20, 1902

SCARF PIN INSURANCE



ASK YOUR JOBBER OR WRITE TO

**HOLD-ON CLUTCH CO. 33 GOLD STREET, NEW YORK**

# Salosico Ware

WEATHERED OAK  
Silver Plated Trimmings and Lining



Style 17,  
List \$10.00

We make an extensive line of these goods. Complete assortment at our New York Office, 25 W. Broadway.

SEND FOR CATALOGUE

**St. Louis Silver Company**  
St. Louis, U. S. A.

# The W. F. Feeley Company

JEWELERS AND SILVERSMITHS      ECCLESIASTICAL ART METAL WORKERS  
Providence, Rhode Island

Chalices, Ciboria, Croziers, Candelabra, Candlesticks, Reading Desks, Pulpits,  
Sanctuary Rails, Altar Lamps, Memorial Tablets, Medals, and

# The Rosary in Fine Jewels

Real Stone

Gold and Rolled  
Gold-Plate  
Mounting

Amethyst    Garnet  
Crystal      Jet  
Goldstone    Topaz  
Carnelian    Tigerseye

Our New Catalogue  
ready for  
distribution

Copy mailed on  
request

Memorandum pack-  
age on selection



Imitation Stone  
Rolled Gold-  
Plate Mounting

Amethyst    Garnet  
Crystal      Jade  
Carnelian    Jasper  
Cat's-eye    Jet  
Emerald      Lapis  
Moonstone    Opal  
Onyx          Pearl  
Rose          Sapphire  
Turquoise    Topaz

# (SIGNS)

WE make the kind that peo-  
ple notice. Silent speakers  
that are always telling about  
you. Fac-simile of signatures  
sawed from metal for cement-  
ing to windows. "No trouble  
to ship out of town."

**THE FORMAN CO.**  
**SIX LIBERTY PLACE**  
NEAR MAIDEN LANE - NEW YORK



# ELK TEETH

Unmounted, genuine. Bought of  
Indians, 10 to 300, as needed,  
sent on selection to responsible  
Jewelers at strictly wholesale  
prices; also

**EAGLE, MOUNTAIN LION  
AND LYNX CLAWS.**

**L. W. STILWELL,**  
**DEADWOOD, - SOUTH DAKOTA.**  
Wholesaler of Sioux Indian Bead-Work and  
Curio Supply Jobber.

# The ST. JAMES

Corner Walnut and Thirteenth Streets  
PHILADELPHIA, PA.  
**The Ideal Hotel of Philadelphia**  
European Plan    EUGENE G. MILLER, Mgr.

**Trade-Marks** of the Jewelry and  
Kindred Trades.  
Second Edition. Price, \$3.00. The Jewelers' Cir-  
cular Publishing Co., 11 John St., New York.



**THE TRADE**

desirous of keeping in touch with modern, profit-producing methods, should always consult the 500 pages of

**OUR BIG CATALOGUE,**

with its 30,000 illustrations and long list prices. We send this splendid book free on request.

*S. F. Myers & Co.*

Headquarters for Dueber-Hampden Watches.

WHOLESALE JEWELERS

The New S. F. Myers Bldg. 47C-49 Maiden Lane New York.



Ladies' Fancy Stone Rings and Stone Scarf Pins in 10K. that defy competition.



Our reputation for making the finest and most complete line of 10-K. gold band rings is still maintained—ask your jobber.

**THE**

**EDWIN LOWE & CO., Inc.**

F.W. BODWELL, V.-Pres. and Gen. Mgr.,

116 Chestnut St., PROVIDENCE, R. I.  
New York Representative, E. T. Wilson, 180 Bway.  
Western Representative, S. H. Brower.

**CHAINS**

Gold Filled—Gold Plate—Fire Gilt

**S. & B. Lederer Co.**  
35 Years Manufacturing

11 Maiden Lane Factory: 131 Wabash Ave.  
New York Providence, R. I. Chicago

**RINGS**

**WM. LOEB & CO.**

101 Sabin St.,

Providence, R. I.

New York Office, 37 Maiden Lane.

**Koshland & Italic Co.**

702 Chestnut Street, PHILADELPHIA, PA.

¶ Not how **CHEAP** but how **GOOD** is the principle we follow in selecting the goods we offer for sale.

**Diamonds, Watches and Jewelry**



**D**AY by day we are adding new sellers to our line. Here are a few of them. Write us when in need of Rings and Diamond Mountings.

Seeing is believing; therefore, if you will be convinced do not fail to see our line when our salesmen are in your territory and afford you the opportunity.

**Ross, Saltman & Anderson**

89 Fulton Street, New York

**AT LAST!**

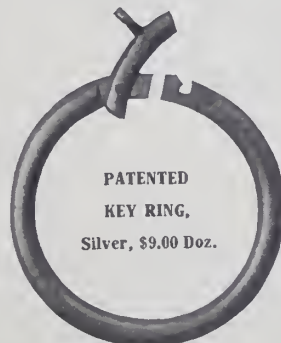

PATENTED  
KEY RING,  
Silver, \$9.00 Doz.

**KEY RING PROBLEM SOLVED!**

**T**HE ring illustrated herewith does the trick. You can put on and take off one dozen keys in less time than you could take one off any other make. We can also supply patent key rings in 10 and 14K. gold.

See our fall line before you place your order for Sterling Silver, Picture Frames, Card Cases, the new style Pocket Book, Toilet Ware, Manicure Articles, Buckles, Jewel Cases, Child's Cups and other hollow ware.

**PRYOR NOVELTY COMPANY**

New York Office: 7 Maiden Lane

Factory and Office:  
473-475 Washington Street, Newark, N. J.

# \$ LOCKET \$

## INSURANCE

Buy Better Than The Best  
**"VERIBEST"**

The Best Show of the Season

NOT WHAT WAS  
 BUT WHAT IS.

The Insurance-Mark

For the Policy Mark  
 look inside locket for



**THAT INSURES**

"VALUE FOR VALUE"

Sales, Quality, Perfection, Re-Orders.

Each Locket stamped  
 on the inside



Insist on "Star Quality,"  
 this Trade-Mark



MADE IN HIGHEST GRADE GOLD FILLED QUALITIES  
 For the Jobbing Trade Exclusively.

## S. & B. LEDERER CO.

NEW YORK CITY  
 9-11-13 Maiden Lane

Providence, R. I.  
 100 Stewart St.

CHICAGO, ILL.  
 131 Wabash Avenue

# ORDERS PROVE OUR GOODS SELL

We make for the Jobbing Trade the following lines  
 of Solid Gold Jewelry :

*Rings, Scarf Pins, Studs, Brooches, Charms,  
 Baby Pins, Handy Pins, Chain Scts,  
 Link Buttons, Hair Barrettes,  
 Crosses, etc.*

Insist upon seeing the designs of Gold Jewelry  
 made by the

## E. L. SPENCER CO.

95 Chestnut Street,

PROVIDENCE, R. I.

New York Office, 9-11-13 Maiden Lane.

SAMPLES ONLY.



# W

ait

And See

In the "Celebrated Case"

This Season's New Goods.

Every one a Seller

# T

here

Have always been

Reasons:—

Established reputation,

Staple Patterns,

High Quality,

Endless Variety,

Right Prices,

'  
 Square Dealing.

# G O O D S S E L L

## Waite-Thresher Company

61 PECK ST., PROVIDENCE, R. I.

7 Maiden Lane,  
 NEW YORK.

1203 Heyworth Bldg.  
 CHICAGO, ILL.

# Locket

Men wear them only on a watch chain, but men are easily pleased. 'Tis a woman's adornment, and the P. & B. Co.'s Line is replete with new goods that satisfy her exacting nature.



We are the largest exclusive makers of 10 Karat jewelry

Plain ones suitable for monogram and fancy designs that are odd, and not found in other lines.

Ask your jobber for our lines of

Cuff Buttons, Baby Pins, Tie Clasps, Fobs, Scarf Pins, Locketts, Bead Necks, Hat Pins, Bracelets, Waist Sets, Brooches and Crosses.

**Potter & Buffinton Co.,**  
**Providence, R. I.**

New York Office,  
 65 Nassau St.

San Francisco Office,  
 206 Kearny St.

**NORMA**  
 TRADE MARK

The New  
**NORMA**

*Patented Adjustable Bracelets*



Examine our Popular Prices ranging from

**\$16.50 to \$36.00**  
 per dozen

The illustrations represent a few of the many styles we make

THE QUALITY OF ALL THESE GOODS IS FULLY GUARANTEED

Send for our new illustrated booklet of patterns and prices

MADE ONLY BY

**The F. H. Sadler Co.**

80 County Street

ATTLEBORO, MASS.

Address all communications to  
 Attleboro, Mass.

N. Y. Office, 180 Broadway  
 Room 43

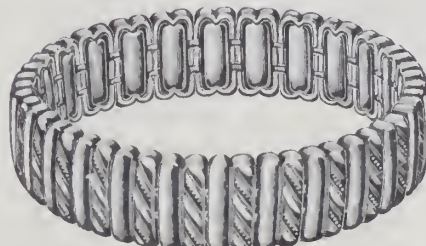

No. 253.



No. 265.



No. 254.

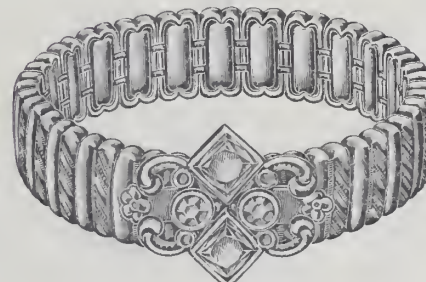

No. 271.

**NORMA**  
 TRADE MARK

**EGYPTIAN PEARLS**

—  
FINEST  
OF  
ARTIFICIAL  
PEARLS.

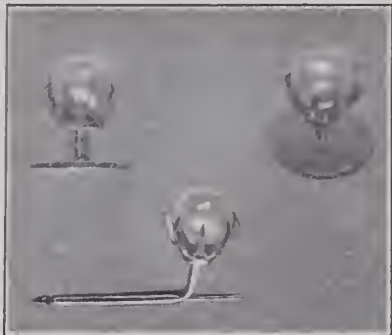

**EGYPTIAN PEARLS**

—  
MOUNTED  
IN  
POPULAR  
JEWELRY.

**T**HE PEARL has always symbolized Beauty and Value. Nature's product is most closely approximated in the handsome "EGYPTIAN" Pearls. The iridescence, weight and color of natural Pearls are retained; and inspection of the "EGYPTIAN" Pearls will demonstrate their pre-eminence. The results attained are possible only by a special process, supplemented by expert workmanship. The articles of Jewelry to which "EGYPTIAN" Pearls are applied are artistic creations meriting your attention.

**GEORGE H. CAHOONE COMPANY,**

Makers of Artistic Jewelry,

PROVIDENCE—7 Beverly Street.

NEW YORK—9 Maiden Lane.

**The REX Cuff Button**

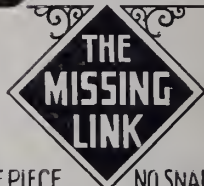
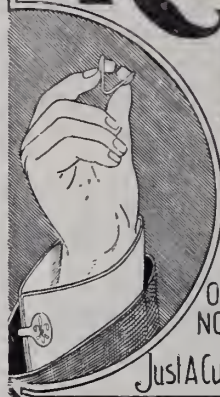

ONE PIECE NO LEVER NO SNAP NO SPRING

Just A Cuff Button That Cannot Break

Shipped in individual cartons holding 1 doz. pairs. Ask your jobber for them; if he does not supply you, write us. Sample pair furnished jobbers on request.

**E. E. STANINGER**

Sole Manufacturer

Hartford Bldg.

CHICAGO, I. L.

**The Kenilworth Bracelet.**

(Patented Jan. 2, 1906, No. 808,805.)  
No. 4086.

A success beyond our expectations. Its simplicity of operation in putting on or taking off, "having no catch or snap," commends it to the discriminating buyer, and has made it the most popular bracelet on the market. Made in plain, beautifully chased and stone set, plain polished, English and Roman finishes, and in gold-filled and sterling silver.

Manufactured by

**Doran, Bagnall & Co.,**

North Attleboro, Mass.

194 BROADWAY, NEW YORK.

67 WABASH AVE. CHICAGO.

126 KEARNY ST., SAN FRANCISCO.

All of the foremost jobbing houses now carry a full line in stock, and you will miss an opportunity if you fail to see them. Ask your jobber to show you the full line.

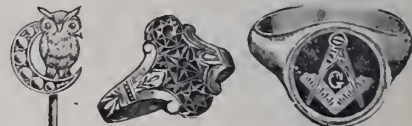
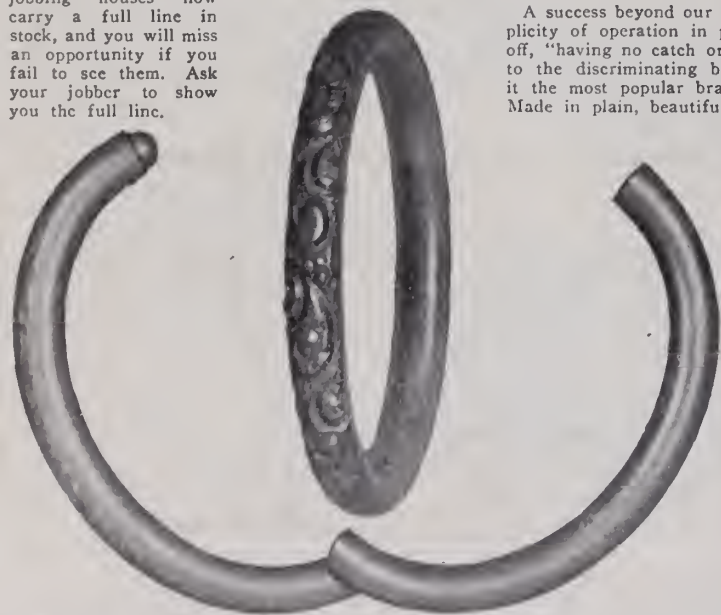

**Remember**

the American Ring Co. when looking for a nice line of

**Rings, Scarf Pins, Brooches, Ear Screws, Crosses, Etc.**

Orders Prove that Our Goods Sell. For the Jobbing Trade Only.

**American Ring Co.**

94 Point Street  
PROVIDENCE . RHODE ISLAND

**JACOB BASCHKOPF,**  
**DIAMOND SETTER,**  
LETTER AND MONOGRAM  
**ENGRAVER,**  
9-13 MAIDEN LANE,  
NEW YORK.

**A. Nonnenmann & J. Aschenbrenner,**  
114-118 East 23d St., New York.

**Original Designers** for Platinum, Gold and Silver Jewelry. Artistic Designs for Silverware and Novelties furnished at shortest notice.

**EDMUND R. NEBELING**  
**Diamond Setter**

49 Maiden Lane - NEW YORK  
Telephone, 6029 John

Gypsy and Platinum Work a Specialty. Mail Orders promptly attended to. Write us for references

# Our New Fall Line

IS NOW READY

It comprises a complete assortment in  
**JEWELRY and WATCHES**

We have everything you want, just when you want it. Our  
**DIAMOND DEPARTMENT**

can furnish either loose or mounted stones in all sizes and weights.

**MORRIS ROSENBLUM & CO.**  
**ROCHESTER, N. Y.**

**Eliassof Bros. & Co.**

IMPORTERS  
AND  
JOBBER OF

**DIAMONDS  
WATCHES  
JEWELRY**

9-11-13 MAIDEN LANE,  
NEW YORK.

100 STATE STREET,  
ALBANY, N.Y.



A LARGE ASSORTMENT OF DIAMOND  
MOUNTED JEWELRY CARRIED IN STOCK.

London, E. C., Holborn, Voaduct 17.  
**G. MARCUS.**

ESTABLISHED 1860.  
**L. O. LEVISON.**

Amsterdam, Tulpstraat 2.  
**ALEX. FELDENHEIMER.**

**CALIFORNIA JEWELRY COMPANY**

Importers of  
**DIAMONDS and PRECIOUS STONES**

SAN FRANCISCO, Temporary Office, Oakland, Delger Building

YOUR MEMO. ORDERS ARE SOLICITED

NEW YORK, 41 Maiden Lane

## JOS. NOTERMAN & CO. DIAMONDS

IMPORTERS AND CUTTERS

Recutting and Repairing odd shaped and chipped stones a specialty. Manufacturers of Mountings and  
Fine Jewelry. Special Designs Furnished.

CINCINNATI, OHIO.

# A NEW MOVEMENT

THE O-SIZE 7 JEWELLED PENDANT SETTING

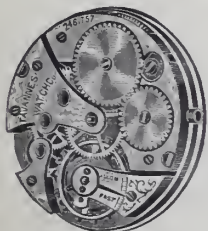

**TAVANNES**

— is —  
**Fully Guaranteed**

FOR SALE THROUGH THE JOBBING TRADE

**TAVANNES WATCH COMPANY**

2 & 4 Maiden Lane, New York

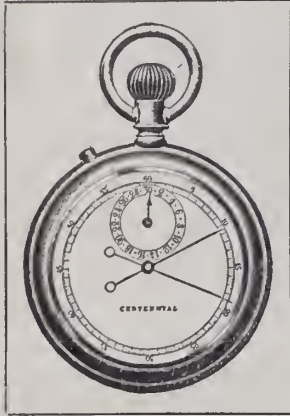
Timer is  $\frac{1}{8}$  Larger than cut

"Watch us" always for anything you wish in the "Watch" line.

## THE OLD RELIABLE Centennial

SPLIT SECOND TIMER

"None better made"

Suitable for Racing and  
Mechanical Purposes.

Timer is  $\frac{1}{8}$  larger than cut

**CROSS & BEGUELIN, Manufacturers, New York.**

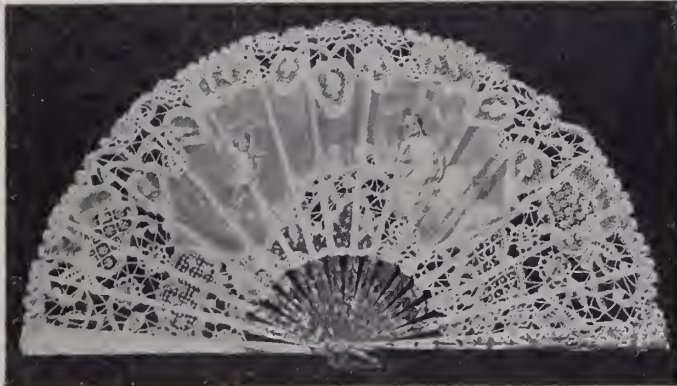

## FANS

Headquarters  
for the most exclusive line in  
this country.

SPECIALLY  
DESIGNED  
FOR THE FINE  
JEWELRY  
TRADE

## NECKLACES

Imitation Pearl and Fancy Bead, in all newest shades and exquisite colorings. Write for Samples, mentioning price.

**LOUIS STEINER, Importer, 520 & 522 Broadway  
NEW YORK.**

## BOSTON'S FOREMOST JOBGING HOUSE.

As manufacturers of diamond mountings, we have established a reputation for giving the greatest value at the least price. As direct importers of precious, semi-precious and imitation stones, we can serve as the repairer of your jewelry better than any other house. A full line of stones always on hand.

Write us for information, or  
Send us a trial order.

**ORKIN BROTHERS**  
373 Washington Street,  
Jewelers' Bldg., BOSTON, MASS.

**GARREAU & GRISER**  
68 & 70 Nassau St., New York.  
**LAPIDARIES.** PRECIOUS  
STONES  
EMS in Unique Cuttings

## MR. RETAILER :

Did you ever see a picnic party "hiking" for seats aboard an excursion boat? Well, that's the way the Watch Jobbers came at us this season for Solidarity gold cases. "Hide and Seek" will be the popular game this Fall, so far as our cases are concerned. You *won't* find them in the "job lot" trays—you *may* not find them in the "top trays," but insist on seeing the "Solidarity Trays" and you shall have them.

## Solidarity Watch Case Co.

ESTABLISHED 1885

GENERAL SELLING AGENTS  
JOHN W. SHERWOOD FRANK E. HARMER

3 Maiden Lane, New York



**GUESSING HAS CEASED TO BE A VIRTUE.**

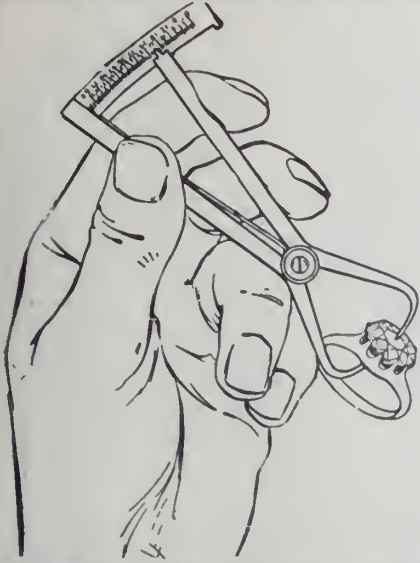

**THE MOE DIAMOND WEIGHT GAUGE** is the only correct system for determining the weight of mounted diamonds. **ENDORSED BY THE LEADING JEWELERS.** Those who are not familiar with the device, kindly send for descriptive booklet.

**Charles Moe, Inventor, 80 Adams St., CHICAGO, U. S. A.**

Price for Instrument and Book, \$3.75 prepaid.

May also order from the following agents: D. C. PERCIVAL & CO., Boston; CROSS & BEGUELIN and R. L. & M. FRIEDLANDER, New York; M. SICKLES & SONS, Philadelphia; NORDMAN BROS., San Francisco; E. & J. SWIGART, Cincinnati; LEONARD KROWER, New Orleans. BACKES & STRAUSS, Sole Agents for Europe and India, London, E. C., 14-17 Holborn Viaduct.

**REMOVAL NOTICE!**

**THE LYONS GEM CO.,**

Have Removed to

**35 Maiden Lane, New York.**

A FULL AND COMPLETE LINE OF PRECIOUS, SEMI-PRECIOUS AND IMITATION STONES ALWAYS IN STOCK.

Our Specialty is Scientific Rubies.

Local and out of town jobs promptly attended to at reasonable prices. Send us your mountings to be set with matched stones. A trial order will convince you that our prices are right, and our goods select.

**L. BONET, CAMEO PORTRAITS,**



Importer of **Precious Stones,**

41 Union Square, NEW YORK.

"PRACTICAL COURSE IN ADJUSTING." Price, \$2.50.

All Jobbers or Jewelers' Circular, Publishing Co.

**WORLD BRAND SILVER**



**Base Metal**

Manufactured in our own factory by workmen selected because of their knowledge and practical experience in its manufacture and use and with a view to obtaining the best possible results.

**Silver**

Not Less Than 50 per cent. heavier plate than the regular "Standard." Made in two grades, six and fourteen ounce plate.

**Designs**

Six fancy patterns—original in design and unexcelled in execution. Also four plain patterns.

**Prices**

As low as consistent with quality.

Write for catalogue and prices.

**THE AMERICAN SILVER COMPANY**  
BRISTOL, CONN.

46 West Broadway, New York.

Silversmiths' Building, Chicago, ILL.

**OUR LINE!**

**JEWELRY and SILVERWARE CASES WINDOW and SHOW CASE DISPLAYS**

Will unquestionably meet with your approval

THROUGH ITS MANY AND ORIGINAL NOVELTIES AND COLOR EFFECTS EVERY FEATURE FOR ATTRACTION WITH AN EYE FOR PRACTICABILITY

**ABE KASSEL**

671-3-5 HUDSON ST.

NEW YORK

**F&B**  
TRADE MARK

**F&B**

The  
**Gypsy**

Another of our new patterns in Toilet and Manicure goods.

Take particular notice of the new shape of Bonnet Mirror, which will be appreciated by every lady who uses one, it is so convenient. The regular shape can be furnished a little later if it is desired.

Our new line of Sterling Silver silk-lined Jewel Cases is especially attractive, and we are showing a great many Novelties which we will have illustrated in our new Catalogue, H, now in the hands of the publishers.

Owing to the phenomenal demand for

**“The Armlet,”**

the **F&B** invisible joint

bracelet, it has been impossible to keep pace with the orders, but we now believe we shall soon be able to make prompt shipments.

See our full lines of gold-filled Locketts, Charms, Crosses, Pendants, Chains, Fobs, Neck Chains, Collarettes, Pins, Brooches, Earrings, Link Buttons, Scarf Pins, Hat Pins, Barrette Pins, Belt Pins, Waist Sets, Buckles, Hair Chain Mountings, Ribbon Book Marks and a large line of Sterling Silver Novelties.

# Theodore W. Foster & Bro. Co.

Manufacturing Jewelers and Silversmiths 100 Richmond Street, Providence, R. I.

New York Salesroom  
31 Maiden Lane

Chicago Salesroom  
Heyworth Building, Wabash Avenue and Madison Street

Canadian Salesroom  
350 King Street, Kingston, Ont.

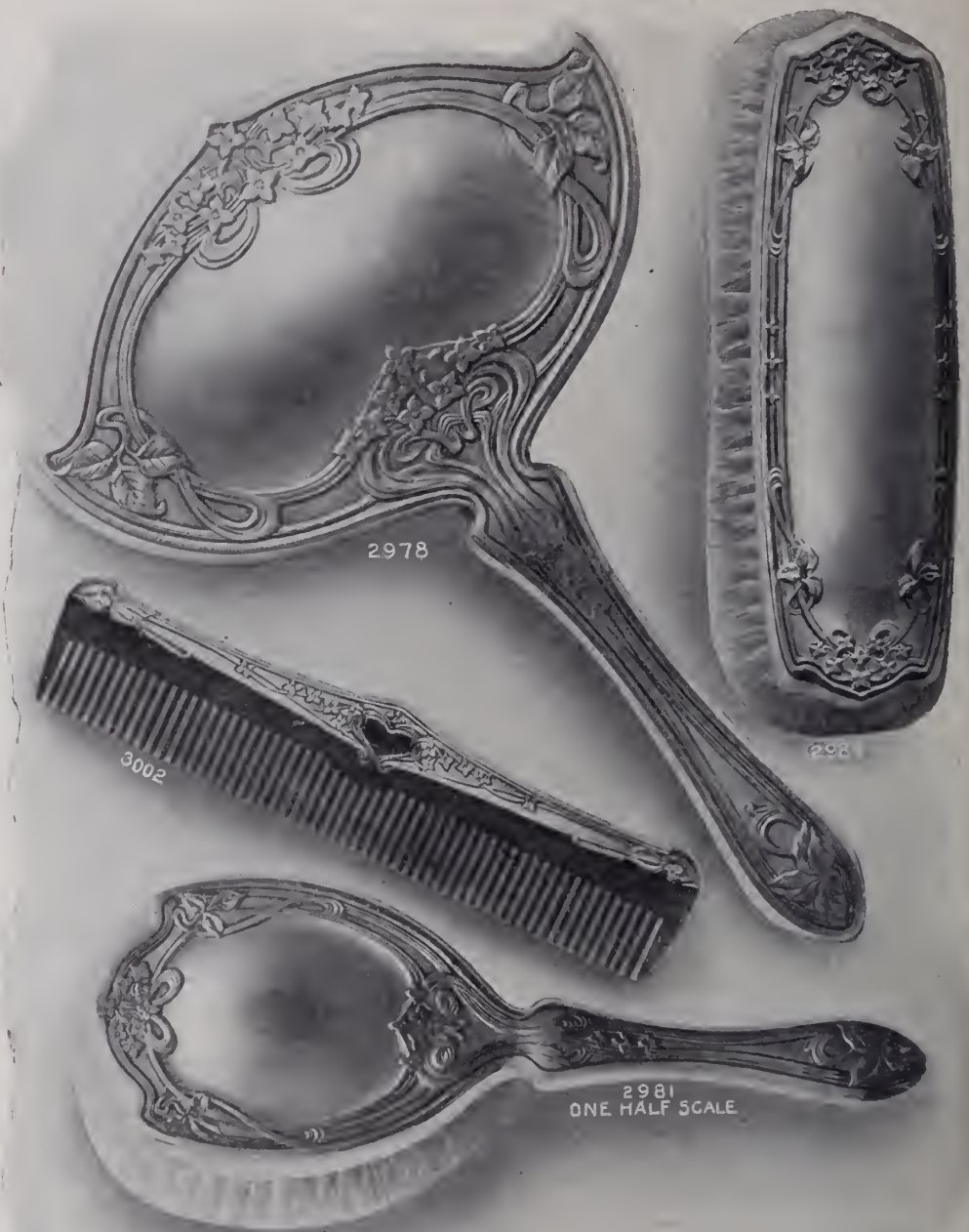

## Dr. George F. Kunz's Report.

Production of Precious Stones in 1905  
Published by the United States  
Geological Survey.

[The publication of this Report was commenced in THE JEWELERS' CIRCULAR—WEEKLY, July 18, 1906, and will be continued in this and succeeding issues until completed.]

### SOUTH AFRICA—(Continued).

On comparing these figures with those of the De Beers group of mines at Kimberley for the same period, it is seen that the blue ground is comparatively very low in its diamond content, but that the average value of the stones per carat is considerably higher than for those of the richest of the other group—the De Beers and Kimberley. The total number of loads washed is nearly two-thirds that of all the De Beers group together; while the total diamond product is less than one-sixth, but its value exceeds one-fifth.

The average number of men employed in the diamond mines of the colony, month by month during 1905, was 526 whites and 4,659 natives. With some fluctuations there has been a general increase of the total number during the year, from 4,458 in July, 1904, to 5,496 in July, 1905. The average monthly wages paid for mining and prospecting in the Orange River Colony are given in a recent article as £20 7s. 7d. to white men and £3 1s. 6d. to natives.<sup>1</sup>

### BRAZIL.

*Diamonds and Carbonado in Bahia.*—Considerable space has been given in recent reports of this Bureau to the diamond and carbonado industry of Brazil. An important article has appeared within the last year on the geology of the Bahia region by Prof. Orville A. Derby, who was engaged by the State of Bahia to study the geological occurrence of the carbonados. The article in question is his report of this work, and has been translated into English by Prof. John C. Branner for publication in this country.<sup>2</sup>

The region examined was the basin of the Paraguaçu River, the upper part of which contains the Chapada Diamantina, or diamond plateau of Bahia. The river traverses four regions or belts of entirely distinct geological character. The first of these takes in all the headwaters of the Paraguaçu and its main affluent, the Santo Antonio; the second reaches from the Falls of Passageni de Andaraí, some 50 miles, to Bebedouro; the third extends about 200 miles, down to Maragogipe, and the fourth is a narrow belt adjacent to the coast.

The diamonds and carbons are characteristic of the first region, and occur occasionally in the second and third. At all the localities examined by Prof. Derby they appear in connection with a thick bed of conglomerate about the middle of the hard sandstone formation. In many places, indeed, he states that the gravels worked for diamonds are simply this same conglomerate decomposed in place, and not a more recent superficial deposit. This fact has already been recognized in the State of Minas Geraes, where also, at Grao Mogol, diamonds have been taken from the hard conglomerate itself. It is clear that in Brazil the conditions of diamond occurrence bear no resemblance at all to those in Africa. All the indications point to the conglomerate as the source of the diamonds, and the recent unconsolidated gravels are richest in the vicinity of outcrops of this rock, which miners call *pedra cravada*.

If this determination of the conglomerate as the home of the diamonds be correct, Prof. Derby remarks, the supply must be enormous, and all that has been done heretofore is trivial in comparison. Only a small part, however, of the deposits can be worked with the methods in use thus far. Whether modern scientific processes, using the hydraulic power so abundant in the region, can operate the beds at an actual profit remains a question for future solution.

Elsewhere than in the vicinity of the Serra das Lavras and its conglomerate there are few diamond occurrences, but still some are known that have interest. Along the bed of the Paraguaçu, in particular, there are various points where diamonds are obtained by diving, and some of these are so far from the Serra that it is not easy to see how the source can be so distant. The principal lo-

cality is at the Falls of Funil, near Bebedouro, on the eastern edge of the second region or zone mentioned above. Here the fall is formed by a heavy bed of conglomerate resembling the one in the first zone, but almost certainly of later age. It rests upon granitic rocks and its pebbles are largely thence derived, so that the "formaço," or diamond gravel, is quite different from that of the first zone. The sandstone of the second zone, however, must be largely derived from the first, and the contained diamonds may be thus accounted for.

These accounts should be compared with that by H. W. Furniss, dealing with the same region and reviewed in the report of this Bureau for 1902.<sup>3</sup>

There is another diamond region in Bahia—that of Cannavieras and the valley of the Pardo River, and the southern part of the State.<sup>2</sup> This, Prof. Derby remarks, is the only diamond occurrence in Brazil at all near the sea. It is a region of but slight elevation, only about 100 meters, largely wooded, and with a thick soil that obscures the rocks. At points, however, in the valleys of the Pardo and the Salobro a heavy conglomerate with granitic pebbles is exposed near the diamond washings. One diamond of three grains was obtained for Prof. Derby in a test made on one and one-half cubic meters of decomposed conglomerate selected by him. Thus, again, diamonds are apparently traced to a widespread bed of conglomerate, here quite near the coast, easily recognized, and suggesting extensive possibilities for investigation and development.

### NEW SOUTH WALES.

A valuable guidebook to the mines and minerals of New South Wales has lately been issued under the direction of the minister of mines and agriculture in that colony, S. W. Moore.<sup>3</sup> In this work references are made to the occurrence of diamonds at several points, which have been noted from time to time in former reports of this Bureau.

The more recent and more important diamond districts around Bingara and Inverell are situated near the Queensland border. Bingara is 378 miles north of Sydney, and Inverell and Tingha are both nearly 40 miles east of Bingara. The divisions named from the two latter places contain much tin in the drift, while the Bingara division is worked principally for gold. With regard to diamonds in particular the guidebook says that near Copeton, in the Inverell district, are numerous isolated hills capped with basalt, beneath which are sands and gravels, with tin, diamonds and some gold. These hills have been variously named, one of them being the celebrated diamond locality of Boggy Camp. It was in this district that the discovery of two small diamonds in a basaltic dike was made in 1904 at Oakey Creek, near Copeton.

The Bingara division presents conditions somewhat similar, yet with some differences. The chief diamond yield has been from patches of gravel capping the foothills of the basalt-covered range some five miles to the southwest of Bingara.

It is in the Bingara district, at Ruby Hill, that the eclogite-bearing pipe was observed in 1902, which led to so much discussion as to eclogite being the probable source of the diamonds.<sup>2</sup> The guidebook states there has been but little activity of late in these fields owing to low prices for the diamonds, which are all of small size.

The statistics for New South Wales, given in this volume, state the diamond yield for 1904 as 14,296 carats, valued at £11,620, and the total production to the end of that year as 147,955 carats, valued at £98,223 17s.

*Large Diamond at Mount Werong.*—The fact, after years of working at various points, that only small diamonds had been found, led naturally to the belief that no large diamonds were to be expected in Australia. Within the past year, however, a diamond of near 29 carats has been discovered at Mount Werong, 136 miles west of Sydney and 30 miles south of Oberon. It was found at a depth of 12 feet by two gold miners, who were not diamond miners and who did not know what it was. They kept it for some months, and were offered a few pounds for it on two occasions, but suspected that it might be more valuable. Finally it was sent to the State depart-

ment of mines at Sydney, where it was recognized at once, and its value then proved to be £200. The stone is a distorted and flattened crystal, measuring 23 by 15 by 5 mm., flawless, and of a straw yellow. Appreciating the importance of this discovery, E. F. Pittman, of the department of mines, promptly visited the place and made a report upon it, which is reviewed by John Plummer in the *Mining World* of Oct. 21, 1905.<sup>1</sup>

Mount Werong is one of the peaks of the mountain range, some 4,000 feet high, which separates the fertile coast region from the arid interior. In the beds and ravines of the streams that drain the ridge much of the drift gravel is found washed down and redeposited, and here occurs gold, with zircons and sapphires, abundant but small, and also this large diamond, and another found some years ago, and valued at £5. The sapphires have undoubtedly some from the decomposed basalt overlying the drift, as none have been found in the drift itself. The diamond Mr. Pittman refers to the drift; but he also recognizes the possibility of its having come from the basalt, in view of the discovery of one or more diamonds in the somewhat related dolerite at Copeton. This new locality is some 300 miles south of the Inverell and Bingara region.

### NOTES ON THE DIAMOND.

*Russian Experiments in Crushing Carbons Used in Diamond Drills.*—Prof. Alex. M. Mitinsky, of the Mining Academy of St. Petersburg, Russia, is carrying on a very interesting series of experiments in crushing the carbons used in diamond drills.<sup>2</sup> The rate of advance of a diamond drill increases with the pressure up to a point where the diamonds are likely to break. Here the limit is reached, beyond which an economic loss is involved by greater pressure. The object of this investigation was to determine this limit, which had not before been done, and which is of course a very important practical question.

There has been hitherto a remarkable difference in the practice of European and American operators in work of this kind. The former have generally followed an empirical rule of applying a pressure of two kilograms per square centimeter on the bottom of the drill, which is equivalent, with ordinary tools, to one kilogram per square millimeter on the diamonds. American drillers have used far higher pressures, as much as 50 or 60 kilograms per square centimeter; by the same ratio this would give 25 to 30 kilograms per square millimeter on the stones set in the drill.

Prof. Mitinsky, assisted by S. Woisslaw, the pioneer of diamond drilling in Russia, selected a number of carbons and subjected them to pressure tests. This was done by placing each stone between two metal plates, a harder one representing the rock and a softer one representing the tool. These were connected with a very sensitive press and recording apparatus, with a maximum load of one metric ton. Different metals and different grades of steel were tried, and the half-sum of the areas of the impressions made in the two plates, in each test, was taken as the cross-section area of the diamond that had been pressed into them for calculation of the force exerted per square millimeter of the stone. The first test was to the limit of the press, one metric ton, without breaking, and the determination was 54.3 kilograms per square millimeter. The second stone, a small one, broke at a calculated pressure of 80.6 kilograms per square millimeter. Three other tests had an average of 68 kilograms as the breaking limit, the lowest being 56 kilograms.

These experiments, Prof. Mitinsky thinks, show clearly that the pressure on drilling tools can safely be much increased with corresponding advantage in results, and that the Americans although far in advance of the Europeans, have yet been operating well within the limit of practical advantage.

After these tests Mr. Woisslaw directed his workmen to disregard the risk of breakage and to use the highest pressure attainable with their machinery. Prof. Mitinsky states that the results were very good, and adds that by this method tools can be obtained that can be run safely at a rim speed of 25 meters per second.

(To be continued.)

Sol. Martin, Jr., Milwaukee, Wis., is now acting as manager of Martin & Co., Evansville, Ind.

<sup>1</sup>*Min. World*, Oct. 21, 1905.

<sup>2</sup>*Eng. and Min. Jour.*, Dec. 16, 1905.

<sup>3</sup>Mineral Resources U. S. for 1902, U. S. Geol. Survey, 1904, pp. 816-822.

<sup>2</sup>Ibid, p. 816.

<sup>3</sup>A Guidebook for the Use of Prospectors in New South Wales; Sydney, 1905, pp. 156, with map.

<sup>4</sup>Mineral Resources U. S. for 1902, U. S. Geol. Survey, 1904, pp. 824-826.

<sup>1</sup>THE JEWELERS' CIRCULAR—WEEKLY, Oct. 11, 1905.

<sup>2</sup>Econ. Geol., vol. 1, No. 2, Nov.-Dec., 1905, pp. 134-142.

# STRAIGHT TALK

We want to do business with every wide-awake retail jeweler of good standing in the United States.

We know that our various lines of gold jewelry are unquestioned as to quality, price and construction.

Therefore we do not hesitate to stamp our registered Trade-Mark on every piece as a guarantee of the above facts.

We make rings for man, woman and child. All kinds of 14k gold sleeve buttons, lockets, Larter shirt studs and Larter vest buttons.

If our travelers do not reach you, may we send you the Fall edition of the Larter Gold Book now in process of publication? A postal will bring one.

4  
over  
40  
years  
Ring Makers

Larter & Sons  
21-23  
Maiden Lane  
New York



Registered Trade-Mark.

## Magnificent Silver Loving Cup Presented to the Chicago Yacht Club.

ONE of the most beautiful specimens in silversmithing that has been exhibited of late is a loving cup represented to the Chicago Yacht Club by Sir John G. Nutting, Baronet of St. Helens, Dublin, Ireland. The trophy was given for the encouragement of yachting on the Great Lakes, and will be offered by the club as a prize for contests to be held, in all probability, during the coming Fall. An illustration appears on the front cover of this issue.

This superb example of Martelé silver workmanship was designed by the Gorham Co., and produced in its factory at Providence, R. I. It stands 31 inches high and the width across the rim is 12 inches. Surmounting the top of the cup is a miniature of a viking ship in sail with flying standard, a representation of ancient skill in seamanship that is a conspicuous feature in the design. A slight liberty is taken with the viking by placing the club's colors on the expanded sail. Directly below the graceful little ship are two mermaids, applied to the upper portion of the curved handles of the bowl, who are looking intently at the moving vessel. Mermaids are also applied at the foot of the handles, adjoining the base of the bowl and just above the stem. The latter figures are supporting an ornate panel within which is the inscription. Other mermaids, shells, sea fishes and sea grass are gracefully hammered in the design, encircling the inscription. Shells and other marine effects are also tastefully used in the ornamentation of other portions of the cup, including the cover and base. The cup stands on a handsome pedestal.

The inscription reads: "Presented to the Chicago Yacht Club for the Encouragement of the Sport of Yachting on the Great Lakes by Sir John G. Nutting, Baronet, St. Helens, Dublin, July, 1906."

## Census Report on Jewelry and Clock Industries of Connecticut.

Statistics showing the prosperity of the jewelry and clock business of Connecticut were issued within the past week by the National Census Bureau. They show a total output in the clock industry of over \$6,000,000 in a year, and of over \$100,000 in the same length of time in jewelry. The figures tell their own story, and follow:

	Clocks. Jewelry.	
	10	7
Number of establishments.....	10	7
Total capital .....	\$6,761,036	\$91,850
Value of land.....	\$352,796	\$3,100
Value of buildings.....	\$1,031,064	\$3,400
Machinery and tools.....	\$1,376,417	\$20,350
Cash and sundries.....	\$4,000,759	\$65,000
Number of proprietors and firm members.....	.....	5
Number of salaried officials..	339	7
Their salaries .....	\$315,472	\$6,500
Number of wage earners....	5,150	46
Their wages .....	\$2,600,679	\$17,898
Men over 16 employed.....	3,523	28
Their wages .....	\$1,994,427	\$14,960
Women over 16 employed....	1,445	16
Their wages .....	\$563,008	2,650
Children under 16 employed.	182	2
Their wages .....	\$43,244	\$279
Rent of works.....	\$741	\$1,065
Taxes .....	\$30,477	\$109
Rent of offices.....	\$241,138	\$4,138
Contract work.....	\$275	.....
Cost of principal materials used.....	\$1,874,549	\$36,524
Fuel and rent of power.....	\$53,804	\$1,117
Value of product.....	\$6,158,034	\$105,700

### Report of Rapid Development of American Culture Pearl Industry Not Believed in New York.

Reports sent out from La Paz, lower California, which are not believed in New York, are to the effect that a French company is now cultivating oysters and growing pearls under a new process which is said to yield better results than anything tried before. The Frenchmen are said to be members of the Boleo Copper Co., and to have associated with some capitalists of Mexico City and La Paz. It is further said that the company has issued a statement showing that in 1905, the first year of its operation, it netted a profit of \$53,000 on an investment of \$63,000.

The process used by the company is said to include the incubating and hatching of the oyster and its proper nutrition with a view to producing the best kind of a pearl. The incubating and brooding process is said to be the invention of Gaston Vives, a pearl fisherman of La Paz, who has taken out patents.

It is said that the company employs several hundred divers and operates 500 incubators. The divers are said to obtain the spawn of the pearl mollusk, which are placed in the incubators. The shells are said to be sold to button manufacturers in California. It is claimed that the company has an important fishing concession.

Maurice Brower, 12 John St., who has acted as agent for the Japanese culture pearls, and who keeps in close touch with developments of the American pearl fisheries, was asked his opinion as to the above report last Monday, just after he returned from a 10 days' trip to western pearl fisheries. Mr. Brower said that culture pearls have been produced at a number of points in the United States. As far as he knows none of these experiments has been as yet of any commercial importance. No pearls produced in this way, he says, are known to have reached the market at any time.

The methods employed by the Americans who have been experimenting along this line, this dealer says, have been somewhat different from those used by the Japanese. As is known in the trade, the Japanese insert a plug in the shell of the oyster and on the point of the plug the button pearls are then produced. In this country the most popular method seems to be to open the shell, inserting on the flesh of the oyster of a grain of sand or some other irritating substance, and then close the shell, which is returned to the water. The oyster coats over the intruding article so that a round or approximately round pearl is produced.

The difficulty, however, is in getting pearls of sufficient size in attractive lustre. Mr. Brower says that he has never seen any culture pearls produced in this country that are larger than five grains. He has heard that some have been produced weighing 10 grains. Most of those that have been produced range from one grain to five grains. The Americans, he says, have no more success in producing pearls less than one grain in size than in getting those larger than 10 grains.

Mr. Brower says that the chief trouble is in the lack of attractive coloring or lustre, and it is on account of this that all the

pearls produced in this manner, which he has seen, are practically without value except as curiosities. As to the company reported to be operating in Lower California, Mr. Brower says he has no knowledge. He knows of individual fishermen who are experimenting, but has not heard of any operation on a considerable scale.

As to values, this dealer gives as an instance that if a five-grain Oriental pearl brings \$100, Japanese culture pearls of the same weight might bring \$10, and on an American culture pearl he would hesitate to place any value.

A report from Bellefontaine, O., says that pearls found in a new bed, in the St. Mary's River, have been sent to Tiffany & Co., New York, for appraisal.

From Red Wing, Minn., comes a report that I. E. Anthony, of Prairie du Chien, obtained \$7,300 for the pearl found at that place by Martin Bates. The latter, it is said, received this amount less \$1,150, Mr. Anthony's commission.

### Death of Chas. Teetzel.

BENTON HARBOR, Mich., July 25.—This town has lost one of its oldest and most prominent jewelers Charles Teetzel, of the firm of Teetzel & Alger, having passed away Sunday night. Death was due to paralysis, and occurred at his home. Besides being the oldest jeweler, Mr. Teetzel had, with one exception, been in business longer than any other man in Benton Harbor.

Deceased was 55 years of age, and commenced business here about 30 years ago. He continued alone until 1896, when he formed a partnership with William Haydon, under the style of Teetzel & Haydon. The firm met with reverses, and the business was sold to Mr. Haydon's father, under whose name it was conducted until January, 1899, when the latter sold out to E. A. Hamilton, with whom Mr. Teetzel continued as watchmaker. He then joined Mr. Hamilton as partner, under the firm style of Teetzel & Hamilton, and a branch store was opened in St. Joseph. This firm dissolved in the Spring of 1900, Mr. Hamilton taking the St. Joseph store and Mr. Teetzel remaining here. Last year he joined forces with George D. Alger, who had formerly been in business for himself, and later was watchmaker for Teetzel & Haydon.

Mr. Teetzel was very popular in the trade, and was known as an able workman and clever watchmaker. He stood high in the community, and his death was mourned by a large circle of friends throughout this section.

C. D. Fry has admitted a partner in his jewelry business in Sasakwa, Okla., and the firm is now Fry & Roberts.

According to reports dissensions in the management of the National Self-Winding Clock Co., Champaign, Ill., have led to a committee of the Board of Directors taking charge of the business. The committee in a communication advises that the factory be continued in operation on an economical basis and that improvements be made in the construction of mantel clocks. The company, which formerly had its factory in Bristol, Conn., was incorporated with an authorized capital of \$1,000,000.

### San Francisco Wholesale Jewelers' Sample Trunks Robbed of \$13,000 Worth of Stock.

GILROY, Cal., July 24.—Diamonds valued at \$10,000, with watches and other jewelry worth \$3,000, were stolen last night from two sample trunks belonging to Adolph Eisenberg & Co., wholesale jewelers, of San Francisco. The trunks were left at Frutig's jewelry store in this town.

Mr. Eisenberg reached here on the 8:40 train, and had his trunks taken to Mr. Frutig's store at once. When the night watchman made the rounds at midnight the store was securely locked and the trunks had been pried open with a jimmy and looted of their valuable contents.

It is believed that the robbery was committed by a well-dressed stranger, who was seen peering into the window of the store last evening while Messrs. Eisenberg and Frutig were there. The actions of this stranger attracted the attention of the two men and Mr. Eisenberg went to the front of the store to question him. The stranger appeared to be intoxicated as soon as Mr. Eisenberg advanced, and reeled down the street out of sight. This incident, while rousing the suspicions of Mr. Eisenberg at the time, was forgotten until the daring robbery was discovered this morning.

Sheriff Ross and Deputy Sheriff White have secured a good description of the supposed burglar, who was seen by a number of people in the vicinity of Mr. Frutig's store last night. It is thought that the stranger is a professional diamond thief, who has been following Mr. Eisenberg, awaiting a favorable opportunity to carry out his plan of robbery.

### Jewelers of Santa Rosa, Cal., Give Birthday Gift to John Hood in Recognition of His Work.

SANTA ROSA, Cal., July 25.—John Hood, a well-known retail jeweler of this city, celebrated his birthday last week, at which time several members of the trade in this city took occasion to surprise him with a handsome present in recognition of all he had done for his brother jewelers after the disaster of April 18. The present took the form of a handsome weathered oak writing table-cabinet and chair, which was given to him formally.

After the earthquake, a number of local watchmakers and jewelers having lost their tools and stock, were almost destitute, and practically unable to continue in business, but through Mr. Hood's efforts attention was called to this by a letter written to THE CIRCULAR-WEEKLY, and as a result the Jewelers' Relief Association and the Jewelers' Board of Trade forwarded to Mr. Hood new tools and a substantial check for use by the jewelers who had suffered. Among those who benefited by Mr. Hood's work and who participated in presenting him with the cabinet were A. P. McGregor, E. P. Sawyer, H. R. Eckstrom, M. F. Noack and E. F. Heath.

Thieves who recently broke into the post-office at Crooksville, O., and after blowing open the safe stole \$15 in cash and \$75 in postage stamps, on the same day entered the retail jewelry store of G. F. Stebbins, where, however, they secured nothing of value.

# The Marlborough

Design Patented Illustrations Exact Size

The Newest Reed & Barton Sterling Pattern, here shown for the first time.  
A design of character and dignity, which has met instant  
favor with the trade.



TRADE MARK



Illustrations and prices of these and other designs, both Sterling and Plate, furnished to the recognized Jewelry Trade.

## REED & BARTON, Silversmiths

ESTABLISHED 1824

THE OLDEST MAKERS OF SILVERWARE OF REPUTE IN AMERICA

REPRESENTED AT— 320 Fifth Avenue, New York  
6 Maiden Lane, New York

103 State Street, Chicago  
296 Second Avenue, San Francisco

OFFICES AND FACTORIES  
TAUNTON, MASS.

## The Diamond Markets.

ANTWERP, July 20.—The situation in the diamond industry here is the same as last month. A better tendency is to be observed in the demand for very small goods, but the market for the large stones remains very quiet. The manufacturers have much difficulty in finding the necessary rough goods to keep all their workmen occupied, so that a certain number of diamond cutters are laid off at this moment.

The offices of Mr. N. Missok, which were at 17 Longue Rue de l'utel, are now at 105 Avenue du Sux. G. Landsberg, who lived at 14 Rue Gounod, now has his office at 50 Rue Brant.

Many foreign buyers visited the Diamond Club during the past fortnight, among others Messrs. Slyper, Bismuth, Haski, Mitacoupolo, Weissberg, De Haan, Eisenhart, Emile Weill, M. Slabotsky, Godesfeld, H. Sevadjian, Adolphe Levy, Eknayan an Wins, all of Paris; Messrs. Kauffmann, Tufel, Frytel, L. Van Moppes and Broekhuysen, London; Messrs. Silberfeld, Lindernborn, Jacobson, Harper and Herzfelder, New York; Mr. Strauss, Hanau; Mr. Hekster, Amsterdam; Mr. Abend, Berlin; Mr. Schatkin, Liverpool; Mr. Mayers, Boston; Mr. Beldiche, Algeria; S. Rapsport, Leipzig; Mr. Alfandari, Constantinople; Mr. Kahn, Moscow; Mr. Kabrinsky, Wilma; Messrs. Pines and Siebenberg, Warsaw; Mr. Hakenbrouck, Frankfurt-on-Main; Mr. Harodischi, Bialystock; Messrs. Gaumer, Antonio and Lorenzi, Milan; Mr. Bellack, Vienna; Mr. Alexandroff, St Petersburg.

AMSTERDAM, July 18.—During the second half of June this market was visited by several foreign buyers, with the result that important sales were made, especially in mêlée of good quality and brilliants of one and two grains. The demand for good mêlée continues, but these stones are obtained with great difficulty. The demand for rough continues very brisk, notwithstanding the commencement of the holiday season.

Among the foreign buyers who have been here recently were: M. Hahn & Co., Mr. Minnelstein, Lambert Frères & Co., A. & E. Worms and Mr. Pehlivanian, all of Paris; Messrs. Bozenhardt and Jollasse, Hamburg; H. Klein, Antwerp; representatives of Zimmermann, Rees & Co.; Jacobson Bros., Laubheim Bros., Arnstein Bros. & Co., Zachs Oppenheimer, L. Oppenheim and Ingomar, Goldsmith & Co., all of New York; Fox Bros. & Co., Cincinnati, and Sigler & Co., Cleveland.

PARIS, July 18.—The market for roses has been very quiet during the last two weeks, although one large merchant bought several hundred carats of small roses of 110 to 125 francs per carat. Small brilliants and eight faces are in demand, chiefly by Paris firms. Several sales were made with American, Argentine and Brazilian dealers in pearls and colored stones.

Two bad failures occurred at the end of June, one by a merchant who has a branch in London, who offered to compromise with his creditors, and the other by a merchant who made a large number of

purchases on time and paid prices out of proportion to the market value.

Miss Alice Bernard, the daughter of Paul Bernard, the vice-president of the Syndicat Professionnel des Negociants et Courtiers en Pierres Precieuses, is engaged to Nathan Pront, of Amsterdam.

The offices of Robert Menkin are now at 19 Rue de Rochechouart. The office of Mr. Mitacoupolo, formerly on the Ave. Alphonse, at Saint Mandé, is now at 80 Rue Bolivar. A new concern has been formed here under the style of Emile Weill-Weill & Fils, 1 Rue Laffitte, with a capital of 300,000 francs.

## Jewelry, Clocks, Optical Goods, Watches, Silverware and Kindred Lines Exported from New York.

WASHINGTON, D. C., July 25.—The following were the exports of jewelry, silverware and optical goods, clocks, watches and kindred lines from the Port of New York for the week just ended:

Auckland: 9 packages watches, \$1,390; 12 packages plated ware, \$1,419; 259 packages clocks, \$9,065.

Bahia Blanca: 3 packages plated ware, \$473.  
Buenos Ayres: 1 package thermometers, \$242; 33 packages plated ware, \$3,349; 4 packages optical goods, \$1,144; 4 packages clocks, \$115; 1 package watches, \$1,292.

Callao: 3 packages watches, \$576.  
Cape Town: 79 packages clocks, \$1,078; 1 package watches, \$154; 5 packages plated ware, \$421.

Chaux du Fonds: 3 packages watches, \$327.  
Colombo: 16 packages clocks, \$431.

Dublin: 4 packages clocks, \$115.  
Fiume: 3 packages clocks, \$125.  
Glasgow: 52 packages clocks, \$1,460.

Hamburg: 2 packages plated ware, \$350; 5 packages optical goods, \$550; 3 packages jewelry, \$170.

Havana: 2 packages plated ware, \$124; 34 packages clocks, \$336; 3 packages jewelry, \$877; 5 packages jewelry, \$880; 1 package scopes and views, \$285; 30 packages clocks, \$260.

Havre: 4 packages optical goods, \$589; 3 packages jewelry, \$1,434; 2 packages watches, \$504.

Liverpool: 21 packages jewelers' ashes, \$1,500; 67 packages clocks, \$1,044; 5 packages jewelry, \$1,489; 2 packages scopes and views, \$150; 1 package plated ware, \$169; 3 packages clocks, \$139; 2 packages jewelry, \$1,500.

London: 78 packages clocks, \$3,336; 1 package stereoscopic goods, \$126; 1 package jewelry, \$186; 11 packages clocks, \$385; 6 packages optical goods, \$1,273; 3 packages scopes and views, \$406; 24 packages watches, \$11,083.

Manila: 7 packages clocks, \$210.  
Montevideo: 4 packages jewelry, \$262; 7 packages clocks, \$140; 7 packages plated ware, \$670.

Rio de Janeiro: 7 packages clocks, \$171; 4 packages plated ware, \$488.

St. Johns: 3 packages optical goods, \$141.  
Southampton: 1 package watches, \$470.

Sydney: 15 packages plated ware, \$1,376; 112 packages clocks, \$1,363; 10 packages watches, \$1,080; 10 packages clocks, \$270.

Trinidad: 2 packages jewelry, \$100.  
Valparaiso: 3 packages plated ware, \$131.

Yokohama: 329 packages clocks, \$5,355.  
Zanzibar: 8 packages clocks, \$100.

## Death of George N. Luckey.

BALDWINVILLE, N. Y., July 25.—George N. Luckey, who died at the home of his daughter, Mrs. E. H. Lewis, Monday morning, was well known in business circles in this section, having been in the jewelry trade about 40 years. Death came after a lingering illness, which had kept him from business for two years.

Deceased was widely known, both as a jeweler and optician, and was at one time an officer of the New York State Optical Society. He came to Baldwinsville in 1860, and was in business in the Seneca House block for many years. Owing to

his impaired health, he was forced to retire in 1894. He was well thought of in the jewelry trade and by his customers, and he had many friends, both in business and social life, who deeply mourn his loss.

Mr. Luckey was married in 1863 to Miss Lucy Shore, who died seven years ago. He is survived by two daughters, Mrs. E. H. Lewis, of this village, and Miss Maud Luckey, of Saratoga. The funeral was held yesterday afternoon, and was largely attended. Among others there was a delegation from the Masonic fraternity, in which Mr. Luckey had been prominent.

## Rochester, N. Y., Jewelers Taking Steps to Form a Local Organization.

ROCHESTER, N. Y., July 26.—With the National Retail Jewelers' convention only a week off local jewelers finally got together this afternoon and discussed matters relative thereto. Early in the week Philip Present, taking the responsibility on his own shoulders, sent out postal cards to the local jewelers inviting them to come together and formulate some plans. Mr. Present stated that the meeting was to be held for two purposes: First, to discuss the matter of the entertainment of the visiting jewelers during their stay and, second, to discuss the advisability of forming of local jewelers' association.

About 10 members of the trade responded to the call and met this afternoon at the Chamber of Commerce. They were: S. D. Burritt, E. J. Scheer, Geo. L. Andrus, H. I. Sunderlin, Philip Present, Ellery Handy, Geo. Hunt, Willis Kennedy, M. H. Van Bergh, J. J. Ernisee. H. I. Sunderlin was elected as temporary chairman. Regrets were read from Klee & Kroh, Mr. Klee being out of town and Mr. Kroh was not able to be present. John Humburch was also out of town and sent his regrets, as did for the same reason J. R. White and E. S. Ettenheimer & Co. Henry Oemish was indisposed and asked to be excused. Otto Voss, Aug. Gervins and E. Dygert were also unable to attend and sent in cards. All of those absent and who sent in excuses with the exception of Humburch Bros. and E. S. Ettenheimer & Co. said that they were in favor of forming a local society.

Considerable discussion was given to the matter of forming a society, and it was finally decided to appoint E. J. Scheer and H. I. Sunderlin a committee to visit the members of the trade and make a thorough investigation as to the prevailing sentiment of those who did not heed the first call.

Regarding the entertainment of the visiting jewelers, Aug. 3 and 4, it was decided that inasmuch as nearly all delegates would also be here for the optical convention and that they would be royally entertained during that convention, no effort would be made to raise funds for their entertainment. There was little said in regard to indorsing the movement for a national association, the jewelers here thinking it best to wait.

On Tuesday, Aug. 7, another meeting of the jewelers will be held at the Rochester Club. At this meeting the committee will report on what they have accomplished, and further steps toward the formation of a permanent society will be taken. All dealers are urged to be present.

# HAYDEN W. WHEELER & CO.

## MOUNTED DIAMONDS

We are making up many new pieces in mounted diamonds for our Fall stock and will show new ideas and a larger and finer stock than ever.

Besides mounted diamonds, we have a large stock of loose diamonds, colored stones and pearls.

NECKLACES, BRACELETS AND LA VALLIERES ARE AMONG THE PREVAILING FADS AT PRESENT.



Trade-Mark  
Registered.

AMSTERDAM  
2 TULP STRAAT



Trade-Mark  
Registered.

LONDON  
50 HOLBORN VIADUCT

2 MAIDEN LANE, NEW YORK

TELEPHONE  
7365 CORTLANDT

ORDER

# DIAMONDS

ON MEMORANDUM FROM

## ALFRED H. SMITH & CO.

170 BROADWAY, NEW YORK.  
Corner Maiden Lane.

London.  
6 Holborn Viaduct.

Chicago,  
103 State Street.

# Oppenheimer Bros. & Veith, Cutters of Diamonds,

65 NASSAU ST. (PRESCOTT BUILDING), NEW YORK.

AMSTERDAM,  
2 Tulp Straat.

LONDON,  
40 Holborn Viaduct.

CUTTING WORKS,  
Cor. Union & Nevins Sts., Brooklyn.

## HENRY E. OPPENHEIMER & CO.,

51 Holborn Viaduct, London.  
50 Rue de Chateaudun, Paris.  
7 Place Loos, Antwerp.

Tel. 621 Cortlandt.

3 MAIDEN LANE, NEW YORK.

DIAMONDS, PEARLS AND PRECIOUS STONES.

MEMORANDUM ORDERS SOLICITED.



### Two More Men Arrested in Connection With Robbery of Joseph Wineburgh & Sons, Utica, N. Y.

UTICA, N. Y., July 27.—Another arrest was made last night, which may have a very important bearing on the \$2,500 diamond tray theft from Joseph Wineburgh & Sons' store on July 17. It is believed that the principal in the bold daylight robbery was captured at Brockport, N. Y., a small town in western New York, and the local police believe the man is John Reedy, alias Harry Reed, alias Harry Campbell, a crook known to all the police in the larger cities. Reedy is supposed to be the man who got away with the tray of diamonds while Bliss and the other man now under arrest here occupied the attention of the clerks in the Wineburgh store.

Stimulated by a reward of \$500, the New York Central Railroad detectives took a hand in the search for the man who got away with the tray of diamonds. The detectives secured photographs of many noted crooks. These they showed to the night manager and waiters at the Hotel Lewis, where the quartette of crooks remained two nights before the robbery. They identified a picture of Reedy as one of the four men, and last night Detective Holstein arrested the suspect at Brockport.

Reedy and another man, said to be Thomas Hayes, better known in the under world as "Big Logan," who was also arrested at Brockport, were brought here tonight, and, while the police refuse to say positively whether they are the two missing diamond thieves, the two men have been sufficiently identified to warrant their being held here. Police departments in other cities want the two men.

The prisoners were arrested at a firemen's convention at Brockport. They were seen to leave a train from Buffalo and taken into custody by the railroad detectives. Mr. Wineburgh partially identified the two men, and they will be held. Both admitted that they were pickpockets, but denied any connection with the Wineburgh robbery.

It is more than likely that some of the men will be held to account for a number of big jewelry robberies which have recently taken place. William F. Anteman, a jeweler in South Pearl St., in Albany, was the victim of a \$2,000 theft of diamonds recently. Mr. Anteman has been here the past two days, and he positively identified Bliss, one of the first men arrested, as one of the men who robbed him. He could not positively identify Young, the man arrested with Bliss.

Chief Cleveland has received a communication from police departments in other cities where the photographs of Bliss and Young have been identified. It is reported that Bliss is wanted for a connection with the robbery of \$7,000 worth of diamonds in a New York store. He operated then as J. R. Ritchie. The Pittsburg police believe that Bliss, under the name of John Rollins, and Young, as James Hoyt, were connected with a sensational diamond robbery in the store of E. P. Roberts & Son in Pittsburg during the holiday season in 1899. Hoyt engaged the attention of a clerk while Rollins slipped a tray of diamonds into a bag. They were captured and each was sentenced to the penitentiary for three and a half years. It

is also reported that Bliss is wanted in Boston.

After the Wineburgh robbery three men went through Lafayette St. in the direction of Rome. A woman saw one of the men place a package under an old stoop. She made an investigation, and unearched one of the clocks which the thieves had bought at the Wineburgh store. The woman positively identified Bliss and Young as two of the three men, and a Lafayette St. saloon-keeper who sold them drinks that afternoon also identified Young and Bliss.

There is no question but that four important arrests have been made. Even if the men cannot be held here they are wanted in other places.

No trace of the missing diamonds has been secured.

Bliss and Young were arraigned in police court to-day. They asked for a further adjournment in which to consult lawyers, and their request was granted. While they were in court parties positively identified them in connection with the Wineburgh robbery.

UTICA, N. Y., July 30.—There is a strong possibility that the diamonds stolen from Wineburgh & Sons' store may be returned to their owners before another issue of THE CIRCULAR-WEEKLY is published. It is understood that Bliss, who has been "sloughed away" four or five times by police departments, and, except for one instance, for diamond stealing, is beginning to dicker for light punishment conditional upon the return of the stolen diamonds. A letter, it is said, has been sent to Boston in Bliss' interests which may result in the return of the diamonds.

Railroad Detective Holstein, who arrested Reedy and Hayes, says he hopes to unearth the stolen diamonds. He intimates that they were hidden between Utica and Rome by Bliss, Young and the "tall man" who worked the Wineburgh case, and that he will learn the location of the hiding place.

There are some doubts in the minds of the police whether Reedy and Hayes can be connected with the Wineburgh robbery. The police know they were here the week of the robbery.

Bliss' picture published in THE CIRCULAR-WEEKLY is exactly like the one taken at the Fellsburg penitentiary after the diamond robbery there, except in the latter picture his hair is cut short. Besides the Pittsburg job, according to Inspector McLoughlin, of New York, Bliss turned a trick in Washington identical with the one so successfully worked here. According to the police, Bliss, under the name of John Roland, alias Ritchie, was arrested Nov. 24, 1899, in Pittsburg on complaint of A. E. Seidle, from whom he had stolen a tray of diamonds, and was sentenced Dec. 6, on plea of guilty, to the Western penitentiary for three and one-half years.

Under the name of Jones Reilly, alias John F. Ritchie, he was arrested in Philadelphia Jan. 14, 1898, for stealing a tray of diamonds, and sentenced to the penitentiary on a plea of guilty for two years, while as John Robinson he was arrested in Allegheny, Pa., for stealing a tray of diamonds on April 7, 1902, and on Feb. 6, 1903, was sentenced in Washington, D. C.,

to which police department he had been surrendered, to three years in prison.

July 12, 1886, Bliss was convicted at Boston of grand larceny, and sent to the Concord, (Mass.) Reformatory. On June 7, 1892, he was arrested at Boston for counterfeiting, and got a four years' sentence.

J. W. Watts, an attorney, managed to get into Bliss' cell and have a talk with the prisoner. This was against Chief Cleveland's orders, and when he learned of it he had the lawyer pulled out of the cell and searched. Watts had a letter written by Bliss and directed to a woman in Boston, requesting her "to get the goods back to Utica, and I won't have to do so long a stretch." The police retained possession of the letter. It is believed here that Bliss can raise sufficient cash to straighten out matters with Wineburgh & Sons if the stolen gems are not recovered.

Chief Cleveland has refused to allow any "dickers" with Bliss which entail any promises of lighter punishment provided the diamonds are returned. The chief intends to put Bliss away where he will not do any mischief for a few years.

Mr. Antemann, the Albany jeweler, has positively identified Bliss as one of the two men who robbed him. Bliss' partner engaged Antemann's attention with some stick pins in a show window, while Bliss committed the robbery. The Albany authorities will lodge a warrant here against Bliss.

### Many San Francisco Jewelers Reimbursed—Insurance Adjusters Making Rapid Progress.

SAN FRANCISCO, Cal., July 25.—The insurance adjusters are now making rapid progress in adjusting the large losses in this city. During the past few days a number of important adjustments affecting the jewelry trade have been made. The loss on the Shreve building, occupied by Shreve & Co., is placed at \$348,487.81 for actual fire damage. The insurance carried on the property was \$440,000, the sound value of which was \$544,156.51, and the salvage was \$195,668.70.

Moss, Inc., formerly in the retail jewelry business at 622 Market St., carried insurance to the amount of \$36,000 on a stock valued at \$37,856.53.

A. I. Hall & Son, wholesale jewelers, formerly at 3d and Mission Sts., but now in the Kamm building, on Market St., carried an insurance of \$73,000 on property valued at \$101,938.70. The salvage was \$9,728.83.

The Alphonse Judis Co., wholesale jewelers and diamond merchants, carried an inside insurance on stock amounting to \$25,000 and outside insurance amounting to \$15,000. The stock in the safe was inventoried at \$107,525, and the damage to it was fixed at \$20,000. Diamonds which were carried from the store and saved amounted to \$58,652.98; outside stock, \$89,211.47; the net loss stock outside of the safe was \$30,261.

Armer & Weinschenk, jewelry supply dealers, formerly in business on Sutter St., have received an insurance payment of \$7,000.

The Gorham Mfg. Co., formerly on Sutter St., but now located on Broadway, Oakland, has been paid insurance to the amount of \$24,000.



Copyright Applied For.

Kimberley Mine Workers

**O**UR MR. RICHARD FRIEDLANDER is now in Europe making heavy purchases of diamonds.

¶ We are now prepared to show our new importations, which will comprise a full line of

# DIAMONDS

of all grades.

¶ Large dealers will find it to their advantage to call and inspect these goods.

---

**R., L. & M. FRIEDLANDER,**

IMPORTERS OF DIAMONDS.

30 Maiden Lane,

New York.

97 Hatton Garden, London, Eng.

**Diamond Market Stronger Than Ever  
—United States the Best Market  
for Large Fine Stones.**

According to Leopold Stern, of Stern Bros. & Co., New York, who returned on Monday of last week from Europe on the *New York*, the diamond market abroad is stronger than ever before, and there has never been so much difficulty in obtaining stones in desirable sizes and qualities as there is now. The death of Alfred Beit, which is greatly deplored, will not affect the market in any way. Mr. Stern says that the "sights" accorded to the half dozen concerns in New York who buy rough stones direct from the syndicate are less frequent than formerly. He believes that the syndicate has applications for 15 times the quantity of diamonds which it is selling.

In all parts of the world the demand is increasing, and the United States continues to get the lion's share of the cleaner qualities of diamonds. So true is this, he says, that if he were a diamond merchant in London, or in other cities in Europe, and desired to buy stones in sizes from one-half carat upward, in the cleaner and best made goods, he would not go first to Amsterdam and Antwerp, but would come to New York. The diamonds cut here, in the sizes from half a carat up, Mr. Stern says, are not excelled in workmanship by those made in any other part of the world, and the material used here is the best.

This idea of Mr. Stern's that European merchants may yet come to New York to buy diamonds was called to the attention of several large importing firms by THE CIRCULAR-WEEKLY reporter, and they all agreed with him. It was pointed out that the rough diamonds are brought into this country free of duty. "The additional cost of labor in New York," said one manufacturer, "is more than compensated by superior workmanship, and does not nearly equal the 10 per cent. duty imposed on cut stones imported into the United States. It is, therefore, impossible for the foreign merchants to compete with the American cutters with any degree of success in the sale of the finer qualities of cut stones."

**Schedules Filed With Bankruptcy Petition of Frank T. Pearce, Providence, R. I., Show Heavy Liabilities.**

PROVIDENCE, R. I., July 25.—Frank T. Pearce, who does business as Frank T. Pearce & Co., a manufacturer of gold pens, at 85 Sprague St., has filed a petition in bankruptcy, giving liabilities of \$69,293.75 and assets of \$30,517.56. News of the failure was received with some little surprise.

The largest single claim is that of the Charles H. Perkins estate, and this is for \$24,750.36. The next heaviest creditor is the estate of Aldridge Gardiner, this being interested to the extent of \$17,024. Mr. Pearce's son, Aldridge G. Pearce, puts in a claim of \$2,700 for labor, \$1,000 for money loaned and \$10,000 in notes. Annie Pearce, the daughter, presents a claim of \$690. The Edwin Lowe Gold Plate Co. is the only other heavy creditor, the amount of this firm's claim being \$2,296.18, this bill having been contracted for materials furnished to the Pearce firm. This firm also holds

notes to the amount of approximately \$2,100.

An itemized statement of the assets is as follows: Cash on hand, \$2.18; stock in trade, \$16,000; machinery and tools, \$9,500; open accounts, \$5,000; money in bank, \$15.32. Total, \$30,517.56. According to the statement, this leaves a deficit of \$38,776.19. The preferred claims for labor amount to \$719.21, and there is a lengthy list of creditors for small amounts.

A meeting of the creditors has been called, and will be held in the office of Chester W. Barrows, referee in bankruptcy, Aug. 6, at 10 A. M.

**Bankruptcy Petition Filed Against Onondaga Art Metal Co. Following the Disappearance of Edward C. Howe.**

SYRACUSE, N. Y., July 30.—Edward C. Howe, who for many years was engaged in the jewelry business with his father, Henry J. Howe, and who six months ago started the Onondaga Art Metal Co., is missing, and Saturday a receiver for the concern was applied for on behalf of Syracuse creditors. It is known that Mr. Howe, who is about 33 years old, left his wife unprovided for.

The Howes are among the best known jewelers in the State. Henry J. Howe has conducted for many years, and still conducts, the largest jewelry store in the city at the corner of S Salina and Washington Sts., and up to six months ago his son Edward was in the business with him. The father backed the son largely, and is a heavy loser by the latter's misdeeds.

The petition in bankruptcy was filed by Attorney John C. Boland and Thomas A. Mara, superintendent of the shops, was appointed receiver of the concern. The petitioners are Charles J. Barker, who holds a promissory note for \$1,500 dated July 1, W. H. H. Chamberlain, who has a balance of \$39.25 due him, and Herman J. Gorke, who has \$60.30 due him.

The petition states that Howe's debts are \$12,000, and that the stock of the company is worth \$3,000 and accounts \$3,000 more. Considerable material is made up.

It is stated in the petition that on July 3, while insolvent, Howe gave to his father, Henry J. Howe, a chattel mortgage for \$4,000 on the machinery and other property for loans made between Sept. 1, 1905, and July 1, 1906. The petition states that Howe left his apartments July 12 and no word has been heard from him since.

**Clever Thief Steals Rings from Two Boston Jewelry Stores and Escapes.**

BOSTON, Mass., July 28.—Two thefts of rings from jewelry stores have taken place in Boston within a week, and circumstances point to the probability that the same man, well dressed, age about 21, committed both.

On Saturday last a cluster diamond ring was taken from a small tray, and a cheap ring substituted therefor while the clerk's attention was diverted, at Freeman & Taylor's, on Temple Pl. On Tuesday evening, by asking the clerk at H. Rahlin's, 323 Tremont St., to get another tray, opportunity was given the robber to lift three wedding rings and a diamond ring from a tray which had previously been set before him, and make his escape.

**Importations at the Port of New York.**

Weeks Ended July 21, 1905, and July 20, 1906.		
	1905.	1906.
China, Glass and Earthen Ware:		
China	\$118,298	\$114,526
Earthen ware	14,465	16,282
Glass ware	46,238	23,071
Optical glass	1,133	3,345
Instruments:		
Musical	15,496	73
Optical	9,847	18,810
Philosophical	1,373	1,132
Jewelry, etc.:		
Jewelry	8,654	16,807
Precious stones	468,290	1,376,072
Watches	79,403	37,006
Metals, etc.:		
Bronzes	250	1,356
Cutlery	32,678	33,640
Dutch metal	3,769	2,543
Platina	18,193	31,673
Silverware	1,847	.....
Miscellaneous:		
Alabaster ornaments	290	1,054
Amber	110	5,392
Beads	2,818	2,675
Clocks	2,703	5,659
Fans	2,350	4,832
Fancy goods	6,095	10,779
Ivory	35	.....
Ivory, manufactures of	873	304
Marble, manufactures of	14,014	16,540
Statuary	4,825	8,313

Weeks Ended July 28, 1905, and July 27, 1906.		
	1905.	1906.
China, Glass and Earthen Ware:		
China	\$99,203	\$131,221
Glass ware	19,302	40,843
Earthen ware	14,528	17,947
Optical glass	942	.....
Instruments:		
Musical	19,109	26,673
Optical	11,885	869
Philosophical	3,057	1,032
Jewelry, etc.:		
Jewelry	13,304	20,641
Precious stones	753,483	637,589
Watches	46,765	34,819
Metals:		
Bronzes	3,925	13,177
Cutlery	29,903	15,630
Dutch metal	8,686	4,495
Platina	31,066	43,418
Silverware	462	367
Miscellaneous:		
Alabaster ornaments	12	263
Amber	8,161	14,050
Beads	3,587	.....
Clocks	.....	11,387
Fans	1,542	3,437
Fancy goods	10,517	8,488
Ivory	19,964	.....
Ivory, manufactures of	1,415	3,083
Marble, manufactures of	16,759	20,585
Statuary	45,941	11,065

**Peter Foisey, Wallace, Idaho, Makes a General Assignment.**

WALLACE, Idaho, July 25.—Peter Foisey, a well-known jeweler of this city, made an assignment last week under State laws to Leonard E. Hanson, for the benefit of his creditors. According to the statement given out, Mr. Foisey's liabilities will amount to about \$5,000, while the value of his assets is placed at \$6,000; the latter consist principally of stock and fixtures.

Mr. Foisey has been in business here since 1897, having previously been located at Prescott and Pocatello. He had made but little progress, and had been hampered for ready cash for some time. It is hoped by his friends that he will be able to arrange with his creditors and continue his business at an early date.

Wm. Igo was taken into custody about a week ago, in Scranton, Pa., on a charge of selling jewelry without a license. He was given his choice of a fine of \$60 or of serving a sentence of 30 days.

*WE are receiving weekly shipments of desirable goods in all sizes and grades, at prices that will interest large buyers.*

**ARNSTEIN BROS. & CO.,**

*Importers and Cutters of*

**DIAMONDS,**

**65 Nassau Street, Corner John, NEW YORK.**

*LONDON, Audrey House, Ely Place. AMSTERDAM, 6 Tulp Straat.*

SEND TO US ANY QUANTITY OF

**AMERICAN PEARLS**

WE BUY FOR CASH.

Send by registered mail or express; we will make an offer by return mail. We will also buy any quantity of

**BAROQUE PEARLS (SLUGS).**

**BUNDE & UPMAYER CO.,**

Mack Block,

MILWAUKEE, WIS.

### Interesting Suit Between New York Jewelers Decided—Defendants Will Appeal.

In the suit of J. Finkel, of Locketz & Finkel, 218 E. Houston St., against the Brooklyn Watch Chain Co., 275 Bowery, Judge Rosenthal, of the Municipal Court, 7th District, Brooklyn, last week gave a judgment in favor of the plaintiff for \$27.87. The defendant company announced its intention of appealing to the Appellate Division, Second Department, Supreme Court.

This was the case in which the defendant sued to recover \$45, the purchase price of a quantity of gold slides. The defence was that the gold in the slides did not come up to the guarantee of 14 karat fineness. At the trial a representative of the United States Assay Office gave the results of assays of parts of three different slides that he had assayed. The fineness of the gold, according to his testimony, varied from 11 to a little more than 12 karats.

The plaintiff questioned the government employe in relation to his methods of testing gold, and endeavored to show that the assays were not fair, inasmuch as only portions of a slide were used. It was claimed by the plaintiff that the presence of solder accounted for the variations, and that an analysis of an entire slide would show that the gold was up to the 14 karat standard.

After the testimony was heard the defendant contended that at the most the court should not give a verdict for more than the reasonable value of the slides as indicated by the results of the assays.

The defendant company was represented at the trial by Louis Karasik. It has since retained for the remainder of the litigation Louis J. Jacoves. Sol L. Youngentob represented the plaintiff.

Mr. Youngentob, who some time ago served a summons on the members of the Brooklyn Watch Chain Co. in an action which he began against them in behalf of Mr. Finkel for damages for alleged malicious transaction, will serve his complaint in a few days. This action is based on charges made against his client in criminal proceedings, growing out of the same transaction. It was charged that the sale of the slides was in violation of Section 361J of the New York Penal Code, which allows a variation of only one karat from the mark on gold. Magistrate Finn dismissed the charges, and subsequently another magistrate refused to reopen the case.

### Death of Fred W. Dexter.

PAWTUCKET, R. I., July 25.—Fred W. Dexter, a well-known resident of this city, a former jeweler, died at his residence, 20 Brook St., yesterday afternoon. The cause of death was Bright's disease, with which he had suffered for several years.

Deceased was born in Pawtucket 48 years ago. After leaving school he entered the store of his father, W. W. Dexter, watchmaker and jeweler, on Main St., and later succeeded his father in the business. It was through his efforts that the Hope Land Co. was formed, he being elected vice-president and one of the directors, and for five of the six seasons the business has been carried on he was manager of the company.

In January, 1885, deceased married Miss Agness E. Muir.

### Van Ness Ave., San Francisco's New Retail District, Now the Scene of Numerous Shoppers.

SAN FRANCISCO, July 25.—The retail jewelry trade has been heavy during the past week, and it seems that as the number of stores increase, the volume of business increases in direct proportion. Many jewelers were slow in making up their minds to get back to business right away, and, in fact, the situation was anything but promising with 450 blocks of the business section of the city in total ruin and thousands of the population living in tents. Those who saw an immediate change for the better and at once made preparations for the resumption of business are now reaping a harvest while the backward ones are still engaged in store building and store fitting.

Van Ness Ave. is now the principal shopping district in the new San Francisco, and will probably remain so for several years to come. Its array of apartment houses and princely dwellings has given way to the great retail stores that lined Market St. and the vicinity of Kearney St., Grout Ave., Stockton and Post Sts. Trade had to be revived somewhere and immediately. San Francisco still has plenty of money to spend, and everyone is anxious to get fitted out again as soon as possible. Ladies wishing to replace their articles of jewelry and fancy goods do not wish to follow the business men into the burned area, where the scenes of ruin are on every hand and where the air is filled with dust. Shopping is reckoned as a holiday by women, and when they shop on Van Ness Ave. they are shopping on what has been the city's most aristocratic boulevard, just on the edge of the burned district.

To-day Van Ness Ave. resembles a great fair. The buildings are all of the same height, and most of them are painted white, and as each floats the pennant of the firm the appearance is that of a gala event. The jewelry trade is well represented in this new district. First of all to open were Hammersmith & Field, closely followed by Radke & Co., the Baldwin Jewelry Co. and the Diamond House. The Bohm-Bristol Co., Shreve & Co., the W. K. Vanderslice Co. and the Alexandra Jewelry Store are building, and all expect to be actively engaged in business by Sept. 1.

### Joseph Bardenheier, Missing Madison Wis., Jeweler, Robbed and Murdered.

MADISON, Wis., July 30.—The dead body of Joseph Bardenheier, a jeweler, who had been missing since last Monday, was found in the woods three miles east of here to-day. He had been robbed and murdered.

Mr. Bardenheier came here in April from Chicago, in which city he commenced business in 1893. He was 47 years old and a native of Germany. He learned his trade abroad, and came to the United States about 14 years ago.

Geo. O. Warren & Son is the firm style of the business conducted by Geo. O. Warren, Sycamore, Ill.

### New Stores and Enterprises.

J. Pastore is about to start in business in Tacoma, Wash.

Gilbert Tuttle, Boston, Mass., will shortly open a store in Winsted, Conn.

Andrew Johnson has opened a watch repairing shop in Lancaster, Minn.

Goldwater Bros., Seattle, Wash., have opened a branch store at Oakland, Cal.

E. C. McCarthy has begun business as a watch and jewelry repairer in Corsicana, Tex.

Wm. Lehberger will shortly engage in the retail jewelry business on West Broadway, Salem, N. J.

Clas. T. Blaum, Dothan, Ala., will soon move to Quitman, Ga., where he will open a new retail jewelry store.

C. H. Myers, formerly of Atlanta, Ga., has moved to Ellijay, Ga., where he has started in the retail jewelry business.

The Jennings Silver Co. was recently incorporated in Newark, N. J., with a capital of \$25,000 with \$1,000 paid in. The incorporators are: John Jennings and Edward Wright, Newark, N. J., and Silas Schwerin, Belleville, N. J.

The National Jewelry Co. is the name of a new concern in Portland, Me. The capital stock is \$10,000. The officers are: President, G. A. Leard, Portland; treasurer, Jas. Redmond, Springfield; clerk, D. A. Meaker, South Portland.

The Josten Mfg. Co., of Owatonna, Minn., was recently incorporated in the State of Minnesota with a capital stock of \$2,500, divided into 250 shares, to sell and repair watches and clocks, and to manufacture jewelers' fittings and tools.

The System Jewelry Co. was incorporated at Hartford, Conn., July 28, with a capital of \$5,000. Frank F. Day, Agnes S. Day and R. F. Barclay, Hartford, are the incorporators of the concern, which will carry on a wholesale and retail jewelry business.

The Currie Hardware & Furniture Co., Currie, Minn., has just added a line of jewelry, clocks, watches, etc., and also a watch and jewelry repairing department. With this new addition the concern has the only jewelry and repairing establishment at that place. The watch repairing department is in charge of a skilled watchmaker.

### Death of Percy Whitechurch.

PHILADELPHIA, Pa., July 29.—The many friends of Percy Whitechurch were grieved to learn that he had died yesterday, at his home at 2318 N. Park Ave. Mr. Whitechurch was well known in the clock trade, having been for many years treasurer of G. S. Lovell Clock Co., 18 S. 10th St.

The funeral services will be conducted at his late home and in St. John's Church, Cynwyd, Wednesday.

Ahern & Bergen, who a short time ago started in the plating business at Nashua, N. H., have dissolved partnership, and hereafter John Ahern will continue the business alone.

John Scheers, Appleton, Wis., has completed a watch in which the hands turn from right to left. The watch keeps good time. The inventor believes that it can be made valuable for certain commercial uses which he does not make public, and has applied for a patent upon it.

# American Energy

AND PUSH OF OUR BUYERS ABROAD HAVE RESULTED IN LARGE SHIPMENTS OF EXCEEDINGLY FINE AND MEDIUM QUALITIES OF THE FOLLOWING GOODS:

**Oriental Baroque Pearls**  
**Round and Button Pearls**  
**Round Tinted Pearls**  
**Half Pearls**  
**Round Cut Rubies**  
**Emeralds and Sapphires**  
**Aquamarines and Peridots**

WITH A WELL SELECTED AND COMPLETE STOCK OF GARNETS AND DOUBLETS, COMPRISING A LINE OF GOODS OF GREAT INTEREST TO THE AMERICAN JEWELER.

## *L. Heller & Son*

**Importers of Precious and Imitation Stones.**

New York, 51 Maiden Lane  
 TELEPHONE 219 JOHN.

Providence, 212 Union Street

Paris, 39 Rue de Chateaudun

Idar, 14 Hauptstrasse

GEORGE H. HODENPYL.

WALTER N. WALKER.

# DIAMONDS

AND

DIAMOND JEWELRY

# HODENPYL & WALKER

Unique  
 and  
 Staple Patterns

**170 Broadway, New York**  
 Corner of Maiden Lane  
 TELEPHONE. 1898 CORTLAND

Repairing and Recutting  
 Diamonds  
 a Specialty

OUR  
**40th**  
**YEAR**

IN  
 BUSINESS

1866=1906

**DIAMONDS**  
 LOOSE AND MOUNTED

**CASES and MOVEMENTS**  
 ALL MAKES AND GRADES

**JEWELRY**  
 GOLD AND PLATED

ORDERS SOLICITED FROM RESPONSIBLE JEWELERS. GOODS SENT ON SELECTION.

All our goods are either direct importations, our own manufacture or bought for cash, enabling us to offer special inducements in prices and terms.



EST. 1866.  
*Lissauer & Company*  
 Importers.  
 2 TULPSTRAAT,  
 AMSTERDAM.

**12 MAIDEN LANE.**  
 (ONE FLIGHT UP)  
 P. O. Box, 1625,  
**NEW YORK.**

## SAVE A TRIP TO PARIS

by calling at our office and looking over our line of the newest French Styles in

Combs, Brooches, Festoons, Hair Barrettes, Buckles, Crosses, Bracelets, in Jets and Metals

**CHOPARD FRÈRES,** Makers of Art Jewelry Novelties

PARIS, FRANCE—35 Rue des Trois Bornes

49 MAIDEN LANE, NEW YORK C TY

## Buffalo, N. Y.

Berthold Block, of B. Block & Co., jobbers, 520 Main St., went out on the road last Saturday after a vacation spent in this city.

Paul Kinney, East Aurora, son of Jireh Kinney, the veteran retailer of this city, who fell from a bicycle on July 9, remained insensible until last Thursday, when he spoke a few words. He lapses into unconsciousness at frequent intervals, but there is strong hope of his ultimate recovery.

Charles F. Damm, manufacturing jeweler, returned a few days ago from a fishing trip in Michigan. To prove that he did some good fishing, he came home with a photograph of himself and a big string of fish which he held in his hands. Freel Smith, traveling salesman for Mr. Damm, left Buffalo last Thursday for a road trip. One-half of Mr. Damm's shop force is on vacation this week. The other half goes next week.

Present & Co., 444 Main St., have begun extensive alterations in their jewelry store. The establishment is being enlarged, a 30-foot extension being made in the rear. A new and modern front is being put in, and also a modern electric lighting plant. Max Lowenthal, who represents Present & Co., Rochester, on the road, assisted in the store here during his vacation season. He returned to Rochester a few days ago to prepare for his road trip.

The convention of jewelers in Rochester this week was well attended by the members of the trade in this city. Nearly all members of the Buffalo Optical Society, including President Simcox, are attending the convention of opticians, also held in Rochester this week. Jewelers of Buffalo have no trade organization, and the merchants from here attended purely as individuals. The opticians here, however, have one of the strongest optical societies in the State. Its membership is made up of opticians and optical dealers in all the towns of western New York.

An accidental error was made in this column recently in a report that John W. Schlehr, 379 Main St., had purchased the establishment of the C. M. Plarr Mfg. Co., at 178 Ellicott St. Mr. Schlehr never had any intention of buying the establishment, and the Plarr concern never had any intention of selling out to Mr. Schlehr or to anybody else. The report grew out of a misunderstanding based on the fact that Mr. Schlehr was engaged by the C. M. Plarr Mfg. Co. as manager of the factory, which is one of the most extensive in the State. The factory now has a force of 19 skilled workmen, who are working overtime to enable the firm to fill its orders.

## Minneapolis and St. Paul.

Peter Aldine, with J. D. Bodfors, Minneapolis, has returned from a three weeks' vacation.

J. W. Robertson, St. Paul, has moved from 322 Jackson St. to 505 Wabasha, where he has opened a new store. He will make a specialty of watch repairing and engraving.

The attendance at the meeting of the Jew-

elers' Association at the Nicollet Hotel, Minneapolis, last week, was large and an interesting and instructive convention was had. After the convention adjourned Thursday the association went to Lake Minnetonka and made a tour of the lake.

A case was heard in the police court in St. Paul last week, where a second-hand clothing and jewelry salesman swindled a young farmer by selling him a bogus watch for \$20, on the claim that it was of Swiss manufacture and had 21 jewels. The proprietor and his clerk were both fined. This is noticeable in that such complaints are becoming very rare.

## San Francisco.

P. W. Wierthin, formerly located at 246 Sutter St., is now at 1062 McAllister St., where he has a small shop.

M. Bratlavsky, dealer in diamonds and jewelry, and who also does repair work, is now located at 964 McAllister St.

Mr. Matthews, of A. I. Hall & Son, has been absent on account of illness, but will probably be able to resume his duties this week.

Karl Eber & Co. are now fitting up their new jewelry store on Post St., near Van Ness Ave., and expect to be able to open in a short time.

Dereemer & Co., who formerly had a store at 137 Montgomery St., has secured a first-class location at 1345 Van Ness Ave., and will open for business there at once.

The Keystone Jewelry Co. has secured a location in front of Tait's Cafe at the corner of Eddy St. and Van Ness Ave., and work is being rushed on the store to make it ready for the opening.

Hammersmith & Field are now doing a good business at their store at Eddy St. and Van Ness Ave., and have begun to wish that they had more room, although the present store is about as large as the one on Kearny St. before the fire.

The United Jewelry & Optical Co. has secured a location at 1653 Fillmore St., and is now busily engaged in fitting up a fine large store there. Here a manufacturing establishment will be established and jewelry handled in both a wholesale and retail way.

The Macey Jewelry Co. has its store at Post and Fillmore Sts. completed, and a fairly complete stock is being carried. The store may be cited as an example of the rise in rentals on Fillmore St. since the fire. The space is but a small one of not more than 150 square feet, and could formerly be secured for \$50 a month, but the rate now is \$360.

The Baldwin Jewelry Co. opened its fine new store to the public last week, and already the volume of business agrees favorably with that of the old Market St. store. This firm expects to move back into the old retail district as soon as conditions warrant it, but also think that Van Ness Ave. will retain permanently in a measure its present position as a shopping district.

Paul V. Garin, whose jewelry store on Fillmore St., near Geary St., was opened only two weeks ago, states that he has found business so heavy that additional help has been secured to attend to it. The chief trouble now is getting supplies. The

transportation companies have more freight offered them than can be handled, and many shipments take from 30 to 40 days to come from New York.

## Optical Notes and Briefs.

The Davis-Elfen Optical Co. has opened an office on 14th St., Oakland, Cal.

Dr. C. J. Larson, eye specialist, Bemidji, Minn., has moved his offices into the Swed-back block.

The Chinn-Beretta Optical Co., Oakland, Cal., has taken a three years' lease on a store on the west side of Van Ness Ave., near California St., San Francisco.

D. G. Gallett, Aberdeen, S. Dak., is attending the meeting of the American Association of Opticians at Rochester, N. Y., as a delegate from the South Dakota Jewelers' Association.

Judge Troutt has decided in favor of Conrad Gatzent in an action against J. Lerk, the Chinn-Beretta Optical Co. and others for the restitution of premises at 1821 Fillmore St., San Francisco, Cal., and damages. It was held that the renting of the premises to Mr. Lerk on a non-subletting lease had been violated by the renting of the property to the optical company and others.

The State Association of Optometrists of Minnesota closed its 11th semi-annual session at the Studio Arcade, 804 Nicollet Ave., Minneapolis, July 26. The convention lasted three days, and a number of interesting addresses were listened to. Fifteen new members were admitted to the association during the convention. On Thursday afternoon the members joined the State Jewelers' Association for a tour of Lake Minnetonka.

## Trans-Atlantic Voyagers.

### FROM EUROPE.

Herman Levy, of New York, returned from Europe recently on the *Teutonic*.

Leopold Stern, of Stern Bros. & Co., New York, returned last week on the *New York*.

Richard Friedlander, of R., L. & M. Friedlander, New York, returned this week on the *Amerika*.

Samuel Stohr, with the International Silver Co., Meriden, Conn., returns this week on the *Amerika*.

Carl H. Weidemann, of Borrelli & Vitelli, New York, returned from Europe this week on the *Koenigin Louise*.

D. Atlas, of Atlas & Fisher, Philadelphia, Pa., returned last week on the *Vaderland*.

Christian Scherfig, New York representative of the Royal Copenhagen Porcelain Co., will return in a week or so.

Returning recently on the *Kronprinz Wilhelm* were E. Arnstein, of Arnstein Bros. & Co., New York; David Zimmern, of Zimmern, Rees & Co., New York; A. D. Harrington, of the Shreve, Crump & Low Co., Boston, Mass.

### TO EUROPE.

S. H. Friend, San Francisco, Cal., sailed yesterday on the *Kronprinz Wilhelm*.

H. W. Selts, Clay Center, Kans., has just returned from a vacation trip through Canada.

# Chester Billings & Son

1840

Successors to  
Kandel, Barmore & Billings

1906

Importers of Diamonds  
Other Precious Stones, and  
Pearls, Diamond Jewelry

1840, Kandel & Barmore; 1866, Kandel, Barmore & Co.; 1880, Kandel, Barmore & Billings; 1897, Chester Billings & Son

New York, 58 Nassau Street, 29 Maiden Lane  
London: 22 Holborn Viaduct, E. C. Paris: 53 Rue de Chateaudun  
Amsterdam: 2 Culp Straat

# My Specialty

WHEN a house is known to excel its competitors in any one attribute, it becomes recognized as "a specialist." I will pay a better cash price for jewelry and precious stones that your customers wish to dispose of, and you do not care to purchase yourself, than any other concern. Send me a trial selection and be convinced.

*Entire Stocks and Estates Bought*

*Bank References Given*

*Everyone knows that I pay more for*

**AMERICAN PEARLS**

*than any other firm.*

**Maurice Brower**

12-16 John St., New York

Telephone, 6233 Cortlandt



## COOPER'S SUN RAY DIAMOND

HAS 100 per cent. more brilliancy than any other style of cutting.

***We Challenge the World.***

Send your old mine and yellow diamonds to be recut; if the effect is not 100 per cent. better, NO CHARGE.

## COOPER DIAMOND

Cutting and Polishing Industry of America

49 MAIDEN LANE, NEW YORK.

Factories, 8th Ave. & 18th St., Brooklyn.

# EDUARD VAN DAM



## Trade Gossip.

I. J. Sharick, of the Alaska Jewelry Co., Juneau, Alaska, recently secured the agency in that city and southern Alaska for the official emblem of the Alaska-Yukon-Pacific Exposition. This emblem is unique in many features, being in the form of an Alaska nugget beautifully engraved. On the front appears a profile head between the figures 1909 having above it in raised letters the words "Alaska-Yukon-Pacific Exposition," and below "The Queen City Extends a Welcome to the World."

The beautiful silver service to be presented to the battleship *Louisiana*, the contract for which was recently awarded to Coleman E. Adler, New Orleans, La., was designed and will be made by the Frank W. Smith Co., Gardner, Mass., who are now at work upon it. The pieces which are to comprise the service were described in THE CIRCULAR-WEEKLY, July 4, and the account contained a typographical error, having made the statement that the centerpiece would weigh about 22,000 ounces. This should have read 2,000 ounces.

In view of increasing business, the Langendorf Watch Co., Langendorf, Switzerland, which already employed about 1,500 workmen, is about to open another addition to the many buildings, consisting of a four-story structure with a frontage of 32 windows, enabling it to add 500 more hands to its working force. This new building will be ready for occupancy in a few weeks. The manager of this watch factory is Mr. Kottmann, who visits the watch market personally at intervals of a year or two, and is therefore well known among the wholesale watch people.

A dainty little pamphlet, as unique as it is artistic, has been issued by the Oneida Community, Ltd. It is entitled "Some Business Ideals of the Oneida Community," and traces the development of the present organization and its products from the foundations laid by the original members of the Community many years ago. The typographical and artistic features of the pamphlet are admirable. The cover, in a cream tint, has a pressed panel, in which is suspended a rich design, the latter being caught at the top only. The cover and pages are deckle edged. Handsome illustrations in tint are applied to the pages by the same method employed with the cover design. These show the spacious edifice known as the Community Home, a picturesque landscape, including the historic Oneida Creek, and a chaste example of the Flower-de-Luce design so widely advertised. Rich greens and gray predominate in the interior decorative effects. The interesting text of the pamphlet takes the form of a simple essay, devoid of the advertising features which commonly characterize such publications.

Under the title of "Creations in New Jewelry," A. Ludwig & Son, New York, have issued a volume of 32 pages, 9 by 12 inches, with a brown deckle-edged cover. This elaborate and beautiful catalogue is not intended to present a complete list of the products made at the company's factory, 75 Nassau St., but to call attention to the variety and exclusiveness of the designs. A large number of the articles are repre-

sented by excellent pictorial illustrations, some in colors. The turquoise matrix and baroque pearls, in brooches and necklaces, are especially clear and true in color effects. The company's collection of genuine sky-blue turquoise and turquoise matrix from Persia is declared to be most comprehensive, and this is equally true of the assortment of robin's egg blue turquoise from New Mexico. In the reading matter of the book attention is called to the merits of the company's jewelry set with genuine precious stones, and a feature is also made of high-grade designs in which manufactured pearls, rubies, emeralds and sapphires are set in gold and platinum. The Ludwigs claim to have kept in the family for many years a secret of manufacturing precious stones and pearls, so as to give them brilliancy and lasting qualities.

## Baltimore.

George V. Webster, who was arrested on the charge of stealing jewelry and money from Jacob Levi, was dismissed last week, as Mr. Levi declined to prosecute. John W. Webster, father of the accused, was present when his son was dismissed.

Frank Bushman was arraigned before Justice Grannan, Friday, at the Central Police Station, charged with embezzlement by his former employer, Jacob Katz, 657 Calvert building. When the warrant was applied for it was stated that the young man was employed as a salesman, and failed to make returns for money which he collected on sales of jewelry. The amount of shortage, it is charged, will reach \$139. The hearing was postponed.

Lewis Minks, head of the Minks Badge Co., was released for court Friday afternoon on his own recognizance by Justice Grannan at the Central Police Station. The charge brought against Mr. Minks is that of counterfeiting and printing illegally the label of the Allied Printing Trades' Council. Mr. Minks declared that he had full authority, under grant of an officer of a branch organization, to use the label, and that he had been instructed under no circumstances to surrender it. This point was denied by William J. Hanafin, president of the Typographical Union, who testified that authority to use the label could emanate only from the former organization, and not from an officer of any other organization not chartered by it. The contention made in Mr. Mink's behalf was that there had been a split in the trades union, and that one of the two factions was as rightfully entitled to the use of the label as was the other.

A. B. Wood, Crosssett, Ark., has admitted his son into the business and the firm name is now A. B. Wood & Son.

Frank Wuerth, of Wuerth & Son, Leavenworth, Kans., will spend the month of August in the wilds of Minnesota, fishing and hunting, with a party from Leavenworth.

At the annual meeting of the stockholders of the Middletown Silver Co., Middletown, Conn., the following directors were elected for the ensuing year: Chas. Fountain, Joseph Merriam, F. L. Sage, Edward S. Davis, Middletown, and M. S. Cornell, of Brooklyn, N. Y. The old board of officers were re-elected.

## ELSIE BEE'S FASHIONS.

NOVELTIES SEEN IN A LADY'S RAMBLES AMONG THE JEWELERS.

VERY handsome is a smoking set of two pieces in a silk-lined box, the gold case with a match box to correspond being decorated with a design of twisted serpents finished in pale green enamels and gold.

\*

The Summer girl wishing novelty in shirt waist sets may choose a mannish style of three studs with sleeve links to match in blood coral, gold or green.

\*

Sky-blue turquoise is shown with fetching effect in a neck ornament consisting of an extremely long string of round beads, in graduated sizes, that is finished with a pretty diamond clasp.

\*

A new style in a gold bar pin has a square-cut green stone in the middle, while from each end of the bar depends a chain about two inches long, formed of the same small square stones, with pearls between.

\*

A most charming gold purse with chain and finger ring attached is richly finished with an elaborate design in the gold, the inside of the case being furnished with a little pocket with catch and a place for cards.

\*

Aside from the regulation styles in rings everywhere seen, in which choice stones are the attraction, some fancy tops are shown. One displays a diamond, a ruby and an emerald, set like a three-lobed leaf in surrounding diamond work. Another has a diamond bar likewise set in diamond work.

\*

An odd pendant is of triangular shape and formed of long gold stems twisted into an ornamental design which ends at the bottom in two enameled leaf sprays crossing each other. In the center of the open design thus formed, and from the point where the leaf sprays cross, depends a large diamond.

\*

One of the new styles in drop-stones is successfully exploited in a necklace wherein oblongs of fire opals are connected into a chain by beautiful diamond work, the large stone at the throat being set in a brooch-like frame. Across the front elongated drop-stones with diamond caps depend from the stones in the necklace.

\*

Many charming variations continue to appear in collars. A wholly unique idea is shown in a model in which 12 rows of pink coral beads are spaced with inch-wide bars of gold embellished with a design of crickets and grasses in pale green enamels. Another novelty is a collar showing a wide band of black velvet decorated with rather odd diamond slides and a diamond clasp. A third style that is quite original is a fancy criss-cross pattern composed of diamonds alternating with green tourmalines, the pattern running down in a V-shape at the throat. From the point dangle oblong drop-stones of green tourmalines.

# WM S. HEDGES & CO.,

IMPORTERS AND CUTTERS OF

## DIAMONDS.

Precious Stones and Pearls.

170 Broadway, Corner Maiden Lane, New York.

27 Holborn Viaduct, London.

Saunders, Meurer & Co. Cutters and Importers of

## DIAMONDS AND OTHER PRECIOUS STONES

FINE PEARLS A SPECIALTY.

65 Nassau St., cor. John St., Prescott Building, Telephone, 1613 Cortland. NEW YORK.

Chas. L. Power & Co., Cutters and Importers,

## DIAMONDS

AND OTHER PRECIOUS STONES,

170 Broadway, corner Maiden Lane, NEW YORK.

27 Holborn Viaduct, London.

## GOODFRIEND BROS.,

IMPORTERS AND CUTTERS OF PRECIOUS AND IMITATION STONES.

Pearls

Rubies

Sapphires

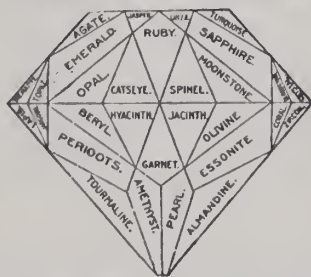

Tourmalines

Gem Corals

Opals

Emeralds

COPYRIGHT, 1895, BY GOODFRIEND BROS.

266 Westminster St., Providence, R. I.  
10 Rue Cadet, Paris.

Tel. No. 662 Cortl.

9-11-13 Maiden Lane, New York.

## CORAL

BORRELLI & VITELLI,

CORAL MANUFACTURING COMPANY,

All kinds of Coral—DROPS, BUTTONS, LENTILLES.

CORAL NECKLACES, Graduated and Uniform.

PINK AND WHITE CORAL A SPECIALTY.

GOLD MEDAL, ST. LOUIS, 1904.

GRAND PRIX, LIEGE, 1905.

3 Via Amadeo, Torre del Greco, Italy.

32 Rue d'Hauteville, Paris, France.

401 Broadway, New York.

Telephone, 5412 Franklin.

CORAL

CORAL

## Last Week's New York Arrivals.

THE CIRCULAR-WEEKLY each day posts in its office a bulletin of the latest buyers visiting New York, which every member of the trade is cordially invited to copy,

For the sum of \$10 (payable in advance), a daily list will be mailed or delivered, during the Fall season (Aug. 1—Dec. 15), to the offices of those desiring this service.

- AIKEN, S. C., B. F. Grohmann, Grand Union.  
ALBANY, N. Y., M. B. Dearstyne (J. G. Myers Co.), Herald Sq.  
M. Gips, Herald Sq.  
ALTOONA, PA., M. Berman, Broadway Central.  
BALTIMORE, MD., S. Cohen (S. Cohen & Son), Everett House.  
J. F. Plummer, Gilsey.  
BOSTON, MASS., S. Gordon, Grand Union.  
F. B. Maynard, Cadillac.  
BRATTLEBORO, VT., G. H. Clapp (A. B. Clapp & Co.), Ashland.  
BUFFALO, N. Y., S. A. Meister (Sweeney Co.), Grand.  
CHICAGO, M. L. Manheimer (L. Manheimer & Bros.), Netherland.  
L. Felsenthal (Felsenthal Bros. & Co.), Herald Sq.  
Miss M. Lawler (Rothschild & Co.), 43 Leonard St.  
H. J. Todd (Rothschild & Co.), 43 Leonard St.  
E. L. Young, Park Ave.  
CHILLICOTHE, O., O. J. Fuchs, Sinclair.  
COATESVILLE, PA., H. Garman, Astor House.  
COLUMBUS, O., F. H. Auld (D. L. Auld Co.), Imperial.  
W. G. Bancroft (Bancroft Bros. Co.), Herald Sq.  
COVINGTON, KY., J. F. Pieper (F. Pieper), Herald Sq.  
DETROIT, MICH., R. C. Traub (Traub Bros. & Co.), Navarre.  
DILLON, MONT., F. Huber (Huber Bros.), Albert.  
DOTHAN, ALA., C. T. Blaum (Dothan Jewelry Co.), Astor House.  
DULUTH, MINN., A. R. Chamberlain (Panton & White Co.), 31 Union Sq.  
J. F. Kearney (Panton & White Co.), Prince George.  
HARRISBURG, PA., W. P. Denehy, Herald Sq.  
HONESDALE, PA., Mrs. C. P. Eldred, Cosmopolitan.  
INDIANAPOLIS, IND., W. D. Sanford (Pettis Dry Goods Co.), 2 Walker St.  
IONIA, MICH., A. G. Bedford, Herald Sq.  
MEMPHIS, TENN., H. Crohn, Herald Sq.  
MINNEAPOLIS, MINN., J. J. West (Powers Mercantile Co.), 214 Church St.  
C. E. Fisher (Wm. Donaldson & Co.), Herald Sq.  
NEW HAVEN, CONN., Miss C. Potter (Howe & Stetson Co.), 75 Spring St.  
NEW ORLEANS, LA., H. J. Robbert, Imperial.  
OMAHA, NEBR., H. Copley, Navarre.  
P. H. Johnson (Hayden Bros.), Albert.  
PHILADELPHIA, PA., E. Brchin (Gimbel Bros.), Albert.  
C. L. Marks (Marks Bros.), Cumberland.  
PORTLAND, ME., W. E. Carter (Carter Bros. Co.), Herald Sq.  
RICHMOND, VA., J. H. Gilloaly (Miller & Rhoads), 320 Church St.  
SAN DIEGO, CAL., C. W. Ernesting, Imperial.  
SAN FRANCISCO, CAL., B. M. Joseph (R. Weill & Co.), Herald Sq.  
SPOKANE, WASH., W. S. Newton (Spokane Dry Goods Co.), Wellington.  
SPRINGFIELD, ILL., J. C. Klaholt, Breslin.  
ST. PAUL, MINN., J. A. Stolberg (The Golden Rule), Navarre.  
TROY, N. Y., J. W. F. Podmore (Jones & Podmore), Albert.  
WHEELING, W. VA., J. W. Grubb, Grand.

## News Gleanings.

Geo. H. Cook & Co. have sold their store in Prescott, Ariz., to O. A. Hesla.

Gustave Lanz, Norristown, Pa., last week installed new fixtures in his store.

J. A. Robinson has purchased the business of J. H. Newell, Lyndon, Kans.

C. A. Palmer, Purdy, Mo., has purchased the store of A. B. Stroud, at the same place.

Beryl Harris, Moundsville, W. Va., has just added a large new safe to his office equipment.

W. E. Burrell & Co., Fairbury, Nebr., have been incorporated with a capital stock of \$10,000.

The death is reported of Rowena Kirkpatrick, wife of A. J. Kirkpatrick, Oklahoma City, Okla.

Tobias Johnson, Neillsville, Wis., has sold out to P. W. Nelson, Black River Falls, Wis., and retired.

P. H. Boyson, of the Boyson Co., Cedar Rapids, Ia., was married recently to Miss Harriet J. Dayton.

The Reineman-Blose Co. was recently incorporated in McKeesport, Pa., with a capital stock of \$40,000.

Extensive improvements are being made to the exterior of the store of A. Davidson, Washington, N. J.

G. A. Schlechter, Reading, Pa., accompanied by his wife, has just returned from a trip along the Great Lakes.

J. C. Mellichamp will open his new store at 70 Whitehall St., Atlanta, Ga., about Aug. 15. The new quarters are about to be renovated.

Chas. E. Dallman, Woonsocket, R. I., has just been appointed watch inspector for the Midland and Western divisions of the New York, New Haven & Hartford Railroad.

Thomas Howard was arrested in Schenectady, N. Y., about a week ago for selling cheap jewelry without a license. He was released after paying the small fine of \$1.

The new building which is being erected in Elmira Heights, N. Y., for the Enterprise Cut Glass Co., is rapidly nearing completion, and the concern expects to be able to occupy the plant within the next three weeks.

C. J. Ward, Andalusia, Ala., has sold a half interest in his business to R. E. Holman, of Ozark. The firm hereafter will be known as the Andalusia Jewelry Co. Mr. Ward will continue to manage the business.

Bert Frank, a buyer of old gold, was arrested Wednesday in Richmond, Va., on a warrant secured by Dr. Davison, a dentist, who charged him with attempting to defraud by means of fraudulent weights and measures. Frank denied the charge.

Judson C. Moyers, Jackson, Mich., has purchased the old Tomlinson building adjoining his present store. Mr. Moyers began his career in the jewelry business as a clerk in this old building 16 years ago. He intends to raze the structure and erect a modern building on the site.

A new concern has started an establishment in Camilla, Ga., known as the City Jewelry Store. The capital stock, all of which is paid in, is \$3,000. The officers are: President, C. L. Taylor; vice-president, E. E. Cox; secretary, J. C. Wilson. The firm will continue the business of C. L. Taylor.

A decision was rendered recently in favor of W. F. Bailey in the case of Albert Pfeifer & Bro., Little Rock, Ark., against the defendant. The plaintiffs sued to enjoin Bailey from working for Chas. S. Stiff, claiming that they had a contract with Bailey to work for them. The injunction was refused.

Last Sunday about 200 members of the Jewelers' Protective Association of Buffalo, N. Y., enjoyed an excursion and picnic at Cascade Park, a resort near that city on the Pennsylvania Railroad. It was the first outing of the season by the members of this association. There were games between different sets of factory employees.

Thieves recently broke into the store of W. W. Bugg, 132 W. Main St., Jackson, Mich., making off with nine diamond rings, 15 opal and diamond rings, six signet rings, one gold-plated bracelet, several watches and watch cases, and about a dozen ladies' chains. A reward of \$50 has been offered for the apprehension of the thieves.

E. M. Nelson's jewelry store, Williston, N. Dak., was entered recently by burglars who stole miscellaneous jewelry and other stock valued in all at about \$400. Mr. Nelson has been engaged in business in Williston only a few weeks, and all of his stock was new. He had no safe, and left his stock in the show cases. There is no clue to the thieves.

D. B. Bancroft, Detroit, Mich., has in his possession a rare relic in the form of two large copper spoons made from a mold, which antiquated utensils were in common use among our forefathers. The spoons were handed down from Adam Manwaring, grandfather of Mr. Bancroft, and they came into the possession of the grandfather in 1778, having been handed down from other ancestors.

John E. Schwarz has been appointed trustee in bankruptcy for Sternberg & Co., Savannah, Ga., and has given bond in the sum of \$10,000. Under a former action originating in the Superior Court of Chatham County, A. M. Hull was appointed receiver and ordered to dispose of the stock. Mr. Hull has now been ordered by Judge Cann to deliver all assets in his possession to Receiver Schwarz.

Mr. Gorman, of Gorman & Green, Salisbury, N. C., was instrumental in causing the arrest on Tuesday of last week of the thief who had previously broken into the home of W. H. Holt, at Spencer, and stolen a watch and other valuables. The man had offered the watch for sale to Mr. Gorman, who at once recognized the timepiece, Mr. Holt having previously given him the number of the movement.

H. Bealmear & Co., Baltimore, Md., contrary to a previously published report, are not engaged in the jewelry business in their new location, 25 W. Baltimore St., but in the regular wholesale business which they have conducted for several years as clock, bronze, art novelty, cut glass and silverware dealers. The firm's old quarters at 25 S. Charles St. were destroyed in the conflagration of Feb. 7, 1904.

Jos. H. Pariseault was taken into custody about a week ago in Fall River, Mass., on a charge of larceny preferred against him by the Foster Co., of that place. Pariseault had been a clerk in the employ of the con-

cern, and, it is alleged, systematically stole timepieces, rings, scarf pins, etc. Thirteen watches were recovered from different pawnshops where Pariseault had pledged them under various names. When subsequently arraigned in court the accused pleaded guilty and escaped upon the payment of costs to the amount of \$2.60, the manager of the concern having refused to prosecute him.

R. N. Whitford, vice-president and general manager of the Hofman Jewelry Co., Columbus, O., arrived in New York Monday, accompanied by C. W. Ernesting, San Diego, Cal., and together will have charge of an exhibition of California gems which will be made in the metropolis. Mr. Whitford and his associate, O. S. Hofman, the president of the Hofman Jewelry Co., who has been a resident of San Diego for the past year, have become much interested in the gems of California, and recently located a new tourmaline mine which is known as the Hof-Whit Gem Mine. They have also become associated with Frank A. Salmon and Mr. Ernesting in the ownership of the latter's kunzite mine, and are now interested in several other mines, among them Pala Chief, Tourmaline King, Tourmaline Queen and Homestake, which they are to actively develop. Mr. Whitford and Mr. Ernesting brought from San Diego one of the finest collections of kunzite and other California stones that has been assembled together, taking them first to Columbus and then to this city.

### Report of a Diamond Find Near Lake Nipissing, in Canada.

MONTREAL, July 31.—Geologists for years have been predicting that diamonds would some day be found in a great temagami country, which lies between Lake Nipissing, in Ontario, and Lake Temiskaming, and it is now believed that at last the expected deposits have been tapped. The Rev. Father Paradis, who is well known throughout eastern Canada for the work he has done in making known the resources of the Lake Temiskaming country, was at the Canadian Pacific Railway Co.'s offices in Montreal last week, and brought the news that Adolphe O. Aubin, who represents Nipissing West in the Ontario Legislature, has in his possession a stone which is believed to be one of the largest diamonds known. The stone was secured from a man who found it in the Lake Nipissing district.

"Nearly every connoisseur who has examined it," said Father Paradis, "has pronounced the stone to be a diamond, and the discovery has naturally caused a great deal of excitement. I myself have seen the stone. It is as large as a hen's egg, and has a rough surface and a yellowish tinge. All the usual tests have been applied to it, and if these tests are infallible, then it certainly is a diamond. Mr. Aubin has already been offered thousands of dollars for it, but has refused to sell it. He is going to have it cut himself."

Father Paradis pointed out that if this stone really proves to be a diamond it will be one of the largest in the world. So far there have been no authenticated finds of diamonds in Canada, though the geologic formation is right for them.

ADDISON W. WOODHULL, President.  
FRANK K. HUFF, Vice-President.

GILBERT T. WOODHULL, Treasurer.  
WILLIAM J. McQUILLIN, Secretary.

# MOUNT & WOODHULL,

IMPORTERS OF

DIAMONDS,  
OTHER PRECIOUS STONES,  
PEARLS, ETC.

MAKERS OF

FINE  
DIAMOND  
JEWELRY.

26 Maiden Lane,

(Southwest Corner Nassau Street)

NEW YORK.

PARIS ADDRESS:  
5 SQUARE DE L'OPERA.

**BAGG, PERINE & CO.,**  
RARE SPECIMENS OF  
DIAMONDS AND OTHER  
PRECIOUS STONES,  
21 & 23 MAIDEN LANE, NEW YORK.  
Tel. No. 6228 Cortlandt.

EMERALDS,  
DIAMONDS  
AND  
PEARLS.

RUBIES AND  
SAPPHIRES.

CABLE ADDRESS:  
MILBAGG.

## Pearl Necklaces and Collarettes.

Mounted  
Diamond  
Jewelry

of every  
description.

*Ludwig Nissen*

*Miller*

*Wieder*

*Emil Knopf*  
*John W. Rueler*  
*Frank L. Wood*

Large  
assortment  
of all kinds of  
very fine, fancy  
and rare gems,  
including Pearls,  
Diamonds, Rubies,  
Emeralds and Sapphires.

182 & 184 BROADWAY  
NEW YORK

Particularly Fancy  
Colored and Fancy  
Shaped Diamonds.

## Canada Notes.

The stock of T. Edwards, London, Ont., has been sold.

R. D. Baker has opened a new jewelry store in Milton, Ont.

Chas. Braund, Austin, Alberta, has been succeeded by E. C. Lake.

M. P. McCaffrey, optician, Halifax, has given a chattel mortgage for \$969.

Llewellyn B. Williams, optician, has given a bill of sale for \$4,700 to T. J. McNally.

Mrs. Alberta J. Hostetler, wife of Lafayette Hostetler, New Hamburg, Ont., died recently.

J. T. A. Gaucher, Maisonneuve, Montreal, was married in Toronto, Ont., July 18, to Miss Lotta Cerré, of that city.

David J. Collis, Fenelon Falls, Ont., has assigned to Peter Mitchell. A meeting of creditors was called for July 28.

The act respecting the sales and marking of manufactures of gold and silver has been passed by the Canadian Parliament.

J. Paul, head watchmaker in the store of George E. Trorey, Vancouver, B. C., passed through Toronto, recently, en route for New York.

Frank Bickerdike has presented to the winners of the trial four-oar rowing crews of Lachine the prize cups given by Henry Birks & Sons, Montreal.

Benjamin Kent, of B. & H. B. Kent, Toronto, Ont., returned last week after an extended purchasing trip to Europe, accompanied by his wife and daughter. He was impressed by the increased demand for diamonds, notwithstanding the steady rise in price. He placed extensive orders for gems, novelties and art goods.

M. F. St. John, jewelry importer and manufacturers' agent, was found dead in his office at the Temple building, St. James St., Montreal, at 2 o'clock, Tuesday afternoon, July 24. Prussic acid was the means taken by the dead man to put an end to his existence. St. John was at one time well known in Winnipeg and in the northwest, where he traveled, selling principally jewelry.

Out-of-town buyers calling on the Toronto, Ont., trade last week, included: John McClelland, Kirkfield, Ont.; H. Shephard, Paisley, Ont.; D. Beith, Sudbury, Ont.; G. J. Porte, Winnipeg, Man.; J. H. Havill, Hamilton, Ont.; J. Pequegnat, Stratford, Ont.; J. F. Van Dusen, Dundalk, Ont.; E. S. Cole, Niagara Falls, Ont.; G. A. Shaver, Arthur, Ont.; H. W. Hurchmer, Bobcaygeon, Ont.

Henry Henkle, who said his home was in Morrisburg, Ont., has been arrested on a charge of stealing two diamond rings from W. E. Hayes' store, Montreal. He was examining a tray of rings when one of the clerks noticed him slip a couple into his vest pocket. He was held in the store until detectives arrived in response to a telephone call, and when he was searched at police headquarters a check for \$185, which was supposed to be bogus, was found in his possession.

The death is reported of Wm. Mosbacher, Wichita, Kans.

C. D. Hunt, Garnett, Kans., and wife have gone to Colorado to spend their Summer vacation.

## North Attleboro.

S. D. McPherson and Leroy Thompson, salesmen for C. Ray Randall & Co., were at the factory the early part of this week.

A 150 pound die fell on the toes of Frank Griffiths at the George Robson Co.'s factory, last Thursday, crushing them very badly.

Alvin Chisholm, of the Bugbee & Niles Co., was confined to his home several days last week. While stooping to pick up an article he injured his back.

George G. Waecler and Fred H. Carpenter have gone to Rochester, N. Y., to prepare the display of the W. & S. Blackinton Co., at the big retail jewelers' convention.

Actual work commenced, last week, on the new Manufacturers' jewelry factory that will be built on Elm St. Early in the week the contract was given to E. K. Watson, of Warren, R. I., and the land was staked out several days later. The new building will be ready for occupancy by Dec. 1, if the terms of the contract are fulfilled. The trustees of the new building are: W. B. Arnold, Boston; W. W. Sherman, of the H. D. Merritt Co., and Clarence W. Fisher, of E. I. Franklin & Co.

The B. S. Freeman Co. took account of stock, last week, pending the inauguration of the new management, which was made necessary through the death of William O. Cornell, of Cornell & Andrews, Providence. In order to settle Mr. Cornell's estate a claim upon the B. S. Freeman Co., held by Cornell & Andrews, had to be disposed of. The Merchants' National Bank and the Westminster Bank of Providence and the banking house of Zimmerman & Forshay, New York, assumed the obligations, and in reorganizing the company elected John S. Scully, of Zimmerman & Forshay, president; Joseph P. Burlingame, Providence, treasurer, and Arthur M. Allen, Providence, secretary. Christopher Dobras, under the new conditions, will continue to act as superintendent of the shop, and Mr. Burlingame will care for the finances. The future of the concern will be much brighter under the new order of régime, and the factory will be able to handle the big increase in business which has already been secured this year.

The hold that the vacation habit has upon North Attleboro jewelers is well illustrated by the general closing of the shops this week to allow the employes an opportunity to rest and recuperate. With only very few exceptions all the shops were closed. Those idle this week included: Riley & French, W. & S. Blackinton Co., G. C. Hudson & Co., C. Ray Randall & Co., F. M. Whiting & Co., Bugbee & Niles Co., Plainville Stock Co., Maintien Bros. & Elliot, Scofield, Melcher & Scofield, Whiting & Davis, Estate of O. M. Draper, H. D. Merritt & Co., E. Ira Richards & Co., North Attleboro Enameling Co., H. H. Curtis & Co., F. H. Cutler & Co., T. G. Frothingham & Co., Cheever, Tweedy Co., John P. Bonnett & Son, F. S. Gilbert, Fred Gorton, Furbish, Swift & Fisher, E. I. Franklin & Co., A. H. Bliss & Co., Doran, Bagnall & Co., George Robson, J. F. Sturdy's Sons Co., W. N. Fisher & Co., J. H. Peckham & Co., R. Blackinton & Co., Sturtevant, Whiting & Bigelow, and

J. O. Copeland. The majority of the manufacturing jewelers and the employes have gone to the seashores, beaches and mountains for the week. The opportunity will be seized to make the annual inspection of boilers, which the State law now insists upon.

## Attleboro.

George Heywood, salesman for the Horton-Angell Co., is home from an extended trip.

The West Silver Co., Taunton, has completed extensive improvements to its power plant and working facilities.

W. D. Flagg, of the advertising department of Reed & Barton, Taunton, has been in New York lately on business.

Ernst A. Uhlig, with F. H. Sadler & Co., became a benedict last week, receiving a handsome gift from fellow workers.

The Cornell-Andrews Co., Olive St., has instituted suit against the town. The railroad grade crossing abolition work has enclosed the factory firmly between massive embankments and a river. Entrance and exit for persons and materials are now possible only by boat.

William C. Tappan, of the D. F. Briggs Co., is the popular choice for president at Windham Hill, Me. He has just returned from a visit there. During his stay he installed a water system on his model farm. The villagers asked him to extend its benefits to them, and he connected to every house at a cost of some thousands.

Col. Sidney O. Bigney, of S. O. Bigney & Co. spent last week in the White Mountains, New Hampshire. F. W. Weaver of F. W. Weaver & Co., has been staying at Cottage City with his family. Mr. and Mrs. Harry P. Kent, the former of F. W. Weaver & Co., have gone to Canada for a tour of the leading cities and points of interest. J. William Simmons, of J. M. Fisher & Co., is making his Summer home at Silver Beach, Mass. Edwin F. Leach, of the Dunbar, Leach, Garner Co., has been spending a vacation in New Hampshire. James E. Blake, of the James E. Blake Co., is at Bar Harbor, Me.

The week which closed last Saturday and the present week were chosen by a large group of the jewelry factories as the time for annual boiler inspection, shop repairs, and, in some cases, the taking of inventory. Owing to the fact that the rush of orders has continued unabated, several concerns were forced to prepare for this enforced idleness by overtime and extra exertions in the weeks preceding. Among the firms affected by this custom are A. Bushee & Co., S. O. Bigney & Co., F. H. Sadler & Co., the Mason & Howard Co., Carter, Quvarstrom & Remington, Electric Chain Co., Bristol Mfg. Co., R. B. Macdonald & Co., J. M. Fisher & Co., C. O. Sweet & Son Co., F. W. Weaver & Co., Sykes & Strandberg, Smith & Crosby, J. T. Inman & Co., Gifford Mfg. Co., Marble & Forrester, D. A. White & Co., and the Horton-Angell Co., the latter concern resuming operations last week.

W. C. Kayser, Marshall, Minn., will engage in business at Millbank, S. Dak., where he has bought a store.

## Providence.

The factory of Smith Bros. is closed this week for the annual vacation.

After a vacation spent at Far Rockaway, William Loeb is once more at his desk ready for business.

Horace and Albert A. Remington have returned from a two months' trip to Europe. They report having an excellent time.

The Outlet Co. has offered a silver cup to the nine of the Providence Amateur League which makes the best showing this year.

The news that the William B. Durgin Co. has purchased the plant of Goodnow & Co. in Boston was received with considerable interest in local jewelry circles.

Judge Brown in the Superior Court last week granted a preliminary injunction against the Washington Real Estate Co., restraining the latter from throwing off belts and cutting off the steam from the factory of Summer & Kotler, on Calender St.

Charles Bates, said to be a jeweler in this city, was reported as having been saved from drowning in the East River by a New York policeman one day last week. Mr. Bates may belong here, but he is not known to those employers who were asked regarding his identity.

An errand boy named John McDonough, employed by J. P. Burlingame & Co., refiners, was fatally crushed by an elevator in the Calender building one afternoon last week. The boy had been sent to the shop of Silverman Bros., in the Calender building, with some wire, and in some way got caught by the elevator, it being presumed that he, with other boys, was playing about the elevator well. He died before the ambulance arrived.

W. C. Mshet, trustee in bankruptcy of the Rodman-Wise Co., Los Angeles, Cal., has brought suit in the Superior Court here against the J. G. Fuller Co. in an action of debt. The plaintiff asserts that a judgment of \$1,386.84 was secured against the firm in the United States District Court, Southern District of California, and that this has never been satisfied. Hence the suit for \$2,000 damages, the attorney for the plaintiff being E. C. Stiness.

Judge Brown in the United States Circuit Court last week handed down an opinion in the suit brought by Edwin F. Robinson against the S. & B. Lederer Co., asking that the defendants be adjudged in contempt of an injunction restraining the concern from selling a patented swivel known as the Robinson swivel. The court finds that the defendant, while technically guilty of contempt, was not wilful or intentional in its violation of the order of the court. It holds that there was no pecuniary reason why the defendant should deliberately violate the injunction, so small is the value of the swivels. The court holds that while the penalty should be such as would induce greater carefulness in the future, it should be measured by the amount of damage which the complainant has sustained through the defendant corporation's disobedience, together with the costs and legal expenses incurred by the complainant upon this application. The amount of these costs will be fixed at a future hearing, if the parties in the case fail to reach an agreement.

# EICHBERG & CO.,

IMPORTERS AND CUTTERS OF

## DIAMONDS,

65 NASSAU STREET,

(Prescott Building.)

NEW YORK.



# STERN BROS. & CO.,

IMPORTERS AND CUTTERS OF

## DIAMONDS,

CUTTING WORKS:

138-142 West 14th St., N. Y.

68 Nassau St.,

NEW YORK.

CHICAGO,  
103 State St.

LONDON,  
29 Ely Place.

The following traveling representatives were in Omaha, Nebr., last week: R. L. Robinson, Denison Mfg. Co.; B. J. Hirshorn, Hodenpyl & Walker; G. W. Townsend, Kreis & Hubbard.

Traveling salesmen visiting Boston, Mass., during the week, included: Joseph F. Infeld, Hendricks & Co.; E. F. Skinner, Roy Watch Case Co.; Lucien M. Zell, American Gem and Pearl Co.; Harry Oliver, Tarrant & Gismond; George H. Sylvia, Mt. Washington Glass Co.; C. Frank Burns, Pairpoint Corporation.

Lancaster, Pa., was visited, recently, by the following traveling representatives: L. Hermann; William Seckels; D. C. Daggett, Egyptian Lacquer Mfg. Co.; Thomas H. Ryland, American Watch Case Co.; Charles Melcher, Aikin, Lambert & Co.; Edwin A. Lewis, Warren W. Fulmer; T. D. Bailey, Robert S. Gatter; Albert B. Randall, W. D. Earl & Co.

Among the traveling representatives who called on the trade in St. Louis, Mo., last week, were the following: E. P. Tiffany, F. H. Sadler Co.; W. A. Burt, Cory & Reynolds Co.; W. H. Hurlbert, American Optical Co.; Charles A. Winans, B. Illfelder & Co.; Max Huss, S. & A. Borgzinner; James Baker, Frank M. Whiting & Co.; F. R. Horton, Carter, Howe & Co.; M. W. Evins, T. G. Hawkes & Co.; Leo Heilbrun, L. Engel Co.

Traveling representatives who called on the Cincinnati, O., trade, last week, included: Rudolph Noel, Rudolph Noel & Co.; A. M. Leibman, E. P. Reichhelm & Co.; Morris Sliman, Shiman Bros. & Co.; S. Marks, Columbia Jewelry Co.; S. Blackinton, S. O. Bigney & Co.; D. Skutch, New Haven Clock Co.; Albert M. Stern, Goodfriend Bros.; Otto Sinnauer, Oppenheimer Bros. & Velth; M. Ettinger, Heyman & Kramer; C. Morgan, Rogers & Bro.; Abel King, I. Emrich & Co.

The following traveling representatives called on the trade in Kansas City, Mo., during the past week: Norbert Gunzburger, L. & M. Kahn & Co.; George Goldberg, Untermeyer-Robbins Co.; Melville Untermeyer, Chas. Keller & Co.; B. Hyman, Hirsh & Hyman; H. M. Carle, Keystone Watch Case Co.; George Gubbins, Rockford Watch Case Co.; Emil Pick, Hammel, Riglander & Co.; Sam Zimmern, Henry Zimmern & Co.; Mr. Askev, New Haven Clock Co.; Mr. Travis, George F. Brown; Mr. Somes, Bates & Bacon; Hugh E. King, Queen City Silver Co. and Fessenden & Co.; B. J. Hirshorn, Hodenpyl & Walker; S. J. Gaspar, O. F. Egginton Co.

The following traveling representatives were in Savannah, Ga., recently: Louis H. Cohn, Adolph Goldsmith & Sons; E. M. Childs, E. Ira Richards & Co.; J. Bernheim, Woodside Sterling Co.; Oscar Krause, Arthur W. Ware & Co.; L. H. Wolf, F. J. Boesse & Co.; Charles S. Miller, Ansonia Clock Co.; E. Shaw, P. W. Lambert & Co.; J. T. Clark, Reed & Barton; G. W. Rowly, Chas. L. Trout & Co.; J. R. Traylor, Kremenitz & Co.; Harry E. Barkman, Jones & Woodland Co.; G. H. Sluter, Carter, Howe & Co.; Harry A. Bachman, Ciner & Seelman; C. W. Thomas, Alsopp Bros.; W. L. Miller, Wm. I. Rosenfeld; Charles Marx, Wm. McGill, Wm. B. Kerr & Co., Inc.; A. Holzinger, Fred Kaufman, M. R. Smith, La Pierre Mfg. Co.

### Market Price for Silver Bars.

The following are the quotations of silver bars in London and New York, as reported by Zimmerman & Forshay:

	New York.	London.
July 24.....	\$.647½	30d.
" 25.....	.65½	30 1-4d.
" 26.....	.65	30 1-16d.
" 27.....	.65	30 1-16d.
" 28.....	.65¼	30 1-8d.
" 30.....	.647½	30d.

W. E. Archer, DeKalb, Ill., was closed recently on a chattel mortgage.

To obtain in Europe, without bulling the markets, such goods as the American manufacturers and retail dealers may endeavor to put forward is a problem that cannot be solved in America.

The goods are not found there and they may not be available even in the European markets at right prices at the particular time the American buyer comes to look for them.

It takes a Gemfinder, constantly on the spot, to collect them when they can be bought most advantageously.

FREDERICK A. JEANNE,

"Gemfinder,"

5, Square de l'Opéra, PARIS, FRANCE

London: Chancery Lane Safe Deposits.

New York: Maiden Lane Safe Deposit Co.

**A. ROSEMAN, 9-11-13 Maiden Lane, New York**

IMPORTER OF

# DIAMONDS

Maker of Diamond Jewelry



Established 1872

HEADQUARTERS FOR

# AMERICAN WATCHES

IMPORTERS

## DIAMONDS

CUTTERS

# Jacob Strauss & Sons

14 MAIDEN LANE

NEW YORK

**SOHN and HYMAN**

IMPORTERS OF PRECIOUS AND IMITATION STONES

Crystals Engraved and Painted from Photo. Crests and Coats of Arms Engraved. Stone Seal Engravers and Incrusters. Lapidary Work a Specialty.

**JOBGING STONES A SPECIALTY**

47 and 49 Maiden Lane,

NEW YORK

**Philadelphia.**

A. Dilsheimer, with his family, spent July at Asbury Park and Long Branch.

A. J. Freidel, with John F. Blisard & Co., spent a few days in York last week on a pleasure trip.

Clarence W. Jones, with E. J. Hertz, 13th and Chestnut Sts., is spending his vacation this week at Atlantic City.

John A. Kinsler, manufacturing jeweler, 1020 Chestnut St., spent the week's end with his family at Asbury Park.

Joseph Gumpert, 2218 Ridge Ave., has moved his family for the Summer to the Parkside Inn, Willow Grove.

John Blisard, of John F. Blisard & Co., 727 Sansom St., spent a few days last week in Atlantic City on a pleasure trip.

Charles Bonnaffon, with the B. F. Williams Co., is reported to contemplate making a trolley trip to Boston as a vacation recreation.

The first meeting of the creditors of Francis Joseph Lingg was held July 28 before Referee in Bankruptcy Mellors, at which time claims of creditors were considered.

S. P. Ludwig, with C. W. Bixler & Co., Easton, Pa., stopped off in this city last week on his way to Atlantic City with his family, where he will spend vacation days.

E. J. Hertz, 10th and Chestnut Sts., has been elected as one of the incorporators of the new People's Trust Co., which will begin operations in the financial world about Oct. 1.

S. Bell, of the Bell-Smith Co., Atlantic City, was one of the visitors last week to this city. Others included: H. S. Kratz, Souderton, Pa., and David Krouse, North Wales, Pa.

J. B. Bechtel, of J. B. Bechtel & Co., starts this week on a trip through eastern Pennsylvania. W. E. Ross started through the western part of the State last week for a six weeks' trip.

Reports are circulated in the trade that some of the stores recently erected opposite the postoffice are to be occupied in the Fall by retail jewelers, but no confirmation can be had at this time of the rumors.

Six marbles, regarded as masterpieces, were given last week to the Academy of Fine Arts, together with a collection of oil paintings, by the terms of the will of Mrs. Sarah Harrison, a wealthy woman who died here recently.

The alertness and integrity of C. Spitz, a pawnbroker, 2222 Callowhill St., resulted last week in the arrest of the man who held up a citizen and robbed him of a gold watch and money. An attempt to pawn the watch led to their capture.

Max Polak, with M. Siekles & Sons, starts this week on his initial traveling trip for the firm, and will cover the eastern shore of Maryland trade. J. J. Zimmern starts next week on a southern trip. Elmer Horn is spending a vacation in Easton and in New York.

Ray Lanz, son of Gus. Lanz, Norristown, Pa., accepted, last week, a position with the Philadelphia & Reading Railway Co. in their time department. The company takes direct supervision over all the clocks used on the road and of the watches of their conductors and brakemen.

D. Atlas, of Atlas & Fisher, returned last

week after a trip to Antwerp and Amsterdam for the purchase of diamonds. He came back to New York on the *Vaderland* and he and Mr. Fisher then went to Atlantic City to spend a few days with their families, who are passing the Summer at that resort.

A miniature of Sarah Siddons, the actress, rare silver watches and Chinese vases of great age are among the articles stolen recently from Philip H. Rosenbach, 1320 Walnut St., a dealer with a fashionable clientele. It was afterward ascertained that John Slack, an employe, was the thief. He was arrested and the goods recovered, but when arraigned his wife pleaded so earnestly that another chance be given him that Mr. Rosenbach relented and he was discharged.

Bert J. Sternberger, a pawnbroker, 1226 Columbia Ave., instituted proceedings last week against his father, William Sternberger and George A. Doyle to obtain the cancellation of a \$20,000 judgment note which the plaintiff says he had persuaded him to sign when he placed him in business in 1900, and which was to forestall the son being caught in unfounded suits. The son declares that his father, after promising to leave the note in his possession, abstracted it and afterward delivered it to Doyle.

Philadelphia jewelers were interested last week in the dispatches from Chicago that the jewelry valued at \$10,000 stolen some weeks ago by Jacob Svoboda, alias Herman, alias Latuar, and alias Lewis Halbert, has been recovered in that city and the culprit arrested. He is to be brought without delay to this city for trial. Svoboda secured entry to the house of his victim, Mrs. Edward Welsh, in Chestnut Hill, by pretending to be a servant, and got away with the jewelry at the earliest possible moment.

No further arrests have been made as a result of the discovery a fortnight ago that gold clippings were being pilfered from the goldsmithing department of the Bailey, Banks & Biddle Co. than that of Abraham Lawrence, who was accused by Edward Williams, head of the department, with the theft of \$500 worth of gold. Lawrence is awaiting trial on the charge. The clippings were from medal shavings, and there appears to be little reason to expect that any other employes will be involved or a conspiracy unearthed.

A pathetic story of the struggles of an aged and enfeebled watchmaker to make a living was unfolded last week when Mary F. Idler, aged 65 years, died at her home, 1734 Passyunk Ave. She lived with her brother, Samuel A. Johnson, who conducts a small jewelry repair shop at that address, and had been a paralytic for three years. Neighbors said she had died of starvation. This report was partially confirmed by police investigations, but Johnson, her brother, said he had done all he could for his sister and himself was only able to eke out a miserable existence. The house was the picture of squalor, and Johnson himself looked on the verge of starvation. He had not even money to bury her, while he continues daily at his bench, and the body was interred in Potter's Field.

Dr. Harry Litchfield, who began his career as a jobbing jeweler at 7th and Chestnut Sts., and who, together with three sons,

Joshua, Henry Nathan and Dr. Paul Litchfield, was widely known in the trade of this city and New York, died last week in the 63d year of his age, at his residence, 1217 Poplar St. He had been in failing health more than a year, and his death was not unexpected among members of his family. He abandoned the jewelry business a score of years ago to practice medicine, the study of which he had pursued while engaged in business. The business was taken over by Harry Struntz, who some years ago was bought out by John B. Beehtel, who is now carrying it on, enlarged, at 725 Sansom St. The sons all began life as jewelers, but Joshua Litchfield is the only one to remain in the business. He is now with George Kelly, instalment dealer. He formerly conducted a retail store on Columbia Ave. near 20th St.

**Rochester.**

Joseph Kopelowitch, of Main St. E., is spending several weeks at Mount Clemens, Mich., for the sake of his health.

Morris Rosenbloom returned last Saturday from a short vacation trip to Grove Springs, N. Y., where his family is spending the Summer. Mr. Levinson, also of this firm, is now spending a few days at the same place. Traveling men for this concern are getting their samples ready, preparatory to their trip out during the first week in August.

The office and factory employes of Bastian Bros. will hold their annual picnic at Seneca Point, Aug. 4. It is expected that about 250 persons will be in attendance. The start will be made from the Court St. bridge at 7.45 o'clock in the morning, and the trip will be made in special Rochester and Eastern trains. The day will be devoted to sports of all kinds, and regulation picnic style will be the order of the day.

Some weeks ago an "eye specialist," Dr. Horace B. Hyde, was arrested in Rochester, N. Y., for having nearly impaired the eyesight of a Mr. Rabshaw by his malpractice on him. Both the Medical Society and the Rochester Optical Society interested themselves in the case, and sought to have Hyde punished for his dangerous work. Hyde, however, was set free on his promise not to practise any more. Now comes the tale that he has been practising in Cuba, N. Y., and has made himself decidedly unpopular by his work. Complaints have been received by the Rochester police, and now they are after him. A warrant has been issued on complaint of Elizabeth Rabshaw, whose brother the "doctor" mistreated.

**Jewelers Gold Bars Withdrawn and Exchanged at New York.**

*Week Ended July 28, 1906.*

The U. S. Assay Office reports:

Gold bars exchanged for gold coin.....	\$350,680.11
Gold bars paid depositors.....	39,208.67
Total .....	\$389,888.78

Of this the gold bars exchanged for gold coin are reported as follows:

July 23.....	\$93,252.15
" 24.....	56,683.67
" 25.....	122,232.45
" 26.....	37,014.50
" 27.....	30,989.77
" 28.....	10,507.57
Total .....	\$350,680.11

From  
Mines  
to  
Market

# THE CAT'S-EYE

There are several kinds of Cat's-Eye, the Common or Quartz variety being known as "Hungarian," and the Chrysoberyl or True Variety as

## ORIENTAL CAT'S-EYE

Buy  
from the  
Cutters

Chrysoberyl Cat's-Eyes are found in shadings of Yellow, Brown, Green and sometimes nearly Black, with a band of light running through the centre. These stones are beautiful and especially adapted to Men's jewelry.

## AMERICAN GEM & PEARL CO.

14 & 16 Church St., NEW YORK

LONDON: 16 Holborn Viaduct

PARIS: 39 Rue de Chateaudun

HORACE A. DWYER, President.  
11 years with Tiffany & Co.  
9½ years with Garraud & Griser  
Awarded a Diploma by the  
Exposition at Chicago, 1893

HENRI CASENOVE, Sec. & Treas.  
12 years with Tiffany & Co.  
MINERALOGIST

H. O. DREHER, Vice-President  
12 years with Tiffany & Co.  
2½ years with Shreve & Co.  
Awarded a Medal and Diploma  
by the Exposition at Paris, 1900

"There is Nothing in the Art that we cannot do."

## The International Gem Co. Inc.

12-16 JOHN ST., NEW YORK

TELEPHONE, 1241 CORTLANDT

LAPIDARIES and IMPORTERS of PRECIOUS STONES

SPECIALISTS IN REPAIRING AND REPOLISHING RARE AND VALUABLE GEMS  
DRILLING — ENGRAVING — SLITTING



TRADE-MARK.

## AZTEC TURQUOISES

Mines: MINERAL PARK, ARIZONA.



TRADE-MARK.

Of true CERULEAN BLUE, the rarest and most fashionable shade. Turquoises bearing Company's trade-mark are GUARANTEED. A new Turquoise will be given without question to replace any that discolors. The leading Jewelers of the World sell AZTEC TURQUOISES.

## THE AZTEC TURQUOISE COMPANY,

12-16 JOHN STREET, NEW YORK.

THE BOSTON DIAMOND HOUSE

## JOHN B. HUMPHREY CO.

387 Washington St., Boston, Mass.

We are receiving Monthly Shipments of Diamonds from our Brazilian Mines, which are on exhibition at our Boston Office.

## Lancaster, Pa.

William Holland, with George M. Bailey, Uniontown, is a proud father.

Harry B. Boyce, with J. W. Kimpel, of Pittsburg, visited Lancaster last week.

Martin Weaver, of the Ezra F. Bowman Technical School, is off on a vacation trip.

J. M. Kreider has taken a position as watchmaker with J. H. Sensenig, New Holland.

Cyrus Novinger, Halifax, has gone to Nevada on a pleasure and business trip combined.

Frank A. Huber, traveling salesman for the H. S. Meiskey Co., is spending his vacation at Atlantic City with his family.

E. R. Kant, F. A. Wheeler, W. N. Shute and Charles E. Foose, representatives of the Non-Retailing Co., have started on their Fall trip.

L. C. Reisner, manufacturing jeweler, of this city, has laid out a new suburb for Millersville, and is exploiting the sale of building lots.

William Pirosh, of Pirosh & Simmons, and wife have announced the engagement of their daughter, Miss Anna Pirosh, to Monroe Levy.

Charles Weidner, engraver, of Newark, N. J., has returned to that place after a three weeks' visit to his father, O. W. Weidner, of this city.

Walter Welcham, a department foreman of the Hamilton Watch Co.'s factory, and his wife have returned from a vacation spent by the seashore.

Warren P. Johnston was married last Thursday to Miss Martha Patterson, and the day following they left for Chattanooga, Tenn., where he expects to open a jewelry store.

W. W. Appel, who has been obliged to vacate his storeroom in the Wheatland Hotel, has secured temporary quarters in the Kepler building, occupying half of the large storeroom of Henry Gerhart.

The following jewelers visited Lancaster recently: W. J. Frazer, Lincoln; E. P. Zane, Christiana; A. C. Squires, Shippensburg; S. H. Miller, Mount Joy; H. C. Foehl, Columbia; J. H. Sensenig, New Holland; Jacob Fisher, Elizabethtown, Pa., and T. B. Helms, Hamlet, N. C.

## Newark.

Members of the International Watch Co., Greenville, last night entertained their friends in Armbruster's Schützen Park.

The death of Winthrop B. Harris, Orange, N. J., said to be a manufacturer of jewelry supplies, was reported last Thursday.

Mrs. F. J. Herpers, widow of F. J. Herpers, who was the founder of Herpers Bros., manufacturers, in this city, died Saturday at Ocean Grove, aged 83 years. Her husband died in 1888. The surviving relatives include one son, Henry, who is now of Herpers Bros., and two grandsons, H. F. and F. J. Herpers, both members of the firm. The funeral will take place to-day from her late residence, 478 Washington St., in this city.

C. F. Miller is remodeling and improving his store in Cairo, Ill.



## Pittsburg.

J. Loughrey Roberts, of the J. M. Roberts & Sons Co., has returned from Atlantic City. John M. Roberts leaves for that place next week.

Among the out-of-town merchants who visited Pittsburg last week were: A. F. Stanver, Wheeling, W. Va., and A. B. Kuntz, Connellsville, Pa.

S. Davis, of S. Davis & Co., is at Cambridge Springs. The store, which was gutted by fire several months ago, has been renovated and greatly improved. The firm has installed a much larger stock than formerly carried. Mr. Davis is resting because of hard work, occasioned by the fire.

Charles O'Brien & Co last week received the order for the \$2,500 gold cup to be given by R. M. Weaver, of this city, for the best 2:15 trotters, closing as to records July 2. It will be competed for at the coming inter-city matinee meeting at Brunot's Island the last week in August. The cup is of special design, and is being made by a New York house.

The following delegates, representing the Pennsylvania Retail Jewelers Association, left Pittsburg last night to attend the National Convention at Rochester: A. C. Graul, Sharpsburg, president of the Pennsylvania Association; C. S. Wiley, secretary; J. P. Archibald, Blairsville; P. C. Yester, McKeesport, and J. F. Blazier, New Kensington. Secretary Wiley has received a number of new members since the association was organized in Pittsburg, July 10. Early in September the Pittsburg retail jewelers will meet to organize, this to be followed by a banquet at one of the leading hotels. The local organization is now being talked up by members of the State organization.

The mercantile appraisers' list last week showed that an execution for \$861 had been issued against Adolph E. Seidle by J. J. Green, but Mr. Seidle is in no way financially involved. The execution was issued by an amicable agreement, and arises over a property transaction in which Mr. Seidle was interested several years ago. It appears that a mortgage was put on the property by the man that Seidle sold to and became tangled up with in a legal sense, so in order to give the present owner a clear title, Mr. Seidle agreed to allow the judgment to be entered, and it will be satisfied. In speaking about the matter, Mr. Seidle said: "I was aware when I did this that it probably would cause me to make some explanation, but it does not involve me in any way." Mr. Seidle is one of the most responsible jewelers in Pittsburg.

The Pittsburg police has caused the arrest of a number of auctioneers, who they claim have been doing business without a license. J. H. Spandau and H. E. Young, jewelry auctioneers, who have been auctioning off goods at 443 Smithfield St., in a room which has the name Pittsburg Jewelry Co. painted over the door, were arrested last week, and arraigned for a hearing before Alderman John Groetzinger, who held both for court in the sum of \$500 bail. The license fee is \$100. It is said that the defense of the men was that they were not carrying on an exclusive auction business, but were simply selling out goods to reduce the stock, preparatory to altera-

tions being made to the store. Seven other auctioneers were also arraigned for a hearing, some of whom were held for court. Pittsburg has been overrun with jewelry auction houses, and some of the local retail dealers, it is said, have complained to the police, with the result that a raid was made on all those auctioneers who did not hold a license.

## Washington, D. C.

Mrs. Myrtle L. Dean has brought suit for divorce against her husband, James M. Dean, optician, 708 13th St., N. W.

The Navy Department, through the Bureau of Supplies and Accounts, is inviting sealed proposals until Aug. 14 for furnishing a quantity of clocks embraced in schedule 70, obtainable at the Navy Pay Office in New York, or upon application to the Bureau at Washington.

H. F. Wichman, who has been in the jewelry business in Honolulu for the last 21 years, has been visiting this city, stopping at the New Willard. In commenting upon the conditions in the Hawaiian Islands, Mr. Wichman said: "The business conditions in Honolulu are good. Immediately after annexation there was a large influx of Americans, looking for business openings. There was not room for all that came then, but affairs have by this time readjusted themselves, and business will now continue to improve."

Under the terms of the will of Max Goldsmith, whose death was reported in THE CIRCULAR-WEEKLY last week, the testator's entire interest in the business of M. Goldsmith & Son is bequeathed to his son Charles, with the proviso that the latter liquidate all debts of the business or owed by Mr. Goldsmith individually at the time of his death. The remainder of the estate, real and personal, is given to Mrs. Ellen Goldsmith, the widow, for life, and upon her death to the son Charles, or his heirs. Mrs. Goldsmith and Charles Goldsmith are named as executors, the will being executed June 7 last. The Probate Court has passed an order admitting the will to probate and record, and has granted letters testamentary to the executors under a bond of \$200.

## New Orleans, La.

Gabe Scooler, of M. Scooler, will remain in New Orleans for the entire Summer. Mr. Scooler had planned a trip to the north and east, but has postponed the journey until later in the year.

A. M. Hill has resumed business as formerly at his old stand in Canal St., the sale to satisfy Mrs. Hill's judgment in the recent divorce proceedings having terminated.

J. Julius Weinfurter's Jewelry Palace was again visited by thieves a few nights ago. The robbers used a sharp stone and broke the heavy plate glass window of the Bienville St. show case. From the show case they stole a tray containing opera glasses valued at \$100, and escaped with their booty.

Coleman E. Adler, who secured the contract for the silver service to be presented to the battleship *Louisiana*, is expected back from New York this week, and the committee, headed by Mayor Behrman,

will hold a conference with him to ascertain the probable length of time that will be consumed in manufacturing the handsome articles by the Frank W. Smith Co., Gardner, Mass., who designed and are now making the service. Mr. Adler telegraphed to forward to Smith stalks of sugar cane, rice and other samples of the State's products, which are to be wrought in the separate pieces of the service. It is a bad season of the year to secure good specimens of sugar cane, as the product comes with the early Winter months, but Mr. Adler's agents were able to secure several fair-sized stalks, which will serve as models to Mr. Smith's workmen. The sugar cane and rice were shipped to New York Saturday, and will be forwarded to Mr. Smith.

## Omaha.

James Dorward has taken a position with T. L. Combs & Co.

T. L. Combs has returned from a trip to the Black Hills, S. Dak.

W. C. Flatau and wife have gone to Denver and Colorado Springs on a pleasure trip.

Mrs. Louis A. Borsheim, wife of L. A. Borsheim, has gone to Sullivan, Ind., to visit her sister.

C. Hansen, watchmaker for Fred Brodegaard & Co., has gone on a two-weeks' vacation to Lake Okoboji.

E. W. Keating, formerly of Omaha, but now with Otto Young & Co., Chicago, is at present visiting friends in this city.

S. D. Gustavson, of the firm of P. E. Flodman & Co., has gone on a two-weeks' fishing trip to the northern lakes of Minnesota.

F. H. Kline, formerly of the W. J. Johnston Co., Pittsburg, Pa., has taken a position as city and house salesman for the A. F. Smith Co.

Ferd Smith, Memphis, Tenn., who is visiting a son, A. F. Smith, accompanied the Commercial Club excursion to the Black Hills last week.

Mae Hayes, who was convicted of stealing a diamond from T. L. Combs & Co., was taken to the Lincoln penitentiary last week, to begin her sentence of five years.

C. C. McLees, president of the Nebraska State Optical Society, of Davenport, Nebr., with his wife stopped off here last week, on their way to Rochester, N. Y., to attend the National Convention of Opticians.

The following out-of-town buyers were in this city last week: A. O. Lieber, Utica, Nebr.; P. W. Folsom, Ashland, Nebr.; Seth H. Clay, Long Pine, Nebr.; Charles Reed, of Reed & Cole, Woodbine, Ia.; M. Barnes, Avoca, Ia., and John Crabill, Plattsmouth, Nebr.

Mr. and Mrs. George W. Ryan, parents of George W. Ryan, of the Mawhinney & Ryan Co., celebrated their 50th wedding anniversary last week. Over 100 friends called to congratulate them, and they were the recipients of many beautiful presents, besides a purse of gold. Mr. Ryan is a retired physician, and is 84 years of age, while Mrs. Ryan is 81 years old.

Frank Pequegnat, Riverside, Cal., has sold out his interest at that place to H. Britzius.

# GORHAM SILVER

## TO THE JEWELRY TRADE

¶ Attention is respectfully invited to the fact that the Gorham Company's traveling representatives have already resumed their customary activities in introducing to the Jewelry Trade the many original and exclusive novelties as well as the standard lines of silverware which have been prepared by the Gorham artificers for the approaching Fall and Holiday Seasons.

¶ In view of the period of unexampled prosperity it seems pertinent to suggest to the progressive jeweler the advantage he will gain by a careful examination of his stock so as to arrive at a speedy and discreet decision as to the directions in which it needs replenishing. Orders given now will be shipped whenever required.

## THE GORHAM COMPANY,

Silversmiths and Goldsmiths

Fifth Avenue and 36th Street, New York.

### BRANCHES:

NEW YORK,

SAN FRANCISCO,

23 Maiden Lane.

Temporary Office:  
1103 Broadway, Oakland, Cal.

LONDON,

Ely Place.

WORKS: Providence and New York.



CHICAGO,  
137 Wabash Ave.



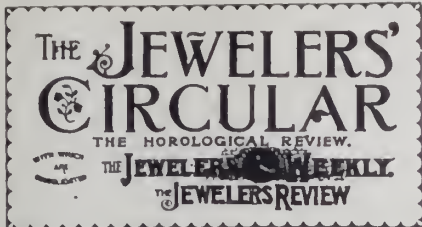

PUBLISHED EVERY WEDNESDAY BY  
**THE JEWELERS' CIRCULAR PUB'G CO.,**  
 11 JOHN ST. COR. BROADWAY, NEW YORK.  
 TELEPHONE: CABLE ADDRESS: JEWELAR NEW YORK  
 1148 CORTLANDT.

VOL. LII. AUGUST 1, 1906. No. 26.

Subscription in U. S., Canada and Mexico, \$2.00  
 Other Countries in Postal Union, . . . \$5.00  
 Single Copies, . . . . . .10

Remit by check or money order. Remittances in money are at sender's risk.

Notices of changes in standing advertisements must be received one week in advance; new matter can be received up to Monday.

No attention paid to communications unless accompanied by full name and address of the writer. This is asked not necessarily for publication, but as an evidence of good faith.

**Index to Special Articles.**

	Page.
Magnificent Loving Cup Presented to the Chicago Yacht Club by John G. Nutting. Illustrated on front cover; text on page. . . . .	40
Dr. Geo. F. Kunz's Report on Precious Stones—(Continued) . . . . .	39
Census Report on Jewelry and Clock Industries of Connecticut . . . . .	40
Report of Rapid Development of American Culture Pearl Industry Not Believed in New York . . . . .	41
Death of Charles Teetzel . . . . .	41
San Francisco Wholesale Jewelers' Sample Trunks Robbed of \$13,000 Worth of Jewelry . . . . .	41
Jewelers of Santa Rosa, Cal., Give Birthday Gift to John Hood . . . . .	41
The Diamond Markets . . . . .	43
Jewelry and Kindred Lines Exported from New York . . . . .	43
Death of George N. Luckey . . . . .	43
Rochester, N. Y., Jewelers Taking Steps to Form a Local Organization . . . . .	43
Two More Men Arrested in Connection with Robbery of Joseph Wineburgh & Sons, Utica, N. Y. . . . .	45
Many San Francisco Jewelers Reimbursed—Insurance Adjusters Making Progress . . . . .	45
Diamond Market Stronger Than Ever . . . . .	47
Bankruptcy of Frank T. Pearce, Providence, R. I. . . . .	47
Bankruptcy Petition Filed Against Onondaga Metal Co. . . . .	47
Thief Robs Two Boston Jewelry Stores . . . . .	47
Peter Foisey Makes an Assignment . . . . .	47
Interesting Suit Between New York Jewelers Decided—Defendants Will Appeal . . . . .	49
Death of Fred W. Dexter . . . . .	49
Van Ness Ave., San Francisco, New Retail District, Scene of Numerous Shoppers . . . . .	49
Wisconsin Jeweler Robbed and Murdered . . . . .	49
New Stores and Enterprises . . . . .	49
Death of Percy Whitechurch . . . . .	49
Reported Diamond Find in Canada . . . . .	55
The Optometrist's Catechism—(Continued) . . . . .	84
Full Report of the Opening of the Annual Convention of the American Association of Opticians, at Rochester, N. Y. . . . .	85
Anatomy of the Nervous System—(Continued) . . . . .	86
An Artistic Clock at Goslar, Germany . . . . .	91
Vibrations of an Electric Clock at Greenwich Interferes With Work of Famous Observatory . . . . .	93
Clock Making in Nagoya, Japan . . . . .	93
House Clocks With Simple Electrical Winding Work, for Operating the Going and Striking Trains Simultaneously . . . . .	95
Why Organization is Beneficial to the Jeweler. How Organization May Prevent Unfair Competition . . . . .	100
Side Lines for Jewelers—(Continued) . . . . .	101
More About Stock Registration . . . . .	101
Practical Advice on Glass Drilling . . . . .	103
Reappraisements of Statuary, China, etc. . . . .	105
Magnificent China Service Presented by King Edward to King Alfonso . . . . .	105
Recent Publications . . . . .	107
Recent Decisions on Statuary . . . . .	107
Another New Form for Diamonds . . . . .	107

**O**WING to the greatly increased size of THE JEWELERS' CIRCULAR-WEEKLY, it is absolutely necessary that all changes in advertisements be received one week in advance of date of publication if proof is desired. Positively no change can be made after Friday noon for the next Wednesday's issue.

**A Golden Opportunity.** THE delegates from the various State associations of retail jewelers who will meet in Rochester, N. Y., Friday and Saturday, for the purpose of forming the National Retail Jewelers' Association, have resting on their shoulders a severe responsibility, for it lies with them, and with them alone, whether or no the trade of the country will have the representative and responsible association which the jewelers of the United States in all sections have wanted for many years. That a national organization will be formed is, of course, an assured fact, and that some good will surely result therefrom is equally evident; but it rests absolutely with the jewelers who attend the convention as to how strong, powerful and lasting this organization is to be.

Every delegate as well as every jeweler who participates in the work of founding the new organization should carefully bear in mind that the mere work of organization and election of officers is but the beginning and not the end of the great movement that the trade at large desires. Theirs is the golden opportunity, and their work should not be entered into lightly or without consideration. For the first time in many years and almost for the first time in the history of the trade there will occur a gathering of jewelers with interests identical in essential particulars, but widely different in other details, who may form themselves into a nucleus that has the possibility of growing into an organization of the greatest possible size and power; for, after all, it is only a nucleus of an organization that can be formed, and it is the character of the work done by the organizers Friday and Saturday and the sincerity of those who attend, that will decide whether the new organization and the State organizations which comprise it will be composed of the leading jewelers as well as the smaller merchants of every city in the Union, or, on the other hand, whether it will remain what it starts out as—purely and simply an affiliation of State societies representing but a small proportion of the members of the jewelry and kindred trades in the various commonwealths in the Union. In all their work the delegates should open their eyes to the plain fact and fully realize that with very few exceptions the organizations represented do not as yet contain the representative members of the retail jewelry industry,

many of whom, we are sorry to say, have been holding off awaiting the outcome of the Rochester convention.

THE CIRCULAR-WEEKLY believes, and is sure, that this convention is absolutely the result of an honest effort on the part of the retailers to obtain relief from abuses from which they now suffer, and that the only possible way open for them is this formation of a body having at heart the interests of the trade, that is in the position to speak for the trade as a whole. If the organization formed is of such a character it will not only satisfy the desires of those jewelers who participated in sending delegates to this convention, but will also attract to it and to its affiliated State societies hundreds of jewelers in every State who have thoroughly desired a representative body to speak for the trade, and who have hitherto refrained from participating in the movement. If, on the other hand, the organization formed is tainted by personalities, or if in any way the great power which it represents, or can represent, is so loosely guarded that it may be directed in the interests, benefit or aggrandizement of any man, or body of men, be they retailers, wholesalers or manufacturers, it will soon lack the confidence of those from whom its membership is drawn, and will follow in the footsteps of many similar organizations that have been formed from time to time in this and in other trades, gradually dying out until it becomes a mere shadow or a name.

Which shall it be? It is for you, Mr. Delegate, and you alone, to say, and therefore you cannot be too careful in avoiding pitfalls which mark the way to decline. Remember that you have your own grievances to remedy, and your organization properly formed can by itself obtain the remedy if such is obtainable. Consider yourself and your trade as a whole, and participate in no personal controversies or strife, no matter whether those engaged therein be your friends or your enemies. Avoid the dangers that lie in the way of the "friendly list," the "black list" and the official organ, etc., etc., and remember that to some extent you are the trustee of the interests of the retail jewelry trade, and as such it is your duty to consider every question from the standpoint of no single man, organization or geographical section, but from that of the entire trade, from the Atlantic to the Pacific and from the Gulf to the Great Lakes. Above all,

# Diamonds Wanted!



He swore by the bright stars  
above her.  
(You know how a lover can  
swear.)  
How he'd love her and love her  
and love her;  
And the stars twinkled down at  
the pair.  
(You know how a star can  
twinkle  
When maidens to lovers confess.)  
They want just one thing—A  
**DIAMOND RING.**  
"Shipped by the next express."  
*An assortment of precious  
stones, loose or mounted; pins,  
rings, brooches, etc., will be  
sent to any jeweler on mem.*

## CROSS & BEGUELIN

Importers and Cutters of Diamonds and Precious Stones

48 Rue de Meslay, PARIS Telephone, 2188 Cortlandt 17 Maiden Lane, NEW YORK



PREPARED IN ADVANCE YOU TAKE NO CHANCE

RINGS  
ALL  
KINDS  
—  
STUDS  
SCREWS  
DROPS



14k-18k  
Platinum  
Plat. Lined  
Plat. Tipped  
all  
Combina-  
tions

ARCH CROWN MTGS.—COMPLETED BEARINGS

Cross & Beguelin, New York.  
Kosuth Marx Jewelry Co., N. Y.  
D. C. Perelval & Co., Boston.  
Jos. Noterman & Co., Cincinnati.  
M. Schussler & Co., San Francisco.

Schradler Wittstein Co., Chicago.  
Leonard Krower, New Orleans.  
Chas. Wathen & Co., Denver.  
Eisenstadt Mfg. Co., St. Louis.

SAMPLES CHEERFULLY SENT  
Arch Crown Mfg. Co.  
26 Camp St., NEWARK, N. J.

be true to yourself as well as your trade, and your work may result in the foundation of an organization to which not only this but future generations in the jewelry trade will point with gratification and pride.

### LETTERS TO THE EDITOR.

Why Jewelers Should Join Their State Organizations.

WESTFIELD, Pa., July 25, 1906.

Editor THE JEWELERS' CIRCULAR—WEEKLY:

I see by the reports in the press that jewelers in many sections are indifferent in the matter of state and national associations, and therefore ask you to publish the following for these jewelers to answer:

Do you realize, Mr. Jeweler, that the mail order houses' sales have increased in the last 10 years from five to 10 per cent.?

Do you realize, Mr. Jeweler, that last year the mail order houses did about 15 per cent. of the entire jewelry business in the United States? Do you realize, Mr. Country Jeweler, that the mail order houses are setting the price on your goods?

Are you not obliged to meet their prices in order to do business with a good many of your customers?

Are you going to fold your hands and let these concerns "Standard Oilize" you?

Now is the time to act. Send in your name to your state association, even if you have to sacrifice a few cigars to pay the dues.

They say the Lord helps those who help themselves. It is certainly proving so with the mail order houses.

I see a good many jewelers advise "home trade" argument with customers, but I find the only argument that is good for much with my customers is prices.

Let us get together and protest against the manufacturers and wholesalers selling to mail order houses, department stores, peddlers, etc. The manufacturers are hiding behind the Sherman Anti-Trust Law, but I notice they have no trouble in cutting off a jobber for reasons of their own.

Mr. Jeweler, stop kicking in your sleep, but let us wake up and kick together.

Yours truly,  
C. W. PARKER.

### Pacific Northwest

Joseph Bach is preparing to open a jewelry store in the new Cowles building, which is nearing completion, in Spokane, Wash.

Albert Hansen, Seattle, Wash., recently moved his stock into the lower floor of the new Lowman building, at the corner of First Ave. and Cherry St., where he has one of the most attractively furnished stores on the coast.

A young man named Miller has been arrested at Oregon City, Ore., on a charge of horse stealing. He is the same man who on the night of June 21 entered the store of A. J. Johnson and stole six watches, several chains, brooches, etc. Miller admitted he stole the stock and produced all he had with him. Some of it was traded, sold or given away, but Mr. Johnson thinks he will recover all the stolen articles.

Wm. Gardner & Son, Oregon City, Ore., have been succeeded by Wm. Gardner.

## New York Notes.

The style of the E. H. Levy Silver Co., 41 Maiden Lane, has been changed to the E. H. Levy Co.

Walter Boss, of the Watson & Newell Co., Attleboro, Mass., and his bride were in New York last week.

Samuel Freeland has moved from Brooklyn to Sidney, N. Y., where he will engage in business as a manufacturing jewelry and diamond dealer.

Christian Schertig, of the Royal Copenhagen Porcelain Co., Hudson and Chambers Sts., who has been visiting the company's works abroad, is expected back in a week or so.

F. E. Leimbach is among the New York pearl merchants now visiting the fisheries along the Wabash. George C. Schmelewski is at the fisheries in the interest of David L. Gluck.

Wallach & Davidson have given up their offices at 65 Nassau St., and now have their office consolidated with the factory at 128 Mott St., where the firm manufactures mountings.

A handsome display of art glass, including shades, globes, smokers' articles and holiday novelties, is being shown in room 322, Astor House, by a representative of the Handel Co., Meriden, Conn.

Travelers for Charles M. Levy, 90 William St., started out last week with new lines of rings and lockets, including stone charms, encrusted with emblems. The stones are buffed on both sides, and come in blood red, sard and in cherry colors.

Henry Steck, the former employe of the L. E. Waterman Co., who was arrested recently on the charge of stealing fountain pens from the company's vault, has been indicted by the Grand Jury, and it is expected that he will be tried in October.

Portions of the sidewalk in front of a number of stores on Fulton St., Brooklyn, including those of L. Simon and A. Lewin & Ash, jewelers, at 525 and 529, respectively, fell into the subway Tuesday afternoon of last week. Nobody was hurt, and the damage was promptly repaired.

Harry W. Mack, who was formerly of THE CIRCULAR-WEEKLY, and who was at one time president of the Trades Weekly Co. and editor of the *Jewelers' Weekly*, is the candidate for leader of the Anti-Quigg Republicans in the 15th Assembly District, where a particularly lively contest for control of the party is now in progress. The primary is to be held Sept. 18.

On the *Kronprinz Wilhelm*, arriving in New York recently, were several members of the jewelry trade, including E. Arnstein, of Arnstein Bros. & Co., New York; David Zimmern, of Zimmern, Rees & Co., New York; A. D. Harrington, of the Shreve, Crump & Low Co., Boston, Mass. Before going back to the "Hub" Mr. Harrington called on the wholesale district in New York.

Humorous articles are appearing in the daily papers in relation to the clock in the new Hall of Records building. Although it has been in position for some weeks, the hands of the dial point always to the hour of 10:07. According to the papers, Brooklynites and others are being misled. "Lost in Red Tape, or the Secret of the Hall of

Records Clock" is the title under which the subject is treated in one of the papers.

A number of the creditors of Simon Robinson, who had jewelry and antique stores at 1283 Broadway, Manhattan, and 1029 Broadway, Brooklyn, have accepted an offer of settlement at 40 cents on the dollar. Prior offers of 25 and 33 $\frac{1}{3}$  per cent. were refused. It is said that a majority of the creditors have signified their acceptance of the 40 per cent. offer, and that the United States District Court will be asked to approve this as a composition in bankruptcy.

More than \$1,000,000 is disposed of in the will of Charles Rubens, formerly a Swiss watch importer at New York, who died early in June at his home in Paris, in which city he has lived for many years. The will was filed in probate by Coudert Bros. To 40 relatives he bequeaths from \$5,000 to \$10,000 each. The Hebrew Benevolent and Orphan Society and Mount Sinai Hospital, of this city, each receive \$5,000. A painting of Christ by Henner is left to the Metropolitan Museum of Art.

Carl H. Weidemann, of Borrelli & Vitelli, 101 Broadway, returns this week on the *Konigin Luise* after a trip to Europe during which he passed a month in Paris buying coral and looking up novelties in French jewelry. Afterward he visited for a month with his mother and sister at Luzerne, Switzerland. A fine specimen of Edelweiss, received from Mr. Weidemann at the office of THE CIRCULAR-WEEKLY indicates that he was successful in hunting the highly-prized little flower which grows only on the loftiest and most dangerous peaks of the snow-covered mountains.

Joseph Eisenstadt, a jewelry peddler, was found early last Thursday morning, tightly bound in ropes, lying in the hallway of a tenement house at 44 Allen St. He told the police that when he left the elevated railroad station at Grand St., the night before he had been attacked by five men, who beat him until he was unconscious. He said that \$900 in money, a gold watch and a diamond ring which were in his possession had been taken. Eisenstadt was sent to the Gouverneur Hospital, where the surgeons said that it would be some weeks before he could leave the institution.

A part of the force at the assay building in New York is to be transferred to Philadelphia, where the smelting and refining operations will be conducted until a new building is erected here. The present building will be razed as soon as the work can be transferred to Philadelphia. The assay office proper, used for the purpose of receiving gold deposits, etc., will continue at New York in its present building until the structure in the rear, for smelting and refining, is completed, when the office will also be torn down and a new office building erected to correspond architecturally with the Sub-Treasury. The business with the public will not be interrupted.

At the northwest corner of John and Dutch Sts. a 12-story office building is to be constructed next year. This will necessitate the removal of a number of jewelry concerns which now occupy quarters in the present buildings at 45, 47 and 49 John St. Dattelbaum & Friedman and D. W. Beaumel & Co. are at No. 45, and H. & E. O. Belais are at No. 47. Several stationery concerns are also located in these build-

ings. There are three stores now on John St. and one on Dutch St. The new building will have a frontage of 75 feet on John St. and 105 feet on Dutch St. Work is to be begun May 1 next, so that the tenants are already looking around for new quarters. The syndicate which is to put up the new building expects, it is understood, that the offices will be leased to a considerable extent to jewelry concerns.

August Seifkins, familiarly known in Maiden Lane as "Gus," who had been with the American Express Co. for 35 years, during most of that time handling packages in the downtown jewelry district, died recently in his home, Bayonne, N. J., of a complication of diseases. Mr. Seifkins was 65 years of age. His death caused genuine regret among a large number of manufacturers and jobbers whom he had served for so many years with fidelity. Speaking of him, one of the shippers on the Lane said that he was an example of the honest and faithful class of men who have attended to the jewelry business in this district for the express companies. "In my recollection," said the merchant, "going back a great many years, not one of these men has ever betrayed his trust. Considering the fact that very valuable property is entrusted to them daily, and even hourly, this record is really notable. One or two of the assistants on the wagons, I believe, have gone wrong, but the principal men, who have charge of the wagons, have proved strictly trustworthy, their services being alike satisfactory to the express companies and to the shippers."

According to the reports from Bridgeport, Conn., the police of that city have identified James McCrosson, who was arrested in New York two weeks ago on a charge of stealing three pearl studs from A. Frankfield & Co., 38 W. 34th St., in this city, as a man who was convicted some years ago. After McCrosson's arrest the New York police sent out inquiries to the police in other cities asking if they had any information about the prisoner. The Bridgeport police said that the photograph and measurements were those of James McMoulton, who was recently released from State prison after serving a two years' sentence for an offence similar to the one committed in New York. McMoulton was arrested July 29, 1903, in Bridgeport, after he had exchanged imitation diamonds for real stones in the stores of Isaac Brush and G. W. Fairchild & Sons. In each case he entered the store, pretending that he wished to make a purchase, and while examining the jewelry made the substitutions. The stolen diamond was missed directly after he left the Brush store, and he was pursued and captured. His conviction followed, and on Sept. 10 he was sentenced by Judge Gager, of Bridgeport. This information was forwarded by the police of that city to New York. McCrosson, who is said by the New York police to be known also under the name of Chalmers, is accused of obtaining the studs from the Frankfield store in the same manner in which McMoulton robbed the Bridgeport stores.

Richard Friedlander, of R., L. & M. Friedlander, 30 Maiden Lane, returned this

IN THE HEART OF THE JEWELRY DISTRICT.

**Guardian Trust Company,**

170 BROADWAY, COR. MAIDEN LANE, NEW YORK.

Capital and Surplus - Over \$1,000,000

Equitable rates of interest allowed on surplus funds.

Collection of out-of-town items made on reciprocal basis.

FRANK W. WOOLWORTH, President.  
GEORGE W. FAIRCHILD, Vice-President.  
CHARLES L. ROBINSON, Vice-President.LATHROP C. HAYNES, Secretary.  
ALFRED M. BARRETT, Asst. Sec'y.Prominent Jewelers } LUDWIG NISSEN.  
Among our Directors } A. K. SLOAN.  
LEOPOLD STERN.**THE ORIENTAL BANK.**

ESTABLISHED 1853.

182 and 184 Broadway, <sup>Corner</sup> JOHN STREET, NEW YORK.

Capital, - - - \$750,000.00.

Surplus and Profits, 1,100,000.00.

**ACCOUNTS FROM THE JEWELRY TRADE ARE SOLICITED.**R. W. JONES, Jr., President.  
NELSON G. AYRES, First Vice-President.  
GEO. W. ADAMS, CashierLUDWIG NISSEN,  
ERSKINE HEWITT, } Vice-Presidents.  
CHARLES J. DAY, }

R. B. ESTERBROOK, Assistant Cashier.

**The Market and Fulton National Bank of New York.**

ORGANIZED 1852.

81-83 FULTON STREET.

Capital, \$1,000,000.

Surplus, \$1,335,000.

ALEXANDER GILBERT, President.  
R. A. PARKER - - Vice-President.  
T. J. STEVENS, - - - Cashier.  
JOHN H. CARR, - Asst. Cashier.**Invites the Accounts of Jewelers.**

Will extend every facility that good banking will justify.

**SAFE DEPOSIT VAULTS.****The Chatham National Bank**

Broadway and John Street, New York

H. P. DOREMUS, Cashier

GEORGE M. HARD, President

W. H. STRAWN, Ass't Cashier

**THE STATE BANK**

376-378 GRAND STREET, NEW YORK

Capital and Earned Surplus, over \$1,100,000. Deposits over Fourteen Millions.

Offers a favorable market for short and long time jewelry and diamond paper

The Officers and Directors of

**THE MERCANTILE NATIONAL BANK**

of the City of New York announce  
the removal of their banking rooms  
to their new quarters in the Western  
Union Building, 195 Broadway,  
corner of Dey Street, and invite your  
inspection of their equipment

WATCHWORD *for the*  
FALL SEASON *of*  
1906    ::    ::    ::

**B**IGGER  
**B**ETTER  
**B**USIER

THIS IS THE  
SIGN OF THE  
TIMES    ::    ::    ::

**B**IGGER  
**B**ETTER  
**B**USIER

*LIKE OURSELVES you are, no doubt, going to be Busier than ever this coming Fall. We would advise your selecting stock earlier than usual. The showings we have provided for you are Bigger and Better. Satisfactory Prices prevail. Don't fail to look here before buying Fall goods.*

**B**IGGER  
**B**ETTER  
**B**USIER

D. C. PERCIVAL  
& CO. INC. 373  
WASHINGTON ST.  
BOSTON, MASS.

**B**IGGER  
**B**ETTER  
**B**USIER

IMPORTERS  
MANUFACTURERS  
AND JOBBERS



## Bigalke & Eckert Co.

### Importers of Watches,

No. 1 Maiden Lane, New York.

Single and Split Second Timers in Nickel  
and Gun Metal Cases.

Complete Assortment of  
Chronographs, Split Seconds and  
Minute Repeaters.

Ladies' and Gentlemen's Flat and Ultra Flat Watches.  
Flat Calendar Watches.

SOLE AGENTS FOR

Huus, Neveux & Cie.

FINE GENEVA WATCHES.





## New York Notes.

(Continued from page 65.)

week on the *Amerika*, after an extended stay in Europe, purchasing diamonds.

J. Abelow, who for several years has been in business in Maiden Lane, recently opened a retail store at 5005 Third Ave., Brooklyn, N. Y.

The Keystone Watch Case Co. last Friday declared its regular semi-annual dividend of 3½ per cent. on the common and 3¾ per cent. on the preferred stock.

N. Langford, watchmaker, formerly of 5J Maiden Lane, and for the last 12 months with B. Rainess, has severed his connection with the latter and has opened a retail store at 962 Amsterdam Ave., near 107th St.

Archie Rutherford, formerly sales manager in charge of the New York office of the H. A. Kirby Co., is now connected with Powers & Mayer, diamond importers and manufacturing jewelers, 258 Fifth Ave.

W. H. Kinna, New York manager of the Elgin National Watch Co., returned last week from Sharon, Wis., where he went to attend the funeral of his mother. The sincere sympathy of the trade is extended to Mr. Kinna in his bereavement.

John E. Lomberg, 1534 Third Ave., is one of the witnesses in the case of Peter Caratza, accused of sending "Black Hand" letters to J. M. Marx, of Miller & Marx, lawyers. Mr. Lomberg was one of a number of the lawyer's friends to whom letters were sent.

Miss Flora Scheer, the 19-year-old daughter of William Scheer, jeweler at 544 Fifth Ave., last week saved a man from drowning in the surf off Arverne, L. I. She was bathing, and hearing his cries for help went to his assistance, keeping him afloat until a life guard reached them.

Samuel Chapin, of S. Chapin & Sons, retail jewelers of Oneida, N. Y., is one of the nephews of Russell Sage, to each of whom is bequeathed \$25,000. The Chapin family in Oneida, according to a report from that city, is quite numerous, so that in all \$250,000 of Mr. Sage's money is to go to that city.

About 500 people enjoyed the annual outing given a week ago last Saturday by Stern Bros. & Co.'s Mutual Benefit Association. The party took a boat at West 22d St. and went up the Hudson River to a grove near Newburgh, N. Y., where the day passed most enjoyably, being enlivened by athletic contests, music and dancing.

Julius Boasberg, of H. & J. Boasberg, 1358 Broadway, last Thursday caused the arrest of Max Heine on the charge of pawning a pair of diamond ear-rings bought from the firm on memorandum. Heine, who is 22 years of age, and lives at 63 E. 106th St., was held for trial in \$1,000 bail in the Jefferson Market Court.

It is announced by the Jewelers Board of Trade that A. C. Becken, of Chicago, will buy the business of J. H. Purdy & Co., Chicago, provided that the creditors accept 60 cents on the dollar. Mr. Becken has for a long time been anxious to add a tool and material department to his jobbing business, and as J. H. Purdy & Co. were willing to discontinue business, Mr. Becken took advantage of the opportunity. It is

thought that J. H. Purdy's creditors will accept the offer. If the deal goes through the new department of A. C. Becken will be turned into a stock company. J. H. Purdy & Co. are one of the oldest houses in their line, the business being established in 1875.

Theo. Bendus, a watch repairer giving his address as 24 W. 34th St., and another man were arrested last Friday on a charge of attempted smuggling. They were passengers on the steamship *Pretoria*, and are said to have concealed in their baggage a number of ermine furs and other articles. United States Commissioner Edward Russ in Hoboken held the two men in \$500 bail each.

Louis L. Grey, in business as Louis L. Grey & Co., at 71 Nassau St., is not associated with L. & B. Lehr, at 47 Maiden Lane, the two concerns being entirely separate. Mr. Grey wishes the above announcement made, as he thought that there was a possibility that a paragraph in last week's issue announcing the dissolution of his old partnership might be misunderstood.

Reuben Richman, 22 years of age, who said that he is a jewelry peddler and lives at 166 Eldridge St., was passing along Rivington St. on Sunday night when a woman pounced upon him and declared that he was her husband, who had deserted her two years ago in Russia. He denied that he ever saw her before. In the Essex Market Court, to which the two were taken, he was discharged, as the woman could not prove that he was her husband.

A man described in the daily papers as "Charles Bates, a wealthy jeweler of Providence, R. I., weighing nearly 300 pounds," fell into the East river as he was walking along the gangway with his wife to board the steamship *Kennebec*, bound for his home. Policeman McDonough made a thrilling rescue, jumping into the water after the jeweler. The men came to the surface close to the paddle-wheels, but the policeman clung to the unconscious jeweler until 'longshoremen with a rope rescued both. Friends in this city said that, while the weight was exaggerated in the published accounts, the jeweler was the administrator of the estate of the late Joseph M. Bates, of Bates & Bacon, Attleboro, Mass.

The New York store of the J. B. Owens Pottery Co., 70 W. Broadway, is being divided, and one-half will be occupied by John H. Ling, formerly buyer of the Siegel Cooper Co., who will represent several cut glass concerns. Mr. Owens will retain the other half for the display of specialties in pottery. He is the president also of the Zanesville Tile Co., 147 W. 23d St. The two concerns are separate, each having works at Zanesville, O. The pottery salesrooms on West Broadway were formerly in charge of W. H. Dunn, who some months ago engaged in business for himself as agent for several china and pottery concerns. Since Mr. Dunn's departure the salesrooms have been in charge of James M. Stewart.

P. H. Schonboud, Dodge Center, Minn., has filed a petition in bankruptcy, giving his liabilities as \$1,583 and his assets as \$1,783, of which \$715 is claimed to be exempt.

## Boston.

W. E. Woodman & Co. have moved from 500 Washington St. to 162 Tremont St.

E. M. Stanton, of Stanton & Glover, has been on a trip to Maine for a mid-summer vacation.

Charles W. Finlay, of A. Paul & Co., is at Warwick, Mass., for a brief respite from business.

D. C. Percival, Sr., of D. C. Percival & Co., passed the greater part of the month of July at Bethel, Me.

Frank W. B. Pratt, of the clock house of Daniel Pratt's Sons, returns, this week, from a three weeks' trip to Cape Porpoise, Me.

George B. Wilson, formerly shipper for Nelson H. Brown, is receiving congratulations from his friends in the trade on account of his wedding, announced to take place to-day.

Edgar W. Hodgson, watchmaker and jeweler, 56 Devonshire St., will remove to 27 State St., this month. Mr. Hodgson has returned from an outing cruise with the Boston Yacht Club, along the North Shore.

The remodeling work that is in progress at the store of A. Stowell & Co., 24 Winter St., is of an extensive character, and will completely transform the old facade into a very handsome exterior, in strong contrast with the rather unpretentious appearance which it has presented in the past. Large and handsome windows for display purposes will be a feature.

One of the papers last week published a story of United States treasury agents working to catch an organized band of expert smugglers who have been bringing diamonds and other articles into this port. Inquiry in the trade and at the Custom House failed to verify the report, or to obtain any details as to the work being done by the government agents.

William Parry Kennard, who died July 22 at Cazenovia, N. Y., from ill health, was the son of William H. Kennard, one of the founders of the great jewelry firm of Bigelow, Kennard & Co., this city. The deceased was born in Boston, Sept. 15, 1863, and after receiving a technical education went into the textile business. He was later secretary of the United States Sugar Refining Co.

The police, last week, were unable to find any clues which would lead up to the arrest of a thief who stole a large and valuable diamond from the store of Freeman & Taylor, 61 Temple Pl., some time ago. Several inspectors and the officers of the Lagrange St. Station, worked on the case. The man was about 35 years old, 5 feet 8 inches in height, and weighed nearly 180 pounds. He carried an overcoat on his arm.

Alterations in the store of the Smith, Patterson Co., since the concern leased the entire building at 52 and 54 Summer St., have been in progress steadily, and the handsome first floor retail department, now nearly completed, is one of the finest in the city. The changes have been made without interruption to business, although the store has been operated, of course, at a disadvantage. The wholesale department, formerly at the rear of the retail department, and in the basement, is now on the second floor.

## Ball's Official Standard R. R. Watches

WHAT WOULD YOU GIVE FOR A LIFELONG CUSTOMER?

Try this plan:

Sell your next watch customer a "Ball."

Its reliable performance will convince him you are a dealer to be depended on—he'll keep coming back for other things.

The watch will win you his business and friendship for always.

*Write for booklet, and watch this space.*

We want to add a lot of new friends to the Ball family of railroad watch dealers.

### THE WEBB C. BALL WATCH CO.

CLEVELAND  
Ball Building

CHICAGO  
804-6-8 Railway Exchange



ESTABLISHED 1854.

INCORPORATED 1893.

JUERGENS & ANDERSEN Co.,  
DIAMONDS,  
MAKERS OF FINE JEWELRY,  
92 TO 98 STATE STREET,  
CHICAGO.

23-25 Looijersgracht, Amsterdam, Holland.

## THE HERMAN KECK MFG. CO.

CUTTERS OF

# DIAMONDS.

MANUFACTURING JEWELERS.

SILVERSMITHS.

Recutting and Repairing of Diamonds.

17-19-21-23 West Fourth Street, CINCINNATI, O.

RUDOLPH NOEL

PHILIP NOEL

RUDOLPH NOEL & CO.

IMPORTERS OF

## DIAMONDS

2 Tulp Straat, AMSTERDAM

'Phone 1902 John

37-39 Malden Lane, NEW YORK



# WESTERN DEPARTMENT

Western Office:  
204 COLUMBUS MEMORIAL BUILDING,  
CHICAGO.

Telephone:  
4079 CENTRAL,  
CHICAGO.

VOL. LII.

CHICAGO, WEDNESDAY, AUGUST 1, 1906.

No. 26.

## Chicago Notes.

A. M. Keasey is the new city salesman for Graffe & Stanek.

C. A. Stenfelt, jeweler and optician, is starting in business in Austin.

M. F. Barger, of M. F. Barger & Co., is spending a few days in Michigan.

A. W. Sproehnle and family are spending the Summer at Lake George, N. Y.

S. F. McLaughlin, with Sproehnle & Co., has just returned from his vacation.

A. L. Fuller, of the Towle Mfg. Co.'s force, is on a vacation and fishing trip.

John J. Decker, of the Wm. A. Rogers, Ltd., force, is at home nursing a broken leg.

Emil Braude, of Emil Braude & Bro., has just purchased a new home on Marshfield Ave.

H. E. Richards, with E. V. Roddin & Co., has just returned from a vacation in the west.

A. Nordahl, of Nordahl & Ohlsen, 449 Milwaukee Ave., is enjoying an outing in Michigan.

H. M. Carle, manager of the Kcystone Watch Case Co., is on a short trip to western cities.

H. Holtman, of Holtman & Alter, is spending a three weeks' vacation at Ottawa Beach, Mich.

Isidor Drexler, city salesman for Meyer Joseph & Co., has been on the sick list for the past week.

Frank Shinn, of Charles L. Trout & Co., New York, spent a few days with friends here, recently.

W. E. Hayward, representative of the Alvin Mfg. Co., is taking an outing at Eagle River, Wis.

Herbert L. Joseph & Co. have filed a certificate to decrease the capital stock from \$100,000 to \$50,000.

Ole C. Land, 344 Milwaukee Ave., is making a visit of a few weeks in California and other western points.

G. A. Jewett, of the Chicago office of Hamilton & Hamilton, Jr., has been making a short trip in Michigan.

R. T. Kleckner, with the Theo. W. Foster & Bro. Co., has just returned from a successful trip to the coast.

G. M. Landon, representing the Homan Silver Plate Co., has returned from a vacation at Eagle Springs, Wis.

W. H. Loud has been in Chicago for the

past few days buying his opening stock. He will locate at Jackson, Mich.

R. E. Hill, George T. Lester and Carl Wolff, of the New England Watch Co., have started out on their Fall trips.

L. F. Dresser was in the city recently buying stock for the new store which he is opening at Michigan City, Ind.

W. G. Fisher, of the Wm. Donaldson Co., Minneapolis, stopped a few days in Chicago on his way to eastern points, last week.

Burton E. Chapman, of the Elgin National Watch Co. force, has just returned from an extended vacation in the Rocky Mountains.

D. Axman, manager of the Chicago office of the J. D. Bergen Co., will take a short vacation in Michigan and then will visit eastern points.

Charles Price and wife, Jacksonville, Ill., have been enjoying an outing at Mackinaw, Mich. They visited the trade here on their way home.

F. G. Thearle, of C. H. Knights & Co., has been spending some time of late at Lake Geneva. He is the president of the Chicago Club at that place.

E. J. Moore, a jeweler at Sidney, Australia, visited the factory of the Elgin National Watch Co. and spent some time with the trade here recently.

Oscar Sehnert, the popular foreman of the F. E. Morse Co., is making a tour of nearby rural points by horse and carriage. His family accompany him.

H. Schwartz is making a trip to Atlantic City and eastern points, where he hopes to spend an enjoyable vacation. He will return to Chicago about Aug. 15.

Max Mayer, with the Western Watch Case Co., left recently for a pleasure trip to Yellowstone Park and vicinity. He will return in the early part of August.

Albert E. Wuerterman, Champaign, Ill., is improving the appearance of his store as well as adding greatly to his facilities of display by putting in a new front.

Arthur E. Fairbanks, of Raton, N. Mex., visited the trade here a few days last week, stopping with his sister while in Chicago. He will visit eastern points before returning home.

C. H. Knights, of C. H. Knights & Co., has just had completed a new cottage at Lake Geneva, which he is now occupying with his family. Mr. Knights, however, ar-

ranges to be at his office a few days each week.

C. A. Vanderberg, Superior, Wis., is closing out his stock at that place by auction. He proposes to locate at Seattle, Wash., and was in Chicago recently buying stock for his new location.

J. A. Limbach, manager of the Chicago office of the Theo. W. Foster & Bro. Co., is visiting the factory at Providence, R. I., and other eastern points. Mrs. Limbach accompanies him.

Sol Hess, of Rettig, Hess & Madsen, and Oscar May, of Moore & Evans, are taking an outing in Michigan. They will visit the new factory of the Star Watch Case Co. at Ludington before they return.

H. C. Stern, now located at State St. and Garfield Boulevard, will remove to larger quarters in the fine, new building on Garfield Boulevard, a few blocks to the east, as soon as the building is completed.

E. M. Lunt, the manager of the Chicago office of the Towle Mfg. Co., is looking especially happy these days. A fine baby boy, which arrived at his home some few days ago, may have something to do with it.

Charles Connors, alias the "busy burglar," was arrested in St. Paul last week, and was brought here. The prisoner is believed to be the head of a notorious gang of thieves who have committed many robberies here, and the Chicago police think if he is the man they want they can connect him with the theft of jewelry last November from the Bauman Jewelry Co.'s show window.

The bid of \$150,000 made by C. D. Fahrney for the entire stock, fixtures and good will of the Cash Buyers' Union has been provisionally accepted by the trustee, Chas. L. Billings. This bid, which is \$20,000 higher than any other bid offered so far, will be confirmed by the court on Aug. 15 if no objections are raised by the creditors, or if no higher bids are received prior to that date. This will allow about \$125,000 to be distributed among the creditors representing accounts of nearly \$300,000.

At a meeting held at 3 P. M. Friday afternoon, July 20, the following members were elected officers of the American Horological Society for the ensuing year: President, Ed. J. Koch; first vice-president, A. W. Strickler; second vice-president, Loren L. Boyle; third vice-president, B. Kirner; treasurer, A. C. Becken; secretary, C. L.

# To the Jobbing Trade.



to help you

increase your sales.

You can do so by carrying our  
Staple lines of Diamond Mount-  
ings and Diamond Jewelry.

**IMPORTERS**

**SHIMAN BROS & CO.**

87 MAIDEN LANE, N. Y.

LONDON: 50 HOLBORN VIADUCT.  
AMSTERDAM: 2 TULP STRAAT.

FACTORY.

1, 3, 5 GOLD STREET.

**MANUFACTURERS**

Hoefler. Directors: Max Ellbogen, Benj. Allen, Julius Schnering, C. H. Knights and C. E. Walker. The hour of meeting was changed from 8 p. m. to 3 p. m. every third Wednesday in the month.

The jewelry store of L. A. Horn, 442 N. Clark St., was visited by a sneak thief last week, who got away with a tray containing 25 diamond rings, valued at \$800. A young man came into the store and asked to have a watch case weighed. After the weight of the case was told to him, he wanted the joint pins removed. On being told that it would take some time to do this he went out, promising to return shortly. Within a very few minutes after he had gone out, Mr. Horn noticed that a valuable tray of rings was missing, and that the sliding door on the inside of the show case was open. The police were promptly notified of the theft, but no hope for the recovery of the jewelry is entertained. Mr. Horn has been in business at this location for the past 25 years, and this is his first experience with sneak thieves.

Among the out-of-town buyers that visited trade here during the past week were the following: Henry Liebenow, of C. Liebenow & Son, Manitowoc, Wis.; John Walsh, Delphos, O.; Henry W. Gram, of Gerlach Drug & Jewelry Co., Carroll, Ia.; G. A. Goodale, Lenox, Ia.; C. E. Hobson, Chariton, Ia.; S. H. Ledden, Sedan, Kans.; H. B. Clark, Rantoul, Ill.; W. P. Reichert, Canton, Ill.; A. F. Hall, of Hall & Sayles, Janesville, Wis.; G. Anderson, Taylorville, Ill.; A. H. Frandsen, Monmouth, Ill.; B. H. Britton, Hampshire, Ill.; L. H. Holbrook, Kenosha, Wis.; Jonas Carlson, Cadillac, Mich.; M. B. Fitch, Buchanan, Mich.; George Chapman, of Chapman & Armstrong, Galesburg, Ill.; John Luckenbaeh, of Luckenbach & Co., and wife, Los Angeles, Cal.; J. W. Spence, Racine Jewelry Mfg. Co., Racine, Wis.; J. M. Bigwood and wife, Terre Haute, Ind.; W. D. Roeder, Dwight, Ill.; G. H. Wilson, Griggsville, Ill.; E. L. McDowell, Arkansas City, Kans.; M. J. Soukup, Decorah, Ia.

Formal letters of administration were filed by the Public Administrator in the estate of M. Lippert under date of April 26 of this year. The assets consist of two suburban lots in Chicago and jewelry merchandise contained in two trunks and appraised at \$5,700, of which about \$2,000 is in diamonds. This stock is in the custody of the Public Administrator, and will probably be disposed of in September to the highest bidder. The outstanding accounts amounted to \$7,000 to \$8,000, a small percentage of which has already been collected. The first payment to creditors will be made in April, 1907, and the balance at the close of the administration of the estate, which, in Illinois, is two years after filing letters of administration. Following is a list of creditors, so far as known: Bonner & Co., \$860; B. A. Ballou & Co., \$94; Daggett & Clap Co., \$84; S. K. Grover Co., \$28; Hutchison & Huestis, \$87; Hirsch & Flashner, \$1,538; H. C. Lindol & Co., \$87; George L. Paine Co., \$90; Parks Bros. & Rogers, \$10; Plainville Stock Co., \$59; Rodenberg & Smith, \$101; Shiman Bros. & Co., \$1,018; J. J. Sommer & Co., \$47; Thornton Bros., \$133; Julius Wodiska, \$137; C. A. Marsh & Co., \$130; Zimmern, Rees & Co., \$603.

## Cincinnati.

C. C. Stoner, of Lindner & Co., will leave this week for the west.

Lee Loeb, of Herman & Loeb, will visit the eastern cities this week.

D. Jacobs, of D. Jacobs & Co., and family is spending the Summer at Atlantic City.

Joseph Miller, of Moers & Miller, Wabash, Ind., was a visitor to the city last week.

Edward Bohmer, watchmaker for Benj. Greenwald, is reported as seriously ill at his home.

J. C. Daller, Sr, manager of the Clemens Oskamp Co., is making his regular western business trip.

A. A. Oaks, manager for the Oskamp Jewelry Co., has returned from an enjoyable Lake trip.

Joseph Hornback will leave this week on his first road trip for Albert Bros. through Indiana, Ohio and Michigan.

M. C. Costello, bookkeeper for Thoma Bros., is again at business after a sojourn at Kentucky numeral springs.

George Gruen, secretary of the D. Gruen, Sons & Co., and wife are staying a few weeks at Clark's Lake, Mich.

Henry Birkenbusch, Pekin, Ill., stopped here last week en route from the skat players' convention at Buffalo, N. Y.

William Pflueger and William Eichelberger, of Joseph Noterman & Co., are home from a fishing trip spent in Michigan.

H. Peck, manager for Wallenstein, Mayer & Co., is much elated over his new title, "grandpa," occasioned by the recent arrival of a granddaughter.

Clarence C. Buehrig, Minier, Ill., has gone out of the repair business and has accepted a position with the Consolidated Time & Lock Co., of this city.

Leonard J. Fox, of the Gustave Fox Co., leaves this week on his usual Pacific Coast trip; B. Ganz, of this house, is home from his eastern trip, and L. Scooler has left on a business trip in the middle west.

Frank Herschede, of the Frank Herschede Co., with his family, is making his annual automobile tour, which will include New York and way points. Charles Lucius, of this firm, leaves Aug. 2 on a pleasure tour through the eastern cities.

The engagement of Miss Ohlen Holland, daughter of John Holland, of the John Holland Gold Pen Co., to Archer Griffin Dean, Avondale, a member of the Dean Gas Engine & Foundry Co., Newport, Ky., is announced. The wedding is to take place in November.

Out-of-town dealers who replenished their stocks here during the past week included: G. H. Becker, of Blumenthal & Becker, Murfreesboro, Tenn.; Herman A. Rohns, Cynthiana, Ky.; J. C. Meyer, Madison, O.; C. V. Loss, Athens, O.; E. Mueller, Hamilton, O.; Blumberg Bros., Chattanooga, Tenn.; W. H. Mueller, Stanford, Ky.; C. E. Salisbury, Ironton, O.

A young lady of refined appearance recently called at Joseph Mehmert's retail store, Freeman Ave., and asked to see some diamond jewelry. After selecting several fine pieces, for which she said she would call later, she left the store. Soon afterward it was discovered she had substituted an imitation stone for one valued at about

\$100. The girl has not yet been apprehended.

Miss Jean Huntoon, several years a representative of an eastern firm, has lately joined the selling force of the John Holland Gold Pen Co., and her territory will embrace the middle States. Mr. Baumgarten, who has been in the fountain pen business for several years, will represent this house in the Atlantic seaboard cities, and have headquarters in Washington, D. C. As yet the vacancy caused by the death of E. O. Pratt, late manager of the New York office, has not yet been filled, but the office will be retained as heretofore.

## Cleveland.

The daily press has announced that Curran Bros., jewelers at Zanesville, have filed a petition in bankruptcy. The assets are given as \$27,000, and liabilities \$40,000.

D. M. Redgeway, formerly with E. & J. Swigart, of Cincinnati, has joined the traveling force of the Sigler Bros. Co. He will probably travel a portion of Ohio, and give some attention to Cleveland business.

The Brunner Bros. Co. has tacked up a placard on the street show case that was robbed a few days ago, as follows: "The man that took the jewelry out of this case in broad daylight Saturday, 11 A. M., and left his hat, can have same by calling for it—if he wants it."

L. M. Sigler, of the Sigler Bros. Co., has just returned from his annual trip to the European diamond markets. C. C. Sigler, with his family, has gone to his country home near Warren. Frank Bromley, engraver at this house, returned a few days ago from St. Clair flats.

Capt. R. E. Burdick, of the Bowler & Burdick Co., will return from his annual trip to the diamond markets of Europe about the middle of August. While in Germany he will make arrangements for a large supply of the well-known anniversary clocks, for which the company is United States agent.

Out-of-town visitors in the city the past few days are as follows: L. J. Goddard, Ravenna; J. E. Beck, Martins Ferry; W. B. McCulloch, Greenwich; W. N. Crow, Millersburg; Frank Dyer, Caro, Mich.; F. D. Crampdon, Burton; Mr. Albaugh, of Albaugh & Son, Hillsdale, Mich., and H. S. Sumner, Akron.

Malcolm Sickles has accepted a position as traveling salesman with the Scribner & Loehr Co., taking the place of A. E. Knight, who resigned to go into the retail business at 8620 Hough Ave., this city. Mr. Gleason, son of J. P. Gleason, of Big Rapids, Mich., has also joined the traveling force of this company. All the salesmen will be on the road with their Fall samples this week.

O. T. Loehr, of the Scribner & Loehr Co., is spending a few days fishing at the headquarters of the Castalia Trout Club, a few miles from Sandusky. George Eroe returned a few days ago from a two weeks' sailing trip in his yacht on the lakes. The matrimonial fever seems to have struck this house with full force, several weddings having already occurred. Saturday William Strath, of the wholesale department, was married to Miss Lucy Mc-

Keon, and within a short time Miss Anna Rosenberg will become the bride of Joseph Brown, of this city.

## Kansas City.

C. P. Kionka, of Kionka & Kionka, is expected to return from his Colorado trip this week.

F. A. Ricketts, of this city, enrolled during the week with the Southwestern Optical College.

August Stuhl, of the Kansas City Polytechnic Institute, will leave soon for a vacation trip.

J. Levin, traveler for Kionka & Kionka, who came in last week from a trip in Iowa, is again on the road.

E. S. Kimber, a veteran retail jeweler of this city, has moved from his old location on Union Ave. to 1417 Grand Ave.

H. F. Rover, with the Woodstock-Hoefer Watch & Jewelry Co., went down to Excelsior Springs last week to pay a visit to his family.

Mr. Crerston, of the Kansas City Watch Case Mfg. Co., is enjoying a visit from his brother, W. T. Crerston, who is spending his vacation here.

L. Weixelbaum, formerly with the Barr-DeVault Jewelry Co., has resigned and engaged in business for himself on the fourth floor of the Missouri building.

M. Abrahamsen, who had been with Gurney & Ware, has resigned to take a position in the manufacturing establishment of Hassig & Krieke Jewelry Co.

C. C. Hoefer, of the Woodstock-Hoefer Watch & Jewelry Co., will leave next week for Plum Lake, Wis., accompanied by his family, for a vacation trip of a couple of weeks.

J. E. Brogan, St. Paul, Kans., was in this city last week, accompanied by his wife. They were on their way home from Denver, where they had been attending the Elks' convention.

Dr. S. W. Lane and wife left last week for Rochester, and from there will go on a 30 days' rest trip. During their absence both the Southwestern Optical College and the office will be closed.

James Potts, the well-known traveler of the Edwards & Sloane Jewelry Co., has just returned from a successful trip through Missouri, and is filling up his trunks with new patterns for another trip.

A. J. Roberts, who has been taking a course in engraving in the Kansas City Polytechnic Institute, has returned to his home in Chanute, Kans., and resumed his old position with H. E. Conklin.

The following out-of-town jewelers called on the trade here last week: F. G. Burgy, Brunswick, Mo.; Roy R. Smithers, Cameron, Mo.; Dr. Carder, of Bodley & Carder, Quenemo, Kans.; H. W. Seltz, Clay Center, Kans.; C. D. Hunt, Garnett, Kans.; Harry Kelly, Erie, Kans.; Leslie White, Lee's Summit, Mo.; Otto Burkland, Osawatimie, Kans.; Will H. Wright, Webb City, Mo.

A forged check for \$7.65 was recently presented at the store of A. B. Allen, S. Union Ave., Pueblo, Colo. J. L. Bowers, who was later arrested on a charge of writing and signing the check, which was presented by another man, protested his innocence and declared that he could not even write.

# THE WESTERN CLOCK MFG. CO.

NEW YORK  
51 Maiden Lane

La Salle, Ill.

CHICAGO  
131 Wabash Ave.



## THE ALTERNATING

Rings and stops alternately for 15 minutes at intervals of 20 seconds.

**T**HE ALTERNATING is the clock you have all been waiting for; a good reliable low-priced intermittent alarm. The movement is SIMPLICITY itself—no extra wheels, nothing to get out of order, and all the advantages of the Western Casting Process: FRICTION-LESS Pivots, SELF-CENTERED Wheels, HARD-STEEL PALLET Escapement.

4½-inch dial

7 inches high

75c. net

AT YOUR JOBBER

## St. Louis.

The firm of Ben Barnett & Co. has moved from 607 Pine St. to 203 N. 6th St.

The Crescent Loan Co. has moved from 7 N. Broadway to the northeast corner of 6th and Pine Sts.

W. A. Gill, 612 Olive St., is spending his Summer vacation by taking week-end fishing trips to St. Clair, Mo.

F. J. Bross, of the L. Bauman Jewelry Co., departed Monday of last week for a trip over his territory, Illinois.

J. S. Loftis, of Loftis Bros. & Co., visited Manager Williamson of the local branch last week, coming down from Chicago.

S. Ruby, 511 N. 6th St., will shortly improve and enlarge his place of business. He will take in 16 more feet on the north side.

George Emling, with Herman Mauch, 506 Franklin Ave., and Miss Lillie Beneke were married Saturday. They made a short western honeymoon trip.

W. F. Kemper, 2326 Franklin Ave., has increased his working force by the addition of Fred Hellmuth, a jewelry repairer, formerly with the Eisenstadt Mfg. Co.

E. W. Borrmueller, buyer for the silverware department of the Mermod, Jaccard & King Jewelry Co., has returned from his vacation, which he spent in fishing in Michigan waters.

Jules Franklin, H. W. Raymond, of Worthington & Raymond, and L. A. Epstein, of L. A. Epstein & Co., all of New York, were among the jobbers who called on the local trade last week.

Paul Deckelmann has resigned as secretary of the H. G. Bergfeld Jewelry Co. W. K. Bergfeld, who is now manager of that company, will make a trip through Illinois the early part of August.

F. L. Jaccard, Texas representative for Bauman-Massa Jewelry Co., stopped over in this city last week. With his family he was en route home after a vacation trip in Minnesota.

The decision of the Retail Jewelers' Association of Missouri not to give the annual picnic this year is not being taken as final, and strong pressure is being brought to bear to cause the association to reconsider its action. The prospects now are that the picnic may yet be given.

Mr. and Mrs. Frederick W. Drosten departed recently for New York, whence they sailed yesterday on the *Kronprinz Wilhelm* for an extended trip abroad. They will visit London, Antwerp and Paris. Mr. Drosten while abroad will purchase precious stones for the F. W. Drosten Jewelry Co.

The piscatorial prowess of Herman Mauch, president of the Retail Jewelers' Association of Missouri, was described in *The Republic* of last Sunday. A photograph showing a big catch was given. Mr. Mauch is also vice-president of the Montezuma Hunting and Fishing Club on the Illinois River.

E. Dick Richards, of the Maschmeyer-Richards Silver Co., is now on the road, traveling through Missouri, Kansas and Nebraska. Other members of the traveling staff of that firm are Erbin Schoenle, formerly with the A. J. Jordan Cutlery Co., St. Louis, with territory in Texas, Oklahoma and Indian Territory, and Walter

Woods, who will work in the north and northwest.

Among the visiting jewelers in St. Louis last week were the following: J. H. Greer, Fort Worth, Tex.; Charles S. Erber, Texarkana, Ark.; Mr. Cook, of Mushert & Cook, Sherman, Tex.; W. H. Wheeler, Palmyra, Ill.; John Roark, Winchester, Ill.; H. Chamber, Bonne Terre, Mo.; M. Ziegler, Kimmswick, Mo.

## Pacific Coast Notes.

Louis and Harry Lefkowitz, diamond merchants, New York, are visiting in Los Angeles, Cal.

H. C. Paulson, manager of the store of J. Johnson, Sonora, Cal., visited San Francisco last week.

The wholesale jewelers of Los Angeles, Cal., with two exceptions, have arranged to close their stores at 1 p. m. on Saturdays, until Sept. 1.

M. W. Jenks, for many years in the retail jewelry business at San Diego, Cal., died suddenly of heart failure at his home in that city, aged 48 years.

It is thought that the New Padrara Mexican Onyx Co., which is developing an onyx mine at Santa Catherina, Lower California, will soon establish a factory for the finishing treatment in San Diego, Cal.

Worth Merritt, a member of the San Diego Gem Co., San Diego, Cal., has been missing for several weeks, and it is believed that he has been lost in the Colorado Desert. Mr. Merritt's wife and mother are anxious for news regarding his whereabouts.

The firm of T. Goodman, which operated three jewelry stores in San Francisco, all of which were destroyed by the fire, has opened a store in Stockton, Cal. The company is located at 112 E. Main St., will carry a complete line of jewelry, and, later, will add an optical department.

S. Huppert, 39 N. El Dorado St., Stockton, has been charged with grand larceny. It is alleged that Huppert made away with a watch valued at \$100, which was left with him to be repaired. A warrant has been issued for his arrest, but it is thought he has gone to San Francisco.

The store of D. A. Reid, Vacaville, Cal., was robbed last week while Mr. and Mrs. Reid were calling on a friend. The thief gained an entrance by cutting the wire screen and going through a rear window which was open. The sum of \$165 in money was taken, with 25 gold and silver watches and a case containing 36 gold set rings. The robbery was reported to Constable Stadfeld, but he was unable to locate the thief.

By the final accounting of the will of the late C. W. Bush, formerly engaged in the retail jewelry business in Los Angeles, Cal., the Masonic Board of Relief will receive over \$35,000. The testator had intended to give the board a much larger sum, but the laws of the State prohibiting the bequeathing of more than one-third of the estate for charitable purposes prevented the will from being carried out to the letter. By order of the Probate Court, over \$50,000 will be distributed pro rata among the blood relatives of the deceased. When Mr. Bush died, June 8, 1905, his estate con-

sisted of \$100,000 worth of realty, \$50,000 in cash, and personal property.

## Indianapolis.

Horace A. Comstock is again competing in the shooting tournament for the English Hotel Cup. He and Mrs. Comstock are spending the Summer in a camp north of Broad Ripple.

Chief of Police Metzger has promulgated rules designed to make it difficult for pawn shops to buy stolen jewelry. Special patrolmen have been assigned to see to it that the rules are enforced.

Those jewelry firms which are represented in the Merchants' Association are observing half-holidays once a week this Summer. Some of the stores close Friday afternoons and others Saturday afternoons.

Among the out-of-town jewelers who visited the local jobbers and manufacturers last week were: Sol. Pennington, Knightstown; J. A. Miessen, Cicero; D. S. Whittaker, Lebanon; J. A. Pickett, New Castle; H. Wheeler, Dana; J. F. Harding, Brownsburg, and Aaron Pursel, Noblesville.

W. A. Cole, janitor of the Warwick Flats, last week found a quantity of jewelry in a closet of the building. The jewelry included watch chains and cases of bracelets, rings and lockets, all of which appeared to be new. The articles were turned over to the police, who are investigating.

Maurice Brower, an exporter of American pearls of New York, was here last week, on his way home from Southern Indiana, where he bought \$20,000 worth of pearls from local mussel diggers. This is the largest transaction in pearls in Indiana since the pearl industry was established. The finest pearl in Mr. Brower's collection was a large one, for which he had paid \$2,500. Mr. Brower said that he would soon take his Wabash river pearls abroad. He says that they have ready sales in foreign countries.

A prominent jewelry manufacturing firm of this city is accused by George Cousins, a negro burglar under arrest, with having bought all the jewelry stolen by the prisoner. Cousins terrorized the wealthy residence section of the city for several weeks. He entered two or three homes a night, and obtained jewelry valued in the aggregate at \$7,000. He was finally caught and lodged in jail. During the "sweating" he confessed to 40 robberies. He said that all his plunder had been bought by a certain jewelry concern. He explained that he would break the gold and silver articles into small pieces and then sell it. He declared that he had received not more than \$500 for all his plunder. The prisoner was taken before the members of the jewelry firm accused. He said they were the ones who paid him for his plunder. The firm made vigorous denial. The police are not inclined to believe the negro's story.

Hopkins & Witty, Dubuque, Ia., are about to begin the work of enlarging their store at 864 Main St. The entire building has been leased by the firm, and will be remodeled.

*Distinctly  
Impressive  
Lines*



*For  
Up-to-Date  
Jewelers*

**T**HE CREATIVE SKILL of the foremost designers of Jewelry abroad contributes to the artistic lines with which this establishment stands identified. The touch of Parisian genius and the glamour of the romantic Orient are manifest in these showings.

The trade is familiar with our popular lines of Bracelets, Combs, Necklaces, etc. Past achievements are exceeded this season. Special attention is called to the artistic use of the Garnet in our Bracelets and Necklaces. Showings in Jet and the most perfect artificial stones.

*D. Lisner & Co.*

*Creating Importers of*

*Jewelry Novelties*

*One-Forty Fifth Avenue, cor. 19th St., NEW YORK*

**ROCKFORD SILVER PLATE COMPANY**  
ROCKFORD, ILL.



*Only  
Retail  
Jewelers  
Can  
Buy  
It*

*Rockford  
Silver  
Plate  
Co.  
Made  
It*

**Watchword of the Craft—"Stand By Those Who Stand By You"**



INDEX TO ADVERTISEMENTS.

Alkin-Laubert Co. ....	112	Hagstoz, T. B., Ltd. ....	112	Ostby & Barton Co. ....	23
Allsopp & Allsopp ....	22	Hahn, E., & Co. ....	97	Page-Davis Co. ....	109
Alvin Mfg. Co. ....	Inside front cover	Hamilton & Hamilton, Jr. ....	9	Pairpoint Corporation ....	108
American Gem & Pearl Co. ....	60	Harris & Harrington. ....	Outside back cover	Parks Bros. & Rogers ....	18
American Platinum Works. ....	112	Hedges, A. J., & Co. ....	24	Passmore Gem Co. ....	80
American Ring Co. ....	34	Hedges, Wm. S., & Co. ....	54	Patek, Philippe & Co. ....	98
American Silver Co. ....	37	Heintz Bros. ....	29	Penfold, Wm. C., Co. ....	96
American Watch Case Co. ....	96	Heller, L., & Son ....	50	Percival, D. C., & Co. ....	68
Apollo Silver Co. ....	108	Herpers Bros. ....	102	Pomfret-Goldy School ....	110
Arch Crown Mfg. Co. ....	64	Hirsch & Hyman. ....	Outside back cover	Potter & Buffinton Co. ....	33
Arnstein Bros. & Co. ....	48, Outside back cover	Hodenpyl & Walker ....	50	Power, Chas. L., & Co. ....	54
Austin, John, & Son. ....	Outside back cover	Hoe's, James C., Sons. ....	97	Powers & Mayer ....	13
Aztec Turquoise Co. ....	60	Hold-On Watch Co. ....	30	Prior, Charles M. ....	26
Bagg, Perine & Co. ....	56	Holtz-Cabot Electric Co. ....	111	Prybibil, P. ....	111
Bail, Webb C., Watch Co. ....	70	Honesdale Decorating Co. ....	108	Pryor Novelty Co. ....	31
Baschkopf, Jacob ....	34	Hotel St. James ....	30	Rachne, Jules ....	94
Bassett Jewelry Co. ....	28	Howard, E., Clock Co. ....	97	Reed & Barton Co. ....	42
Bates & Bacon ....	20	Hraba, Louis W. ....	109	Reichhelm, E. P., & Co. ....	102
Bealmear, H., & Co. ....	109	Humphrey, John B., Co. ....	60	Renziehausen, W. F., Co. ....	112
Berge, J. & H. ....	102	Illinois Watch Co. ....	8	Revell, A. H., & Co. ....	Outside back cover
Bigalke & Eckert Co. ....	68	International Gem Co. ....	60	Rice's, Bernard, Sons. ....	108
Bigney, S. O., & Co. ....	4	Jacot Music Box Co. ....	109	Ries & Armstrong ....	98
Billings, Chester, & Son. ....	52	Jeandheur, F., Jr. ....	102	Rockford Silver Plate Co. ....	76
Blig, Ferdinand, & Co.'s Successors. ....	104	Jeanne, Frederick A. ....	58	Rockford Watch Co. ....	80
Bishop, R. W. ....	111	Jewelers' League ....	110	Roger Williams Silver Co. ....	80
Blackton, R., & Co. ....	16	Johnston, W. J., Co. ....	10, 11	Roseman, A. ....	58
Blacklinton, W. & S., Co. ....	12	Jorgeson, F. C., & Co. ....	109	Rosenbloom, M., & Co. ....	35
Blancard & Co. ....	102	Juergens & Andersen Co. ....	70	Ross, Saltman & Anderson ....	51
Bonet, L. ....	37	Juergensen, Jules ....	98	Rothschild Bros. & Co. ....	28
Borrelli & Vitelli ....	54	Kahn, L. & M., & Co. ....	Outside back cover	Roy Watch Case Co. ....	94
Bowden, J. B., & Co. ....	23	Kassel, Abe. ....	37	Rubenstein, L. W. ....	17
Bradley Polytechnic Institute. ....	80	Keck, Herman, Mfg. Co. ....	70	Rudolph & Snedeker ....	98
Brower, Maurice ....	52	Kent & Woodland ....	25	Rumpp, C. F., & Sons. ....	109
Brnhl Bros. & Henius Co. ....	Outside back cover	Ketcham & McDougall ....	109	Sadler, F. H., Co. ....	33
Bryant, M. B., & Co. ....	23	Klipper Bros. ....	97	Saunders, Meure & Co. ....	54
Buckley, Sam'l, & Co. ....	26	Kohlbusch, Herman, Sr. ....	112	Schiff, M. ....	25
Bunde & Upmeyer Co. ....	48	Kohn, Alois, & Co. ....	25	Schultz, Leiss & Co. ....	21
Cahoone, Geo. H., Co. ....	34	Kohn & Co. ....	29	Sessions Clock Co. ....	96
California Jewelry Co. ....	35	Koshland & Italic Co. ....	31	Seymour, Cassius W. ....	22
Carrington & Co. ....	24	Lackner & Ohl ....	27	Shiman Bros. & Co. ....	72
Carter, Howe & Co. ....	25	Langendorf Watch Co. ....	58	Stegel, Rothschild & Co. ....	110
Chatham National Bank ....	64	Larter & Sons. ....	49	Smith, Alfred H., & Co. ....	44
Chopard Frères ....	50	Lederer, S. & B., Co. ....	31, 32	Smith, E. H. H., Silver Co. ....	112
Columbia Jewelry Supply Co. ....	110	Lehong, L., & Bro. ....	Outside back cover	Smith, Frank W., Co. ....	19
Conley & Straight ....	112	Levy, L. W., & Co. ....	80	Snow & Westcott ....	26
Cooper Diamond Co. ....	52	Levy, Robert ....	19	Sohn & Hyman ....	58
Cottle, S., Co. ....	26	Lewy & Cohen ....	26	Solidarity Watch Case Co. ....	36
Crohn, M. ....	24	Libby Glass Co. ....	106	Spencer, E. L., Co. ....	32
Cross & Begneliu ....	36, 64	Lisner, D., & Co. ....	76	Staninger, E. E. ....	34
Crouch & Fitzgerald ....	26	Lissauer & Co. ....	50	State Bank ....	66
Day, Clark & Co. ....	27	Loeb, Wm., & Co. ....	31	Steiner, Louis ....	36
Depasse Mfg. Co. ....	24	Lorsch, Albert, & Co. ....	Outside back cover	Stern Bros. & Co. ....	58, Inside back cover
De Selms Watch School ....	97	Love, Edwin, & Co., Inc. ....	31	Sternau, S., & Co. ....	18
Diamond Point Pen Co. ....	102	Luthy & Hine ....	25	Stilwell, L. W. ....	30
Didisheim, Hipp., & Bro. ....	94	Lyons Gem Co. ....	37	St. Louis Silver Co. ....	30
Donnelly, J. J. ....	102	Maehert & Reiss ....	98	St. Louis Watchmaking School ....	97
Doran, Bagnall & Co. ....	34	Maple City Glass Co. ....	106	Strauss, Ignaz, & Co. ....	108, Outside back cover
Dordlinger, C., & Sons. ....	106	Market & Fulton National Bank. ....	66	Strauss, Jacob, & Sons. ....	38
Dubois Watch Case Co. ....	98	Mathey Bros., Mathez & Co. ....	98	Street, Geo. O., & Sons. ....	22
Dulk, Robert ....	97	Mendes Cutting Facilities ....	109	Tavannes Watch Co. ....	55
Duubar, Leach, Garner Co. ....	102	Mercantile National Bank ....	67	Tivoli Art Glass Co. ....	106
Durand & Co. ....	24	Meyerowitz Bros. ....	77	Trenton Watch Co. ....	97
Eichberg & Co. ....	58	Miller, Fuller & Whiting ....	28	Trout, Charles L., & Co. ....	24
Elgin National Watch Co. ....	92	Moe, Charles. ....	37	Van Dam, Eduard ....	52
Eliassof Bros. & Co. ....	35	Moore & Sons ....	22	Wadsworth Watch Case Co. ....	6, 7
E. P. H. Chain Catch ....	29	Mount & Woodhill ....	56	Wagner Mfg. Co. ....	27
Fahys, Joseph, & Co. ....	1	Murray, Dan I. ....	80	Waite-Thresher Co. ....	32
Fairchild & Co. ....	97	Myers, S. F., Co. ....	31	Waltham Watch Co. ....	90
Favre-Jacot, Georges, & Co. ....	97	Nebeling, Edmund R. ....	34	Washington, C. Irving ....	29
Feeley, W. J., Co. ....	30	New York Central Railroad. ....	110	Welsh, Chester H. ....	29
Forman Co. ....	30	New York Telephone Co. ....	111	Wendell & Co. ....	5
Forsinger, J. W. ....	97	Nissen, Ludwig, & Co. ....	56	Western Clock Co. ....	74
Foster, Theodore W., & Bro. Co. ....	38	Noel, Rudolph, & Co. ....	70	Wheeler, Hayden W., & Co. ....	44
Freund, Henry, & Bro. ....	21	Nonnenmann, A., & J. Aschenbrenner. ....	34	Whiteside & Blank ....	45
Friedlander, R., L. & M., 46, Outside back cover	46, Outside back cover	Noterman, Jos., & Co. ....	35	Whiting & Davis ....	20
Garraud & Griser ....	36	Ohan, G. ....	97	Whiting Mfg. Co. ....	15
Gesswein, F. W., Co. ....	102	Ollendorf, L., Co. ....	22	Wodiska, Julius ....	27
Goodfriend Bros. ....	54	Oppenheimer Bros. & Veith ....	44	Wolfsheim & Sachs ....	28
Gorham Co. ....	62	Oppenheimer, H. E., & Co. ....	44	Wood, C. F., & Co. ....	Outside back cover
Gougelman, Paul ....	109	Oriental Bank ....	66	Wood, J. R., & Sons. ....	2, 3
Griffoul, August ....	102	Orkin Bros. ....	36	Woodside Sterling Co. ....	14
Guardian Trust Co. ....	66	Osmun-Parker Mfg. Co. ....	24		

MEYEROWITZ BROS.,

IMPORTERS OF

DIAMONDS,

37-39 MAIDEN LANE,  
NEW YORK CITY

A Complete Line of Precious, Semi-Precious and Imitation Stones. Mail orders promptly attended to.  
Telephone, 4577 John.

## Special Notices.

Payable invariably in advance.

Rates 75c. per insertion for notices not exceeding 25 words; additional words, 2c. each.

SITUATIONS WANTED, 1c. a word each insertion; minimum charge, 25c.

Heavy type, 5c. a word; minimum charge, \$1.25.

Display cards, \$2.00 per inch.

In all cases, if answers are to be forwarded, 10c. extra to cover postage must be enclosed.

All answers to advertisements addressed care *The Jewelers' Circular-Weekly*, should be sent to the *New York Office*, unless the *Chicago Office* is specifically mentioned.

## Situations Wanted.

SITUATION WANTED by good, all round watchmaker; do some engraving; good references. Jeweler, 528 Jackson St., Sandusky, O.

WASHINGTON, D. C.; good watchmaker wants position in Washington, D. C.; best reference; no bad habits. Address "Jeweler," Box 272, Marion, Va.

AN EXPERIENCED young man desires a position in a wholesale jewelry house. Address "Unquestionable References, 6972," care Jewelers' Circular-Weekly.

SALESMAN of experience, and well acquainted with trade in middle west, would like to connect with a manufacturer. "Reliable, 6969," care Jewelers' Circular-Weekly.

WANTED, by young lady with seven years' experience in jewelry business, position as confidential clerk; state salary. "S. E. F., 7049," care Jewelers' Circular-Weekly.

WANTED, A POSITION as engraver, bookkeeper, cashier and saleslady; good references; terms reasonable. Address "Enquirer, 5877," care Jewelers' Circular-Weekly.

YOUNG LADY, good engraver, jeweler and A1 saleslady, wishes position Sept. 1; southern States; best of references; state salary. Address 698 S. Pryor St., Atlanta, Ga.

WANTED, POSITION by an experienced general letter and monogram engraver, city or country; will accept a position at once. "G., 7069," care Jewelers' Circular-Weekly.

BY YOUNG MAN, 18 years; experienced; position as retail salesman; given the best of satisfaction; of good address; west preferred. "M., 7012," care Jewelers' Circular-Weekly.

FIRST CLASS designer and modeler on novelties and sterling silver hollow ware; artistic and practical; desires position. Address "A. B. C., 7027," care Jewelers' Circular-Weekly.

YOUNG MAN, 22, desires position as watchmaker, engraver and jewelry repairer; have had five years' experience; can give good reference. Address "C., 7015," care Jewelers' Circular-Weekly.

A PRACTICAL WATCHMAKER and engraver desires steady position; 17 years' experience at bench; full set of tools; references A1. Address "Steady, 7015," care Jewelers' Circular-Weekly.

PERMANENT POSITION as watchmaker, engraver and salesman, wanted at once; practical man; good habits; not less than \$25 per week accepted. "Practical, 7060," care Jewelers' Circular-Weekly.

COMPETENT watchmaker and adjuster, jeweler, engraver, optician, to change Sept. 1; good habits, splendid references; capable of taking charge. Address "A. B. C., 6967," care Jewelers' Circular-Weekly.

WATCHMAKER AND SALESMAN, with New York experience, desires position with New York City jewelry house, where ability will be recognized, best of credentials furnished. "C., 7039," care Jewelers' Circular-Weekly.

EXPERIENCED letter and monogram engraver, also can assist on jewelry and clock repairing and plain watch work. Ohio preferred, good habit and references. "Engraver, 7018," care Jewelers' Circular-Weekly.

PERMANENT POSITION wanted in State of New York only; by first class watchmaker and jeweler; 25 years' experience; salary not less than \$20 a week; best of references. "R., 705," care Jewelers' Circular-Weekly.

FIRST-CLASS WATCHMAKER, good salesman and fair engraver; can come at once; 10 years' experience; go anywhere; transportation and salary of \$18 per week; total abstainer; A1 references. B. Gardner, Indianapolis, Ind.

DESIGNER, first class artistic designer on fine jewelry, is open for engagement. "L., 7041," care Jewelers' Circular-Weekly.

WANTED, SEPT. 1, position by watchmaker and engraver; 15 years' experience; used to railroad work; own tools and have had experience as buyer and manager in retail store. Address "H. I. N., 7009," care Jewelers' Circular-Weekly.

YOUNG MAN, possessing complete knowledge of wholesale jewelry business, desires position where advancement is possible; long experience and unquestionable references; no objection to hard work. "N., 7055," care Jewelers' Circular-Weekly.

WATCHMAKER, competent to take full charge, desires position Aug. 20; 15 years' experience; prefer railroad work; accustomed to taking in and delivering work; references from former employers. Address "W., 7063," care Jewelers' Circular-Weekly.

A WATCHMAKER of recognized ability; trained in London; 15 years' American experience; seeks position in first class firm as fine watchmaker and adjuster; highest references; have also New York optical diploma. "H. G., 6794," care Jewelers' Circular-Weekly.

A1 WATCHMAKER, graduate optician; fine letter and monogram engraver; 21 years' experience; good appearance; no bad habits; A1 references; lathe, modern tools and trial case; Indiana or Illinois; would not go east of Indiana. Address "C. W., 6963," care Jewelers' Circular-Weekly.

FIRST CLASS watchmaker, engraver and optician; good salesman, etc.; will be open for a position about Oct. 1; capable of taking full charge of store; only a steady position at a good salary will be considered; reference furnished. Address "E. F. O., 6995," care Jewelers' Circular-Weekly.

OPEN FOR ENGAGEMENT about Sept. 15, an experienced watchmaker and up-to-date engraver; have other qualifications pertaining to the jewelry business, but prefer the above work only; 25 years' experience; 40 years of age; hours, 8 to 6; west preferred. Address "A. R., 7011," care Jewelers' Circular-Weekly.

ENGRAVER, a mechanic and executive of known ability, just finishing contract, desires a change; all kinds of ornamental work, surface, relief or pierced; specialty Masonic and emblem work; cutting for enamel, chasing and die cutting pertaining to same; thoroughly reliable, best of reference; only A1 position with reliable firm will be considered. Address "Gravure, 6988," care Jewelers' Circular-Weekly.

CATALOG MAN wants position; 15 years' experience in getting up successful catalogs, also as buyer, manager and "business getter;" satisfactory references furnished; moderate salary. Write "W., 7050," care Jewelers' Circular-Weekly, 103 State St., Chicago, Ill.

## Side Lines Wanted.

WANTED, gold line of jewelry; gold rings, gold chains; representative firm's make of goods; to sell on commission in conjunction with my diamond business for cities, Philadelphia, Baltimore and Washington, D. C. Address E. M. Bracher, 929 Chestnut St., Philadelphia, Pa.

## For Sale.

FOR SALE, one eight foot and one six foot oak wall or side clock case, new; hold 18 and 12 clocks respectively; good as new; will sell for \$10 and \$8 each, which is half what they cost; send money with order. J. E. Carr, Portsmouth, O.

## Help Wanted.

WANTED, watchmaker that understands his business; steady. T. A. Westmyer, Wheeling, W. Va.

WANTED, AT ONCE, a good optician who can also assist at watch work. W. C. Bryant, Bangor, Me.

WANTED, watchmaker, one who understands plain engraving preferred. Leo Slonim, Plainfield, N. J.

WANTED, optical clerk living in New York or suburbs. R. L. & M. Friedlander, 30 Maiden Lane, New York.

AT ONCE, watchmaker and engraver; permanent position to a good man. "M., 6849," care Jewelers' Circular-Weekly.

FIRST CLASS watchmaker wanted for permanent, good position; salary, \$25. Apply to N. Salzman, Galveston, Tex.

WATCHMAKER and engraver, and jeweler and engraver; permanent positions to competent men. Laebicotte & Co., Columbia, S. C.

WATCHMAKER, jeweler, engraver and optician; I want a good man; permanent position. "W., 7024," care Jewelers' Circular-Weekly.

WANTED, AT ONCE, watchmaker, jewelry jobber and clock repairer; wages, \$15; permanent position. J. H. Lepper, Mason City, Ia.

GOOD POSITION open for young man; one who understands the wholesale jewelry line. Fred Kaufman & Co., 565 Broadway, New York.

GOOD POSITION open for young lady, one who understands the wholesale jewelry line. Fred Kaufman & Co., 565 Broadway, New York.

BOOKKEEPER WANTED in wholesale jewelry house; one who can make himself useful. L. S. Meyer & Bro., 38 Maiden Lane, New York.

WANTED, a good watchmaker; \$25 per week; address with references and full particulars in first letter. Chas. S. Stiff, Little Rock, Ark.

WANTED, optician who understands testing eyes; good salary and chance for advancement. A. Kahn, 935 F. St., N. W., Washington, D. C.

FIRST CLASS SALESMAN, engraver or optician preferred, to go to Columbus, Ga. Address "F. T. P., 7059," care Jewelers' Circular-Weekly.

WANTED, a first class traveling optical salesman for southern territory; must have good references. Address Leonard Krower, New Orleans, La.

PERMANENT POSITION for thoroughly competent watchmaker; state salary and give references in first letter. Eugene V. Haynes Co., Atlanta, Ga.

WANTED, first class watchmaker; none but men of long experience need apply; steady position. Apply A. Weiner, 2827 Third Ave., near 149th St., New York.

SALESMAN, traveling south and west, to carry a good line of Swiss watches on commission as side line. Address "M. R., 7066," care Jewelers' Circular-Weekly.

FIRST CLASS WATCHMAKER, engraver preferred; state experience, salary wanted in first letter; steady position. A. Hawkins, 727 Eighth Ave., New York.

WANTED, competent watchmaker, optician and fine engraver; steady and pleasant position for a man well recommended. Address Jeweler, Box 466, Troy, Alabama.

WANTED, watchmaker's apprentice who has had some experience; must be active, ambitious, of neat appearance and well recommended. Albert Edholm, Omaha, Nebr.

WANTED, engraver and jeweler; send reference in first letter. Sylvan Bros., Columbia, S. C.

WATCHMAKER WANTED, a first class man, used to receiving and delivering, to work at front bench. Address or apply to Rowe Bros., 28 Washington St., Chicago, Ill.

WATCHMAKER WANTED; first class man in prominent New York retail store; state experience, references and salary expected. "Retail, 7047," care Jewelers' Circular-Weekly.

WANTED, at once, good watchmaker, jeweler if you can engrave so much the better; state experience, wages wanted; send photograph first letter. F. Middleburg, Charleston, Va.

**HELP WANTED.—Continued.**

WANTED, WATCHMAKER, must be good salesman; experienced; salary based upon ability. Jules Aschein, 37 Maiden Lane, New York; or, Southern Loan and Jewelry Co., Tampa, Fla.

WANTED, a first class diamond setter, one who can make diamond mountings preferred; salary, \$25 per week to start. Address A. C. Heinrich, Foreman, Geo. T. Brodnax, Inc., Memphis, Tenn.

WANTED, good engraver who can do fine monogram, old English and script lettering; good salary; permanent job; young man preferred. H. C. Abbott & Bro., 1905 Second Ave., Birmingham, Ala.

WATCHMAKER, experienced in fitting and selling watchmaker's materials and tools; permanent position for the right man; call or correspond; reference. Aisenstein & Woronock, 22 Eldridge St., New York.

WANTED, CLOCKMAKER, who is also an experienced letter and monogram engraver; send samples of engraving with references; and state salary wanted. Address C. L. Byrd & Co., Memphis, Tenn.

WANTED, experienced watchmaker, engraver and salesman; send sample of engraving, reference, age and salary expected; steady position and short hours. Address "Indiana, 6821," care Jewelers' Circular-Weekly.

SALESMEN, responsible men wanted who are now calling on drug, stationery or jewelry trade, to carry a side line of fountain pens; liberal commission to hustlers. "Pens, 7034," care Jewelers' Circular-Weekly.

SIDE LINE; splendid opportunity for a well-acquainted road man to carry prominent comb manufacturer's line for jobbing and department store trade, west. "A. C. M. E., 7006," care Jewelers' Circular-Weekly.

FIRST CLASS watchmaker and optician wanted; good opportunity offered to right party; steady position; in one of the large cities in Pennsylvania; write at once. L. W. Rubenstein, 54 Maiden Lane, New York.

WANTED, first class optician; one who understands lens grinding and is experienced as salesman; position permanent; send copy of reference, photo and state amount of salary expected. Address J. Levinski, Waco, Tex.

\$25 PER WEEK for first class watchmaker and engraver; optical knowledge desirable but not necessary; references, photo., samples of engraving and time could commence work in first letter. Jos. Mazer, McMeister, Ind. Ter.

WANTED, a first class optician; one who understands edge grinding preferred; steady employment and good wages to the right man; must come well recommended. Address "Central Connecticut, 6640," care Jewelers' Circular-Weekly.

WANTED, young man, watchmaker, jeweler and engraver, by Sept. 1, to work in retail store; a good job for right man; will pay \$15 per week for first year and raise thereafter; send reference in first letter. Meyer & Schamber, Meridian, Miss.

WANTED, salesman with established route in New England, to take line of sterling silver on commission in connection with non-conflicting line; must furnish first class references; line now ready. Address "N. E., 7018," care Jewelers' Circular-Weekly.

WANTED for Virginia, salesman, young man about 25 years old, with practical experience preferred; permanent position; \$50 per month with chance to advance; send photo and recommendations in first letter. Address care Room 711, 2 Maiden Lane, New York.

WANTED, WATCHMAKER, young American, with at least five years' experience preferred; must have lathe and all tools; position is permanent and chance to improve splendid; wages, \$16-\$18, start; full particulars in first letter to Herbert K. Smith, Jamaica, N. Y.

WANTED, first class watchmaker by one of the largest stores in New England; give all particulars in first letter regarding salary, references and capabilities; good salary and permanent position to good man. Address "N. L., 7070," care Jewelers' Circular-Weekly.

WATCHMAKER, one who can engrave preferred; must be good workman and come well recommended; of good appearance and one who can wait on trade; state experience and ability along with wages expected in first letter. Address "K. W. & E., 7031," care Jewelers' Circular-Weekly.

WANTED, a young man to do watch and clock work; one who can do plain engraving; don't want a high-priced man, but a young man who wants to finish the trade; a good chance for a good young man to finish his trade; state age, experience and salary wanted to start on. W. M. McNeal, Atlanta, Ga.

EXPERIENCED watchmaker and clock repairer; quick workman, for Washington, D. C.; fine French and chime clocks your special work; apply, stating years of experience and where, also age, and wages expected; life position to right man; hours, 8 to 6. "Box 6833," care Jewelers' Circular-Weekly.

WANTED, salesman for a leading American watch house to travel Pennsylvania and New York; an unusual opportunity; state experience and address in confidence, "Watches, 6930," care Jewelers' Circular-Weekly.

WANTED, a first class watchmaker and engraver; one who understands jewelry jobbing; good salary to strictly first class man; none other need apply; address with references. Cooper Queen Consolidated Mining Co., Bisbee, Ariz.

**Business Opportunities.**

FOR SALE, very cheap, old established jewelry and optical store. T. J. Skidmore, 750 Fulton St., Brooklyn, N. Y.

WEST VIRGINIA jewelry and optical store; \$2,500; 15,000 population. "V., 7022," care Jewelers' Circular-Weekly.

FOR SALE, a well established, good paying jewelry business in Chicago. Address "Paying, 7036," care Jewelers' Circular-Weekly.

FOR SALE, jewelry store established 10 years on the leading street in Boston; stock and fixtures, \$5,000. Address "Boston, 7014," care Jewelers' Circular-Weekly.

WANTED, a partner with \$10,000 in a well located jewelry business in Chicago; a fine chance for a hustler. Address "B., 7037," care Jewelers' Circular-Weekly.

JEWELRY STORE WANTED in prosperous eastern Washington town; good wheat belt; fine opening; should be taken immediately. Address "Prosperous, 7016," care Jewelers' Circular-Weekly.

\$2,500 JEWELRY AND OPTICAL BUSINESS, manufacturing city of 15,000, in the center of the coal and oil district of West Virginia; repair work, \$150 monthly; low rent; poor health reason for selling. "Z., 7021," care Jewelers' Circular-Weekly.

FOR SALE, jewelry and fixtures; railroad inspection; mining town of 2,100; northeast Missouri; only jeweler; nearest competition nine miles; reason for selling, failing health; this offer is worth looking after at once. Address "R., 7030," care Jewelers' Circular-Weekly.

CASH FOR WATCHES and diamonds; send them at once and get your money by return mail. Joseph Brown & Co., Fifth Ave. and Madison St., Chicago, Ill.

\$2,250 STOCK and fixtures in good town in Michigan; stock clean, no old goods; fixtures new and up-to-date; bench work \$65 per month; must be sold at once; fine opportunity for good workman and optician; population, 5,000; country seat; liberal discount for cash. Address "Liberal, 7025," care Jewelers' Circular-Weekly.

JEWELRY and stationery business, Central Texas; only workman in town; very little competition; stock and fixtures about \$2,000; annual sales about \$5,000; bench work averaged \$56 this year; have other business reason for selling; will sell or rent building; rent, \$20 per month. Address "J. W., 7053," care Jewelers' Circular-Weekly.

FOR SALE to quick buyer, at 50 cents on the dollar, an entirely new and complete stock of optical goods, including A. O. Co.'s gold goods, Stevens' filled goods, aluminum specs and eye-glasses, guards, temples, springs, and material for all work in gold, silver and aluminum, King's Crown Trial Case, De Zeng's Luminous Electric Ophthalmoscope and Retinoscope and other retinoscopes; giving up this department; goods in stock about one year. B. Marks, Jeweler, 10 3d St., Troy, N. Y.

FOR SALE, manufacturing jewelry business in good western city; no competition; plenty of city work, as well as surrounding country; most work, diamond mounting and emblem goods; shop well equipped; all expenses reasonable; good reasons for selling. Address, "P. H., 7019," care Jewelers' Circular-Weekly.

DO YOU WISH TO RETIRE? We buy jewelry stores to any amount; also entire stocks of jewelry, diamonds, watches, silverware, fixtures, etc.; we are known all over the United States to pay highest spot cash; notify us, we will call on you at once; all business transacted we handle strictly confidential. Address Brooklyn Purchasing Syndicate, 608 Broadway, Brooklyn, N. Y., or Tel. 2328, Williamsburg.

**To Let.**

DESK ROOM or part of office to let. 3 Maiden Lane, Room 53, New York.

TO LET, part of an exceptionally desirable office, with fine north light; opportunity for precious stone business or manufacturer's agent. Room 48, Lorsch Bldg., 37 Maiden Lane, New York.

WILL RENT to desirable party, desk room with office privileges, in light, attractive office; manufacturer's representative or diamond dealer preferred. "Maiden Lane, 7040," care Jewelers' Circular-Weekly.

FOR RENT, a desirable light office in the Prescott Building, eighth floor; for particulars inquire at room 55, 65 Nassau St., New York.

**TO LET.****Three Desirable Light Lofts**

At 31 MAIDEN LANE, N. Y.,

One door from Nassau St. Prominent location, center of jewelry district. Address F. J. Whiton, 130 Broadway, New York; or, your own broker.

**WORKSHOP NOTES**

(Third Edition)

For Jewelers and Watchmakers.

A collection of the latest practical receipts on the manufacture and repairing of watches, clocks and jewelry.

Price,  
**\$2.50**

300 pages (size 7½x 10½ inches), bound in cloth, stiff covers. Should be on every workbench.

Published by

**THE JEWELERS' CIRCULAR PUBLISHING CO.,**

11 John St., Cor. Broadway, New York.

# 25% to 40% SAVED

if you order at once. I cut the corners off expenses. No traveling men means 25 per cent. saved. Look at price, order to-day, as I will sell them all in a few days at such prices.

Enameled, all colors, complete in box, with pins to match. Plain, \$2.90 each. Fancy inlaid in gold, \$3.10 each. Plain enameled, without box, \$2.35 each. Fancy inlaid, without box, \$2.55 each.



- 9k solid gold chatelaines, plain cases.....\$4.25 each
- 9k solid gold chatelaines, engraved cases..... 4.50 each
- 14k plain polished cases.. 5.75 each
- 14k engraved cases..... 5.90 each
- 9k plain hunting, solid gold chatelaines..... 6.25 each
- 9k engraved hunt'g, solid gold chatelaines..... 6.50 each
- 14k polished, solid gold hunting ..... 8.00 each
- 14k engraved, solid gold hunting ..... 8.25 each

- Gun metal O. F. chatelaine watches .....\$1.70 each
- Silver O. F. chatelaine watches ..... 1.70 each
- Carmen watch bracelet, fine gold filled..... 6.75 each
- Silver hunting, ladies' chatelaine ..... 2.45 each
- Gun metal O. F. boys' watch ..... 1.75 each
- Silver hunting case boys' watch ..... 2.90 each

- Gun metal quarter repeaters .....\$15.25 each
- 6, 16, 18 sizes, complete in electro plated cases 1.75 each
- 6 size, 5-year complete watch, good mov'ts.. 3.00 each
- 16 size, 5-year complete watch, good mov'ts.. 3.15 each
- 6 size, 10-year complete watch, good mov'ts.. 3.25 each
- 16 size, 10-year complete watch, good mov'ts.. 3.55 each

These prices are net cash on arrival, or 10 days. I will not guarantee these prices to last 10 days longer; place your orders the minute you read this advertisement. If you want goods held and shipped later, pay 10 per cent. on your order as a guarantee, and I will hold goods for you 30 to 60 days. Should you send money in advance, and not like the goods on arrival, I will refund your money. I am handling this deal as a broker at a postage stamp price commission. Let me put you right, give me your orders on all such deals. Your dollar is your friend, why not save it with a man you can depend upon to cut the corners off expenses and give you the benefit? Try it once. Address the correct man for the correct price.

**DAN I. MURRAY, Manufacturer, Importer and Broker,**  
**3 MAIDEN LANE, NEW YORK.**

IF you have any stones in the rough—except diamonds—to be cut, our new cutting works will enable us to fulfill your every wish. All work guaranteed. Best results attained. Try us.

**PASSMORE GEM COMPANY**  
 LAPIDARIES, PRECIOUS STONES, ODD GEMS  
 373 Washington Street, Boston, Massachusetts

**Roger Williams Silver Co.,**  
 PROVIDENCE, R. I., AND NEW YORK, 860 BROADWAY.

**Sterling Only.**

RICH DESIGNS :: :: :: Photos on Application.



Real Seal Bags with inside purse, size of bag 8 x 6 inches

PRICE, \$36.00 A DOZEN  
 High Class—Best Value in the Market

**L.W. Levy & Co.**  
 580-582 Broadway, New York City

LEATHER GOODS, NOVELTIES  
 OF ALL SORTS, METAL,  
 GLASS, CHINA, GUN METAL, Etc.

**Horological Department,**  
**BRADLEY POLYTECHNIC INSTITUTE,**  
 Formerly Parsons Horological Institute,  
 PEORIA, ILLINOIS.

Largest and Best Watch School in America.  
 We teach Watch Work, Jewelry, Engraving, Clock Work, Optics. Tuition reasonable. Board and rooms near school at moderate rates. Send for Catalog of Information.

# Rockford Watches Speak for Themselves.

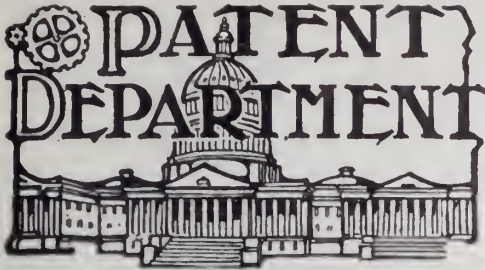

IN WHICH IS CONTAINED A LIST OF THE LATEST PATENTS GRANTED BY THE UNITED STATES AND GREAT BRITAIN, THE UNITED STATES PATENTS THAT HAVE EXPIRED AND THE REGISTERED TRADE-MARKS.

UNITED STATES PATENTS.

ISSUE OF JULY 17, 1906

**825,976. KNIFE.** ANDERS E. NEIGLICK, Chicago. Filed Dec. 11, 1905. Serial No. 291,204.

A knife comprising a handle, a blade slidably mounted within said handle, a sliding shifter for

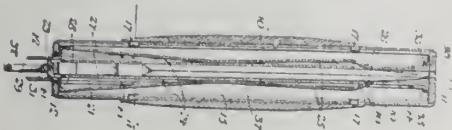

the blade within the handle having means at its inner end for detachably engaging the inner end of the blade and a spring-catch for releasably holding said shifter within the handle.

**825,987. MATCH-BOX.** AUGUSTUS F. THOMPSON, Huntington, W. Va. Filed April 6, 1906. Serial No. 310,384.

In a device of the class set forth, a casing open at one end and having a recess in one wall adjacent to its bottom, a match-holding casing telescoping therein and having a delivery-hole in its top and a longitudinal slot in its side wall near its bottom, and a combined locking and actuating



device consisting of a spring lying on the bottom of the casing and having one end formed into a spring-arm adapted to normally project the match-holder and its other end bent to lie against the wall of the casing and work in the slot in the match-holder wall, the upper end of this latter part being bent inward through the slot so as to engage the bottom of the match-holder, a part of said spring engaging in the aforesaid recess in the casing.

**826,047. ARTIFICIAL EYE.** EMILIUS MULLER, London, Eng. Filed July 23, 1904. Renewed Jan. 13, 1906. Serial No. 295,903.

In an artificial eye, a pupil therein conically



shaped and having an annular concaved surface between the base of the pupil and the point of said pupil.

**826,086. BRACELET.** GEORGE H. CHANDLER,



Providence, R. I. Filed Feb. 7, 1906. Serial No. 299,930.

An expansible bracelet or the like comprising a

pair of members A and B, the latter telescoping into the former, a head C at one end of the member A, a head D at the opposite end of the member B, a spring M connecting said heads, and hinge members J and K upon the outer faces of said heads C and D.

**826,232. COMBINED MATCH-BOX AND CIGAR-CUTTER.** WILLIAM H. J. DOWNEY, Middletown, Del., assignor of one-half to John P. McIntyre, Middletown, Del. Filed April 2, 1906. Serial No. 309,541.

In combination with a match-box, a rectangular outlined casing having one end projecting beyond the longitudinal edges thereof and apertured, one edge of said casing adapted to be held against the

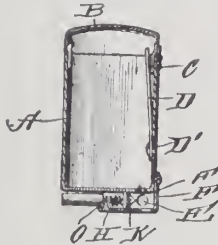

end of a match box, screws passing through registering apertures in said projecting end and the wall of the box, whereby said projecting portion may be held against the edge of the box, partition within the casing, a spring-pressed plunger mounted in registering apertures in said partition and one edge of the casing, an angled cutting-knife fixed to the end of said plunger and adapted to shear against the marginal outline of an aperture in the side of the casing, one end of said plunger extending through an aperture in the end of the casing, and a spring interposed between a shoulder upon said plunger and said partition.

**826,236. EYEGLASS SPRING AND ATTACHMENT.** WATSON D. FENIMORE, San Francisco, Cal. Filed Jan. 2, 1906. Serial No. 294,168.

In an eyeglass and in combination with the posts, boxes, and grips thereof, a horizontal bridge having its ends curved downwardly and inwardly whereby they lie substantially directly under the



horizontal portion, the extremities of said ends lying in a plane which is substantially at right angles with the plane of the lenses, and said extremities extending rearwardly beyond said curved portions and fitted to said boxes.

**826,299. CIGAR-PERFORATOR.** HENRY M. WILLIS, East Williston, N. Y. Filed Nov. 14, 1905. Serial No. 287,243.

A cigar-perforator comprising a flat plate forming a carrier-slide having longitudinal guides, and a flat plate forming a punch-slide having longitudinal slide-bars operating in said guides, said carrier-slide having a transversely-disposed nipple provided with a chamber for the reception and

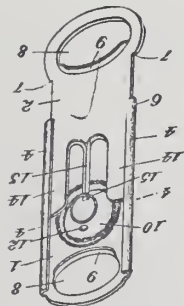

support of the cigar-tip and oppositely-disposed apertures in the walls of said chamber, and said punch-slide having a punch extending parallel with said slide-bars and at an angle to said nipple and located so as to pass through said apertures, and each of said slides having means whereby they may be slid upon each other.

**826,334. NAPKIN-PIN.** STEPHEN O. HICKOK and RICHARD W. McLAIN, Allen, Mich. Filed Nov. 3, 1905. Serial No. 285,740.

A napkin-pin formed from a single length of

spring-wire which is bent intermediate of its ends into substantially U-shape, one side of the clip being pointed to form a pin, and the other side constituting a shank, the free end of which is bent into a loop forming a handle disposed in the same plane with the shank and the pin and located outwardly from the point of the pin, with its ex-



tremity lying between the pin and the shank, the extremity of the rebent portion of the shank being bent to form a rounded terminal disposed between the shank and the pin and spaced from these elements to provide an entrance-opening between the pin and the handle, and between the inner end of the handle and the shank.

**826,444. STOP-WATCH.** JOSEPH PETRILLO, Boston, Mass. Filed May 24, 1905. Serial No. 261,925.

In a stop-watch, an arbor for carrying an indicating-hand, a gear fast thereon, means to connect said gear with and disconnect it from the train of gearing driving the mean hands of the

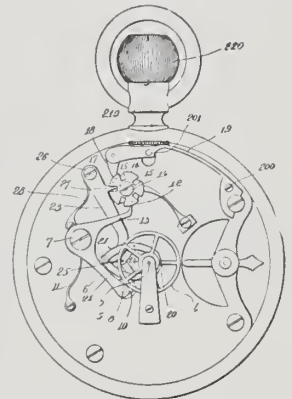

watch, and means to set said arbor to zero position, said latter means comprising a swinging setting-arm, a pair of setting-fingers carried by said arm and pivoted thereto, and a projection rigid with the gear to be engaged by said fingers.

**826,464. MATCH-BOX.** MARCUS O. ANTHONY, New York. Filed June 2, 1905. Serial No. 263,432.

As a new article of manufacture, a box-blank having the parts forming the sides, front, back and bottom of the box integral, and having a

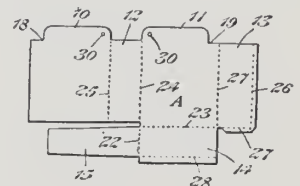

spring member attached to the part which is to form the bottom of the box, said member being independent of the part forming the back of the box.

ISSUE OF JULY 24, 1906

**826,552. FOUNTAIN-PEN.** CHARLES DUNN, New York. Filed July 3, 1905. Serial No. 268,033.

In a pen of the character described, a casing provided with an abutment at its rear end and integral



therewith and an opening therethrough, a penetration located at the opposite end of said casing, a piston-holder cylindrical in form, an extension-

rod provided with an enlarged end and of greater length than said piston-holder, and provided with a threaded end which is adapted to engage with said piston-holder, an abutment located on the end of said extension-rod which serves to prevent the extension-rod from withdrawing from the piston-holder at its rear end, a stem removably attached to said piston-holder, a piston mounted thereon, and a disk connected to said stem to secure said piston in place.

**826,563. ADHESIVE GUARD FOR EYE-GLASSES.** EDGAR J. GEORGE, Chicago. Filed Aug. 26, 1905. Serial No. 275,894.

In eyeglasses, means for supporting the glasses



upon the nose having opposite contact-surfaces adapted to embrace the nose and composed of a substantially solid substance having adhesive properties.

**826,628. PROCESS OF ENAMELING METAL AND THE RESULTING PRODUCT.** SAMUEL H. THURSTON, Long Branch, N. J. Filed May 25, 1905. Serial No. 262,137.

The process substantially as herein described of enameling metal, which consists in first forcibly beating one metal into and upon the other system

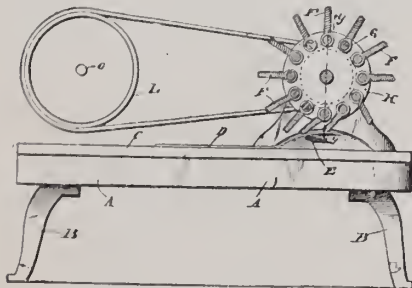

matically and continuously until the particles, or molecules, or the coating metal are driven into the metal being coated and incorporated with the particles at and beneath the surface of the same, thereby forming an adherent and coherent permanent coating irremovably united with the metal being coated, and then forming a coating of enamel upon said coating.

**826,635. STEREOSCOPE.** RICHARD R. WHITING, Cincinnati, O. Filed March 23, 1905. Serial No. 251,588.

In a stereoscope, a hood, two partitions E located between the lenses and separated by a space for the reception of the nose of the user, said parti-

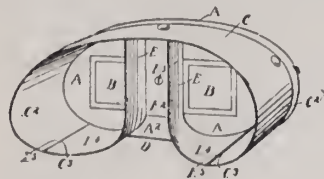

tions E extending from the plane of the lenses toward the face of the user, a back plate in one with the partitions E, and the hood at the bottom provided with the recess D, aligning with the space between the partitions.

**826,798. COFFEE POT.** ALBERT PETERMAN, Dallas, Tex. Filed Jan. 23, 1904. Serial No. 190,369.

A pot comprising, in combination, a body having a pouring spout and a cover, a receptacle removably mounted in the upper part of the body below the cover, a hollow handle disposed externally of and parallel with the body of the pot and threaded at its lower end, an induction-pipe communicating at its lower end with the body of the pot and enlarged at its upper end to form a valve-chamber, said valve-chamber having a shoulder and a threaded portion to engage the lower threaded end of the handle, a perforated guide-plate clamped against said shoulder by the handle, a valve controlling the passage in the induction-pipe and provided with a stem shiftable in said guide plate, a

pipe extending laterally from the upper end of the handle and projecting through the wall of the pot below the cover and forming a combined induction connection and stay for the top of the handle, a valve-pump piston in the handle, a stem connected to said piston and extending outwardly through the upper end of the handle and provided with a handhold, whereby the tubular handle forms

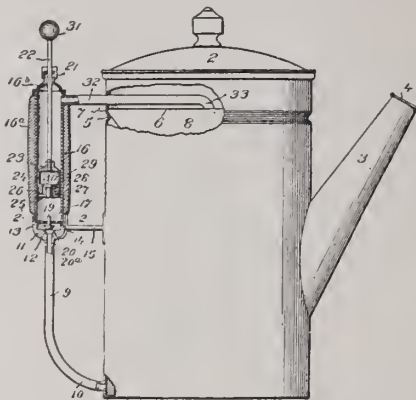

a direct connection between the induction and induction pipes and serves additionally as a pump-cylinder, the stem of the valve in the valve-chamber of the induction-pipe being so arranged as to be engaged by the pump-piston at the limit of the downward movement of the latter to positively close said valve and prevent it from sticking.

**826,719. TIMING MECHANISM FOR ENGINE-HOUSES.** JAMES M. GARDINER, Hackensack, N. J., assignor to the Gamewell Fire Alarm Telegraph Co., New York. Filed Feb. 10, 1905. Serial No. 245,067.

The combination with a signal-circuit, and two independently-driven time-indicating movements,

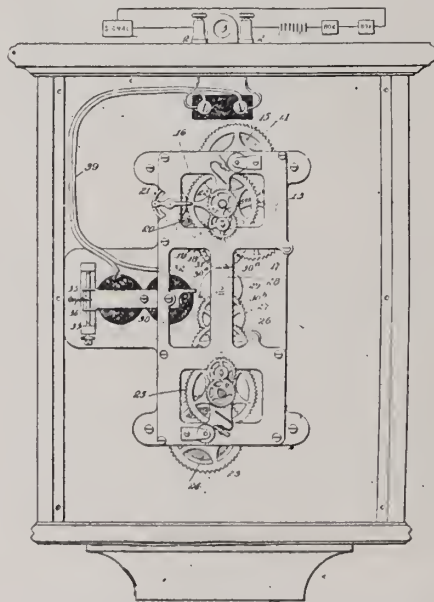

one movement being controlled by the other, and means for disconnecting the movements, the said disconnecting means being controlled by the signal-circuit.

**826,804. CIGAR-CUTTER.** FREDERICK RATCLIFF, Portland, Conn. Filed March 12, 1906. Serial No. 305,455.

A cigar-cutter comprising a pair of plates piv-



oted together near one edge, each plate having a cutting perforation and a finger that extends over the edge of the opposite plate.

**826,854. PIN-TONGUE.** THOMAS G. HUNT, Providence, R. I. Filed Feb. 19, 1906. Serial No. 301,763.

As an improved article of manufacture, a pin-

tongue having its rear or joint end portion bent

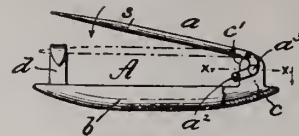

and terminating in lateral lugs integral therewith.

**826,913. PEN-POINT GUARD.** GEORGE E. WOODBURY, San Francisco, Cal. Filed Feb. 5, 1906. Serial No. 299,388.

A pen-point guard comprising a finger-piece pivotally attached to the holder behind the pen-point, a guard carried by said finger-piece adapted to set



over or in front of the pen-point, and a spring operating to set said guard in operative position when pressure is removed from the finger-piece.

**826,933. COIN-CONTROLLED CLOCK AND SAVINGS-BANK.** ANDREW J. HALL, Chicago. Filed Oct. 14, 1904. Serial No. 228,438.

In combination with a case having a key-aperture and a coin-aperture therein, coin-controlled apparatus arranged in said case and comprising, an arm pivotally mounted and adapted to be operated by a coin, a rod connected with one branch of said

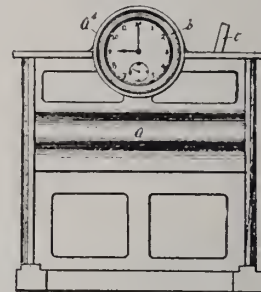

arm and having a shutter at one end thereof, a catch arranged to engage the other end of said rod, a lifting-bar connected with said arm and adapted to be engaged and held by a key, a coin-chute leading from the coin-aperture to the free end of said arm, and means for restoring the pivoted arm to its normal position upon the removal of the key.

**827,004. FOUNTAIN-PEN.** BENJAMIN F. FLINT, Cincinnati, O., assignor to David B. Kaufmann, Cincinnati, O. Filed Oct. 28, 1905. Serial No. 284,858.

A fountain-pen comprising a tubular barrel open throughout its length and having a longitudinal slot pierced in its side intermediate its ends, a pen-section carried at one end of the barrel, a plug carried at the opposite end of the barrel, a tube

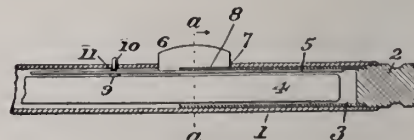

carried by said plug and extending into the barrel, an ink-sack carried by the pen-section and extending into the barrel and with its inner end extending within said tube, a presser-bar freely suspended within the barrel adjacent the ink-sack, a thumb-piece carried by the presser-bar and extending outward through said longitudinal slot and having a longitudinal notch, or slit, therein, adapted to be engaged by the inner end of the said tube and locking the presser-bar against actuating contact or engagement with the ink-sack.

**827,010. WATCH-POCKET.** LOUIS GREENWALD, Longview, Tex.; Saline Greenwald administratrix of said Louis Greenwald, deceased. Filed Nov. 20, 1905. Serial No. 288,242.

A watch-holder comprising a flap secured to a

garment and foldable thereagainst, a pocket on the

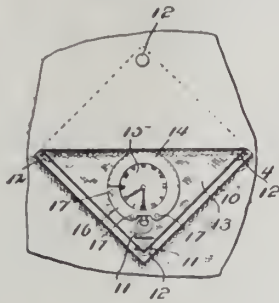

back of the flap, and means for securing the free end of the flap.

**827,022. FOUNTAIN PEN.** DAVID B. KAUFMANN, Cincinnati, O. Filed July 22, 1905. Serial No. 270,822.

A fountain-pen comprising a hollow barrel having a minute reservoir-opening in its side for the passage of a pin or the like, a compressible, tubular ink-reservoir removably inserted within the barrel, a press-plate unattached to said ink-reservoir and extended lengthwise in the barrel with an intermediate part in line with the said minute opening



therein and adapted to be engaged by a pin inserted thereat and a strip of elastic metal one end of which has attached connection with the press-plate and the opposite end of which has attached connection with the barrel, said strip being between the barrel and press-plate and being provided with a central opening registering with that in the barrel and being adapted to hold the press-plate normally retracted in close proximity to the wall of the barrel.

DESIGNS.

**38,120. BADGE.** FRANK B. BOWER, Philadelphia, Pa., assignor to Phi Kappa Sigma Fraternity, Philadelphia, Pa. Filed March 15, 1906. Serial No. 306,302. Term of patent 14 years.



Prints.

**1,734.—Title: "IT WINDS ITSELF."** (For a self-winding clock.) NATIONAL SELF-WINDING CLOCK CO., Champaign, Ill. Filed May 7, 1906.

**1,735, 1,736 and 1,737.—Title: "IT WINDS ITSELF."** (For a self-winding clock.) NATIONAL SELF-WINDING CLOCK CO., Champaign, Ill. Filed June 4, 1906.

UNITED STATES PATENTS THAT HAVE EXPIRED.

[Reported especially for THE JEWELERS' CIRCULAR-WEEKLY by R. W. Bishop, Patent Attorney, Washington, D. C.]

Issued July 23, 1889.

**407,375. FERRULE FOR UMBRELLAS AND CANES.** C. S. SMITH, Philadelphia, Pa.

**407,401. BELT.** JACOB HIRSHFELD, New York, assignor of one-half to A. G. Spalding & Bros., same place and Chicago.

**407,412. FOUNTAIN-PEN.** JOSEPH MORRIS, London, England.

**407,439. CURLING-IRON.** SAMUEL HAWKCRIDGE, Hohoken, N. J.

**407,449. POWDER-BOX.** J. E. ROEDER, Philadelphia, Pa.

**407,464. PERFUME-CARRIER.** OTTO ARMBRUSTER, Brooklyn, N. Y.

**407,481. WATCH-MOVEMENT HOLDER.** HEINRICH HEIDENREICH, New York, assignor to Henry Zimmern, same place.

**407,509. POSTAGE-STAMP HOLDER.** D. M. BLOCH, New York.

**407,517. PENHOLDER.** J. P. EGAN, New York.

**407,566. BRACELET.** W. B. BALLOU, North Attleboro, Mass.

**407,585 and 407,586. FOUNTAIN-PENS.** JOSEPH FRIEDMAN, Seymour, Conn.

**407,637. THIMBLE-EMBOSSING MACHINE.** JOSEPH BROWNING, Philadelphia, Pa., assignor to J. F., F. M. and E. S. Simons, same place.

**407,642. WATCH.** CONSTANT DINICHERT, Montilier, Switzerland.

**407,643. HINGED BUTTON.** R. W. A. DITTMAN, Hamburg, Germany, assignor to A. F. Richter, same place.

**407,668. HOLDER FOR RINGS.** C. A. KRON, New York.

**407,705. CUFF-HOLDER.** W. E. TERRY and E. K. HANLEY, Elmira, N. Y.

**407,719. THREAD-CUTTER FOR THIMBLES.** ORRIN CADY, Cincinnati, O., assignor of one-half to W. B. Pritchard, Waterbury, Conn.

**407,723. CHAIN.** J. E. CROOK, Providence, R. I., assignor of one-half to A. T. Wall & Co., same place.

Designs issued July 19, 1892, for 14 years.

**21,715. SPOON.** H. B. HOUTSROS, Philadelphia, Pa., assignor to J. E. Caldwell & Co., same place.

**21,719 and 21,720. WATCH CASE.** J. C. DUEBER, Canton, O.

**21,727. GLASS-VESSEL.** L. A. ROSE, Paris, France, assignor to L. Straus & Sons, New York.

BRITISH PATENTS.

(ABRIDGMENTS OF SPECIFICATIONS, 1905, FROM THE Illustrated Official Journal.)

ISSUE OF JULY 11, 1906.

**5,134. DRESS-PINS.** R. McKECHNIE, Ingleside, Cork, Ireland. March 11.

A point protector for hat-pins and the like consists of a tube *d*, Fig. 4, fixed to an ornamental frame *c* and carrying at the end a plate *f* with two spring arms *g*.

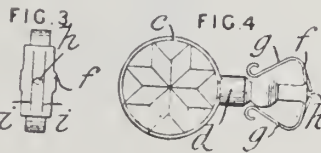

**5,160. PENS.** G. TUCKER, Federation Works, Birmingham. March 13.

Relates to fountain pens in which the nib can be withdrawn into the reservoir when not in use. One end *a*<sup>1</sup> of the reservoir *a* is open and the other is closed by a shank *b*, which is attached by screwing or otherwise and is provided with an axial hole *b*<sup>1</sup> and with a pair of longitudinal slots *b*<sup>2</sup>, *b*<sup>3</sup>. The rib *e* is secured between the end of

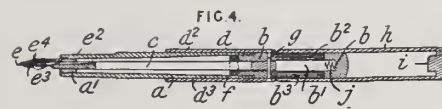

the feed-bar *c* and a sleeve *e*<sup>2</sup> which is fixed to the feed-bar and is provided with an extension *e*<sup>4</sup> running along the top of the nib. The sleeve *e*<sup>2</sup> closely fits the mouth of the reservoir, and when withdrawn into the reservoir allows the latter to be filled. The bar *c* passes through a cork, fiber, or other plug *f* into the aperture *b*<sup>1</sup> of the shank *b*. A pin *g*, passing through the end of the bar *c* and through the slots *b*<sup>2</sup>, *b*<sup>3</sup>, connects the bar *c* with an external slide *d*. A cap *h* is adapted to fit on to the shank *b* or the end *a*<sup>1</sup> of the reservoir, and is provided with a plug *i* which screws into the open end of the reservoir in order to prevent the escape of the ink. The slide *d* is provided with extensions *d*<sup>2</sup>, *d*<sup>3</sup> of such a length that they are engaged by the edge of the cap when the latter is placed on the reservoir. The nib is thus withdrawn into the reservoir before it can be injured by the plug *i* of the cap. A cushioning-spring *j* is provided for the end of the rod.

**5,176. KNIVES.** G. W. WHITLEY, North Finchley, London, N. March 13.

Handles, attaching to table knives, etc. The

tang *b* of the blade is made to extend through the handle, an enlargement *c* at the end fitting

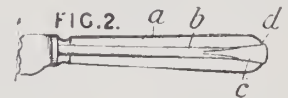

into a hole *d* in the handle *a*, which is made hollow in two parts. The tang is soldered to the handle at the bolster and the enlarged part at the end.

**5,299. LOCKETS, ETC.** II. T. DUMELOW, Hockley, Birmingham. March 14.

A locket or the like is formed of an outer metal shell *a* and a slide *b* containing photographs, miniatures, etc., and having a flange *f* and at-

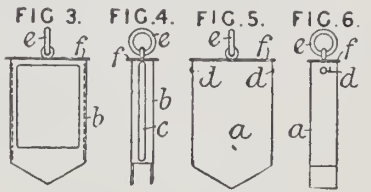

tachment ring *c*. Spring-like or other pegs *d* may engage grooves *c*, and the shell and slide may be elastic, to prevent accidental opening.

**5,310. WATCHES.** F. HARTMANN and J. OLIAK, both of Prague, Austria. March 14.

Going-Trains.—A watch is made which requires winding-up only once a week, but in which the length of the mainspring is still normal. The

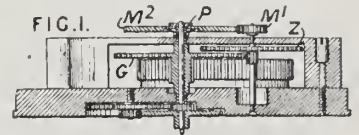

ratios of the wheels and pinions give four hours for the revolution of the center-wheel *G* and a quarter of an hour for the revolution of the third wheel *Z*. The center-arbor extends through the hollow arbor of the center-wheel and carries at the back a second center-wheel *M*<sup>2</sup> in gear with a wheel *M*<sup>1</sup> of one-fourth the size on the third arbor.

Motionwork.—Instead of having a cannon pinion, the center-arbor and second center-wheel *M*<sup>2</sup> are connected by a friction clutch *P*.

**5,647. CLOCKS.** J. A. T. ANDERSON, London. March 17.

Going-Trains: Framework.—A portable clock, Fig. 2, of small dimensions, but adapted to go for

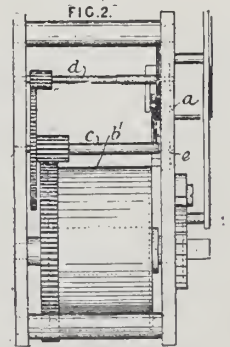

a year or more without re-winding, is made by gearing-up a spring barrel *b*<sup>1</sup>, such as would suit an eight-day clock of the same size, through two arbors *c*, *d*, to a watch movement without barrel. The pillar-plate *e* of the watch movement is let into the front-plate *a* of the main frame, and the center-arbor is prolonged in consequence of the dial-plate being in advance of the front-plate.

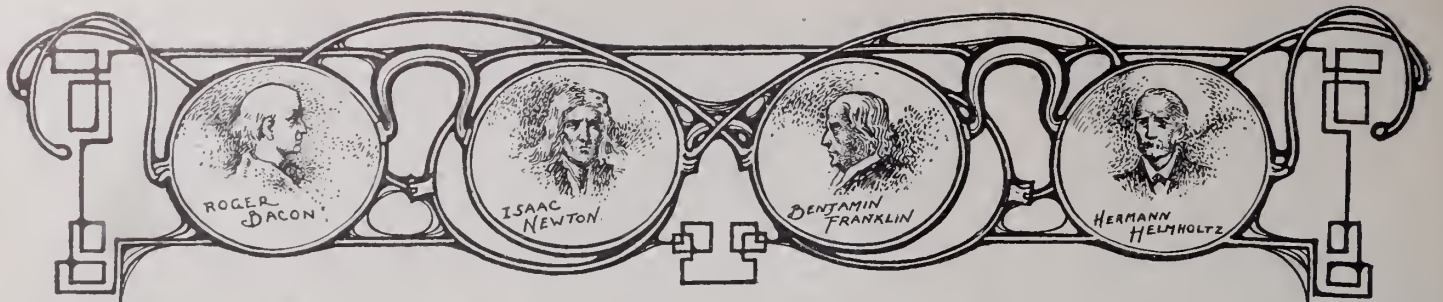

# OPTICAL DEPARTMENT

## The Optometrist's Catechism.

A SERIES OF QUESTIONS AND ANSWERS ON ELEMENTARY OPTICS, IN CATECHETICAL FORM.

By E. Le Roy Ryer.

Copyright, 1903, by THE JEWELERS' CIRCULAR PUBLISHING CO.

(Continued from issue of July 25.)

Q.—(660) What are the salient features of the old "refracting-angle" system?

A.—Numbering prisms by the angular deviation of their refracting surfaces was the method first used, but, like the old or inch system of numbering lenses, it is a faulty, unscientific method. Such a method gives only an idea of the construction and shape of the prism, but does not give a true idea of how powerful a prism is from a refracting standpoint. That is, two prisms may be made, one of crown glass and the other of diamond, but each with the same angular deviation or, in other words, each

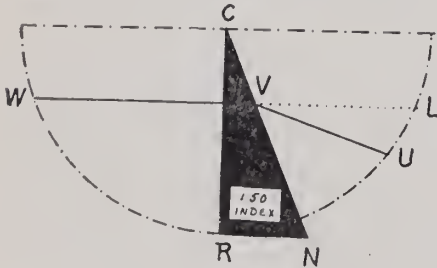

Fig. 87.

having exactly the same shape, and yet while the old method would assume them to be similar, the one made of diamond would have nearly double the refracting power of the other. Thus CRN, Fig. 87, represents a prism made of crown glass with refractive index of 1.50, while DIA, Fig. 88, represents a prism made of diamond with a refractive index of 2.70. The triangles, CRN and DIA, are equal because CRD being radii of the same sized circles, RN is made equal to IA, and are perpendicular respectively to CR and DI; angles CRN and DIA are therefore right angles and equal, and it is true of triangles that if they have two sides and one angle equal they will be equal in all respects. In our case, therefore, the angles, RCN, Fig. 87, and IDA, Fig. 88, are equal, and as the angles represent the angular deviation of the surfaces of the prisms, the old method would designate these two prisms equal. But in Fig. 87 a ray of light, WV, is refracted by the crown glass prism, CRN, from the direction L toward U, while in Fig. 88 the diamond prism, DIA, would

refract a similar ray, XY, from the direction J toward Z, and Z is one and four-fifths as far from J, Fig. 88, as U is from L, in Fig. 87; therefore, the prism DIA, Fig. 88, is in reality one and four-fifths as powerful as the same sized prism, CRN,

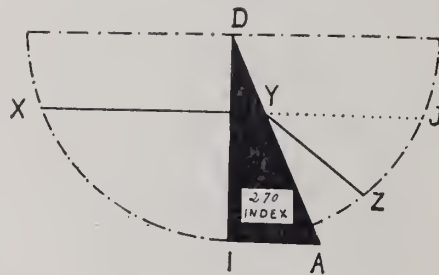

Fig. 88.

Fig. 87, yet their refracting angles are equal, and should, according to the old system, be equal in other respects. From this one instance all must conclude that such a method as that of numbering by the angular deviation gives no true idea of a prism's refractive value, and it is this value and not the shape of the prism or the deviation of its surfaces that concerns the optometrist.

Q.—(661) What is Dennett's method of numbering prisms?

A.—Dennett proposed calling the unit of measurement a centrad. A centrad represents a prism that will deviate a ray of light the 100th part of the arc of the radian. The measurements are made as follows: In Fig. 89, RA represents the arc of the radian. This arc is equal to as much of the circumference of the circle as will equal the length of the radius of curvature. In this case, NA equals the radius of curvature and RA equals 57.295 degrees. This arc of the radian, RA, is then divided into 100 equal parts. A prism, base down, at the center of curvature that will deviate a ray of light downward just a 100th part of this arc of the radian is called a centrad and equals 1/100th of 57.295 degrees, or .57295 of a degree. In Fig. 89, CEN represents a 10-centrad prism and bends the ray downward one-tenth of the arc of the radian, or from D to A, a one centrad would bend it only one-tenth as much, but

on a small diagram this could barely be noticed.

Q.—(662) What is Prentice's method of measuring and numbering prisms?

A.—During the last few years much more attention has been given muscular anomalies than they ever before received. The fact must also stand out conspicuously to the thoughtful observer that as time goes on more and more study will be given these conditions; and with the study of muscular insufficiencies is naturally associated the study of prisms. As it became evident that a standard lens was needed, so is it evident that a standard prism is needed; the lens unit (the dioptre) was suggested and accepted, and the same reasoning that proved the advisability of adopting the dioptre applies equally to the necessity of adopting

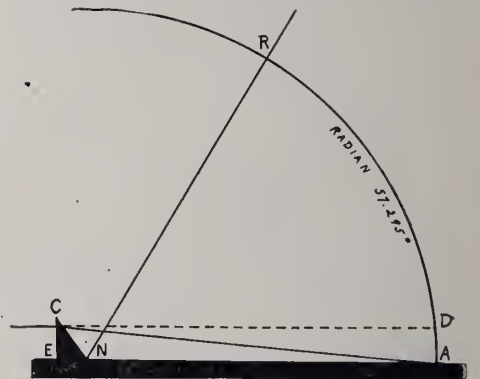

Fig. 89.

a standard unit for prism measurement. No one foresaw the demands of the future with greater clearness than Charles F. Prentice, who proposed as the standard unit the prism-dioptre. This method immediately met with approval from all sources. It is well for the American optometrist to know that both the Bausch & Lomb Optical Co. and the American Optical Co. made elaborate practical tests of the method, and, finding it so pre-eminently advantageous, discarded the old degree system entirely and now manufacture all prisms on the basis of the prism-dioptre. Dr. Swan M. Burnett said: "The old method of numbering prisms simply by the angular deviation of their sides is confessedly inaccurate and unscientific. Any attempt to supplant this by one more accurate and to place the nomenclature of prisms on the same basis of scientific exactness as the other optical appliances in the hands of the practical ophthalmologist is, therefore, deserving of consideration. The method proposed by Mr. Prentice not only does this, but does it in a manner and according to principles



**Optical Department.**

which are familiar to even the less scientific practitioners. To have the same unit (the meter) of measure and comparison for all refracting apparatus, and uniform with the nomenclature employed in the designation of anomalies of refraction and muscular equilibrium, gives a simplicity which is not only commendable in itself, but tends to render the study of the practical use of prisms easier and more comprehensive to

method of numbering prisms. We are, furthermore, in a position to state positively that heretofore this subject has not been given the attention it deserves; although the prism is one of the simplest and most fundamental elements in dioptries, its very simplest feature is not generally understood. Many indulge in high-sounding arguments concerning the prism's value in cases of heterophoria, and yet, if asked, could not tell to what extent a 1 Δ prism would affect a ray of light.

A prism-dioptry is a prism that will de-

first one, Z, being one centimeter from the principal axis or center of the lens. This ray Z, being one centimeter from the optical center B, is deflected from Z' to F, just one centimeter in the focal plane P F; the second ray, Y, is two centimeters from the center, B, and is deflected two centimeters, or from Y' to F in the focal plane P F; and the third ray X, being three centimeters from the center B, is deflected three centimeters in the focal plane, or from X' to F.

Thus a lens decentered one centimeter will produce as many prism-dioptics as the lens has dioptics of refraction. For instance, a lens of 1 dioptry decentered 1 centimeter will produce a 1 prism-dioptry; a lens of 2.D. decentered 1 C.M. will produce 2 Δ; and a lens of 5.D. decentered 1 C.M. will afford 5 Δ, etc. The prism-dioptic power is also in direct proportion to the amount of decentration—that is, a lens of 2.D. decentered ½ C.M. gives 1 Δ; or if the same 2.D. lens were decentered 2 C.M. it would produce 4 Δ, etc.

Q.—(664) What law governs the relation between the prism-dioptry and lens-dioptry?

A.—Any lens is capable of producing as many prism-dioptics as the lens possesses dioptics of refraction, provided the lens is decentered one centimeter.

If we remember the centimeter in connection with the prism-dioptry, as we do the meter in its relation to the lens-dioptry, no trouble will be encountered in making these calculations.

The author suggests the following rule: To obtain the prism-dioptic value of a decentered lens, multiply the lens-dioptics by

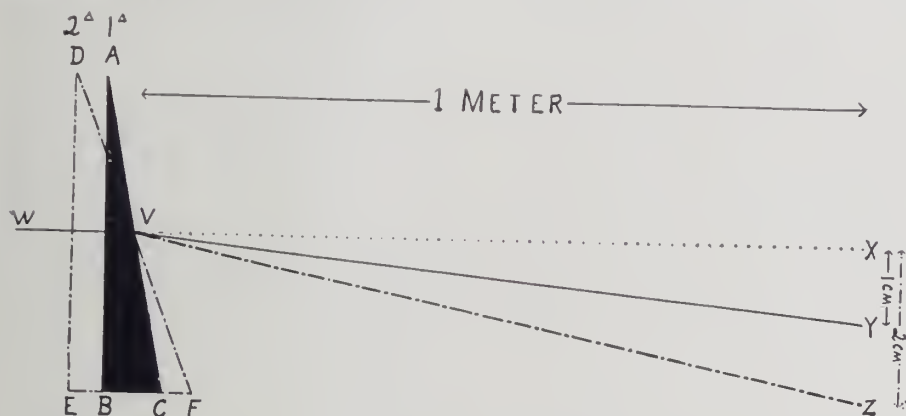

Fig. 90.

the student. This is particularly apparent in the connection the author establishes between the prism-dioptry, the lens-dioptry and the meter-angle."

When optometrists recollect how high feeling ran between themselves and medical men a few years ago, they will realize that this method must have had exceptional merit to elicit such remarks from the medical press as the above, and the following, printed in *Medical News*: "To Mr. Prentice alone belongs the credit of having proposed as a standard prism one which produces a deflection of one centimeter at one meter's distance, and no advocate of the centrad ever hinted at it until the appearance of his paper in the 'Archives of Ophthalmology.' We owe the simplicity of that idea to Mr. Prentice; let us not deprive him of whatever honor belongs to the conception."

Prentice first advocated a metric system of numbering and measuring prisms in 1890. It was he also who first suggested that the figure of a prism Δ, used as an exponent to the prism numerals, should be the symbolic sign for the prism-dioptry, it also being the letter D of the old Greek alphabet. By this means, one prism-dioptry (1 Δ) is readily distinguished from the prism of one degree (1°) refracting angle, and from prisms based upon any other system of numeration. Some advocates of the centrad claimed the right to use the symbol Δ as the sign for designating a centrad, but the figure of a triangle, no matter how placed in respect to the position of its sides, refers exclusively to the prism-dioptry, being so recognized by American manufacturers.

We have prefaced our description of the prism-dioptry with the above remarks with the hope of arousing our readers to a keener appreciation of the importance of gaining a full understanding of the prism-dioptry

deflect a ray of light one centimeter at one meter's distance. For instance, in Fig. 90 are shown two prisms. A B C is the unit or prism-dioptry, deflecting the ray W V one centimeter, from X to Y at a distance of one meter; D E F, same figure, represents a 2 Δ (two prism-dioptry) deflecting

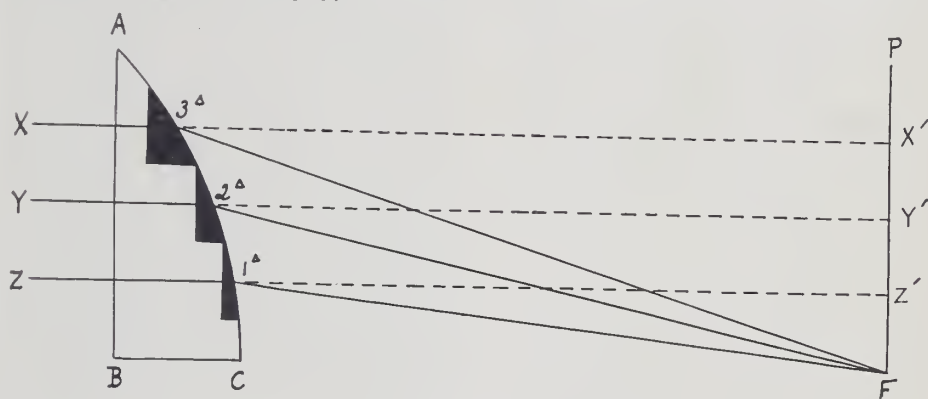

Fig. 91.

the ray W V twice as much—that is, two centimeters at one meter's distance, or from X to Z.

Q.—(663) Does the prism-dioptry bear any relation to the lens-dioptry?

A.—Yes; every lens, no matter what its dioptric power, contains all possible values of the prism-dioptry, it being only the size of the lens which in practice will set a limit to its prismatic power. The prism-dioptry constitutes a distinct part of every lens of the dioptric system. As Prentice claims, the prism-dioptry stands unchallenged in its unique ability to harmonize all of the refracting elements in the optometrical lens-case by establishing a complete and inseparable relation between lenses and prisms. Thus in Fig. 91, A B C represents a vertical section of a 1 dioptre plano-convex lens; X Y Z are rays incident upon its plane surface, and are one centimeter apart, the

number of centimeters of decentration.

The practical value of these principles cannot be too fully appreciated by the optometrist. Muscular work is destined to play a very important role in his work, and the basis of muscular correction is often prisms, and a prismatic effect can often be obtained with little extra cost by decentration that would cost heavily if the effect were to be obtained by incorporating a prism in the combination. For example, suppose the case called for + 4.00 D.S. ⊖ 2.00 D.C. 180 = 2 Δ base in; to grind this in the form of a spherocylinder-prism would be an expensive method; the same result could be obtained by decentering the spherocylinder ½ centimeter (or 5 millimeters, or, roughly, ¼ of an inch) and thus getting a prismatic effect equal to 2 Δ without actually using a prism.

(To be continued.)

## Optical Department.

### Anatomy of the Nervous System.

(Lecture recently delivered before the Rochester Optical Society by DR. RALPH H. WILLIAMS.)

(Continued from issue of July 18.)

WE have now arrived where we can deal with the functions of the various portions of the nervous system. Beginning with the cerebrum, we find it to be the center for all physical and mental process involving volition and consciousness. Volition is the starting point in direct motor activity, while consciousness is the final phase of sensory impressions. While, as has been shown in the matter of the reflexes the spinal cord is capable of carrying on elaborate and well co-ordinated reflex actions, yet it is incapable of initiating any motor impulses or of registering any sensory impulses.

As has also been shown, each hemisphere of the cerebrum is concerned only with the motion and sensation of the opposite side of the body, and the cerebrum has been studied until it is possible to accurately localize the areas controlling the different functions of the different localities. The cortex of the brain is the final and highest nervous element. While the optic thalamus and the corpora striata, the basic ganglia with which we have dealt, are important, they are yet secondary to the cortical tissue. This is proven by the fact that when a hemorrhage takes place which affects only the optic thalamus, unless it be of considerable extent no notice will be taken of it, whereas even the slightest hemorrhage in the cortical substance will cause a paralysis of some function, be it ever so slight.

We will not go into the details of the areas of the brain further than to mention the local of what is known as the visual area. This is located in the occipital lobes, which you will remember lie behind the ear and above a line drawn from the upper margin of the ear to the external occipital protuberance.

This localization has been carried to such a point, however, that it is now entirely possible to surgically remove causes of interference with the function of certain areas. The function of the cerebellum is that of co-ordination. It is the great center of co-ordination of the muscles of the body. It is not the only co-ordinating center, for, as has been shown, the entire cord has that function to a considerable degree, but the great and broad co-ordinating operations are conducted by the cerebellum. For instance, suppose you wish to look at some object squarely at your right. That impulse being originated by the higher cortical center, the lower centers take it up and distribute the necessary impulses to the muscles of the eye and to the muscles of the neck, and even to the back. It is this extensive co-ordination which is controlled by the cerebellum.

In order that it can properly perform this function, it must receive impressions. These impressions are of four kinds, and, as have been shown, reach it through the columns of Clark and the direct and crossed pyramidal tracts of the cord as well as by communicating fibres from other portions

of the brain. These impressions are tactile, muscular, visual and labyrinthine.

The first tactile is, as you all know, the impression carried from the nerves in the skin. The muscular sense is that sense which tells you the location and condition of a portion of the body without looking at it. Visual impression speaks for itself, and labyrinthine impressions are those which are carried to the brain from the semi-circular canals of the ear, and which show the position of the body in its relation to the perpendicular. All of these sensations enter actively into the performance of the function of co-ordination.

It would be impossible in the time at my command to deal with the physiology of all of the special senses. Many of them you are familiar with in a general way, and the physiology of the sense of sight is one of which you know more than I. I will therefore confine myself to a general discussion of the more prominent nerves of the body, and especially those most nearly related to your work.

Before taking up this subject I wish to again speak of certain efferent nerves which carry trophic impulses. As yet little is known regarding the nature of the end organ of this class of nerves, but it is located in the tissues themselves, and through it the nutrition, the building up and tearing down process which is always going on, is controlled.

In some portions of the body the direct source of these trophic nerves is only a matter of speculation, while in others it is definitely known. It is especially appreciated in the fifth nerve, the pneumogastric and, in a general way, the sympathetic. The cessation of operation of the trophic nerves results in a diminution of their usual constituents, but, on the other hand, there is an increase in the amount of fat.

In dealing with the anatomy of the cranial and spinal nerve I gave you more or less of their physiology in describing their function. This was only superficial, however, and there are a few points of special interest in connection with some of these nerves which I will deal with now. These are points which have more or less of a bearing upon pathological conditions.

The first cranial nerve or olfactory is of comparatively little importance for our purposes, so we will pass it by. While it seems superfluous for me to discuss the optic nerve before this society, I will risk the possibility of repeating something you already know, and discuss a few of the finer points of the physiology of this nerve.

It is connected centrally both with the psycho-visual center and with the pupil contracting center, and of course the reflex association of these two centers is close. It is possible for paralysis, or even degeneration, to take place of either one of these tracts of nerve independently, resulting in absolute blindness in the case of the fibres to the visual center and with dilatation of the pupil when the pupillary fibres are affected.

Perhaps no portion of the body is affected so much by what is known as reflex affection as is the eye, unless it be the stomach. The study of this reflex is a broad subject, and has brought comparatively little of definite knowledge as to the direct source

of the reflex effect, or rather its path. It is generally believed to be due to the effect upon the general vaso motor system, and on account of the delicacy of these structures in the eye that that organ is affected before an alteration in the blood pressure would affect other organs.

The two organs in the body in which pathological conditions are most often reflected in the eye are the liver and the female pelvic organs. Diseases of the liver frequently cause affections of the eye which are usually transitory or intermittent in character, but which are nevertheless very distressing. The so-called liver spots before the eyes are a common example of this condition. This is usually due to an increase in the blood pressure in the liver in even a slight congestion. Diseased conditions of the ovaries have often been the sole cause of quite serious conditions in the eyes, and a persistent irritation of the ovaries has been known to set up destructive diseases in the eyeball as a result of the persistent reflex irritation. This is a subject so broad and deep that it has received special consideration in monographs devoted to that subject alone.

A case recently under my observation suffering for a number of years from general neurasthenia of a pronounced character was unable to be fitted with glasses so that the eyes could be used with any degree of comfort. Glasses which would answer the purpose to-day would be far from correct a week from now. This condition persisted until the muscles of the eye became so weakened that there was little left to work with, and a course of muscular education was commenced. I had been aware for some time of the presence of serious conditions in the pelvis, but had endeavored to do what was possible to relieve them without resorting to the knife, a thing which the patient dreaded very much.

Finally conditions arrived at a state in spite of what could be done that it was necessary to go further. Investigation proved the presence of tumors in the cervix and walls of the uterus which were showing a tendency to break down with a possibility of becoming cancerous. An operation was resorted to immediately, resulting in the finding of one tumor in the cervix already broken down to the consistency of a cheesy mass, and another in the cavity of the uterus in even a more advanced state of degeneration. Two undegenerated tumors were found in the wall of the uterus, one in the right broad ligament, and the right ovary contained a cyst. All of these tumors were about the size of an English walnut. It was, of course, necessary to remove all but the left ovary.

The time is as yet too short to express a definite opinion as to what the state of the eyes will be in this case. The nervous system must be reorganized, but the progress is good, and everything points to a practically complete recovery in time. The eyes are already acting better, and I believe that in the course of a couple of years the patient can be fitted with glasses which will afford relief. Three years ago I expressed the belief that we would eventually find that the cause of that disturbance was pelvic, and my prediction seems to be in a fair way to be proven.

(To be continued.)

## AMERICAN OPTICIANS IN CONVENTION

### Report of the Opening of the Eighth Annual Meeting of the American Association of Opticians, at Rochester, N. Y.

ROCHESTER, N. Y., July 31.—The eighth annual convention of the American Association of Opticians, which opened yesterday, gives promise of being one of the most enthusiastic and largely attended meetings ever held by the association. Over 800 eye specialists from all parts of the country are present, and many have brought their wives. The visitors have been arriving since last Wednesday, and still more are expected. Delegates were welcomed at Haines Hall, where the meetings and exhibits are being held.

Yesterday morning was devoted to the convention of the Optical Society of the State of New York. Delegates for this convention registered from 10 o'clock to 11 o'clock in the morning. At 11 o'clock President W. W. Bissell of the State Society called the meeting to order. The minutes of the last meeting were read by Roger F. Williams, secretary, and approved by the delegates. Thanks were extended to Mr. Williams for his faithful work.

F. E. Robbins, Elmira, treasurer, read a report on the financial standing of the society. The report stated that the Optical Society of the State of New York had made a very substantial growth in the last year. "Considering the amount of work accomplished," said Mr. Robbins, "the society is in better financial condition than ever before. There have been more dues paid in advance than ever before in the history of the society. The society is one of the institutions of the State, and the future looks most promising."

The report of the Executive Committee was next read by H. C. Watts, chairman. The report briefly stated what had been accomplished during the past year and what work still remained to be done.

E. E. Arrington, chairman of the Legislative Committee, reported on the work that had been done at Albany during the past year. He spoke of the failure to pass the "Optometry Bill" and the reasons for the failure; further, he stated what must be done by the members of the society to secure their rights. Mr. Arrington said that his paper on "Legislation," which he will read Wednesday, will more fully cover the subject.

Following the report of the Legislative Committee, President W. W. Bissell delivered his annual address, which will appear in a forthcoming issue of THE CIRCULAR—WEEKLY.

At the close of President Bissell's address some time was devoted to a discussion of plans and ideas for the future. Delegates then took a recess until 2 o'clock in the afternoon, when unfinished business was taken up and later legislation discussed and considered in every possible light. Throughout, the meeting was lively and enthusiastic. Before closing the session officers and directors for the ensuing year were chosen. The

rest of the afternoon was given to inspecting the exhibits.

At 8 o'clock in the evening Haines Hall was filled to the limit with delegates to the National Association convention. The exhibits were in the same hall, as the space in the meeting room was somewhat at a premium. The session was opened by an address of welcome by the Hon. James G. Cutler, Mayor of Rochester. The Mayor, in a few words, expressed his pleasure at being able to welcome so many opticians to Rochester, and spoke of what the optical industry has accomplished for that city. He also expressed his satisfaction over the general advance of optometry and of the good work which the optometrists have and are trying to accomplish. John C. Eberhardt, Dayton, O., responded to the Mayor's address.

B. B. Clark, president of the National



B. B. CLARK.  
President American Association of Opticians.

Association, next delivered the annual address, which follows:

PRESIDENT B. B. CLARK'S ADDRESS.

I do not think it necessary to retrospect at this time, as you nearly all are familiar with what has been done and left undone during the past nine years of our organization. I think it must be conceded that these annual gatherings have done much for all of us in many ways. When members from all parts of the United States and Canada and representatives from foreign countries, interested in the same line of work, meet, as we have met, and exchange ideas and express their ideals, it does not need a philosopher to realize the mutual benefit derived.

I notice once in a while—usually in the

optical journals—the question is asked by some one who does not sign his name to the inquiry—what good local and state societies are? "What is the American Association and what are the benefits of affiliation?"

These questions I can answer and there are almost any number here in this room who can give you more reasons than you ever thought of. Many times it costs a lot of money to know many people who are not worth knowing, and the best plans are perfected only after many failures. There is one question I would like to ask of such inquirers. If you are not getting anything out of this association, why are you putting into it?

There are many men who can lead to college, but you cannot make them think. Criticism is helpful many times, but it should be accompanied by suggestion. I have attempted to be as brief as possible and wish only to call your attention to several matters, which, in my opinion, should be given some thought and discussed at this meeting.

The most important matter from all points of view is the regulation of the practice of optometry. It is equally important to the optometrist, jobber, physician and public. Legislation will require a higher standard of qualification, which means education within and without, and such education will have a great tendency to reduce the commercial value of humbug.

While this matter will have to be accomplished by the individual States, I believe that this organization should assist in every way possible. I have the past year appointed a committee on legislation, and I would suggest that all State associations introducing optometry legislation should correspond with that committee, as I believe it can assist them to a great extent. I also believe that by so doing, uniform optometry laws may be placed upon the statute books of the different States. During the past year a "Legal Defense Committee" has been appointed to which I desire to call your attention.

Article II. of the constitution and by-laws of the American Association provides in part, that the purposes of this association shall be: "Safeguarding the material interests of the profession; elevating the standard of optical education; securing the enactment and enforcement of optical legislation and enlightening and directing public opinion in regard to the problem of optometrical science." It is our belief that safeguarding the interests and enlightening and directing public opinion may well be observed in offering direct and indirect aid to legitimate members of our profession who are being persecuted and prosecuted in many states through petty spite and jealousy of incompetents who presume upon a suffix to pose as experts in optometry.

After consultation with our Board of Directors I have appointed a legal defense committee to assist any member of this association, or any member of any society in affiliation, who has been subjected to prosecution while engaged in the legitimate practice of optometry. Those in need of help should communicate with our secre-

## Optical Department.

tary, who will put them in touch with the legal defense committee. All members applying for such aid must have the endorsement of their State society.

The States of Vermont and Connecticut have enacted laws compelling an examination of school children's eyes at frequent periods, and it is an example which other states may well follow. Dr. Geo. Woodruff, in a recent article published in the *North American Review*, says: "Headache, whether it is due to anemia, eye strain, bad ventilation, fatigue, nerve exhaustion, or what not, is, in its origin, distribution and characteristics, the most typical, perhaps, of all school diseases." Grouping information obtained from France, Germany, Great Britain, Sweden, Denmark and Russia, it is apparent that from 40 to 50 per cent. of the school children suffer from this malady; and, further, that it is commonly habitual, usually frontal in location, and that girls are more affected than boys. Moreover, it was noticed that the number of scholars suffering from habitual headache increased (at a maximum rate of six per cent. a year), step by step, and grade by grade, with advancement through school.

How many school children in the United States suffer from or succumb to diseases of the nervous system induced or made worse by school life, and what proportion of such affections encountered in adults originate at this early period, it is impossible to say. We know that, wherever careful and comprehensive investigations have been undertaken among school girls and boys, disorders of the system have been found to be numerous and of a character actually or potentially grave. In one year more than 10 per cent., and in another nearly 20 per cent. of the public school children, examined by health officers in Boston, were thus sent home. In Cleveland, 25 per cent. of the girls and 33 per cent. of the boys, who left the high school during a single year, did so because unable to keep up with their studies by reason of ill health. One writer asserts that, in five cities of the United States, 16,000 children between eight and 14 years of age were taken out of the public schools within one school term, because of ill health.

We know that a large portion of this headache and nervous derangement is caused by eye strain, as we have authentic statistics showing that the percentage of school children having imperfect vision, is enormous. While the duty devolves upon the parent, it is a well known fact that few parents take the trouble to ascertain whether a child's eyes are in a condition to do the work required. In all localities it is possible to call the attention of the Boards of Education to the desirability of ascertaining the condition of the eyes of the school children and suggesting a simple test which can be readily made by the teachers and enable them to at least get the manifest vision.

At our meeting in Minneapolis, last year, several amendments to our by laws were adopted, and the past year, I think, has proved the wisdom of such changes. In

those amendments, however, no provision was made regarding the representative rights of affiliated State societies, and I would suggest such an amendment be adopted at this meeting. Otherwise, I am convinced that the scheme of affiliation should not be changed.

During the past year the officers of our association have endeavored to formulate and carry out plans that would prove beneficial. The Physiological Section has been given the entire responsibility of securing speakers to address this meeting, and it is entitled to considerable credit for the able manner in which it has performed this part of the programme.

It was decided by the Board of Directors, in order to stimulate a maximum interest among exhibitors, to offer them space at this convention free of charge.



SAMUEL S. GRANT.  
President of the Physiological Section.

and the association has not asked for any advertising in a programme nor accepted a donation of any kind. Whether this departure is the wisest course you may judge for yourselves.

Our membership in 1898 was 181. Today it is over 1,500, which is certainly a healthy growth, and should insure an income sufficient for all necessary expenses. I trust this meeting will be pleasant and a profitable one to you, and that our city may have the pleasure of a visit from you many times in the future.

Following President Clark's address, William E. Huston, Kansas City, Mo., secretary of the association, read his report, which was heard with approval by the delegates. The report of the treasurer, J. K. Stebbins, Ashtabula, O., showed that the association was in good financial condition and that the outlook was all that could be asked for. The meeting was then adjourned until this morning.

The first thing on to-day's programme was a visit to the factory of E. Kirstein's Sons Co., on Court St. A large crowd left

the convention hall about 8.30 o'clock and spent over an hour inspecting the different departments.

At 9.30 the opticians again went into regular session. The first part of the session was devoted to business matters. This is to be followed by addresses by the following: Dr. Arthur G. Campbell, Topeka, Kans., "Health Ray Lenses"; E. LeRoy Ryer, New York, "The American Optometrical Academy"; R. M. Lockwood, New York, "The Eye as an Imperfect Optical Instrument"; E. C. Bernheim, Providence, R. I., "Errors in the Business of the Optician"; Ernest Eimer, Muskegon, Mich., "The Physiological Section, Past and Future." These addresses will be listened to with much interest by those present.

At 1 o'clock in the afternoon the opticians will leave the convention hall for a visit to the Bausch & Lomb Optical Co.'s factory. Owing to the immense size of this plant, arrangements have been made to spend the whole afternoon there. The visitors are to be welcomed by officers of the firm, and all departments thrown open for their inspection. After spending an afternoon at the factory, recently, some opticians were heard to say, "I'd like to spend a couple of days in that plant." For those who do not care to visit this establishment friends of the local opticians have provided automobiles, and the visitors will be given a ride about the city and shown the points of interest.

In the evening there will be an eye-testing clinic, conducted by the Physiological Section. Prof. Samuel S. Grant, president of the Section, is demonstrator. There is also a muscle-testing clinic in charge of Librarian of Section C. M. Jenkins, with Dr. John H. Ellis and John C. Eberhardt acting as demonstrators. Both clinics are expected to be largely attended.

A feature of the convention are the exhibits of the different manufacturers. On each side of the front part of the hall the larger booths are erected. The smaller booths are in the center of the hall, back to back. On the left side are: The Eye-Fix Remedy Co., Detroit, Mich., F. H. Eastman in charge; Chas. Fried, New York; Taylor Bros., Rochester, Chas. Taylor in charge; W. & S. Blackinton Co., North Attleboro, Mass., Geo. G. Wheeler and F. H. Carpenter in charge; Warner & Swasey, Cleveland, O., Miss M. E. Cramer in charge; Geneva Optical Co., Geneva and Chicago.

On the right are: The Globe Optical Co., Boston, Mass., with R. E. Thompson, F. M. Drisko, W. W. Slade, Geo. B. Nagel, A. G. Barber and F. A. Barber in charge; Boston Optical Co., Boston, Mass.; Pinkham & Smith, Boston, Mass., William F. Pinkham and Walter G. Wolf in charge; Winchester Optical Co., Horseheads, N. Y., H. C. Jenung and W. I. Slavin in charge (Edward Clarke, Dunkirk, N. Y., also exhibited in this booth); D. V. Brown, Philadelphia, Pa., B. A. Marsden and W. H. Podesta in charge.

In the center and small rooms leading off the hall proper the following exhibited: Rochester Spectacle Co.; E. Klein & Bros., Cincinnati, O.; Standard Optical Co., Geneva, N. Y., H. B. Graves, C. W. Holland and C. E. Quimby in charge, also two demonstrators; Fox Optical Co., Philadelphia, Pa.; R. F. Simmons Co., Attleboro,

Mass.; McIntire, Magee & Brown, Philadelphia, Pa.; Fred Gengelman, New York; B. Mayer, Baltimore, Md.; Hub Optical Case Co., East Dedham, Mass.; Pollack & Michaels, New York; C. P. Goerz, New York; E. Howard Watch Co., Waltham, Mass.; Jos. Fahys & Co., New York; South Bend Watch Co., South Bend, Ind.; Southbridge Spectacle Mfg. Co., Southbridge, Mass., and L. E. Waterman Co., New York.

The booths are prettily decorated, and all made a good showing. Many of the exhibitors had their booths all in shape on last Saturday, but there were several who still had work to do on them yesterday and to-day.

One of the prettiest booths is that of E. Kirstein's Sons Co. This is located in a small room off the rear end of the hall. It was attractively decorated with palms and cut flowers, and on the opening day punch was served by young ladies dressed in white. The booth is in charge of the traveling representatives of the firm, William L. Waldert, A. J. Fairbairn, Benj. Hillsbury, Grant Whittlesey, D. H. Lammerets and Frank Waugh. Off of this booth the Physiological Section has a place fixed up as a testing room. All the latest and most improved instruments and appliances are used here and explained.

The Rochester Optical Society also has a booth. Mr. Someriski, secretary of the society, is in charge of this booth, where information regarding streets, hotels, car lines, etc., may be had. A telephone has also been installed in this booth for the convenience of the visitors.

For to-morrow the programme is as follows:

8:30 TO 9:30 A. M.

Business session of Physiological Section.

9:30 A. M.

Unfinished business.

Address, John C. Eberhardt, Dayton, O., "Monocular Amblyopia Due to Congenital Corneal Asymmetry;" address, Geo. W. McPatrick, M.D., Chicago, "Correction for Myopes;" address, Edward E. Arrington, "Legislation;" address, H. P. Holmes, Des Moines, Ia., "Accommodation;" address, Samuel S. Grant, Montreal, "The Eye in Comparative Anatomy."

1 P. M. SHARP.

Meeting of members and visitors at Convention Hall to start for Eastman Kodak Works, Kodak Park.

At the conclusion of visit to Kodak Park, a beautiful trip has been arranged as follows: Trolley cars leave Kodak Park for Ontario Beach; from Ontario Beach take steamers over Lake Ontario to Sea Breeze; from Sea Breeze take steamers over the famed Irondequoit Bay to Glen Haven; from Glen Haven take trolley cars to Rochester.

The official photograph will be taken at Kodak Park by the Century Camera Co.

EVENING, 8 P. M.

Address, G. M. Jenkins, Richmond, Ind., "Some Diseases Essential for the Optometrist to Recognize;" address, Chalmers Prentice, M.D., Chicago, "The Soul and Its Immortality Proven by Science;" address, Earl J. Brown, M.D., Chicago, "Mechanism of Accommodation," illustrated by stereopticon; address, H. L. DeZeng, Philadelphia, "The Illumination of the Eye by Direct and Oblique Methods;" address, E. Culverhouse, Toronto, Canada, B. O. A., "Things in General."

The Dothan Jewelry Co.'s establishment, Dothan, Ala., was broken into recently and several hundred dollars' worth of jewelry was stolen. Among the loot are several watches which had been left to be repaired. A negro named Oscar McGlendon, who was subsequently arrested accused of the crime, but who afterwards escaped, surrendered part of the plunder.

## Connecticut

Tracy Bergen has left on an extended western trip in the interest of the J. D. Bergen Co., Meriden.

Walter Hubbard, F. P. Wilcox and B. W. Collins were re-elected directors of the Meriden Cutlery Co., Friday.

Chifford W. Leavenworth, treasurer of R. Wallace & Sons Mfg. Co., Wallingford, is confined to his home on Academy St. by illness.

Oscar Anderson, formerly with the Seth Thomas Clock Co., Thomaston, is now in the employ of the New England Watch Co., Waterbury.

W. F. Winslow and G. P. Owen have assigned to the William L. Gilbert Clock Co., Winsted, their patent rights on a handle for swinging arbors.

C. B. Rogers and W. H. Lyon are members of a committee of Meriden's leading citizens appointed to further the project of securing a Federal building at Meriden.

The jewelry stores of Bridgeport are closing at 1 p. m. every Friday, instead of closing evenings at 5 o'clock. The change will continue during the month of August.

C. Burton Rogers, as chairman of a committee of the Danbury Business Men's Association, is conducting a campaign looking to the reduction of the price of gas in Danbury.

Walter Hubbard has been re-elected vice-president of the Meriden Savings Bank, also one of the bank's trustees. Edward Miller and Geo. M. Curtiss were also re-elected trustees.

Eugene M. Boughton died recently at his home in Waltham, Mass. The deceased was formerly a resident of Waterbury, where he had been working for the New England Watch Co.

Frank E. White, formerly in the employ of A. W. Austin, Norwalk, was called to the latter place recently by the death of his aunt, Mrs. Rufus Buttery. Mr. White is now engaged in business in Thomaston.

The employes of Factory "P," International Silver Co., Wallingford, will give a clambake at Ulert Grove, Saturday, Aug. 18. The committee of arrangements consists of J. St. Hilare, P. Bridgett and M. Slater.

John Mari, an employe of R. Wallace & Sons Mfg. Co.'s factory, Wallingford, had the first and second fingers of his left hand badly crushed last week, the members having been caught in some of the machinery at the plant.

When Christian Strobel, of Lake & Strobel, Waterbury, died a short time ago he left no will, and it is now announced that he has no estate and that all his property had been transferred to a brother and maiden sister before death.

The Fire Brigade, Factory "M," International Silver Co., held its annual outing last Saturday at Mansfield's Grove. A bounteous shore dinner was served and several athletic events were held, the successful contestants receiving suitable prizes.

The funeral of Christian Strobel, of the Lake & Strobel Co., Waterbury, took place at his home, 114 N. Willow St., that city, at 2:30 p. m. on Tuesday of last week. The honorary pall bearers were A. M. Dickenson, J. E. Sewell, Robert F. Griggs, J. A.

Hynes, Alfred Grescher, Otto Castrop, C. E. Eagan and Charles Raymond, the last two representing the Waterbury Lodge of Elks. The interment was in Riverside.

C. D. Morris, superintendent of R. Wallace & Sons Mfg. Co.'s factory, Wallingford, was badly shaken up and severely injured last Wednesday evening, when his automobile collided with a trolley car. Both bones of his left hand was broken above the wrist.

The annual outing of the foremen of the Bradley & Hubbard Mfg. Co., Meriden, was held Saturday at Money Island. The party left on an early train for New Haven, and from there sailed to the island. There were several athletic events, and an appetizing shore dinner was served.

Mayor Landers, of New Britain, will be entertained by Mayor Reynolds, New Haven, Saturday, Aug. 4, when a large delegation from the Landers, Frary & Clark Co. will be at Steeplechase Island. A feature of the outing will be a baseball contest between the New Britain Association and the Newfields.

The retail jewelry store of Mrs. A. Jaffe, 457 State St., New Haven, has been attached in a suit brought by Joseph Rofes to recover on a note of \$230 with interest at 5 per cent. Rofes claims that the note has never been paid, and demands \$300 damages. The case was made returnable to the City Court, Monday.

Leopold Simons, New Haven, has the sympathy of his many friends in the trade owing to the recent death of his wife at Sharon Springs, New York. The deceased had been ailing for about a year, and had been taken to Sharon Springs in the hope that the change would benefit her. The interment took place in New York.

The Landers, Frary & Clark Foremen's Club, New Britain, was the guest of President Charles F. Smith, of the company, at Schuetzen Park Saturday afternoon, July 28. The club members occupied a special car leaving the center at 1:07 o'clock. Dinner was served at 1:30, and after the dinner there was a programme of athletic sports.

The silversmiths of Factory "E," International Silver Co., Wallingford, will give an outing at Gehrman's Grove, Saturday, Aug. 11. They will play a game of baseball with the finishers in the sterling department for a purse of \$25. The outing committee is composed of Thomas Mahon, F. A. Morse, Gustave Burke, Emile Lee, Prospect Massicotte and Louis Crump.

John J. Brown, Hannibal, Mo., and his brother, T. A. Brown, Quincy, Ill., have started on a trip to Chicago and New York to buy supplies for the holiday trade.

Roy D. Parker, a watchmaker, of Goshen, N. Y., has invented an automatic typewriter, which relieves the operator of shifting the carriage. With this machine one can write continuously and as rapidly as desired without taking the hands off the keyboard. It is made with a tabulating attachment, and the paper is placed in writing position automatically. Several offers from manufacturers have been received by the inventor, but as yet he has not felt disposed to accept them, and it is possible that a company will be formed to place the machines on the market.

# Mainspring Don'ts

## Simple Hints for Those Who Handle Mainsprings

---

Don't fail to provide yourself with the best mainspring winder that can be obtained. See that the hooks on all arbors of the winders are no longer than the thickness of the thinnest spring, and thus avoid kinking, and therefore unnecessary breaking of mainsprings.

Don't use a mainspring that is too long, because it fills the barrel and prevents that part, or the mainwheel, from making the required number of revolutions, with the consequence that the watch will not run as it should after each winding.

Don't use a mainspring that is too strong, because it will set, increase the percentage of breakage and injure the watch.

Don't use a mainspring that is too wide, and be sure that the tip and brace do not extend beyond the limits of the cover and barrel.

Don't forget that a mainspring should not occupy more than one-third the diameter of the barrel, thus leaving two-thirds to be divided between the arbor and winding space, to enable the watch to run about thirty-six hours.

Don't expect a mainspring to be flat if you put it in the barrel with the fingers. This method usually injures the spring, gives it a cylindrical form, and thereby increases the friction in the barrel.

Don't bend the inner or outer end of the mainspring with flat-nosed pliers, but provide yourself with specially made round-nosed pliers which will give a circular form to these parts, prevent short bends, contract the inner coil, and thus secure a closer fit to the barrel arbor without injuring the spring.

Don't expect other than a properly fitted flat mainspring with rounded edges to produce the least friction in the barrel, allow the greatest amount of power to the train, and give the best results as to time, service, etc.

Don't expect a mainspring to always endure extreme changes in temperature, or electrical disturbances, or straightening at full length, or neglect from lack of cleaning and oiling.

Don't expect a watch that needs cleaning or other repairs to run satisfactorily by merely putting in a new mainspring.

Don't expect a mainspring to plough through too much dirt.

---

## Waltham Watch Company

Waltham, Mass.

# THE HOROLOGICAL REVIEW.



## An Artistic Clock in Goslar.

THE German city of Goslar, so picturesquely situated in the much-visited Hartz Mountains, can boast of a work of art which, from an artistic and technical standpoint, has few equals. We are making no extravagant claim when we assert that Goslar owes its attraction for visitors, in part at least, to the renowned art clock by Wecken, a work which annually causes thousands of tourists from every country of the civilized world to go quite a little out of their way to see it.

The circumstances which led to the construction of this remarkable clock are quite out of the ordinary, and are connected with the fortunes of the former royal house of Hanover. A miniature altar, borne by the sculptor Hermann Wecken in a procession of the citizens in homage to the last king of Hanover, about 40 years ago, caused a great stir; the king summoned him to an audience and Wecken was privileged to present the altar to his sovereign.

In the audience Wecken received the most unstinted praise for his skill from the king, who at the same time expressed a wish that the young artist should produce something still more important, something fit to be placed in the chapel of the palace of Marienburg, (Hanover), and which could be used by the king as a present to his spouse Queen Marie, of Hanover.

Stimulated by the encouragement of his sovereign Wecken set about his task. Five years of intense meditation and untiring toil passed away. From Wecken's workshop issued a work, perfect in idea and execution—a work which has not a great number of equals as a masterpiece of horological science. If we consider the exquisite artistic harmony shown in its construction and its wealth of figured work, we shall undoubtedly place it among the finest specimens of decorative art.

The work was completed June 14, 1866, and Wecken took the necessary steps to convey his creation, on which he had expended all his talent, knowledge and skill, to the king. Ominous clouds now gathered on the political horizon of Germany, and the fratricidal war between Austria and Prussia swept like a storm wind over the country.

The proud house of Guelph lay shattered by the hurricane; the ill-fated king lost his country and his crown, and Wecken was naturally compelled to abandon any hope

that his royal patron would remember the order given five years before. When the king was forced to leave his country, Wecken decided, after much persuasion, to exhibit his artistic clock publicly. The writer is indeed at a loss what to admire most; the conception which gave birth to the whole work, the fine and scrupulously accurate mechanical work, the astonishing perfection of every detail or the consummate feeling for beauty with which the master was inspired when he constructed his world-renowned clock. There is not a sin-

gle superfluous detail, while nothing essential has been omitted; the whole work is characterized by harmony and clearness and bears abundant testimony to the matured skill of its creator. Mr. Wecken is 71 years old and is still hale and hearty.



HERMANN WECKEN.

The structure, consisting of six tiers, rests on a sole or base, with three steps and a pedestal 70 centimeters in height. The first tier is supported by Doric columns, between which an arrow of ebony shows the days and months on a calendar disk. On this disk are also four splendidly carved female figures representing the four seasons and symbolizing the flight of time, the period of blossom and decay, from youth to old age.

The calendar work is automatic and requires no regulating. In niches between the columns stand the four evangelists—

Matthew, Mark, Luke and John with their attributes. On stylobates at the sides of the second tier, which has a graceful openwork balcony, and is constructed in the Ionian style, are Elijah with his mantle of camel's hair and Moses with the tables of the law. In the same tier, above the date hand, is an altar in the Greco-Roman style with figures representing the Annunciation and the birth of Christ. This altar consists of two parts and has a contrivance whereby on the birthday of any member of the former royal house of Hanover the portrait of the member is made to appear in front of the upper part of the altar with a card of congratulation in front of the lower part. Both remain visible for 24 hours and then disappear. Four armed foot-soldiers protect the law given by the prince.

The third tier, built in the Corinthian style, displays the Crucifixion; the whole work, in fact, bears a marked Christian character. The four sacred persons who were present at the death of Christ stand between the pillars to the right and left of the scene of Crucifixion. Each stands in an arched niche, inlaid with ebony. The figures themselves are made of palm-wood, making an effective contrast with the ebony.

An angel with a trumpet stands at each end of the front of the fourth tier; the latter is constructed in the Corintho-Roman style and is smaller than the tiers below. Christ, His hands stretched out in blessing, stands in a portal in the middle; on each side of Him is a folding door. The Apostles are also seen in this tier.

The fifth tier, in the Graeco-Roman style, is still smaller than the fourth. It is formed by eight double pilasters placed octagonally and forming the foundation of an octagonal socle with six steps. Between the two middle pilasters is a dial showing the mean time. Two angels, one on each side, strike the hours and quarters on bells. Sixteen Greek columns supporting a dome with a cross constitute the sixth tier and worthily complete the structure.

The striking mechanism is set in motion at the end of every hour. First, the angels at the top raise their hammers to strike the bells. The hour bells are a tone lower than the quarter bells. The Crucifixion begins at the last stroke of the hour. The centurion standing by the cross raises his staff as a signal; then the soldiers standing on ladders behind the cross begin to strike the nails through Christ's hands. The bell for

# Wise Dealers Set Store by the ELGIN



The wide-awake dealer knows the value of a good stock of Elgin Watches. He knows that they are a good criterion by which to have the public judge his store.

He knows that Elgin customers are satisfied customers, and that satisfied customers are the very foundation of successful business. The

## ELGIN WATCH

is the World's Standard Timekeeper

See Jobbers' List for prices or write the Company.

Every dealer is invited to send for the Elgin Art Booklet, "Timemakers and Timekeepers," illustrating the history and development of the watch.

**ELGIN NATIONAL WATCH COMPANY,**

Factories, Elgin, Ill., U. S. A.

General Offices, 131 Wabash Ave., Chicago.

New York Office, 11 John Street.

San Francisco Office, 206 Kearny St.



prayer strikes with muffled tones. Then one of the soldiers standing below the cross, at an order from the centurion, gives the sponge to Christ, and another immediately afterward pierces his side with a spear.

The Crucifixion takes place on rocky ground; in the background are seen the pinnacles of the Holy City. The two crucified malefactors are also shown, one on

from the right folding door at the side of the Saviour, draw near to Him with raised heads, receive His blessing and disappear through the door on the left. At the moment the last Apostle vanishes, the same mysterious sound is again heard, and the Apostles reappear as if magic in their niches.

During the Benediction the angels on the fourth tier raise their trumpets and play

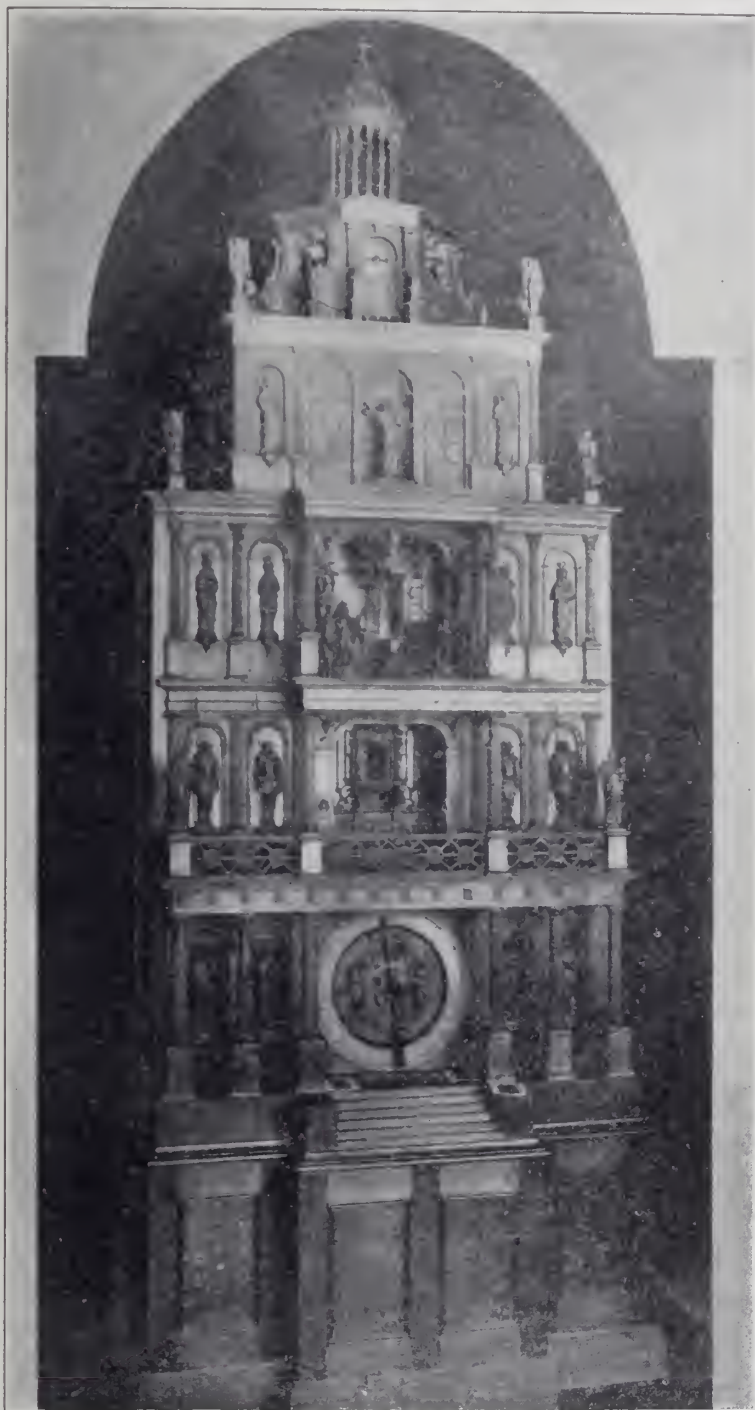

AN ARTISTIC CLOCK AT GOSLAR, GERMANY.

each side of the Saviour. After the Crucifixion a set of bells in the temple-shaped upper tier plays the hymn, "Nun kommt der Heiden Heiland." Then the hour strikes again; at the last stroke a momentary and startling sound is heard, during which the Apostles on the fourth tier disappear into the interior, to emerge, one by one,

in thirds the hymn, "Lobt Gott Ihr Christen allzugleich." Deep silence then reigns again, broken only by the monotonous tick-tack of the pendulum.

The store of Edward Vail & Co., Wichita, Kans., has been remodeled and equipped with new fixtures.

### Vibration of an Electric Plant at Greenwich Interferes with Work at Famous Observatory.

IN a syndicated letter from London to several leading American newspapers, Percival Phillips says that several thousand unimportant individuals living near Greenwich threaten to upset navigation and clocks throughout the world. They have demanded, as necessary, the erection of an enormous electric generating station near the famous observatory. The vibrations resulting from this power plant are already putting the astronomer's calculations out of gear, and conflict among the world's clocks is threatened.

Inasmuch as railways are dependent on Greenwich for their running time, the situation is regarded by scientists as exceedingly serious. The sleepy House of Lords is taking more than passing interest in the controversy between the Astronomer Royal and the London County Council, which is erecting the power plant for the benefit of the residents of Greenwich town. As Lord Ellenborough points out, the completion of the power plant means that the site of the observatory must be changed. If in obedience to the County Council the point of reference is changed, Great Britain may have remonstrances and possible demands for compensation from all parts of the world.

Lord Kelvin, whose reputation as a scientist is well known through America, emphasizes the danger of changing the observatory site, and, in consequence of his warning, the Government has promised that all the astronomers in Great Britain shall look into the matter, and the opinion of the Washington observatory may also be asked.

Lord Ellenborough voiced the sentiment of the public when he sarcastically observed, in the House of Lords this week, that the next thing the County Council will do will be to order the equator to leave the tropics, and not to take more than its fair share of sunshine.

### Clock Making in Nagoya, Japan.

A DISPATCH from Yokohama, Japan, states that the clock-making industry in Nagoya, for which that city has obtained a great reputation in Japan, is at present in a very prosperous condition, manufacturers having more orders on hand than can be executed promptly.

The total number of clocks turned out in Nagoya during March last was 32,385, of which 21,594 were hanging clocks, and the rest standing clocks. The quality of the timepieces made in Nagoya is gradually improving in consequence of the enforcement of the inspection rules, and at present the number of clocks rejected by inspection is not more than eight per thousand. By the increase in demand and the advance of the copper market, the price of timepieces has advanced to an average of Y 29 per dozen. —*Japan Chronicle*.

F. M. Watts, Kirksville, Mo., accidentally took an overdose of chloral hydrate, one night recently. He was critically ill, but is now convalescent.

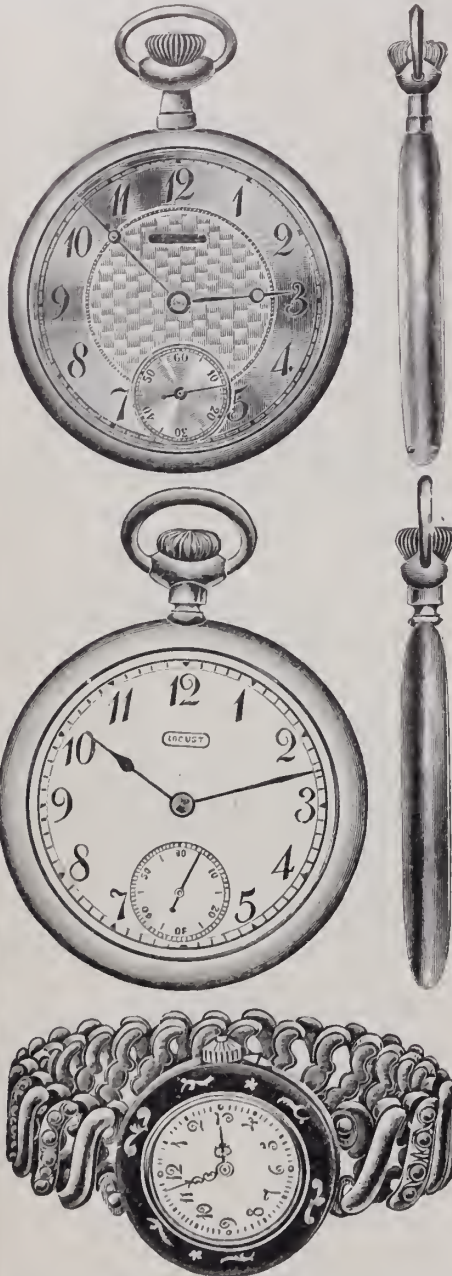

# THREE WINNERS

## The Lancet

15 and 17 jewel, adjusted, cased in 25-year Gold Filled hinge. The best and most attractive watch on the market.



## The Locust

7 jewel, lever. Cased in 20-year Gold Filled. Screw back and bezel.



## The Carmen Watch Bracelet

Needs no comment.

ASK YOUR JOBBER FOR THEM OR WRITE DIRECT TO

HIPP. DIDISHEIM & BRO., 49 Maiden Lane, NEW YORK

CHICAGO OFFICE, Columbus Building

## The New Continental Watch Co.'s Movements.

0, 12 and 16 Size. 7 to 21 Jewels. All Bridge Model and Pendant Set.



Fitting all American cases without any change, interchangeable pendant set, have steel scape wheels, exposed pallets, double roller, Arabic or Roman dials, with and without marginal figures. CONTINENTAL WATCH CO. on bridges, C. W. CO. on dials except otherwise ordered. Special name or nameless movements require four months' time for delivery. Packed in glass show box inside paper box. No expense has been spared to make these movements the best on the market for the money. Every movement absolutely guaranteed. A full line of finished material constantly on hand.

For Sale by all Jobbers.

JULES RACINE & CO., Exclusive Importers,

103 State St., Chicago.

37 MAIDEN LANE, NEW YORK.

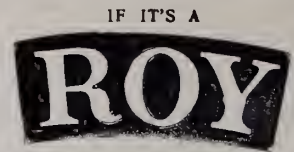

TRADE MARK  
IT'S STANDARD



O Size Bassine Engraved Cases, made from assayed Gold, quality as stamped.

## ROY WATCH CASE COMPANY,



21-23 Maiden Lane, NEW YORK.

SAN FRANCISCO. LONDON, ENG.

**House Clocks with Simple Electrical Winding Work, for Operating the Going and Striking Trains Simultaneously.**

(Translated expressly for THE JEWELERS' CIRCULAR-WEEKLY from the Deutsche Uhrmacher Zeitung.)

THE special feature of this electrical winding arrangement is that a single electromagnet can easily raise two or more weight levers, each of which when falling actuates its own work. A main work or master clock can, for instance, be placed by this method between two common work-plates by the side of a train, and the latter can then attend to the closing of the current for an entire series of secondary clocks. Moreover, in the case of clocks with striking work, both the going and striking trains can be wound up, if desired, by a single electromagnet, it being quite immaterial whether both levers descend uniformly or not.

Whenever a circuit is closed, which oc-

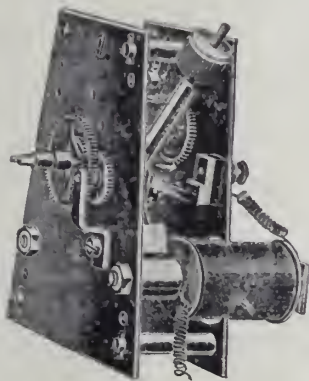

FIG. 1.

curs once every five or 10 minutes in a going train, the levers are all simply made to fly up to their highest point, though one lever may have fallen a considerable distance, another only slightly and a third not at all. If the lever in the striking work is so arranged that one fall is enough for the maximum number of subsequent strikes (12), then without any further operation at the next closing of the circuit, which follows every hour or half-hour stroke, the lever will be again raised to its highest position.

Fig. 1 shows the exterior of a regular movement provided with this electrical winding contrivance. It differs, as will be seen, from an ordinary spring regulator movement only in having two coils of an electromagnet (the right hand coil is shown in the figure), fixed in the sides at the bottom and the weight lever rising obliquely in the position of impulse.

As it will be more instructive to study a work of this kind with two weight levers, we give an illustration of one of the latter in Fig. 2, and in order to show the portions of the electrical winding mechanism between the work plates, the front plate is represented as for the most part broken open. The mechanism operates both the going and the striking train.

The arrangement is very simple. *u* and *s* are the two poles of the electromagnet, between which the armature, *a*, turns round on its axis, *c*. To the left extremity of the armature a winding arm, *f*, made of strong wire, and bent back at *k*, is fixed, the horizontal end (*k*) of which throws up the

two levers, *i* and *j*, when contact is made, in consequence of which the armature, *a*, turns round its axis to the right.

Fixed to the axis, *c*, of the armature, *a*, is also a forked switch arm, *b*, which not only closes, but immediately afterward breaks the circuit in a way presently to be described. At present we will consider the two weight levers a little more closely. As will be seen from Fig. 2, the lever, *i*, belongs to the going train. Connected in the usual way with the center wheel, *f*, is a fine-toothed ratchet, *g'*, with which the pawl, *m*, of the lever, *i*, is geared in such a manner that the clockwork is set free when the lever flies up, but catches when the latter, driving the work, descends.

In addition, a maintaining work is placed behind the wheel, *g'*, to supply the motive power during the short space of time that elapses whenever the lever, *i*, flies up. The lever, *j*, of the striking work is arranged in the same manner. Here, also, a maintaining work is placed behind the ratchet, *h'*, fixed on the arbor of the extra wheel and driven by the pawl, *w*, in the direction of the movement. As the jerk when the armature oscillates is somewhat violent, and the danger consequently arises that the latter may again fly back in the opposite direction (in which case another undesired closing of the circuit would take place), a safe and at the same time simple stop contrivance has been devised for the armature.

A bent lever, *r r'*, turning round *r''*, is disposed in such a manner that its shorter arm, *r*, when in a position of rest, *i. e.*, as soon as the armature swings to the right at the closing of the circuit, is in contact with the stop, *t*, in the position shown by the dots. In this position it locks the right end of the armature, *a*, and both levers are now raised. When one of them descends, it strikes on one of the pins, *r''* or *r'''*, in the longer arm, *r'*, of the locking lever (the lever *i* on *r''*, the lever *j* on *r'''*) and pushes this long arm, *r'*, downward. The result is that the short arm, *r*, again releases the armature and when the latter comes into the position shown in Fig. 2 the circuit is again closed.

As already stated, the circuit is closed as well as broken by the forked switch-lever, *b*, fixed to the axis, *c*, of the armature and with the aid of a star connection. The latter is a double wheel, being composed of two four-armed crosses or stars. The front star wheel, *u*, with the pointed teeth, serves only for conducting—on, as, when the armature turns to the left, the pin, *y*, of the forked switch lever engages in the lower tooth of the star wheel, turning the latter to the left; when the armature turns to the right and the lever flies upwards, the pin, *x*, again makes the star wheel, *u*, turn a certain amount—in all about 90 deg.—in the same direction.

The star wheel, *v*, at the back, is used as a contact disk. It is in constant electrical connection with the contact spring, *p*, which touches it behind, and is for most of the time insulated from the second contact spring, *q*. For, at the extremity of the latter are two pins, the longer of which, *d*, falling between the teeth of the star wheel, *v*, is made of insulating material, while the other pin, *e*, not visible in the drawing, as it lies below the center of the contact disk,

*v* (in the direction *e*), is made of metal. If the contact disk, *v*, is in such a position that the insulated pin, *d*, lies on one of the four flat arms of the star wheel, the current is interrupted, since the contact pin at *e*, being shorter, cannot touch the contact disk.

But as the armature swings slowly back to the left under the action of the weight lever, the pin, *p*, of the switch lever, *b*, makes the star wheel, *u*, also turn to the left, and the insulated pin, *d*, finally falls away from the arm of the contact disk, *v*. Then, pressed by the spring, *q*, it falls between the teeth lying between two adjacent star wheel arms till its descent is arrested by the metal pin, *e*, striking the contact disk.

At this moment the circuit is closed, the armature is attracted by the electromagnet,

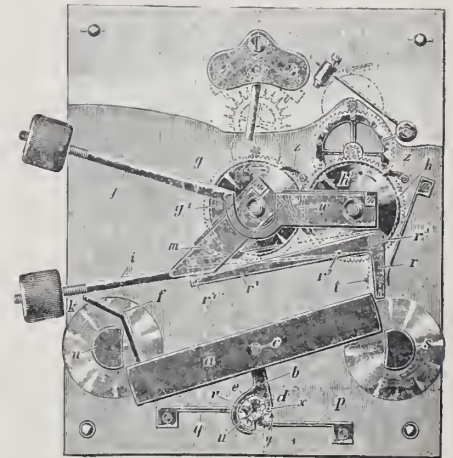

FIG. 2.

and swings vigorously to the right, throwing the weight lever upwards. At the same time the pin, *x*, as already stated, causes the two star wheels, *u* and *v*, to turn further, and the metallic pin, *e*, slides along the contact disk, *v*, so that the point of contact is pushed aside and the closing point separated from the opening point. This increases the certainty of the action.

Immediately before the next star wheel arm meets the insulated pin, *d*, the blunt end of the spring, *q*, slides into the cavity of the contact disk; consequently the circuit, without being broken, is no longer closed at the point of the contact pin, but around the conical surface just above it. If the star wheel turns a little more, the cross arm will press upon the slope of the insulated pin, *d*, and push the latter against the surface of the arm; the contact pin, *e*, will then be raised suddenly and almost perpendicularly out of the cavity and the current will be interrupted.

The circuit, therefore, is not broken at the point of the contact pin; consequently the injurious effects of very high tension (burning of the point of contact by the spark) are avoided. It is also an advantage that the circuit is closed suddenly and with a certain amount of force by the falling of the insulated pin under the pressure of the spring, *q*, and afterwards opened again with equal rapidity.

W. G. Sheppard has moved his stock of jewelry from Cambridge, Nebr., to Indianola, Nebr.



# American Watch Case Co.,

Manufacturers of Fine Gold Cases,

9-11-13 Maiden Lane,

New York.



We will send Free upon request this Case Opener, made from Fine Tool Steel, highly tempered.

1906 Catalogue Now Ready

## Sessions Clocks

Superior finish. Reasonable prices.

Have you seen our

**New and Exclusive Designs**  
in Mantel and Hanging Clocks?

Write for Catalog and supplement.

### The Sessions Clock Co.

Main Office and Factories,  
Forestville, Connecticut, U. S. A.

New York Salesrooms,  
37 Maiden Lane.



## WHOLESALE

# DUEBER-HAMPDEN COMPLETE WATCHES

The conceded friend makers for the retail dealer. We are certain that we can help you make customers if you will write us for prices on Chains, Rings and all kinds of High-Grade Jewelry.



## WM. C. PENFOLD CO.

WHOLESALE JEWELERS

AND AGENTS FOR DUEBER-HAMPDEN WATCHES

818-820 Chestnut St., Philadelphia, Pa.

## THE COMMERCIAL MEANING OF "SERVICE"

**T**HE WORD "Service" is being used very widely in business. It means more than the mere exchanging of goods for money; it applies to certain convenient methods of conducting business, which add to the customer's satisfaction without necessarily increasing the cost to him. Good products plus good service mean the highest efficiency. As applied to watches, such efficiency is here afforded.

CHICAGO  
103 STATE ST.

**J. W. FORSINGER,**  
LEADING AMERICAN WATCHES AND MOVEMENTS

NEW YORK  
2 MAIDEN LANE



# ZENITH

## MOVEMENTS

Give the

**RIGHT TIME  
EVERY TIME  
For a LIFE TIME**

**Grand Prize, Paris Exposition, 1900**

Made in O size, 12 size, 16 size, all grades  
Hunting or Open Face, Pendant Set

INTRODUCED FOR THE FIRST TIME IN AMERICA, THOUGH ONE OF  
THE BEST KNOWN WATCHES IN EUROPE FOR GENERATIONS

Manufactured by

**GEORGES FAVRE-JACOT & CO., Locle, Switzerland!**

HIPP. DIDISHEIM & BRO., Sole Agents, { 49 MAIDEN LANE, NEW YORK.  
COLUMBUS BUILDING, CHICAGO.

**Be Sure To Ship Us L's Make**

**L**  
GOODS

Ever since we are in a position to supply  
Watches and Movements

FROM THE

**LANGENDORF WATCH CO.**

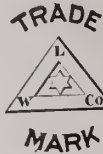

We read in our daily mail that the customers ask us specially to ship them L's Make only.

**W**HAT advantage is there in L's Make prompting our customers to add above request to their orders?

**C**AN IT BE POSSIBLE that so large a number of them have already noticed increased profits and great satisfaction when handling this new line?

This week it is the "NAMTOC" Watch. Ask for a sample. It is just what your customers want, a thin model Gent's Gilt Metal open face Watch. Remember it is L's MAKE.

SOLE AGENTS FOR UNITED STATES.

**BYRON L. STRASBURGER & CO.,**  
17 Maiden Lane, New York, N. Y.

**MOST COMPACT**

AND THINNEST  
DUST-PROOF

**OPEN FACE  
GOLD CASE**

MADE IN THE WORLD  
FOR  
AMERICAN MOVEMENTS.

Made in all shapes, engine turned,  
engraved or plain.



Colby Patent, April 24, 1894.

**DUBOIS WATCH  
CASE CO.**

21 Maiden Lane, New York.

**46 out of 99 PRIZES**

were awarded to

**PATEK, PHILIPPE & CO.**

In the Timing Contest of the Astronomical Observatory in Geneva, for the year 1905, comprising: The only First Unique Prize for Best Average Running; 2 First Prizes out of 3; 5 Second Prizes out of 10; 8 Third Prizes out of 18; 9 Fourth Prizes out of 24; 10 Honorable Mentions out of 23; 11 Simple Mentions out of 21. 11 Manufacturers participated.

68 NASSAU ST., NEW YORK.

GENEVA, SWITZERLAND.

**JULES JÜRGENSEN**  
Watches and Chronometers

PARIS "THE GRAND PRIX"—1900

**SOLE**  
RUDOLPH & SNEDEKER,  
65 Nassau St., New York  
**AGENTS**

**"Perfect Yourself"**

in ENGRAVING and EXPERT WATCH WORK.  
Take a Post-Graduate Course.

**RIES & ARMSTRONG, Macon, Ga.**

**WATCH  
REPAIRS**

FOR THE TRADE ONLY  
**WE BEAT THEM ALL!**

in Prices and Quick Service

**MAEBERT & REISS**

71 and 73 Nassau Street - NEW YORK

WATCHES OF PRECISION.

**Mathey Bros., Mathez & Co.**

Manufacturers and Importers of

Superior, Plain and Complicated Watches.

Sole Agents for

**CHAS. H. MEYLAN.**

SMALL WATCHES A SPECIALTY.

WATCHES DEMAGNETIZED.



12 SIZE MOVEMENTS.

Brassus, Switzerland

21 MAIDEN LANE, NEW YORK.



12 SIZE SPLITS.

# Trenton Watches are Unequaled

For Beauty of Design, Perfection of Finish and Reliability Combined with Moderate Price



No. 100. Bridge Model, O Size, 7 Jewel, Hunting and Open-Face, Pendant Setting.

**JOBBERS SELL TRENTONS**



No. 320. Bridge Model, 13 Size, 7 Jewel, Hunting and Open-Face, Pendant Setting.

**PRICE LIST on APPLICATION**



No. 140. Bridge Model, 16 Size, 15 Jewel, Hunting and Open-Face, Pendant Setting.

A SAMPLE LINE is convincing. They are Pendant Setting in all Sizes, fitting Regular Pendant Setting Cases, Decorated Dials, and Louis XV Hands.

A Neat Sign or Advertising Booklet for the Asking

Manufactured and Guaranteed by the  
**TRENTON WATCH CO.**  
Trenton, N. J.

**JAS. C. HOE'S SONS**  
10 Liberty Place  
Near Maiden Lane  
NEW YORK

Manufacturers of High Grade Wall Show Cases and Jewelers' Fixtures

INTERIOR REFITTING of STORES and OFFICES A SPECIALTY

Write for Estimates  
Finest references given if desired

Established 1820

**LEARN WATCHMAKING AT HOME**  
by THE De SELMS CHART SYSTEM, copyrighted and patented. The most simple, practical and up to the minute method of learning.  
Saves you time and money while learning and puts you in a position to more than double your income.  
50 million timepieces to be repaired. Accurate time is a necessity in the business world. When time is money the watchmaker gets his share of profit. Positions for graduates. Booklet free. Write to-day.  
**The De SELMS WATCH SCHOOL,**  
109 Perry Street, ATTICA, INDIANA.

**Expert WATCH and Chronometer REPAIRING FOR THE TRADE.**  
When others fail you we guarantee satisfaction. A trial will convince. Prices very reasonable.  
List will be sent on request.  
**G. OHAN,** 37-39 Maiden Lane, Lorsch Bldg., Room 27. NEW YORK.

**ROBERT DULK,**  
DESIGNER,  
Etching in Gold and Silver,  
Telephone, 3960 Chelsea.  
No. 70 5th Avenue, NEW YORK

MAKERS OF  
**Tower and Street Clocks**  
For particulars write us, mentioning The Jewelers' Circular-Weekly.  
**E. HOWARD CLOCK CO.,**  
EST. 1842. BOSTON, MASS., U. S. A.

**THE MINERVA**  
GOLD FILLED  
**Watch Bracelet**  
BEST IN THE MARKET

Also Solid Gold Watch Bracelets, plain or set with Diamonds and Pearls.  
Full line of Swiss Watches in all sizes and qualities, also novelties in watches a specialty. Write us for information, etc.  
**KLIPPER BROS.**  
59 Maiden Lane New York

**Learn Watchmaking**  
Refined, profitable labor. Competent men always in demand. We teach it thoroughly in as many months as it formerly took years. Does away with tedious apprenticeship. Money earned while studying. Positions secured. Easy terms. Send for catalogue. Address  
**St. Louis Watchmaking School, St. Louis, Mo.**

ESTABLISHED 1872. **E. HAHN & CO.,** CABLE ADDRESS: "AQUAMARINE," LONDON.  
33, HATTON GARDEN, 33 LONDON.

Precious Stones, Semi-Precious Stones, Ceylon Fancy Stones, Pearls, Corals, Opals and All Novelties in Stones suitable for	I. All Jewelry and Export Purposes. II. Art Metal Work, Church Work. III. Mechanical Purposes. IV. Collectors, Educational purposes, Museums.
--	--

**FAIRCHILD & COMPANY**  
225 to 233 Fourth Ave. NEW YORK CITY.

Manufacturers of GOLD PENS, PENCILS, PENHOLDERS, SEGAR CUTTERS, SPECIALTIES, PENCILS SET WITH JEWELS.

Style, quality and workmanship acknowledged the very best.

**LEROY W FAIRCHILD.**  
GOLD PENS.



That this department shall prove mutually beneficial to our readers, it is desirable that the members of the trade generally communicate with THE JEWELERS' CIRCULAR-WEEKLY regarding any advantageous device or plan which they are utilizing in connection with their business.

### Why Organization is Beneficial to the Retail Jeweler.

(Extract from the speech of PRESIDENT A. C. GRAUL, before the Pennsylvania Retail Jewelers' Association.)

TO begin with, there is too little goodwill, too little friendship, between members of the craft. If a jeweler has occasion to refer to other jewelers, particularly near neighbors, he will either directly or indirectly, make the others appear as nearly the sum of human depravity and dishonesty as possible. The fact is that the jeweler's apprentice must always be of good character and have recommendation before he can get a position in the trade. From these selected youths eventually come the retail jewelers, the men who do all that they could to fall out with each other. They all need and require a high degree of technical knowledge and skill, and they are systematically trained to be affable and courteous, but they speak ill of one another, and this fact is largely responsible for many of the evils which they suffer.

A cohesive and comprehensive organization will go far toward removing this primary evil. One thing to be early thought of in studying the situation is the condition of our workmen. In no trade requiring character, intelligence and skill of the standard necessary for our workmen, are the wages as low as they average for the watchmaker and jeweler. It takes longer than most trades to become competent, and the conditions of the work early undermine or destroy such essential qualities as eyesight, nerve poise and digestion. Then, why are they so poorly paid? In my judgment it is because the master jewelers are so much at enmity with each other that they will accept work at too low prices. Thus the pace is set and the neighbor becoming "rattled," goes him one better or worse.

It is a fact that almost without exception the employer who pays a workman \$20 a week takes a goodly portion of the wages out of the profits of his sales, which for other causes have already been sadly curtailed. The keen struggle for existence makes the jeweler prone to selfishness, makes him begrudge his neighbors even the appearance of prosperity, and he therefore seeks to belittle them in the eyes of the public as much as possible.

Retailing jobbers are truly a "thorn in the side" of the legitimate retailer, doing him the most unfair and irreparable injury. Do

not retailers themselves break the soil and sow seed from which the retailing jobber reaps his harvest? How many of those present have not piloted a customer to where a big selection may be had, telling the customer that his jobbers accommodate him by permitting him to take his customers there. (One gentleman indicates by a gesture that he is not guilty.)

Educate your customers, your neighbors, your friends and your relatives that there is only one place to buy jewelry, and that place is the retail jewelry store—your store. It goes without saying that jewelers do not take their customers to a department store for jewelry. Many jewelers will go there for a dishpan if it can be had 10 cents cheaper in price and 10 cents lower in quality than in the local and legitimate hardware store. Likewise they go to the department store for a carpet, a pair of shoes, a necktie or a suit of clothes. Thus the department store's delivery wagon comes to the jeweler's door and unloads his purchases. The jeweler has set the pace. Neighbors, friends and customers reason that if the store is good for Mr. Goldcase it will also be good for them.

You can cry yourself hoarse against the quality of department store goods and it will be of no avail. You have already spoken disparagingly of the other jewelers and they have paid you the same compliment. In short, you have destroyed your influence. The mail order house, the fake shops, the false quality stamps, can be overcome if the craft are friendly before the public and united before the jobbers and manufacturers.

Taking up the question of favoritism by manufacturers, Mr. Graul attacked the methods of the so-called "Big Four" companies in certain specific instances, and ended by reading from a recent speech in Congress by Representative Rainey on the same subject, which was published in THE CIRCULAR-WEEKLY a few weeks ago.

Advertising writing looks as easy to the amateur as roller skates do to the small boy—both get a good many bumps before they arrive.

A "quarter horse," like an advertisement in a medium of fake circulation, may start all right, but loses in the long finish.

A standing advertisement is like your wife's last year's dress—people know it is the same old dress, but they're not interested.—*White's Sayings.*

### How Organization May Prevent Unfair Competition.

(HERMAN C. WATTS' address at the recent convention of Retail Jewelers' Association of Illinois.)

THE past few months have witnessed a widespread movement in the organization of the retail jewelry trade. The one direct cause of this growing demand for organization is unfair competition, which has originated with the mail order houses and department stores. Their cut-price methods of selling watches and kindred lines, more especially watches, they use to attract trade for other lines, on which they can make a liberal profit. The question arises—can those manufacturers, who maintain a fixed retail selling price of watches or kindred lines, lose anything by the organization of the retail jewelers? Certainly not; for mail order and department houses cannot sell even standard makes of watches except at cut prices, and anything that helps the legitimate retail jeweler's progress is a direct benefit to these manufacturers.

However, since the organization of the various State associations, there has arisen some opposition, which is actively engaged in trying to hamper the progress of organization. Possibly some interests have been successful thus far in preventing the conventions from adopting resolutions on the all-important issue, the adoption and the universal maintenance of a retail price of watches. Deprive the mail order houses and department stores of the right to cut prices on standard watches and also kindred lines (as the average purchaser of jewelers' wares, except watches, cannot tell whether prices are high or low, for he cannot judge the quality)—deprive these concerns of the right to undersell the legitimate jeweler on the standard makes of watches, and the public will take it for granted that if they undersell the jeweler on other goods in his line, these goods are of inferior quality.

The opposition to maintaining prices cannot prevent the jewelers from organizing for trade protection, neither have they behind the movement the strength to resist the demands of such a body; therefore, brother jewelers, our strength lies in the adoption and also the maintenance of the retail price of watches.

R. Grimes, Dows, Ia., has shipped his stock to Waterloo, Ia., where he engages in business.



## Storekeeping Department.

### Side Lines For Jewelers.

(By N. NIELSON, Harlan, Ia., Vice-President Iowa Retail Jewelers' Association, before the latter's recent convention in Des Moines, Ia.)

(Continued from issue of July 11.)

**S**TATUARY sells well when first put in stock, but usually does not move very fast after having been on display for some time, for the very good reason that your customers get to notice certain pieces and will remember them, and after that you will find it hard to sell them. This, of course, applies mainly to the smaller places and not to the cities.

Another line that you find in the jewelry stores is the piano and organ line, and I at one time handled quite an extensive line of those goods, but all I have to say in regard to this line is that, when any one of the brethren feels tempted to put in a stock, think twice before acting and then "don't." I made my line pay a profit while I carried the goods, but I will state that as far as my experience went I do not consider that the instrument trade has come down to a basis where a self-respecting man can handle them and keep his good opinion of some of his fellow men, and especially some of those engaged in the instrument trade, but I will not go into hair-splitting on this point here, and I will only say that when the manufacturers stop furnishing instruments to the consignment man, sell to legitimate dealers only and establish a fixed retail price, not until then will I recommend the line to the retail jeweler as a side line.

Going back to what I consider the more important lines, I will say that I found cameras to be a most excellent line. Buy only standard goods and you are protected on the retail prices, which assures you a fair profit on every sale made, but first of all make it a point to understand photography so that you can give your customers any information they may want, and also so you will know just what to buy for your stock. You positively cannot make it a winner unless you post yourself and also your salesman if you employ such. If this advice is taken to heart I will recommend this line as one of the most important ones and one that ought to receive first consideration, if the field is fairly open, as far as competition is concerned.

Phonographs are also on the list for first consideration, if they are not sold too extensively by other concerns in your city. It is a splendid line in some ways and in other ways it is not very desirable, for we should always bear in mind that our side lines ought not to interfere with our regular jewelry line, for this should always be our first consideration. We are jewelers first and last, every other line is a side issue, and your customers in the jewelry line will not always appreciate hearing "Hiawatha," "Bedelia," "My Loving Henry," or any other old thing while they are deciding on some valuable purchase on a busy day. Such scenes cannot be avoided with phonographs as a side line, although if you were to ask me if I would consider it a good side line to add I would answer

"yes," but I would not advise any one to handle it unless a fairly extensive stock was carried.

Small musical instruments are always good as a side line because it takes a small city to support an exclusive music store, and hence the jeweler's opportunity. This line, if properly pushed, ought to bring many a dollar to the enterprising jeweler making an effort to push them.

Sewing machines are good. Carry not less than 10, and if possible up to 20 machines of all grades, from the cheapest to the very best. Do not employ canvassers. Always have on the floor a couple of the very cheapest machines at \$10 to \$12, but push good machines as much as possible; at the same time let people know that you have cheap machines if they want them. Do not try to make but a fair profit only on any machine, and you will be surprised to see how many machines you can sell and what a help the extra profit will be to you to help pay expense. I will not say anything in regard to stationery, because I have never had any experience, but I will say that I have seen jewelers sell it with very much success.

The lines as outlined cover practically the entire list that I would recommend as side lines for jewelers. There may be others, but in my estimation I would let the other stores sell them. To the jeweler that now has the side lines I will not try to offer a great many suggestions for, as stated before, he may have had a great deal more experience than I have, and to the city jeweler I will say that I do not propose to offer any suggestions as to what he ought to do and ought not to do in regard to side lines, but I will say this to any one contemplating side lines or who is now selling them—do not add a single line until you are ready for it, then put in a good stock and carry it right, master one line thoroughly before adding another. And treat every successive line in that manner. This I consider good advice for any jeweler.

Now, here I will mention a thing or two that may not come in under my subject in one sense, while in another way it does. This applies to the jewelry trade in general all over the country, and this is advertising. None of your side lines will be a complete success unless they are advertised and advertised right. We will assume that you are all good advertisers for your regular lines of jewelry, but do not stop at that. Advertise your side lines as soon as you have them properly displayed, and first, last and all the time tell the people what you have to sell, give descriptions of your goods and prices of them. Always give prices, for prices are what the public is interested in. You do not need to cut prices, unless you wish to in order to get the trade to come your way, and you do not need to cut your competitor's prices on anything which he might happen to advertise. Take something else and advertise it, word your ads. so that the public will be interested, and then quote the right price. Follow this advice and the results in trade which it will bring to you will surprise you.

Another very essential thing in advertising your business in general is a good

supply of cuts to illustrate the goods advertised. The cuts take up extra space, but 10 people will see your ads. with cuts where only one would notice them without cuts, so you will be the gainer.

By following my advice any jeweler will more than hold his own in competition with mail order houses and department stores. Judicious advertising, backed by the goods and the right salesmen behind the counter makes failure impossible, be it selling side lines or any other lines. By following the plan outlined I have built up my business to what it is now and practically driven the competition of the mail order houses in my lines out of existence in my territory, so I feel that I have some rights to claim what I do and also to recommend it for the jewelry trade.

As I am only allowed a few minutes for the reading of this paper I will have to be brief, but I will add the following before finishing. Advertise everything in season, and in side lines push your cameras in the Summer, for they are the sellers when everything else goes slowly. Put your efforts on the phonographs in the Winter time, sewing machines in the Spring and Fall, etc. Push goods all the time, but push harder in the regular season.

I will stop now or I do not know when I will get through, for advertising is one of my hobbies, since it is one of the main things that has made my success possible.

[THE END.]

### More About Stock Registration.

**W**HILE recently looking over some back numbers of THE CIRCULAR-WEEKLY, I was interested in one concern's system of registering and pricing stock, described in the issue of Jan. 3, 1906.

This system is all right as far as it goes, but an improvement may be made by adding to the register a place for entering the name of the customer who purchases the article, and the date sold, on the same line as the original entry. The record will then show, after posting each day's sales, the stock on hand for the following day.

At the end of the year preparatory to inventory, the entries still unposted should be entered in numerical order in a new stock book, and stock should be taken in the ordinary manner by the clerks, listing the articles on a separate sheet, according to the tag and description. These sheets can be assembled and checked against the stock book by the bookkeeper.

It will depend upon the class of business which the jewelry house is doing, as to whether or not it will be advisable to show the cost on the tag on each article. It is not a good practice, if you expect the salesman to sell the article at the selling price as shown on the tag, as it gives him an opportunity to use his own judgment, and sometimes weakens his position with the customers. However, if the competition is keen, and it is desired to have an asking price, and if the customer does not want to pay such price, a margin could be allowed, and a second price shown and regarded as the bottom price at which the article can be disposed of. This, however, is not good business in high grade establishments catering to first-class trade. W. C.

What Tool is of More Importance to THE MAKERS OF FINE JEWELRY than

**A FIRST CLASS SAW ?**

**SHARP—TRUE—UNIFORM  
—PERFECTLY TEMPERED**

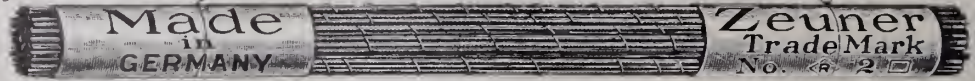

Such is the **ZEUNER SAW.**

**TRY THEM,** for "Only the Best are Good Enough," and only the Best are Cheap. Trial orders promptly filled under guarantee of perfect satisfaction, which applies also to our "AMERICAN SWISS FILES."

**E. P. REICHELME & CO.,** 23 JOHN STREET, NEW YORK.

**HERPERS BROS.,**  
MAKERS OF  
**BRACELET SETTINGS**  
IN 10, 14 AND 18 KARAT GOLD AND IN PLATINUM.  
ALSO A COMPLETE LINE OF GALLERIES AND FINDINGS.  
OFFICE AND FACTORY NEWARK, N. J., U. S. A. NEW YORK BRANCH 41-43 MAIDEN LANE  
12 NEW PATTERNS

**GLARDONS' SWISS FILES**  
are the **HIGHEST STANDARD** of Excellence.  
We are Sole Agents for the United States and Canada.  
**F. W. Gesswein Company,**  
Established 1868. Incorporated 1896.  
WILLIAM DIXON, PRES.  
Dealers in Fine Tools and Supplies,  
39 John Street, New York.

**BLANCARD & CO.,**  
96 MAIDEN LANE,  
NEW YORK.  
WELL MADE GOLD FINDINGS.

**CRUCIBLES.**  
Jewelers' Supplies, Etc.  
Established 1850.  
**J. & H. BERGE,**  
95 John Street, NEW YORK.

**F. JEANDHEUR, Jr.**  
Rear 17 John St., N. Y. Third Floor.  
**Gold and Silver Plating**  
SPECIAL WORK AND COLORING IN ALL SHADES A SPECIALTY.  
Established 1868. **Platina Plating.**

**ROLLED GOLD PLATE  
SEAMLESS WIRE AND TUBING**  
**DUNBAR, LEACH, GARNER CO.,**  
MANUFACTURERS,  
ATTLEBORO, MASS.

**CASTINGS** Gold, Silver, Bronze, Brass, German-silver, Copper & Iron, Supply Jewelers, Silversmiths, Die-makers, Mould-makers, etc.  
L. D. Tel. 2072 L.  
Unbreakable Bronze Forces. Hard Bronze Engraving Plates. Cast Iron Forces for making Steel Dies.  
Chandeller, Undercut Work, Statuary.  
**AUGUST GRIFFOUL,** 313 HALSEY STREET, NEWARK, N. J.

**JAMES J. DONNELLY,**  
**Gold and Silver Electro Plater,  
Fire Gilder and Colorer,**  
41 and 43 Maiden Lane, New York.  
Prompt Attention Given to Mail Orders.

**THE "E-Z-FILL" SELF-FILLING FOUNTAIN PEN**  
FILLS INSTANTLY BY TOUCHING SPRING ON SIDE OF BARREL WITH PATENT PUSH PIN. Other Patents Pending.  
**THE "E-Z-FILL" SELF FILLING FOUNTAIN PEN**  
PAT. JAN. 4 1903  
Every Pen Warranted 14-Karat Solid Gold. No complicated parts to get out of order. Large profits to Jobber and Retailer. The only safe and practical Self-Filling Fountain Pen ever offered at a popular price. Made only by  
**DIAMOND POINT PEN CO.** - 100-102 Beekman Street, New York  
Largest Manufacturers of Popular Price Fountain Pens in the United States INFRINGERS WILL BE STRICTLY PROSECUTED Send for large Illustrated price list

Retails at **\$1.00**



[Answers are also solicited from our readers to the questions published on this page.]

**QUESTION No. 1629.—A Test for Diamonds.**—How can I test a diamond so I can distinguish a genuine from a counterfeit?  
A. T.

**ANSWER:**—An Italian chemist, Massimo Levi, gives the following as a test for diamonds: If you have a doubtful stone, put it into a leaden or platinum cup with some powdered fluorspar and a little oil of vitriol; warm the vessel over lighted charcoal in a fireplace or wherever there is a strong draught to carry off the noxious vapors that will be copiously evolved. When these vapors have ceased rising, let the whole cool and then stir the mixture with a glass rod to fish out the stone. If you find it intact it is a genuine stone, but if it is false it will be corroded by the hydrofluoric acid that has been generated around it. A paste diamond will disappear under the treatment.

**QUESTION No. 1630.—Tinning Brass and Copper by Immersion.**—How can I make a solution that I can use for tinning pieces of brass and copper by simply immersing? Also how to make a solution for tinning with the battery process?  
T. B. C.

**ANSWER:**—For tinning by immersion prepare a solution of ammonia alum, 17½ ounces; boiling water, 12½ ounces; protochloride of tin, 1 ounce. After the articles to be tinned are properly cleaned they are placed in the above solution while boiling, and continue the boiling until the articles are properly whitened. To plate with tin and the electric current, prepare the bath by using the following proportions: Potassium pyrophosphate, 12 ounces; protochloride of tin, 4½ ounces; water, 20 ounces. For the anode pure Banca tin should be employed, and then a moderate current should be used. Finish with a fine scratch brush. For tinning small iron castings, clean and boil them with scraps of block tin in a solution of cream of tartar.

**QUESTION No. 1631.—Lustrous Pearls.**—Will you inform me how to keep pearls so that they will retain their luster?  
G. D.

**ANSWER:**—The best means for preserving pearls in their normal condition is to place them in a box or metal drum filled well with calcined magnesia in order to exclude the air and gases.

**QUESTION No. 1632.—Etching on Large Cups.**—Please suggest a better way of etching on large cups with round surfaces than by laying them in the acid.  
A. T.

**ANSWER:**—The surface of any object to be etched may be limited by being surrounded with a composition of asphaltum cement or a similar substance.

**QUESTION No. 1633.—To Polish Tortoise Shell Back Combs.**—How are tortoise shell

back combs polished after they get shop-worn and dull?  
F. X.

**ANSWER:**—Tortoise shell may be polished by a revolving buff of a soft texture charged with rotten stone mixed with oil, or tripoli, or putty powder, the latter also mixed with oil.

**QUESTION No. 1634.—To Prevent Jewelry from Tarnishing in a Safe.**—My gold and plated jewelry turn red in my new safe. How can I prevent this?  
G. B.

**ANSWER:**—Foul air is probably the cause. Gum camphor, placed in the safe, has a tendency to prevent this trouble.

**QUESTION No. 1635.—Cement for Bone and Glass.**—Where can I get a good cement for repairing bone fans, combs and glassware?  
H. S. F.

**ANSWER:**—Rosenthal Mfg. Co., 3163 Cottage Grove Ave., Chicago, and Van Stan's Stratena Co., 1211 N. 60th St., Philadelphia, Pa.

**QUESTION No. 1636.—Restoring Brilliance of Diamonds After Fire.**—Is there any acid which will restore brilliancy of diamonds that have been through a fire?  
S. F.

**ANSWER:**—No acid or any chemical substance is known which will restore the brilliancy of a diamond which has been overheated. It is necessary in such a case to have the diamond repolished.

**QUESTION No. 1637.—Receipt for Making Lacquer.**—How is lacquer made?  
C. A. K.

**ANSWER:**—A good lacquer for silverware is made from spirits of wine to which a little collodion is added. With this mixture paint your silverware. If you have a great number of articles to be coated it would pay to fill a vessel large enough to contain each one of your silver articles, and dip them into it; then hang them up to dry in a room free from dust. The fluid dries quickly, leaving a thin, transparent, absolutely invisible film upon the silver, and protects it from the influence of the air. Through a mixture of aniline colors soluble in alcohol, the so-called "brilliant varnish" is obtained for the use of gilded ware. By immersion in hot water the invisible collodion film can be removed at any time. The best thing to do, however, is to use collodion lacquer, which can be obtained from any manufacturer of silverware or from jewelers' material stores.

It is reported that a manufacturing jewelry establishment will soon be started in the Minnehaha building, in Sioux Falls, S. Dak.

### Practical Advice on Glass Drilling.

Editor THE JEWELERS' CIRCULAR—WEEKLY:

In your issue of July 11 is an answer to question No. 1605, in "Workshop Notes and Queries," as to drilling holes in glass. The answer is good as far as it goes, but it does not go far enough.

The drilling of glass with a steel drill is a "paradox." The slower the drill is rotated the faster it cuts. The saturated solution of camphor in turpentine, with or without ether, is all that could be desired. There may be other shapes of drills, but one shaped like the accompanying illustration is easily made, and quickly sharpened when dull. Figure No. 1 is an edge view; No. 2 is a side view. Make the drill out of an ordinary round file, leaving the temper just as it is. Simply sharpen the small end of the file as shown, and insert the opposite end in a large-sized watch screwdriver or spectacle screwdriver, No. 1169 or 1171.

Hardy's lists are both good. Do not try to use a cut of file finer than No. 2. Do

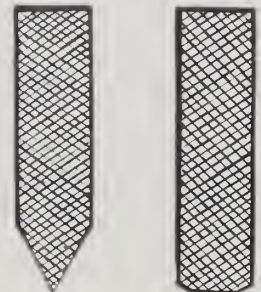

FIG. 1.

FIG. 2.

not disturb the file teeth toward the end or the drill, except on the two sides. The file teeth on the edge of the drill act as a reamer while drilling. In reaming out a hole after drilling, use a No. 2 round file, and rotate it from right to left (at the top). The files are cut with a sort of spiral cut. If you revolve them the other way they will screw into the hole and break the glass.

Use the drilling solution freely and revolve the tool very slowly by hand; then you can feel it in case it begins to bind.

If you use the drill for making holes in rimless lenses, first put the strap on a stud over the lens, where you want the hole to be. Have the strap holes large enough to accommodate the drill. Have your drill always sharp. Take the drill, dip in solution, place upon the glass to be drilled, and by hand rotate it slowly back and forth, giving it a moderately firm pressure. Drill from both sides, go slowly, and reduce the pressure as you feel the drill meeting the hole on other side of lens. Accidental breakage of glass will be less than 1 per cent. Average time to drill an ordinary lens is 30 seconds.  
J. M. I.

W. B. Sherratt, Lakepark, Ia., has sold out to C. B. Chrysler. Mr. Sherratt will move to Humboldt in the same State, where he will continue business.

At a recent meeting of the trustees in Bath, N. Y., a new town clock was formally presented to the village. The timepiece will be erected at the entrance of Pulteney Sq. The clock was fully described in a previous issue of THE CIRCULAR—WEEKLY.



# ART WARES

FOR THE

## OPENING SEASON

Discriminating Importations from Noted  
Art Centers. Rich and  
Varied Showings.

FERDINAND  
BING & CO.'S  
SUCCESSORS

Special Wares  
for the  
Art Department  
of  
Jewelers.

10  
Washington  
Place,  
NEW YORK.

THE DISPLAYS provided by this establishment in former seasons justify the jeweler in expecting that a rich harvest of Art Wares awaits him now. His interests have not been lost sight of in notable selections from leading art centers abroad. Varied and impressive showings in Bronzes, Electroliers, Antique Brass and Copper, Ceramics, Marble Statuary, Art Glass, Clocks, etc., will reward inspection.

# THE CONNOISSEUR

*Devoted to Art Pottery, China, Marbles, Bronzes, Cut and Decorated Glass Ware, Bric-à-Brac, Lamps, Art Metal Wares, Fancy Goods and Kindred Lines.*

## Recent Reappraisements of Statuary, China, Cut Glass, Pottery, Etc.

**R**EAPPRAISEMENTS of china, statuary and similar lines were announced last week by the Board of United States General Appraisers, New York, as follows:

Alabaster statuary from Itala Chericci & Co., Rome, exported May 2, 1906, entered at New York (File No. 10351); findings of Waite, G. A.: Alabaster statue and column, entered at 210, advanced to 235 lire for both.

White china from O. & G. Guthcrz, Carlsbad, exported March 6, 1906, entered at Newport News (File No. 39418); findings of Hay, G. A.: Tea cups and saucers, 37, entered at 2.04 crowns per dozen; A. D. cups and saucers, Paris, entered at 2 crowns per dozen; plates, 21 cm., Paris, entered

entered at £3 18s. 6d. Add case. Less carriage. No advance.

Japanese merchandise from Morimura Bros., Kobe, exported Aug. 23 to Dec. 30, 1905, entered at New York and Port Townsend (File Nos. 37876, 38030, 38093, 38204, 38276); findings of Waite, G. A.: Porcelains, 245/2, flower pots, entered at 80 yen per set, packing included; teapots, 235/4, entered at .04½ yen each; do., 235/2, entered at .14½ yen each; dishes, 227/63, entered at .06 yen each; plates, 227/3, entered at .03½ yen each; cups and saucers, 226/4, entered at .04½ yen per set; assorted vases and koros, 3 pieces in set, 214/39, entered at 11.88 yen per case of 4 sets; 222/29, tea set, 6 pieces in set, entered at 4.60 yen per set; 222/11, chocolate sets, entered at 3.10 yen per set; 223/82, vases, entered at 1.70 yen per piece; 223/140, vases, entered at 1.25 yen each; 223/76, vases, entered at .65 yen each; 223/125, vases, entered at .45 yen each; 223/142, vases, en-

## Magnificent China Service Presented by King Edward to Alfonso.

**T**HE magnificent state dessert and coffee service which King Edward has presented to King Alfonso is a reproduction of the historic service made at the old Chelsea Works in 1763 by order of Queen Charlotte for her brother, the Grand Duke of Mecklenberg-Strelitz. The present Grand Duke lent some of the models for this work.

The service was supplied by Thomas Goode & Co., of S. Audley St., London, who possesses some of the original models. It is hand painted and hand gilded, and consists of the following pieces: Thirty plates,



PART OF MAGNIFICENT STATE DESSERT AND COFFEE SERVICES PRESENTED BY KING EDWARD TO KING ALPHONSO.

at 2 crowns per dozen. And similar goods. Discount, 3 per cent. Add case. Advanced 3 per cent.

Decorated china from Koshin Shokai, Yokohama, exported Jan. 23, 1906, entered at New York (File No. 38843); findings of Waite, G. A.: Porcelain tea sets, 7 pieces, entered at 37, advanced to 55 yen for all.

Cut glass ware from Petrus Regout & Co., Maestricht, exported Jan. 25, 1906, entered at New York (File No. 34625); findings of Board No. 3: Prices as published in reappraisal No. 3907, April 10, 1905. Reappraised value affirmed.

Decorated china from Chieppe & Barbarin and Gustav Balleroy, Limoges, exported Sept. 2, 1905, to Feb. 24, 1906, entered at New York (File Nos. 37368 and 39094/95 (findings of Board No. 2): Prices as published in reappraisal 6940, May 2, 1906, and 6939, May 2, 1906. Reappraised value affirmed.

Polished granite from W. F. Pratt, Aberdeen, exported Jan. 19, 1906, entered at Boston (File No. 38520); findings of Waite, G. A.: 1 Beers red die,

entered at .39½ yen each; 223/133, entered at .34 yen each; 223/92, vases, entered at .50 yen each; 223/18, entered at .25 yen each; 223/93, vases, entered at .23 yen each; 68/68, bowls, entered at .80 yen each; do., 68/70, entered at .75 yen each; chocolate pot, 30/29, entered at .65 yen each; 144/107, boxes, entered at .26 yen each; 162/8, jars, entered at 1.95 yen each; 138/15, fern pot, entered at .90 yen each; 161/39, tankards, entered at 1.45 yen each. To all prices from No. 222/29, tea set, manufactured by Saigo, add 25 per cent; prices above that are net. Vases, 73606, entered at .49 yen each; chocolate pot, 73346/73770, entered at .55 yen each; 2534/34/73770, almonds, entered at .13 yen each; 73435/73778, comport, entered at .42 yen each. Add 10 per cent. on these prices. And similar goods. All advanced 10 per cent. Add cases and packing.

J. B. Pederson, Leeds, N. Dak., has started work for the erection of a modern store building for his jewelry business.

eight square dishes, two curious jardinières with covers, ice buckets, two round bowls, one oval center piece and stand, four oval covered dishes, two oval sugar tureens and covers, 18 coffee cups and saucers.

The china, which is decorated with embossed gilt, bears dark blue panels, at intervals containing gilt insects, moths, flies, butterflies, etc., in relief with floral festoons in between, while in the center is the quaint exotic bird peculiar to the old Chelsea of this date.

W. H. Baird, Waverly, N. Y., has discontinued business.

Taylor & Berlovitz, Newburg, N. Y., have dissolved partnership, and the business will be continued by John W. Taylor.

**C. DORFLINGER & SONS,**  

---

 36 MURRAY STREET, NEW YORK.

Manufacturers of plain  
 and cut Table Glassware  
 of the highest quality.

*Works, White Mills, Wayne Co., Penna.*



**"The World's Best"**

A simple phrase, but  
 brim-full of significance,  
 as applied to cut glass.  
 The dealer knows its  
 truth; so does the buyer.  
 That's why a lower price  
 for some other cut glass  
 than Libbey has no pow-  
 ers of attraction.

**That's Why the Buyer  
 Looks for the Name**

**The Libbey Glass Co.**  
 TOLEDO, OHIO  
 New York Salesroom, No. 57  
 Park Place.

*Libbey*  
 "THE WORLD'S BEST"

**LOOKING FOR  
 THE NAME**

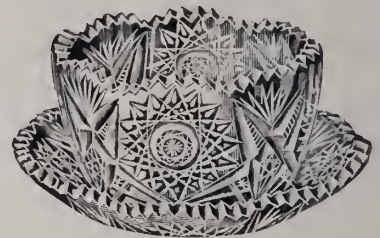

No. 755, MAYONNAISE BOWL AND PLATE  
 SEMINOLE

**A Ready Seller During the  
 Salad Season**

**Maple City Glass Co.,**  
 CUT GLASS TABLEWARE,  
 Hawley, Pa.

SALESROOMS:  
 New York—H. B. Stites, 253 Broadway.  
 Baltimore—Green & Thomas, 33 S. Charles  
 St.  
 Boston—Sweetser-Bennett Co., 101 Tremont  
 St.  
 Buffalo—J. R. Stadlinger, 685 Main St.  
 Indianapolis—J. A. Dugan Co., 22 S. Capl-  
 tol Ave.  
 Duluth—Duluth Crockery Co., 6th Ave. and  
 West St.  
 Denver—Western Selling Co., 422 Charles  
 Block.

**Tivoli Art Glass Co.**

(L. ADLER & SON)

Makers of High Art Iridescent  
 and Decorated Glassware  
 87 Maiden Lane NEW YORK  
 Telephone, 2054 John.



If you were con-  
 vinced, Mr. Jew-  
 eler, that a line of  
 glassware show-  
 ing the iridescent  
 colors of the rain-  
 bow would sell  
 readily and yield  
 a handsome prof-  
 it, wouldn't it in-  
 terest you? Our

line is that line, consisting of Vases,  
 Fancy Bowls, Globes, Novelties,  
 etc., ranging in price from \$1 to  
 \$50 each. Write us for information  
 and send to-day for a selection.

**TRADE-MARKS**

OF THE JEWELRY AND KINDRED TRADES.  
 Over 4,000 Marks. Second Edition. Price, \$3.00.  
 The Jewelers' Circular Pub. Co., 11 John St., N. Y.

### Recent Publications.

**SCHMUCK- UND EDELMETALL-ARBEITEN.** Eine Auswahl Moderne Werke. By COUNCILLOR ALEXANDER KOCH. Imperial octavo, cloth, gilt, 211 pages, profusely illustrated. Published by Alexander Koch, Darmstadt, Germany. Price, 16 marks (postage extra).

THIS elegant art work is recently from the German press under the above title, which, translated into our vernacular, reads "Decoration and Work in the Precious Metals," being a selection of modern works of leading German, Austrian, English and French artists.

Starting with a preface of two pages, the remainder of this beautiful volume is entirely devoted to reproductions in the best of the process engraver's art of the salient chef d'oeuvres of recent years. Perhaps the best method of hinting at the value of the work in the short space at disposal would be to enumerate the names of the various artists represented. They are included in the following list: F. Adler, Munich; C. R. Ashbee, London; Prof. Peter Behrens, Düsseldorf; Franz Böres, Stuttgart; Rudolf Bosselt, Düsseldorf; Prof. Hans Christiansen, Darmstadt; J. V. Cissarz, Darmstadt; Christine Connell; Prof. C. O. Czeschka, Vienna; M. Dufrene, Paris; Erich Erler-Samaden, Munich; Theodor Fahrner, Pforzheim; Alexander Fischer, Kensington; Fröhlich, Bremen; Ernst Moritz Geyger, Florence; Prof. Alfred Grenander, Guild and School of Handicraft, London; P. Hausteim, Stuttgart; M. Herberger, Munich; H. Hirschwald, Berlin; Prof. Jos. Hoffmann, Vienna; Höcker & Son, Amsterdam; Anton Huber, Flensburg; Patriz Huber; Margarete Jung, Dresden; Ethel Karuth; Prof. G. Kleemann, Pforzheim; Erich Kleinhempel, Dresden; Charlotte Krause; Richard Kühl, Berlin; René Lalique, Paris; Lauer & Wiedmann, Pforzheim; Margaret Mackintosh, Glasgow; Maison Moderne, Paris; M. Meyer, Mayence; Prof. Kolomon Moser, Vienna; Prof. Jul. Müller, Salem, Pforzheim; August Oesselmann, Darmstadt; Hans Ofner, Vienna; Alfred Oppenheim, Frankfurt-on-the-Main; M. Pfeiffer, Munich; Otto Prutscher, Vienna; Ernst Riegel, Munich; Ada Ridley; Aage Rolund; Rope & Woodward; K. M. Seifert, Dresden; H. Schmidt-Straub, Pforzheim; Schmitz, Breslau; F. Schmoll von Eisenwerth, Munich; Florence H. Steele; Prof. Curt Stoeving, Berlin; Architect von Tettau, Berlin; Louis C. Tiffany, New York; E. L. Vietor, Darmstadt; Heinrich Vogeler, Worpswede; Wadsworth; W. Weingartner; Vienna Werkstätte; H. Wilkens & Sons, Hemelingen; Bernhard Wenig, Hanau; Prof. F. Wolber, Pforzheim; Philippe Wolfers, Brussels; E. C. Woodward; Würbel-Czokaly, Vienna; F. Zerrenner, Pforzheim.

The jewelry, utensils, etc., represented in the selection consist of pendants, bracelets, bowls, flower-holders, brooches, necklaces, diadem, snuff boxes, fans, fruit-trays, girdle-clasps, lamps and candle-sticks, cuff-buttons, dress-pins, goblets, smoker's utensils, rings, combs, caskets, umbrella and cane-handles, table center-pieces, tea and coffee services, toilet-mirrors, watches, watch-chains, liqueur and wine bottles, mural displays, panels, etc.

As might be expected, the masterpieces of René Lalique somewhat dwarf the other designs; pages 42 to 55 are dedicated to this past master in the plastic art. Erich Erler-Samaden, Ernst Moritz Geyger, Ernst Riegel, C. B. Ashbee, are represented by extremely talented designs of great originality. Professors Josef Hoffmann, and Kolo Moser also have charming *pièces de resistance* to prove that this decadent age is not altogether without its masters in the gold and silversmithing art.

Councillor Koch in his despondent preface declares that "nowhere is the battle for art so dull and unenlivening than in the province of decoration and work in the noble metals." He declares that even among our wealthiest—where cost does not count—the value of the gems and the materials in which they are made up alone is appraised. Of these they know the worth, but of art value—nothing.

In this superb collection of art works is certainly contained a selection of exemplars that will prove invaluable in the workshops, studios and other vocations where gold and silversmithing have their home.

A few of these masterpieces, of course, have already found illustration in THE CIRCULAR-WEEKLY, but numerous of the pieces have never before been seen in publications, this side of the Atlantic at least.

### Recent Customs Decisions on Statuary.

THE following cases in which duties on statuary were involved were recently decided by the Board of United States General Appraisers, New York:

**STATUARY—CARVED TABLE.**—Protest of National City Bank of New York against the assessment of duty by the collector at New York. The article in dispute consisted of a marble table with supports or legs carved in Pompeian style. The importers contended that it was statuary as defined in Par. 454, tariff act of 1897. Protest overruled. Note G. A. 6346 (T. D. 27302) and G. A. 5462 (T. D. 24758).

**STATUARY—BUSTS—BAS-RELIEF.**—Protests of John Wanamaker et al. against the assessment of duty by the collector at New York. Protests sustained as to bases for busts, on the authority of Abstract 9303 (T. D. 26902), and overruled as to bas-relief, on the authority of G. A. 5225 (T. D. 24048). The importers claimed the merchandise to be statuary as defined in Par. 454, tariff act of 1897.

**STATUARY—BASES FOR BUSTS.**—Protests of John Wanamaker against the assessment of duty by the collector at Philadelphia. The Board held bases for busts dutiable as statuary, as claimed by the importer.

A German correspondent reports that in the zoological gardens at Breslau there is a spider monkey which was operated upon for cataract, and now wears eye glasses. For more than a year after it was received at the zoo it was very healthy and lively; then it became very quiet, ceased to play, and crouched in a corner. It was examined and found to be suffering from cataract, so it was immediately taken to the eye hospital and operated upon. In less than a month it was fitted with a pair of spectacles, which it wears with becoming gravity.

### Another New Form for Diamonds.

THE new form of cutting for diamonds, known as the "sun ray," now being introduced to the trade, has attracted attention of experts here and in Europe, who are studying its possibilities. The new cutting is the invention of Herbert Cooper, of the Cooper Diamond Co., who has secured patents for his design, and who believes it will revolutionize the cutting art. He claims that he produces a diamond with more brilliancy and better color, and with smaller loss, than is possible in the regular "brilliant."

The general shape of the "sun ray" diamond is similar to the regular brilliant, excepting that there is a little more weight left above the girdle. While the brilliant has a total of 58 facets, with 33 on the top, the "sun ray" has 74 facets, including the table and culet, 49 of these being above the

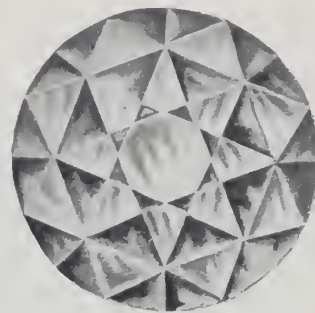

TOP VIEW OF SUN RAY CUTTING.

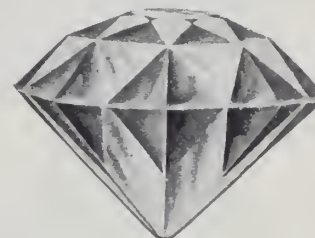

SIDE VIEW OF SUN RAY CUTTING.

girdle. This is necessary in order to produce a double crown effect, as may be seen in the illustration.

The upper crown is the same as on the brilliant, while the lower crown, being cut at a different angle, produces a raised point midway between the table and girdle, which by breaking the long facets produce a rose effect.

This rose effect is produced eight times, around the stone, and as each rose acts as an individual stone, more light enters and is reflected back, thereby causing a vast improvement in color, with double the brilliancy of the regular brilliant.

The "sun ray" diamond is the result of special study in the hope of producing more brilliancy than has ever before been shown in a diamond. The admirers of the cutting believe that saving in weight, increased brilliancy and improvement in color, without any material increase in the cost of cutting, are all effected.

C. E. Tucker, Greenville, S. C., has admitted his brother into the business, and the firm style has been changed to C. E. Tucker & Bro.



WE ARE MANUFACTURING  
**Low Priced Mother-of-Pearl Stick Fans**  
 WITH UP-TO-DATE DESIGNS.

Write for samples. State limit of price.

**IGNAZ STRAUSS & CO.**

Manufacturers of European, Japanese and American Fans and Novelties  
 SALESROOMS: 684 BROADWAY, NEW YORK, Repair Department.



No. 3399.—Loving Cup. Height, 10 inches.

**The Pairpoint Corporation.**

Send for Catalogue showing our complete line of

**Prize Cups and Trophies.**

BRANCHES:

38 Murray Street, New York City  
 36 St. Antoine Street, Montreal, P. Q.  
 717 Market Street, San Francisco, Cal.

FACTORY: NEW BEDFORD, MASS.



WE make compotes of good glass and have them decorated by artists, with designs in pure gold.

*Ask for Catalogue just issued.*

**THE HONSDALE DECORATING CO.**  
**HONSDALE, PENN.**

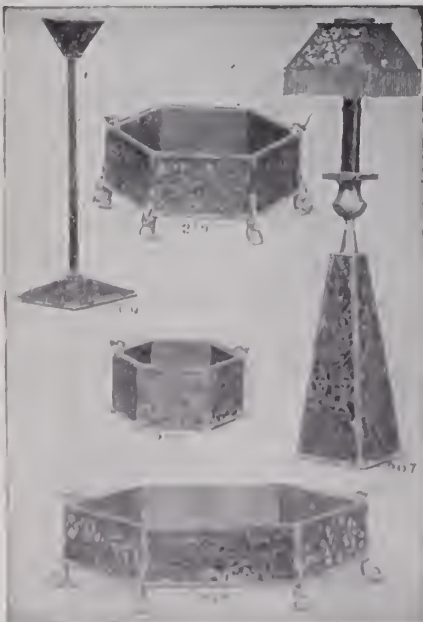

**For the FALL TRADE**

We have prepared many NEW ARTICLES in our famous

**"Metal and Glass" and Copper**

VISITING BUYERS are invited to inspect our new

**Electroliers, Desk Sets, Etc., Etc.**

**APOLLO SILVER CO.**

**BERNARD RICE'S SONS**  
 PROPRIETORS

WRITE FOR BOOKLET

544 BROADWAY, NEW YORK



Made in the "APOLLO STUDIOS"





Hand Bag.

Established 1850

**C. F. RUMPP & SONS**

Manufacturers of

**Fine Leather Goods**

**PHILADELPHIA**

NEW YORK SALESROOMS - - 683 and 685 Broadway

Send for Catalogue.



Emergency Case.

**Jewelers' Show Cases.**



Our Small **ROSEWOOD MOULDING STEEL LINED CASE.**  
We Challenge the World to Produce a Better Case.

**F. C. JORGESON & CO.**  
11-17 N. ANN ST., CHICAGO.

Makers of all Kinds of  
**Jewelers' Fixtures.**  
Write for illustrated circular.  
OUR MOTTO: The best of Everything.

**It's the Little Things that count.**



The dainty little things that appeal at once to the casual observer. If it's useful, as well as ornamental, so much the better. Here is a **LITTLE THING**, so very useful and so pretty in design and finish, that you have but to show one to make a sale, and it yields a **BIG PROFIT**. It is called

**The Automatic Eye-Glass Holder**

Can be used as well for a Pencil Holder. It is made in Enamel, Gold, Silver and Rolled Plate, in a variety of artistic designs. We fully guarantee every Holder. We mean it, and will replace any Holder that fails to satisfy. Samples sent upon request. Send for catalogue.

Est. 1832. **Ketcham & McDougall, Manufacturers,**  
37-39 MAIDEN LANE, NEW YORK.  
ALSO MAKERS OF THE LEADING LINE OF THIMBLES.



**LEARN JEWELERS ENGRAVING**

"The Engraving School that Graduates Experts."  
A fascinating, high-salaried and easily learned trade, taught thoroughly and practically by correspondence. Your instructor is the foremost authority and master workman in the world. We will teach the beginner better engraving by correspondence than he can gain in years of rigid apprenticeship. We will improve the skill of any engraver one hundred per cent. and make him master of the trade. The demand for competent engravers far exceeds the supply.  
Send for handsome, illustrated prospectus.  
**PAGE-DAVIS COMPANY.**  
Suite 10, 90 Wabash Avenue, CHICAGO.

**"PERFECTION"**  
A Diamond-Pointed Drill



For drilling Glass, Lenses, Stone or any Hard Substance

**Price \$5, \$6, \$7**  
According to Size and Quality

**MENDES CUTTING FACTORIES**  
12-16 John Street NEW YORK

**JACOT MUSIC BOX CO., IMPORTERS.**  
Stella and Ideal Music Boxes,  
39 UNION SQUARE, N. Y.

**A New Eyeglass Holder** Prevents Loss of Glasses from Hook

PRACTICAL—SIMPLE—SAFE—SECURE



A new and novel idea which has overcome the possibility of loss once glasses are entrusted to it. Glasses attached to this hook can only be removed at will of wearer and in the simplest manner. The feature of this hook is a "HUMP" engaged by a "LOOP" making a secure connection.



**PAUL GOUGELMAN, Manufacturer, 37-39 Maiden Lane, New York.**

Established 1879. Manufacturer of

**LOUIS W. HRABA, Fine Leather Goods,**

29 East 19th St., New York. Exclusively for the Jewelry Trade.

**CLOCKS, BRONZES COMMUNITY SILVER CUT GLASS, NOVELTIES**

SEND FOR CATALOGUE

**H. BEALMEAR & CO.**  
234-236 Park Ave.  
Baltimore, Md.

# TRIED AND PROVEN

## FOR 29 YEARS THE JEWELERS' LEAGUE

have been in continuous and successful operation. During this period they have paid to the beneficiaries of their members over

**\$3,134,000.00**

without disputing or compromising a single claim.

To-day, with adequate rates, they are in the full blast of vigor and prosperity.

Those desiring life insurance protection for their wives, or those dependent upon them, should investigate the new monthly table of rates, which offers maximum insurance at minimum cost.

**Death Benefits, - \$1,000 to \$5,000**

**Age limit of applicants, 21 to 44 years**

For full particulars, address the Home Office, 12 John St., New York City

GEO. W. STREET,  
President.

F. A. MARSELLUS,  
Sec'y and Treas.

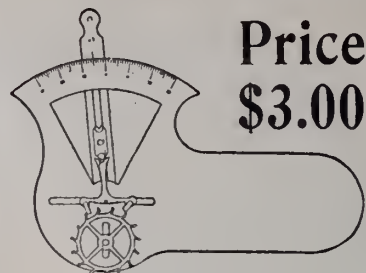

**Price  
\$3.00**

(Pat. Feb. 7, 1905.)

The LATEST, the BEST and  
the ONLY ACCURATE

## Pallet Stone Setting Tool

on the market, used in connection with the Depthing Tool. With this tool you can set a pallet stone in fifteen minutes, in place of from one to four hours at guess work. With the above instrument there's no guess work. In less than fifteen minutes your pallet is set correctly.

FOR SALE BY

**The Columbian  
Jewelry Supply Co.**

122 West 2nd Street, Central Block, 1st Floor,  
PUEBLO, COLO.

Send for descriptive circular  
Write us for prices on Clock Tools and Materials  
JOHN A. BLAIR, Manager



THE PERFECT SHAPE UMBRELLA

## "MAIDEN BALTIMORE"

No Springs  
No Screws  
CAN BE PUT  
IN A TRUNK

IT IS now nearing the time when Jewelers are looking toward purchasing their stocks for the Fall and Holiday seasons in Umbrellas and Canes. We are prepared with our line, which we have specially designed for the Jewelry Trade. It consists of rare novelties, and things entirely new and exclusive.

Our Detachable Handle Umbrella has met with great favor, and will increase your Umbrella Business, as it is the only

one on the market without levers, springs or screws. We make Umbrellas from \$1.50, with Sterling Silver and Gold Handles, up to \$125.00 each, and Canes from 50 cents up to \$25.00 each. Send for a Selection, Express paid.

## SIEGEL, ROTHSCHILD & CO.

MAKERS

418-420 West Baltimore Street, BALTIMORE, MD.

NEW YORK SALESROOM  
353 Broadway

PHILADELPHIA SALESROOM  
1011 Chestnut Street

## SEPTEMBER IN THE ADIRONDACKS

No finer place can be found than the Adirondacks in September.

The air is cool and bracing, the scenery beautiful and the sense of perfect rest that comes with the night is delightful.

This wonderful region is reached from all directions by the



"America's Greatest Railroad."

For a copy of "The Adirondack Mountains and How to Reach Them," send a two-cent stamp to George H. Daniels, Manager General Advertising Department, Grand Central Station, New York.

C. F. DALY,  
Passenger Traffic Manager,  
NEW YORK.

DAY  
CLASS

## ENGRAVING

NIGHT  
CLASS

THE SCHOOL FOR THOSE WITH MODERATE MEANS  
POMFRET-GOLDY SCHOOL OF JEWELRY ENGRAVING

SEND FOR PROSPECTUS 319 HEED BUILDING, PHILADELPHIA, PA.

# A Jewelers' Electric Lathe Motor

This illustration shows one of the eight different styles and sizes of Jewelers' Electric Lathe Motors, manufactured by **The Holtzer-Cabot Electric Co.**

Every Holtzer-Cabot Jewelers' Lathe Motor is backed by an absolute guarantee of one year.

which has passed through the experimental stages and which, through a careful elimination of defects, has become practically perfect.

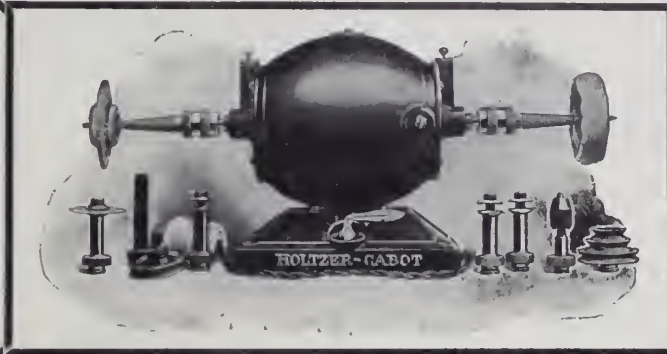

In using **Holtzer-Cabot Jewelers' Electric Lathe Motors** you receive the benefit of their **thirty years' experience** in the building of electrical apparatus, and you get a motor which has had **four years' trial** in practically all classes of buffing, grinding, polishing and kindred uses.

Send for our special circular No. 409, regarding our offer of "A Jewelers' Lathe Motor on Trial."

MAIN OFFICE,  
BOSTON (Brookline), Mass.

**The Holtzer-Cabot Electric Co.**

CHICAGO OFFICE,  
395 & 397 Dearborn St.

## Telephone Calls

only **5c.** each

## Extension Stations

only **\$6** per year

These are only two of the many attractive features of the new telephone rates, effective July 1st.

Contracts now being taken.

Call nearest Contract Office for full information.

**NEW YORK TELEPHONE COMPANY**

<i>Contract Offices:</i>	<i>Telephone No.:</i>
15 Dey Street	9010 Cortlandt
115 West 38th Street	9040 38th
220 West 124th Street	9000 Morningside
916 East 150th Street	9020 Melrose

# PATENTS

obtained on inventions and designs. Trade-marks, prints and labels registered.

**R. W. BISHOP,**  
ATTORNEY AT LAW,

908 C Street N.W., Washington, D. C.

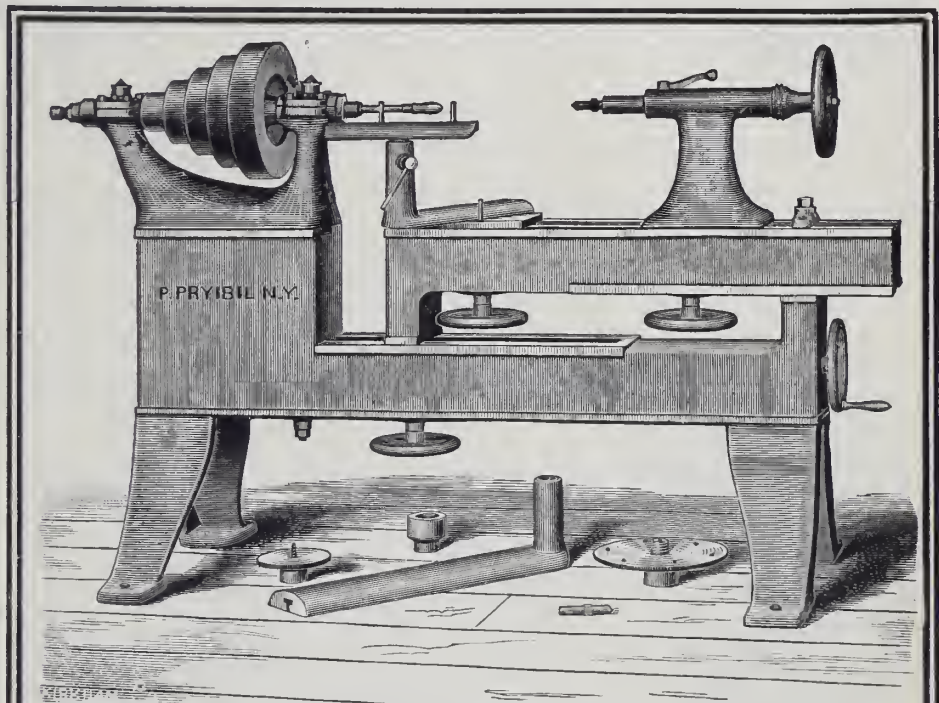

## Above Cut Shows Our EXTENSION SPINNING LATHE.

Swing of lathe 22 inches when closed, 44 inches when extended.

Substantially built for heavy work.

Write for  
Catalogue

**P. PRYIBIL,** 512-524 W. 41st St., New York.

*Mercantile Fountain Pen*

**The Best Self-Filling Attachment**

made and guaranteed by the

**AIKIN-LAMBERT COMPANY,**

19 Maiden Lane,  
NEW YORK.

Retail Price:

\$3.00

\$3.50

\$4.50

Send for Price Lists and Discounts.



**E. H. H. SMITH SILVER CO.**

BRIDGEPORT, CONN.

Silversmiths' Building,  
CHICAGO, ILL.

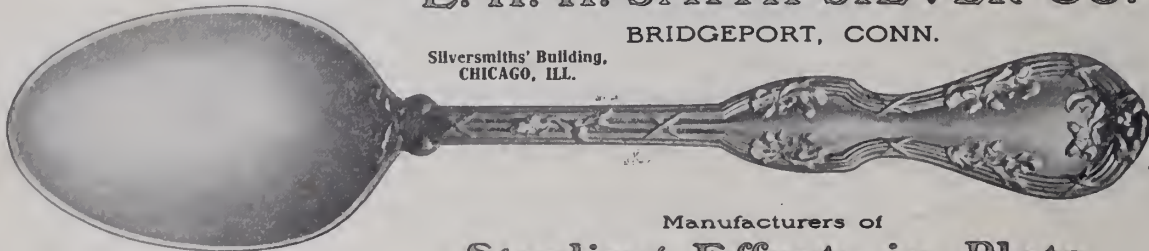

THE OAK.

Manufacturers of

**Sterling Effects in Plate**

Write for our new catalogue.

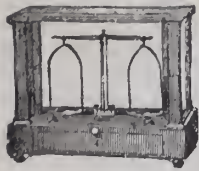

**HERMAN KOHLBUSCH, Sr.,**

ESTABLISHED 1859.

Manufacturer of Fine Balances and Weights  
for every purpose where accuracy is required.

Office and Salesroom, 194 BROADWAY, NEW YORK.

Send for Price List.

Tel. 370 Cortlandt.



**Modern Methods**

Insure maximum returns at minimum expense. We are equipped with up-to-date appliances, and guarantee prompt and honest service.

Send us a trial order.

**CONLEY & STRAIGHT,**

Gold and Silver Refiners,  
Assayers and Sweep Smelters,

236 EDDY STREET, - PROVIDENCE, R. I.

Dealers in Fine Gold,  
Silver and Copper.

All kinds of Gold  
and Silver Anodes.

**WM. F. RENZIEHAUSEN CO.,**  
**GOLD and SILVER REFINERS**

Sweep Smelters, Assayers and Analytical Chemists

Rolling of FINE AND STERLING SILVER a Specialty.

Long Distance Telephone, 3759-P.

45-49 Oliver Street, NEWARK, N. J.

**Encyclopedia-Dictionary**

and reference hand-book of the Ophthalmic Sciences.

Price, \$2.50.

The Jewelers' Circular Pub. Co., 11 John St., N. Y.

**WE BUY**

Old Gold and Silver Filings, Polishings, Sweeps, Hand Washings, etc. We will make accurate valuations and hold consignment subject to your acceptance. If valuation is not satisfactory, we reship to you at our expense.

**WE PAY FOR OLD GOLD:**

22 K. 88c. per dwt.	12 K. 48c. per dwt.
20 K. 80c. " "	10 K. 40c. " "
18 K. 72c. " "	8 K. 32c. " "
16 K. 64c. " "	6 K. 24c. " "
14 K. 56c. " "	4 K. 16c. " "

MARKET RATES FOR SILVER AND PLATINUM.

Try us and you will appreciate our Squareness, Promptness and Accuracy.

**T. B. HAGSTOZ, Ltd.,** Main Office, 709 Sansom St., Philadelphia, Pa.  
SMELTERS, ASSAYERS, REFINERS.

**WE SELL**

Gold, Silver and Platinum, various qualities, rolled flat or drawn to wire of any gage.

**PRICES OF ALLOYED GOLD:**

10 K. 48c. per dwt.	14 K. 64c. per dwt.
12 K. 56c. " "	16 K. 72c. " "
	18 K. 80c. per dwt.

Gold and Silver Solder, either from formulas furnished or our own. "T. B. H." Alloy, 25c. per oz. Guinea Gold, 75c. per lb. Shot Copper, 40c. per lb. We will send tables for alloying without charge. They save figuring.



**PLATINUM AMERICAN PLATINUM WORKS**  
NEW YORK OFFICE  
41 Cortlandt Street  
**NEWARK, N. J.**







