

Know All About
Jewelry Making, Jewelry Designing
and Metal Working



Olen Sampson
Ariel Needham

First Edition, 2012

ISBN 978-81-323-0346-6

© All rights reserved.

Published by:

Academic Pages

4735/22 Prakashdeep Bldg,

Ansari Road, Darya Ganj,

Delhi - 110002

Email: info@wtbooks.com

Table of Contents

Chapter 1 - Goldsmith

Chapter 2 - How to Make Simple Bead Jewelry

Chapter 3 - How to Make Metal Smooth

Chapter 4 - How to Make a Memory Wire Bracelet

Chapter 5 - How to Make a Beaded Necklace

Chapter 6 - Metalsmith

Chapter 7 - Brazing

Chapter 8 - Rolling (metalworking)

Chapter 9 - Jewelry Making

Chapter 10 - How to Price Your Jewelry Designs

Chapter 11 - How to Choose Jewelry

Chapter 12 - How to Choose a Platinum Ring

Chapter 13 - Necklace

Chapter 14 - Ring

Chapter 15 - Earring

Chapter- 1

Goldsmith

A **goldsmith** is a metalworker who specializes in working with gold and other precious metals. Since ancient times the techniques of a goldsmith have evolved very little in order to produce items of jewelry of quality standards. In modern times actual goldsmiths are rare. Historically goldsmiths have also made flatware, platters, goblets, decorative and serviceable utensils, and ceremonial or religious items, but the rising prices of precious metals have curtailed the making of such items to a large degree. Goldsmiths must be skilled in forming metal through filing, soldering, sawing, forging, casting, and polishing metal. Traditionally, these skills had been passed along through apprenticeships, however, more recently Jewelry Arts Schools specializing solely in teaching goldsmithing and a multitude of skills falling under the jewelry arts umbrella are available. Many universities and junior colleges also offer goldsmithing, silversmithing and metal arts fabrication as a part of their fine arts curriculum.

The nature of gold



15th century engraving of the goldsmith, and patron saint of goldsmiths, Saint Eligius in his workshop

Coupled with aesthetic attractiveness and rarity, gold's physical properties have given gold and items made from it an unparalleled place in human history. Gold is so malleable and ductile that even primitive tools can work it to a high level of detail. It is fairly easy to "pressure weld," which is to say that two small pieces can be pounded together to make one larger piece, similar to clay. Gold is a noble metal— it does not react with most elements. That means it is usually found in its native form, that it will last indefinitely without oxidization and tarnishing, and that it is easily melted, fused and cast without the problems of oxides and gas that are problematic with bronzes, for example. Throughout history, people have found its lustre and color to be aesthetically pleasing.

Since prehistoric times, mankind has been able to simply pick up gold off the ground, and anyone with two rocks would be able to form it into some pleasing or useful item. A major part of that history has been played by those who work in gold: goldsmiths.

History



Quelle: Deutsche Fotothek

Goldsmith in the mid-17th century

Gold has been worked by humans in all cultures where the metal is available, either indigenously or imported, and the history of these activities is extensive. Superbly made objects from the ancient cultures of Europe, Africa, India, Asia, South America, Mesoamerica, and North America grace museums and collections around the world. Some pieces date back thousands of years and were made using many techniques that are still used by modern goldsmiths.

In medieval Europe goldsmiths were organized in guilds and were usually one of the most important and wealthy of the guilds in a city. The guild kept records of members and the marks they used on their products. These records are very useful to historians, were they to survive. Goldsmiths often acted as bankers, since they dealt in gold and had sufficient security for the safe storage of valuable items. In the Middle Ages, goldsmithing normally included silversmithing as well, but the brass workers and workers in other base metals were normally in a separate guild since the trades were not allowed to overlap. Usually jewelers were goldsmiths. The Khudabadi Sindhi Swarankar community is one of the oldest community in goldsmithing in India, whose superb gold art works were displayed at The Great Exhibition of 1851 in London

The printmaking technique of engraving developed among goldsmiths in Germany around 1430, who had long used the technique on their metal pieces. The notable engravers of the 15th century either were goldsmiths, as was Master E. S., or the sons of goldsmiths, such as Martin Schongauer and Albrecht Dürer

The modern goldsmith

It has been said that goldsmithing is the only art which uses some aspect of all other arts. Thus a fully realized goldsmith might have a wide array of skills and knowledge at their disposal. Gold, being the most malleable metal of all, offers unique opportunities for the worker. In today's world a wide variety of other metals, especially platinum alloys, may also be used extensively. 24 karat is pure gold, and was historically known as fine gold. However, 24 karat gold is rarely used, because it is so soft, so it is usually alloyed to make it stronger and create different colors; goldsmiths may have some skill in that process. Then the gold may be cast into some item, usually with the lost wax casting process, or it may be used to fabricate the work directly in metal. In the latter case, the goldsmith will use a variety of tools and machinery, including the rolling mill, the drawplate, and perhaps swage blocks and other forming tools to make the metal into shapes needed to build the intended piece. Then parts are fabricated through a wide variety of processes and assembled by soldering. It is a testament to the history and evolution of the trade that those skills have reached an extremely high level of attainment and skill over time. A fine goldsmith can and will work to a tolerance approaching that of precision machinery, but largely using only his eyes and hand tools. Quite often the goldsmith's job involves the making of mountings for gemstones, in which case they are often referred to as *jewelers*.

'Jeweler' however is a term mostly reserved for a person who deals in jewellery (buys and sells) and not to be confused with a goldsmith, silversmith, gemologist, diamond cutter and diamond setters.

Notable goldsmiths

- Jocelyn Burton
- Paul de Lamerie
- Paul Storr
- Lorenzo Ghiberti
- Benvenuto Cellini
- Johannes Gutenberg
- House of Fabergé

Contemporary goldsmiths

- William Claude Harper
- Mary Lee Hu
- Linda MacNeil

Chapter- 2

How to Make Simple Bead Jewelry



Hand Made Bracelet, Made With buttons and string.

Hey People!!

Wanna make a bracelet, ring, necklace etc Well u came to the right place, Im going to show you how to make jewellery quick, easy and fun. Are u making it for your mum, dad, brother or sister etc Then You can get a smile on they face, when u make jewellery for them. And they will not only think its nice, they would even know that YOU made it with your hands, and they going to be pleased. Well enough of me, lets start making!!



Steps

1. **Buy some elastic thread and medium sized beads.** Seed beads are too small and pony beads are too big.
2. **Decide what kind of jewelry you want to make.** This idea works well for necklaces, bracelets, rings, and anklets!
3. **Cut a piece of elastic thread about 2 - 4 inches longer than you need for your project.**
4. **Tie a bead onto one end of the piece of thread so the other beads do not fall off once you thread them on.**
5. **String desired beads onto the elastic.**
6. **Tie the two ends of the elastic together.**
7. **Cut off the extra thread.**



Tips

- Alphabet beads are fun to use for this craft!
- If you make bracelet or ring you will want it snug around your wrist or finger so it doesn't slide off.
- If you want to get fancier, you can position the beads where you want them by strategically tying small knots in the elastic.
- Try applying clear nail polish after tying the knot to keep it together.



Things You'll Need

- thick thread
- different kind of beads
- Clear nail polish

Chapter- 3

How to Make Metal Smooth



When you work with metal you will find that you cut yourself often. This will tell you how to keep yourself cut free. This method will take some time but it is definitely worth it.

Steps

1. **Start off by filing the edges of the metal until you are sure that you will not cut your fingers on it.**
2. **Take some rough sandpaper and spend a while making the sides as smooth as you can.** When you think they are at their smoothest, it is ready to move on.
3. **Then, take the rough sandpaper and smooth out the corners.**
4. **Take some 180 sandpaper and quickly finish it off.**



Tips

- A Dremel tool works great too.



Warnings

- Be careful of the metal's sharp edges when you get it.



Things You'll Need

- Metal
- File
- Rough sandpaper
- 180 sandpaper
- Bit of time



Chapter- 4

How to Make a Memory Wire Bracelet



The instructions below are for making a simple memory-wire bracelet.

Steps

1. **Take the memory wire and measure around your wrist twice if an adult and three times if a child.**
2. **Cut the memory wire with pliers made for memory wire.** Other cutters may be damaged if used on memory wire.
3. **Loop one end of the memory wire with pliers.** Place the wire in between the round nose pliers and push the wire around with your finger creating a small thin oval. Be sure to fully crimp the end of the wire to avoid sharp edges that may cause discomfort when worn. String beads on to the memory wire. Beginners may choose to use beads of similar colors, but don't hesitate to try a variety of shapes, colors and sizes for an eclectic look!
4. **Generally start with a metal bead and enlarge the size of bead used thereafter to give a tapering look to the ends of each side.** Aesthetically it has been recommended to clump same type beads in odd numbers (3,5,7) before

adding an alternate bead, metal component (small metal bead, metal spacer
*usually irregular thin component (like a flat pancake) made to cause a definite space between beads bringing attention and focus to that point).

5. **For example:** 6 Med blue round beads 6mm, two 6mm crystal bicone beads (pointed on each end), 1 6mm Square crystal bead 2 spacers and 3 Round 5mm silver balls would be arranged in the following order; 1 5mm metal ball followed by 3 6mm blue beads then add an additional 5mm metal ball followed by one of the 6mm bicones, spacer, square crystal, spacer, bicone, metal ball and 3 more additional 6 mm blue beads, and repeat until desired length has been met, ending the piece again with the smaller metal ball. -oOOOo0@[]@0oOOOoOOOo0@[]@0oOOOoOOOo- Etc.
6. **Curl the other end of the memory wire using the pliers, again being sure to leave a smooth end.** Any sharp points can be dulled with an emery board.



Tips

- Choose your beads in advance and have them arranged in the pattern you desire. Setting them on a towel or arranging in a slight long grooved surface makes it easier to arrange and determine beforehand. This will help you determine if you like the look you are creating prior to stringing the entire thing and realizing you hate it. Your pattern may be symmetrical - or not! Choose from a wide variety of

materials such as glass, wood, stone, or precious metal. You may wish to "frame" your larger beads with smaller beads such as seed beads or rondelles.

- Memory wire bracelets are especially popular when strung with dangle beads or charms.



Warnings

- Keep beads away from small children, as they may be swallowed.
- Dont put it around both hands as this can cut off circulation.



Things You'll Need

- round nose pliers
- memory wire for bracelets
- beads
- memory wire cutters



How to Price Your Jewelry Designs



Figuring out how to price your designs is not one of the more glamorous parts of running a successful jewelry design business. Pricing your designs can be tricky, especially if you design one of a kind pieces, but it is an essential step you must take to turn your hobby into a profitable business. Once you understand the costs of your business, and what you expect to profit from your work, creating a formula to price your designs is a simple process.



Steps

1. **Keep a "recipe book" to record exactly what was spent to create each design.** You will basically need to price each item used in your designs. For example, if you pay \$1.50 for a dozen sterling crimp beads, and you used 2 crimps beads in your design, you would divide \$1.50 by 12 (.13¢ per crimp bead), and so on, making it much easier to calculate the exact cost of each design. The more meticulous you are about calculating expenses, the better your pricing will be. Even the packing materials you use for the design and the shipping costs of the supplies should be accounted for. Keep receipts--this will also come in handy during tax time, if you want to deduct business expenses.
2. **Record your time spent on each design.** How quickly can you design and complete your jewelry? Second to quality, speed is a key factor in profitability. If it takes you 30 minutes to recreate a design, you would charge differently than a design that takes 4-5 hours to create. Write your time spent in your recipe book.
3. **Calculate the price.** Using a formula will give you a starting point, and you can tweak the price with the steps that follow. Which formula you use, however, will depend on whether you're selling retail (directly to customers) or wholesale (to stores, for example).
 - o Retail - Take the total cost of your supplies, multiply it times 2.5 (some people multiply by 3) and there's your retail price. A spreadsheet is perfect for this step. Simply set up a table of products used, your cost, and then a formula to calculate the pricing using the 2.5 or other multiple. If your business has a physical storefront, you have to take into consideration

that there are additional costs. Rent, employee pay, utilities, displays and fixtures, and property taxes all need to be considered in your pricing strategy. You may find that in your market, you may need to price at 3 to 5 times your cost of materials.

- Wholesale - Multiply by 1.5 (some people multiply by 2) instead. You can charge less for your jewelry if you're selling wholesale because you spend less time marketing to individual customers and more time actually making jewelry (advertising, processing orders, maintaining a shopping cart website, maintaining a store, etc.). You should verify that your market can afford a higher price (usually times 2 to 2.5) than the price you arrive at, using the next few steps. Many jewelry designers find that selling wholesale allows them to achieve business growth and profitability. When you use the 1.5 factor, you are allowing room for shop owners to sell your designs and even offer sales and discounts on your designs, if a certain design doesn't sell quickly enough. This may sound like a lot, but make sure that you consider the amount of time and labor you put into developing and creating your pieces as well as the boutique owner's expenses.
4. **Adjust for the cost of your labor.** The difference between a hobby and a business is whether you get a paycheck, so decide how much you want to make per hour, and make sure that your labor is accounted for in the price. Let's say, for example, the cost of supplies for your design is \$10 and you calculate \$25 as your retail price (using the 2.5 guideline). If you want to pay yourself \$10 per hour and you spent 2 hours on this design, then you really need to be charging at least \$30 for the piece (\$10 supplies, \$20 labor). There may be additional costs to consider, such as your storefront, or time spent marketing (e.g. creating a brochure).
- When deciding how much to pay yourself hourly, consider your experience. How long have you been designing jewelry? If you have a long track record, vast expertise, and a portfolio of unique designs, you may find that you can charge more. You may have particular advantages, including contacts and unique designs, that allow you to charge more.
 - To repeat--just because you enjoy doing the work doesn't mean you shouldn't get paid for it! Make sure you're getting at least minimum wage.
5. **Perform market research.** Now that you have an idea of what you want to charge for a design, it's time to dip your toes in the market and see if the piece can be profitable. Generally, it's a good idea to start off with the highest price you think the market will bear, because you can always bring it down.
- Have people offered to buy any of your jewelry designs? This is a good indication of the marketability of your designs. If your coworkers fight over a necklace you made, that may be a good sign that there is a market for your design. Friends and coworkers are also good sounding boards for prices. Ask them how much they think your design is worth, and what they would pay for it.
 - Examine past success. Have you already sold any of your jewelry? This is important too in that it gives you concrete information on how much you

can sell a design for. You may hear from friends or coworkers that they would pay \$XX for a design, but an actual sale is real, concrete evidence.

- Has an experienced designer evaluated your work? Having the opinion of another designer can be valuable in determining the level of quality of your work, and what you can expect to get for it.
6. **Re-evaluate the design.** If you encountered feedback in the previous step which indicates that the price you arrived at isn't going to fly, you have some thinking to do about this design.
- If you do not find interest for a particular design, you may want to think of changing the design.
 - Assess your materials. Do you design using sterling findings and semi-precious beads, or less expensive beads? Higher quality materials will always command a higher price in the market. You may want to consider making designs with both high quality materials, and less expensive materials. This will allow you to attract business from both the high end buyer, and the more budget minded buyer.
 - Don't cut yourself short just to "break in" to the market (e.g. selling to customers at wholesale prices). This will only get people used to cheap prices, and it'll be difficult to raise them later on, jeopardizing your chances of ever making your business profitable. It's better to redesign or reject pieces that don't cover their costs as described above.
 - It's better to redesign or reject pieces that don't cover their costs as described above. People are often suspicious of products sold at unusually low prices; most of us have internalized the idea that 'you get what you pay for'. Cheap prices are often interpreted as cheap materials and workmanship. If your pieces aren't selling well, try raising your prices. It goes against our intuition, but you may be surprised at the results! After all, jewelry is a luxury and not a necessity.



Tips

- As you become more experienced, you'll find which prices cover your unique costs while still generating sales. For example, if you're doing a lot of beadwork and wirework where the supply cost is low but the time spent is high, and you're selling retail only through a website, the following could be a better formula:
 - $(\text{cost of materials} \times 2) + (\text{time spent on piece} \times \text{hourly rate})$
 - calculate 30% of the previous figure and add it to the previous figure to account for overhead
 - multiply the figure by 2 to get the retail price
- Some people use the tactic of setting a retail price just under a whole number (\$49.95 rather than \$50) to make the price look less intimidating. This may be more suitable for relatively inexpensive pieces but you should experiment to see how your customer base responds.



Chapter- 5

How to Make a Beaded Necklace



Shell Focal Point Necklace



Jasper Necklace



Beaded Necklace (crystals, sterling silver tubes)



You'll need a few basic supplies, but making beaded necklaces is truly easy. All of the items needed are inexpensive and can be found at any craft store. Specialty beads of glass or stone can be found at a bead store or at one of the many online retailers.

Steps

1. **Gather your stringing materials.** The best kinds are flexible beading wire and beading thread. Look for wire that has 19, 21 or 49 strands of stainless steel wire, coated with nylon. (Strands that only have 3 or 7 wires will kink easily.) Beading thread is a great option if you are stringing lightweight beads, and it comes in several different colors. Also look for silk cord which comes in a variety of colors and thicknesses if you will be showing some of the stringing material in the project.
2. **Before cutting your thread or wire, determine the length of your necklace and add 4-8", so that you have enough material to connect the clasp to the stringing materials.**
3. **You will need crimping beads and a special crimping tool (a pair of chain nose pliers can be used in place of a crimping tool).** Many bead makers prefer sterling silver crimp beads. They bend easier than base metal ones, and grab the wire better, so your clasp stays secure. Crimp beads come in different sizes and can be smooth or printed with a design. Be sure to use a size that works with the stringing material.
4. **Gather 2 crimp beads, 1 clasp, and the beads for the desired necklace.**
5. **Slide a tiny bead (2-4mm) on the threading material, then the crimping bead, then another tiny bead on the stringing material about an inch or so down.** Place one end of the clasp (the jump ring) on after the crimp bead, and make a

- loop with the stringing material. Place the end of the stringing material through the clasp section and then the bead-crimp-bead combo and use the crimping tool/ chain nose pliers to crimp the bead in place. (If using bead thread, you may wish to put a dot of super glue or hypo cement on either end to ensure that the beads and crimp stay on.) These steps will protect the stringing material from rubbing on the ends of the crimp bead, which may cause the necklace to break.
6. **Choose your beads and lay out your design before stringing; using a beading board can be beneficial allowing the design to be laid out and measured before stringing.** When you are satisfied, string them onto your necklace. Be sure to leave about 3-4 inches of stringing material at the end.
 7. **Do the same thing as in step 3:** use a clasp section/ jump ring and the bead-crimp-bead combo and try to push the remaining stringing material into the bead holes below the crimp bead.
 8. **Be careful not to pull the stringing material too tight.** Leave a small amount of slack in the necklace (2-4 mm or 1/4"). This leaves room for the beads to move and rotate, so they don't rub on each other or the stringing material too much. If the stringing material is too tight the necklace will be rigid and this can make the design look angular instead of slightly rounded like a necklace should be.
 9. **Crimp the second end and cut the stringing material with slush cutters.** It is not recommended that you cut the wire too close to the crimp bead. An inch of wire, carefully hidden in the bead holes is good insurance against breakage.



Tips

- More strands of stainless steel wire equals more flexible jewelry.
- Beading wire with more strands should be used for projects with heavy or large beads.
- Sterling silver or gold-filled crimps hold better than base metal crimps.
- If you wish to sell your jewelry and you want the highest price possible, you must use high quality materials.
- Before crimping the last crimp bead hold the necklace in the air to release any slack in the stringing material otherwise there might be too much slack when completed and the design will look sloppy.
- Crimp covers can be used to cover the crimp bead and make the necklace look more professional.
- Magnetic clasps are a wonderful option especially for Mothers because they will release when pressure is applied preventing the stringing material/ necklace from breaking.



Warnings

- A too-tightly-strung necklace is more likely to suffer breakage.

- Keep the small beads away from children under three years old, as they are a choking hazard.



Things You'll Need

- Clasp (including jump rings)
- 19, 21 or 49 strand flexible beading wire or beading thread
- Sterling silver or gold-filled crimp beads
- Super glue or GS Hyo Cement if using thread
- Crimp beads
- At least 4 small beads to protect your crimps beads and hide your wire or thread "tails."
- Beads of your choice for necklace, such as glass, stone, ceramic, precious or base metal, etc.
- Crimping pliers or chain nose pliers
- Flush cutters
- Stiff, strong beading needles if using thread that does not come with an attached needle.

Chapter- 6

Metalsmith

A **metalsmith**, often shortened to **smith**, is a person involved in making metal objects. In contemporary use a metalsmith is a person who uses metal as a material, uses traditional metalsmithing techniques (though not necessarily the material), whose work thematically relates to the practice or history of the practice, or who engages in any number metal related activities.

Etymology

The word *smith* is cognate with the somewhat archaic English word, "smite", meaning "to hit" or "to strike". Originally, *smiths* practiced their crafts by forming metal with hammer blows. However, the old etymological guess of "smite" as the source of "smith" is without foundation. "smith" derives from an old Teutonic word, *smeithan*, to forge. The root is seen in the Greek word σμίλη, a burin.

As an English suffix, *-smith* connotes a meaning of specialized craftsmen — for example, *wordsmith* and *tunesmith* are nouns synonymous with writer or songwriter, respectively.

History

In pre-industrialized times, smiths held high or special social standing since they supplied the metal tools needed for farming (especially the plough) and warfare. This was especially true in some West African cultures.

Types



Illustration by Theodor Kittelsen for Johan Herman Wessel's *The Smith and the Baker*

Types of smiths include:

- a blacksmith works with iron and steel; (this is what is usually meant when referring just to "Smith")
- an arrowsmith forges arrow heads;
- a bladesmith forges knives, swords, and other blades;
- a coppersmith, or brownsmith, works with copper;
- a fendersmith makes and repairs the metal fender before fireplaces, protecting rugs and furniture in mansions and fine estates, and frequently cares for the fires as well;
- a goldsmith works with gold;
- a gunsmith works with guns;
- a locksmith works with locks;
- a pewtersmith works with pewter;
- a silversmith, or brightsmith, works with silver;
- a tinsmith, tinner, or tinker works with light metal (such as tinware) and can refer to someone who deals in tinware;
- a swordsmith is a bladesmith who forges only swords;

- a whitesmith works with white metal (tin and pewter) and can refer to someone who polishes or finishes the metal rather than forging it.
- a coinsmith works strictly with coins and currency

Artisans and craftpeople

The ancient traditional tool of the smith is a forge or *smithy*, which is a furnace designed to allow compressed air (through a bellows) to superheat the inside, allowing for efficient melting, soldering and annealing of metals. Today, this tool is still widely used by blacksmiths as it was traditionally.

The term, *metalsmith*, often refers to artisans and craftpersons who practice their craft in many different metals, including gold, copper and silver. Jewelers often refer to their craft as *metalsmithing*, and many universities offer degree programs in metalsmithing, jewelry, enameling and blacksmithing under the auspices of their fine arts programs.

Machinists

Machinists are metalsmiths who produce high-precision parts and tools. The most advanced of these tools, CNC machines, are computer controlled and largely automated.

Chapter- 7

Brazing



Brazing practice

Brazing is a metal-joining process whereby a filler metal is heated above and distributed between two or more close-fitting parts by capillary action. The filler metal is brought slightly above its melting (liquidus) temperature while protected by a suitable atmosphere, usually a flux. It then flows over the base metal (known as wetting) and is then cooled to join the workpieces together. It is similar to soldering, except the temperatures used to melt the filler metal is above 450 °C (842 °F), or, as traditionally defined in the United States, above 800 °F (427 °C).

Fundamentals

In order to obtain high-quality brazed joints, parts must be closely fitted, and the base metals must be exceptionally clean and free of oxides. In most cases, joint clearances of 0.03 to 0.08 mm (0.0012 to 0.0031 in) are recommended for the best capillary action and joint strength. However, in some brazing operations it is not uncommon to have joint clearances around 0.6 mm (0.024 in). Cleanliness of the brazing surfaces is also of vital importance, as any contamination can cause poor wetting. The two main methods for cleaning parts, prior to brazing are chemical cleaning, and abrasive or mechanical cleaning. In the case of mechanical cleaning, it is of vital importance to maintain the proper surface roughness as wetting on a rough surface occurs much more readily than on a smooth surface of the same geometry.

Another consideration that cannot be over-looked is the effect of temperature and time on the quality of brazed joints. As the temperature of the braze alloy is increased, the alloying and wetting action of the filler metal increases as well. In general, the brazing temperature selected must be above the melting point of the filler metal. However, there are several factors that influence the joint designer's temperature selection. The best temperature is usually selected so as to: (1) be the lowest possible braze temperature, (2) minimize any heat effects on the assembly, (3) keep filler metal/base metal interactions to a minimum, and (4) maximize the life of any fixtures or jigs used. In some cases, a higher temperature may be selected to allow for other factors in the design (e.g. to allow use of a different filler metal, or to control metallurgical effects, or to sufficiently remove surface contamination). The effect of time on the brazed joint primarily affects the extent to which the aforementioned effects are present; however, in general most production processes are selected to minimize brazing time and the associated costs. This is not always the case, however, since in some non-production settings, time and cost are secondary to other joint attributes (e.g. strength, appearance).

Flux

In the case of brazing operations not contained within an inert or reducing atmosphere environment (i.e. a furnace), flux is required to prevent oxides from forming while the metal is heated. The flux also serves the purpose of cleaning any contamination left on the brazing surfaces. Flux can be applied in any number of forms including flux paste, liquid, powder or pre-made brazing pastes that combine flux with filler metal powder. Flux can also be applied using brazing rods with a coating of flux, or a flux core. In either case, the flux flows into the joint when applied to the heated joint and is displaced by the

molten filler metal entering the joint. Excess flux should be removed when the cycle is completed because flux left in the joint can lead to corrosion, impede joint inspection, and prevent further surface finishing operations. Phosphorus-containing brazing alloys can be self-fluxing when joining copper to copper. Fluxes are generally selected based on their performance on particular base metals. To be effective, the flux must be chemically compatible with both the base metal and the filler metal being used. Self-fluxing phosphorus filler alloys produce brittle phosphides if used on iron or nickel. As a general rule, longer brazing cycles should use less active fluxes than short brazing operations.

Filler materials

A variety of alloys are used as filler metals for brazing depending on the intended use or application method. In general, braze alloys are made up of 3 or more metals to form an alloy with the desired properties. The filler metal for a particular application is chosen based on its ability to: wet the base metals, withstand the service conditions required, and melt at a lower temperature than the base metals or at a very specific temperature.

Braze alloy is generally available as rod, ribbon, powder, paste, cream, wire and preforms (such as stamped washers). Depending on the application, the filler material can be pre-placed at the desired location or applied during the heating cycle. For manual brazing, wire and rod forms are generally used as they are the easiest to apply while heating. In the case of furnace brazing, alloy is usually placed beforehand since the process is usually highly automated. Some of the more common types of filler metals used are

- Aluminum-silicon
- Copper
- Copper-phosphorus
- Copper-zinc (brass)
- Gold-silver
- Nickel alloy
- Silver
- Amorphous brazing foil using nickel, iron, copper, silicon, boron, phosphorus, etc.

Atmosphere

As the brazing work requires high temperatures, oxidation of the metal surface occurs in oxygen-containing atmosphere. This may necessitate use of other environments than air. The commonly used atmospheres are

- **Air:** Simple and economical. Many materials susceptible to oxidation and buildup of scale. Acid cleaning bath or mechanical cleaning can be used to remove the oxidation after work. Flux tends to be employed to counteract the oxidation, but it may weaken the joint.

- **Combusted fuel gas** (low hydrogen, AWS type 1, "exothermic generated atmospheres"): 87% N₂, 11–12% CO₂, 5–1% CO, 5–1% H₂. For silver, copper-phosphorus and copper-zinc filler metals. For brazing copper and brass.
- **Combusted fuel gas** (decarburizing, AWS type 2, "endothermic generated atmospheres"): 70–71% N₂, 5–6% CO₂, 9–10% CO, 14–15% H₂. For copper, silver, copper-phosphorus and copper-zinc filler metals. For brazing copper, brass, nickel alloys, Monel, medium carbon steels.
- **Combusted fuel gas** (dried, AWS type 3, "endothermic generated atmospheres"): 73–75% N₂, 10–11% CO, 15–16% H₂. For copper, silver, copper-phosphorus and copper-zinc filler metals. For brazing copper, brass, low-nickel alloys, Monel, medium and high carbon steels.
- **Combusted fuel gas** (dried, decarburizing, AWS type 4): 41–45% N₂, 17–19% CO, 38–40% H₂. For copper, silver, copper-phosphorus and copper-zinc filler metals. For brazing copper, brass, low-nickel alloys, medium and high carbon steels.
- **Ammonia** (AWS type 5): Dissociated ammonia (75% hydrogen, 25% nitrogen) can be used for many types of brazing and annealing. Inexpensive. For copper, silver, nickel, copper-phosphorus and copper-zinc filler metals. For brazing copper, brass, nickel alloys, Monel, medium and high carbon steels and chromium alloys.
- **Nitrogen+hydrogen**, cryogenic or purified (AWS type 6A): 70–99% N₂, 1–30% H₂. For copper, silver, nickel, copper-phosphorus and copper-zinc filler metals.
- **Nitrogen+hydrogen+carbon monoxide**, cryogenic or purified (AWS type 6B): 70–99% N₂, 2–20% H₂, 1–10% CO. For copper, silver, nickel, copper-phosphorus and copper-zinc filler metals. For brazing copper, brass, low-nickel alloys, medium and high carbon steels.
- **Nitrogen**, cryogenic or purified (AWS type 6C): Non-oxidizing, economical. At high temperatures can react with some metals, e.g. certain steels, forming nitrides. For copper, silver, nickel, copper-phosphorus and copper-zinc filler metals. For brazing copper, brass, low-nickel alloys, Monel, medium and high carbon steels.
- **Hydrogen** (AWS type 7): Strong deoxidizer, highly thermally conductive. Can be used for copper brazing and annealing steel. May cause hydrogen embrittlement to some alloys. For copper, silver, nickel, copper-phosphorus and copper-zinc filler metals. For brazing copper, brass, nickel alloys, Monel, medium and high carbon steels and chromium alloys, cobalt alloys, tungsten alloys, and carbides.
- **Inorganic vapors** (various volatile fluorides, AWS type 8): Special purpose. Can be mixed with atmospheres AWS 1–5 to replace flux. Used for silver-brazing of brasses.
- **Noble gas** (usually argon, AWS type 9): Non-oxidizing, more expensive than nitrogen. Inert. Parts must be very clean, gas must be pure. For copper, silver, nickel, copper-phosphorus and copper-zinc filler metals. For brazing copper, brass, nickel alloys, Monel, medium and high carbon steels chromium alloys, titanium, zirconium, hafnium.
- **Noble gas+hydrogen** (AWS type 9A)
- **Vacuum**: Requires evacuating the work chamber. Expensive. Unsuitable (or requires special care) for metals with high vapor pressure, e.g. silver, zinc,

phosphorus, cadmium, and manganese. Used for highest-quality joints, for e.g. aerospace applications.

Common techniques

Torch brazing

Torch brazing is by far the most common method of mechanized brazing in use. It is best used in small production volumes or in specialized operations, and in some countries, it accounts for a majority of the brazing taking place. There are three main categories of torch brazing in use: manual, machine, and automatic torch brazing.

Manual torch brazing is a procedure where the heat is applied using a gas flame placed on or near the joint being brazed. The torch can either be hand held or held in a fixed position depending on if the operation is completely manual or has some level of automation. Manual brazing is most commonly used on small production volumes or in applications where the part size or configuration makes other brazing methods impossible. The main drawback is the high labor cost associated with the method as well as the operator skill required to obtain quality brazed joints. The use of flux or self-fluxing material is required to prevent oxidation.

Machine torch brazing is commonly used where a repetitive braze operation is being carried out. This method is a mix of both automated and manual operations with an operator often placing braze material, flux and jiggling parts while the machine mechanism carries out the actual braze. The advantage of this method is that it reduces the high labor and skill requirement of manual brazing. The use of flux is also required for this method as there is no protective atmosphere, and it is best suited to small to medium production volumes.

Automatic torch brazing is a method that almost eliminates the need for manual labor in the brazing operation, except for loading and unloading of the machine. The main advantages of this method are: a high production rate, uniform braze quality, and reduced operating cost. The equipment used is essentially the same as that used for Machine torch brazing, with the main difference being that the machinery replaces the operator in the part preparation.

Furnace brazing

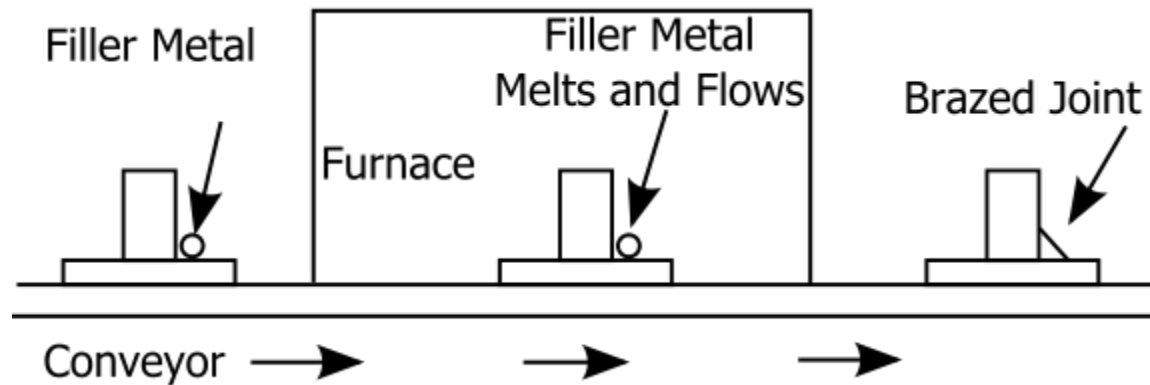

Furnace brazing schematic

Furnace brazing is a semi-automatic process used widely in industrial brazing operations due to its adaptability to mass production and use of unskilled labor. There are many advantages of furnace brazing over other heating methods that make it ideal for mass production. One main advantage is the ease with which it can produce large numbers of small parts that are easily jigged or self-locating. The process also offers the benefits of a controlled heat cycle (allowing use of parts that might distort under localized heating) and no need for post braze cleaning. Common atmospheres used include: inert, reducing or vacuum atmospheres all of which protect the part from oxidation. Some other advantages include: low unit cost when used in mass production, close temperature control, and the ability to braze multiple joints at once. Furnaces are typically heated using either electric, gas or oil depending on the type of furnace and application. However, some of the disadvantages of this method include: high capital equipment cost, more difficult design considerations and high power consumption.

There are four main types of furnaces used in brazing operations: batch type; continuous; retort with controlled atmosphere; and vacuum.

Batch type furnaces have relatively low initial equipment costs and heat each part load separately. It is capable of being turned on and off at will which reduces operating expenses when not in use. These furnaces are well suited to medium to large volume production and offer a large degree of flexibility in type of parts that can be brazed. Either controlled atmospheres or flux can be used to control oxidation and cleanliness of parts.

Continuous type furnaces are best suited to a steady flow of similar-sized parts through the furnace. These furnaces are often conveyor fed, allowing parts to be moved through the hot zone at a controlled speed. It is common to use either controlled atmosphere or pre-applied flux in continuous furnaces. In particular, these furnaces offer the benefit of very low manual labor requirements and so are best suited to large scale production operations.

Retort-type furnaces differ from other batch-type furnaces in that they make use of a sealed lining called a "retort". The retort is generally sealed with either a gasket or is welded shut and filled completely with the desired atmosphere and then heated externally by conventional heating elements. Due to the high temperatures involved, the retort usually made of heat resistant alloys that resist oxidation. Retort furnaces are often either used in a batch or semi-continuous versions.

Vacuum furnaces is a relatively economical method of oxide prevention and is most often used to braze materials with very stable oxides (aluminum, titanium and zirconium) that cannot be brazed in atmosphere furnaces. Vacuum brazing is also used heavily with refractory materials and other exotic alloy combinations unsuited to atmosphere furnaces. Due to the absence of flux or a reducing atmosphere, the part cleanliness is critical when brazing in a vacuum. The three main types of vacuum furnace are: single-wall hot retort, double-walled hot retort, and cold-wall retort. Typical vacuum levels for brazing range from pressures of 1.3 to 0.13 pascals (10^{-2} to 10^{-3} Torr) to 0.00013 Pa (10^{-6} Torr) or lower. Vacuum furnaces are most commonly batch-type, and they are suited to medium and high production volumes.

Silver brazing

Silver brazing, colloquially (however, incorrectly) known as a *silver soldering* or *hard soldering*, is brazing using a silver alloy based filler. These silver alloys consist of many different percentages of silver and other metals, such as copper, zinc and cadmium.

Brazing is widely used in the tool industry to fasten hardmetal (carbide, ceramics, cermet, and similar) tips to tools such as saw blades. "Pretinning" is often done: the braze alloy is melted onto the hardmetal tip, which is placed next to the steel and remelted. Pretinning gets around the problem that hardmetals are hard to wet.

Brazed hardmetal joints are typically two to seven mils thick. The braze alloy joins the materials and compensates for the difference in their expansion rates. In addition it provides a cushion between the hard carbide tip and the hard steel which softens impact and prevents tip loss and damage, much as the suspension on a vehicle helps prevent damage to both the tires and the vehicle. Finally the braze alloy joins the other two materials to create a composite structure, much as layers of wood and glue create plywood.

The standard for braze joint strength in many industries is a joint that is stronger than either base material, so that when under stress, one or other of the base materials fails before the joint.

One special silver brazing method is called *pinbrazing* or *pin brazing*. It has been developed especially for connecting cables to railway track or for cathodic protection installations. The method uses a silver- and flux-containing brazing pin which is melted down in the eye of a cable lug. The equipment is normally powered from batteries.

Braze welding

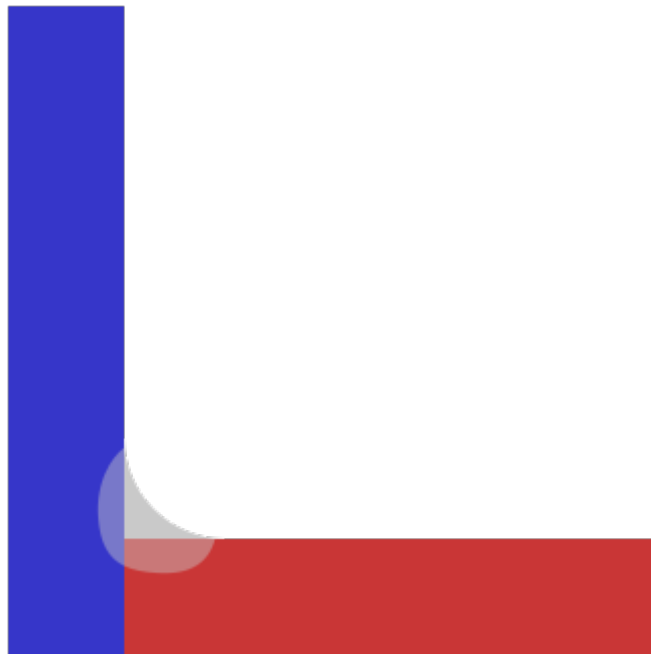

A braze-welded T-joint

Braze welding, also known as *fillet brazing*, is the use of a bronze or brass filler rod coated with flux to join steel workpieces. The equipment needed for braze welding is basically identical to the equipment used in brazing. Since braze welding usually requires more heat than brazing, acetylene or methylacetylene-propadiene (MPS) gas fuel is commonly used. The American Welding Society states that the name comes from the fact that no capillary action is used.

Braze welding has many advantages over fusion welding. It allows the joining of dissimilar metals, minimization of heat distortion, and can reduce the need for extensive pre-heating. Additionally, since the metals joined are not melted in the process, the components retain their original shape; edges and contours are not eroded or changed by the formation of a fillet. Another side effect of braze welding is the elimination of stored-up stresses that are often present in fusion welding. This is extremely important in the repair of large castings. The disadvantages are the loss of strength when subjected to high temperatures and the inability to withstand high stresses.

Carbide, cermet and ceramic tips are plated and then joined to steel to make tipped band saws. The plating acts as a braze alloy.

Cast iron "welding"

The "welding" of cast iron is usually a brazing operation, with a filler rod made chiefly of nickel being used although true welding with cast iron rods is also available. Ductile cast iron pipe may be also "cadwelded," a process which connects joints by means of a small copper wire fused into the iron when previously ground down to the bare metal, parallel to the iron joints being formed as per hub pipe with neoprene gasket seals. The purpose behind this operation is to use electricity along the copper for keeping underground pipes warm in cold climates.

Vacuum brazing

Vacuum brazing is a materials joining technique that offers significant advantages: extremely clean, superior, flux-free braze joints of high integrity and strength. The process can be expensive because it must be performed inside a vacuum chamber vessel. Temperature uniformity is maintained on the work piece when heating in a vacuum, greatly reducing residual stresses due to slow heating and cooling cycles. This, in turn, can significantly improve the thermal and mechanical properties of the material, thus providing unique heat treatment capabilities. One such capability is heat-treating or age-hardening the workpiece while performing a metal-joining process, all in a single furnace thermal cycle.

Vacuum brazing is often conducted in a furnace; this means that several joints can be made at once because the whole workpiece reaches the brazing temperature. The heat is transferred using radiation, as many other methods cannot be used in a vacuum.

Dip brazing

Dip brazing is especially suited for brazing aluminum because air is excluded, thus preventing the formation of oxides. The parts to be joined are fixtured and the brazing compound applied to the mating surfaces, typically in slurry form. Then the assemblies are dipped into a bath of molten salt (typically NaCl, KCl and other compounds) which functions both as heat transfer medium and flux.

Heating methods

There are many heating methods available to accomplish brazing operations. The most important factor in choosing a heating method is achieving efficient transfer of heat throughout the joint and doing so within the heat capacity of the individual base metals used. The geometry of the braze joint is also a crucial factor to consider, as is the rate and volume of production required. The easiest way to categorize brazing methods is to group them by heating method. Here are some of the most common:

- Torch brazing
- Furnace brazing
- Induction brazing

- Dip brazing
- Resistance brazing
- Infrared brazing
- Blanket brazing
- Electron beam and laser brazing
- Braze welding

Advantages and disadvantages

Brazing has many advantages over other metal-joining techniques, such as welding. Since brazing does not melt the base metal of the joint, it allows much tighter control over tolerances and produces a clean joint without the need for secondary finishing. Additionally, dissimilar metals and non-metals (i.e. metalized ceramics) can be brazed. In general, brazing also produces less thermal distortion than welding due to the uniform heating of a brazed piece. Complex and multi-part assemblies can be brazed cost-effectively. Another advantage is that the brazing can be coated or clad for protective purposes. Finally, brazing is easily adapted to mass production and it is easy to automate because the individual process parameters are less sensitive to variation.

One of the main disadvantages is: the lack of joint strength as compared to a welded joint due to the softer filler metals used. The strength of the brazed joint is likely to be less than that of the base metal(s) but greater than the filler metal. Another disadvantage is that brazed joints can be damaged under high service temperatures. Brazed joints require a high degree of base-metal cleanliness when done in an industrial setting. Some brazing applications require the use of adequate fluxing agents to control cleanliness. The joint color is often different than that of the base metal, creating an aesthetic disadvantage.

Some brazes come in the form of **trifolds**, laminated foils of a carrier metal clad with a layer of braze at each side. The center metal is often copper; its role is to act as a carrier for the alloy, to absorb mechanical stresses due to e.g. differential thermal expansion of dissimilar materials (e.g. a carbide tip and a steel holder), and to act as a diffusion barrier (e.g. to stop diffusion of aluminium from aluminium bronze to steel when brazing these two).

Braze families

Brazing alloys form several distinct groups; the alloys in the same group have similar properties and uses.

- **Pure metals:** Unalloyed. Often noble metals – silver, gold, palladium.
- **Ag-Cu:** Good melting properties. Silver enhances flow. Eutectic alloy used for furnace brazing. Copper-rich alloys prone to stress cracking by ammonia.

- **Ag-Zn:** Similar to Cu-Zn, used in jewelry due to high silver content to be compliant with hallmarking. Color matches silver. Resistant to ammonia-containing silver-cleaning fluids.
- **Cu-Zn (brass):** General purpose, used for joining steel and cast iron. Corrosion resistance usually inadequate for copper, silicon bronze, copper-nickel, and stainless steel. Reasonably ductile. High vapor pressure due to volatile zinc, unsuitable for furnace brazing. Copper-rich alloys prone to stress cracking by ammonia.
- **Ag-Cu-Zn:** Lower melting point than Ag-Cu for same Ag content. Combines advantages of Ag-Cu and Cu-Zn. At above 40% Zn the ductility and strength drop, so only lower-zinc alloys of this type are used. At above 25% zinc less ductile copper-zinc and silver-zinc phases appear. Copper content above 60% yields reduced strength and liquidus above 900 °C. Silver content above 85% yields reduced strength, high liquidus and high cost. Copper-rich alloys prone to stress cracking by ammonia. Silver-rich brazes (above 67.5% Ag) are hallmarkable and used in jewellery; alloys with lower silver content are used for engineering purposes. Alloys with copper-zinc ratio of about 60:40 contain the same phases as brass and match its color; they are used for joining brass. Small amount of nickel improves strength and corrosion resistance and promotes wetting of carbides. Addition of manganese together with nickel increases fracture toughness. Addition of cadmium yields **Ag-Cu-Zn-Cd** alloys with improved fluidity and wetting and lower melting point; however cadmium is toxic. Addition of tin can play mostly the same role.
- **Cu-P:** Widely used for copper and copper alloys. Does not require flux for copper. Can be also used with silver, tungsten, and molybdenum. Copper-rich alloys prone to stress cracking by ammonia.
- **Ag-Cu-P:** Like Cu-P, with improved flow. Better for larger gaps. More ductile, better electrical conductivity. Copper-rich alloys prone to stress cracking by ammonia.
- **Au-Ag:** Noble metals. Used in jewelry.
- **Au-Cu:** Continuous series of solid solutions. Readily wet many metals, including refractory ones. Narrow melting ranges, good fluidity. Frequently used in jewellery. Narrow melting range, excellent fluidity. Alloys with 40–90% of gold harden on cooling but stay ductile. Nickel improves ductility. Silver lowers melting point but worsens corrosion resistance; to maintain corrosion resistance gold has to be kept above 60%. High-temperature strength and corrosion resistance can be improved by further alloying, e.g. with chromium, palladium, manganese and molybdenum. Addition of vanadium allows wetting ceramics. Low vapor pressure.

- **Au-Ni:** Continuous series of solid solutions. Wider melting range than Au-Cu alloys but better corrosion resistance and improved wetting. Frequently alloyed with other metals to reduce proportion of gold while maintaining properties. Copper may be added to lower gold proportion, chromium to compensate for loss of corrosion resistance, and boron for improving wetting impaired by the chromium. Generally no more than 35% Ni is used, as higher Ni/Au ratios have too wide melting range. Low vapor pressure.
- **Au-Pd:** Improved corrosion resistance over Au-Cu and Au-Ni alloys. Used for joining superalloys and refractory metals for high-temperature applications, e.g. jet engines. Expensive. May be substituted for by cobalt-based brazes. Low vapor pressure.
- **Pd:** Good high-temperature performance, high corrosion resistance (less than gold), high strength (more than gold). usually alloyed with nickel, copper, or silver. Forms solid solutions with most metals, does not form brittle intermetallics. Low vapor pressure.
- **Ni:** Nickel alloys, even more numerous than silver alloys. High strength. Lower cost than silver alloys. Good high-temperature performance, good corrosion resistance in moderately aggressive environments. Often used for stainless steels and heat-resistant alloys. Embrittled with sulfur and some lower-melting point metals, e.g. zinc. Boron, phosphorus, silicon and carbon lower melting point and rapidly diffuse to base metals; this allows diffusion brazing and allows the joint to be used above the brazing temperature. Borides and phosphides form brittle phases; amorphous preforms can be made by rapid solidification.
- **Co:** Cobalt alloys. Good high-temperature corrosion resistance, possible alternative to Au-Pd brazes. Low workability at low temperatures, preforms prepared by rapid solidification.
- **Al-Si:** for brazing aluminium.
- **Active alloys:** Containing active metals, e.g. titanium or vanadium. Used for brazing non-metallic materials, e.g. graphite or ceramics.

Role of elements

- **Silver:** Enhances capillary flow, improves corrosion resistance of less-noble alloys, worsens corrosion resistance of gold and palladium. Relatively expensive. High vapor pressure, problematic in vacuum brazing. Wets copper. Does not wet nickel and iron. Reduces melting point of many alloys, including gold-copper.
- **Copper:** Good mechanical properties. Often used with silver. Dissolves and wets nickel. Somewhat dissolves and wets iron. Copper-rich alloys sensitive to stress cracking in presence of ammonia.

- **Zinc:** Lowers melting point. Often used with copper. Susceptible to corrosion. Improves wetting on ferrous metals and on nickel alloys. Compatible with aluminium. High vapor tension, produces somewhat toxic fumes, requires ventilation; highly volatile above 500 °C. At high temperatures may boil and create voids. Prone to selective leaching in some environments, which may cause joint failure. Traces of bismuth and beryllium together with tin or zinc in aluminium-based braze destabilize oxide film on aluminium, facilitating its wetting. High affinity to oxygen, promotes wetting of copper in air by reduction of the cuprous oxide surface film. Less such benefit in furnace brazing with controlled atmosphere. Embrittles nickel. High levels of zinc may result in a brittle alloy.
- **Aluminium:** Usual base for brazing aluminium and its alloys. Embrittles ferrous alloys.
- **Gold:** Excellent corrosion resistance. Very expensive. Wets most metals.
- **Palladium:** Excellent corrosion resistance, though less than gold. Higher mechanical strength than gold. Good high-temperature strength. Very expensive, though less than gold. Makes the joint less prone to fail due to intergranular penetration when brazing alloys of nickel, molybdenum, or tungsten. Increases high-temperature strength of gold-based alloys. Improves high-temperature strength and corrosion resistance of gold-copper alloys. Forms solid solutions with most engineering metals, does not form brittle intermetallics. High oxidation resistance at high temperatures, especially Pd-Ni alloys.
- **Cadmium:** Lowers melting point, improves fluidity. Toxic. Produces toxic fumes, requires ventilation. High affinity to oxygen, promotes wetting of copper in air by reduction of the cuprous oxide surface film. Less such benefit in furnace brazing with controlled atmosphere. Allows reducing silver content of Ag-Cu-Zn alloys. Replaced by tin in more modern alloys.
- **Lead:** Lowers melting point. Toxic. Produces toxic fumes, requires ventilation.
- **Tin:** Lowers melting point, improves fluidity. Broadens melting range. Can be used with copper, with which it forms bronze. Improves wetting of many difficult-to-wet metals, e.g. stainless steels and tungsten carbide. Traces of bismuth and beryllium together with tin or zinc in aluminium-based braze destabilize oxide film on aluminium, facilitating its wetting. Low solubility in zinc, which limits its content in zinc-bearing alloys.
- **Bismuth:** Lowers melting point. May disrupt surface oxides. Traces of bismuth and beryllium together with tin or zinc in aluminium-based braze destabilize oxide film on aluminium, facilitating its wetting.

- **Beryllium:** Traces of bismuth and beryllium together with tin or zinc in aluminium-based braze destabilize oxide film on aluminium, facilitating its wetting.
- **Nickel:** Strong, corrosion-resistant. Impedes flow of the melt. Addition to gold-copper alloys improves ductility and resistance to creep at high temperatures. Addition to silver allows wetting of silver-tungsten alloys and improves bond strength. Improves wetting of copper-based brazes. Improves ductility of gold-copper brazes. Improves mechanical properties and corrosion resistance of silver-copper-zinc brazes. Nickel content offsets brittleness induced by diffusion of aluminium when brazing aluminium-containing alloys, e.g. aluminium bronzes. In some alloys increases mechanical properties and corrosion resistance, by a combination of solid solution strengthening, grain refinement, and segregation on fillet surface and in grain boundaries, where it forms a corrosion-resistant layer. Extensive intersolubility with iron, chromium, manganese, and others; can severely erode such alloys. Embrittled by zinc, many other low melting point metals, and sulfur.
- **Chromium:** Corrosion-resistant. Increases high-temperature corrosion and strength of gold-based alloys. Added to copper and nickel to increase corrosion resistance of them and their alloys. Wets oxides, carbides, and graphite; frequently a major alloy component for high-temperature brazing of such materials. Impairs wetting by gold-nickel alloys, which can be compensated for by addition of boron.
- **Manganese:** High vapor pressure, unsuitable for vacuum brazing. In gold-based alloys increases ductility. Increases corrosion resistance of copper and nickel alloys. Improves high-temperature strength and corrosion resistance of gold-copper alloys. Higher manganese content may aggravate tendency to liquation. Manganese in some alloys may tend to cause porosity in fillets. Tends to react with graphite molds and jigs. Oxidizes easily, requires flux. Lowers melting point of high-copper brazes. Improves mechanical properties and corrosion resistance of silver-copper-zinc brazes. Cheap, even less expensive than zinc. Part of the Cu-Zn-Mn system is brittle, some ratios can not be used. In some alloys increases mechanical properties and corrosion resistance, by a combination of solid solution strengthening, grain refinement, and segregation on fillet surface and in grain boundaries, where it forms a corrosion-resistant layer. Facilitates wetting of cast iron due to its ability to dissolve carbon.
- **Molybdenum:** Increases high-temperature corrosion and strength of gold-based alloys. Increased ductility of gold-based alloys, promotes their wetting of refractory materials, namely carbides and graphite. When present in alloys being joined, may destabilize the surface oxide layer (by oxidizing and then volatilizing) and facilitate wetting.

- **Cobalt:** Good high-temperature properties and corrosion resistance. In nuclear applications can absorb neutrons and build up cobalt-60, a potent gamma radiation emitter.
- **Magnesium:** Addition to aluminium makes the alloy suitable for vacuum brazing. Volatile, though less than zinc. Vaporization promotes wetting by removing oxides from the surface, vapors act as getter for oxygen in the furnace atmosphere.
- **Indium:** Lowers melting point. Improves wetting of ferrous alloys by copper-silver alloys.
- **Carbon:** Lowers melting point. Can form carbides. Can diffuse to the base metal, resulting in higher remelt temperature, potentially allowing step-brazing with the same alloy. At above 0.1% worsens corrosion resistance of nickel alloys. Trace amounts present in stainless steel may facilitate reduction of surface chromium(III) oxide in vacuum and allow fluxless brazing. Diffusion away from the braze increases its remelt temperature; exploited in diffusion brazing.
- **Silicon:** Lowers melting point. Can form silicides. Improves wetting of copper-based brazes. Promotes flow. Causes intergranular embrittlement of nickel alloys. Rapidly diffuses into the base metals. Diffusion away from the braze increases its remelt temperature; exploited in diffusion brazing.
- **Germanium:** Lowers melting point. Expensive. For special applications. May create brittle phases.
- **Boron:** Lowers melting point. Can form hard and brittle borides. Unsuitable for nuclear reactors. Fast diffusion to the base metals. Can diffuse to the base metal, resulting in higher remelt temperature, potentially allowing step-brazing with the same alloy. Can erode some base materials or penetrate between grain boundaries of many heat-resistant structural alloys, degrading their mechanical properties. Has to be avoided in nuclear applications due to its interaction with neutrons. Causes intergranular embrittlement of nickel alloys. Improves wetting of/by some alloys, can be added to Au-Ni-Cr alloy to compensate for wetting loss by chromium addition. In low concentrations improves wetting and lowers melting point of nickel brazes. Rapidly diffuses to base materials, may lower their melting point; especially a concern when brazing thin materials. Diffusion away from the braze increases its remelt temperature; exploited in diffusion brazing.
- **Mischmetal**, in amount of about 0.08%, can be used to substitute boron where boron would have detrimental effects.
- **Cerium**, in trace quantities, improves fluidity of brazes. Particularly useful for alloys of four or more components, where the other additives compromise flow and spreading.

- **Strontium**, in trace quantities, refines the grain structure of aluminium-based alloys.

Deoxidizers

- **Phosphorus**: Lowers melting point. Deoxidizer, decomposes copper oxide; phosphorus-bearing alloys can be used on copper without flux. Does not decompose zinc oxide, so flux is needed for brass. Forms brittle phosphides with some metals, e.g. nickel (Ni_3P) and iron, phosphorus alloys unsuitable for brazing alloys bearing iron, nickel or cobalt in amount above 3%. The phosphides segregate at grain boundaries and cause intergranular embrittlement. (Sometimes the brittle joint is actually desired, though. Fragmentation grenades can be brazed with phosphorus bearing alloy to produce joints that shatter easily at detonation.) Avoid in environments with presence of sulfur dioxide (e.g. paper mills) and hydrogen sulfide (e.g. sewers, or close to volcanoes); the phosphorus-rich phase rapidly corrodes in presence of sulfur and the joint fails. Phosphorus can be also present as an impurity introduced from e.g. electroplating baths. In low concentrations improves wetting and lowers melting point of nickel brazes. Diffusion away from the braze increases its remelt temperature; exploited in diffusion brazing.
- **Lithium**: Deoxidizer. Eliminates the need for flux with some materials. Lithium oxide formed by reaction with the surface oxides is easily displaced by molten braze alloy.

Active metals

- **Titanium**: Most commonly used active metal. Few percents added to Ag-Cu alloys facilitate wetting of ceramics, e.g. silicon nitride. Most metals, except few (namely silver, copper and gold), form brittle phases with titanium. When brazing ceramics, like other active metals, titanium reacts with them and forms a complex layer on their surface, which in turn is wettable by the silver-copper braze. Wets oxides, carbides, and graphite; frequently a major alloy component for high-temperature brazing of such materials.
- **Zirconium**: Wets oxides, carbides, and graphite; frequently a major alloy component for high-temperature brazing of such materials.
- **Hafnium**
- **Vanadium**: Promotes wetting of alumina ceramics by gold-based alloys.
- **Aluminium**: Base component of most brazes for aluminium. Embrittles ferrous metals.

Impurities

- **Sulfur:** Compromises integrity of nickel alloys. Can enter the joints from residues of lubricants, grease or paint. Forms brittle nickel sulfide (Ni_3S_2) that segregates at grain boundaries and cause intergranular failure.

Some additives and impurities act at very low levels. Both positive and negative effects can be observed. Strontium at levels of 0.01% refines grain structure of aluminium. Beryllium and bismuth at similar levels help disrupt the passivation layer of aluminium oxide and promote wetting. Carbon at 0.1% impairs corrosion resistance of nickel alloys. Aluminium can embrittle mild steel at 0.001%, phosphorus at 0.01%.

In some cases, especially for vacuum brazing, high-purity metals and alloys are used. 99.99% and 99.999% purity levels are available commercially.

Care has to be taken to not introduce deleterious impurities from joint contaminations or by dissolution of the base metals during brazing.

Melting behavior

Alloys with larger span of solidus/liquidus temperatures tend to melt through a "mushy" state, where the alloy is a mixture of solid and liquid material. Some alloys show tendency to **liquation**, separation of the liquid from the solid portion; for these the heating through the melting range has to be sufficiently fast to avoid this effect. Some alloys show extended plastic range, when only a small portion of the alloy is liquid and most of the material melts at the upper temperature range; these are suitable for bridging large gaps and for forming fillets. Highly fluid alloys are suitable for penetrating deep into narrow gaps and for brazing tight joints with narrow tolerances but are not suitable for filling larger gaps. Alloys with wider melting range are less sensitive to non-uniform clearances.

When the brazing temperature is suitably high, brazing and heat treatment can be done in a single operation simultaneously.

Eutectic alloys melt at single temperature, without mushy region. Eutectic alloys have superior spreading; non-eutectics in the mushy region have high viscosity and at the same time attack the base metal, with correspondingly lower spreading force. Fine grain size gives eutectics both increased strength and increased ductility. Highly accurate melting temperature allows joining process to be performed only slightly above the alloy's melting point. On solidifying, there is no mushy state where the alloy appears solid but is not yet; the chance of disturbing the joint by manipulation in such state is reduced (assuming the alloy did not significantly change its properties by dissolving the base metal). Eutectic behavior is especially beneficial for solders.

Metals with fine grain structure before melting provide superior wetting to metals with large grains. Alloying additives (e.g. strontium to aluminium) can be added to refine

grain structure, and the preforms or foils can be prepared by rapid quenching. Very rapid quenching may provide amorphous metal structure, which possess further advantages.

Interaction with base metals

For successful wetting, the base metal has to be at least partially soluble in at least one component of the brazing alloy. The molten alloy therefore tends to attack the base metal and dissolve it, slightly change its composition in process. The composition change is reflected in the change of the alloy's melting point and the corresponding change of fluidity. For example, some alloys dissolve both silver and copper; dissolved silver lowers their melting point and increases fluidity, copper has the opposite effect.

The melting point change can be exploited. As the remelt temperature can be increased by enriching the alloy with dissolved base metal, step brazing using the same braze can be possible.

Alloys that do not significantly attack the base metals are more suitable for brazing thin sections.

Nonhomogenous microstructure of the braze may cause non-uniform melting and localized erosions of the base metal.

Wetting of base metals can be improved by adding a suitable metal to the alloy. Tin facilitates wetting of iron, nickel, and many other alloys. Copper wets ferrous metals that silver does not attack, copper-silver alloys can therefore braze steels silver alone won't wet. Zinc improves wetting of ferrous metals, indium as well. Aluminium improves wetting of aluminium alloys. For wetting of ceramics, reactive metals capable of forming chemical compounds with the ceramic (e.g. titanium, vanadium, zirconium...) can be added to the braze.

Dissolution of base metals can cause detrimental changes in the brazing alloy. For example, aluminium dissolved from aluminium bronzes can embrittle the braze; addition of nickel to the braze can offset this.

The effect works both ways; there can be detrimental interactions between the braze alloy and the base metal. Presence of phosphorus in the braze alloy leads to formation of brittle phosphides of iron and nickel, phosphorus-containing alloys are therefore unsuitable for brazing nickel and ferrous alloys. Boron tends to diffuse into the base metals, especially along the grain boundaries, and may form brittle borides. Carbon can negatively influence some steels.

Care has to be taken to avoid galvanic corrosion between the braze and the base metal, and especially between dissimilar base metals being brazed together.

Formation of brittle intermetallic compounds on the alloy interface can cause joint failure. This is discussed more in-depth with solders.

The potentially detrimental phases may be distributed evenly through the volume of the alloy, or be concentrated on the braze-base interface. A thick layer of interfacial intermetallics is usually considered detrimental due to its commonly low fracture toughness and other sub-par mechanical properties. In some situations, e.g. die attaching, it however does not matter much as silicon chips are not typically subjected to mechanical abuse.

On wetting, brazes may liberate elements from the base metal. For example, aluminium-silicon braze wets silicon nitride, dissociates the surface so it can react with silicon, and liberates nitrogen, which may create voids along the joint interface and lower its strength. Titanium-containing nickel-gold braze wets silicon nitride and reacts with its surface, forming titanium nitride and liberating silicon; silicon then forms brittle nickel silicides and eutectic gold-silicon phase; the resulting joint is weak and melts at much lower temperature than may be expected.

Metals may diffuse from one base alloy to the other one, causing embrittlement or corrosion. An example is diffusion of aluminium from aluminium bronze to a ferrous alloy when joining these. A diffusion barrier, e.g. a copper layer (e.g. in a trimet strip), can be used.

A sacrificial layer of a noble metal can be used on the base metal as an oxygen barrier, preventing formation of oxides and facilitating fluxless brazing. During brazing, the noble metal layer dissolves in the filler metal. Copper or nickel plating of stainless steels performs the same function.

In brazing copper, a reducing atmosphere (or even a reducing flame) may react with the oxygen residues in the metal, which are present as cuprous oxide inclusions, and cause hydrogen embrittlement. The hydrogen present in the flame or atmosphere at high temperature reacts with the oxide, yielding metallic copper and water vapour, steam. The steam bubbles exert high pressure in the metal structure, leading to cracks and joint porosity. Oxygen-free copper is not sensitive to this effect, however the most readily available grades, e.g. electrolytic copper or high-conductivity copper, are. The embrittled joint may then fail catastrophically without any previous sign of deformation or deterioration.

Chapter- 8

Rolling (metalworking)

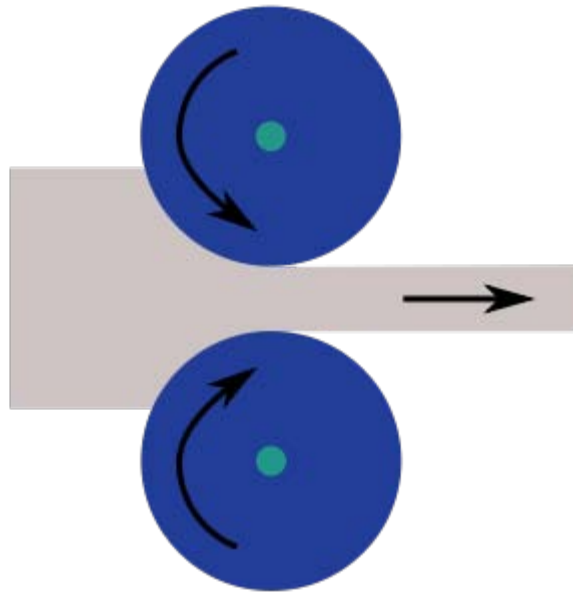

A rolling schematic

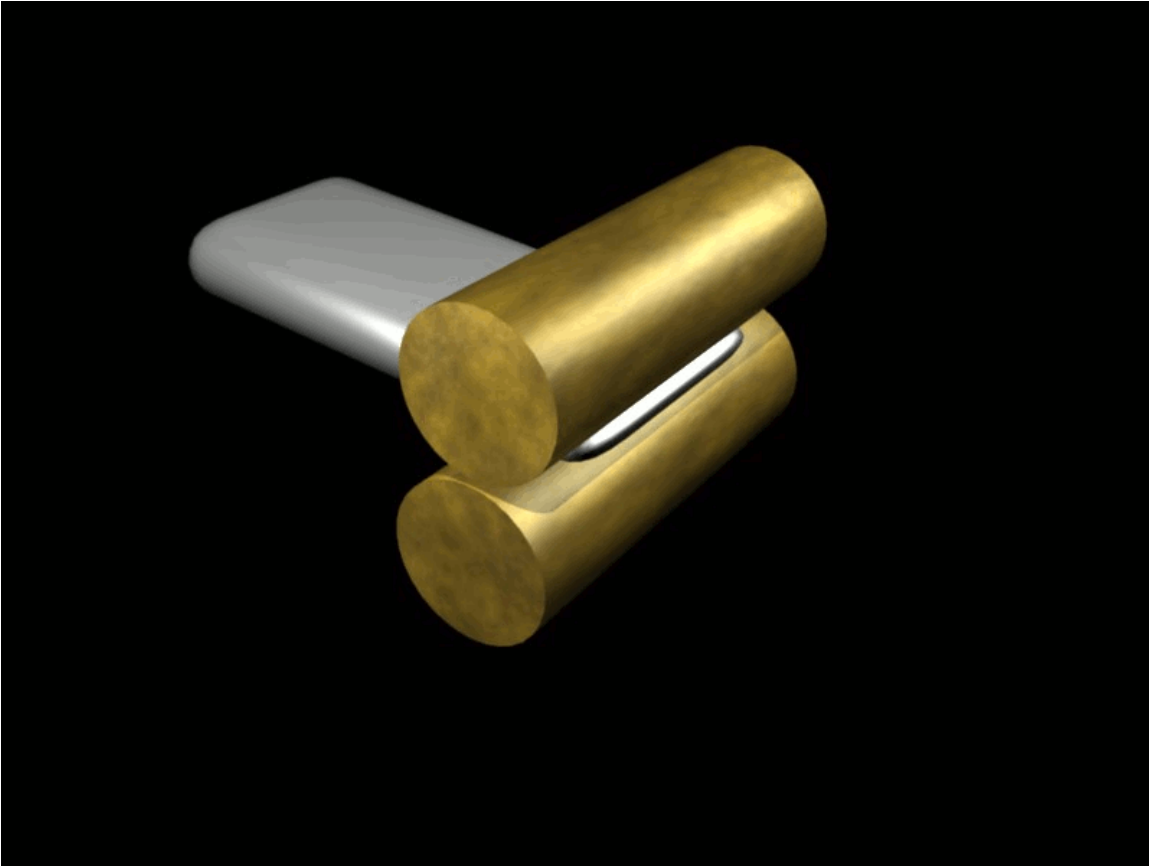

In metalworking, **rolling** is a metal forming process in which metal stock is passed through a pair of rolls. Rolling is classified according to the temperature of the metal rolled. If the temperature of the metal is above its recrystallization temperature, then the process is termed as **hot rolling**. If the temperature of the metal is below its recrystallization temperature, the process is termed as **cold rolling**. In terms of usage, hot rolling processes more tonnage than any other manufacturing process and cold rolling processes the most tonnage out of all cold working processes.

There are many types of rolling processes, including *flat rolling*, *foil rolling*, *ring rolling*, *roll bending*, *roll forming*, *profile rolling*, and *controlled rolling*.

Temperature

Hot rolling



A coil of hot-rolled steel

Hot rolling is a metalworking process that occurs above the recrystallization temperature of the material. After the grains deform during processing, they recrystallize, which maintains an equiaxed microstructure and prevents the metal from work hardening. The starting material is usually large pieces of metal, like semi-finished casting products, such as slabs, blooms, and billets. If these products came from a continuous casting operation the products are usually fed directly into the rolling mills at the proper temperature. In smaller operations the material starts at room temperature and must be heated. This is done in a gas- or oil-fired soaking pit for larger workpieces and for smaller workpieces induction heating is used. As the material is worked the temperature must be monitored to make sure it remains above the recrystallization temperature. To maintain a safety factor a *finishing temperature* is defined above the recrystallization temperature; this is usually 50 to 100 °C (122 to 212 °F) above the recrystallization temperature. If the temperature does drop below this temperature the material must be re-heated before more hot rolling.

Hot rolled metals generally have little directionality in their mechanical properties and deformation induced residual stresses. However, in certain instances non-metallic

inclusions will impart some directionality and workpieces less than 20 mm (0.79 in) thick often have some directional properties. Also, non-uniform cooling will induce a lot of residual stresses, which usually occurs in shapes that have a non-uniform cross-section, such as I-beams and H-beams. While the finished product is of good quality, the surface is covered in mill scale, which is an oxide that forms at high-temperatures. It is usually removed via pickling or the smooth clean surface process, which reveals a smooth surface. Dimensional tolerances are usually 2 to 5% of the overall dimension.

Hot rolling is used mainly to produce sheet metal or simple cross sections, such as rail tracks.

Cold rolling



A coil of cold-rolled steel

Cold rolling occurs with the metal below its recrystallization temperature (usually at room temperature), which increases the strength via strain hardening up to 20%. It also improves the surface finish and holds tighter tolerances. Commonly cold-rolled products include sheets, strips, bars, and rods; these products are usually smaller than the same products that are hot rolled. Because of the smaller size of the workpieces and their greater strength, as compared to hot rolled stock, four-high or cluster mills are used. Cold rolling cannot reduce the thickness of a workpiece as much as hot rolling in a single pass.

Cold-rolled sheets and strips come in various conditions: *full-hard*, *half-hard*, *quarter-hard*, and *skin-rolled*. Full-hard rolling reduces the thickness by 50%, while the others involve less of a reduction. Quarter-hard is defined by its ability to be bent back onto itself along the grain boundary without breaking. Half-hard can be bent 90°, while full-hard can only be bent 45°, with the bend radius approximately equal to the material thickness. Skin-rolling, also known as a *skin-pass*, involves the least amount of reduction: 0.5-1%. It is used to produce a smooth surface, a uniform thickness, and reduce the yield-point phenomenon (by preventing Luder bands from forming in later processing). It is also used to breakup the spangles in galvanized steel. Skin-rolled stock is usually used in subsequent cold-working processes where good ductility is required.

Other shapes can be cold-rolled if the cross-section is relatively uniform and the transverse dimension is relatively small; approximately less than 50 mm (2.0 in). This may be a cost-effective alternative to extruding or machining the profile if the volume is in the several tons or more. Cold rolling shapes requires a series of shaping operations, usually along the lines of: sizing, breakdown, roughing, semi-roughing, semi-finishing, and finishing.

Processes

Flat rolling

Flat rolling is the most basic form of rolling with the starting and ending material having a rectangular cross-section. The material is fed in between two *rollers*, called *working rolls*, that rotate in opposite directions. The gap between the two rolls is less than the thickness of the starting material, which causes it to deform. The decrease in material thickness causes the material to elongate. The friction at the interface between the material and the rolls causes the material to be pushed through. The amount of deformation possible in a single pass is limited by the friction between the rolls; if the change in thickness is too great the rolls just slip over the material and do not draw it in. The final product is either sheet or plate, with the former being less than 6 mm (0.24 in) thick and the latter greater than; however, heavy plates tend to be formed using a press, which is termed *forming*, rather than rolling.

Oftentimes the rolls are heated to assist in the workability of the metal. Lubrication is often used to keep the workpiece from sticking to the rolls. To fine tune the process the speed of the rolls and the temperature of the rollers are adjusted.

Foil rolling

Foil rolling is a specialized type of flat rolling, specifically used to produce foil, which is sheet metal with a thickness less than 200 µm (0.0079 in). The rolling is done in a *cluster mill* because the small thickness requires a small diameter rolls. To reduce the need for small rolls *pack rolling* is used, which rolls multiple sheets together to increase the effective starting thickness. As the foil sheets come through the rollers, they are trimmed and slitted with circular or razor-like knives. Trimming refers to the edges of the foil,

while slitting involves cutting it into several sheets. Aluminum foil is the most commonly produced product via pack rolling. This is evident from the two different surface finishes; the shiny side is on the roll side and the dull side is against the other sheet of foil.

Ring rolling

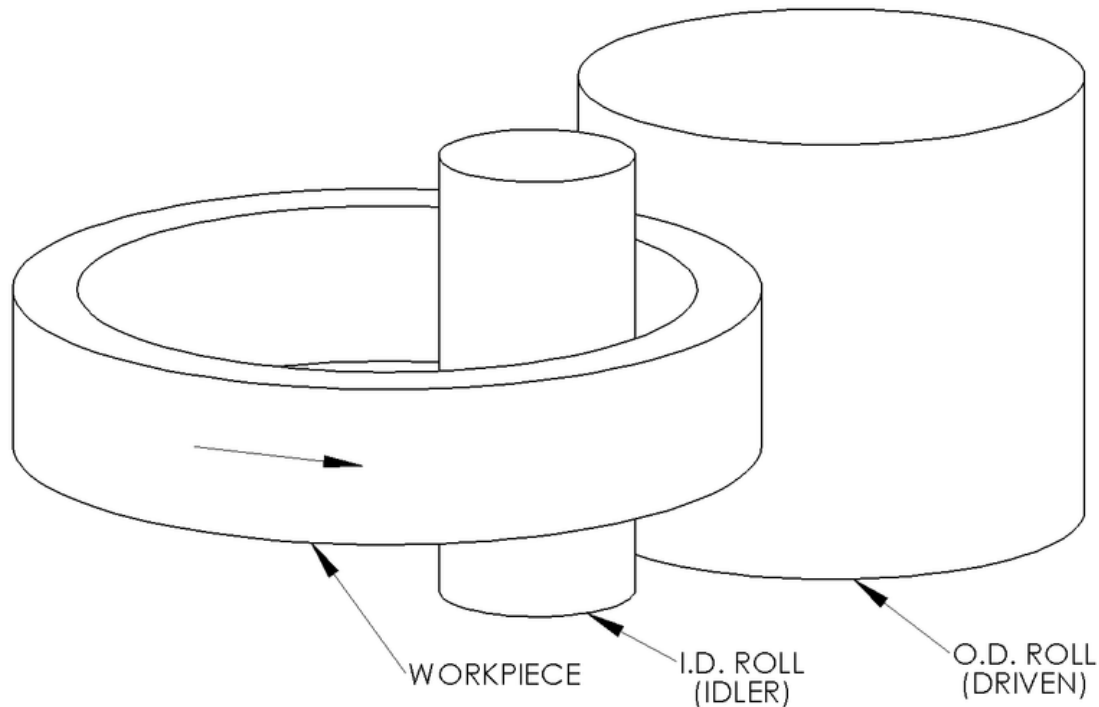

A schematic of ring rolling

Ring rolling is a specialized type of hot rolling that increases the diameter of a ring. The starting material is a thick-walled ring. This workpiece is placed on an *idler roll*, while another roll, called the *driven roll*, presses the ring from the outside. As the rolling occurs the wall thickness decreases as the diameter increases. The rolls may be shaped to form various cross-sectional shapes. The resulting grain structure is circumferential, which gives better mechanical properties. Diameters can be as large as 8 m (26 ft) and face heights as tall as 2 m (79 in). Common applications include rockets, turbines, airplanes, pipes, and pressure vessels.

Roll bending

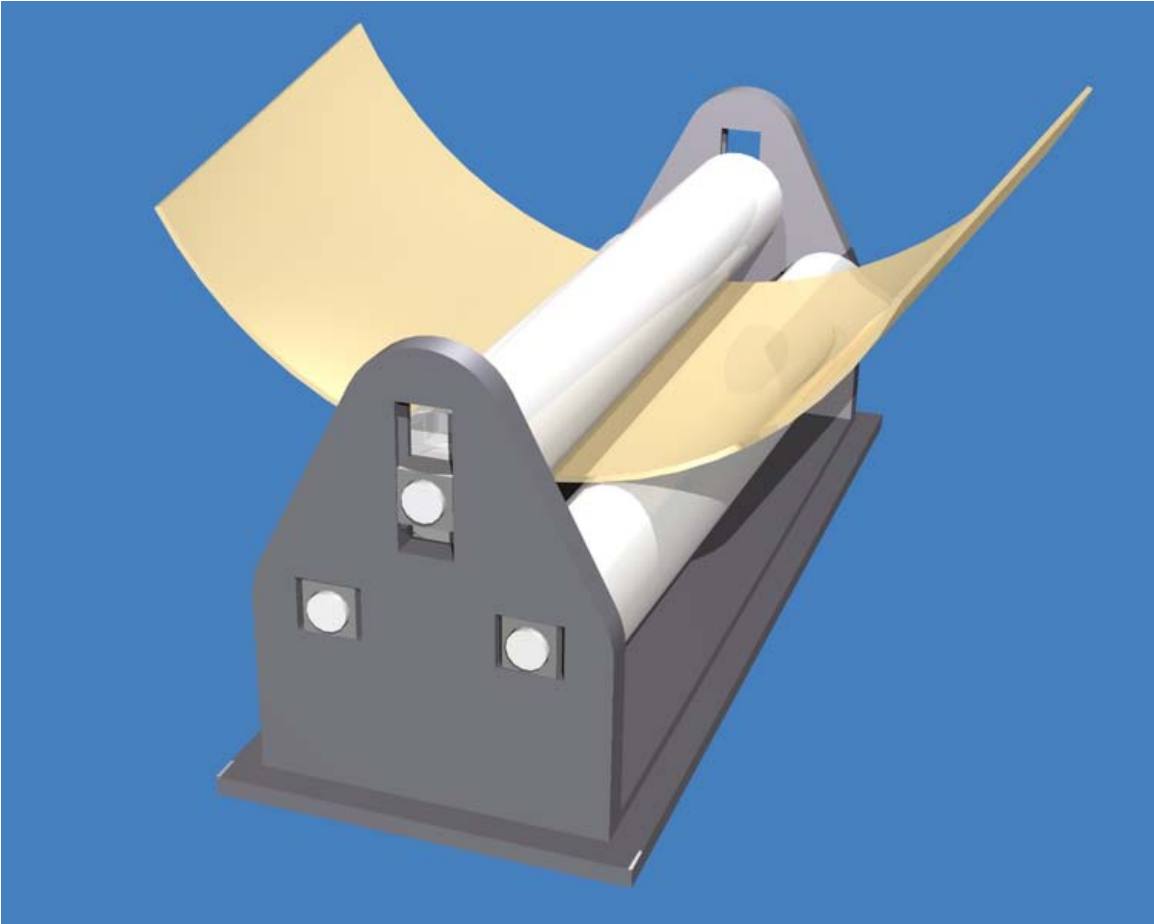

Roll bending

Roll bending produces a cylindrical shaped product from plate or steel metal.

Roll forming

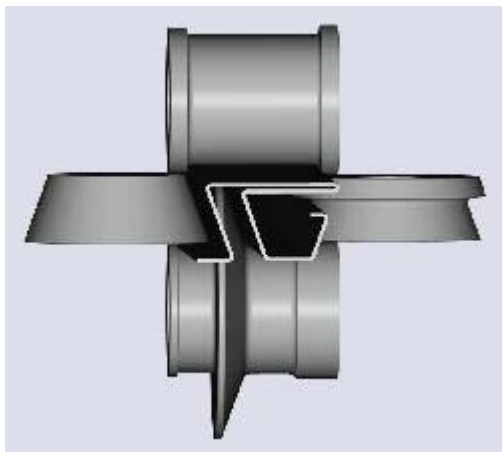

Roll forming

Roll forming is a continuous bending operation in which a long strip of metal (typically coiled steel) is passed through consecutive sets of rolls, or stands, each performing only an incremental part of the bend, until the desired cross-section profile is obtained. Roll forming is ideal for producing parts with long lengths or in large quantities.

Structural shape rolling



Cross-sections of continuously rolled structural shapes, showing the change induced by each rolling mill.

Controlled rolling

Controlled rolling is a type of thermomechanical processing which integrates controlled deformation and heat treating. The heat which brings the workpiece above the recrystallization temperature is also used to perform the heat treatments so that any subsequent heat treating is unnecessary. Types of heat treatments include the production of a fine grain structure; controlling the nature, size, and distribution of various transformation products (such as ferrite, austenite, pearlite, bainite, and martensite in steel); inducing precipitation hardening; and, controlling the toughness. In order to achieve this the entire process must be closely monitored and controlled. Common variables in controlled rolling include the starting material composition and structure, deformation levels, temperatures at various stages, and cool-down conditions. The benefits of controlled rolling include better mechanical properties and energy savings.

Mills

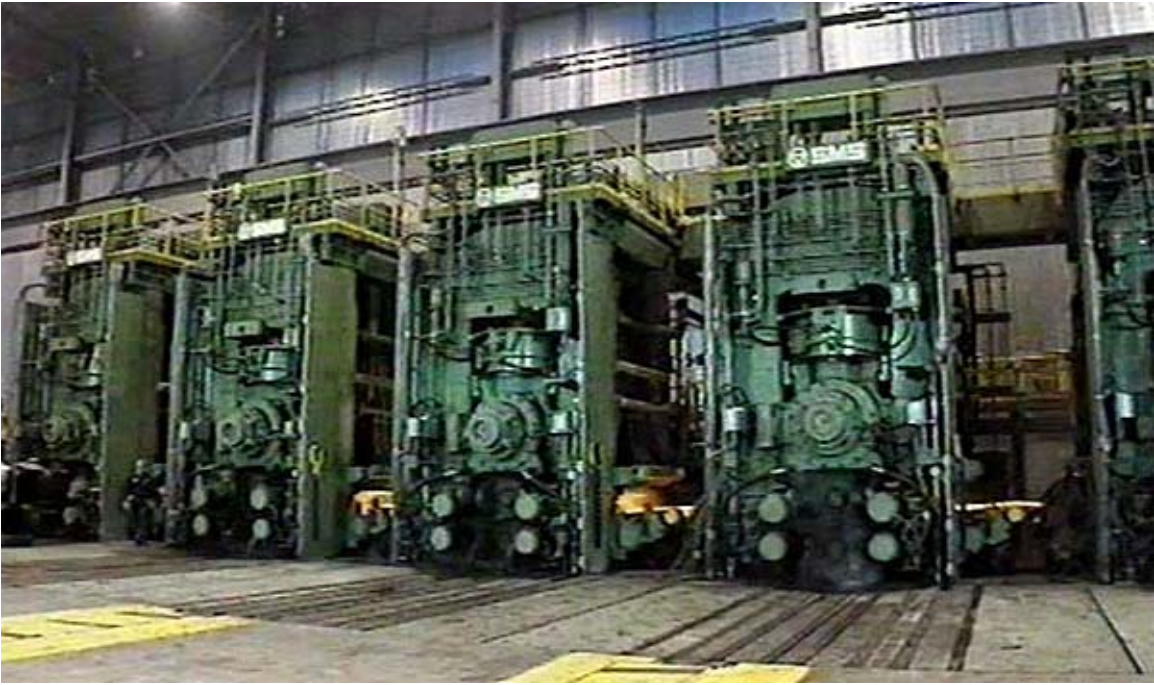

Rolling mills



Rolling mill for cold rolling metal sheet like this piece of brass sheet

A *rolling mill*, also known as a *reduction mill* or *mill*, has a common construction independent of the specific type of rolling being performed:

- Work rolls
- Backup rolls - are intended to provide rigid support required by the working rolls to prevent bending under the rolling load
- Rolling balance system - to ensure that the upper work and back up rolls are maintain in proper position relative to lower rolls
- Roll changing devices - use of an overhead crane and a unit designed to attach to the neck of the roll to be removed from or inserted into the mill.
- Mill protection devices - to ensure that forces applied to the backup roll chocks are not of such a magnitude to fracture the roll necks or damage the mill housing
- Roll cooling and lubrication systems

- Pinions - gears to divide power between the two spindles, rotating them at the same speed but in different directions
- Gearing - to establish desired rolling speed
- Drive motors - rolling narrow foil product to thousands of horsepower
- Electrical controls - constant and variable voltages applied to the motors
- Coilers and uncoilers - to unroll and roll up coils of metal

Slabs are the feed material for hot strip mills or plate mills and blooms are rolled to billets in a billet mill or large sections in a structural mill. The output from a strip mill is coiled and, subsequently, used as the feed for a cold rolling mill or used directly by fabricators. Billets, for re-rolling, are subsequently rolled in either a merchant, bar or rod mill. Merchant or bar mills produce a variety of shaped products such as angles, channels, beams, rounds (long or coiled) and hexagons.

Configurations

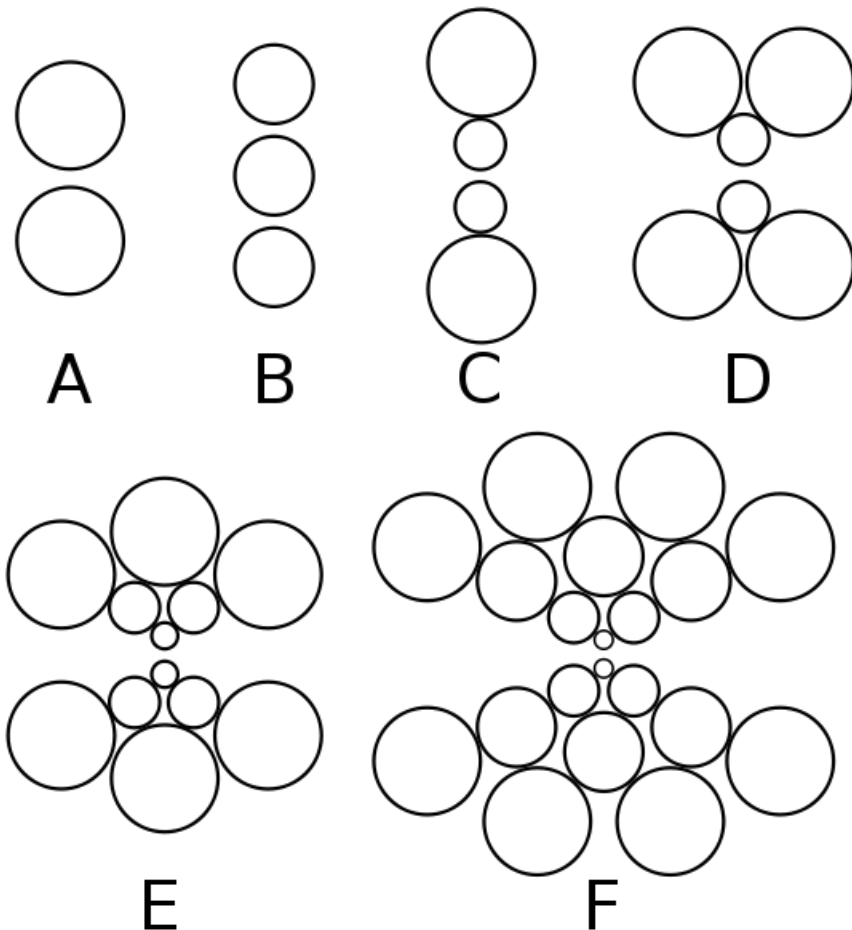

Various rolling configurations. Key: A. 2-high B. 3-high C. 4-high D. 6-high E&F. Cluster

Mills are designed in different types of configurations, with the most basic being a *two-high non-reversing*, which means there are two rolls that only turn in one direction. The *two-high reversing* mill has rolls that can rotate in both directions, but the disadvantage is that the rolls must be stopped, reversed, and then brought back up to rolling speed between each pass. To resolve this, the *three-high* mill was invented, which uses three rolls that rotate in one direction; the metal is fed through two of the rolls and then returned through the other pair. The disadvantage to this system is the workpiece must be lifted and lowered using an elevator. All of these mills are usually used for primary rolling and the roll diameters range from 60 to 140 cm (24 to 55 in).

To minimize the roll diameter a *four-high* or *cluster* mill is used. A small roll diameter is advantageous because less roll is in contact with the material, which results in a lower force and energy requirement. The problem with a small roll is a reduction of stiffness, which is overcome using *backup rolls*. These backup rolls are larger and contact the back side of the smaller rolls. A four-high mill has four rolls, two small and two large. A cluster mill has more than 4 rolls, usually in three tiers. These types of mills are commonly used to hot roll wide plates, most cold rolling applications, and to roll foils.

Historically mills were classified by the product produced:

- Blooming, cogging and slabbing mills, being the preparatory mills to rolling finished rails, shapes or plates, respectively. If reversing, they are from 34 to 48 inches in diameter, and if three-high, from 28 to 42 inches in diameter.
- Billet mills, three-high, rolls from 24 to 32 inches in diameter, used for the further reduction of blooms down to 1.5x1.5-inch billets, being the preparatory mills for the bar and rod
- Beam mills, three-high, rolls from 28 to 36 inches in diameter, for the production of heavy beams and channels 12 inches and over.
- Rail mills with rolls from 26 to 40 inches in diameter.
- Shape mills with rolls from 20 to 26 inches in diameter, for smaller sizes of beams and channels and other structural shapes.
- Merchant bar mills with rolls from 16 to 20 inches in diameter.
- Small merchant bar mills with finishing rolls from 8 to 16 inches in diameter, generally arranged with a larger size roughing stand.
- Rod and wire mills with finishing rolls from 8 to 12 inches in diameter, always arranged with larger size roughing stands.
- Hoop and cotton tie mills, similar to small merchant bar mills.
- Armour plate mills with rolls from 44 to 50 inches in diameter and 140 to 180-inch body.
- Plate mills with rolls from 28 to 44 inches in diameter.
- Sheet mills with rolls from 20 to 32 inches in diameter.
- Universal mills for the production of square-edged or so-called universal plates and various wide flanged shapes by a system of vertical and horizontal rolls.

Tandem mill

A tandem mill is a special type of modern rolling mill where rolling is done in one pass. In a traditional rolling mill rolling is done in several passes, but in tandem mill there are several *stands* and reductions take place successively. The number of stands ranges from 2 to 18. Tandem mill can be either hot or cold rolling mill type.

Defects

In hot rolling, if the temperature of the workpiece is not uniform the flow of the material will occur more in the warmer parts and less in the cooler. If the temperature difference is great enough cracking and tearing can occur.

Flatness

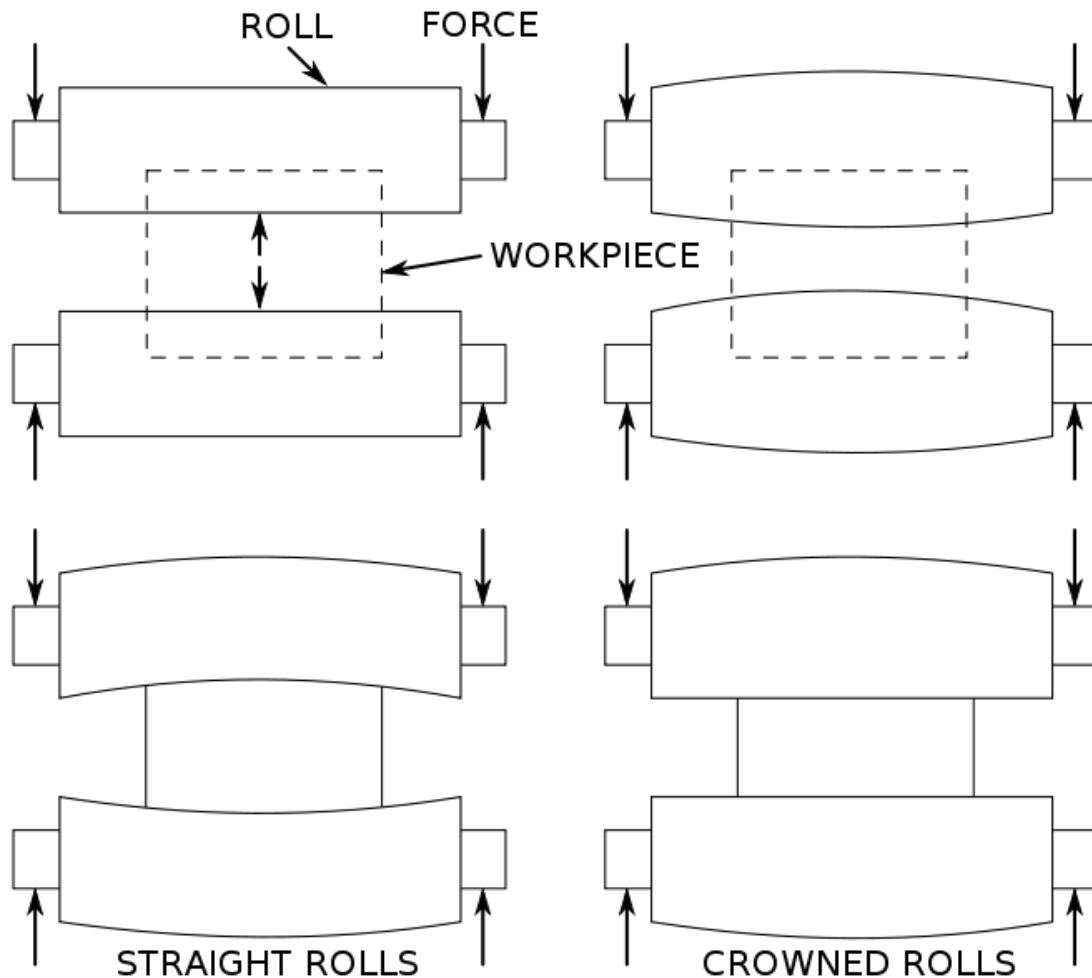

Roll deflection

Maintaining a uniform gap between the rolls is difficult because the rolls deflect under the load required to deform the workpiece. The deflection causes the workpiece to be

thinner on the edges and thicker in the middle. This can be overcome by using a crowned roller, however the crowned roller will only compensate for one set of conditions, specifically the material, temperature, and amount of deformation. If the flatness defect is great enough the edges will become wavy or the center may produce fractures.

Another way to overcome deflection issues is by decreasing the load on the rolls, which can be done by applying an longitudinal force; this is essentially drawing. Other methods of decreasing roll deflection include increasing the elastic modulus of the roll material and adding back-up supports to the rolls.

Surface defects

There are six types of surface defects:

Lap

This type of defect occurs when a corner or fin is folded over and rolled but not welded into the metal. They appear as seams across the surface of the metal.

Mill-shearing

These defects occur as a feather like lap.

Rolled-in scale

This occurs when mill scale is rolled into metal.

Scabs

These are long patches of loose metal that have been rolled into the surface of the metal.

Seams

They are open, broken lines that run along the length of the metal and caused by the presence of scale.

Slivers

Prominent surface ruptures.

History

Iron and steel

The earliest rolling mills were slitting mills, which were introduced from what is now Belgium to England in 1590. These passed flat bars between rolls to form a plate of iron, which was then passed between grooved rolls (slitters) to produce rods of iron. The first experiments at rolling iron for tinplate took place about 1670. In 1697, Major John Hanbury erected a mill at Pontypool to roll 'Pontypool plates'—blackplate. Later this began to be rerolled and tinned to make tinplate. The earlier production of plate iron in Europe had been in forges, not rolling mills.

The slitting mill was adapted to producing hoops (for barrels) and iron with a half-round or other sections by means that were the subject of two patents of c. 1679.

Some of the earliest literature on rolling mills can be traced back to Christopher Polhem in 1761 in *Patriotista Testamente*, where he mentions rolling mills for both plate and bar iron. He also explains how rolling mills can save on time and labor because a rolling mill can produce 10 to 20 and still more bars at the same time which is wanted to tilt only one bar with a hammer.

A patent was granted to Thomas Blockley of England in 1759 for the polishing and rolling of metals. Another patent was granted in 1766 to Richard Ford of England for the first tandem mill. A tandem mill is one in which the metal is rolled in successive stands; Ford's tandem mill was for hot rolling of wire rods.

Other metals

Rolling mills for lead seem to have existed by the late 17th century. Copper and brass were also rolled by the late 18th century.

Modern rolling

The modern rolling practice can be contributed to the efforts of Henry Cort of Fontley Iron Mills, near Fareham, England. In 1783 a patent was issued to Henry Cort for his use of grooved rolls for rolling iron bars. With this new design mills were able to produce 15 times the output per day than with a hammer. Although Cort was not the first to use grooved rolls; he was the first to combine the use of all the best features of various ironmaking and shaping processes known at the time. Thus the term "father of modern rolling" was giving to him by modern writers.

The first rail rolling mill was established by John Birkenshaw in 1820 where he produced fish bellied wrought iron rails in lengths of 15 to 18 feet. With the advancement of technology in rolling mills the size of rolling mills grew rapidly along with the size products being rolled. Example of this was at The Great Exhibition in 1851 a plate 20 feet long, 3 ½ feet wide, and 7/16 of inch thick, weighed 1,125 pounds was exhibited by the Consett Iron Company. Further evolution of the rolling mill came with the introduction of Three-high mills in 1853 used for rolling heavy sections.

Chapter- 9

Jewelry Making

Handmade jewelry



A bead crochet necklace made from crochet lace, sterling silver, and freshwater pearls

Handmade jewelry is jewelry which has been assembled and formed by hand rather than through the use of machines. According to the guidelines of the FTC, in order to be stamped or called "handmade" the work must be made solely by hand power or hand guidance. This means that jewelry may be made using drills, lathes, or other machinery, but it must be guided by human hand. This precludes the use of punch presses, CNC machinery and casting to name a few processes that would not qualify as "handmade". Beyond that caveat it can be anything made out of anything that would be considered jewelry. The American Gem Trade Association Spectrum awards, the Gem Center Idar Oberstein, and the De Beers Awards include awards for handmade jewelry.

Jewellery cleaning

Jewelry cleaning is the practice of removing dirt from jewelry to improve its appearance.

Methods and risks

Maintaining a clean diamond can sometimes be difficult, as jewelry settings can obstruct cleaning efforts, and oils, grease, and other hydrophobic materials adhere well to a diamond's surface. Some jewelers provide their customers with sudsy ammonia cleaning kits. Many jewelers use steam cleaners. Some other jewelers sell small ultrasonic cleaners. Home-based cleaning methods include immersing the diamond in ammonia-based or ethyl alcohol-based solutions, or even a solution of mild grease dissolving detergent and warm water. Silver jewelry can be cleaned using aluminum foil, baking soda, and hot water. However, this practice is not recommended by most jewelers. ----

Certain types of cleaning can damage some jewelry. For example, some class rings are coated with a dark pigment to reduce their shininess. Some gemstones, such as white topaz, have an overlay to produce certain colors. Ultrasonic cleaning can remove this coating, if it is not a quality piece. Ultrasonic cleaning is also contraindicated for opals, pearls and amber, and any other gemstone that is porous. Gemstones that are glued in (a common practice with semiprecious stones in non-precious methods, and in class rings) should not be placed into an ultrasonic cleaner. An ultrasonic cleaner can cause stones that are loose in their settings to come out. Jewelry should always be examined for overlays and loose stones prior to cleaning with an ultrasonic cleaner or a steam cleaner.

Jewelry Care

There are a number of things owners can do to prevent build up of dirt and prevent jewelry from becoming tarnished. Namely, store jewelry carefully in its original packaging or a jewelry box. Clean jewelry using warm water, mild soap and a soft bristle toothbrush. Use a non-abrasive silver cloth or soft lint free cloth to polish jewelry and remove tarnishing. Don't expose jewelry to harsh chemicals or perfumes as this could

cause damage and discoloration. Don't wear jewelry when using household cleansers. Also try to avoid sweating while wearing jewelry as this will result in a grimy buildup. Try to avoid spraying jewelry with beauty products such as hair spray, cosmetics or perfume as this can tarnish or discolor the jewelry.

Bangles, earrings (particularly those manufactured from hollow tubing) and chains should be worn with care in order to avoid surface damage, and should be removed before going to bed. Check for signs of wear and tear regularly, especially on catches and joints. Stone settings can become loose over time, especially if they have been hit against a hard surface or snagged on clothing.

Ultrasonic jewelry cleaning

Ultrasonic cleaners are useful for jewelry cleaning and removing tarnish. they use ultrasound waves and chemicals combined to create bubbles that "cling" to the foreign particles such as dirt, oil, and unknown substances. The high frequency waves are sent out and pull the contaminants off of the object. the bubbles collapse after they attach to the contaminants and move to the surface of the chemical solution creating what appears to be a boiling solution.

Beauty of gems

Although it is not one of the 4 Cs, cleanliness affects a diamond's beauty as much as any of the 4 C's (cut, carat, color, clarity).

A clean diamond is more brilliant and fiery than the same diamond when it is "dirty". Dirt or grease on the top of a diamond reduces its luster. Water, dirt, or grease on the bottom of a diamond interferes with the diamond's brilliance and fire. Even a thin film absorbs some light that could have been reflected to the person looking at the diamond.

Colored dye or smudges can affect the perceived color of a gem. Historically, some jewelers' diamonds were misgraded due to smudges on the girdle, or dye on the culet. Current practice is to thoroughly clean a gem before grading its color as well as clarity.

Cleanliness does not affect the jewelry's market value, as jewelers routinely clean jewellery before offering it for sale. However, cleanliness might reflect the jewelry's sentimental value.

Basse-taille



The Royal Gold Cup, 23.6 cm high, 17.8 cm across at its widest point; weight 1.935 kg.
British Museum

Basse-taille (baiss-taille) is an enamelling technique in which the artist creates a low-relief pattern in metal, usually silver or gold, by engraving or chasing. The entire pattern is created in such a way that its highest point is lower than the surrounding metal. A translucent enamel is then applied to the metal, allowing light to reflect from the relief and creating an artistic effect.

Medieval examples

The technique had been known to the Ancient Romans, but was lost at the end of the Middle Ages until the 17th century. Translucent enamel is more fragile than opaque, and medieval survivals in good condition are very rare. Medieval examples begin in Italy in the 13th century, and spread to other centres for high-quality courtly work, at a time when the *champlevé* enamels associated above all with Limoges had become almost mass-produced and relatively cheap. It is generally agreed that the late 14th century Royal Gold Cup, now in the British Museum, is the outstanding surviving example of *basse taille* enamel. It is one of only four known survivals done on gold, including both secular or religious pieces; another is the small Salting Reliquary, also in the British Museum. The "King John Cup" in King's Lynn, of ca. 1340, silver-gilt with transparent enamel, is the best example of *basse-taille* work probably made in England; the metalwork expert Herbert Maryon describes this and the Royal Gold Cup as the "two examples of outstanding merit, unsurpassed in any collection". However it is unclear if most of the enamel at King's Lynn is original. The technique was rediscovered in the 17th century, but was not much practiced thereafter. In a variant of the technique, translucent enamel was applied over a *guilloché* machine-turned metal backing by Peter Carl Fabergé on the Faberge eggs and other pieces from the 1880's until the Russian Revolution, and this technique is still used, usually in a single colour.

Technique



A 14th century silver plaque in *basse-taille* with translucent enamels, with considerable losses, showing the prepared metal surfaces beneath, and the tinting with different colours.

The process for creating *basse-taille* enamel began by marking the outline of the design and the main internal outlines on the gold with a tool called a "tracer". Then the interior area was worked, either with chasing tools, hammering and punching rather than cutting, or with chisels, to form a shallow recess to hold the enamel. The more important parts of the design were modelled by varying the depth of the surface to produce different intensities of colour when the translucent enamel was added; for example in the Royal Gold Cup the gold under folds of drapery often rises near the surface to create a paler highlight. In the example illustrated with Luke's ox the lowest lobe shows tufts of grass formed by cutting deeper into the background. In many of the recessed areas further

decoration was added by either engraving or punching which would show through the translucent enamel, or to facet the background so the reflections change as the viewing angle changes slightly. Most background areas to the enamelled scenes were decorated in the same way. Finally the surfaces were cleaned up, made good and polished, perhaps including scraping off any bumps showing through on the reverse of the metal.



Medallion of the Death of the Virgin, with damaged *basse-taille* enamel

The enamel lies flush with the gold surfaces; it was a preparation of finely ground glass paste applied with great care to the prepared recessed areas, and then fired. When different colours of enamel meet each other with a neat boundary, this was achieved by firing one colour with a retaining border of gum tragacanth before adding the next. The difficulty was often increased by the application of tints of a different colour to a base shade of enamel before firing, so that the added colour blends gradually into the background colour around the edges of the tinted area. This is especially used on "flux", or colourless enamel, as in the ground areas, rocks and trees. In the Royal Gold Cup flux was also used for flesh areas as on a gold background it darkens slightly when hard to a

suitable colour for skin. The *rouge clair* or "ruby glass" red, used so effectively here, was made by adding tiny particles of copper, silver and gold to the glass; here scientific tests have shown that copper was used. After firing the enamel was polished flush with the surrounding metal, which was presumably decorated last.

Filigree



sterling Horse and Buggy, Filigree work



Sterling Dish, Filigree work

Filigree (formerly written *filigrann* or *filigrane*) is a delicate kind of jewel work made with twisted threads usually of gold and silver or stitching of the same curving motifs. It often suggests lace, and in recent centuries remains popular in Indian and other Asian metalwork, and French from 1660 to the late 19th century. It should not be confused with ajoure jewellery work; while both have many open areas, filigree involves threads being soldered together to form an object and ajoure involves holes being punched, drilled, or cut through an existing piece of metal.

The word, often thought derived from the Latin *filum*, thread, and *granum*, grain, is not found in Du Cange, and is indeed of modern origin. According to Prof. Skeat it derives from the Spanish *filigrana*, from "filar", to spin, and *grano*, the grain or principal fibre of the material.

History

Though filigree has become a special branch of jewel work in modern times, it was historically part of the ordinary work of the jeweler. A. Castellani states, in his "Memoir on the Jewellery of the Ancients" (1861), that all the jewelry of the Etruscans and Greeks (other than that intended for the grave, and therefore of an unsubstantial character) was

made by soldering together and so building up the gold rather than by chiselling or engraving the material.

Ancient work

The Egyptian jewelers employed wire, both to lay down on a background and to plait or otherwise arranged. But, with the exception of chains, it cannot be said that filigree work was much practiced by them. Their strength lay rather in their cloisonné work and their molded ornaments. Many examples, however, remain of round plaited gold chains of fine wire, such as are still made by the filigree workers of India, and known as trichinopoly chains. From some of these are hung smaller chains of finer wire with minute fishes and other pendants fastened to them.

In ornaments derived from Phoenician sites, such as Cyprus and Sardinia, patterns of gold wire are laid down with great delicacy on a gold ground, but the art was advanced to its highest perfection in the Greek and Etruscan filigree of the 6th to the 3rd centuries BC. A number of earrings and other personal ornaments found in central Italy are preserved in the Louvre and in the British Museum. Almost all of them are made of filigree work. Some earrings are in the form of flowers of geometric design, bordered by one or more rims each made up of minute volutes of gold wire, and this kind of ornament is varied by slight differences in the way of disposing the number or arrangement of the volutes. But the feathers and petals of modern Italian filigree are not seen in these ancient designs. Instances occur, but only rarely, in which filigree devices in wire are self-supporting and not applied to metal plates.

The museum of the Hermitage at Saint Petersburg contains an amazingly rich collection of Scythian jewelry from the tombs of the Crimea. Many bracelets and necklaces in that collection are made of twisted wire, some in as many as seven rows of plaiting, with clasps in the shape of heads of animals of beaten work. Others are strings of large beads of gold, decorated with volutes, knots and other patterns of wire soldered over the surfaces. In the British Museum a sceptre, probably that of a Greek priestess, is covered with plaited and netted gold wire, finished with a sort of Corinthian capital and a boss of green glass.

Asia

It is probable that in India and various parts of central Asia filigree has been worked from the most remote period without any change in the designs. Whether the Asiatic jewellers were influenced by the Greeks who settled on that continent, or merely trained under traditions held in common with them, it is certain that the Indian filigree workers retain the same patterns as those of the ancient Greeks and work them in the same way, down to the present day. Wandering workmen are given so much gold, coined or rough, which is weighed, heated in a pan of charcoal, beaten into wire, and then worked in the courtyard or verandah of the employer's house according to the designs of the artist, who weighs the complete work on restoring it and is paid at a specified rate for his labour. Very fine

grains or beads and spines of gold, scarcely thicker than coarse hair, projecting from plates of gold are methods of ornamentation still used.

Calcutta is a famous place for filigri work, traditionally known as Calcutti Work. Cuttack in the eastern India state of Orissa, is also famous for its filigree work. Due to lack of patronage and modern design ideas this is a dying art. Most filigree work revolve around images of Gods and Goddesses.

Medieval Europe

Passing to later times we may notice in many collections of medieval jewel work reliquaries, covers for Gospel books, etc., made either in Constantinople from the 6th to the 12th centuries, or in monasteries in Europe, in which studied and imitated Byzantine goldsmiths' work. These objects, besides being enriched with precious stones, polished, but not cut into facets, and with enamels, are often decorated with filigree. Large surfaces of gold are sometimes covered with scrolls of filigree soldered on; and corner pieces of the borders of book covers, or the panels of reliquaries, are frequently made up of complicated pieces of plaited work alternating with spaces encrusted with enamel. Byzantine filigree work occasionally has small stones set amongst the curves or knots. Examples of such decoration can be seen in the Victoria and Albert, and British Museums. Examples include the Cross of Lothair in Aachen.

In the north of Europe the Saxons, Britons and Celts were from an early period skillful in several kinds of goldsmiths' work. Admirable examples of filigree patterns laid down in wire on gold, from Anglo-Saxon tombs, may be seen in the British Museum notably a brooch from Dover, and a sword-hilt from Cumberland. The Staffordshire Hoard of Anglo-Saxon gold and silver (estimated 700 CE) discovered in a field in Staffordshire, England, on 5 July 2009 contains numerous examples of very fine filigree described by Archaeologist Dr Kevin Leahy as "incredible".

Irish filigree work of the Insular period is more thoughtful in design and more extremely varied in pattern. The Royal Irish Academy in Dublin contains a number of reliquaries and personal jewels, of which filigree is the general and most remarkable ornament. The Tara brooch has been copied and imitated, and the shape and decoration of it are well known. Instead of fine curls or volutes of gold thread, the Irish filigree is varied by numerous designs by which one thread can be traced through curious knots and complications, which, disposed over large surfaces, balance one another, but always with special varieties and arrangements difficult to trace with the eye. The long thread appears and disappears without breach of continuity, the two ends generally worked into the head and the tail of a serpent or a monster.

The reliquary containing the "Bell of Saint Patrick" is covered with knotted work in many varieties. A two-handled chalice, called the "Ardagh Chalice" found near Limerick in 1868, is ornamented with work of this kind of extraordinary fineness. Twelve plaques on a band round the body of the vase, plaques on each handle and round the foot of the vase

have a series of different designs of characteristic patterns, in fine filigree wire work wrought on the front of the repousse ground.

Much of the medieval jewel work all over Europe down to the 15th century, on reliquaries, crosses, croziers and other ecclesiastical goldsmiths' work, is set off with bosses and borders of filigree. Filigree work in silver was practised by the Moors of Spain during the Middle Ages with great skill, and was introduced by them and established all over the Peninsula, whence it was carried to the Spanish colonies in America. The Spanish filigree work of the 17th and 18th centuries is of extraordinary complexity, and silver filigree jewelry of delicate and artistic design is still made in considerable quantities throughout the country.

The manufacture spread over the Balearic Islands, and among the populations that border the Mediterranean. It is still made all over Italy, and in Portugal, Malta, Macedonia, Albania, the Ionian Islands and many other parts of Greece. That of the Greeks is sometimes on a large scale, with several thicknesses of wires alternating with larger and smaller bosses and beads, sometimes set with turquoises, etc., and mounted on convex plates, making rich ornamental headpieces, belts and breast ornaments. Filigree silver buttons of wire-work and small bosses are worn by the peasants in most of the countries that produce this kind of jewelry.

Silver filigree brooches and buttons are also made in Denmark, Norway and Sweden. Little chains and pendants are added to much of this northern work.

Some very curious filigree work was brought to Great-Britain from Abyssinia after the Battle of Magdala : arm-guards, slippers, cups, etc., some of which are now in the Victoria and Albert Museum. They are made of thin plates of silver, over which the wire-work is soldered. The filigree is subdivided by narrow borders of simple pattern, and the intervening spaces are made up of many patterns, some with grains set at intervals.

Uses

The art may be said to consist in curling, twisting and plaiting fine pliable threads of metal, and uniting them at their points of contact with each other, and with the ground, by means of gold or silver solder and borax, by the help of the blowpipe. Small grains or beads of the same metals are often set in the eyes of volutes, on the junctions, or at intervals at which they will set off the wire-work effectively. The more delicate work is generally protected by framework of stouter wire.

Brooches, crosses, earrings, buttons and other personal ornaments of modern filigree are generally surrounded and subdivided by bands of square or flat metal, giving consistency to the filling up, which would not otherwise keep its proper shape.

Filigree jewelry design, and its twisting and soldering techniques, have an application in other metal-work such as wrought iron hanging wall brackets and silertoned doors.

For examples of antique work the student should examine the gold ornament rooms of the British Museum, the Louvre and the collection in the Victoria and Albert Museum. The last contains a large and very varied assortment of modern Italian, Spanish, Greek and other jewelry made for the peasants of various countries. It also possesses interesting examples of 19th century work in granulated gold by Castellani and Giuliano. Celtic work is well represented in the museums in Dublin and London.

Granulated work

Some writers of repute have laid equal stress on the glum and the granuna, and have extended the use of the term filigree to include the granulated work of the ancients, even where the twisted wire-work is entirely wanting. Such a wide application of the term is not approved by current usage, according to which the presence of the twisted threads is the predominant fact.

A few words must be added as to the granulated work, which some writers classify as filigree, though there may be no twisted wires. Such decoration consists of minute globules of gold, soldered to form patterns on a metal surface. Its use is rare in Egypt. It occurs in Cyprus at an early period, as for instance on a gold pendant in the British Museum from Enkomi in Cyprus (10th century BC). The pendant is in the form of a pomegranate, and has upon it a pattern of triangles, formed by more than 3000 minute globules separately soldered on. It also occurs on ornaments of the 7th century BC from Camirus in Rhodes. But these globules are large, compared with those found on Etruscan jewelry. Fortunato Pio Castellani, who had made the antique jewelry of the Etruscans and Greeks his special study, with the intention of reproducing the ancient models, found it for a long time impossible to revive this particular process of delicate soldering. He overcame the difficulty at last, by the discovery of a traditional school of craftsmen at St Angelo in Vado, by whose help his well-known reproductions were executed.

Chapter- 10

How to Price Your Jewelry Designs



Figuring out how to price your designs is not one of the more glamorous parts of running a successful jewelry design business. Pricing your designs can be tricky, especially if you design one of a kind pieces, but it is an essential step you must take to turn your hobby into a profitable business. Once you understand the costs of your business, and what you expect to profit from your work, creating a formula to price your designs is a simple process.

Steps

7. **Keep a "recipe book" to record exactly what was spent to create each design.** You will basically need to price each item used in your designs. For example, if you pay \$1.50 for a dozen sterling crimp beads, and you used 2 crimps beads in your design, you would divide \$1.50 by 12 (.13¢ per crimp bead), and so on, making it much easier to calculate the exact cost of each design. The more meticulous you are about calculating expenses, the better your pricing will be. Even the packing materials you use for the design and the shipping costs of the supplies should be accounted for. Keep receipts--this will also come in handy during tax time, if you want to deduct business expenses.
8. **Record your time spent on each design.** How quickly can you design and complete your jewelry? Second to quality, speed is a key factor in profitability. If it takes you 30 minutes to recreate a design, you would charge differently than a design that takes 4-5 hours to create. Write your time spent in your recipe book.
9. **Calculate the price.** Using a formula will give you a starting point, and you can tweak the price with the steps that follow. Which formula you use, however, will depend on whether you're selling retail (directly to customers) or wholesale (to stores, for example).
 - Retail - Take the total cost of your supplies, multiply it times 2.5 (some people multiply by 3) and there's your retail price. A spreadsheet is perfect for this step. Simply set up a table of products used, your cost, and then a formula to calculate the pricing using the 2.5 or other multiple. If your business has a physical storefront, you have to take into consideration that there are additional costs. Rent, employee pay, utilities, displays and fixtures, and property taxes all need to be considered in your pricing strategy. You may find that in your market, you may need to price at 3 to 5 times your cost of materials.
 - Wholesale - Multiply by 1.5 (some people multiply by 2) instead. You can charge less for your jewelry if you're selling wholesale because you spend less time marketing to individual customers and more time actually making jewelry (advertising, processing orders, maintaining a shopping cart website, maintaining a store, etc.). You should verify that your market can afford a higher price (usually times 2 to 2.5) than the price you arrive at, using the next few steps. Many jewelry designers find that selling wholesale allows them to achieve business growth and profitability. When you use the 1.5 factor, you are allowing room for shop owners to sell your designs and even offer sales and discounts on your designs, if a certain design doesn't sell quickly enough. This may sound like a lot, but make sure that you consider the amount of time and labor you put into developing and creating your pieces as well as the boutique owner's expenses.
10. **Adjust for the cost of your labor.** The difference between a hobby and a business is whether you get a paycheck, so decide how much you want to make per hour, and make sure that your labor is accounted for in the price. Let's say, for example, the cost of supplies for your design is \$10 and you calculate \$25 as your

retail price (using the 2.5 guideline). If you want to pay yourself \$10 per hour and you spent 2 hours on this design, then you really need to be charging at least \$30 for the piece (\$10 supplies, \$20 labor). There may be additional costs to consider, such as your storefront, or time spent marketing (e.g. creating a brochure).

- When deciding how much to pay yourself hourly, consider your experience. How long have you been designing jewelry? If you have a long track record, vast expertise, and a portfolio of unique designs, you may find that you can charge more. You may have particular advantages, including contacts and unique designs, that allow you to charge more.
- To repeat--just because you enjoy doing the work doesn't mean you shouldn't get paid for it! Make sure you're getting at least minimum wage.

11. Perform market research. Now that you have an idea of what you want to charge for a design, it's time to dip your toes in the market and see if the piece can be profitable. Generally, it's a good idea to start off with the highest price you think the market will bear, because you can always bring it down.

- Have people offered to buy any of your jewelry designs? This is a good indication of the marketability of your designs. If your coworkers fight over a necklace you made, that may be a good sign that there is a market for your design. Friends and coworkers are also good sounding boards for prices. Ask them how much they think your design is worth, and what they would pay for it.
- Examine past success. Have you already sold any of your jewelry? This is important too in that it gives you concrete information on how much you can sell a design for. You may hear from friends or coworkers that they would pay \$XX for a design, but an actual sale is real, concrete evidence.
- Has an experienced designer evaluated your work? Having the opinion of another designer can be valuable in determining the level of quality of your work, and what you can expect to get for it.

12. Re-evaluate the design. If you encountered feedback in the previous step which indicates that the price you arrived at isn't going to fly, you have some thinking to do about this design.

- If you do not find interest for a particular design, you may want to think of changing the design.
- Assess your materials. Do you design using sterling findings and semi-precious beads, or less expensive beads? Higher quality materials will always command a higher price in the market. You may want to consider making designs with both high quality materials, and less expensive materials. This will allow you to attract business from both the high end buyer, and the more budget minded buyer.
- Don't cut yourself short just to "break in" to the market (e.g. selling to customers at wholesale prices). This will only get people used to cheap prices, and it'll be difficult to raise them later on, jeopardizing your chances of ever making your business profitable. It's better to redesign or reject pieces that don't cover their costs as described above.
- It's better to redesign or reject pieces that don't cover their costs as described above. People are often suspicious of products sold at unusually

low prices; most of us have internalized the idea that 'you get what you pay for'. Cheap prices are often interpreted as cheap materials and workmanship. If your pieces aren't selling well, try raising your prices. It goes against our intuition, but you may be surprised at the results! After all, jewelry is a luxury and not a necessity.



Tips

- As you become more experienced, you'll find which prices cover your unique costs while still generating sales. For example, if you're doing a lot of beadwork and wirework where the supply cost is low but the time spent is high, and you're selling retail only through a website, the following could be a better formula:
 - $(\text{cost of materials} \times 2) + (\text{time spent on piece} \times \text{hourly rate})$
 - calculate 30% of the previous figure and add it to the previous figure to account for overhead
 - multiply the figure by 2 to get the retail price
- Some people use the tactic of setting a retail price just under a whole number (\$49.95 rather than \$50) to make the price look less intimidating. This may be more suitable for relatively inexpensive pieces but you should experiment to see how your customer base responds.

How to Make Metal Smooth

When you work with metal you will find that you cut yourself often. This will tell you how to keep yourself cut free. This method will take some time but it is definitely worth it.

Steps

5. **Start off by filing the edges of the metal until you are sure that you will not cut your fingers on it.**
6. **Take some rough sandpaper and spend a while making the sides as smooth as you can.** When you think they are at their smoothest, it is ready to move on.
7. **Then, take the rough sandpaper and smooth out the corners.**
8. **Take some 180 sandpaper and quickly finish it off.**

Tips

- A Dremel tool works great too.

Warnings

- Be careful of the metal's sharp edges when you get it.

Things You'll Need

- Metal
- File
- Rough sandpaper
- 180 sandpaper
- Bit of time

Chapter- 11

How to Choose Jewelry



Choosing your jewelry is no different than choosing your wardrobe. Most important is to stick within your comfort zone and your personal fashion style. That said, it never hurts to step out of the box once in awhile.

What's most important is that your jewelry matches up with your outfit. Your jewelry is the finishing touch on your total look. Make your fashion statement count!



Steps

1. **Determine what you want your jewelry to do.** Do you want it front and center stage? Do you want it to compliment? Do you want it subtle?
2. **Make certain your jewelry is appropriate for the occasion or event you'll be wearing it to.** A sexy oversized choker might be perfect for a night on the town but may not be fitting for the boardroom.
3. **Determine how long you want it to last and how often you plan to wear it.**
4. **Know how much money you want to spend.**
5. **If you can, try on the jewelry or hold it up next to you to determine whether it suits you.**



Tips

- Although you may have a favorite designer, there's really no need to stick with just one. In fact, there's no need for the pieces to actually be designer. There are plenty of wonderful pieces on the market that are unsigned but certainly make a fashion statement. Mix and match your jewelry to give it character and a little pizzazz!
- Costume Jewelry, both signed and unsigned, is an affordable way to complete your look. Costume Jewelry can be bought for a low price and has plenty of life. Heck, we see costume jewelry back to the 1920s still in excellent condition. What's great with costume jewelry is you can use it, get tired of it, put it away or give it away and have still gotten good value for your money.
- Designer pieces tend to cost a little more, last a little longer, and they usually follow more traditional lines so you can wear them for more than one or two seasons.
- Sterling Silver is affordable and very versatile. If you don't want to spend the money for sterling, then purchase some silver plate pieces. Silver is a must have for any wardrobe! You can go from dainty and delicate to large and noticeable. It can be dressed up or down and is acceptable for any event or occasion.
- Have some gold plate or gold tone pieces in your wardrobe basics also. 10-14k gold may be a bit too pricey for many but gold plated jewelry is quite affordable and will give you good value for the cost. Gold, like silver, can be dressed up or dressed down and is perfect for a very classy look.
- When purchasing rings, you can have great fun - again the choices are endless from large and overwhelming to dainty and feminine. The length and size of your fingers plays an important role in what will look good. For example, long skinny fingers don't look good with huge oversized rings, yet on a woman that has long

thicker fingers they look exquisite. Long nails? Short nails? it all makes a difference. Play and see what you like, and what looks good. Also, determine where you will be wearing these rings. For example, if you're working around fine fabrics, you'll not want any rings that have sharp edges that could snag. Your rings are also part of your total statement.

- When purchasing necklaces, be certain you know your neck size so that you get a good fit. This is very important when purchasing online as you don't get a chance to try it on. If your neck is average in size then a 16" necklace will look great, however if you have a somewhat larger than average neck then a 16" necklace could be too tight. Measure the length of some of your favourite necklaces you already own. This will give you a good indication of what length you prefer. Opera necklaces which are over 30" are terrific. They can be double wrapped, knotted, or whatever else your imagination comes up with. When choosing colored necklaces, make sure to pick a color that complements your skin tone. It may match your outfit fabulously but if it doesn't match or complement your skin tone your look could be lost.
- When purchasing bracelets, you'll need to decide where you're going to wear them, and how noticeable you want them to be. The availability of size and shape is endless - you can go from large bangle bracelets to dainty gem bracelets. If it is a slip-on bracelet, be sure that it will fit over your hand. Make certain to measure your wrist as the fit of a bracelet is very important. Too large and it will look sloppy and may even slide off. Too small and it can constrict your wrist movement.
- Your hands are your expressive area and many of us "talk with our hands." (they are also the smallest part of our body!) Try wearing three bracelets on one wrist - its a sign of power. They don't have to match either so step out and do something different. Don't forget to wear a dainty bracelet with your watch.
- When purchasing earrings, realize that the shapes and styles are endless - from dangles to chandeliers to hoops to studs to buttons. There are materials from enamel to beads to gems to metal to wood. The size of the earrings is very important to the statement you're making. The larger the earring, the more noticeable and the more incorporated they become into your total look. Large earrings aren't for everyone - depending on your face size and shape they may actually detract rather than attract. Experiment and find what looks best on you.
- Another thing to remember with purchasing your earrings is that tiny earrings make you look larger and larger earrings make you look smaller. Large earrings can give you the appearance of losing 10 pounds! (We all love that) Pick something that is in proportion to your size but most women can wear nickle to quarter size without any problem. Pick your earrings to the opposite shape of your face - they will be more complimentary. If you have a round face and wear round earrings your face will appear much rounder.
- Your jewelry choices are endless - no matter what your tastes, your likes, your dislikes. You'll be able to complete your look just the way you want it with little effort. So be sure to make your fashion statement!
- People sometimes like to make a statement and decide to wear jewelry with meaning behind it. It's a lovely way to show your history or beliefs. A good

example of this is the symbol of an inverted hand, where the hand extended forward is a symbol of divine force. Another example, is Celtic jewelry where the Celtic knots can symbolise the eternity of life.

How to Make a Memory Wire Bracelet



The instructions below are for making a simple memory-wire bracelet



Steps

7. **Take the memory wire and measure around your wrist twice if an adult and three times if a child.**
8. **Cut the memory wire with pliers made for memory wire.** Other cutters may be damaged if used on memory wire.
9. **Loop one end of the memory wire with pliers.** Place the wire in between the round nose pliers and push the wire around with your finger creating a small thin oval. Be sure to fully crimp the end of the wire to avoid sharp edges that may cause discomfort when worn. String beads on to the memory wire. Beginners may choose to use beads of similar colors, but don't hesitate to try a variety of shapes, colors and sizes for an eclectic look!
10. **Generally start with a metal bead and enlarge the size of bead used thereafter to give a tapering look to the ends of each side.** Aesthetically it has been recommended to clump same type beads in odd numbers (3,5,7) before adding an alternate bead, metal component (small metal bead, metal spacer *usually irregular thin component (like a flat pancake) made to cause a definite space between beads bringing attention and focus to that point).
11. **For example:** 6 Med blue round beads 6mm, two 6mm crystal bicone beads (pointed on each end), 1 6mm Square crystal bead 2 spacers and 3 Round 5mm silver balls would be arranged in the following order; 1 5mm metal ball followed by 3 6mm blue beads then add an additional 5mm metal ball followed by one of the 6mm bicones, spacer, square crystal, spacer, bicone, metal ball and 3 more additional 6 mm blue beads, and repeat until desired length has been met, ending the piece again with the smaller metal ball. -oOOo0@[]@oOOOoOOOo0@[]@oOOOoOOOo- Etc.

12. **Curl the other end of the memory wire using the pliers, again being sure to leave a smooth end.** Any sharp points can be dulled with an emery board.



Tips

- Choose your beads in advance and have them arranged in the pattern you desire. Setting them on a towel or arranging in a slight long grooved surface makes it easier to arrange and determine beforehand. This will help you determine if you like the look you are creating prior to stringing the entire thing and realizing you hate it. Your pattern may be symmetrical - or not! Choose from a wide variety of materials such as glass, wood, stone, or precious metal. You may wish to "frame" your larger beads with smaller beads such as seed beads or rondelles.
- Memory wire bracelets are especially popular when strung with dangle beads or charms.



Warnings

- Keep beads away from small children, as they may be swallowed.
- Don't put it around both hands as this can cut off circulation.

Things You'll Need

- round nose pliers
- memory wire for bracelets
- beads
- memory wire cutters

Chapter- 12

How to Choose a Platinum Ring



Platinum Engagement Ring

Platinum is often called the "King of Metals" as it has a special allure because it is rare, enduring, and pure. However, not all platinum is equal and not all platinum craftsmanship is the same.

Steps

1. **Know the purity content of your platinum ring.** As with all precious metals, platinum must be alloyed with other metals in order to achieve the hardness required for jewelry. A ring that is alloyed with 80% Platinum and 20% other metals is worth a lot less than a ring that is 95% pure platinum.
2. **Check the hallmark on the inside of the ring.** Federal regulations require all platinum bands to bear a stamp or "hallmark" on the inside of the band. If it says "IridPlat", or ".90Plat/Ir" then the ring is only 90% pure platinum, and you should pay less for it than a ring that is 95% pure platinum. If the hallmark says "Plat" or ".95 Plat", then the ring is considered pure platinum and commands a premium price.
3. **Ask your jeweler about the alloy used in your platinum ring.** If you are buying a pure platinum ring (95% platinum), then it should be alloyed with either Cobalt or Ruthenium. These alloys produce a harder platinum that can hold a mirror bright polish and resist years of daily wear. Many .95 pure platinum rings are alloyed with the less expensive metal Iridium, but these rings are softer and will become scratched and dull within a year of daily wear.
4. **Seek a master platinumsmith.** Find an ultra-specialist focused on designing and handcrafting jewelry in platinum. Working in platinum is very difficult. The metal doesn't melt until it reaches 3223°, unlike gold that melts at a mere 1700°. The tools needed to work in platinum are completely different as well. Given these challenges, there are but a few talented master platinumsmiths who have the expertise to make high-quality platinum rings. While some mass producers choose to outsource their platinum "artistry" to China to cut costs, the handful of masters trained in the finer art of platinumsmithing are in the US and Europe.
5. **Look for quality handcrafting in the engraving, filigree, pavé or other fine details.** Platinum rings today come in thousands of designs with differing details to suit personal tastes. These details may include engraving, or deep cuts in the platinum that form a design. Some jewelry manufacturers choose to imitate hand engraving by imbedding a design into the ring's casting. This prefabricated engraving will eventually wear off and lose its luster. Therefore, look for deep and intricate hand engraving, which typically lasts for generations. Filigree is another design element reminiscent of the Art Deco period. Again, to save costs, many jewelers prefabricate filigree in the casting process. The result is chunky filigree that lacks elegance and finesse. True artistry from the Art Deco period calls for filigree that is created from hand-drawn wires and sculpted then soldered into a piece. For the best quality, ensure that any filigree in the platinum ring is handcrafted. Bezel set with pavé is another extremely popular platinum ring option. Bezel set refers to a border of metal, often set with small diamonds that accent the center stone – and can make it appear larger. Bezel setting with pavé in platinum requires very specific expertise. Proper setting ensures that the focus is on the sparkle of the diamonds, not the platinum prongs holding in the stones. Noticing these fine points today will ensure the right choice for years to come.
6. **Consider custom rings for a one-of-a-kind heirloom piece.** For those who wish to express their individualism and own a statement ring that will become a family

- heirloom, custom is the only way to go. Many big jewelry houses scorn custom work. If you don't like one of their limited design choices, then you have too much imagination. Custom-made rings allow you to work with the designer to create the ultimate reflection of your tastes. The "build your own ring" online tools are a fun gimmick, but far from the true custom craftsmanship associated with a quality ring. Work with a knowledgeable, personal jeweler who can guide you in the process.
7. **Match your ring to your lifestyle.** If high style and glamour are priorities in your life, go for a showstopper that's loaded with exquisite hand artistry and a large center stone. If mountain climbing on Mount Kilimanjaro is your priority, forgo the delicate pavé work and opt for a platinum design with a low silhouette, that is, one that doesn't elevate the center stone so that it won't get banged around on rocks. Or, look at substantial platinum bands with unique engraving that look fashionable, yet are very practical. While most women fall somewhere in the middle, the point is that your ring needs to fit into your life. Some may feel more comfortable in a beautiful platinum band with an intricate floral design while others will gravitate toward a classic piece with a single center stone and filigree or the popular three-stone look with engraving. Nevertheless, since this purchase will likely be worn for ages to come, avoid the trendy, ultra-modern designs that promise to look dated in a few years.
 8. **Choose a style that looks best on your hand.** Now that you've eliminated certain designs based on your lifestyle, figure out what looks best on your hand. a) Match the size of your ring to the size of your hand. If you are large-framed with large, angular hands, don't choose a dainty piece that fades away. Rather look at bolder designs with a thicker platinum band or consider stacking several rings. If you are petite, choose more delicate pieces and plenty of details. b) Don't be obsessed with the size of the center stone. It's irrelevant that your best friend has a three carat. If it was set in white gold or poor-grade platinum, lacks style and its diamond has visible flaws, this is not a ring to covet. Think quality and substance in the design, the workmanship, the platinum alloy and the precious gems you select. c) Try on many ring styles to be sure. Some women are sure that they want a certain style of ring until it's on their finger. What's right for a cousin is not likely what's perfect for you. This is similar to clothing shopping. Trying on a piece is essential to know that it suits your fingers and hand size, that the ring doesn't twist or become off-centered easily or that it doesn't look good when stacked with a wedding band.
 9. **Ask your jeweler for a wax mold or silver replica of your ring.** If you have chosen a custom ring, you can ask your jeweler for a wax mold of your ring to ensure that the design meets your expectations before it is cast into platinum. Today, the best shops use computer-aided design (CAD) to create a three-dimensional image of your ring. Then, the jeweler creates a wax mold of the piece and the artisans refine its dimensions with extreme precision. Find out if your jeweler offers this service, which can eliminate any disappointment that your custom ring is not what you dreamed of. A few jewelers create a sterling silver and cubic zirconia version of a client's custom ring before casting it in platinum to ensure that the ring is exactly what the client wants.

Tips

- It's worth educating yourself on the finer points of choosing a platinum engagement rings to ensure that your testament to love - and investment in an important family heirloom - is the right choice.
- Check out a large variety of platinum designer rings at various Websites.
- When it comes to .95 pure platinum, the secret to a brighter platinum ring is the alloy.



Warnings

- If you are interested in buying an antique platinum ring, it will probably bear the hallmark "IridPlat" or ".90Plat/Ir" on the inside of the band. It is only in the past 15 years that .95 pure platinum has been popular in North America.
- If your platinum ring needs to be repaired, be sure to take it to a master platinumsmith. Most jewelers do not have the capability to properly repair platinum rings and your ring could be ruined if improper tools or the wrong platinum alloy is used to repair it.

Chapter- 13

Necklace



A necklace design using computer graphics



A bead crochet necklace made from crochet lace, sterling silver, and freshwater pearls

A **necklace** is an article of jewellery which is worn around the neck. Necklaces are frequently formed from a metal jewellery chain, often attached to a locket or pendant. Necklaces can also be manufactured with cloth, and they sometimes contain rocks (particularly gems), wood, and/or shells with different shapes and sizes.

History of necklaces

Necklaces have been an integral part of jewelry since the time of ancient civilizations. The birth of necklaces is believed to be as old as the Stone Age, which is around 40,000 years old. At that time, people were decorating themselves with mollusk necklaces. Later, necklaces made of stones, bones, shells and animal teeth became popular. After the

discovery of metals, gold, silver and a variety of other metals were used to make eye-catching necklaces for both men and women.

Types of necklaces

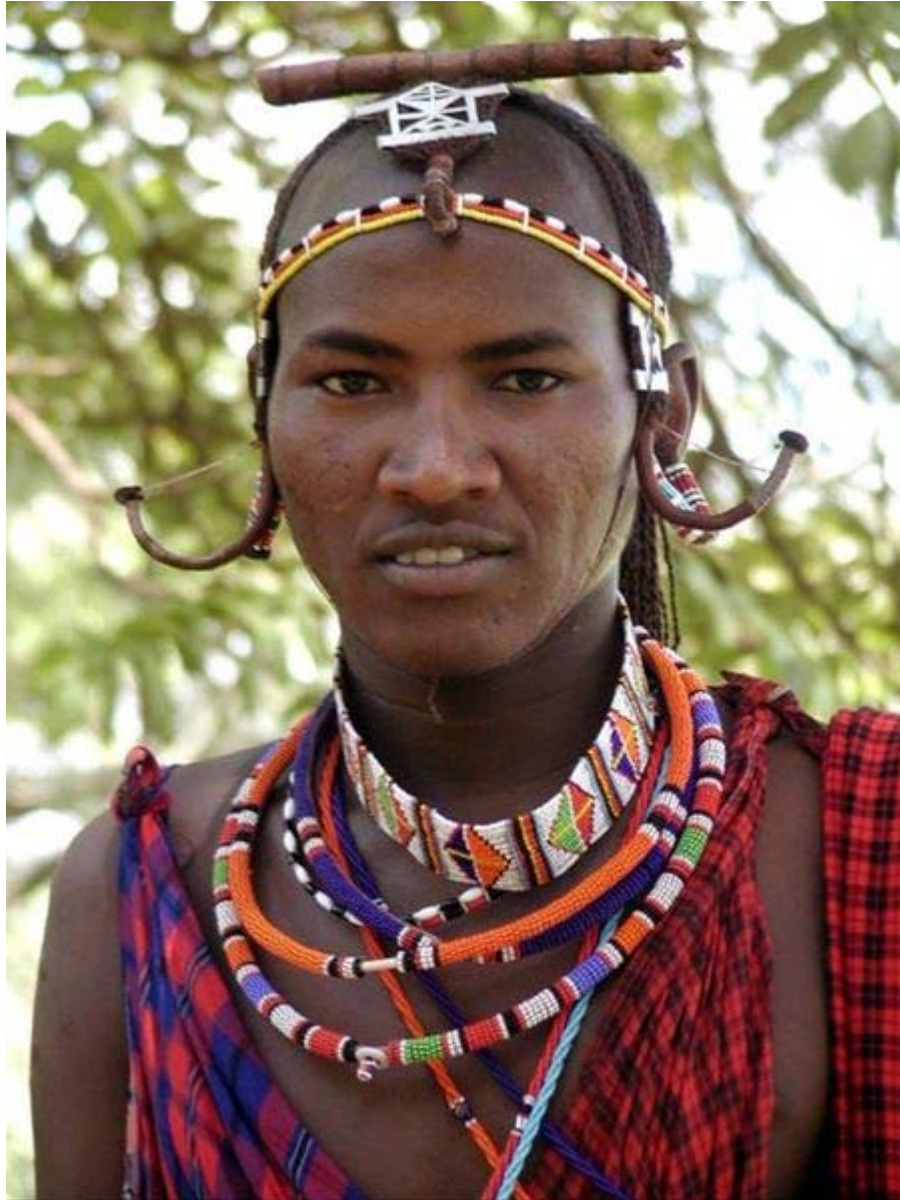

The Maasai use necklaces as part of traditional attire



Girl wearing a necklace

Bib necklace

A bib necklace is made multiple strands of stepped pearls.

Choker

35 centimetres (14 in) to 43 centimetres (17 in) long and sits high on the neck.

Matinee necklace

A matinee length necklace is 56 centimetres (22 in) to 58 centimetres (23 in) long, typically a single strand that rests at the top of the cleavage.

Opera necklace

An opera necklace is 75 centimetres (30 in) to 90 centimetres (35 in) long and sits at the breastbone.

Princess necklace

A princess necklace is 45 centimetres (18 in) to 50 centimetres (20 in) long. It is between choker and matinee length.

Sautoir or rope necklace

A sautoir or rope necklace is any necklace longer than opera length.

Uniform necklace

A uniform necklace consists of pearls that appear to be all the same size, although normally there is a slight difference towards the ends so they appear to be in proportion.

Sharktooth

A sharktooth necklace is a necklace with a shark tooth attached.

Pendant



Spanish pendant at Victoria and Albert Museum



Indonesia Bull Pendant and other pendants (100 B.C-A.D. 300)

A **pendant** (from Old French) is a hanging object, generally attached to a necklace or an earring. In modern French this is the gerund form of “hanging” (also meaning “during”). Pendants can have several functions:

- Ornamentation
- Identification (i.e. religious symbols, sexual symbols, symbols of rock bands)
- Protection (i.e. amulets, religious symbols)
- Self-affirmation (i.e. initials, names)
- Ostentation (i.e. jewels).
- Award (i.e. Scouting Ireland Chief Scout's Award, Order of CúChulainn)

These purposes can be combined (i.e. a richly jewelled symbol).

Other meanings



Ruby Eye Pendant from an ancient civilisation in Mesopotamia. Probably it was used to protect evil eyes.

- A teach pendant is a portable control device used in industrial robotics.
- A cable pendant is one of a series of cables that is horizontally suspended across a flight deck of aircraft carriers for aircraft to land by catching with tailhook.
- A *nautical pendant* is a length of cable or rope, usually of a short length, that has eyes or fittings, or both, at the ends for attachment to vessels and bollards or buoys.
- A pendant is a common item used in hypnosis.
- Pendants is a type of jewelry are often equipped with precious or semi precious stones. In ancient times kings and queens used to embrace there personality with multi stone Pendants studded in gold, silver and bronze.
- Pendant vertex, a vertex whose neighbourhood contains exactly one vertex
- A hanging light fitting.
- Pendant paintings are two paintings painted by a single author that are meant to go together.

Chapter- 14

Ring



Finger rings worn by Mary Nevill, Baroness Dacre, 1559

A **finger ring** is a circular band worn as a type of ornamental jewellery around a finger; it is the most common current meaning of the word *ring*. Other types of metal bands worn as ornaments are also called *rings*, such as arm rings and neck rings.

Rings are worn by both men and women and can be of any quality. Rings can be made of metal, plastic, wood, bone, glass, gemstone or other materials. They may be set with a "stone" of some sort, which is often a precious or semi-precious gemstone such as ruby, sapphire or emerald, but can also be of almost any material.

History of rings

The custom of giving and receiving rings dates back over 4,800 years. The fourth digit or ring finger of the hand has become the customary place to wear a wedding ring in much of the world. It stems from a 16th-century Tudor belief that the left-handed ring finger was connected by a vein directly to the heart; thus, wearing a ring on the third finger demonstrated that the wearer was in a relationship.

Finger rings

Shapes and styles

Various ring shapes and styles exist. The following are but a few.

- **Flat wedding bands** are the simplest form of ring that can be made. A flat wedding band basically consists of a strip of metal that is bent around into a loop and joined where the ends meet.
- **Half-round rings**, also called D-shape rings, are flat wedding bands that are filed half-round on the outside.
- **Sleeve rings** are rings that consist of a thin inner ring or sleeve, with several other rings stacked onto it to form one solid ring. The rings can either be soldered onto the sleeve or the ends of the sleeve can be upset (like a tube rivet) to keep them all together. A little of both can also be done.
- **Solitaire rings** are rings with a single large stone as a centerpiece, usually a diamond.
- **Eternity rings** are rings with stones, usually diamonds, of the same cut and size, set in one row all around the ring. The stones are usually round or square, and the setting is usually either claws or a channel setting. When the stones do not continue around the entire ring, but stop halfway around the finger, it is called a half-eternity ring.
- **Trinity rings** or **Trilogy Rings** are three rings to be worn at one time.
- **Cluster rings** are rings with a group of stones in a cluster setting, forming the focal point of the ring. The cluster setting usually consists of one large stone (usually round or oval) in the center surrounded with several smaller stones.
- **Tension Rings** are a type of ring in which a single gemstone is held in place by pressure rather than prongs, a bezel or other mounting. The metal setting is actually spring-loaded to exert pressure onto the gemstone.

Usage

Ring	Usage
Aqiq ring	A carnelian or Agate ring worn by some Muslims, especially Shi'ah, in imitation of Muhammad and the twelve Imams.
Championship ring	A ring presented to members of winning teams in professional business leagues as well as college tournaments in North America.
Claddagh ring	An Irish friendship ring. It is traditionally used to indicate the state of

	romantic availability.
Class ring	Worn by students and alumni in commemoration of their graduation.
Dinner ring	An oversized ring, set with non-precious or semiprecious stones.
Engagement ring	A traditional ring worn by a woman to indicate her engagement to be married.
Eternity ring	A ring symbolizing eternity with a partner.
Finger armor ring	Typically it spans from the base of the finger to just below the nail or middle of the second joint and includes a bending joint.
Friendship ring	Friendship rings are used to symbolize a close relationship that has no romantic undertone.
Gimmel ring	Ring made of 2 or 3 linking hoops, popular for betrothals in 16th and 17th century Europe
Iron Ring	Ring worn by Canadian engineers.
Magic ring	A fictitious ornament that appears frequently in fantasy stories and fairy tales.
Mood ring	A novelty ring which changes color in response to body temperature, using a thermochromic liquid crystal.
Mother's ring	A ring worn by a mother displaying the birthstone of each of her children, and sometimes including those of the mother and father.
Mourning ring	A ring worn in memory of someone who has died.
Multi-Finger ring	Two or more conjoined rings, designed to be worn across two, three, or four fingers; popularized by hip-hop culture.
Pinky ring	A ring worn on the pinky finger.
Posie ring	A ring with a short inscription on its outer surface.
Pre-engagement ring	A small, inexpensive ring given to a partner, to promise not to court a rival.
Promise ring	A ring worn to remind oneself of a promise one has made.
Purity ring	A symbol of virginity in some religious cultures.
Puzzle ring	Interlocking rings forming a single band; difficult to reassemble if removed from the finger.
Poison ring or Pillbox ring	A Ring consisting of a pillbox fitted into the ring, either for keeping medication or poison.
Regards ring	A Victorian engagement ring with an implicit acrostic: R uby, E merald, G arnet, A methyst, R uby, D iamond, S apphire.
Ring of O	A ring inspired by the <i>Story of O</i> , Pauline Reage's novel, in which the heroine, "The O" is presented with such a ring as a symbol of her submission.
Rosary ring	A rosary ring is a ring worn around the finger with 10 indentations and a cross on the surface, representing one decade of a rosary. The rings are used to keep track of place in the prayer by rotating the ring on a finger

and feeling the marks.

Signet ring	An emblematic, often familial, ring, often bearing a coat of arms, fit for use to imprint a wax seal on documents etc.
Sovereign ring	A typically large, gold ring, set with a gold sovereign as its decorative feature.
Thumb ring	This largest of finger rings is worn on the thumb primarily for fashion, but is also worn as a symbol of will power or internal energy, sexuality, and other beliefs or attitudes.
Watch ring	A small analogue or digital watch to be worn around a finger.
Wedding ring	A ring presented in many marriage ceremonies to signify marital commitment. Originally worn only by the woman, it is now common for both spouses to wear such a ring.

Notable individual rings

- The bearer of the Iffland-Ring disposes the ring by will to someone whom he regards as the most significant German-speaking actor.
- Hans-Reinhart-Ring
- The Ring of the Fisherman, the signet ring of the Pope.

Other types

- Arm rings.
- Neck rings.
- Toe rings are smaller rings worn on any of the toes.

Chapter- 15

Earring

Earring

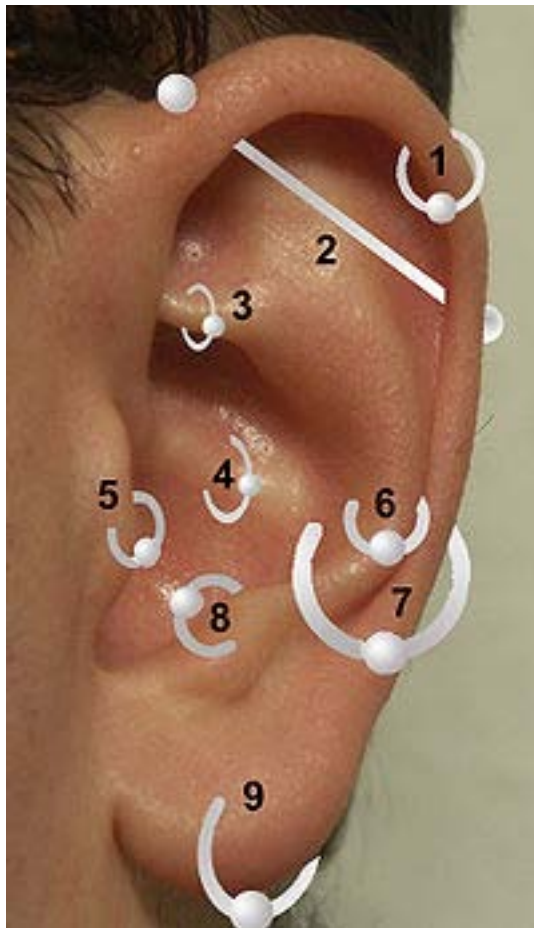

- 1) Helix/Cartilage, 2) Industrial, 3) Rook, 4) Daith, 5) Tragus, 6) Snug, 7) Conch, 8) Anti-Tragus, 9) Lobe

Location Ear

Jewelry Captive bead ring, barbell, circular barbell,
flesh plug

Healing 6 to 8 weeks

Earrings are jewelry attached to the ear through a piercing in the earlobe or some other external part of the ear (except in the case of clip earrings, which clip onto the lobe). Earrings are worn by both sexes. In western cultures, earrings have traditionally been worn primarily by women, although in recent decades, ear piercing has also become popular among men in North America, Europe, Asia and Africa.

Common locations for piercings, other than the earlobe, include the rook, tragus, and across the helix (see image). The simple term “ear piercing” usually refers to an earlobe piercing, whereas piercings in the upper part of the external ear are often referred to as “cartilage piercings.” Cartilage piercings are more complex to perform than earlobe piercings and take longer to heal.

Earring components may be made of any number of materials, including metal, plastic, glass, precious stones, beads, and other materials. Designs range from small loops and studs to large plates and dangling items. The size is ultimately limited by the physical capacity of the earlobe to hold the earring without tearing. However, heavy earrings worn over extended periods of time may lead to stretching of the earlobe and the piercing.

History

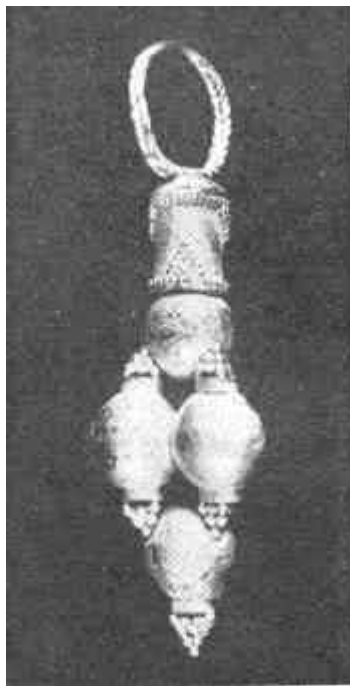

Golden Elamite earring



Royal earrings, Andhra Pradesh, 1st Century BCE

Ear piercing is one of the oldest known forms of body modification, with artistic and written references from cultures around the world dating back to early history. Early evidence of earrings worn by men can be seen in archeological evidence from Persepolis in ancient Persia. The carved images of soldiers of the Persian Empire, displayed on some of the surviving walls of the palace, show them wearing an ear ring.

Other early evidence of earring wearing is evident in the Biblical record. In Exodus 32:1-4, it is written that while Moses was up on Mount Sinai, the Israelites demanded that Aaron make a god for them. It is written that he commanded them to bring their sons' and daughters' earrings to him in order that he might comply with their demand. (ca. 1500 BCE)

Among sailors, a pierced earlobe was a symbol that the wearer had sailed around the world or had crossed the equator. In addition, it is commonly held that a gold earring was worn by sailors in payment for a proper burial in the event that they might drown at sea. Should their bodies have been washed up on shore, it was hoped that the earring would serve as payment for "a proper *christian* burial". Regardless of this expression, the practice predates Christianity and can be traced back as far as ancient Greece where the gold paid the ferryman, Charon, to provide passage across the river Acheron to Hades.

Pierced ears were popular in the United States through the early 1900s, then fell into disfavor among women due to the rising popularity of clipped-on earrings. Nevertheless, a small male following continued to exist.

In the late 1960s, ear piercing began to make inroads among men through the hippie and gay communities. At that time, the practice re-emerged, but since a large commercial market for them did not exist, most ear piercings were done at home. Teenage girls were known to hold *ear piercing parties*, where they performed the procedure on one another. Such an event is depicted in the 1978 motion picture *Grease* (set in 1959), where Sandy (Olivia Newton-John), the leading lady, is pierced by her friends.



Pairs of earrings for sale at a roadside stand in Costa Rica

In the late 1970s, amateur piercings, sometimes with safety pins and/or multiple piercings, became popular in the punk rock community. By the 1980s, the trend for male popular music performers to have pierced ears helped establish a fashion trend for men.

This was later adopted by many professional athletes. British men started piercing both ears in the 1980s; George Michael of Wham! was a prominent example. The heavily jeweled Mr. T was an early example of an American celebrity wearing earrings in both ears, although this trend did not become popular with mainstream American men until the 1990s.

Multiple piercings in one or both ears first emerged in mainstream America in the 1970s. Initially, the trend was for women to wear a second set of earrings in the earlobes, or for men to double-pierce a single earlobe. Asymmetric styles with more and more piercings became popular, eventually leading to the cartilage piercing trend.

A variety of specialized cartilage piercings have since become popular. These include the tragus piercing, antitragus piercing, rook piercing, industrial piercing, helix piercing, orbital piercing, daith piercing, and conch piercing. In addition, earlobe stretching, while common in indigenous cultures for thousands of years, began to appear in Western society in the 1990s, and is now a fairly common sight. However, these forms of ear piercing are still infrequent compared to standard ear piercing.

Procedure

Ear piercing became commonly available in physician offices. Some of the earliest commercial, non-medical locations for getting an ear piercing appeared in the 1970s at Manhattan jewelry stores, although the overall commercial market was still in its infancy. By the 1980s, ear piercing was common among many women, thus creating a broader market for the procedure. Department stores throughout the country would hold ear piercing events, sponsored by earring manufacturers. At these events, a nurse or other trained person would perform the procedure, either pushing a sharpened and sterilized *starter earring* through the earlobe by hand, or using an ear-piercing instrument modified from the design used by physicians.

Sexual orientation

In various Western cultures, piercing the left vs. the right ear has sometimes been popularly perceived to be associated with a particular sexual orientation. In the 80s it was said that "left is right, and right is wrong," alluding to social prejudices surrounding sexual orientation. The left ear was reserved for piercing by straight men and a pierced right ear signified that one was gay. It is similarly held that among homosexual men, an earring in the left ear signifies a dominant partner or "top" and the right a submissive one or "bottom".

Religious

In India, nearly all the girls and some boys get their ears pierced in a religious ceremony before they are about 5 years old. Infants may get their ears pierced as early as several days after their birth. Similar customs are practiced in other Southeast Asian countries, including Nepal, Sri Lanka, and Laos, although traditionally, most males wait to get their

ears pierced until they have reached young adulthood. They only tend to allow one piercing on each ear as it is disrespectful to have any more than that.



Earring

Several varieties of non-pierced earrings exist.

- **Clip-on earrings** - Clip-on earrings have existed longer than any other variety of non-pierced earrings. The clip itself is a two-part piece attached to the back of an earring. The two pieces closed around the earlobe, using mechanical pressure to hold the earring in place.

- **Magnetic earrings** - Magnetic earrings simulate the look of a (pierced) stud earring by attaching to the earlobe with a magnetic back that hold the earring in place on by magnetic force.
- **Stick-on earrings** - Stick-on earrings are adhesive-backed items which stick to the skin of the earlobe and simulate the look of a (pierced) stud earring. They are considered a novelty item.
- **Spring hoop earrings**- spring hoops are almost indistinguishable from standard hoop earrings and stay in place by means of spring force.
 - An alternative which is often used is bending a wire or even just using the ring portion of a CBR to put on the earlobe, which stays on by pinching the ear
- **Ear Hook earrings** - A large hook like the fish hook that is big enough to hook and hang over the whole ear and dangles.
- **The Hoop** - A hoop threads over the ear and hangs from just inside the ear, above where ears are pierced. Mobiles or other dangles can be hung from the hoop to create a variety of styles.
- **Ear Screws** - Screwed onto the lobe, allow for exact adjustment - an alternative for those who find clips too painful.

Permanent earrings

Where most earrings worn in the western world are designed to be removed easily to be changed at will, earrings can also be permanent (non-removable). They were once used as a mark of slavery or ownership. They appear today in the form of larger gauge rings which are difficult or impossible for a person to remove without assistance. Occasionally, hoop earrings are permanently installed by the use of solder, though this poses some risks due to toxicity of metals used in soldering and the risk of burns from the heat involved. Besides permanent installations, locking earrings are occasionally worn by people of both genders, due to their personal symbolism or erotic value.

Ear piercing

Pierced ears are earlobes or the cartilage portion of the external ears which have had one or more holes created in them for the wearing of earrings. The holes may be permanent or temporary. The holes become permanent when a fistula is created by scar tissue forming around the initial earring.

Piercing techniques

A variety of techniques are used to pierce ears, ranging from "do it yourself" methods using household items to medically sterile methods using specialized equipment.

A long-standing home method involves using ice as a local anesthetic, a sewing needle as a puncture instrument, a burning match and rubbing alcohol for disinfection, and a semi-soft object, such as a potato, cork, or rubber eraser, as a push point. Sewing thread may be drawn through the piercing and tied, as a device for keeping the piercing open during the healing process. Alternatively, a gold stud or wire earring may be directly inserted into the fresh piercing as the initial retaining device. Home methods are often unsafe and risky due to issues of improper sterilization or placement.

Another method for piercing ears, first made popular in the 1960s, was the use of sharpened spring-loaded earrings known as *self-piercers*, *trainers*, or *sleepers*, which gradually pushed through the earlobe. However, these could slip from their initial placement position, often resulting in more discomfort, and many times would not go all the way through the earlobe without additional pressure being applied. This method has fallen into disuse due to the popularity of faster and more successful piercing techniques.



An ear being pierced with an ear piercing instrument

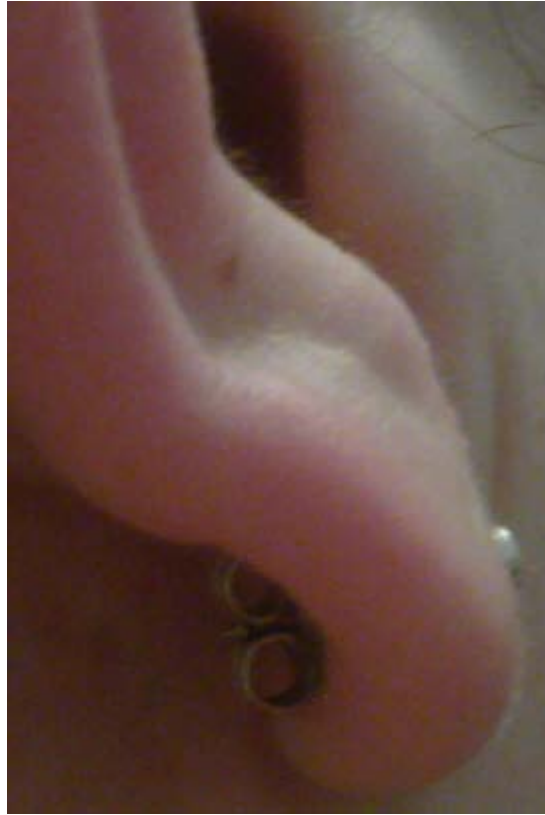

Pierced ear with traditional starter stud

Ear piercing instruments, sometimes called *ear piercing guns*, were originally developed for physician use but with modifications became available in retail settings. Today more and more people in the Western world have their ears pierced with an ear piercing instrument in specialty jewelry or accessory stores, or at home using disposable ear piercing instruments. An earlobe piercing performed with an ear piercing instrument is often described as feeling similar to being pinched, or being snapped by a rubber band.

An alternative which is growing in practice is the use of a hollow piercing needle, as is done in body piercing.

In tribal cultures and among some neo-primitive body piercing enthusiasts, the piercing is made using other tools, such as animal or plant organics.

Initial healing time for an earlobe piercing performed with an ear piercing instrument is typically 6–8 weeks. After that time, earrings can be changed, but if the hole is left unfilled for an extended period of time, there is some danger of the piercing closing. Piercing professionals recommend wearing earrings in the newly pierced ears for at least 6 months, and sometimes even a full year. Cartilage piercing will usually require more healing time than earlobe piercing, sometimes 2-3 times as long. After healing, earlobe piercings will shrink to smaller gauges in the prolonged absence of earrings, and in most cases will completely disappear.

Health risks

The health risks with conventional earlobe piercing are common but tend to be minor, particularly if proper technique and hygienic procedures are followed. One study found that up to 35% of persons with pierced ears had one or more complications, including minor infection (77% of pierced ear sites with complications), allergic reaction (43%), keloids (2.5%), and traumatic tearing (2.5%). Pierced ears are a significant risk factor for contact allergies to the nickel in jewelry. Earlobe tearing, during the healing period or after healing is complete, can be minimized by not wearing earrings, especially wire-based dangle earrings, during activities in which they are likely to become snagged, such as while playing sports. Also, larger gauge jewellery will lessen the chance of the earring being torn out.

With cartilage piercing, the blunt force of an ear piercing instrument will traumatize the cartilage, and therefore make healing more difficult. Also, because there is substantially less blood flow in ear cartilage than in the earlobe, infection is a much more serious issue. There have been several documented cases of severe infections of the upper ear following piercing with an ear piercing instrument, which required courses of antibiotics and/or surgery to clear up. There are many ways that an infection can occur: the most common way is when the person that got pierced decides to take out the piercing too early. According to the A.M.A (American medical association), the proper waiting period to change or take out a piercing with substantially less risk of infection would be three weeks.

For all ear piercings, the use of a sterilized hollow piercing needle tends to minimize the trauma to the tissue and minimize the chances of contracting a bacterial infection during the procedure. As with any invasive procedure, there is always a risk of infection from blood borne pathogens such as hepatitis and HIV. However, modern piercing techniques make this risk extremely small (the risk being greater to the piercer than to the pierced due to the potential splash-back of blood). There has never been a documented case of HIV transmission due to ear/body piercing or tattooing, although there have been instances of the Hepatitis B virus being transmitted through these practices.