

HANDBOOK
OF
GEM
IDENTIFICATION

by
Richard T. Liddicoat, Jr.

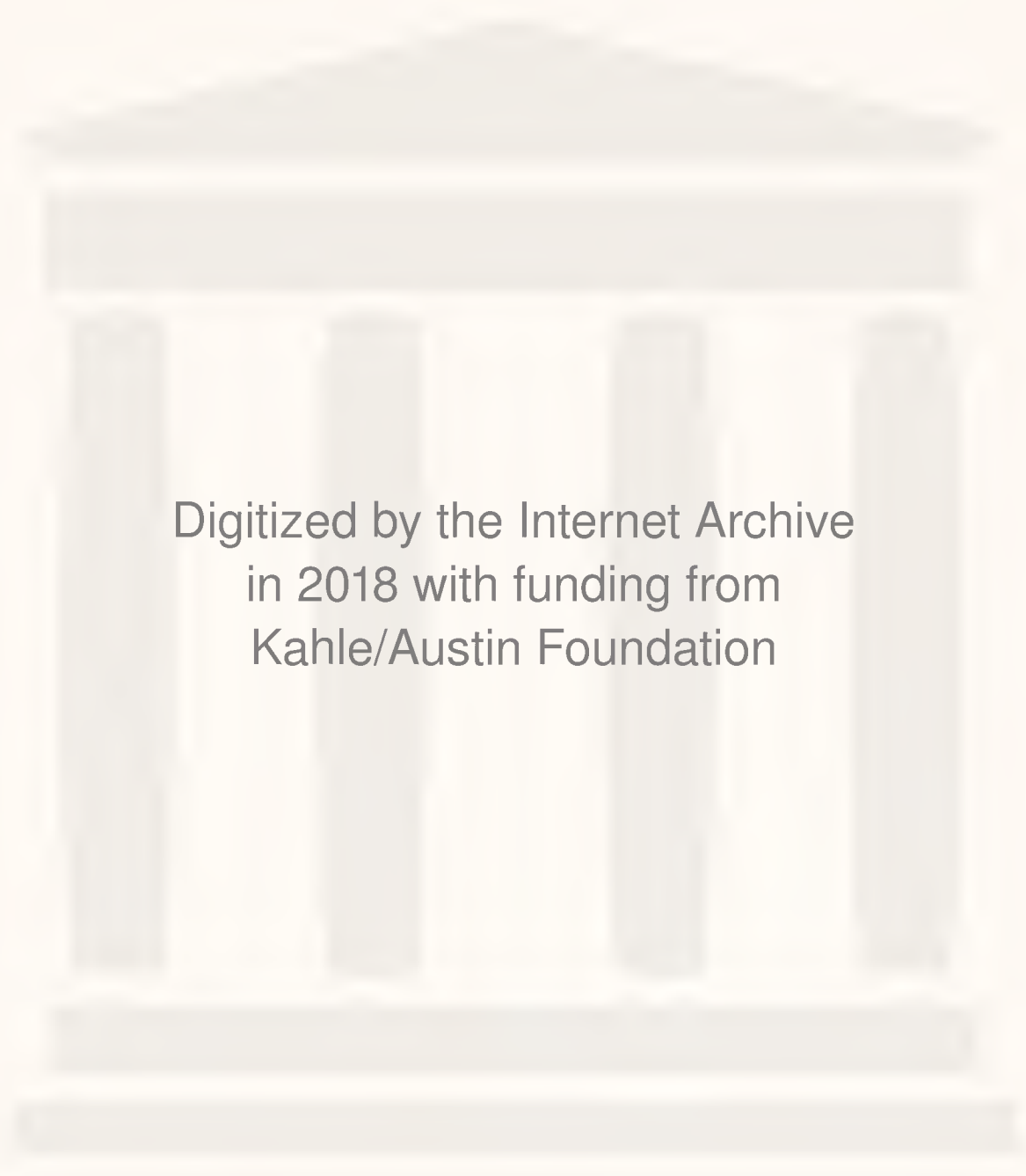

Digitized by the Internet Archive
in 2018 with funding from
Kahle/Austin Foundation

HANDBOOK OF GEM IDENTIFICATION

Books by the Same Publishers

DICTIONARY OF GEMS AND GEMOLOGY

Robert M. Shipley

JEWELERS' MANUAL

Richard T. Liddicoat, Jr. and Lawrence L. Copeland

GILL'S INDEX

To Journals, Articles and Books
Relating to Gems and Jewelry

Joseph O. Gill

THE DIAMOND DICTIONARY

*Lawrence L. Copeland, Richard T. Liddicoat, Jr.,
Lester B. Benson, Jr., Jeanne G. M. Martin,
G. Robert Crowningshield*

HANDBOOK OF GEM IDENTIFICATION



Characteristic silk-like inclusions are shown in a photomicrograph of demantoid garnet.

Frontispiece

Handbook of GEM IDENTIFICATION

by
Richard T. Liddicoat, Jr.

President

GEMOLOGICAL INSTITUTE OF AMERICA

With a Foreword to the First Edition by the late
DEAN EMERITUS EDWARD H. KRAUS, Ph.D., Sc.D.
College of Literature, Science and the Arts
University of Michigan

Published by the
GEMOLOGICAL INSTITUTE OF AMERICA
1660 Stewart Street, Santa Monica, California 90406
Founded by Robert M. Shipley

Copyright 1981
BY THE
Gemological Institute of America

FIRST EDITION
FIRST AND SECOND PRINTINGS
1947

SECOND EDITION
1948

THIRD EDITION
1951

FOURTH EDITION
1953

FIFTH EDITION
1957

SIXTH EDITION
1962

SEVENTH EDITION
1966

EIGHTH EDITION
1969

NINTH EDITION
1972

TENTH EDITION
1975

SECOND PRINTING
1977

THIRD PRINTING
1980

ELEVENTH EDITION
1981

*All rights reserved. No part of this work may
be reproduced without the written permission
of the author and the publishers.*

ISBN 0-87311-006-4

PRINTED IN THE UNITED STATES OF AMERICA

Foreword

Today jewelers and the general public are better informed concerning gems than ever before. In the United States, this is due in large measure to the wide dissemination of gemological information during the last quarter of a century through the publication of authoritative texts on gems, the formation of many mineralogical clubs, and especially through the activities of the Gemological Institute of America, founded in 1931, and of the American Gem Society, organized in 1934. For some time, however, it has been recognized that there is need for a manual describing in detail the various methods and procedures to be followed in the identification of gems. This need is now being supplied by Richard T. Liddicoat's "Handbook of Gem Identification."

By his excellent scientific training and his extensive experience at the Gemological Institute of America, Mr. Liddicoat is well qualified to author an authoritative handbook. Moreover, he has had the benefit of the counsel and advice of Director Robert M. Shipley and others at the Institute.

In the opening chapters, the essentials concerning the important properties of gemstones are described in a lucid manner. Manufactured stones and the instruments used for testing are discussed in several chapters. The main portion of the book is devoted to the tests and procedures to be followed in the

Foreword

identification of gemstones, which are grouped according to color. As the tests and procedures are outlined in great detail, there should be no difficulty whatever in following them. The book also includes useful tables of properties, a glossary, and various flow charts.

This handbook should prove to be very helpful in the making of accurate determinations of gemstones. It is a valuable addition to gemological literature, and will be welcomed by dealers in, and lovers of, gems.

Edward H. Kraus.

Ann Arbor, Michigan
July 21, 1947

Preface

Although many books have been written describing gemstones and their occurrence, there is a need for books which give both the jeweler and the layman with limited equipment an outline for making the simple and often conclusive tests that identify gems. If properly used this handbook will help to fill that need.

Several individuals offered valuable assistance in the preparation of this book. From his initial suggestion, which started the preparation to the reading of the final proofs, Robert M. Shipley proved unfailingly helpful. The author is also especially indebted to Ralph J. Holmes, Ph.D., for his many suggestions. George Switzer, Ph. D., contributed several ideas that have been incorporated. Several of the adaptations of mineralogical instruments and tests for the identification of gemstones were developed by Robert Shipley, Jr. Many of the methods and tests used in this handbook were developed by him. The majority of the photomicrographs of gemstone inclusions are those of Dr. Edward Gubelin, C.G., of Lucerne, Switzerland, who kindly permitted their use. With few exceptions, the line drawings were prepared by Lester Benson.

RICHARD T. LIDDICOAT, JR.

Los Angeles, California
August 20, 1947

Preface to Sixth Edition

In each of the previous revisions of this book, the changes were limited largely to new finds, new substitutes, and new tests and developments in instrumentation that had occurred since the previous edition. This time, Chapters VI, VII, IX, X, XI, XII, XIV, and XV were changed materially, and Chapter XIII plus all of the identification chapters were completely rewritten. These new chapters are based on a procedure in which the refractometer is the first instrument used in an identification.

So many substances that are seldom encountered by jewelers are often submitted for identification to the Gem Trade Laboratories and they appear in so many collections that their properties and descriptions were added to Chapter XV and the complete tables. However, the main portions of each identification chapter have not been burdened with details of these rarely encountered gem materials.

Robert Crowningshield, Bert Krashes and Eunice Miles, of the Institute's New York Gem Trade Laboratory, read and criticized each of the new chapters, making a number of valuable suggestions and comments. Joseph Murphy and Glenn Nord of the Los Angeles staff also made constructive suggestions. In the course of typing the manuscript and preparing it for the typesetter, Jeanne Martin, also a Graduate Gemologist, contributed many useful ideas; in addition, she took many of the new photographs.

The rewritten chapter on the spectroscope (Chapter XIII) has a new table of absorption spectra. The illustrations were prepared by Crowningshield, using a new technique for making realistic black-and-white reproductions of absorption spectra. Changes in the book were edited by Lawrence L. Copeland.

Richard T. Liddicoat, Jr.

October 1, 1962

Preface to Tenth Edition

Since the Ninth Edition was completed early in 1972, there have been a number of developments of significance in new synthetics, new gem finds, and especially in the alteration of gemstones, notably with gamma irradiation. In 1972, Gilson's synthetic opals had been announced, and we had had the opportunity to examine some synthetic white opals, but now both synthetic white opals and truly beautiful synthetic black opals are on the market.

Gadolinium gallium garnet, better known as GGG, a synthetic material with a garnet structure, is coming into widespread use as a diamond substitute. Flux-grown synthetic alexandrite has been on the market for some time now, but a new synthetic alexandrite made by the Czochralski pulling technique is soon scheduled, we believe, to be released for the market.

It is also necessary to discuss the new reflectivity meters and what significance they might have in testing.

Helpful suggestions were offered by Charles Fryer, Michael Waitzman, Janice Mack, Archie Curtis and the New York Laboratory staff. Susan Adams edited the revisions.

Richard T. Liddicoat, Jr.

June 13, 1975

Preface to Eleventh Edition

After a number of years of relative quiet on the synthetic front, the last year or two has seen a new emphasis on synthetic ruby, synthetic alexandrite, plus the great interest displayed in surely the best of the diamond simulants—cubic zirconia. In this period there have been a number of new instruments introduced, particularly for separating diamond from substitutes. Thermal conductivity comparators such as the Ceres Probe and the Diamond Master and other diamond detecting instruments such as the Gem Diamond Pen are numerous.

In this edition a new Fluorescence Table has been added indicating typical reactions to long-wave and short-wave ultra-violet radiation. The chapter entitled “Ancillary Tests” has been revised and retitled “Altered Stones—Ancillary Tests”. In addition, a new chapter has been added on Altered Stones—situations that occur when different treatments are given gemstones to make them more attractive or more valuable than they are intrinsically.

Archie Curtis, G.G., GIA’s Assistant Director of Administration, who taught identification for years, while on a flight to Tokyo to teach classes there, read over the book and gave very helpful detailed commentary on items that were out-of-date or for some other reason needed changing.

I am also indebted to Elizabeth Schuster, who teaches GIA’s Home Study Gem Identification Course for her comments about needed up-dating. Over the years many people have been particularly helpful in preparation of new editions; included are Charles Fryer, Michael Waitzman, the New York Laboratory staff and Glenn Nord.

Richard T. Liddicoat, Jr.

December 29, 1980

TABLE OF CONTENTS

Chapter	Page
I Introduction	1
II The Nature of Gemstones	3
III Cleavage, Fracture, and Hardness	7
IV Specific Gravity	13
V Refractive Index Determination	23
VI Double Refraction, Pleochroism, and Optic Character	46
VII Magnification	66
VIII The Use of Characteristic Imperfections as a Means of Gem Identification	83
IX Color Filters and Fluorescence	112
X Synthetic Gemstones	118
XI Doublets, Triplets, Foil Backs, and Imitations	151
XII Pearls, Cultured Pearls, and Imitations	163
XIII The Spectroscope	179
XIV Altered Stones and Ancillary Tests	211
XV Instruments Essential to Gem Testing	222
XVI Descriptions and Property Variations of Gemstones	228
XVII A Procedure for the Identification of Gem- stones and Their Substitutes	282
XVIII The Identification of Transparent Purple and Violet Gemstones and Their Sub- stitutes	287
XIX The Identification of Transparent Blue Gem- stones and Their Substitutes	296
XX The Identification of Transparent Green Gemstones and Their Substitutes	305

HANDBOOK OF GEM IDENTIFICATION

XXI	The Identification of Transparent Yellow Gemstones and Their Substitutes.....	323
XXII	The Identification of Transparent Brown and Orange Gemstones and Their Substitutes	335
XXIII	The Identification of Transparent Pink and Red Gemstones and Their Substitutes ..	345
XXIV	The Identification of Transparent Colorless Gemstones and Their Substitutes.....	357
XXV	The Identification of Nontransparent Violet and Blue Gemstones and Their Substitutes.....	373
XXVI	The Identification of Nontransparent Green Gemstones and Their Substitutes.....	382
XXVII	The Identification of Nontransparent Red, Orange, Yellow, and Brown Gemstones and Their Substitutes.....	393
XXVIII	The Identification of Nontransparent White, Gray, and Black Gemstones and Their Substitutes.....	401
	Appendix.....	411
	Color Table.....	412
	Cleavage and Parting Table.....	417
	Pleochroism Table.....	418
	Refractive Index Table.....	42 and 420
	Dispersion Table.....	422
	Table of Birefringence.....	47 and 422
	Specific Gravity.....	18 and 423
	Hardness Table.....	12 and 425
	Table of Significant Fluorescence.....	426
	Glossary.....	429
	Gemological Institute of America.....	433
	Index.....	439

HANDBOOK OF GEM IDENTIFICATION

Chapter I

Introduction

The beauty of gemstones and the immense value placed on many of them by mankind has led to a proliferation of substitutes and clever alterations of natural material to enhance beauty and apparent value. To one seeking to classify gemstones exactly, the problems are many, but the task is made less difficult by the relatively small number of possibilities and by the effective instrumentation available to assist the gemologist.

Most minerals have relatively constant properties. Most gemstones are minerals, so accurate property measurement is an essential to identification.

One who seeks to become proficient in gemtesting must guard against a number of pitfalls. Probably the most common errors made by the novice tester are failure to consider all possibilities and faulty interpretations of results.

The first part of this book is devoted to the important properties of gems and to their identification by various instrument tests, with full explanations of methods and results. Although in many instances positive identification can be made with the simplest of instruments, more difficult tests are also described in detail.

The remaining portion of the book is devoted to a detailed step-by-step plan to classify gemstones correctly in each of the different colors in which important gems occur, with a sufficiently wide color range to satisfy any indecision as to colors on the part of the tester. There are also chapters covering the distinction between gems of natural and synthetic origin. Means of identification of other substitutes also are included. Complete tables of the properties of important gems, as well as many infrequently encountered in the jewelry trade, are contained in the appendix. Tables of the

properties of gems of the color under discussion, with the variability of each property, are contained in each chapter on identification.

Many photographs and drawings supplement the text, in order to clarify the tests. Numerous photomicrographs illustrate the appearance of gems of natural origin, as well as the man-made counterparts. Characteristic inclusions of various gems are also portrayed in photomicrographs, to assist in making identifications based on the characteristic internal appearance.

Chapters describing the important tests prepare the reader for the use of the final identification portion of the book. There are seven sections devoted to the identification of transparent gemstones and their substitutes; four to nontransparent gemstones and their substitutes; and one section to the identification of natural and cultured pearls and pearl imitations. Each section on the identification of gemstones follows a pattern based upon the recommended procedure for gemtesting outlined in Chapter XVII.

Chapter II

The Nature of Gemstones

The Nature and Classification of Gem Minerals. With rare exceptions (amber, jet, pearl and coral), the materials used for gem purposes are minerals. A *mineral* has been defined as a naturally occurring inorganic material of essentially constant chemical composition, usually possessing a definite crystal structure or orderly arrangement of its component atoms. Opal, which is generally regarded as amorphous (i.e., lacking a systematic arrangement of atoms), is an exception. Since each mineral species possesses a constant chemical composition and a characteristic crystal structure, it follows that each species will have a constant set of physical and optical properties. This constancy of properties renders the identification of gem materials possible. Amber and jet, although they occur within the earth, are not regarded as minerals, since they have been produced through the agency of living organisms. To such organic materials mineralogists have applied the term *mineraloids*. A *rock* is a mechanical intergrowth of two or more minerals. Lapis-lazuli, consisting of lazurite, pyrite and sometimes calcite, is an example of a gem that is regarded as a rock rather than a mineral.

Mineralogists, in their description of minerals, employ a classification just as zoologists and botanists do in describing animals and plants. Since almost all gems are minerals, gemologists follow the mineralogical classification. Botanists and zoologists refer to genera, species and varieties of plant and animal life. The gemologist and mineralogist use the terms, *group*, *species* and *variety*. *Group* refers to two or more gem minerals that are similar in structure and properties, but not quite the same chemically. The in-

dividual members of a group are themselves *species*. All *varieties* of a species have the same crystal structure and the same chemical composition, but differ only in color. The color variations are usually due to the presence of minute traces of impurities. Thus, ruby and sapphire are color varieties of the gem mineral corundum. The garnet family is classed as a gemological group, since there are appreciable differences in the composition of the several types of garnet, although all members of the group are identical in structure. The difference in color among the members of the garnet group is not due to small quantities of impurities (as in the case of ruby and sapphire), but is directly attributable to the basic chemical differences between the species of the garnet group.

Crystal Systems and Their Function in Determinations. The optical, physical, and all other properties of a mineral are determined by its chemical composition and crystal structure. Minerals having a definite crystal structure are called *crystalline*, while those with no regular internal arrangement are known as *amorphous*. One of the few natural amorphous substances used as a gem is opal, but glass and several other imitations are also amorphous. All crystalline materials are assigned to one of the six different crystal systems, each mineral species occurring in only one of those systems. The crystal systems are: isometric (or cubic), hexagonal, tetragonal, orthorhombic, monoclinic, and triclinic. Diamond and spinel crystallize in the isometric system. Beryl (emerald and aquamarine) and corundum (ruby and sapphire) crystallize in the hexagonal system. Zircon crystallizes in the tetragonal system. Gems crystallizing in the orthorhombic system are topaz and chrysoberyl. Commonly encountered monoclinic gems are the jades and precious moonstone (orthoclase feldspar). Gems that crystallize in the triclinic system are turquoise and labradorite feldspar.

Differences in chemical composition and internal structure give the various gems properties that differ from each other markedly, and thus enable the jeweler to identify the various species. Gems that crystallize in the isometric system and those that are amor-

The Nature of Gemstones

phous are known as *isotropic*; that is, they are *singly refractive*. Gems that crystallize in the other five crystal systems are *doubly refractive*; i.e., they possess the property of breaking up a beam of light into two rays as it passes through the substance.

Knowledge of the crystal system of a gem is important, because many of the properties used in identification are related to the crystallization of the material. Familiarity with crystal forms and habits is also a valuable aid in the identification of rough gem materials. On the basis of the optical properties of a cut gem, it is often possible to decide in which system or group of systems the gem belongs. The determination of the nature of common crystal inclusions in a faceted gem provides a valuable clue to its identity. Genuine spinel, for example, is characterized by minute octahedral inclusions. Any mineralogical or gemological text contains diagrams or photographs that will assist in determining the crystal system of rough gems.

Crystal Structure. Variations in chemical composition and crystal structure of gem minerals cause a wide range of physical and optical properties. The heavier the individual atoms, the greater will be the density of the material. Likewise, spacing of atoms within the structure will influence densities. Diamond and graphite are both carbon, but the density of graphite is only slightly more than half that of the diamond. This is a consequence of the relatively closely packed structure of diamond. This tightly packed structure of the diamond also accounts for its extreme hardness.

Identification of Unknowns. Since each mineral species has characteristic and fairly constant optical and other physical properties, it follows that the determination of these properties will make possible the identification of a gem of unknown nature. There

are many properties that may be used to separate the various species, but the ease with which the several properties can be determined varies considerably. Dispersion is a difficult property to measure, but it can be determined. Resistance to fracture or to chemical corrosion are not only difficult to evaluate, but will cause damage to the gem by their application. Unlike the mineralogist, the gemologist is severely limited in the tests that can be applied to gem identification. Many of the principal methods of mineral identification require the partial destruction of the sample. The gemologist is obviously limited to the use of tests that will in no way harm the specimen, yet they must be conclusive and rapid. The tests that best fulfill the gemologist's requirements are those for refractive index, single or double refraction, pleochroism, selectivity of light absorption, specific gravity, and characteristic inclusions. The first four have long been the basis of gem identification.

Identification of the various natural gem species is based on accurate determination of optical and physical properties. Prior to the advent of the synthetic gemstone, no further tests were necessary to conclusively identify any gem. The introduction of the synthetic has greatly increased the difficulty of accurately identifying gem minerals, since, by definition, not only the chemical composition but the crystal structure of a synthetic must be identical with that of the natural gem it represents. As a consequence of this identity of composition and structure, the optical and physical properties of both the natural stone and its synthetic equivalent are essentially identical. Therefore, the determination of the constant optical and physical properties does not distinguish between natural stones and their synthetic counterparts. Fortunately, the inclusions found in man-made gems are different from those found in gems of natural origin. In many instances, however, the synthetic gem is sufficiently well made to require high magnification to resolve its inclusions. Inasmuch as it is often necessary to examine gems under high magnification, the use of characteristic inclusions to distinguish between natural gem species, as well as between artificial and natural gems, is of great value to one who has become familiar with their appearance.

Chapter III

Cleavage, Fracture, and Hardness

Cleavage. The atomic pattern of a gemstone and the relative strength of the bonds between atoms determines the manner in which the stone may break or split. Cleavage, which might be compared to the splitting of wood along the grain, is a gemstone's tendency to split along directions parallel to certain planes of atoms in its internal structure; it is dependent on the lack of cohesion between atomic planes in certain directions. Cleavage within a gem results in a flat, smooth break, and is described both by its relation to the crystal faces, or possible crystal faces, of the original crystal and by the ease with which the splitting occurs. The cleavage of diamond is parallel to the octahedral faces, its most common crystal form. The cleavage of topaz is described as perfect, parallel to the base of its prismatic crystal form.

Since few gemstones are likely to cleave, presence of cleavage cracks within a gem may be useful in its identification. Important gems that cleave easily are: diamond, the feldspars, spodumene (kunzite) and topaz. Beryl, garnet, quartz and zircon do not cleave readily. Perhaps the most frequent use of cleavage in identification is in the separation of various varieties of feldspar from the varieties of chalcedony that may resemble them. Tiny breaks often present around the girdle of a cabochon are flat and have a vitreous luster on sunstone, moonstone, amazonite and other feldspars, but are shell-like with a waxy luster on chalcedony.

The presence of cleavage in a gem is proof that the material is

crystalline and is an indication of importance to the gem cutter, who both utilizes cleavage and guards against it in his work.

False Cleavage (Parting). A flat, smooth break that occurs parallel to planes of weakness caused by repeated twinning is called parting or false cleavage. It is not uncommon in ruby and sapphire, of the important gemstones.

Fracture. Fracture, which may be compared to splitting across the grain of wood, takes several forms, which are described by their distinctive appearance. The following are the most common:

Conchoidal fracture presents a curved and shell-like appearance.

Most gems show conchoidal fracture — glass perhaps to a greater extent than genuine stones.

Even fractures have a smooth appearance, but lack the regularity and single-plane appearance of cleavage. Some types of quartz show even fracture.

Uneven fractures can best be described by likening them to the edges of broken pottery. Almost any mineral or rock may exhibit uneven fracture.

Splintery fractures resemble the usual breaks seen in wood.

Splintery fracture is seen most often in hematite and in nephrite jade.

Fracture is of little use in identification, with two notable exceptions:

(1) Chalcedonic quartz and turquoise have the shell-like fracture common to most gems, but the luster on such fracture surfaces is waxy to dull, not vitreous as in most other gemstones.

(2) Hematite may be distinguished from Hemetine, a substitute, by hematite's splintery fracture.

Hardness. The property of hardness, dependent upon cohesion, or the force of attraction between atoms, may be defined as resistance to scratching or abrasion. Since each gem has a characteristic hardness, the test for hardness may provide a clue to the identity of a gemstone. The possibility of damage to the stone, in the case

Cleavage, Fracture and Hardness

of transparent gemstones, seriously limits the value of the test. In the determination of opaque gemstones, on the other hand, the test may be useful.

Mohs scale, the standard scale of hardness in both mineralogy and gemology, comprises the following minerals arranged in order of decreasing hardness:

10 Diamond	5 Apatite
9 Corundum	4 Fluorite
8 Topaz	3 Calcite
7 Quartz	2 Gypsum
6 Feldspar	1 Talc

Note: Mohs scale is one of relative hardness only. The difference in hardness between the materials listed is not equal.

The following intermediate values, supplementary to the figures given by Mohs, are useful in gemstone identification:

8½ Chrysoberyl
7½ - 8 Beryl
7½ Almandite garnet, zircon

Hardness tests may be made in one of several ways. Perhaps the most common application is to determine if an edge of the unknown material will scratch something of known hardness.

Many jewelers who own no other testing instruments have a set of hardness points or pencils. Each consists usually of a small metal tube with a cylinder of a mineral of known hardness ground to a point at one end and cemented into one end of the tube. Commonly, the points used include diamond, synthetic corundum, topaz, quartz and feldspar. In addition to pencils, small rectangular plates made up of the minerals 1 to 9 of the Mohs scale are sometimes used in hardness testing.

There are several manmade materials that make convenient additional hardness points. Silicon carbide, 9¼; hardened steel file, 6-7; ordinary glass, 5½; and a copper penny, 3, are commonly employed.

HANDBOOK OF GEM IDENTIFICATION

Caution: Whether the unknown is scratched with a point, or an edge is drawn across another material, any hardness test is dangerous. It is very easy to mar the surface or even break a stone.

The hardness test must be regarded as a last resort, to be avoided if at all possible when testing transparent stones. If the tester does use hardness, a sharp hardness pencil applied to as inconspicuous a place as possible is suggested, or that the girdle be drawn across a plate of known hardness. Opaque materials are not rendered less attractive by a small scratch in an inconspicuous place on the back, but care is needed to prevent breakage.

It is easy to make an error in a hardness determination, by failing to press the point firmly against the unknown or an edge of the unknown against a plate of known hardness. Although great care is necessary, the action must be firm, to avoid sliding over a softer surface, but controlled to avoid slipping and damage. Only a minute scratch is needed. The tester can usually feel whether point or edge is "biting" or just sliding. Wipe the test surface and examine it with a loupe to see whether the point has powdered itself or scratched the test surface.

In making a hardness test, the jeweler should bear in mind that a gem of any given hardness will scratch another gem of equal hardness, and that hardness may vary with crystal direction.

To Make the Test with a Hardness Plate: In any test with hardness plates, start with the softer plates beginning with hardness 4 or 5. Attempt to scratch the hardness plate with the edge of the gem.

Caution: Since in testing gems in this manner against the plates of greater hardness a perceptible portion of the girdle might easily be ground down, and since the edges of the harder plates are usually sufficiently sharp to be used as hardness points, it is advisable to apply them as such against the back of the gem to avoid damage to the girdle.

Cleavage, Fracture, and Hardness

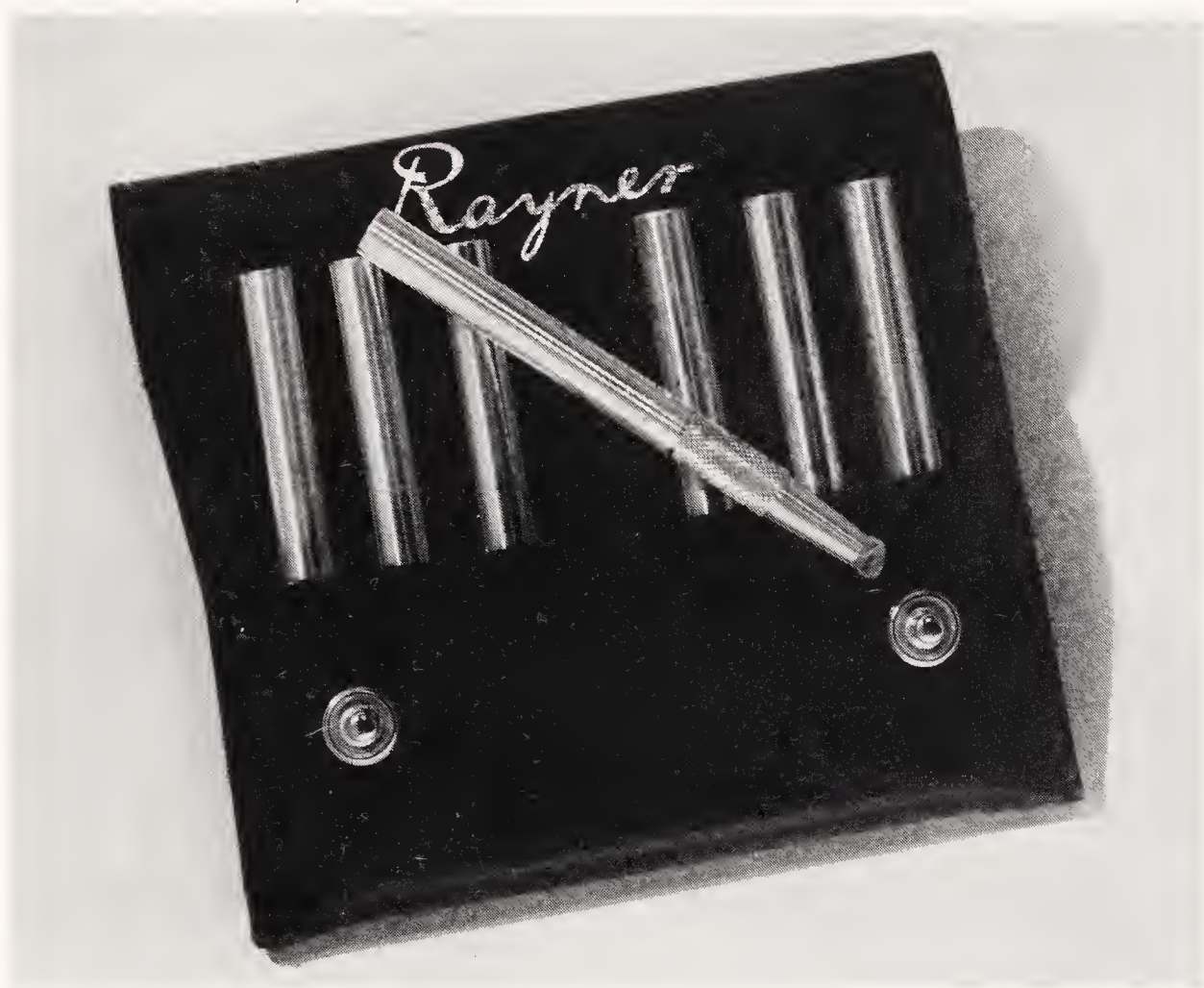

Figure 1

Set of hardness points, with points of hardness from five to ten.

Mohs Hardness Table

Diamond	10	Leucite	6
Silicon carbide	9¼	Petalite	6
Corundum & Syn.	9	Hematite	5½-6½
Chrysoberyl	8½	Rhodonite	5½-6½
Syn. cubic zirconia	8½	Beryllonite	5½-6
YAG	8¼	Anatase	5½-6
Spinel & Syn.	8	Brazilianite	5½
Painite	8	Enstatite	5½
Topaz	8	Willemite	5½
Taaffeite	8	Moldavite	5½
Rhodizite	8	Thomsonite	5½
Beryl & syn. emerald	7½-8	Opal	5-6½
Phenakite	7½-8	Diopside	5-6
Zircon (high, medium)	7½	Glass	5-6
Almandite garnet	7½	Strontium titanate	5-6
Hambergite	7½	Lazulite	5-6
Euclase	7½	Lazurite (lapis-lazuli)	5-6
Gahnite	7½	Turquoise	5-6
Gahnospinel	7½	Sodalite	5-6
Rhodolite garnet	7-7½	Chlorastrolite	5-6
Pyrope garnet	7-7½	Sphene	5-5½
Spessartite garnet	7-7½	Obsidian	5-5½
Tourmaline	7-7½	Datolite	5-5½
Andalusite	7-7½	Bowenite (serpentine)	5-5½
Iolite	7-7½	Apatite	5
Staurolite	7-7½	Scheelite	5
Grossularite garnet	7	Dioptase	5
Quartz & Syn.	7	Smithsonite	5
Danburite	7	Odontolite	5
Dumortierite	7	Stibiotantalite	5
Chalcedony	6½-7	Syn. Turquoise	5-
Peridot	6½-7	Apophyllite	4½-5
Jadeite	6½-7	Syn. opal	4½
Andradite garnet	6½-7	Zincite	4½
Axinite	6½-7	Kyanite	4-7
Saussurite	6½-7	Variscite	4-5
Idocrase	6½	Augelite	4
Scapolite	6½	Fluorite	4
Kornerupine	6½	Rhodochrosite	3½-4½
Zircon (low)	6½	Malachite	3½-4
Pollucite	6½	Azurite	3½-4
GGG	6½	Sphalerite	3½-4
Spodumene	6-7	Coral	3½-4
Sinhalite	6-7	Conch pearl	3½
Epidote	6-7	Calcite	3
Sillimanite	6-7	Verdite	3
Cassiterite	6-7	Black coral	3
Zoisite	6-7	Hemetine	2½-6
Rutile & Syn.	6-6½	Pearl	2½-4½
Microcline	6-6½	Jet	2½-4
Albite-Oligoclase	6-6½	Pseudophite	2½
Orthoclase	6-6½	Agalmatolite	2½
Nephrite	6-6½	Serpentine	2-4
Pyrite	6-6½	Amber	2-2½
Benitoite	6-6½	Copal	2
Marcasite	6-6½	Alabaster	2
Prehnite	6-6½	Stichtite	1½-2
Ekanite	6-6½	Steatite (soapstone)	1-1½
Labradorite	6		
Amblygonite	6		

Chapter IV

Specific Gravity

Value in Identification. For an unmounted stone, an accurate specific-gravity determination provides valuable information, since the specific gravities of the major gemstones seldom overlap. Tests can be made with minor additions to a diamond balance, or with an inexpensive set of heavy liquids, so it is not difficult for most jewelers to add to their testing facilities.

Density and Specific Gravity. *Density* is defined as the mass of any given material per unit volume. It is dependent upon the atomic weight or weights of the constituents and upon the atomic spacing of the material. Thus, the mass or weight of lead in one cubic foot greatly exceeds that of an equal volume of wood. Diamond is composed entirely of carbon, an element with a very low atomic weight. The relatively close atomic spacing of diamond, however, gives that gem a medium density. Both the silicon and the oxygen atoms of quartz have atomic weights greater than carbon, but its less compact crystal structure produces a smaller mass per unit volume than diamond.

The fact that one substance has a greater density than another is of little value in gem identification, unless a means of making exact comparisons is available. To make exact comparisons, it is necessary to compare the weights of equal volumes of materials. Since gems are seldom of the same size, their volumes must be determined first. The ratio of the weight of a gemstone to the weight of an equal volume of water gives a figure that can be compared to a similar value for any other gemstone. This ratio is called *specific gravity*. It is more accurately defined as the ratio of the

HANDBOOK OF GEM IDENTIFICATION

weight of a substance to the weight of an equal volume of water at 4° Centigrade (the temperature at which density of water is the maximum). The variation of water's density from 4° to room temperature is so slight that it need not be considered in gem identification.

Comparing gemstones to an equal volume of water, we find that diamond, for example, weighs 3.52 times as much as the water. Amber is only 1.08 times as heavy as water in equal volume, while gold is 19.3 times heavier than water.

The specific gravity of each gem species is constant within fairly narrow limits. In a few instances, the specific gravity of two species will be nearly the same or will overlap, but such instances are exceptional. It is therefore apparent that specific gravity can be used as a valuable aid to the identity of a gem.

The Hydrostatic Principle. To make a specific-gravity determination, it is necessary to compare the weight of a gemstone to that of an equal volume of water. It might appear that it would be difficult to determine what constitutes an equal volume of water. The famed philosopher and scientist, Archimedes, determined that any material wholly immersed in water loses in weight an amount equal to the weight of water it displaces. Since a gem must displace a volume of water equal to its own volume, the weight of an equal volume of water must equal the stone's loss of weight when immersed in water.

Thus, if a gem is first weighed in air, then weighed when immersed in water, the difference in the two weights must be the weight of the water displaced — an amount of water that is equal in volume to the gem. Then the weight of the gem in air divided by the loss of weight when weighed in water must, by definition, be its specific gravity.

The Adaptation of the Jeweler's Diamond Balance for S. G.¹ Measurements. The diamond balance can easily be adapted to secure specific-gravity measurements. A stand is placed so that its base rests under the weighing pan of the balance, and its arm ex-

¹Specific gravity.

Specific Gravity

tends up over the pan so that a water container can be placed over the pan, without touching the balance. A wire is suspended from the arm of the balance that holds the weighing pan, so that it hangs into the liquid in the container that rests on the stand.

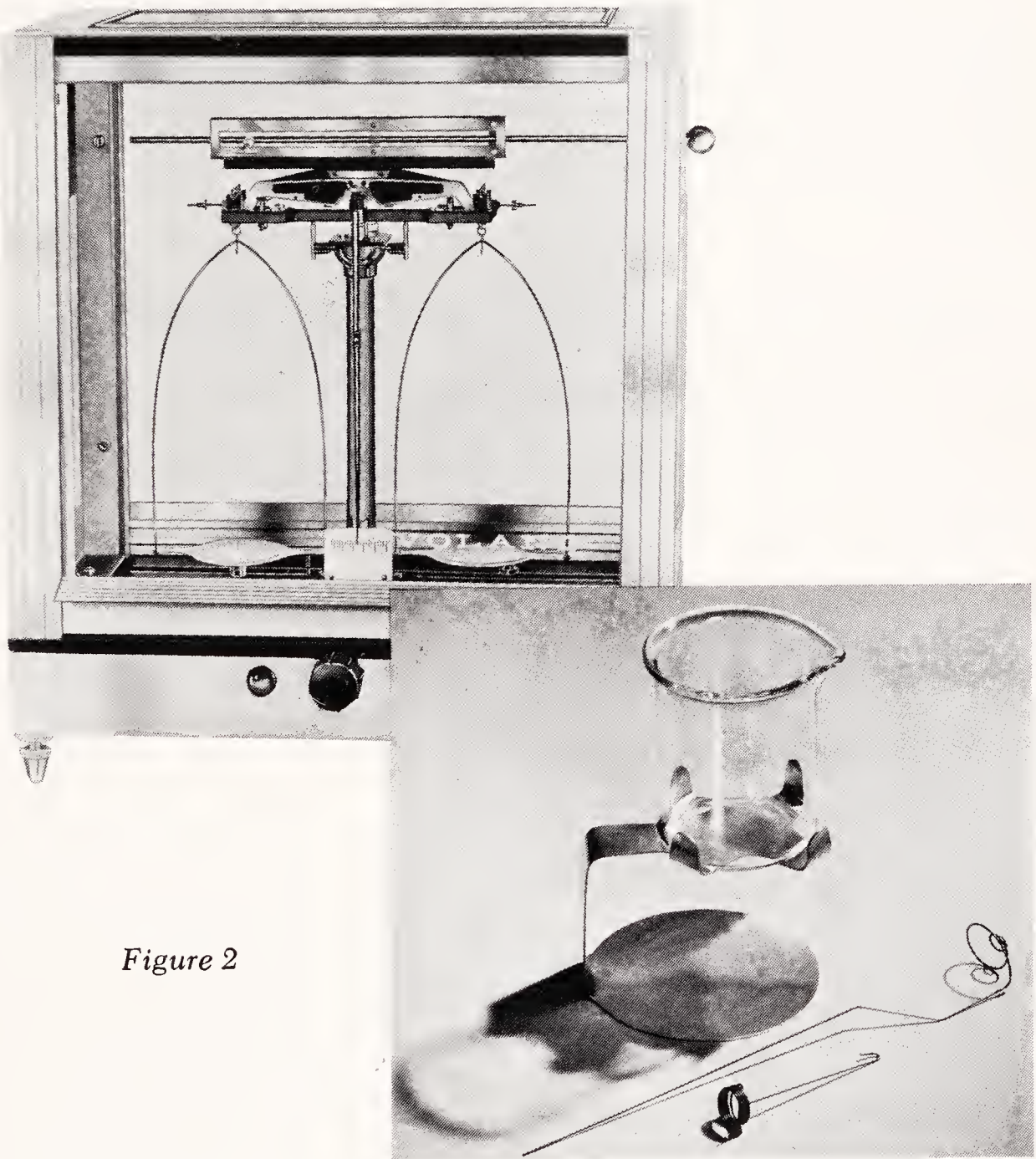

Figure 2

Close-up of diamond balance with specific gravity attachments.

HANDBOOK OF GEM IDENTIFICATION

The end of the wire that hangs into the water is bent into a loop or basket that will hold the gem to be tested. From the opposite arm of the balance a second wire is hung to act as a counterbalance to the wire suspended in the water. For the purpose of simplifying the calculation of specific gravity, the second wire should exactly balance the first, when the first wire is suspended in the water.

Use a longer wire for the counterbalance to the wire that holds the stone. Reduce the counterbalance in length very carefully, step-by-step until it balances the wire that hangs into the liquid. This eliminates the necessity for taking into account the weight of the wire that holds the stone.

Sample Specific-Gravity Determination by Means of a Diamond Balance. After having balanced a wire hanging in water on one side of the balance with a wire hanging in air on the other side, we make the following determinations:

The weight of a gem in air is four carats. Its weight in water is three carats. Using the formula,

$$\frac{\text{Weight in air}}{\text{Weight in air} - \text{weight in water}} = \text{Specific gravity}$$

$$\text{we have } \frac{4}{4 - 3} = \text{Specific gravity} = \frac{4}{1} = 4.0$$

Detergent or Carbon Tetrachloride. When specific gravity is determined by means of the diamond balance, the surface tension of the water dampens the swing of the balanced wire-loop basket so much that it is often difficult to obtain accurate determinations on small gems. To reduce the surface tension of water effectively, add a detergent, preferably a drop or two of one of the household liquid type available at any grocery store.

Jewelers often substitute pure carbon tetrachloride in place of pure water to avoid the high surface-tension problem. If this substitution is made, the tester must make allowance for the density

Specific Gravity

of carbon tetrachloride in the formula for obtaining specific gravity.

Thus, when weighing a gemstone in carbon tetrachloride the formula is:

$$\frac{\text{Weight in air}}{\text{Weight in air} - \text{weight in liquid}} \times 1.58 = \text{Specific gravity}$$

Using the same example as that in which the weighing was taken in water, this change would be necessary: The weight of the stone in air was 4 carats; its weight in carbon tetrachloride would be 2.42 carats. Inserting these figures in the above equation, we have this result:

$$\text{S.G.} = \frac{4}{4 - 2.42} \times 1.58 = \frac{4}{1.58} \times 1.58 = 4.0$$

Because of its very low surface tension, specific-gravity determinations made with carbon tetrachloride are usually more accurate than when water is used without adding a detergent. However, a detergent reduces the surface tension of water to nearly that of carbon tetrachloride.

Tolerances. The accuracy of a specific-gravity determination on the diamond balance depends on the delicacy and accuracy of the balance, the skill and care of the tester, and the size of the stone tested. With water plus detergent or carbon tetrachloride, an experienced and careful tester should be within $\pm .01$ on stones of three or four carats or larger on a standard balance. The novice should use the following tolerances while becoming adept at the specific determination: 3 carats to four, $\pm .10$; 2 to 3 carats, $\pm .15$; 1.25 to 2 carats, $\pm .20$; .75 to 1.25, $\pm .25$; and .50 to .75, $\pm .35$. Below .50, a difference of .01 carat in either weighing may mean a difference of .50 in specific gravity, so even the most careful weighing on a standard balance may result in a determination far from the true figure.

Other Balances. There are several balances that utilize this hydrostatic method of specific-gravity determination. One, the Ber-

Specific Gravity Table

Stibiotantalite	7.50(±.30)	Enstatite	3.25(±.02)
GGG	7.02(±.07)	Sillimanite	3.25(±.02)
Cassiterite	6.95(±.08)	Chlorastrolite	3.20
Scheelite	6.12	Fluorite	3.18(±.01)
Syn. Cubic Zirconia . .	5.80(±.20)	Apatite	3.18(±.02)
Zincite	5.70	Spodumene	3.18(±.03)
Hematite	5.20(±.08)	Andalusite	3.17(±.04)
Strontium titanate . . .	5.13(±.02)	Euclase	3.10(±.01)
Pyrite	5.00(±.10)	Odontolite	3.10
Marcasite	4.85(±.05)	Lazulite	3.09(±.05)
Zircon		Tourmaline	3.06(−.05, +.15)
(high)	4.70(±.03)	Amblygonite	3.02
(medium)	4.32(±.25)	Danburite	3.00(±.01)
Gahnite	4.55	Psilomelane	3.0
YAG	4.55	Nephrite	2.95(±.05)
Smithsonite	4.30(±.10)	Phenakite	2.95(±.01)
Rutile & Syn.	4.26(±.02)	Datolite	2.95
Spessartite	4.15(±.03)	Brazilianite	2.94
Almandite	4.05(±.12)	Pollucite	2.92
Sphalerite	4.05(±.02)	Verdite	2.90
Painite	4.01	Prehnite	2.88(±.06)
Gahnospinel	4.01(±.40)	Beryllonite	2.85(±.02)
Zircon (low)	4.00(±.07)	Conch Pearl	2.85
Corundum		Agalmatolite	2.80
& Syn.	4.00(±.03)	Turquoise	2.76(−.45, +.08)
Malachite	3.95(−.70, +.15)	Steatite	2.75
Anatase	3.90	Lazurite	
Andradite	3.84(±.03)	(lapis-lazuli)	2.75(±.25)
Rhodolite	3.84(±.10)	Beryl	2.72(−.05, +.12)
Azurite	3.80(−.50, +.07)	Pearl	2.70(−.02, +.15)
Pyrope	3.78(−.16, +.09)	Labradorite	2.70(±.05)
Chrysoberyl	3.73(±.02)	Augelite	2.70
Syn. alexandrite	3.71(±.02)	Pseudophite	2.70
Staurolite	3.71(±.06)	Calcite	2.70
Rhodochrosite	3.70	Scapolite	2.68(±.06)
Syn. spinel	3.64(−.12, +.02)	Syn. emerald	
Benitoite	3.64(±.03)	(hydroth.)	2.68(±.02)
Kyanite	3.62(±.06)	(Gilson)	2.67(±.02)
Grossularite	3.61(−.27, +.12)	(flux)	2.66
Taaffeite	3.61	Quartz & Syn.	2.66(±.01)
Spinel	3.60(−.03, +.30)	Syn. Turquoise	2.66
Topaz	3.53(±.04)	Albite-	
Diamond	3.52(±.01)	Oligoclase	2.65(±.02)
Sphene	3.52(±.02)	Coral	2.65(±.05)
Rhodonite	3.50(±.20)	Iolite	2.61(±.05)
Sinhalite	3.48	Chalcedony	2.60(±.05)
Idocrase	3.40(±.10)	Serpentine	2.57(±.06)
Epidote	3.40(±.08)	Orthoclase	2.56(±.01)
Rhodizite	3.40	Microcline	2.56(±.01)
Peridot	3.34(−.03, +.14)	Variscite	2.50(±.08)
Jadeite	3.34(±.04)	Leucite	2.50
Zoisite	3.30(±.10)	Obsidian	2.40(−.07, +.10)
Dioptase	3.30(±.05)	Moldavite	2.40(±.04)
Kornerupine	3.30(±.05)	Petalite	2.40
Saussurite	3.30	Apophyllite	2.40(±.10)
Dumortierite	3.30(±.10)	Thomsonite	2.35(±.05)
Diopside	3.29(±.03)	Hambergite	2.35
Axinite	3.29(−.02)	Alabaster	2.30
Ekanite	3.28	Glass	2.3 to 4.5

Specific Gravity

Sodalite	2.24(± .05)	Coral (black)	1.35(± .05)
Chrysocolla	2.20(± .10)	Jet	1.32(± .02)
Stichtite	2.18(± .02)	Plastics	1.30(± .25)
Opal	2.15(− .09, + .07)	Amber	1.08(± .02)
Coral (golden)	2.12(± .1)		
Syn. Opal	2.05(± .03)		

man, is a torsion balance. The important advantage of the Berman Balance is its accuracy with gems of less than one-third carat. The Berman is not commonly used in the jewelry trade, since it cannot be used for weight determination, and it is more expensive than an accurate diamond balance.

The Jolly Balance is occasionally used to determine the specific gravity of rough minerals and gems over five carats in size. It consists of a tall mirror, with a calibrated scale beside it, from the top of which hangs a long coiled spring from which are suspended two small pans. A zero reading of the scale is taken with the lower pan in water and the upper pan empty. Then readings are taken with the stone first on the pan in the air, and again on the lower pan, which is submerged in water. The reading taken with the stone on the upper pan, subtracted from the zero reading is divided by the difference between the reading taken with the stone on the upper pan and the reading with the stone on the submerged pan. If a detergent is used in the water, the specific-gravity determinations are fairly accurate with stones of two or more carats.

Direct Reading Balances. Such scales as the Westphal Balance and the Penfield Balance (as well as its modifications) determine specific gravity directly. The balances mentioned have a zero setting against which the stone is weighed in air. The stone is then weighed in water with a direct reading of specific gravity the result. These balances are so designed that the second reading gives specific gravity rather than a second weight.



Figure 3

Three useful heavy liquids for specific gravity determinations.

Liquids Used in Specific-Gravity Determinations. The most rapid specific-gravity determination is obtained by means of heavy liquids. In addition, heavy liquids do not have the size limitation apparent in the balance method by which the results are unreliable for small stones (if the ordinary diamond balance is employed). Of the several liquids that may be used, the most practical are *methylene iodide and bromoform*. Methylene iodide is light yellowish brown when fresh but becomes darker as iodine is set free by sunlight (a small piece of pure tin or copper in the liquid reduces discoloration). In its pure form it has a density of 3.32 at room temperature.

In place of bromoform, Gem Instruments Corporation now dilutes methylene iodide with benzyl benzoate. The evaporation rates of the two liquids are so close that the density changes little over long periods.

Bromoform, a colorless liquid, gradually turns brown on exposure to sunlight as free bromine is released. Its density at room temperature is 2.89. Dark methylene iodide and bromoform are effectively lightened to their original color by removing the free iodine or bromine with mercury by drawing the metal and dense liquid repeatedly into an eye dropper. Bromoform should be used only in good ventilation.

Specific Gravity

To determine the specific gravity of an unknown gemstone, using either methylene iodide or bromoform, place the gemstone gently in the liquid. *If the gem floats*, it has a specific gravity less than that of the liquid, and the volume of the stone that remains beneath the surface of the liquid represents a volume of liquid equal in weight to the total weight of the stone. If $\frac{5}{6}$ of a gem floating on a liquid is beneath the surface, the gem's specific gravity is $\frac{5}{6}$ that of the liquid. If a small transparent glass beaker is used for this determination, it is possible to arrive at a fairly close estimate of the proportion of the stone below the surface. *If the gem sinks slowly*, its specific gravity is just greater than that of the liquid. *If it sinks very rapidly*, like a rock in water, the specific gravity is appreciably greater than that of the liquid. Caution: Tap a floating stone with tweezers, to be sure it is not held by surface tension.

Methylene iodide may be diluted with benzyl benzoate to produce liquids of lower density. Useful lower densities include 3.06, 2.67, and 2.62, among others.

Clerici's Solution. Clerici's solution is a mixture of thallium formate and thallium malonate, which has a density between 4.2 and 4.3 in a saturated water solution at 70°F. The solution is transparent. In the saturated form of this liquid almost all transparent gems, with the exception of zircon, will float. Solutions of almost any density below 4.25 are easily made by diluting the solution with distilled water.

Clerici's solution is much more expensive than methylene iodide or bromoform. For maximum effectiveness, many testers dilute the solution to the specific gravities of corundum (4.00), spinel (3.60) and diamond (3.52).

With all heavy liquids care is recommended to prevent the liquid from getting on the hands or clothes of the user. In addition, each liquid must be removed from stone and tweezers before the stone is placed in another liquid.

Almost every gemstone of importance will float in pure Clerici's solution, but liquids of proper density for the important gemstones may be made by dilution with pure water. With proper liquids, rapid and accurate specific-gravity determinations are possible without the

HANDBOOK OF GEM IDENTIFICATION

size limitations or the arithmetical or mechanical errors that occur in the diamond-balance method.

Caution: Clerici's solution is very poisonous and highly corrosive; thus, not recommended for general use.

The specific gravity of gemstones is sufficiently constant to provide the gemtester with an important means of identification. It is not difficult to determine specific gravity by a variety of inexpensive but efficient methods.

Chapter V

Refractive Index Determination

When a beam of light strikes the boundary surface between two transparent substances, such as between diamond and air, it is partly reflected. The law of reflection states that the *angle of incidence and the angle of reflection are equal and that the incident and reflected rays are in the same plane, which is normal to the surface*. The reflection of an object in a mirror illustrates this law. (See illustration.)

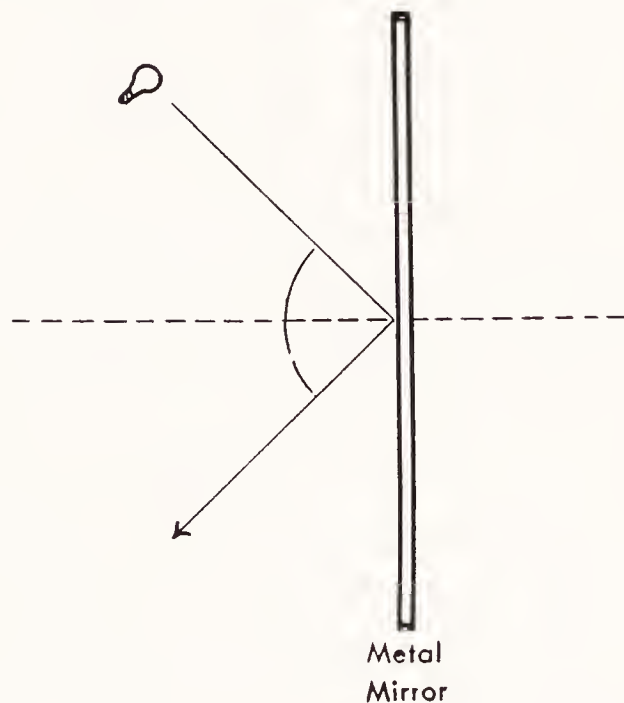

Figure 4

Reflection of a beam of light from a metal mirror.

Refraction. When a beam of light passes from air into another transparent material such as a gem, its velocity is reduced and the beam is bent, unless it strikes the surface of the material perpendicularly (at 90° to the surface). The ratio of the velocity of light in air to its velocity in the new substance is known as the

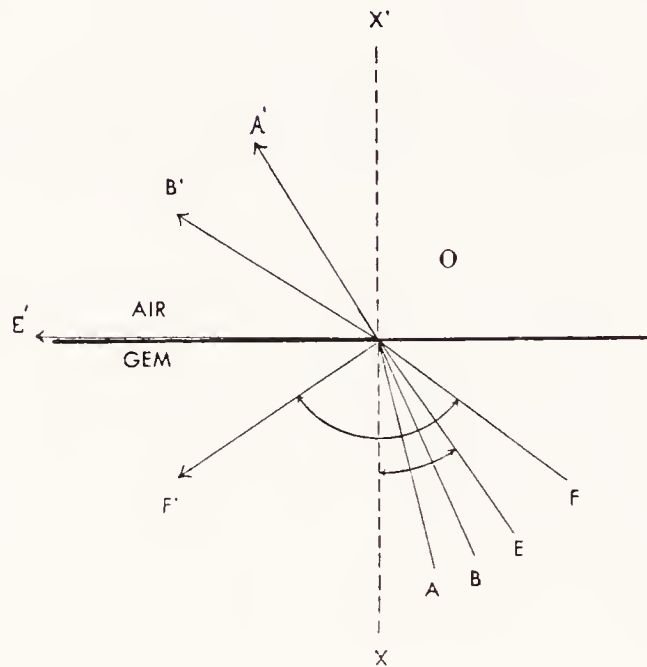

Figure 5

Refraction and total reflection.

refractive index of that substance. Light passing obliquely from air into an optically denser substance is bent *toward* the normal. The *normal* is an imaginary line perpendicular to the surface. (See illustration.) Light coming from a denser substance into air is bent *away* from the normal.

If light passes from one medium into another of unequal optical density in a direction perpendicular to their boundary, no deflection of the light takes place. Light that passes from a gem into air along a path parallel to X-X' in Figure 5 would travel at an increased velocity in the air, but would suffer no bending at the gem's surface. Light entering the gem from the air along a path X'-X would likewise continue in a straight line, but would be reduced in velocity.

A light beam originating at point A in Figure 5 would travel the path designated A-A'. Light from point B, which travels along BO within the gem, would take a direction of OB' when it passed into air. As the angle to XO is increased for light beams that leave the gem at point O, the farther would the light be bent from OX'.

Refractive Index Determination

The maximum possible deflection from OX' would be reached when the light was bent at an angle of 90° as it entered the air. Such a condition is illustrated by path EOE' (Figure 5). Angle EOX is called the *critical angle* for the gem, since any light that impinges on the surface of the gem at point O at an angle greater than EOX would be totally reflected within the gem. Beam FOF' illustrates total reflection. The size of the critical angle is dependent upon the *refractive index* of the material.

Refractive Index is defined as the ratio of the sine of the angle of incidence to the sine of the angle of refraction. It may also be defined as the ratio of the velocity of light in air to its velocity in a given substance. The higher the refractive index of the gem, the smaller its critical angle. Since the size of the critical angle is inversely proportional to the refractive index of any given substance, a measure of the critical angle will determine the refractive index. Gem refractometers are designed to measure critical angles and to translate the reading directly into a refractive-index figure.

The Refractometer. Of the many tests available to the jeweler who attempts to identify an unknown gemstone, the simplest to perform, and perhaps the most valuable in determination, is the measurement of the gem's refractive index on a refractometer. The gem refractometer is an instrument that employs a very high-refractive-index glass hemisphere and measures the critical angle between the glass and the gem to be tested. The first gem refractometer was developed in Europe about 1885, and, until 1946, the only instruments of this nature were made in Europe.

The more recent models have a scale that automatically translates the critical angle reading into the refractive index. Light enters the back of the instrument, comes up through the glass hemisphere, strikes the gem, which is in optical contact with the top of the hemisphere, and is reflected through the lens system of the instrument to the eye. (See Figure 6.) All light that enters at an angle greater than the critical angle between the glass and the substance being measured is totally reflected from that substance and comes through

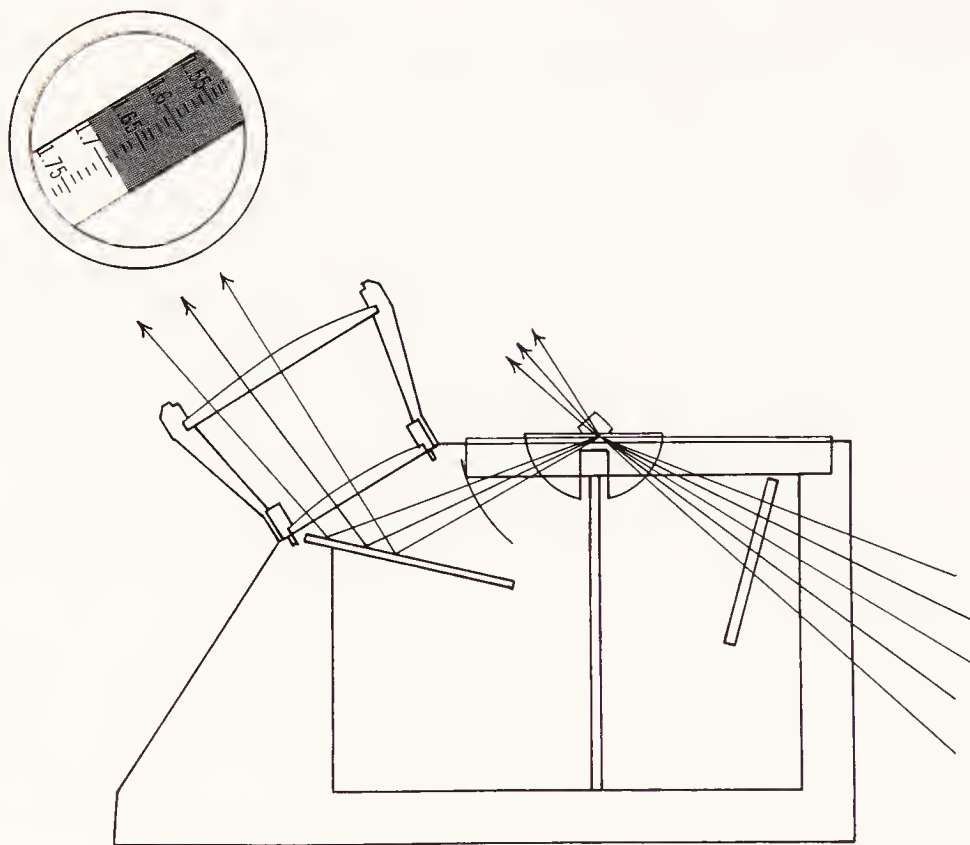

Figure 6
The optical system of the Duplex Refractometer

the scale to the eye. The light that strikes the surface of the unknown gem at less than the critical angle is lost by refraction into the gem. Thus a shadow will be seen on the scale of the instrument up to the point of the critical angle, beyond which the scale will appear bright. (See Figure 13.)

The reading on the scale is easily distinguishable in white light, because a narrow spectrum is visible at the dividing line between the shadowed and the bright portions of the scale, since there is a slightly different critical angle for each of the components of white light. If *monochromatic* light representing a very narrow spectral emission is used, no such spectrum appears; instead, a very sharp division between the shadowed and the bright portions of the scale is visible.

The Rayner and several other refractometers magnify the contact between stone and glass several times, so that only a portion of the contact area is visible. If the eyepiece is removed from the Gem or

Refractive Index Determination

Figure 7
The Rayner Dialdex Refractometer.

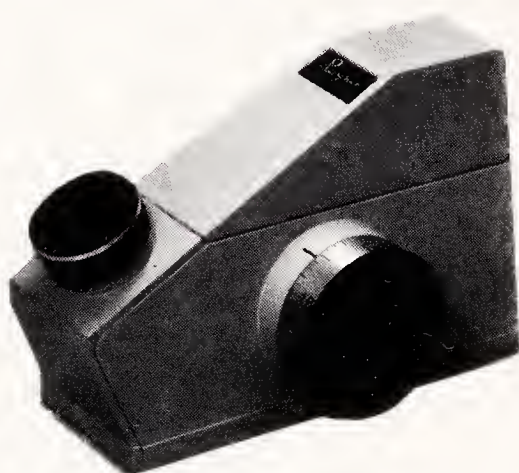

the Erb & Gray and a 2x to 3x lens substituted, or if the Duplex is used without its supplementary lens, the contact between stone and hemisphere can be seen only slightly magnified. The late Lester B. Benson, Jr., discovered that a view of the whole contact area made it possible to obtain accurate readings on curved surfaces and facets with diameters of a millimeter or less from which no reading could be taken with conventional refractometry.

Makes of Refractometers. There are many refractometers made for gemologists to use in identification. The Rayner, made in England, is made in two different models, one with an interior scale and the other which has an exterior scale that is dialed to the reading that is seen on the scale. The latter is called a "Dialdex". There are also instruments made in Japan. In America, Gem Instruments makes the "Duplex". The Duplex is the only refractometer designed to read effectively the so-called spot readings as well as the regular flat surface readings.

The Erb & Gray was the first gem refractometer of American design and manufacture. Like the Tully, the first model had a revolving hemisphere. The Erb & Gray had an adjustable eyepiece mounted on a movable arm. By removing a set screw the eyepiece could be removed from its collar to facilitate spot readings on cabo-

chons and tiny gemstones. This refractometer proved to be exceptionally efficient for both spot and regular readings.

Because of the simple optical system of both models, readings are possible on both instruments on small gemstones and cabochon cuts that give no index reading by normal methods.

Gem Refractometer. The Gem Refractometer, manufactured for several years by the Gemological Institute of America, is a tiny instrument employing a segment of a half cylinder of optically dense glass in a fixed position, and a movable eyepiece. Because there is little magnification, the contact between a stone not covering the hemisphere entirely and the liquid appears as a shadow covering only a portion of the scale, with the reading appearing as a conventional spectrum.

The Duplex Refractometer. The most recently introduced refractometer, the Duplex, is the first designed expressly to read cabochons and tiny stones, as well as large stones with flat facets.

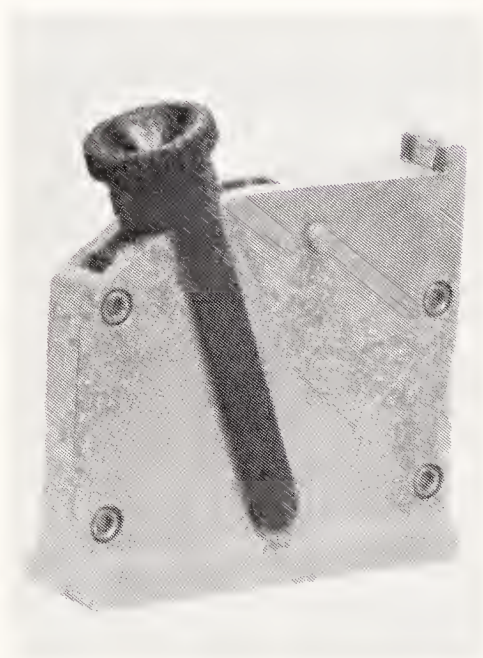

Figure 9

The Gem Refractometer.



Figure 8

The Erb and Gray Refractometer

Refractive Index Determination



Figure 10.
The Duplex II Refractometer.

The Duplex, designed by the late Lester B. Benson, Jr., K. M. Moore and G. M. Johnson, has a large slotted segment of hemicylinder instead of a hemisphere. It was the first instrument to employ a movable mirror instead of a movable eyepiece. A second model, the Duplex II, was redesigned to eliminate the movable mirror. Refractive index tables are attached to both sides of the instrument. (See Figure 10)

The Reflectivity Meter is a new instrument in the gem testing firmament. The reflectivity meter directs a beam of light energy towards the flat polished surface of a gemstone and measures the percentage of light energy returning from the surface. Some of them use an infrared light source rather than a visible light source, and as a result the readings obtained in cases of highly dispersive materials are not always close to the sodium light figures which are quoted in most refractive index tables. The three instruments presently on the market are the "Gemeter," the "Jeweler's Eye,"

HANDBOOK OF GEM IDENTIFICATION

and the "Re-dex." In the "Jeweler's Eye" Dr. Hanneman (its creator) compensated for the different readings due to the infrared source by just showing ranges on a dial rather than refractive indices.

Reflectivity meters are not limited by the 1.81 top reading of a conventional refractometer. Unfortunately, they are much less accurate than conventional refractometers. Readings vary because the readings are dependent on the flatness of the surface, the quality of the polish and the cleanliness of the surface in addition to the actual refractive index. Even the seemingly flat, well-polished surfaces of some gem species often give greatly different readings.

How to Use the Refractometer. The refractometer, the most useful instrument available for gemtesting, is also the most delicate. Since the glass hemisphere or prism on which the gem is placed must have a refractive index well above that of the gem, it is necessary to use a glass that has a very high lead-oxide content. The large percentage of lead oxide results in a glass not only very soft, but also easily corroded. The gems to be tested usually are much harder than the glass. Use every precaution to avoid scratching the glass by placing the gem on the instrument with care.

To produce an optical contact between the gem and the glass, a liquid of higher refractive index than that of the gem must be used. The liquid used on the refractometer is a saturated solution of sulphur in methylene iodide, with tetraiodoethylene added. Pure methylene iodide has an index of about 1.74. The addition of sulphur to the saturation point increases the refractive index to about 1.79, and the addition of tetraiodoethylene brings the index to 1.81.

Such a liquid is highly corrosive, and must not be left in contact with the glass any longer than it takes to make the refractive-index reading — if it remains on the hemisphere, it oxidizes the glass, leaving a tarnish film that seriously reduces the efficiency of the instrument. The liquid must be removed from the hemisphere immediately after the reading is made. Since most tissues have harsh fibers that will scratch the glass surface in time, special lens tissue should be used to remove the high refractive-index contact liquid.

Refractive Index Determination

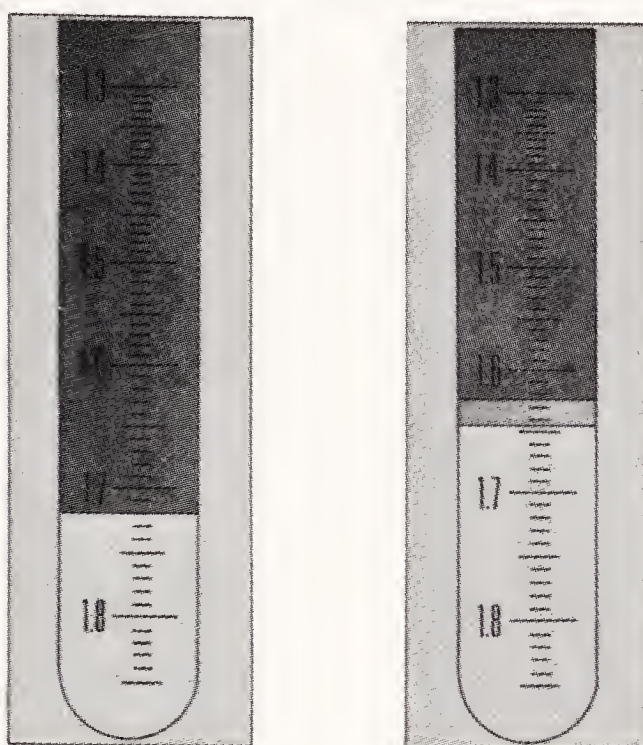

Figure 12

*Left, refractive index reading for a singly refractive gem (spinel).
Right, typical readings for the strongly doubly refractive tourmaline.*

the glass. Change the position of the light to avoid missing a faint reading, and move your eye back and forth in relation to the eyepiece of the instrument. When using the Duplex, Erb & Gray or Gem Refractometer, place the gem's largest facet over a small drop of R. I. liquid on the center of the hemisphere. Remove the eyepiece and find the image of the contact area on the scale. Starting at the low-number end, follow the shadow up the scale until it either terminates at 1.81, the R.I. of the liquid, or at a blue-green line — the reading for the gemstone. If the shadow continues to the 1.81 liquid line, the gem has an index above that figure. If the shadow does not extend that far, but no clear reading is observed, remove the gem from the hemisphere to clean both the glass surface and the gem. If the gem has other large facets, try to read the refractive index from a second facet. Occasionally, a sulphur crystal or dust will prevent optical contact between the gem and the glass hemisphere. If no reading is obtained by this method, or if the reading is faint and questionable, check it by the spot method described on the next page. Many gemologists use the spot method to find the

position of the reading as the first step in the determination of every refractive-index reading.

If a reading is obtained, the scale will be relatively dark from its low-number end to the reading, which will appear as a narrow spectrum dividing the dark and brightly lighted portions of the scale. If the gem is strongly doubly refractive, two such spectra may appear between the dark and brightly lighted portions of the scale. In the average doubly refractive gemstone, the reading in white light appears as a broad single reading. Double refraction may be proved by rotating a Polaroid plate quickly before the eyepiece, causing the line to jump back and forth between the high and low readings.

With transparent gemstones, it is possible to cover the light portal and direct the light source through the stone from above and behind it. This reverses the scale reading, since the high-number portion of the scale is in shadow and the low end is brightly lighted. The spectrum denoting the reading is predominantly red, in contrast to the blue-green of the normal reading.

If the gem has an index above that of the contact liquid (1.81), no reading will be visible, but the shadow will be unbroken up to the refractive index of the liquid, which is shown by a single line at 1.81 on the scale. No gem with an index that is higher than 1.81 will give a reading on the refractometer, but the shadow should extend to 1.81, the liquid index. By normal methods, no reading will be observed on cabochon-cut gems, on very poorly polished gems, or on those without facets large enough to give a reading. However, such stones often yield readings by the spot method.

Spot Method. The effectiveness of the refractometer as a gem-testing instrument was increased materially as a result of a development by the late Lester Benson¹. Benson discovered that removal of the eyepiece of the Erb & Gray Refractometer makes possible the resolution of the contact between gem and hemisphere as a small spot on the scale, the observation of which discloses readings on tiny gemstones, cabochons and seemingly opaque materials not ordinarily readable on a refractometer. Later, Crowningshield²

1. *Gems & Gemology*, Vol. VI, No. 2, Summer 1948, page 35.

2. *Gems & Gemology*, Vol. VI, No. 6, Summer 1949, page 176.

Refractive Index Determination

found that similar readings were possible on more complex refractometers, if the scale were viewed at a distance of 18 inches or more from the eyepiece.

To obtain a reading by the spot method, a minute drop of contact liquid should be used. If the drop has a diameter of more than one quarter millimeter when resting on the gem surface or hemisphere, a portion of the liquid should be removed. After placing



Figure 13

If the spot is dark at 1.56, and light at 1.58, the reading is near 1.57

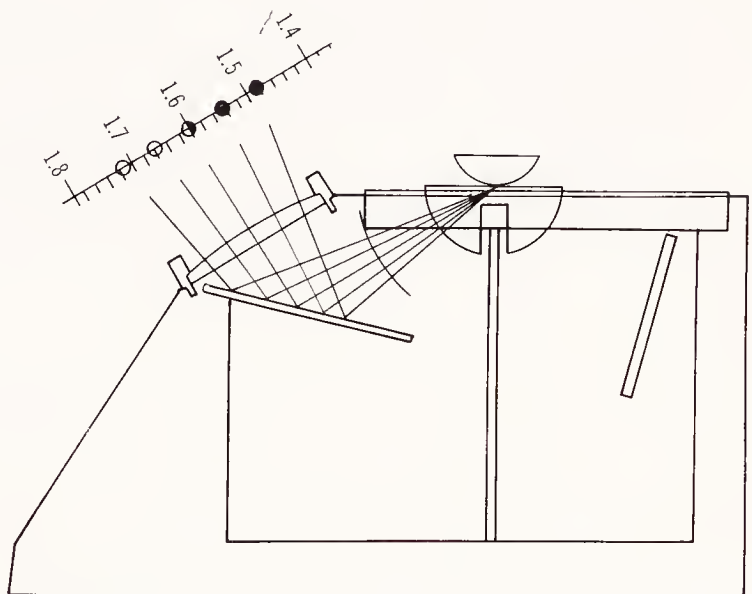

Figure 14

Schematic Diagram of a cabochon of 1.60 refractive index on the Gem Refractometer viewed from five angles. As the eye is moved, the spot remains dark at the low number end of the scale, until the reading approaches, when the edge of the shadow appears. The reading is made when the spot is half light and half shadowed.

HANDBOOK OF GEM IDENTIFICATION



Figure 15

Duplex refractometer showing table of indices, and with auxiliary lens removed for spot reading

the gemstone over the droplet, the scale should be viewed from a distance of 12 to 18 inches (after moving the eyepiece arm out of the line of vision of the Erb & Gray or Gem refractometers). The proper eye-to-eyepiece distance, when using the Duplex Refractometer for this method, is about 10 to 16 inches.

To prolong the life of the hemisphere's top surface, at the key center point, it is wise to place the drop of liquid near the front or back of the rectangular surface for a spot reading. The gem is touched against the droplet of liquid, and then the dot of liquid on the curved gem surface is lowered gently to the center of the hemisphere's surface.

For maximum accuracy, ultimately, the spot should be reduced to not more than two to three scale divisions with the stone resting

Refractive Index Determination



Figure 16

A spot reading being taken on a small cabochon

on the hemicylinder. The eye is held over the center of the eyepiece and the mirror is moved to permit the scale to be scanned. The point of contact between gem and hemisphere will appear as a spot on the scale, with the shape of the spot conforming to that of the gem surface (i.e., round or oval with cabochons, the shape of the facet of a faceted stone which is resting on the hemisphere). The spot appears to move in relation to the scale as the angle of observation changes. If the eye is looking directly down on the low-number portion of the scale and the gem has a high index, the spot will appear entirely dark. If the portion of the scale numerically higher than the reading is viewed directly, the spot will appear as a ring

with a light center. At the point on the scale corresponding to the refractive index of the stone, the spot will be half dark and half light, often showing the conventional blue-green spectrum at the division between light and dark. (See Figure 14). In general, the dark half is on the low-number end of the scale, but curved surfaces, while conforming to the results described above otherwise, may give readings that are light on the low-number half of the spot at the correct reading, and dark on the high-number half.

Caution: If the spot is as small as it should be, the change of the spot from dark to light is often abrupt as the eye moves toward the higher numbers. There may be no color visible at any point, and no point of half light and half dark.

When using any instrument but the Duplex, which was designed for the purpose, often the beginner finds difficulty in resolving the numbers on the scale at the same time the spot is in focus. On the Rayner, it is necessary to move the eye down to the eyepiece (or close enough to resolve the scale numbers). Then the eye is withdrawn slowly, while observing a number, until the spot is again in focus. When using the Erb & Gray, a 2x or 3x lens may assist the tester. Practice soon permits the gemologist to resolve spot and scale together. One who is farsighted may need to resort to a very low-powered magnifier to bring the scale into focus when the spot is clear.

Readings in White Light. If the light source used to obtain the refractive-index reading is daylight or an ordinary electric-light source, the narrow spectrum representing the reading will appear predominantly blue-green, with a very narrow yellow band. The reading will correspond most closely to refractive-index tables, if it is read at the division between the yellow and green lines, since such tables usually give the index of the material for sodium light.

If the light portal is covered and light directed through the gemstone from above and behind, the high-number end of the scale appears black and the reading appears as a red line across the scale between the black and lighted portion of the scale.

Readings in Monochromatic Yellow Light. The sharpest and most accurate readings on a refractometer are obtained with the

illumination, if the filter is removed. The readings are almost exactly .01 lower than those in sodium light, but are nearly as sharp. If the .01 correction factor is applied, they are very satisfactory. A cardboard mask shaped to replace the Mineralight filter, leaving a small opening for the light to reach the refractometer light portal, provides a protection to the gemologist's eyes.

A Wratten A red-gelatin filter sharpens readings very effectively, but the result is usually about .005 above sodium-light readings. Since most of the highly dispersive gem species have indices above the limits of the refractometer, the use of a red filter does not lead to gross errors of index when a .005 correction is used.

Cleaning the Refractometer. When the refractive-index reading has been made, wipe the hemisphere surface clean with lens tissue. Apply a cleaning fluid, such as xylene, with lens tissue, to prevent corrosion of the glass by the high-index liquid. If the refractometer is not to be used again for a day or two, coat the surface with a thin layer of Vaseline as a further protection. Tarnish that in time covers the hemisphere surface can be removed, if a paste made of cerium-oxide powder and water is used as a polish and applied to the hemisphere surface with the fingertip. This should not be done until readings have become faint. Pure methylene iodide provides an effective solvent for sulphur deposits on or around the hemicylinder.

Other Means of Determining Refractive Index. Of the several other means of determining refractive index, none of which is as satisfactory as determination by the refractometer, the simplest is the *approximate immersion method*.

Determination of Approximate Refractive Index by Immersion. When a gem is placed in a liquid, the degree to which it is visible in the liquid depends upon the proximity of its refractive index to that of the liquid. (See Chapter VII for list of immersion liquids.) As the indices of the gem and the liquid approach the same value, the outline of the gem becomes less distinct. If the gem is almost invisible, its index very closely approximates the index of

Refractive Index Determination

the liquid. Thus, a hessonite garnet becomes almost invisible in methylene iodide, since the index of this garnet is about 1.74 — the refractive index of the liquid. Topaz and tourmaline nearly disappear when placed in cinnamon oil, which has an index of about 1.62. This immersion method is useful for the determination of approximate index, but fails to provide the exact readings obtained on the refractometer.

B. W. Anderson pointed out that faceted stones lower in index than the liquid are easily distinguished from those of higher index by the appearance of the girdle and facet junctions. A flat-bottomed dish is placed over white paper and a liquid of known index is poured in. Gems are laid in the dish table down and a single lamp is placed over the tray. If the index of the gem is lower than that of the liquid, it casts a bright-edged shadow and facet junctions appear as black lines. If the stone is higher than the liquid in index, the shadow is dark edged and the facet edges appear as bright lines. The thickness of the bright or dark rim is a measure of the difference in index between liquid and stone. The rim may be colored, if the index or indices of the stone is or are almost identical to that of the liquid.

The facet-junction and stone-edge appearances described are those seen when the magnifier is focused within the gemstone. Both Mitchell and Schlossmacher pointed out that these conditions reverse when the focus is raised to a point above the gem; i.e., bright facet junctions become dark and vice versa.

For this purpose, liquids of fairly high index and low density are ideal, so that even gems of low S.G. do not float. A floating gem has to be held down. Good liquids are monobromobenzene (1.56), monoiodobenzene (1.62), monobromonaphthalene (1.66), and monoiodonaphthalene (1.704).

By placing a photographic printing paper below the glass, photographs of results may be made.

The Becke Line. The most common mineralogical means of refractive-index determination makes use of the Becke effect. The mineralogist powders samples of the unknown and places a drop

Refractive Index Table

Rutile & Syn.	2.616		2.903
Anatase	2.493		2.554
Diamond		2.417	
Strontium titanate		2.409	
Stibiotantalite	2.37		2.45
Sphalerite		2.37	
Syn. Cubic Zirconia		2.17(± .03)	
GGG		2.02	
Zincite	2.013		2.029
Cassiterite	1.997		2.093
Zircon (high)	1.925		1.984
Scheelite	1.918		1.934
Sphene	1.900(± .018)		2.034(± .020)
Zircon (medium)	1.875(± .045)		1.905(± .075)
Andradite garnet		1.875(± .020)	
YAG		1.833	
Zircon (low)	1.810(± .030)		1.815(± .030)
Spessartite garnet		1.81(± .010)	
Gahnite		1.80	
Almandite garnet		1.79(± .030)	
Painite	1.787		1.816
Corundum	1.762(− .003, + .007)		1.770(− .003, + .008)
Synthetic corundum	1.762		1.770
Rhodolite garnet		1.76(± .010)	
Gahnospinel		1.76(± .02)	
Benitoite	1.757		1.804
Pyrope garnet		1.746(− .026, + .010)	
Chrysoberyl	1.746(± .004)		1.755(± .005)
Synthetic alexandrite	1.742(± .004)		1.751(± .005)
Staurolite	1.736		1.746
Grossularite garnet		1.735(+ .015, − .035)	
Azurite	1.73(± .010)		1.84(± .010)
Synthetic Spinel		1.73(± .01)	
Rhodonite	1.73		1.74
Epidote	1.729(− .015, + .006)		1.768(− .035, + .012)
Taaffeite	1.719		1.723
Spinel		1.718(− .006, + .044)	
Kyanite	1.716(± .004)		1.731(± .004)
Idocrase	1.713(± .012)		1.718(± .014)
Zoisite	1.691(± .002)		1.704(± .003)
Willemite	1.69		1.72
Rhodizite		1.69	
Dumortierite	1.678		1.689
Axinite	1.678		1.688
Diopside	1.675(− .010, + .027)		1.701(− .007, + .029)
Sinhalite	1.668(± .003)		1.707(± .003)
Kornerupine	1.667(± .002)		1.680(± .003)
Jadeite	1.66(± .007)		1.68(± .009)
Malachite	1.66		1.91
Spodumene	1.660(± .005)		1.676(± .005)
Jet		1.66(± .020)	
Sillimanite	1.659		1.68
Chlorastrolite	1.65		1.66
Enstatite	1.658(± .005)		1.668(± .005)
Dioptase	1.655(± .011)		1.708(± .012)
Peridot	1.654(± .020)		1.690(± .020)
Euclase	1.654(± .004)		1.673(± .004)
Phenakite	1.654(− .003, + .017)		1.670(− .004, + .026)
Apatite	1.642(− .012, + .003)		1.646(− .014, + .005)
Andalusite	1.634(± .006)		1.643(± .004)

Refractive Index Table

Danburite	1.630(± .003)	1.636(± .003)
Datolite	1.626	1.670
Tourmaline	1.624(± .005)	1.644(± .006)
Smithsonite	1.621	1.849
Topaz	1.619(± .010)	1.627(± .010)
Prehnite	1.615	1.646
Turquoise & Syn.	1.61	1.65
Lazulite	1.612	1.643
Amblygonite	1.612	1.636
Bakelite	1.61(± .06)	
Nephrite	1.606	1.632
Brazilianite	1.602	1.621
Odontolite	1.60(± .03)	1.61(± .03)
Ekanite	1.597	
Rhodochrosite	1.597	1.817
Verdite	1.580	
Beryl	1.577(± .016)	1.583(± .017)
Augelite	1.574	1.588
Synthetic emerald (New Gilson)	1.571	1.579
Pseudophite	1.57	1.58
Synthetic emerald (hydrothermal)	1.568(± .02)	1.573(± .02)
Synthetic emerald (flux)	1.561	1.564
Variscite	1.56	1.59
Serpentine	1.56(- .07)	1.570(- .07)
Coral (black & golden)	1.56(± .01)	1.57(± .01)
Ladradorite feldspar	1.559	1.568
Hambergite	1.555	1.625
Beryllonite	1.552	1.562
Agalmatolite	1.55	1.60
Scapolite	1.55	1.572
Quartz & Syn.	1.544(± .000)	1.553(± .000)
Iolite	1.542(- .010, + .002)	1.551(- .011, + .045)
Steatite	1.54	1.590
Amber	1.540	
Chalcedony	1.535	1.539
Apophyllite	1.535	1.537
Albite-oligoclase	1.532(± .007)	1.542(± .006)
Pollucite	1.525	
Microcline	1.522	1.530
Orthoclase	1.518	1.526
Stichtite	1.516	1.542
Thomsonite	1.515	1.540
Leucite	1.508	
Petalite	1.502	1.518
Lazurite (lapis-lazuli)	1.500	
Obsidian	1.500	
Lucite	1.495(± .005)	
Calcite	1.486	1.658
Coral	1.486	1.658
Sodalite	1.483(± .003)	
Glass (normal)	1.48-1.70	
Glass (extreme)	1.44-1.77	
Moldavite	1.48	
Opal	1.45(- .080, + .020)	
Synthetic opal	1.44	
Fluorite	1.434	

HANDBOOK OF GEM IDENTIFICATION

of liquid of known refractive index over a small portion of the powder on the glass slide. The grains are examined under high magnification. When the light is transmitted through the liquid and grains of the unknown material, each grain appears to have light edges. When the tube of the microscope is raised, the bright edge (the so-called Becke line) moves toward the higher index. This is useful when a few grains of material can be taken from the rough, or scraped from the girdle of a cut stone. It is also useful to determine whether inclusions have higher or lower indices than the host gem material. A set of refractive-index liquids in steps of .01, from under 1.5 to over 1.8, are available.

Determination of Refractive Index with a Microscope. The Duc de Chaulnes method of obtaining refractive indices is one that is easily applied by anyone who has a Gemolite or other binocular microscope capable of high magnification. For reasonable accuracy it is necessary to use a 2X adaptor lens on the microscope.

The Duc de Chaulnes method requires measuring the actual total depth of a stone from table to culet by gauge or micrometer and then the apparent depth with the microscope. The actual depth divided by the apparent depth gives the refractive index. If 90X is used by attaching a 2X adaptor and the Deluxe Gemolite's magnification knob is turned to 3, it narrows the plane of focus sufficiently for good accuracy in the use of this method. On a Custom A Gemolite, the knob is turned to 4.2 to obtain 126X with a 2X adaptor. The problem is to measure the apparent depth.

This can be accomplished in a number of ways: such as using a dial micrometer mounted on a Gemolite. It is also easy enough to rig up a pointer and a scale on the rack and pinion so that the measurements can be made. One rough way is simply to put a point on one side and a finely divided ruler is mounted along the other side of the rack and pinion assembly.

After focusing on the table, record the scale reading. Then focus through the stone to the culet and take a second reading. To get the apparent depth of the stone subtract the smaller reading from the larger.

Refractive Index Determination

If nothing else is available a GIA table gauge can be taped to the stationary side of the rack and pinion, and a mark made on the moveable side. Using a loupe and a penlight it is possible to read the table gauge quite accurately. It is not accurate enough if one is using just 45X; it is necessary to use the full magnification plus a 2X adaptor lens to achieve a satisfactory degree of accuracy.

Chapter VI

Double Refraction, Pleochroism, and Optic Character

When light is moving through air or any other gas, its waves may undulate or vibrate in any direction perpendicular to the direction of transmission. All liquids and some solids reduce the velocity of light from its velocity in air without offering restrictions other than partial absorption. Such liquids and solids are said to be *isotropic*, since the velocity of light is the same in all directions of transmission. All *amorphous* solids, such as opal and glass, and all materials that crystallize in the cubic system, are isotropic, or singly refractive. Isotropic materials have but a single refractive index for any given wavelength of light.

Solids that crystallize in the other five crystal systems have a more complicated effect upon light as it is transmitted through them. Light is forced to vibrate in two planes at right angles, and the light vibrating in one of these directions is retarded in velocity more than the other; hence, such materials have two indices of refraction. As a result, a single ray of light that enters a gem crystallized in any but the cubic crystal system is broken into two rays. Each of the two rays, vibrating in a single plane, is said to be *plane polarized*. Solids that break light into two polarized beams as it is transmitted through them are said to be *anisotropic*, or *doubly refractive*. The measure of the ability of a solid, such as a gem, to convert a single ray of light into two rays having unequal velocity is called *birefringence*. The numerical value for a gem's birefringence is obtained by subtracting the lowest refractive index from the highest given for that gem. A table of birefringence of gemstones follows:

Double Refraction, Pleochroism, and Optic Character

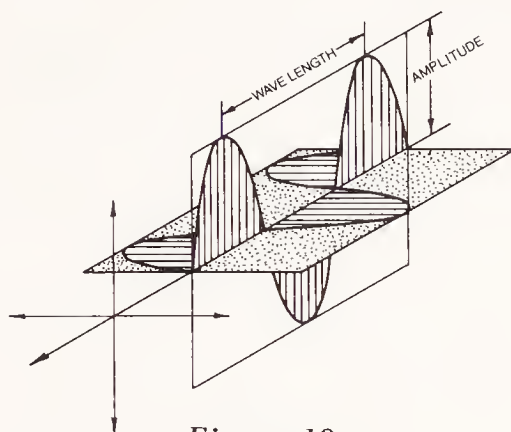

Figure 18.
The wave motion of plane-polarized light.

Birefringence Table

Apatite	.002 - .006	Spodumene	.016
Syn. Emerald (flux melt)	.003	Tourmaline	.018 - .020+
Zircon (low)	about .005	Euclase	.019
Beryl	.005 - .009	Brazilianite	.019
Danburite	.006	Diopside	.026
Andalusite	.008 - .013	Peridot	.036
Corundum	.008	Epidote	.039
Topaz	.008	Sinhalite	.039
Chrysoberyl	.009	Datolite	.044
Quartz	.009	Benitoite	.047
Beryllonite	.010	Diopase	.053
Enstatite	.010	Zircon	up to .059
Rhodonite	.010	Cassiterite	.096
Jadeite	.013	Azurite	.110
Kornerupine	.013	Sphene	.134
Sillimanite	.015 - .021	Calcite	.172
Kyanite	.015	Smithsonite	.228
Phenakite	.016	Malachite	.250
Scheelite	.016	Syn. Rutile	.287

Gems that crystallize in the hexagonal and tetragonal systems, such as sapphire, zircon, quartz and tourmaline, have one direction (*optic axis*) in which they fail to polarize light. Such doubly refractive, or anisotropic, materials with one direction of single refraction are said to be *uniaxial*.

Double Refraction, Pleochroism, and Optic Character

Determination of Double Refraction Under Magnification.

When zircon is examined through a loupe, the lines formed by the junction of facets appears as pairs of parallel lines when viewed through the stone, unless it is examined in the one direction of single refraction or exactly at right angles thereto. At right angles to the direction of single refraction, there is a maximum difference in velocity between the two beams, but they appear one behind the other, rather than having been bent unequally. If high magnification is used, doubling of the facet edges on the side of the gem away from the objective should be seen, even in gems having very low birefringence, unless the direction of observation is parallel to or perpendicular to an optic axis. Parallel to the optic axis is a direction of single refraction. Perpendicular to the optic axis is the direction of maximum birefringence, but one image is directly behind the other, thus, doubling of facet junctions is not noted. Since doubly refractive gems have directions of single refraction, absence of doubling of facet junctions should not be interpreted as evidence of single refraction, unless the stone has been observed in more than two directions. In a direction of maximum birefringence, gems of one-carat size with a birefringence of .004 or more should show doubling under a magnification of 30 or more diameters. The edges of inclusions within gems often show doubling under magnification. While the absence of double images should not be interpreted as proof of single refraction, their presence is proof that the gem is doubly refractive.

Rotation of a Polaroid plate over the eyepiece will cause the two images caused by double refraction to appear individually and to seem to jump back and forth. If the gem is dichroic, the images may be different in color.

Estimating Birefringence. Doubling of opposite facets and inclusions is, of course, proof of double refraction. By the amount of doubling, the examiner can estimate roughly the birefringence of the gem. By examining a zircon, a peridot, a tourmaline and a sapphire of about the same depth, the microscopist can get an idea of relative birefringence that will enable him to judge an unknown fairly accurately. It is important to remember that there are directions in which no birefringence is visible in doubly refractive stones, so relative birefringence should be judged after an examination in a direction of maximum doubling.

HANDBOOK OF GEM IDENTIFICATION

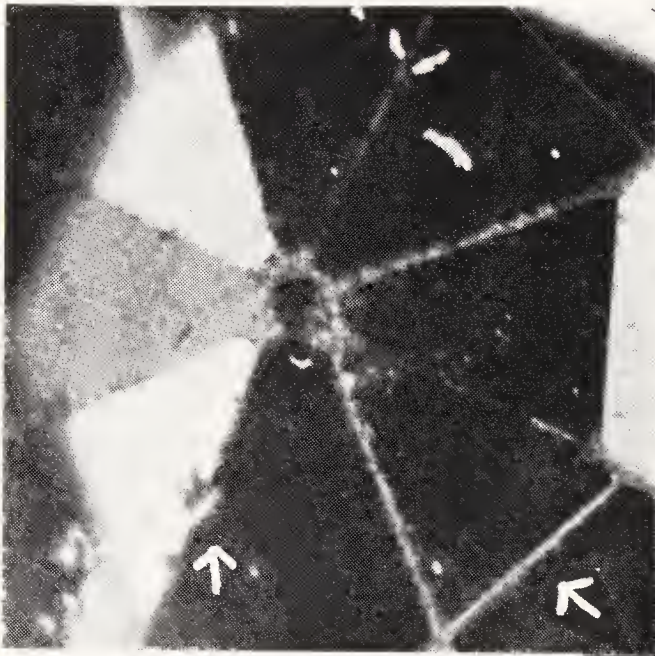

Doubling of opposite facet junctions in corundum.

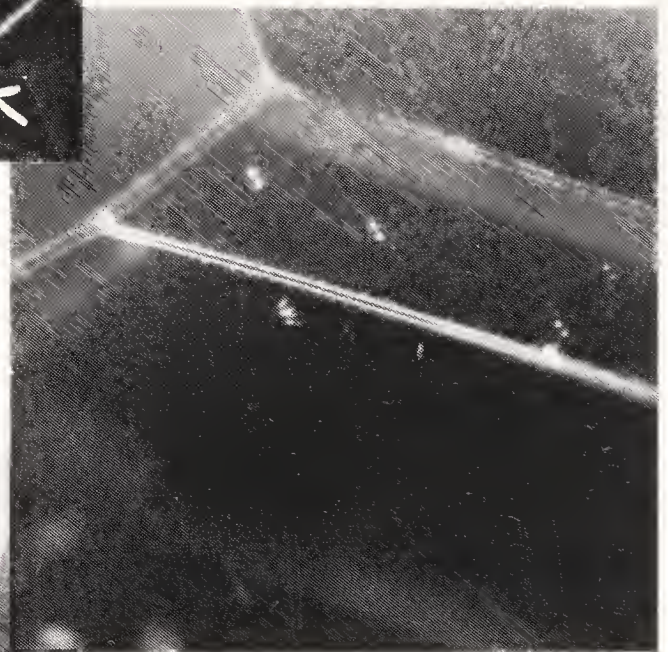

Doubling in tourmaline.

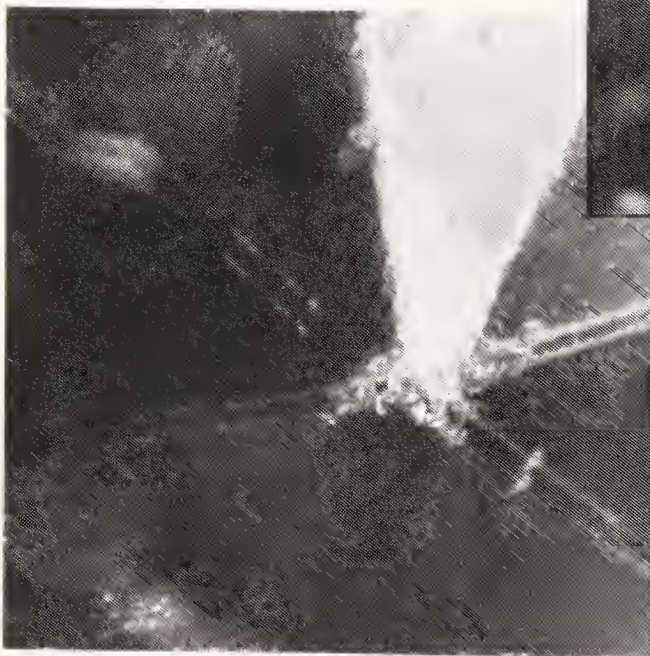

Doubling in zircon.

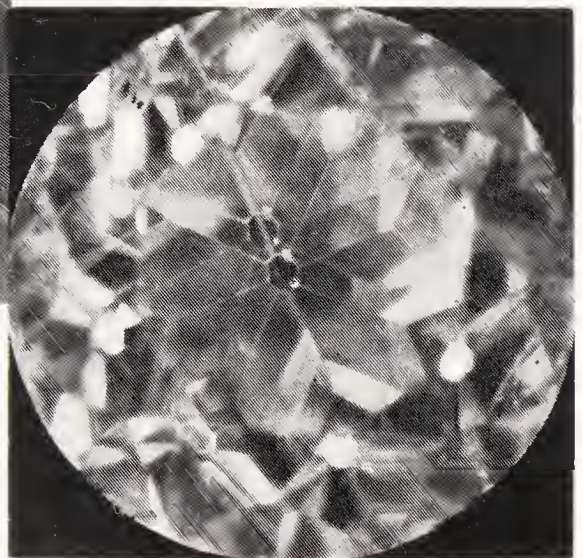

Doubling in synthetic rutile.

Figure 20

Double Refraction, Pleochroism, and Optic Character

The Reflection Test for Double Refraction. A simple test for double refraction in transparent faceted gems that requires no instruments is the reflection test. Cut a hole one-eighth to one-fourth inch in diameter in a piece of white cardboard or stiff white paper. Hold the card so that sunlight or light from a powerful lamp passes through the hole and falls upon the crown of the gem. Light entering the crown will be reflected from the pavilion facets and refracted from the crown back to the lower side of the card to form a pattern of small dots. The dispersion of the gem often causes a pattern of rainbow spots. If the gem is doubly refractive, the spots will appear on the card in pairs.

The Polariscopes. Perhaps the simplest, yet one of the most valuable, instruments used in gem identification is the *polariscope*. Although polariscopes had been used for more than a century, it was not until 1935 that one designed especially for gemtesting by Robert Shipley, Jr., was placed on the market. Since a polariscope is both efficient and inexpensive, it has become standard equipment in almost every American gemtesting laboratory. The polariscope consists essentially of two Polaroid plates mounted a sufficient distance apart to permit gems to be examined between them. Usually, the lower Polaroid is fixed in position and the upper may be rotated.

The Illuminator Polariscopes. The polariscope in widest use today is that known as the *Illuminator Polariscopes*. This instrument has a single casting to mount a lamp and two Polaroid plates. The lamp is housed in the base, just beneath the lower Polaroid, or polarizer. The upper Polaroid plate (analyzer) may be rotated in a plane parallel to the polarizer. It is held between three and four inches above the polarizer on an arm extending over the lower plate. A light portal at the front of the instrument serves as a light source both for the refractometer and the dichroscope.

A stone to be examined in the polariscope may be held in stone tweezers, the tester's fingers, or in an immersion cup made to fit both the Illuminator Polariscopes and the Gemolite. Perhaps the

easiest and most convenient method is to use the fingers to manipulate the stone.



Figure 21
The Illuminator Polariscope

How to Use the Polariscope. All gemtesting polariscopes are operated on the same principle. Gems are examined between crossed Polaroids; i.e., with the vibration direction of the analyzer turned at right angles to that of the polarizer. This is the dark, or extinction, position. When the upper Polaroid has been turned to the position of minimum light passage, examine the stone between the two plates. Since the light analyzed is that transmitted through the gem, only those with sufficient transparency to transmit light may be analyzed by this method. If the stone darkens and becomes light each 90° of rotation, double refraction is indicated. If it remains dark, it is singly refractive. In a doubly refractive stone the change varies from an abrupt light to darkness across the whole stone to one in which only a dark band moves across the transparent stone as it is rotated. The difference depends on the relationship of the tester's angle of view to the optic axis of the stone. At right angles to an axis, the change is abrupt.

Double Refraction, Pleochroism, and Optic Character

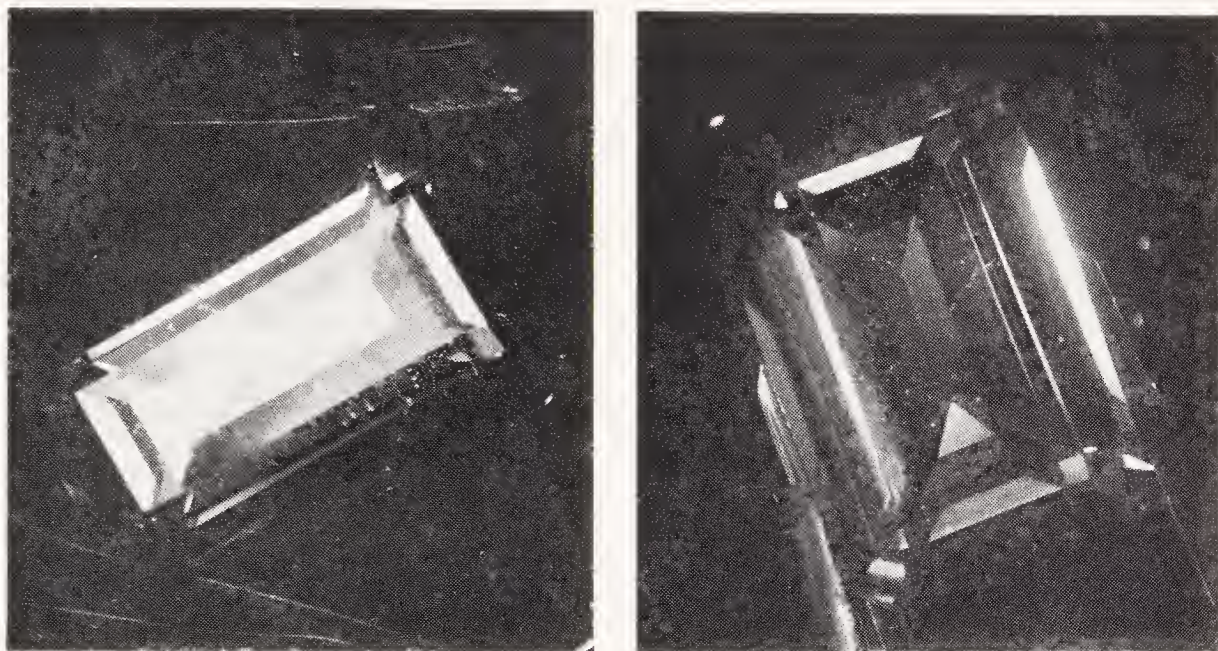

Figure 22

Behavior of a doubly refractive stone in the polariscope. At left, the gem is light; at right, a 45-degree turn of the cylinder twists the stone to its dark position.

From right angles to an optic axis to from 75° to perhaps 45° (depending on the shape of the stone, whether it is faceted, its index level, whether uniaxial or biaxial and other factors), abrupt changes are usual. Closer to the optic-axis direction, a band of dark moving across a usually light stone is to be expected. Within a few degrees of parallel to the optic axis, colors are usually visible in a doubly refractive stone. The significance of the colors is discussed in a later section in this chapter.

Cautions. Since doubly refractive gems have one or two directions of single refraction, it is necessary to examine them in more than two directions before assuming the gem to be singly refractive. Brilliant-cut gemstones should not be examined in a table-up or table-down position, because all light entering the crown may be totally reflected back in the same direction. Such stones should be examined through the girdle or a side of the crown and the opposite side of the pavilion.

The jeweler must watch for singly refractive materials that show a condition (caused by strain within the gem) called *anomalous*

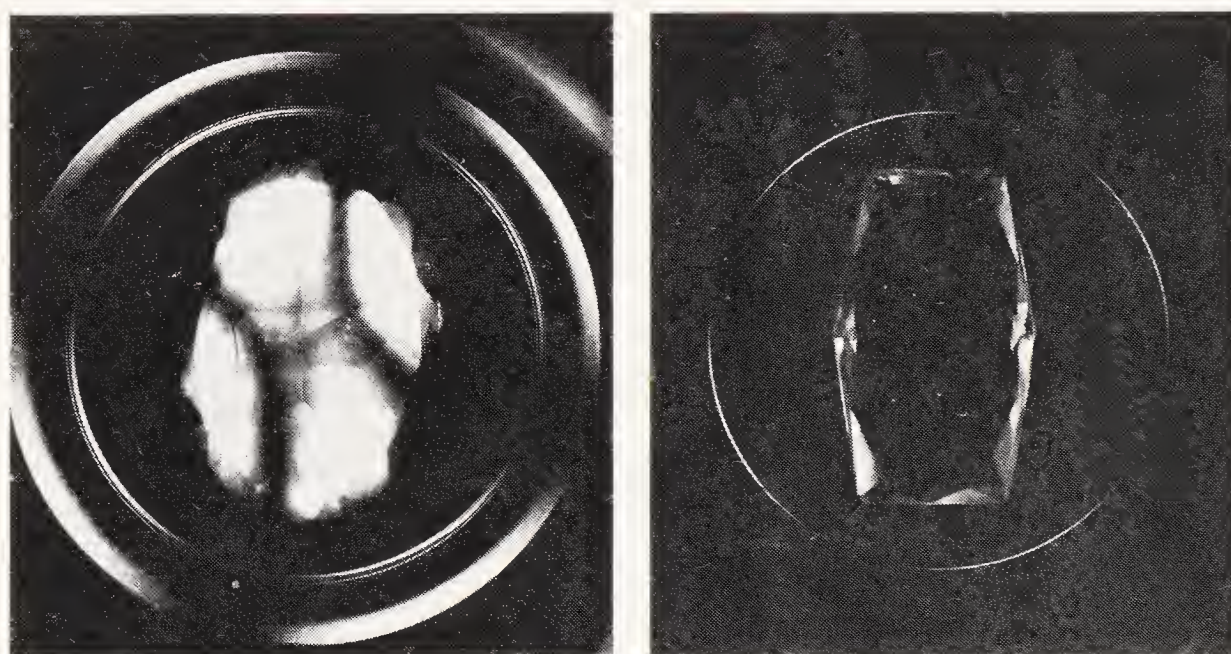

Figure 23

Left. Anomalous double refraction as seen in some glass imitations. Right. A singly refractive stone, which remains dark in all positions in the polariscope.

double refraction, which may be confused with true double refraction. Garnet, synthetic spinel, diamond, amber, plastic, translucent opal and glass are likely to exhibit this effect. Amber and plastic are likely to be so strained that they may show colors in a patchy distribution. Rarely, a highly strained diamond shows the same effect.

The Polariscope Test for Anomalous Double Refraction.

Turn the upper Polaroid plate to the position in which minimum light transmission through the instrument is permitted. Rotate the stone between the plates. If the intensity of the light passing through the stone changes, turn the stone until it is in the position allowing maximum light transmission. To determine whether the intensity change is caused by true or anomalous double refraction, turn the upper Polaroid until the polariscope allows maximum light transmission while holding the stone in a fixed position.

If the light coming through the stone increases as the upper Polaroid is rotated, anomalous double refraction in a singly refractive gemstone is indicated.

Double Refraction, Pleochroism, and Optic Character

Figure 24

A doubly refractive crystalline aggregate that remains light when rotated between crossed Polaroids



If the light coming through the stone either remains constant or decreases during the process, true double refraction is suggested. However, some red garnets react in this fashion. Since ruby, which they may resemble, is strongly dichroic, the dichroscope separates the two gemstones. The spectroscope serves the same purpose.

Doubly Refractive Crystalline Aggregates. When doubly refractive material is composed of a large number of tiny crystals, it causes a distinctive effect in the polariscope. When the two Polaroids are in the crossed, or dark, position, such gems will appear uniformly bright as the gemstone is rotated. Translucent chalcedony and jade always react in this manner in the polariscope. The failure to extinguish in any position is a consequence of the random orientation of the multitude of tiny crystals that comprise the aggregate. In all positions of the stone, a sufficient number of the small crystals are oriented in a direction in which light may pass, so that the gem will never darken. Some corundum also fails to extinguish in the polariscope. As a result of repeated twinning, certain sets of thin plates are in the dark (extinction) position while the alternate parallel plates are not; hence the gem appears light in all positions.

Translucent glass imitations may react similarly to doubly refractive aggregates in the polariscope, particularly if they have

a rough back surface. In this event, tiny surface fractures displaying a vitreous luster distinguish glass from most crystalline aggregates used as gemstones. The polariscope reaction is not dependable for semitranslucent materials in which the only light transmitted is a minimum amount through thin edges. Under these conditions, singly refractive materials often give results similar to those of doubly refractive aggregates. Badly fractured stones and those full of inclusions may give similar results.

Pleochroism. Light that is transmitted through doubly refractive gems vibrates in two planes at right angles, with the two beams suffering unequal reduction in velocity. Traveling separate paths at different velocities, the two beams often suffer unequal absorption in colored anisotropic gemstones and emerge as different colors. This property is called *pleochroism*. Pleochroic gems in the hexagonal and tetragonal crystal systems show two different colors and are said to be *dichroic*.

Dichroism is described as *strong, distinct or weak*. Ruby, for example, shows very strong dichroism; emerald, distinct dichroism; citrine quartz, weak dichroism.

Pleochroic gems that crystallize in the orthorhombic, monoclinic and triclinic systems may show three colors when viewed in various directions, but more often only two are easily distinguishable. Those in which three colors can be distinguished are said to be *trichroic*. Trichroism is described in the same manner as dichroism. Ruby, sapphire, emerald and zircon are dichroic; the alexandrite variety of chrysoberyl is trichroic.

Pleochroism often can be seen without instruments, if the gem is examined from different directions. To see more than one color in any single direction, it is necessary to use optical instruments.

The Dichroscope. The determination of pleochroic colors is the purpose of a small instrument called a dichroscope. Early models employed transparent Iceland spar calcite to separate the two colors seen in pleochroic gems in a direction other than parallel to an optic axis. Other types utilize two pieces of Polaroid film set with their

Double Refraction, Pleochroism, and Optic Character



Figure 25 a
Dichroscope construction.

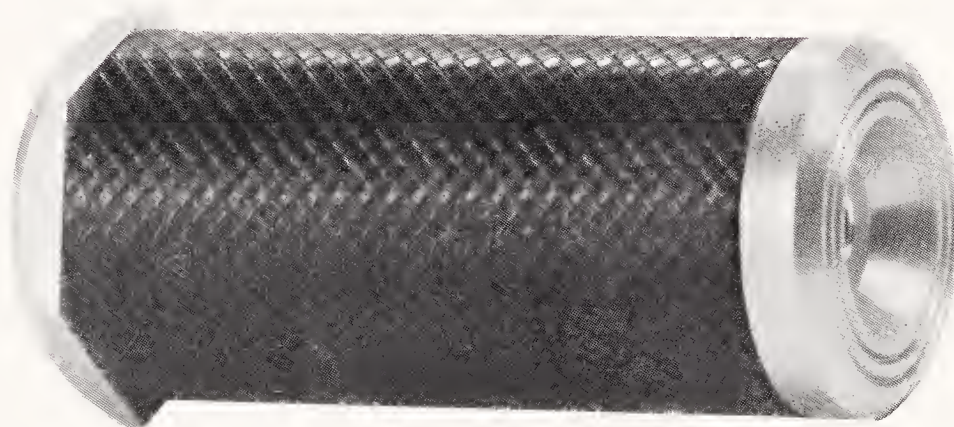

Figure 25 b
The GEM Dichroscope.

transmission directions at right angles.

Light, on entering the calcite, is broken into two polarized rays that have vibration directions at right angles to each other. These two rays are slowed unequally by the calcite so that one is bent (refracted) considerably more than the other. Two images of the square or rectangular aperture are visible through the dichroscope. The two images will have different colors when a pleochroic gem is examined through the instrument in the proper directions. In the Polaroid version, the colors seen through the Polaroid pieces set at right angles will be different.

To Test a Gemstone for Pleochroism with the Dichroscope. The advantage of the dichroscope lies in the fact that the two pleochroic colors that may be characteristic of a given direction in a doubly-refractive gem are seen side by side. A gem to be examined

is held in stone tweezers or in the fingers about one-fourth to one-half inch from the rectangular opening. The lens at the eyepiece end of most dichroscopes focuses at about that distance from the square or rectangular window at the opposite end. As a light source, a microscope substage lamp is excellent. Any reasonably white incandescent light is satisfactory. Fluorescent lamps show a certain amount of polarization at the edges, so weak dichroism may be seen in a stone where none exists. Because of partially polarized reflection from facets and some polarization in light sources (even in the sky near the horizon), very, very weak dichroism should be regarded with suspicion.

If no dichroism is detected in the first direction examined, turn the stone and examine it in other directions. The two optic-axis directions in a biaxial pleochroic gemstone would show no difference in color in the two windows.

A gem that shows trichroism would display, for example, red and green in one direction, green and yellow in a second and red and yellow in a third direction. Only two of the three trichroic colors could be seen in any one direction. Since pleochroic colors of a gem are often distinctive, the determination of pleochroism is valuable in gem identification. Although many gems are doubly refractive, the number that show strong dichroism is small. Unless the dichroism exhibited is unlike that for any but a single gemstone, it is best to consider it proof of double refraction only, and not of the stone's identity.

The direction in which dichroism can be seen is also important because it gives an indication of the synthetic or genuine origin of corundum. Almost all genuine corundum is cut so that the table is at right angles to the optic axis, whereas most synthetic gems are cut so that the table of the cut stone is usually more or less parallel to the optic axis. As a result, natural ruby and sapphire seldom show dichroism when viewed through the table, whereas their synthetic counterparts usually show strong dichroism through the table.

Use of the Polariscope in Detecting Pleochroism. The polariscope detects pleochroism effectively when the analyzer is turned to the parallel position, allowing maximum transmission of light.

Double Refraction, Pleochroism, and Optic Character



Figure 26
Correct Use of the Dichroscope.

When held between the polarizer and analyzer, a pleochroic stone will show different colors in positions 90 degrees apart, as it is rotated. The polariscope is a less satisfactory instrument for the determination of pleochroism than is the dichroscope, because the two colors are not seen simultaneously as they are in the latter. Nevertheless, there are gemologists who feel that the polariscope offers a more effective means for detecting pleochroism in very light-colored stones in which no color difference can be detected with a dichroscope.

Optic Character. The determination of the uniaxial or biaxial character of a doubly refractive gemstone often provides an important clue to its identity.

Uniaxial gems have two refractive indices, one of which is constant for any direction. The other index varies from the constant index to a point above or below it. If the constant index is the

lower numerically, the material is said to be *positive*. If the upper index is constant and the lower is variable, the stone is said to be *negative*.

Optically *biaxial* gemstones are also either positive or negative, but since they have three refractive indices (only the highest and lowest are given in most refractive-index tables), the signs are determined in a different manner. The highest and lowest indices vary from their maximum and minimum positions to the intermediate (beta) index. If the numerically highest index (gamma) is closer to the intermediate one than is the lowest index (alpha), the gem is said to be negative. If the lowest is closer to the intermediate (beta) index, the gem is said to be positive. A test of this kind might seem to be out of place in a text of this nature, but the determination is not difficult with the refractometer.

Determination of Optic Character on the Refractometer. If a gemstone has a large birefringence (.015 or more), or if a monochromatic light source is used, it is often possible to determine the optic character. If, as the gemstone is rotated, one refractive-index reading remains the same while the other varies, the gemstone is probably uniaxial, since the chance of encountering such a direction in a biaxial gem is small. If the lower index is the one that does not vary, the gem is uniaxial with a positive optic sign. If the higher index is constant but the lower index varies, the optical sign is negative. For example, corundum has indices of 1.762 and 1.770, of which the higher reading, 1.770, is constant, while the former varies from 1.762 to 1.770. Since the higher is constant, corundum is negative in sign. The birefringence of the gem is represented by the maximum difference between the two indices.

A Polaroid plate rotated over the eyepiece of the refractometer enables the tester to isolate, in turn, each of the two readings of a doubly refractive gemstone, thus facilitating the determination of birefringence and optic character.

Biaxial gems are distinguished on the refractometer by a variation of both the upper and lower indices as the hemisphere is ro-

Double Refraction, Pleochroism, and Optic Character

tated. The same effect is noted on a refractometer with a fixed dense-glass hemisphere or prism by rotating the gem instead of the hemisphere. As the biaxial gem is rotated, both the high and low indices vary; the high from an intermediate point up to a maximum reading, and the low from a minimum reading up to the same intermediate position. The optical sign of the biaxial gem may be determined by noting whether the minimum or maximum reading is farthest from the intermediate position from which both vary. If the numerically higher reading is closer to the intermediate index than is the lower, the gem is said to be optically negative. If the lower index is closer to the intermediate index, the gem is said to be optically positive. For example, if readings were taken on topaz and the low reading varied from 1.629 to 1.631 and the high reading from 1.637 down to 1.631, 1.631 would be the intermediate index and the optic sign positive because 1.629, the lowest reading, is closer to the intermediate reading. In some cases, minimum position of the high reading and the maximum position of the low will either overlap or fail to reach a reading common to both. In this event, approximate the position of the intermediate index by taking a figure midway between the two. It should be noted that there are two possible orientations in biaxial stones in which one index remains constant during rotation on a facet and the other index does not reach it. A reading on a second facet should disclose the gem's biaxial nature.

There is a third direction in biaxial stones within the range of the refractometer in which one index remains constant and the other varies from the maximum position to the minimum. Thus, the tester may not realize that one index is remaining constant, but rather assume that the minimum varies from the intermediate to the minimum position and the maximum reading from the maximum position to the intermediate position, whereas, in truth, the intermediate position remains constant throughout a 360-degree rotation. This occurs when the facet is cut perpendicular to the intermediate index direction (beta).

Analyzing Refractometer. In 1949, Robert Shipley, Jr., and

HANDBOOK OF GEM IDENTIFICATION

Noel Alton introduced two refractometers employing polarizing systems to analyze the nature of the birefringence of gemstones. One utilizes white light and filters and the other monochromatic (sodium) light. One Polaroid film with its vibration direction at 45° or 90° to the contact surface of the hemisphere is placed between the light source and the refractometer light portal, and a second over the eyepiece at 90° to the first. With this arrangement of Polaroid, the portion of the scale between the high and low readings for a doubly refractive gemstone appears light and the remainder of the scale dark. As the stone is rotated on the hemisphere, the changes in width and position of the birefringent bar of light are analyzed in the manner outlined in the preceding paragraphs.



Figure 27

A 10X loupe held under the top piece of the polariscope resolves the interference figure

Double Refraction, Pleochroism, and Optic Character

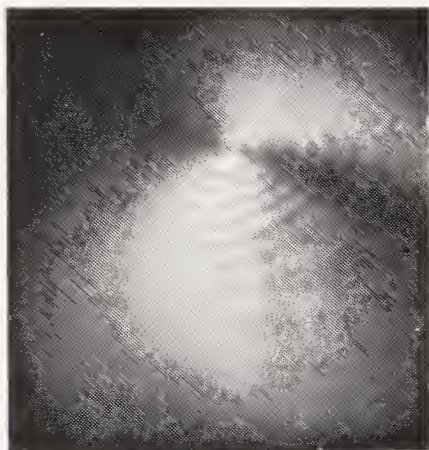

Figure 28
A biaxial interference
figure parallel
to an optic axis.

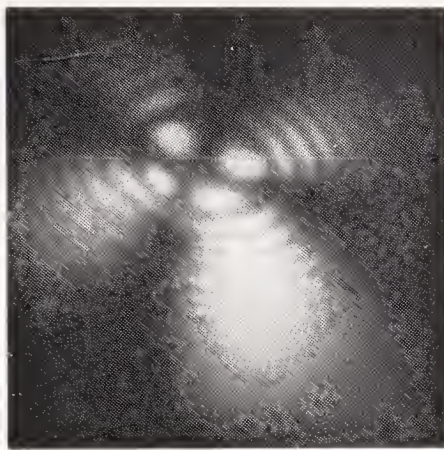

Figure 29(a)
A uniaxial
interference figure.

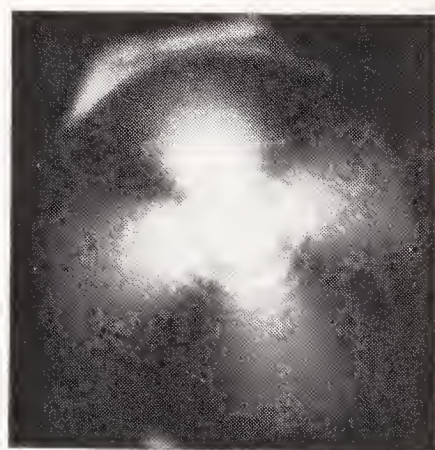

Figure 29(b)
The bull's eye uniaxial
interference figure that
is characteristic of
most quartz.

Singly refractive materials without strain double refraction show no light bar when the Polaroids are in crossed position. Strained singly refractive materials display a light line without measurable width. These instruments are useful particularly for unusual gemstones, rarely encountered by the jeweler.

The Use of the Polariscope in the Determination of Optic Character. There are several tests that may be performed with instruments used primarily for other purposes that will materially assist in an occasional difficult identification. One of the most valuable is the determination of optic character with the polariscope.

If a doubly refractive gem is examined through the polariscope in a direction parallel to an optic axis, an interference figure will be seen under certain conditions. Figures 28 and 29 illustrate uniaxial and biaxial figures observed in this way. Three conditions must be observed to obtain an interference figure in the polariscope: (1) the gem must be mounted so that an optic axis is perpendicular to the Polaroid plate; (2) the analyzer (upper Polaroid plate) must be turned to the extinction (dark) position; (3) a condensing lens effect must be obtained.

The second condition is easily met, but the first and third are more difficult. Since the majority of uniaxial gems are cut with the table more or less perpendicular to the optic axis, mount or hold the stone so that the table is parallel to the analyzer. The observer is able to recognize the correct orientation by the appear-

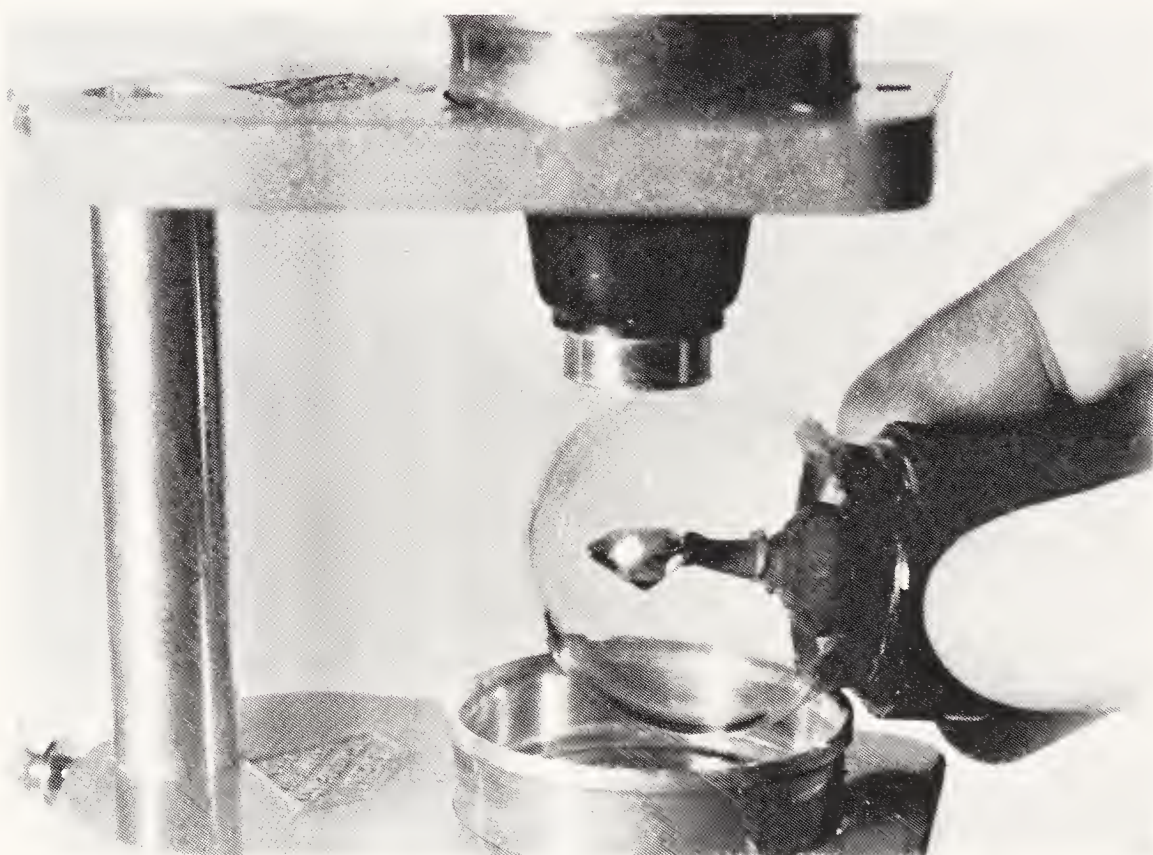

Figure 30

*The Moore Sphere held between the Polaroid plates of a Gem Polariscope.
A low powered loupe rests under the analyzer.*

ance of bright colors within the gem. If the optic axis is perpendicular to the Polaroid plates, there should be a minimum light-intensity change as the stone is rotated. If the first position in which the gem is held does not seem to be parallel to the optic axis, turn the gem while observing it. As the stone is rotated, a dark line may be observed. Turn the stone in the direction that causes the dark line to become more sharply defined. As the line appears sharper and narrower, interference colors should appear.

The third condition may be difficult to meet in a faceted gem, but gems cut *en cabochon* act as condensing lenses. Therefore, interference figures are usually resolved in such gems in determining the singly or doubly refractive character. Two principal methods of producing the condensing-lens effect are available with faceted gems. A simple method involves the placing of a drop of viscous liquid on the gem after it has been oriented properly. If a strain-free glass or plastic sphere is touched against the stone, it also serves effectively.

Double Refraction, Pleochroism, and Optic Character

A 10x loupe held under the top piece of the polariscope resolves the interference figure when viewed from a distance of eighteen inches or more. Immersion of the gemstone in a small beaker or the bottom section cut from a test tube filled with water or bromoform often permits resolution of an interference figure difficult to obtain otherwise.

The distinction between uniaxial and biaxial gems has many uses. It is the easiest way to distinguish between precious moonstone (orthoclase) and the chalcedonic quartz variety, since both are normally cut *en cabochon* and no condensing lens is necessary to resolve the interference figure in precious moonstone. Since chalcedony is composed of a multitude of tiny crystals, no figure can be obtained. Similar determinations also serve to distinguish between topaz and tourmaline, and between corundum and chrysoberyl. The addition of a quartz wedge to the tester's equipment materially increases the value of interference figures, since the optic sign (positive or negative) can be determined with the wedge.

The beginner will find difficulty in obtaining interference figures with the polariscope, except when gems are cut *en cabochon*. However, the test becomes so valuable in difficult identifications that it is wise to develop the necessary technique.

The Moore Sphere. A more effective means of condensing light to produce interference figures is provided by a liquid-filled glass sphere at the center of which a gemstone is mounted. Such an immersion vessel is the Moore Sphere. By placing this small instrument between crossed Polaroid plates, it is possible usually to resolve an interference figure in a matter of a few seconds by rotating the sphere in a direction in which the dark line or brush becomes sharper and narrower. When interference colors appear, a 10x loupe placed above the sphere and observed from a distance of 18 inches or more should resolve the interference figure. This instrument is no longer being manufactured. The Moore Sphere has not been available for many years. The reference is given because such an instrument could be made by anyone interested in doing so for personal use.

Chapter VII

Magnification

Importance to Gem Identification. A vitally important factor in the correct identification of gems is the proper use of magnification, since clear resolution of inclusions is essential to distinguish manmade substitutes from natural gemstones. Effective magnification techniques, good equipment, and a knowledge of gem characteristics makes it possible to extend the usefulness of magnification. It may assist in the detection of efforts to improve appearance by fraudulent means, to distinguish between different natural gemstones, and to judge quality.

Magnifying Instruments. Numerous types of loupes and microscopes are used for gem identification. The magnification range is from two to over six hundred diameters. Under the loupe and under the microscope, efficient lighting of the gem is essential to successful magnification. Inasmuch as a transparent gemstone is usually cut for maximum brilliancy, the reflection of light from its many facets adds materially to the examiner's difficulties. The lighting problem increases with increasing magnification; in fact, magnifications of 200 diameters or more are rarely useful in gem identification. It is apparent that the magnifier chosen by the gemtester must be one that has an efficient light source or one that may be so adapted that efficient lighting is easily obtained. Dark-field illumination, in which light is directed into the gem from the side, usually provides the most effective method of illuminating the interior of a gemstone. (See illustration.)

Magnification

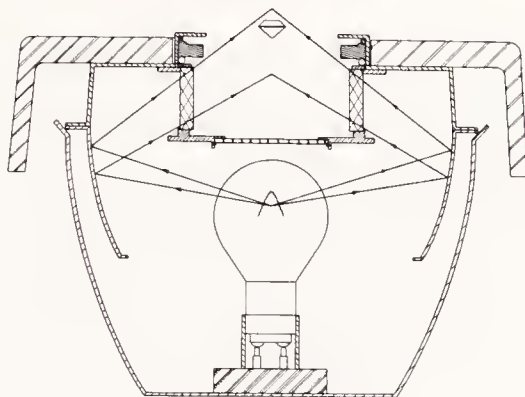

Figure 31

Diagram of a dark-field illuminator.

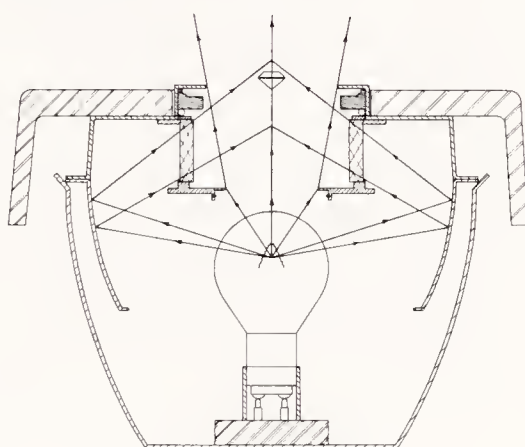

Figure 32

Diagram of a direct illuminator.

Loupes. Lenses of many diameters and various magnifications are used in jewelers' loupes. The best of these are *triplets*, corrected for chromatic and spherical aberration. The correction, both practical and necessary, places the entire field in focus at once and eliminates the confusing color fringe visible around magnified objects seen through an uncorrected loupe. (See Chapter X on distinction between synthetic and genuine gems.) The wider the field of the ten-power corrected loupe, the more light it transmits to the eye, increasing its usefulness. If a loupe of ten power or higher magnification is not corrected, the field, partially masked, is small.

A loupe of less than ten power will seldom resolve inclusions well enough for the observer to determine their nature. A loupe of greater than ten power has so short a focal distance that ade-



Figure 33
The Bausch & Lomb 10x Loupe.

quate lighting is achieved with difficulty and observation becomes more complicated.

Much of the synthetic corundum and synthetic spinel made today has inclusions too tiny to be resolved well enough by loupe to permit unquestionable classification. Very often, the higher magnification provided by a microscope is essential.

Microscopes. Almost every field of science and several different industries have highly specialized requirements for a microscope. Most of them are difficult to adapt to provide satisfactory gem microscopy. The biologist and the pathologist examine thin sections under very high powers and the metallurgist needs strong overhead illumination, and likewise uses high magnifications. High powers, with their very narrow depths of focus, and overhead lighting are almost useless for transparent gemstones. The gemologist needs lower-powered objectives, dark-field illumination and the depth perception provided by a stereoscopic binocular system. The types of binocular microscopes adapted for gem use, as described in the following paragraphs, have many advantages over the usual

Magnification

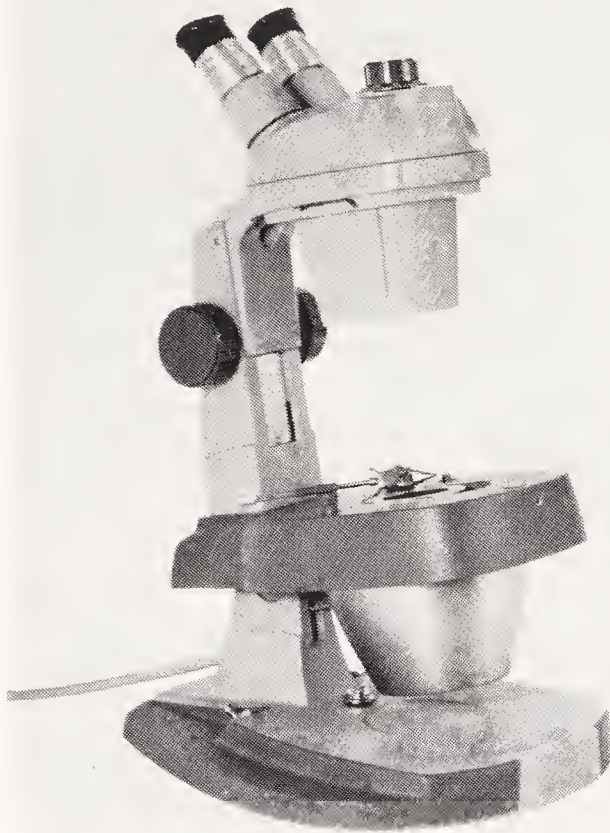

Figure 34
The Diamondscope.

monocular microscope and other types of binocular. The combination of objectives of low power with wide-field eyepieces yields an especially wide field of vision, covering a much greater-than-usual area at any given magnification. The stereoscopic vision permits objects to be located exactly and their nature to be identified. The highly effective dark-field illumination provides the needed contrast for the efficient examination of the surface and interior characteristics of gemstones. All of the instruments herein described utilize a spring-loaded stoneholder, opening to a full twenty-five millimeters to hold rings and other larger jewelry pieces, as well as loose stones.

The Diamondscope. This is the trademarked name for the original stereoscopic microscope—a dark-field-illuminator combination designed for increased efficiency in the examination of gemstones. There have been many changes over the years. The modern instrument employs a binocular equipped with the zoom feature,

HANDBOOK OF GEM IDENTIFICATION

with a standard range of 10x-45x, and a possible extension to 200x. The magnifier is designed to remain in approximate focus from one end of the magnification range to the other.

A mechanical stoneholder (see *Diamondscope* illustration), that may be mounted on either side of the illuminator base, is furnished to hold either mounted or loose gems. The illuminator base has an interchangeable background for dark-field and direct illumination of a gem.

The name *Diamondscope* is a trademark name controlled by the American Gem Society, which does not sell, but only leases the instrument subject to rulings governing its use in business.



Figure 35

Examining a gemstone on the Mark V Gemolite

The Gemolite. Since 1948, the Gemolite has been available to the jeweler and gemtester for gem identification and quality grading. This instrument employs a wide-field binocular micro-

Magnification

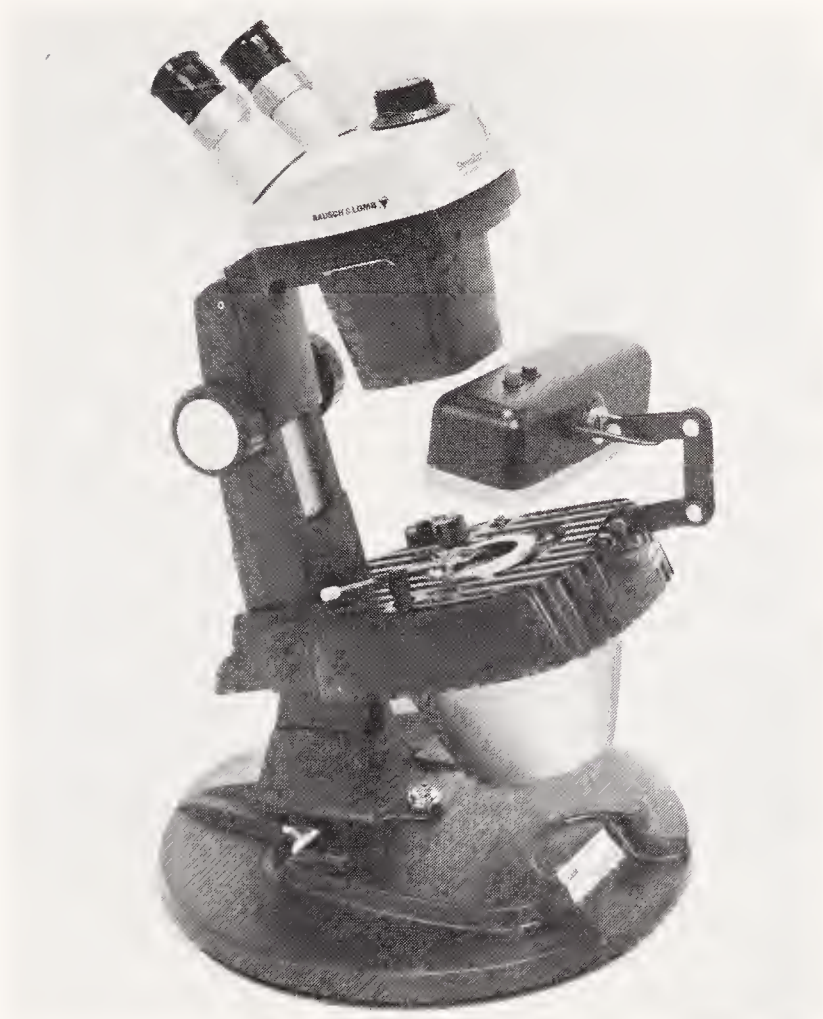

Figure 36

The Deluxe Mark V Gemolite

scope mounted on a base designed for highly efficient illumination of transparent gemstones. An overhead light source is used to illuminate opaque stones. The gem or jewelry is held in a mechanical spring-loaded stoneholder that offers easy manipulation and almost universal motion. An iris diaphragm serves a variety of purposes for controlling the light on the stone. Earlier models employed .7, 2 and 4x objectives, with 15x wide-field eyepieces, to yield magnifications of 10.5, 30 and 60x. One present model has the Stereozoom feature, offering an infinite number of magnifications between 10 and 45x with 15x eyepieces. The field at 10x is an inch, and at 45x, one-quarter inch or nearly the diameter of a one-carat round diamond brilliant. A 2x adapter doubles the magnification range to 20 to 90x. The Gemolite has a rotating base and a tilting mechanism for convenience. Higher power eyepieces increase the potential to 200x. (See illustration.)

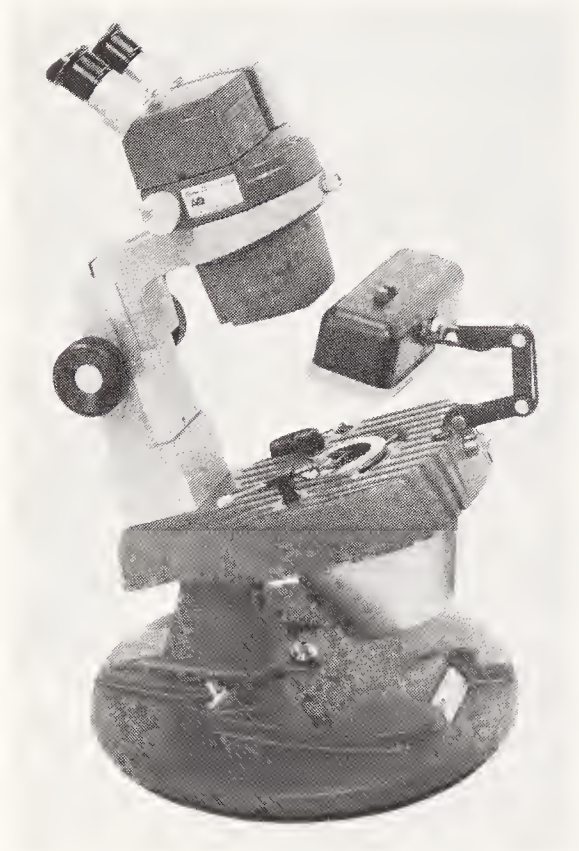

Figure A
 Custom Mark V Gemolite "A"



Figure B
 Custom Mark V Gemolite "B"

Custom Gemolites. Two Custom models of the Gemolite employ binocular stereo microscopes of exceptionally high resolution and use the Zoom feature. One made by the American Optical Company has a usual range of 10x to 63x, with a field at 10x of over $\frac{15}{16}$ of an inch and a 4-inch working distance (*Figure A*). A comparable Bausch & Lomb high-resolution binocular with Stereozoom has a normal range of 10x to 70x. The field at 10x is about $\frac{5}{8}$ of an inch, and the working distance three inches. Both instruments may be raised to much higher magnifications with 2x adaptor lenses or higher powered eyepieces, or both (*Figure B*).

The Diamond Grader. A small binocular microscope employing the same type of dark-field illuminator as the Gemolite and Diamondscope is known as the Diamond Grader. It offers 10 and 30x magnifications, plus a spring-loaded stoneholder, an iris diaphragm and light field, as well as tiltback and a turntable. Al-

Magnification

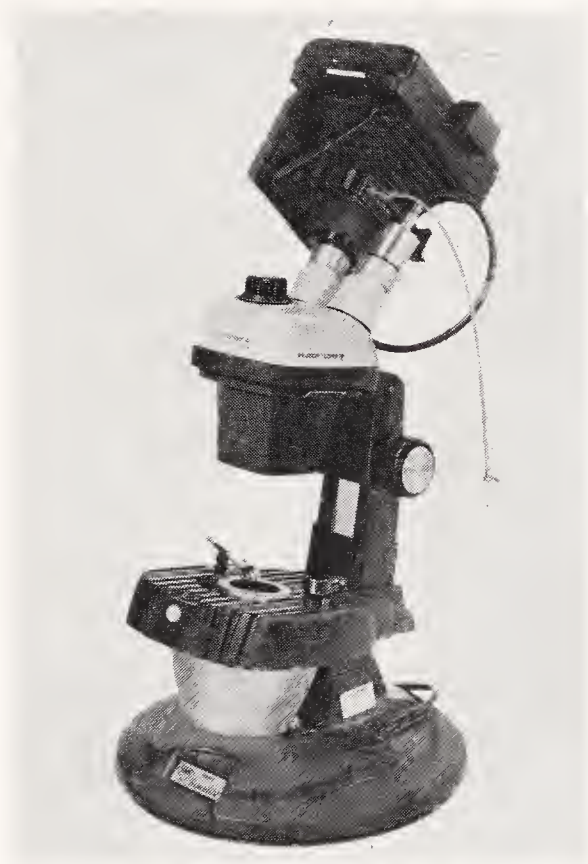

Figure 37

*Mark V Deluxe "B" Gemolite
with attached PhotoScope for
taking photomicrographs*

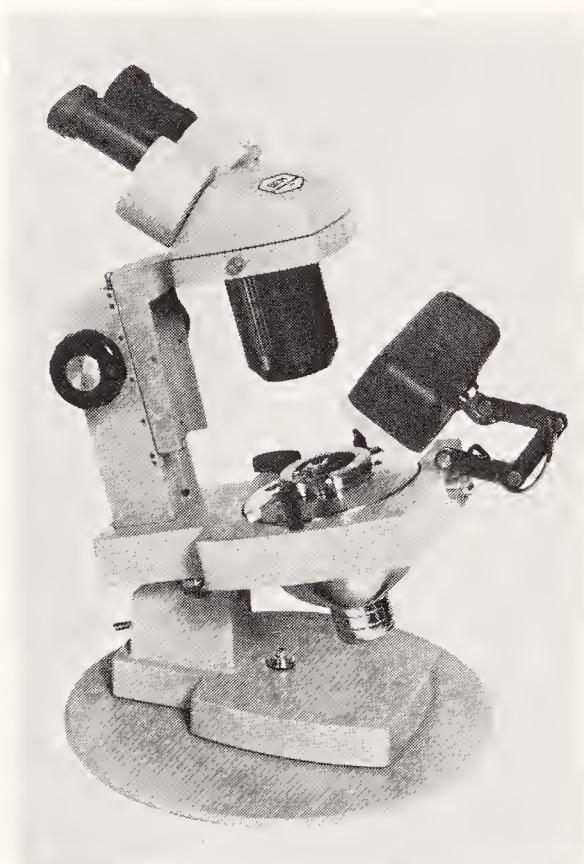

Figure 38

The Diamond Grader

though the maximum magnification is less than that of larger instruments, it is an effective gemtesting instrument. (See illustration.)

Other Microscopes. For gem identification, the loupe is often inadequate. To obtain greater magnification at a lower cost than that called for by a Gemolite or Diamondscope, the tester may then turn to a Gem Detector or to a monocular microscope. Monocular microscopes are available in a price range of about that of a good loupe up to about triple the cost of a Gemolite (for a petrographic microscope with attachments). Inexpensive student medical and biological stands usually are designed for the study of slides at high magnification and are useless for gem work. However, if student microscopes can be obtained with 10x or 15x wide-field oculars and 1x and 4x objectives, they are useful, if a satisfactory form of dark-field illumination can be improvised. Among monocular microscopes, one that gives erect images is particularly desirable.

Procedure for the Examination of Gems under Magnification.

Since examination procedures vary according to the types of magnification described in the preceding paragraphs, the use of each type will be described separately. A certain portion of the procedure for gem examination under magnification is necessary whatever the type of magnification employed.

Cleaning the Gemstone. All stones must be carefully cleaned before they are examined. The most confusing aspect of the classification of gemstone inclusions under magnification is the presence of surface dust that may easily be mistaken for internal inclusions. The possibility for costly interpretative errors emphasizes the need for exceptional care in cleaning a gem. Many cleaning methods may be used effectively, but some are more efficient than others. Probably the best cleaning method, in the absence of a good steam cleaner or an ultrasonic cleaner, is that in which the gem is dipped into carbon tetrachloride, acetone, alcohol, or some similar solvent, and then wiped carefully in a piece of red silk. Silk is preferable to cotton or other cloth, since it is less likely to leave lint on the stone. While any color would suffice, a brightly colored silk cloth is best, since its threads are not likely to be confused with internal imperfections. In the absence of solvent, careful rubbing with a silk cloth may render the gem sufficiently clean to avoid confusion. Paper facial tissues are satisfactory for cleaning loose stones. Since lint is sure to remain after tissue use, blowing on the stone is essential to remove most adhering particles. The carefully cleaned stone should be mounted without being touched by the fingers. A small camel's-hair brush is a helpful accessory to flick off any surface dust that remains after the stone has been mounted. The major difficulty encountered by the novice in microscopic examination of gemstones (the confusion of surface dust with internal imperfections) will be rendered negligible if the gem has been carefully cleaned.

The Use of the Loupe. The brilliant-cut gemstone must be as carefully lighted for loupe examination as for examination under

Magnification

Figure 39
A 10X triplet hand loupe

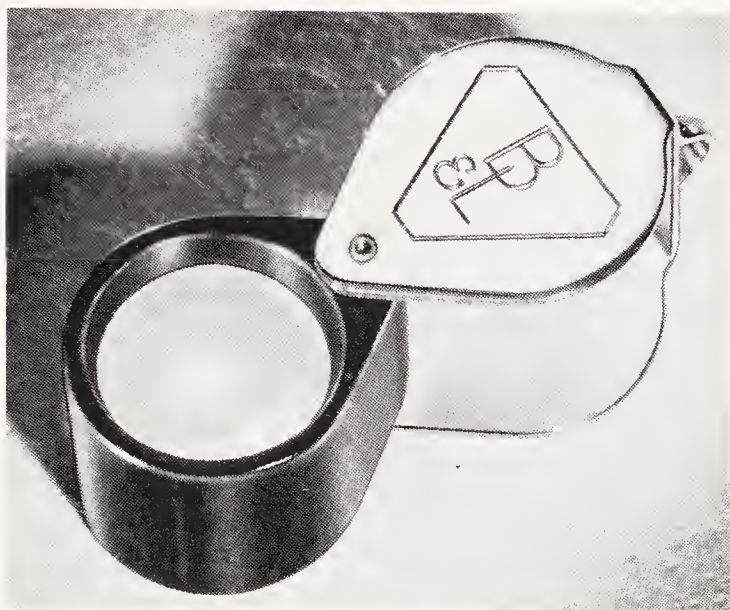

higher magnification. Carefully clean the stone to remove dust, pick it up with stone tweezers, and hold over a black background. With a small lamp, direct light into the gem from the side. Imperfections within the gem will appear as bright objects clearly visible against a black background. The dark-field illumination described improves visibility of inclusions under all the many types of jewelers' loupes.

The Use of Microscopes. Mounting the Stone in a Mechanical Holder. If the gemstone is to be examined under the Gemolite, Diamondscope, Gem Detector or the gemological microscope, remove it from the silk cloth or facial tissue with the mechanical stoneholder without touching it with the fingers. For best results, place the gem, table down, on the silk and grasp it at the girdle. Mount the stoneholder on its post on the instrument, and turn it so that the stone can be examined with the table facing the microscope objective.

Mounting the Stone on a Glass Slide. If a microscope without a mechanical stoneholder is used, the gem is usually mounted on a glass slide. A small piece of beeswax, plasticine or other material that can be shaped easily, is used to hold the stone. To mount the stone, hold it in tweezers to avoid touching it with the fingers and apply wax to the girdle. By means of the wax, transfer the

stone to a small glass microscope slide and place the slide on the stage of the microscope. For best results, mount the stone with the table parallel to the slide and with the culet resting on the slide. The gem may be placed table down on a glass slide without using wax, if the microscope is in a vertical position, but it is more difficult to see inclusions clearly from this direction, whereas mounting with wax takes little time and places the stone in a position especially advantageous for examining the interior.

Lighting. If the microscope has a built-in illuminator, close the baffle to give dark-field lighting and adjust the stone so that it is well lighted. If an ordinary microscope is used, direct the light toward the stone from the side at the level of the stage. Adjust it so the interior of the stone is well lighted, but with a minimum of bright reflections into the microscope.

Focusing. The working distance for binocular gemtesting microscopes is such that the gem is several inches from the objective. Focusing is usually accomplished first with the lowest magnification. Additional magnification is then employed as needed. With a monocular, such as the gemological microscope, the process is more exacting. First make certain that the microscope has its lowest power objective in position, then use the coarse adjustment knob to turn the body tube down so that the objective comes close to the stone.

Caution: To avoid damage to either objective or gem caused by lowering the objective until it strikes the stone, adjust the body tube downward, while observing the objective from the side of the instrument, until it nearly touches the stone.

The light used with either an ordinary or a polarizing microscope should be approximately adjusted to a position that permits a maximum illumination of the gem before a focus is attempted.

Bring the gem into focus by raising the body tube with the coarse adjustment knob while looking through the instrument. When the gem has been resolved under low power, adjust the light more

Magnification

carefully for maximum illumination of the stone's interior. If the microscope does not have an illuminator base, improve resolution of the gem's interior by holding a small substage lamp beside the stage of the instrument.

As the gem comes into focus, the culet will appear first; then as the tube is raised farther, the table will appear. If the focus is changed *very slowly* from culet to table, any inclusions within the gem will come into and out of focus as the tube is raised to a focus on the table. When this focus change is made on a polarizing microscope, use the fine-adjustment knob.

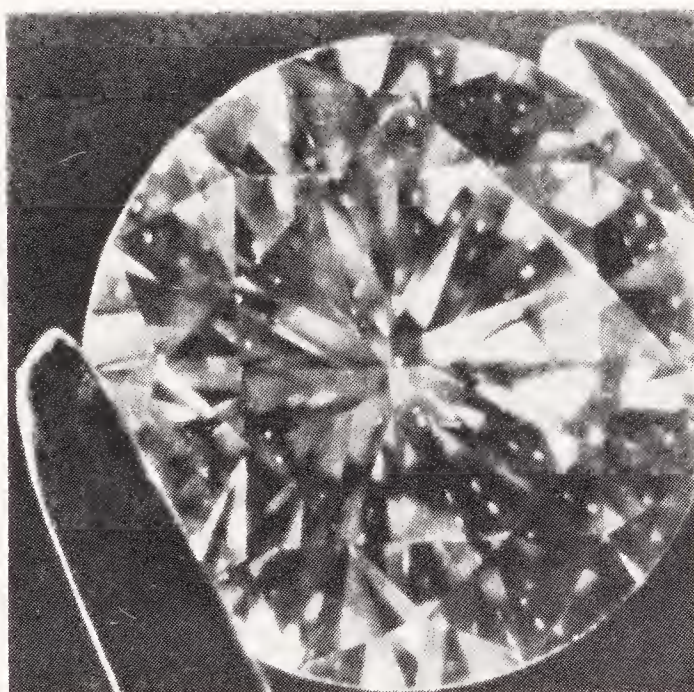

Figure 40

Table view of centrally located inclusions reflected many times.

Distinction Between Dust and Inclusions. Surface dust, easily mistaken for internal imperfections in a gem, constitutes a confusing element for the beginner in gemstone identification. Even an experienced microscopist occasionally encounters difficulty because of dust. Since the most careful cleaning will seldom remove all surface dust, the observer must become adept at distinguishing correctly between dust and inclusions.

If the objects in question are exactly in focus when the table is in focus, it will not be difficult to determine that they are on

the surface. If there is any doubt, touch the table of the gem with a camel's-hair brush to see if the supposed imperfections disappear.

Dust on pavilion facets is especially confusing. When the focus is raised from the culet to the table, pavilion facets come into focus from the bottom to the top; thus, surface dust and true inclusions come into resolution at the same time. If the stone is mounted, and therefore difficult to dust with a camel's-hair brush, it is often possible to remove dust from pavilion facets by blowing sharply against the gem.

To best determine whether an object apparently resting on a pavilion facet is surface dust or an internal imperfection, observe the facet junctions very carefully. Where the facets meet along the back of the gem, only the portions in the plane of focus will be seen clearly. If the object in question is between adjoining facet junctions, it is probably on the surface. If the object is in the center of the stone, or at some distance from any surface that is in focus when the inclusion is most clearly visible, it must be within the stone. A mechanical stoneholder is helpful in this determination, because in it the gem may be easily turned for better perspective and its pavilion facets may be more readily cleaned with the camel's-hair brush. Turning the stone while observing the questionable inclusions may also assist in determining whether they are surface or internal. The arc in which they turn is likely to be much tighter, if they are within the gem.

Higher Magnification. Examination of the gem under lowest magnification will usually disclose inclusions in most colored gems, whether synthetic or genuine. Often, however, higher magnification is necessary to catalogue them correctly. With higher magnifications it is essential to increase the light sufficiently to bring the inclusions into clear resolution. When magnification is over one hundred diameters, a very brilliant light is essential to light the interior of the stone sufficiently to see inclusions clearly. Sharpness of definition decreases with increase in magnification.

Magnification

This, together with the lack of sufficient light, places a very definite upper limit on the use of higher magnification.

Immersion. Lighting the interior of a gem for most efficient examination under higher magnification is complicated by the reflection from the polished facets. Gems are faceted to take full advantage of their ability to bend light that enters them. Since the quality of brilliance requires that the gem return to the eye as much as possible of the light that enters the top of the stone, normal lighting of the microscope stage is insufficient for an examination under high magnification. For the magnification used on the Gemolite, the dark-field illuminator provides efficient lighting. For microscopes without such an illuminator, the confusing effect due to reflections from the facets may be avoided by immersing the gem in a liquid whose refractive power is close to that of the gem. If a gem is suspended in a liquid that has a refractive index equal to its own, it becomes practically invisible; the facets are no longer a cause of distortion, and lighting becomes a much simpler problem. It is not necessary for the liquid to be close in index to the gem under examination. Any liquid, such as water or mineral oil, is helpful, but with gems of high refractive index a liquid with an index higher than that of water will give better results. The following are suggested as suitable immersion liquids:

<i>Liquid</i>	<i>Refractive Index</i>
Water	1.34
Olive Oil	1.47
Benzol	1.50
Clove Oil	1.53
Monobromobenzene	1.56
Bromoform	1.59
Monoiodobenzene	1.62
Monobromonaphthalene	1.66
Methylene Iodide	1.74



Figure 41
A Gemolite immersion cell.

The Immersion Cell. The method of using an immersion liquid will vary depending upon the equipment. Immersion cells, valuable accessory equipment for the microscope or loupe, increase the value of these instruments, since they become more efficient magnifiers when the gemstone is immersed.

The use of an immersion cell has many advantages: (1) the observer experiences much less difficulty in seeing into a highly reflective gem; (2) light penetrates the gem, thoroughly illuminating inclusions; (3) the distinction between surface and internal imperfections is facilitated; and (4) growth lines become much more evident.

If the jeweler has no manufactured immersion cell, an excellent one may be improvised by using a small glass beaker, or even a very small drinking glass, with a fairly clear bottom and sides that allow light to enter the liquid. The gem to be examined may be placed in the bottom of the immersion cell, held in the liquid by means of tweezers, or held in wax attached to a rod of any type. For convenient manipulation of the stone, if held in tweezers or on the end of a rod, the sides of the immersion cell must be low; preferably about an inch high.

Magnification

Another type of immersion cell is easily made by cutting off the bottom of a glass test tube of fairly small diameter. Little liquid is required to fill the small hemisphere that remains, and the gem can be supported on the bottom of the curve without the aid of a stoneholder. A cylindrical section of a test tube cemented to a glass slide also makes an effective immersion cell. To resolve curved striae or angular growth lines, an opal-glass container, such as a cold-cream jar, is excellent.



Figure 42
Cement layer on a triplet immersed
in water

Determinations facilitated by Immersion. Immersion is an excellent means for quick and positive identification of assembled stones. In *doublets* or *triplets* the separation planes are easily seen either as planes of bubbles or as divisions between two distinct colors. In *garnet-and-glass doublets* the genuine inclusions in the garnet cap are seen, as well as the bubbles that appear where the glass back has been fused to the garnet. In addition, the difference in luster and transparency of the garnet and the glass are readily seen.

Natural or Synthetic Origin. To find corundum and synthetic corundum to be almost entirely without visible flaw is not uncommon. If it is not possible to determine the natural or manmade origin of a ruby or sapphire by observation in air, immersion is the only alternative, unless the spectroscope will serve to distinguish or the Plato method* is used (immersion is usually essential in this test too). Since it is possible to examine the interior of an immersed stone with increased efficiency, the examiner often finds hitherto unseen imperfections that provide the necessary evidence for a decision as to the synthetic or natural character of spinel or corundum. If, however, no inclusions are resolved, he must seek out growth lines.

Immersion in a liquid such as bromoform and a careful control of the light source provide effective conditions for growth-line resolution. Light must be reduced to a pin-point source either by an iris diaphragm below the immersion cell, or by an opaque cover with a small opening over the light source. The light source should be directly below the stone in line with the microscope. With practice, curved striae in synthetic corundum and the straight zoning of natural ruby and sapphire can be resolved almost without exception.

*See the Plato Method, Chapter X.

Chapter VIII

The Use of Characteristic Imperfections as a Means of Gem Identification

The tests commonly used in gemstone identification are based upon definite, tangible instrument determinations; the refractometer and specific-gravity tests give definite numerical results, the dichroscope may show distinct colors, and polariscope determinations may be clear cut. Employing prescribed instruments and established methods, a jeweler, after sufficient practice, can become skillful in securing satisfactory results with these instruments and methods.

By comparison, proficiency in identification of gemstones by means of their characteristic inclusions or imperfections involves a knowledge not quickly obtained by reading the printed page. To acquire skill in this method of identification, the jeweler must be thoroughly familiar with the subject of magnification; he must have a keen eye for accurate classification of inclusions or imperfections that involve, at times, the most fanciful shapes. Much more experience in the observation of gemstones will be required to achieve skill in this method.

Each time a jeweler makes a positive identification by the standard methods, he should examine the gem under high magnification in order to build up a working knowledge of the internal characteristics of gemstones.

Lighting. Ordinarily, a jeweler examines a gemstone with the light directed from behind the stone, with the result that inclusions appear as dark objects against a light background.

Dark-field illumination, in which the light is directed upon the stone from the side, is by far the best method of lighting for an examination of inclusions, since it not only enables the observer to locate imperfections more readily, but also aids identification of included crystals by revealing them as light objects against a dark background.

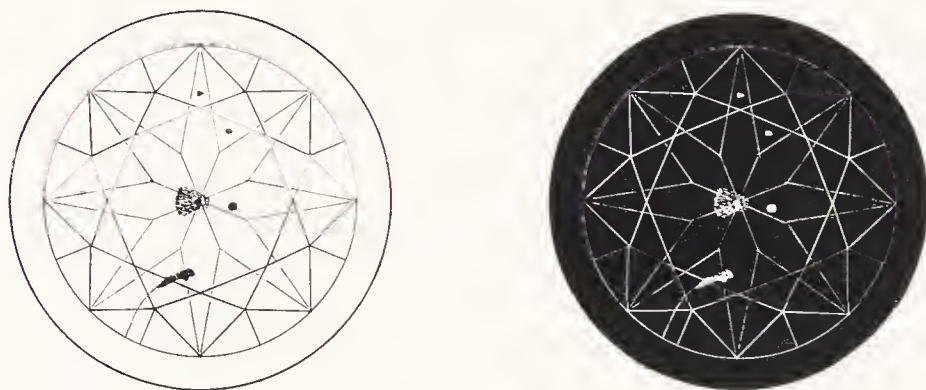

Figure 43

The appearance of a gem under magnification in ordinary illumination (left) and by dark-field illumination such as that of the Gemolite (right)

Inclusions. This term is used in its broadest sense to include surface and internal fractures and cleavages, gas and liquid inclusions and crystal and other solid materials enclosed within the gem. In some gemstones the inclusions are sufficiently characteristic to permit an immediate identification of the stone.

Gemstones without internal flaw are not uncommon, especially in such gem species as diamond, beryl, topaz and quartz.

Fracture. Four gems may be identified with some degree of certainty on a basis of their fractures.

Chalcedony has the conchoidal fracture common to most gems, but the luster on the fractured surfaces is dull or waxy, not glasslike as in other gems.

Hematite fractures are characteristically splintery, resembling a break in wood.

Turquoise is often identified by its dull to waxy luster on small fracture surfaces, in contrast to the vitreous luster of its glass imitation.

Gem Identification by Characteristic Imperfections

Zircon derives a characteristic appearance from its strong tendency to “pit” or crumble at facet edges. Heat-treated zircons are especially subject to such pitting.

Most other gems display a conchoidal, or shell-like, fracture, with a vitreous luster on the fracture surface.

Cleavage. Since few gems of importance are likely to show cleavage, straight cracks in a gem are important as clues to its identity; the angles between cleavage cracks may assist the jeweler to determine the system in which the gem crystallizes.

Diamond, the *feldspar* gems, *spodumene* and *topaz* are the important gemstones in which cleavage is likely to be observed. (See cleavage table, Appendix.)

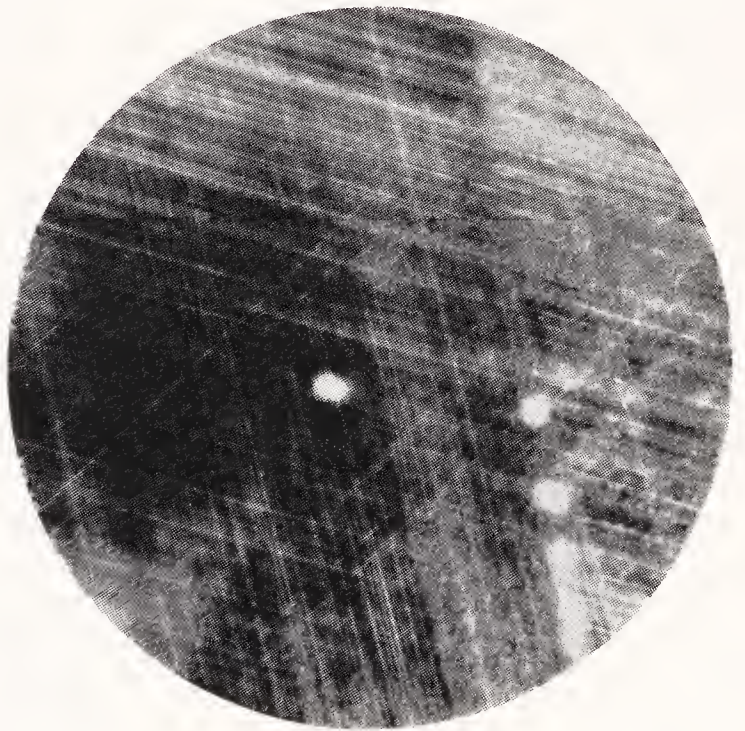

Figure 44

“Silk” consisting of three sets of rutile needles arranged at 60 degrees to each other in natural corundum

Photo by E. Gubelin

Important Genuine Gemstones and their Characteristic Inclusions

Corundum. Study the photomicrographs of corundum carefully. Usually, the experienced gemologist can identify the corundum family under the microscope immediately by means of several types of characteristic inclusions.



Figure 45
*"Silk" formed by negative
crystals in natural corundum*

Photo by E. Gubelin



Figure 46
*Included zircon crystals sur-
rounded by a "halo" of black
fractures in natural corundum*

Photo by E. Gubelin

The crystal inclusions encountered in ruby and sapphire have the following characteristic appearances:

Needlelike inclusions, known as *silk*, consist of long crystals of rutile, straight and needlelike in appearance, and arranged in

Gem Identification by Characteristic Imperfections

Figure 47
Spinel octahedra as inclusions
in natural sapphire with
strong color zoning

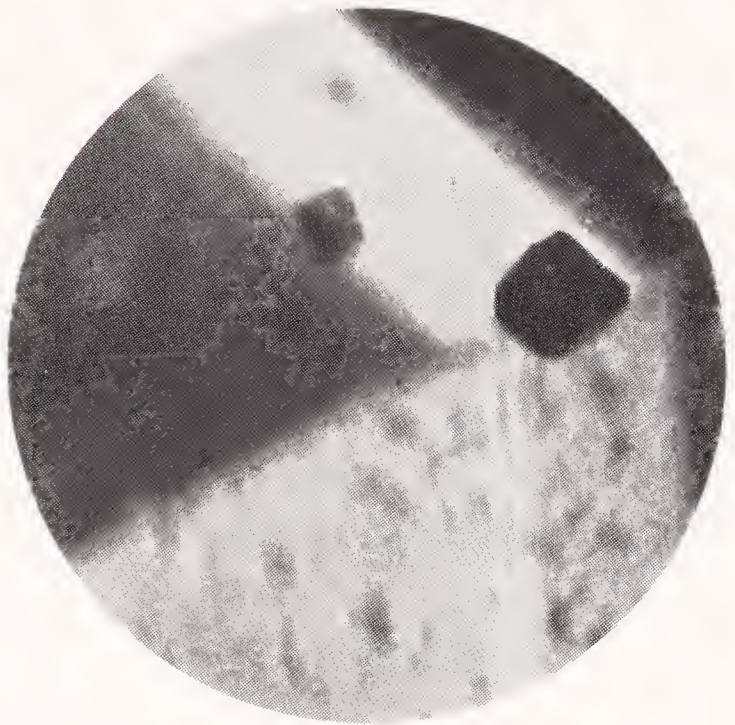

Photo by E. Gubelin

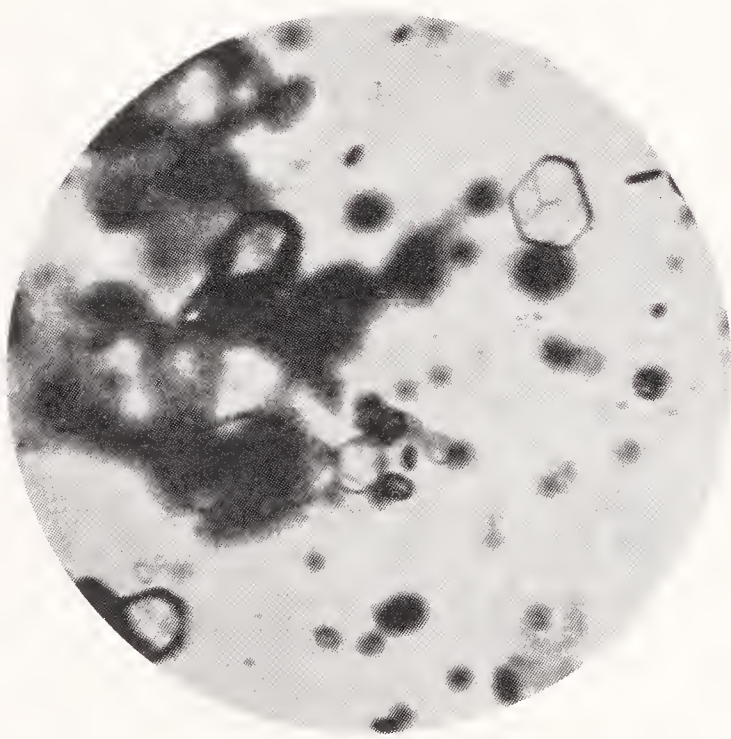

Figure 48
Six-sided mica and other an-
gular inclusions in sapphire

Photo by E. Gubelin

three sets of parallel threads that intersect each other at sixty-degree angles. The three sets are all in planes at right angles to the c-axis (in this case also the optic axis). Rutile or hornblende needles in almandite are usually, but not always, coarser than

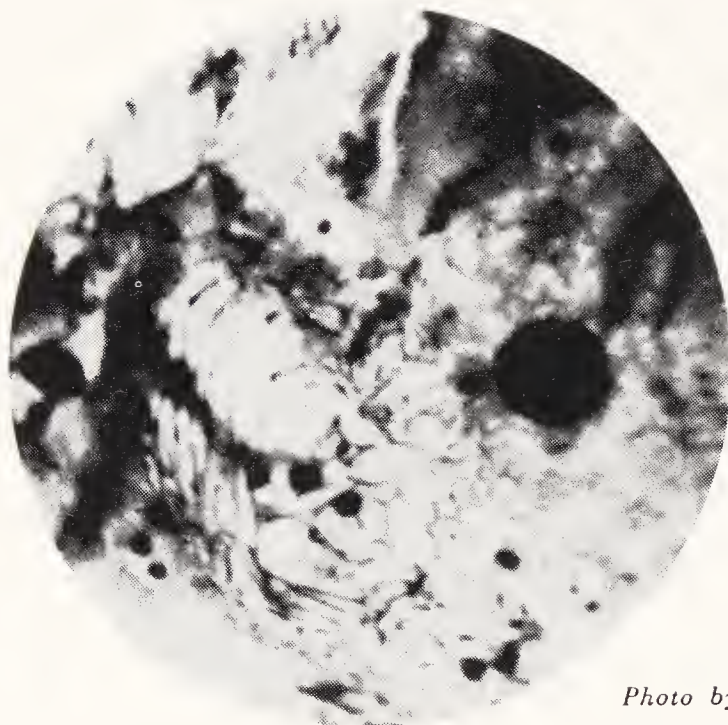

Figure 49
Solid six-sided opaque inclu-
sions and liquid inclusions in
Siam ruby

Photo by E. Gubelin

those in corundum. They differ distinctly, in that only two sets (at 70° to one another) occur in the same plane. Needlelike inclusions in quartz are very short, usually occurring in small bundles with three directions at 60 and 120° to another in each grouping.

Included *zircon crystals* are characteristically surrounded by a halo of black fractures. Zircon, with its higher refractive index, stands out against the surrounding corundum as a bright point of light. The black halo of fractures around zircon crystals is thought to be caused by radioactive disintegration in the zircon.

Tiny *spinel octahedra* (eight-sided crystals that resemble two pyramids base to base) are found in corundum, especially in rubies from Burma and sapphires from Ceylon.

Other solid crystal inclusions that may be encountered in ruby and sapphire are:

Mica inclusions, six sided, colorless or brown.

Hematite slabs, brown or black, (often with a hexagonal outline).

Garnet in rounded grains.

Rutile in coarse crystals.

Corundum crystals and grains with low relief.

Gem Identification by Characteristic Imperfections

Figure 50

“Fingerprint” patterns of liquid inclusions in natural sapphire.

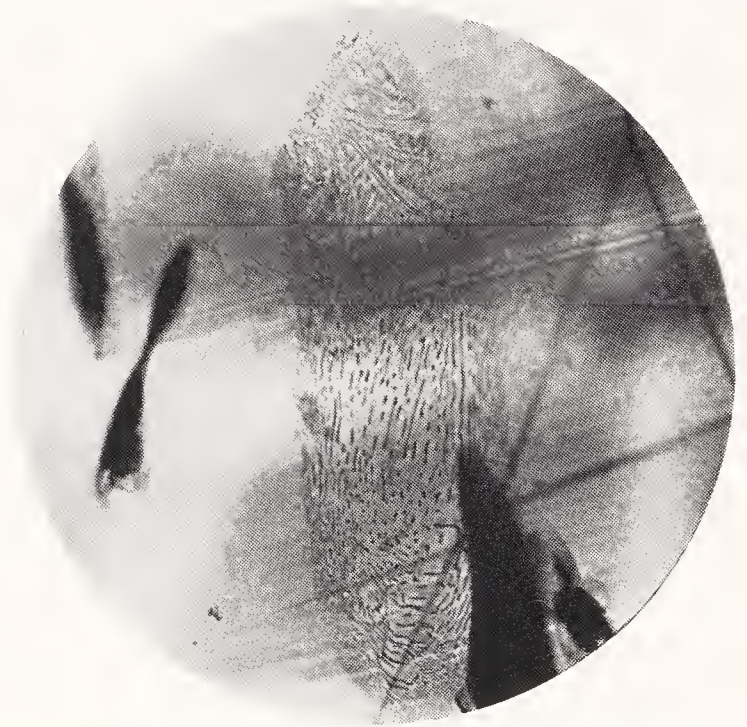

Photo by E. Gubelin

Many of these inclusions may be seen in red garnets, especially the zircon crystals with halos, coarse rutile, hematite slabs and rounded grains.

The fingerprint inclusions (see illustration) take their name from interesting clouds of hollow inclusions filled with liquid and gas that form patterns resembling fingerprints around crystal inclusions. Though similar inclusion-filled planes occur in other gems, the liquid inclusions rarely have the regular pattern common in ruby and sapphire. Fingerprints are rarely seen in garnet.

Siam rubies are characterized by fingerprint inclusions, black solid inclusions and a lack of silk common to corundum from other localities.

Very prominent hexagonal growth and color zones are common in both ruby and sapphire. (See illustration.) In Burma rubies, however, a streaked and wavy color distribution is characteristic.

An effect created by repeated twinning constitutes an interesting phenomenon occasionally seen in corundum — the only colored gem other than feldspar likely to show it. Straight parallel lines, more widely spaced than silk or color-zoning striae, extend all the way across the gem. When the twinned stone is placed in the

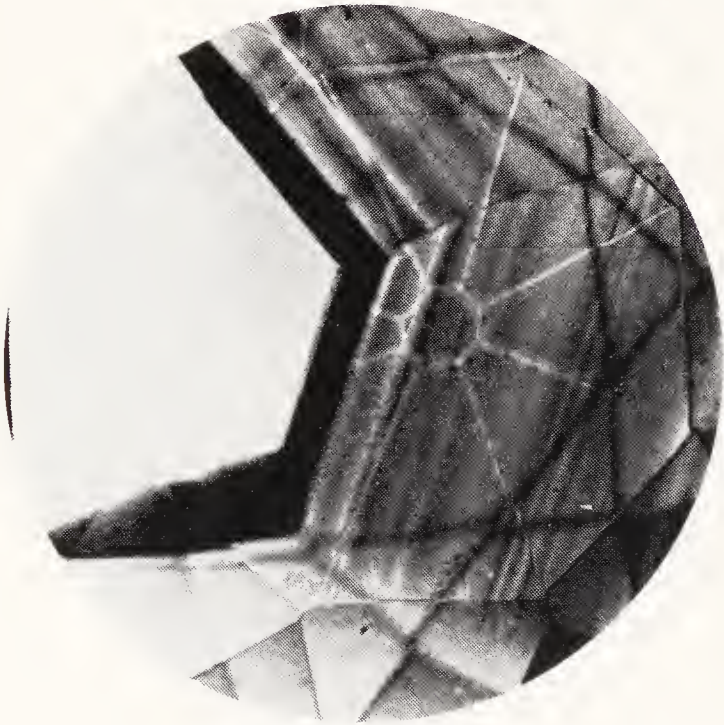

*Figure 51
Strong hexagonal color
zoning in natural
corundum.*

Photo by E. Gubelin

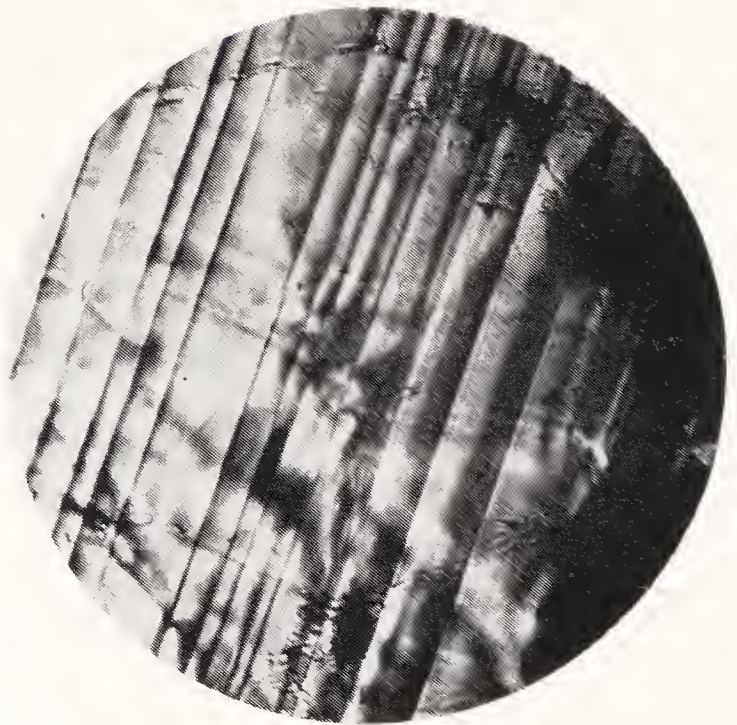

*Figure 52
Straight parallel zoning
caused by repeated
twinning in corundum.*

Photo by E. Gubelin

dark (crossed Polaroid) position in the polariscope or under the polarizing microscope, the gem remains light in all positions and does not exhibit the usual four light and four dark positions of a doubly refractive gem during a three hundred and sixty-degree rotation. A second set of such lines may be present at right angles to the first.

Gem Identification by Characteristic Imperfections

Tourmaline. Red tourmaline (rubellite) is typified by many internal fractures that are roughly parallel to the long axis of the crystals. The fractures are usually gas filled and give mirror-like reflections.

Green tourmaline seldom contains fractures parallel to the long axis of the crystal. It is characterized by long, irregular, threadlike liquid and gas inclusions, evenly distributed in abundance throughout the gem. Rubellite has these same capillary-size liquid inclusions, but seldom in the abundance common in green tourmaline. The numerous tiny liquid inclusions of green tourmaline have an appearance unlike other gems.

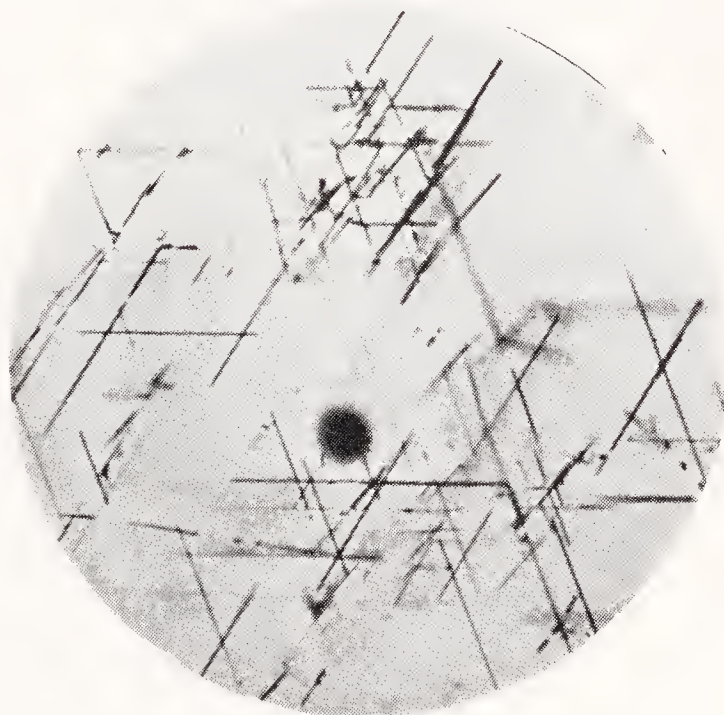

Figure 53
"Silk" in almandite garnet.

Photo by E. Gubelin

Garnet Group

Almandite. Under magnification almandite garnet is likely to be confused with ruby, since it sometimes contains grains of radioactive zircon as well as silk in a pattern that may appear similar to that found in ruby. There, however, the similarity ends.

Almandite garnet is frequently observed in which one can see two sets of needlelike inclusions intersecting at angles of 70° and 110° . The angle of 70° is close to, and might be mistaken for, a 60° angle on casual inspection. Since there are three such paired

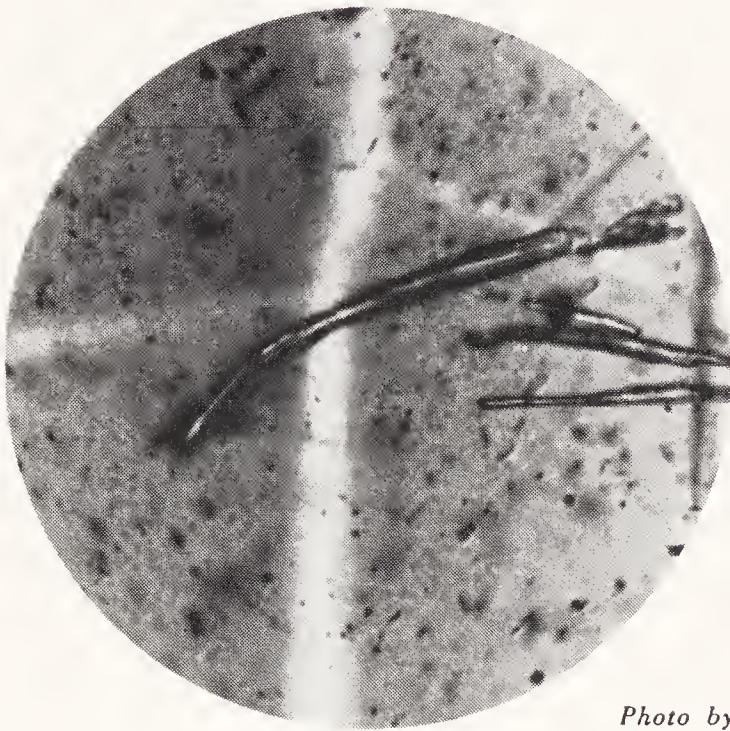

Figure 54
Typical inclusions
in almandite garnet.

Photo by E. Gubelin

sets of inclusions in some almandite, there are certain directions along which a three-fold grouping of inclusions similar to that of corundum may seem to be present; however, only two directions are ever found in the same plane in garnet.

The silk in almandite is coarser, shorter and usually less abundant than its counterpart in corundum. Evenly distributed, small, colorless grains in great abundance that are often doubly refractive in the singly refractive garnet, together with the stubby silk, suggest almandite garnet.

Grossularite. Grossularite garnet usually contains short, stubby, rounded prisms (probably of dipside) in quantity. A characteristic peculiar to the hessonite variety of grossularite is a swirled heat-wave-over-hot-pavement effect that gives the observer the impression that it is impossible to properly focus his microscope on the interior of the gem. (See illustration.)

The bright green transparent variety that has been called tsavorite shows a range of inclusions. The most commonly seen are small, thin, white crystals in healed fractures. Opaque hematite plates and elongated actinolite crystals are less common.

Gem Identification by Characteristic Imperfections

Figure 55
Stubby rounded prisms
and swirled effect typical
of hessonite.

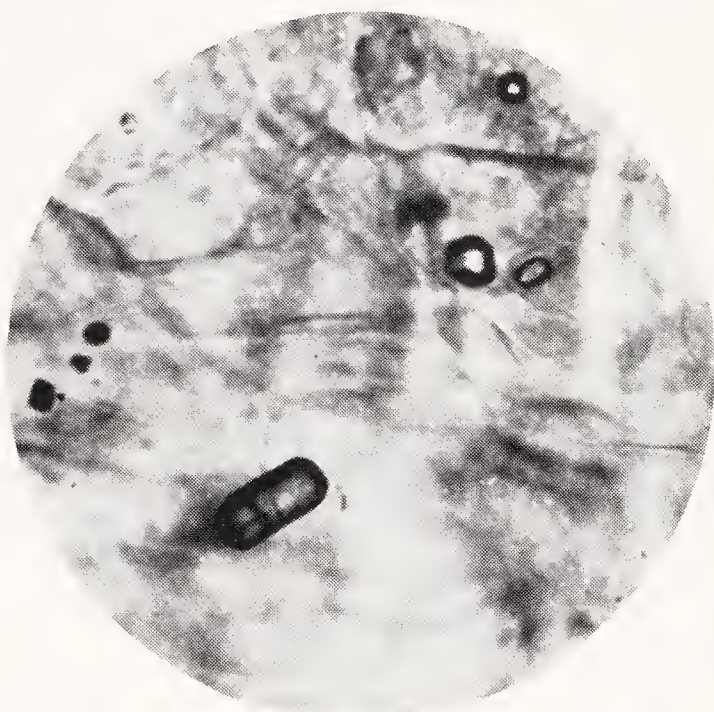

Photo by E. Gubelin



Figure 56
Characteristic "horse-tail"
inclusions that identify
demantoid.

Photo by G.I.A.

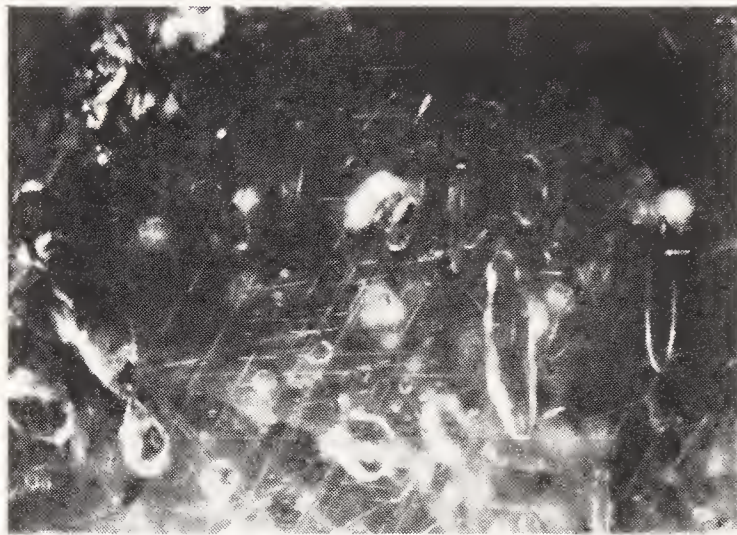

Photo by G.I.A.

Figure 57
Typical inclusions in pyrope garnet

Andradite. The demantoid variety of andradite garnet exhibits brown inclusions similar to very fine silk, but in characteristic curved and radiating arrangements, which identifies it at once. (See frontispiece and other illustrations.)

Pyrope. Pyrope garnet has an internal appearance similar to that of almandite, but often with large rounded crystal grains of very low relief. (See illustration.)

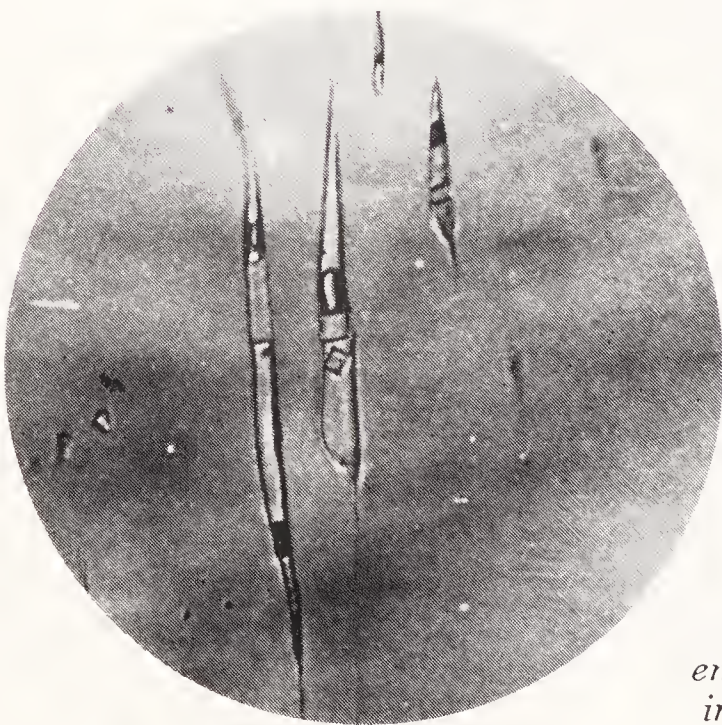

Photo by E. Gubelin

Figure 58
Three-phase inclusions in emerald with a square crystal, indicating Colombian origin.

Gem Identification by Characteristic Imperfections

Beryl

Emerald. Emerald, one of the gemstones most easily identified by its imperfections, contains not only many crystal inclusions, but also three-phase inclusions — irregular spaces filled with solid, liquid and gaseous matter.

Emeralds have such a variety of inclusions that an experienced tester may be able to gain a good idea of source by characteristic inclusions. For example: three-phase inclusions with a square or rectangular crystal phase typify Colombian emerald; tremolite needles in a rich green, small stone suggest Sandawana; and pyrite crystals suggest Colombian origin. The characteristically shaped brass-yellow cubic crystals of pyrite are often seen in emerald, and because they appear black in transmitted light, are usually referred to as “carbon.” (*See illustrations.*)

Figure 59
Pyrite inclusions in a
Colombian emerald.

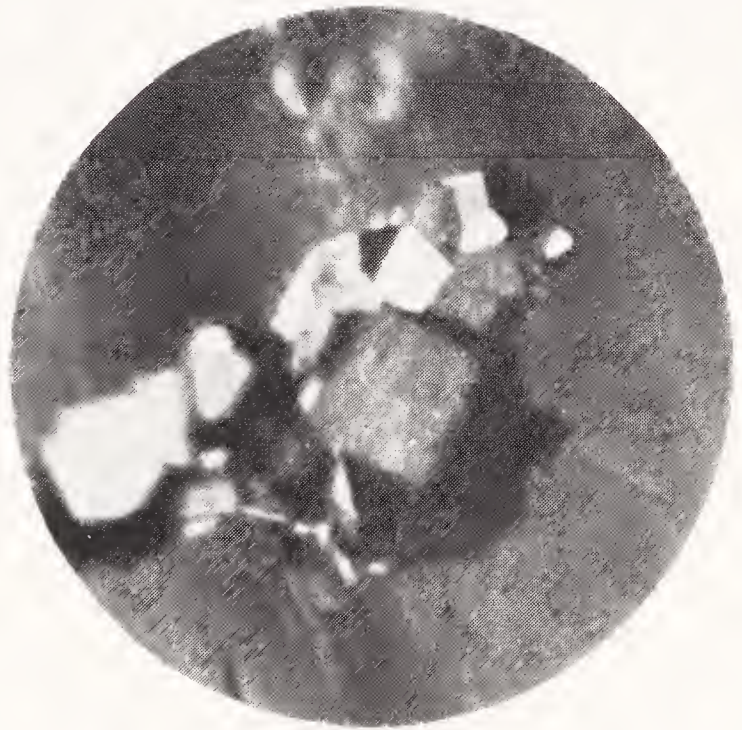

Photo by E. Gubelin

A badly fractured appearance is very common in emerald under magnification. Calcite inclusions along fractures are common in emeralds from Colombia, often imparting a roiled appearance.

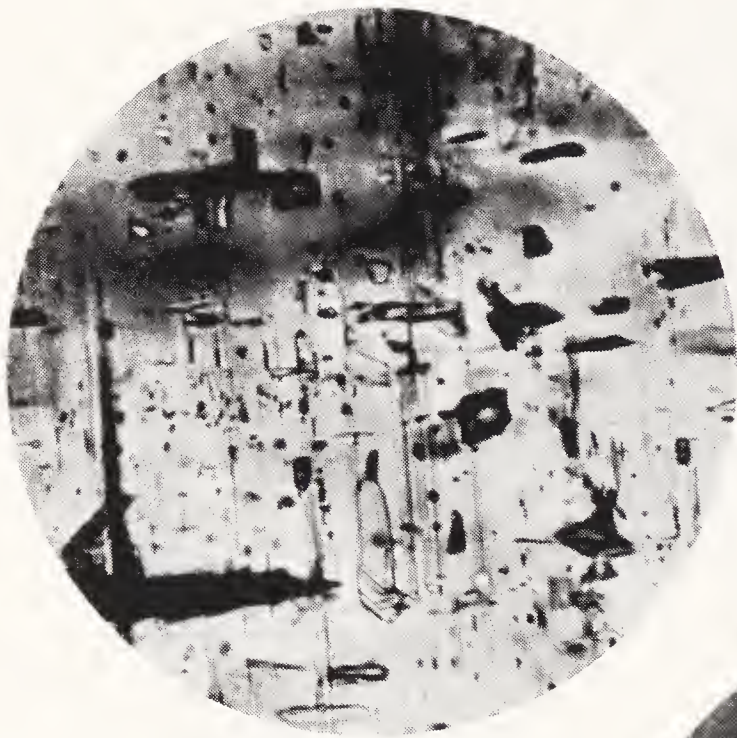

Photo by E. Gubelin

Figure 60
Biotite flakes and other characteristic inclusions in an Indian emerald

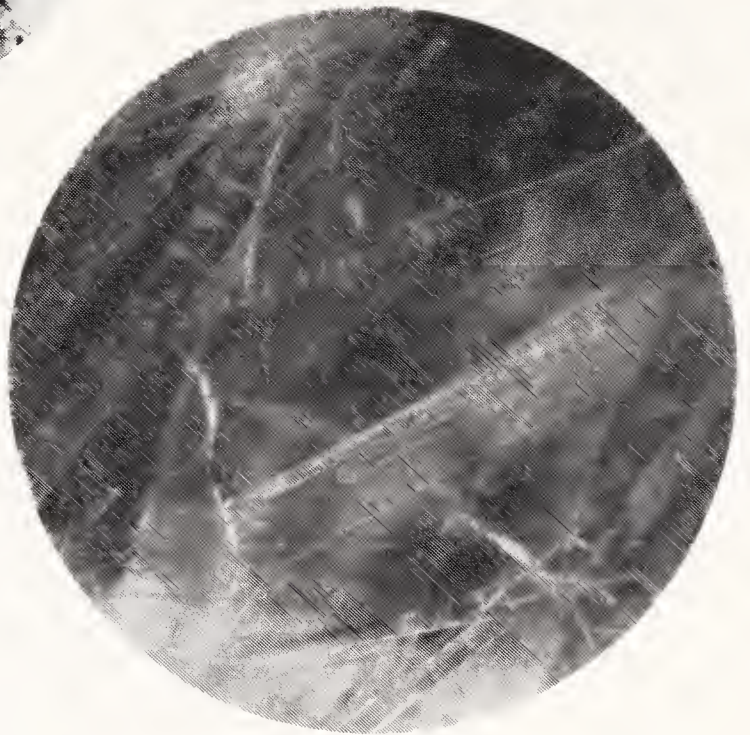

Figure 61
Tremolite or actinolite needles in a Sandawana emerald.

Photo by E. Gubelin

The emerald from most of the localities of the world have inclusions which are characteristic of that area. If one has access to emeralds from known localities, a gemologist can often be relatively sure of their source.

Aquamarine. Though aquamarine is often free from inclusions, it may show characteristic brown, iron-oxide inclusions and tiny, parallel liquid-filled spaces.

Gem Identification by Characteristic Imperfections



Photos by G.I.A.

Figure 62

Octahedral spinel crystals in spinel.



Figure 63

Numerous octahedral spinel crystals which typify natural spinel.

Other Gemstones

Spinel. Spinel's characteristic inclusions are usually formed by tiny enclosed octahedral (eight-sided) crystals of spinel. The included crystals are found both scattered in a random distribution, and in layers of many crystals. The layers of crystals are sometimes parallel to octahedral faces of the spinel where they formed as the crystal grew, but more often these are distributed along irregular fractures.

Topaz. Topaz is more likely to be free from inclusions than almost any other important gem. Its characteristic inclusions are irregular, often fairly large liquid- and gas-filled spaces that may contain two or more nonmiscible liquids separated by a clear dividing line. (See photomicrograph.) The easy cleavage parallel to the base of the orthorhombic topaz crystal is sometimes shown

in the cut gem by straight feathers. Clear signs of cleavage serve to separate topaz from most of the gems with which it is confused.

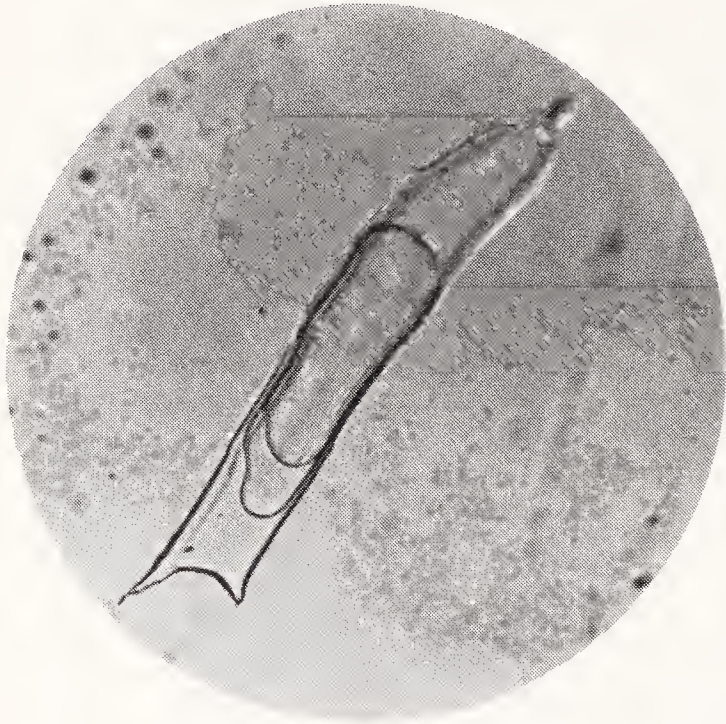

Figure 64
Irregular gas-and-liquid-filled space in topaz.

Photo by E. Gubelin

Zircon. High-property zircon does not have distinctive features likely to be encountered in a majority of stones examined. However, the sum of common features provides a valuable indication of identity.

The high birefringence of all but green or the very rare orange metamict zircon results in a strong doubling of the opposite facets in zircon of any other color. The junction of two facets appears to be two lines when the microscope is focused through the gem onto the pavilion facets. Similarly, inclusions in all but green zircon appear doubled in any direction at more than a small angle to the axis of single refraction.

White zircon often has many inclusions so tiny that they cannot be resolved individually, but give a total effect referred to as "cottony."

Zircon, unlike diamond, appears cloudy, rather than clear or sharply transparent.

Occasionally, zircon contains flat planes of wormlike inclusions,

Gem Identification by Characteristic Imperfections

Figure 65
Doubling of opposite
facet edges in a zircon.

Photo by G.I.A.

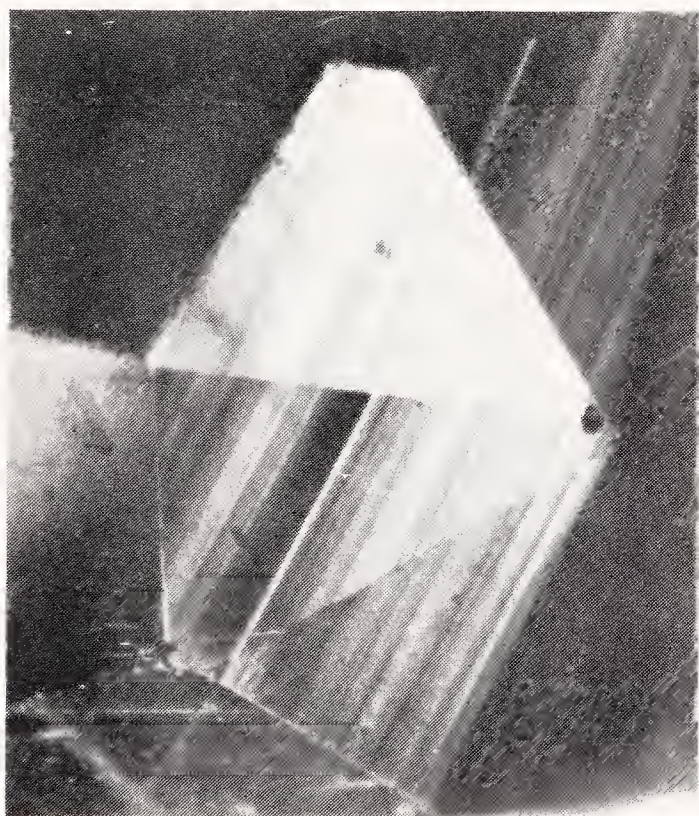
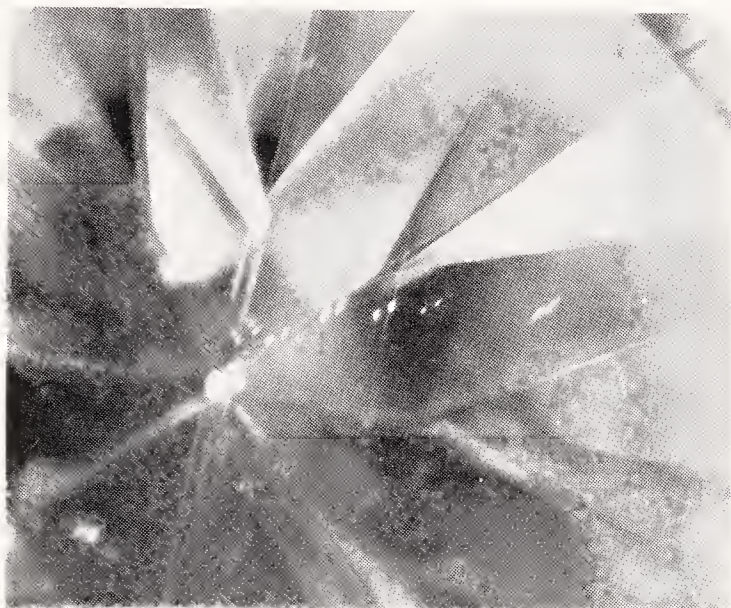

Figure 66
Strong parallel zoning in low-
property zircon

Photo by G.I.A.

roughly circular in contrast to the angular-patterned liquid inclusions of the corundum fingerprint.

Low-property zircon, usually green, is characterized by the presence of strong parallel zoning. All low-property zircons examined in the GIA laboratories have exhibited this characteristic. (See photomicrograph.)

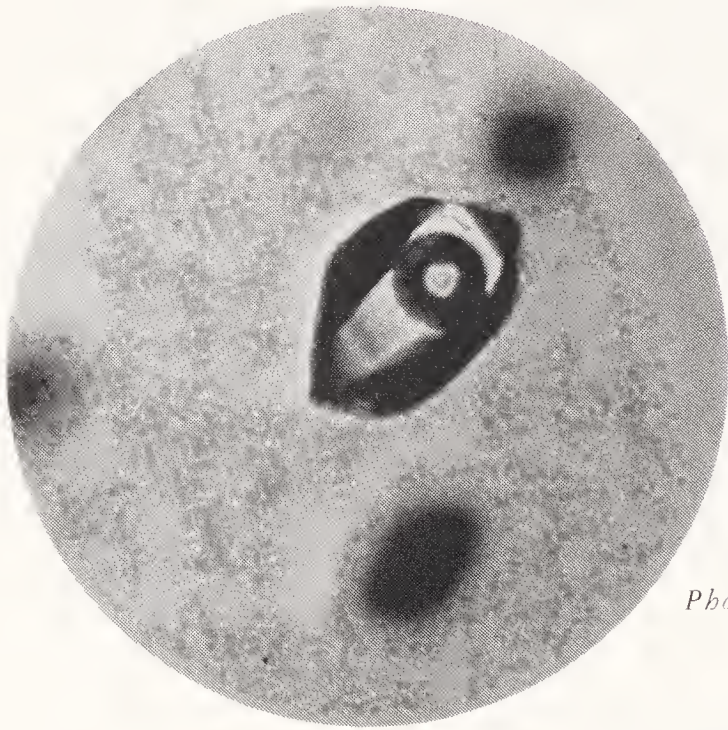

Figure 67
Liquid and a gas bubble in
negative crystals in rock
crystal quartz.

Photo by E. Gubelin

Figure 68
Inclusions resembling soap
scum in heat-treated ame-
thyst and citrine



Photo by G.I.A.

Quartz

The species quartz has more gem varieties than any other mineral. The crystalline varieties amethyst, citrine, rock crystal and smoky quartz are characterized by inclusions of negative crystals in the usual hexagonal crystal form of quartz.

Gem Identification by Characteristic Imperfections

Figure 69
Moss-like arrangement of manganese oxide in moss agate quartz.



Amethyst and the citrine resulting from heat treatment of amethyst often show cloudy white inclusions that appear as white stripes in a plane. They resemble a soap scum on hard water. A very sculptured fracture surface with subvitreous luster is also characteristic. However, crystalline quartz is often flawless.

Cryptocrystalline quartz (*chalcedony*) has no inclusion typical of all varieties. The dendritic arrangement of manganese oxide in moss agate is characteristic of that variety.

The inclusions that cause a star in quartz are unlike those that produce asteriated ruby and sapphire. The needlelike inclusions are very short and occur in small “bundles” distributed at random throughout the gem. Each of the tiny bundles consists of three sets of needlelike inclusions at 60° to one another. Star quartz seldom appears in the jewelry trade without a red- or blue-mirror backing to give color and to strengthen the star.

Peridot. Tiny black metallic inclusions, surrounded by a small fingerprint pattern of liquid inclusions, characterize peridot when present, but many peridots do not contain such inclusions. Peridot is strongly birefringent.

Diamond. Very frequently seen are included crystals of diamond (likely to be confused with black carbon inclusions unless viewed properly; i.e., by dark-field illumination). Elongated, four-sided prismatic crystals that may be peridot, pyrope garnet or chrome diopside are not uncommon.

The three keys to a diamond identification under magnification are the unique appearance of the surface of a bruted girdle on a brilliant or a marquise, a grooved or trigon-studded natural (an original crystal surface) and cleavages. (See illustration of trigons on naturals.)

Synthetic Gemstones and Their Characteristic Inclusions

In many cases the standard tests for identification of a gemstone will preclude the necessity of an examination of its inclusions, since so few gem species are synthesized. Differentiation between genuine and synthetic stones, however, depends upon the jeweler's ability to recognize inclusions characteristic of each gem. Since synthetics are quite common on the present market, the value of a sound knowledge of the characteristic inclusions of gemstones is emphasized, for the jeweler is frequently called on to distinguish between a genuine and a synthetic stone.

The many important gems made synthetically have characteristic differences under high magnification. Although inclusions commonly found in synthetic corundum, spinel and emerald are discussed in the chapter on synthetic gemstones, they are of such importance to the jeweler in identifying gems that it is well to describe them here as well.

Flame-Fusion Synthetic Corundum. Spherical gas bubbles are characteristic of synthetic corundum and may have the following appearance and arrangements:

They may be *round in cross-section, but elongated*, like a bubble that has risen from its original position in a molten material. They may be found in *groups of many tiny bubbles*, frequently with one or two large bubbles in addition, or as *rough lines of bubbles arranged on a curve*.

Gem Identification by Characteristic Imperfections



Figure 70

A colorless octahedron of diamond as an inclusion in diamond (taken under dark-field illumination).

Photo by E. Gubelin

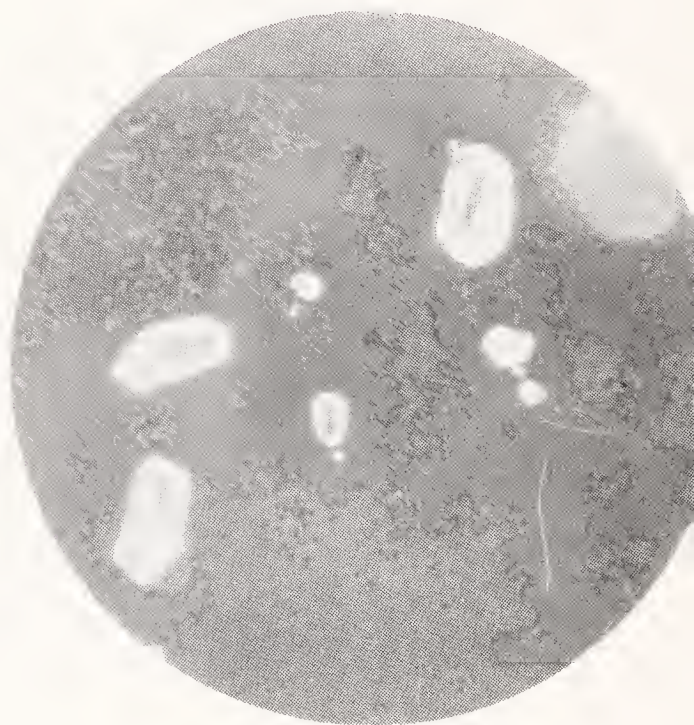

Figure 71.

Peridot crystals included in diamond

Photo by E. Gubelin

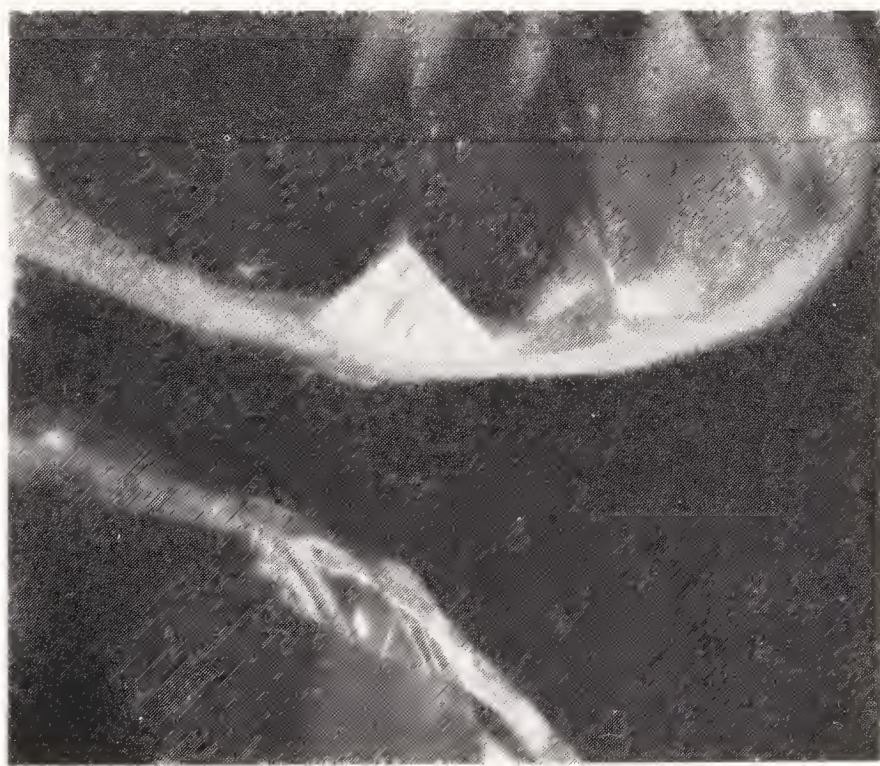

Figure 72

Trigons on a natural on a girdle of a diamond

Photo by G.I.A.

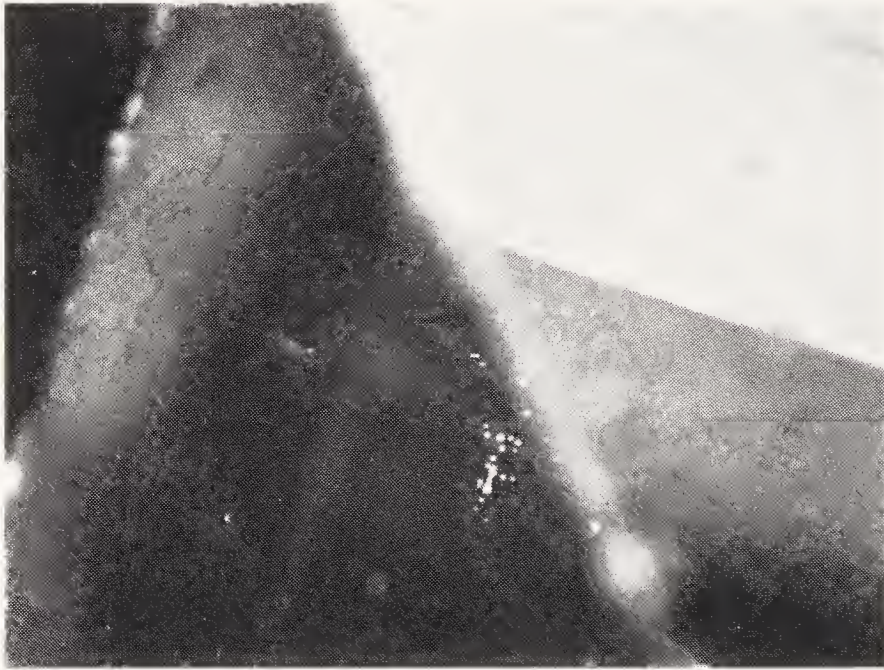

Figure 73

Photo by G.I.A.

A patch of tiny spherical gas bubbles in synthetic corundum.

Curved growth lines, or striae, are often evident in synthetic corundum, and are characteristic. However, they are not seen in yellow, orange, or colorless synthetics. (See *Figure 74* and Chapter X.)

Caution: Since polishing marks on a facet may resemble striae, be sure to focus the microscope on a point within the gem when observing the stone for curved striae, and be certain that the striae continue across several facets.

Flux-Grown Synthetic Ruby. Both Carroll Chatham and Kashan Laboratories of Texas are marketing synthetic rubies grown by flux techniques. Inamori is a third manufacturer.

Early individual crystals offered by Chatham were characterized by large natural seeds. Seeds were not noted in the darker red faceted stones and cabochons. Both Chatham and Kashan synthetics may have veil-like or wisplike inclusions (*Figure A*), similar in appearance under low magnification to flux-grown synthetic emeralds. There are usually coarser flux inclusions and smaller tubes, giving the appearance of dashed lines (*Figure B*). Occasionally, a thin tube resembles coarse silk (*Figure C*). For further comments on detection, see Chapter X.

Gem Identification by Characteristic Imperfections

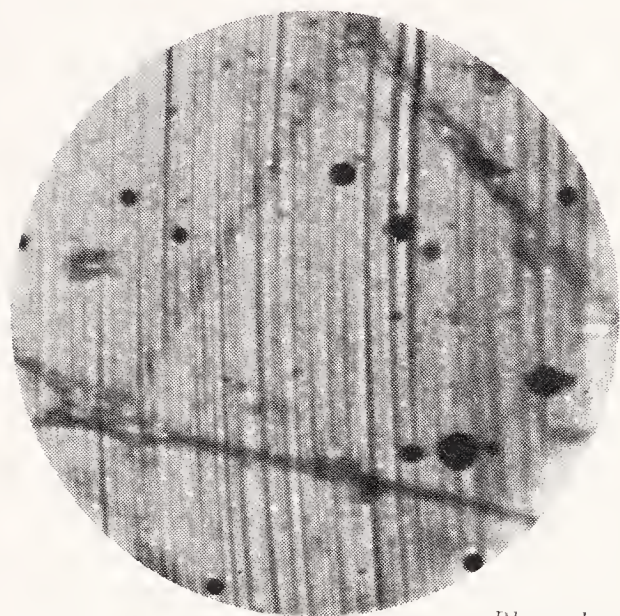

Photo by E. Gubelin

Figure 74
Spherical gas bubbles and
curved striae in synthetic
flame-fusion ruby

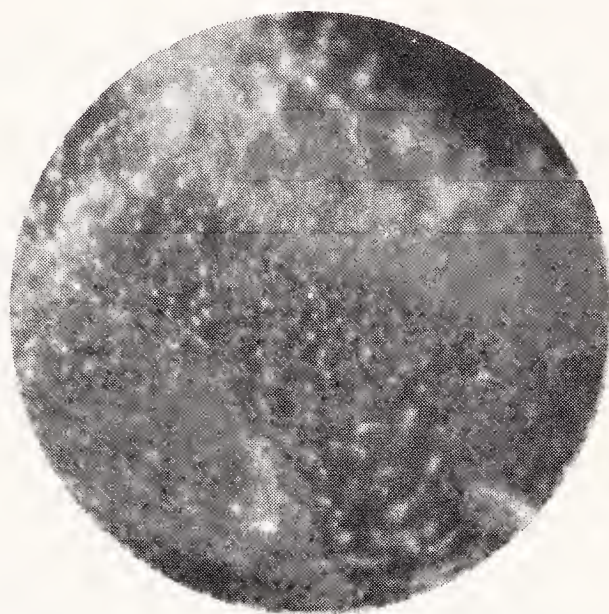

Photo by G.I.A.

Figure A
Veillike or wisplike inclusions
in flux-grown synthetic ruby

Synthetic Spinel. Spherical gas bubbles, usually very small and quite widely separated, rarely grouped, are characteristic of synthetic spinel.

Small inclusions that have the appearance of white bread crumbs in dark-field illumination also characterize synthetic spinel, but are less commonly encountered. (See *Figure 75.*)

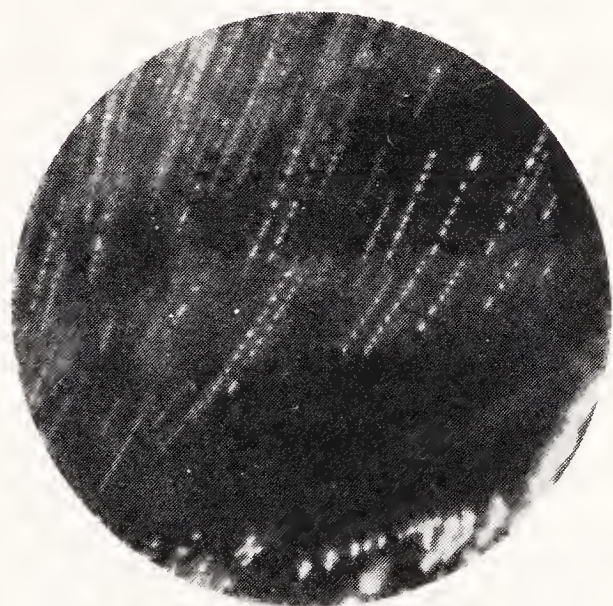

Photo by G.I.A.

Figure B
Dashed lines in flux-grown
synthetic ruby

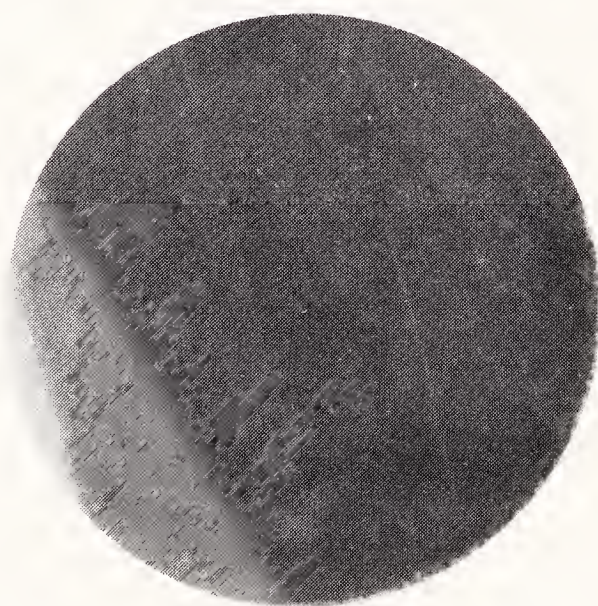

Photo by G.I.A.

Figure C
Coarse "silk" in flux-grown
synthetic ruby

HANDBOOK OF GEM IDENTIFICATION

Very rarely curved color bands are visible in synthetic spinel, but *never* curved striae in any color but red.

Synthetic spinel often contains inclusions that have a deceptively natural appearance. Larger gas bubbles often have a distinctly angular outline. Threadlike gas inclusions are common. (See photographs in Chapter X.)

Fortunately, there are other means of separation; also, minute spherical gas bubbles almost always accompany the deceptive types of inclusions.

Synthetic Emerald. Synthetic emerald is distinctly different from either synthetic spinel or synthetic corundum in that it contains no spherical bubbles and *never* has curved growth lines. There are now several distinct types of synthetic emeralds available. The flux-fusion type, such as those manufactured by Chatham, Gilson and Zerfass, is distinctly different from the hydrothermal type made by Linde. The hydrothermal overgrowth of synthetic emerald on prefaceted natural beryl made by Lechleitner is different from either.

The inclusions of the flux melt products have a deceptively natural appearance. Indeed, the Chatham, Gilson and Zerfass synthetic

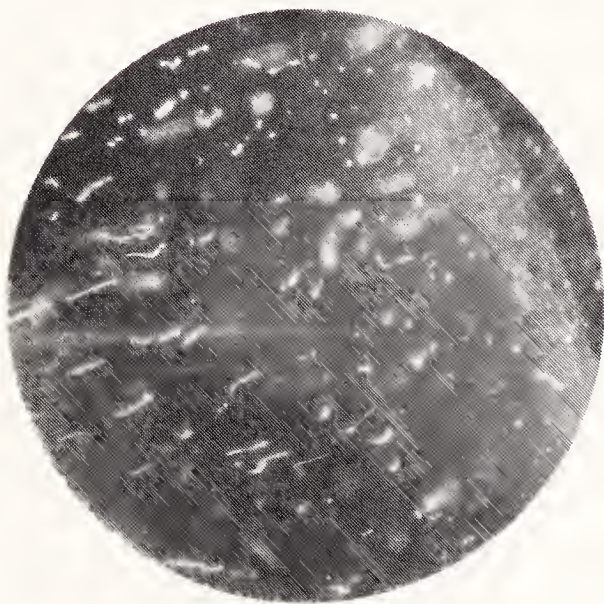

Figure 75
Irregular threadlike gas in-
clusions in synthetic spinel
Photo by G.I.A.

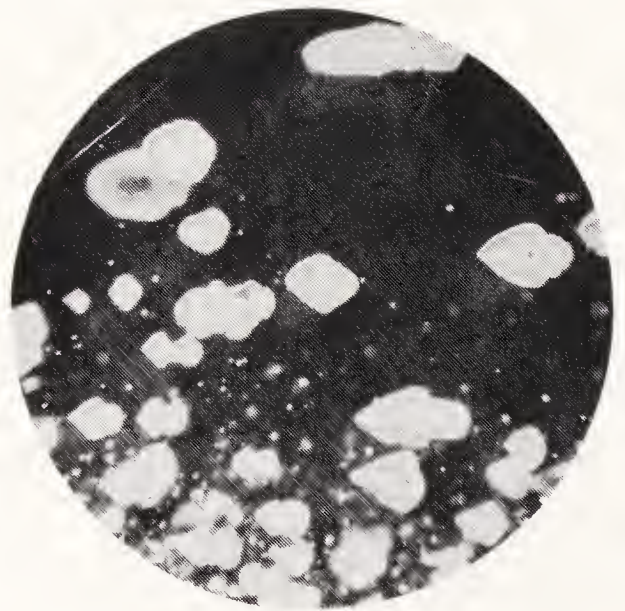

Figure 76
Large profiled and tiny spherical
gas bubbles in synthetic spinel.
Photo by E. Gubelin

Gem Identification by Characteristic Imperfections

emeralds bear such a close resemblance to the genuine gem that it is unwise for the inexperienced jeweler to attempt to distinguish between the two by means of inclusions. Natural emeralds often show three-phase inclusions (solid, liquid and gas within the same space). Colombian emeralds have tiny square crystals in the spaces partially filled by liquid and gas. Pyrite crystals are common in natural emerald. The Chatham synthetic usually contains crystals of platinum. These cubic crystals are white, in contrast to the brass yellow of the pyrite crystals in the natural. They are usually close to the surface. Platinum is soft and sectile, in contrast to hard, brittle pyrite. A needle point will distinguish between the two in crystals at the surface. Chatham synthetic emeralds, as well as Gilson and Zerfass products, also are characterized by the presence of wispy or veillike groups of flux inclusions. The appearance illustrated is unlike any pattern observed in genuine emerald; but for the novice, the lower property values in conjunction with strong fluorescence under long-wave ultra-violet furnishes a safer means of identification. (See Chapter X.)

The synthetic emerald-coated beryl (Lechleitner) is characterized by parallel cracks in the thin coating. Within the large preformed seed, natural beryl inclusions are to be expected. The overgrowth is not polished on most facets, so tiny crystal faces are visible under magnification. (See photographs.)

The more recent hydrothermal synthetic emeralds developed by Linde lack the wispy inclusions that characterize the flux-fusion products. Instead, they have tiny two-phase inclusions. Often, they



Figure 77
Wisp-like patterns of solid
flux inclusions in synthetic
emerald.

Photo by E. Gubelin

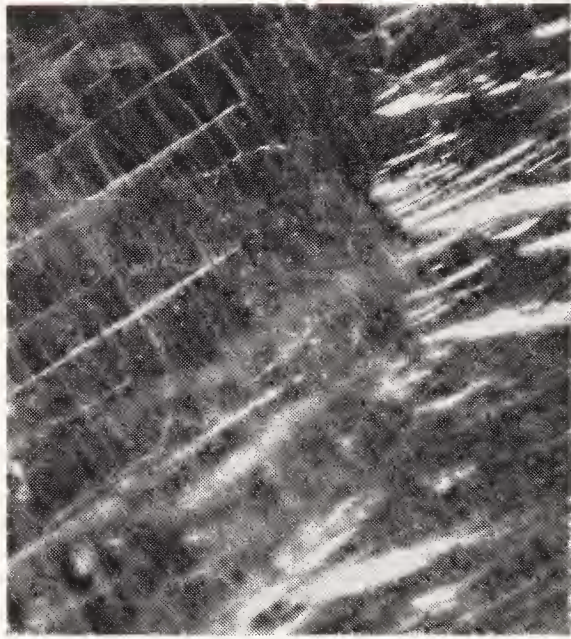

Figure 78

Characteristic parallel strain cracks in thin synthetic emerald layer in Lechleitner product

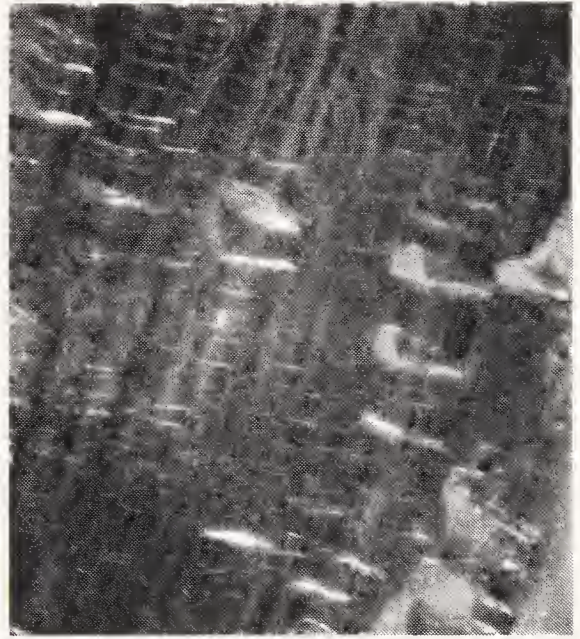

Figure 79

Lechleitner product, showing growth pattern of synthetic emerald on pre-faceted beryl

have larger phenakite crystals with cuneiform spaces extending from them. (See *Figure 80*.)

Reconstructed Ruby, by definition, would be manmade ruby produced by using fragments of natural ruby. Apparently, sintering was never used; Kurt Nassau, Ph.D., proved that the color is driven off and that it is not possible to sinter natural ruby fragments into material with the color and texture of ruby. However, it is apparent that small button-shaped synthetic rubies were made before the advent of the Verneuil process. Such synthetic ruby had sets of curved striae meeting other sets at abrupt angles. A somewhat similar striae condition could exist at the tip of modern boules started on synthetic seeds.

Synthetic Garnet. A number of materials with a wide variety of compositions have been made with structures identical to the garnet group, but with compositions unknown in nature. Almost every color of the spectrum has been made. Yttrium-aluminum and yttrium-iron garnet structures have been mentioned most often, but many other elements have been used to achieve desired results, mostly for laser research. Many of these have gem-substitute potenti-

Gem Identification by Characteristic Imperfections

Figure 80

*Typical "comma" inclusion
(phenakite crystal with
smaller cuneiform space
extending from it) in a
Linde hydrothermal
emerald.*

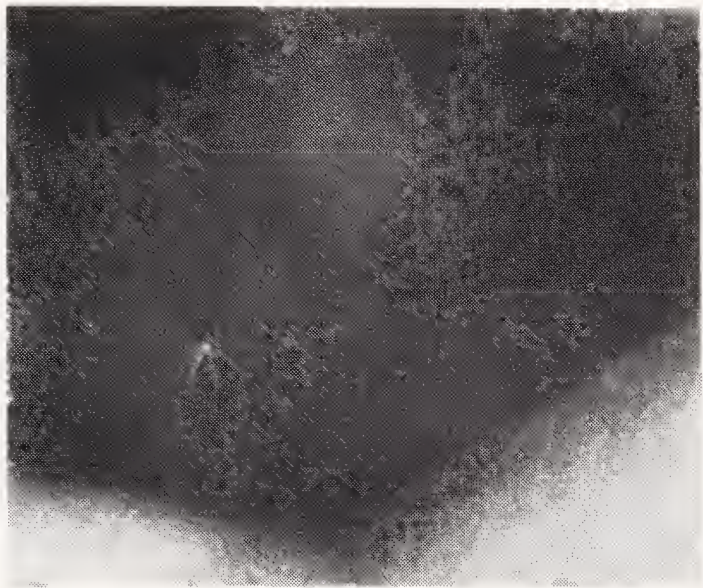

Photo by G.I.A.

ality, but to date only substitutes for demantoid have appeared at GIA Laboratories in finished jewelry. Since natural garnets in other colors are inexpensive, the high cost of the synthetics made to date have precluded wide use in other colors.

The inclusions in YAG include not only gas bubbles, but rather irregular-appearing fingerprints. In addition to a few spherical inclusions that are somewhat akin to what one would expect in synthetic corundum, there are tubelike inclusions reminiscent of those of synthetic spinel (*Figure 81A*).

Glass. Spherical or elongated gas bubbles and swirl marks, or flow lines, characterize glass. The latter are caused by incomplete mixtures of the ingredients of the melt or are formed by pressure as the glass is molded into its faceted-gem appearance.

Often, insoluble angular material is mixed with glass to simulate the genuine inclusions of certain species of gemstones. Such inclusions are seldom an accurate representation of those of the genuine gem and they are invariably accompanied by many bubbles, but a hasty examination may lead to an incorrect identification. Glass is often flawless.

Synthetic Rutile. The spherical gas bubbles that characterize synthetic corundum and synthetic spinel are also to be found in synthetic rutile. The most unusual feature of the material under magnification is the tremendous doubling of opposite facet junc-

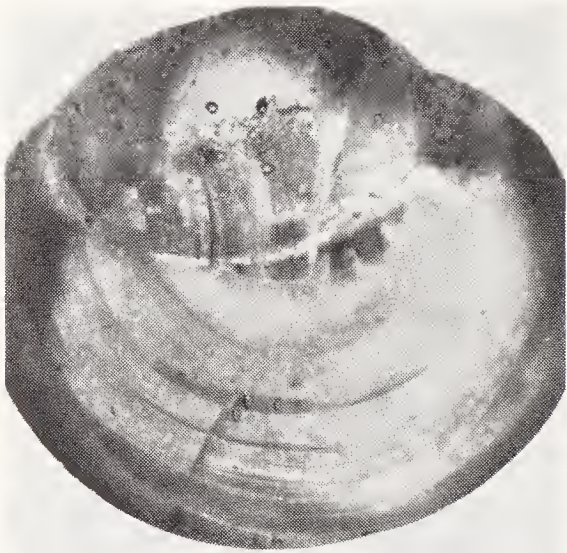

Figure 81
 Button-shaped synthetic ruby
 showing striae intersecting at
 abrupt angles



Figure 81A.
 Typical inclusions in yttrium-
 aluminum garnet

tions and of any inclusions that may appear. In even small faceted stones, the birefringence causes two entirely separate culets to be seen. (See illustration in Chapter VI.)

Synthetic Quartz. Rock crystal quartz has been made synthetically by hydrothermal methods for many years. It is widely used, especially in the communications field. To our knowledge, this has not been used to any extent for jewelry purposes. In the last few years, synthetic quartz has been made in a variety of colors, both in Russia and the United States. Not only are citrine and amethyst colors manufactured, but also blue and green transparent quartz that does not resemble anything known in nature. Some of the stones can be identified by color banding parallel to the flat seed plate that was used to get the growth started. The banding may give a kind of heat-wave effect parallel to the seed. Although many are without inclusions, sometimes there are breadcrumb or dustlike inclusions, or spicules similar to those that characterize hydrothermal synthetic emerald.

Synthetic Turquoise. Synthetic turquoise made by Pierre Gilson has been on the market for several years. It is readily distinguished by its appearance under magnification of about 50x. Under very

Gem Identification by Characteristic Imperfections

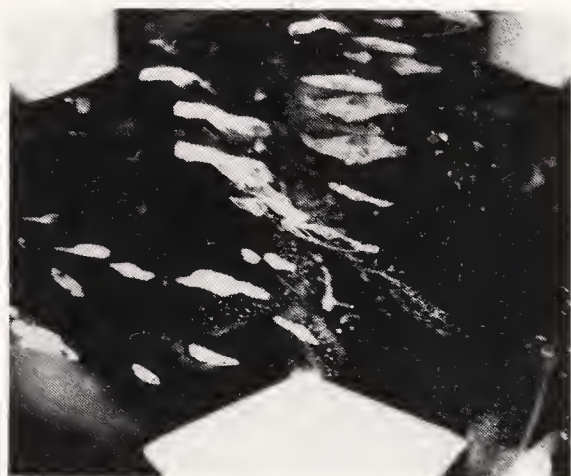

Figure 82A
Typical coarse flux inclusions
in synthetic alexandrite.

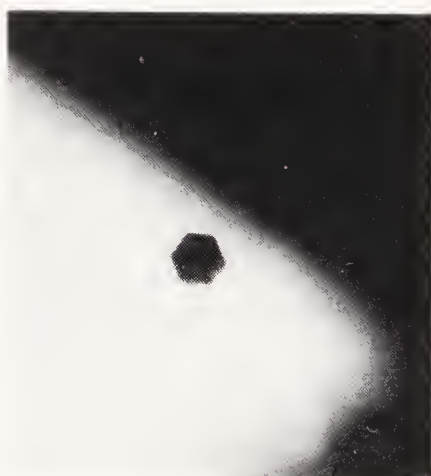

Figure 82B
Opaque hexagonal platelet
inclusion in synthetic
alexandrite.

high magnification, it is seen to be made up of darker blue spheres in a white ground mass.

Synthetic Alexandrite (flux-grown) is rather easily separated from natural material by the presence of inclusions of a typical flux-grown appearance — either in veillike patterns or as tubes of flux. (See Figure 82A.) There are also tiny cut-corner triangular or hexagonal platelets that appear metallic. (See Figure 82B.) The synthetic is strongly fluorescent.

Synthetic Alexandrite (Czochralski). There is a new synthetic alexandrite made by a pulling technique that shows characteristics of that method of growth. Certain directions of flatly curved striae are visible. Gas bubbles are possible but were not frequently seen in the few specimens that we had a chance to examine. Those specimens were quite light in color.

Strontium Titanate. This Verneuil product is similar to the others in that it usually contains spherical gas bubbles.

Conclusions. It is manifestly impossible to convey by word alone a sufficiently accurate description of characteristic inclusions so that the reader will be able to identify a gemstone simply on a basis of its appearance under high magnification. The purpose of this chapter is to call to the attention of the reader the possibilities of the use of a gem's inclusions as a means of identification that will become increasingly valuable to him as he becomes more adept at gemtesting.

Chapter IX

Color Filters and Fluorescence

Sunlight and the light from other incandescent light sources is made up of a blend of the colors of the spectrum. The white light we see may be made up of all spectral colors or just some of them. To appear colorless to the eye, gemstones must either transmit all of the spectral hues or enough to achieve a balanced transmission the human eye perceives as white. Colored stones are seen as colored because of a selective absorption of some of the wavelengths of the white light transmitted. Differences in absorption of the various wavelengths cause differences in appearance, such as those characterizing ruby, red spinel, red tourmaline and the red garnets, for example. A keen eye, familiar with the characteristic appearances of the various gemstones, may be able to distinguish between even very similarly appearing gemstones with a high degree of accuracy. However, to identify beyond question, other devices than the human eye are needed, for the eye is incapable of analyzing the composition of a light, whether colored or white. To assist the eye, the gemologist employs such devices as the dichroscope, color filters and the spectroscope. The function of the dichroscope was explained in Chapter VI.

The Emerald Filter. Of the color filters used for various purposes in science, that of greatest use to the gemologist is that known variously as the Chelsea, or emerald, filter. The transmission curve of the emerald is unusual among green gemstones, in that a portion of the yellow-green spectrum is largely absorbed by emerald and a major portion of the deep red is transmitted. Anderson and Payne, of the London Laboratory, prepared a filter that permitted the

Color Filters and Fluorescence

passage of little green, except that in the yellow-green wavelengths, but permitted the transmission of the deep-red wavelengths. Since the portion of the green and yellow-green spectrum transmitted by most emeralds is absorbed by the filter, only the deep-red secondary peak of emerald transmission is seen through the filter. As a result, most (but not all) emeralds and synthetic emeralds appear red through the filter, in contrast to most other green gems and substitutes. Synthetics, especially the hydrothermally-grown Linde are strongly red. Other green gems, lacking the yellow-green absorption of emerald, usually appear green. Demantoid and green zircon often give a pink appearance, and green plastic-coated beryl may appear red. Some emerald-imitation triplets have a green cement that makes them appear red through the filter, but these are exceptions. Most doublets and triplets, jadeite, tourmaline, glass and green chalcedony appear green. Occasionally, dyed jadeite and green-dyed chalcedony take on a pinkish color when seen through the filter.

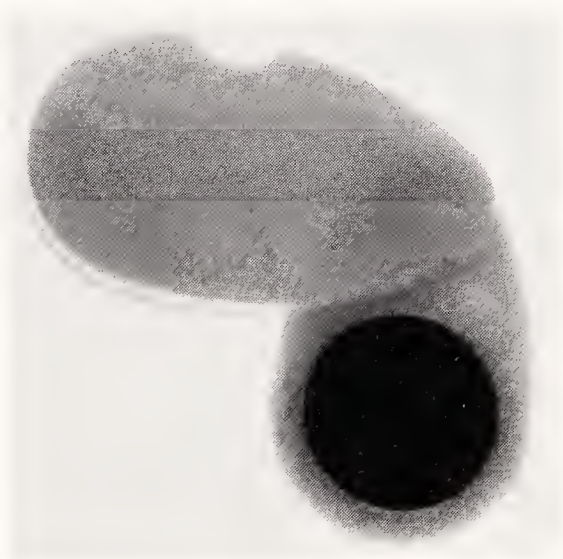
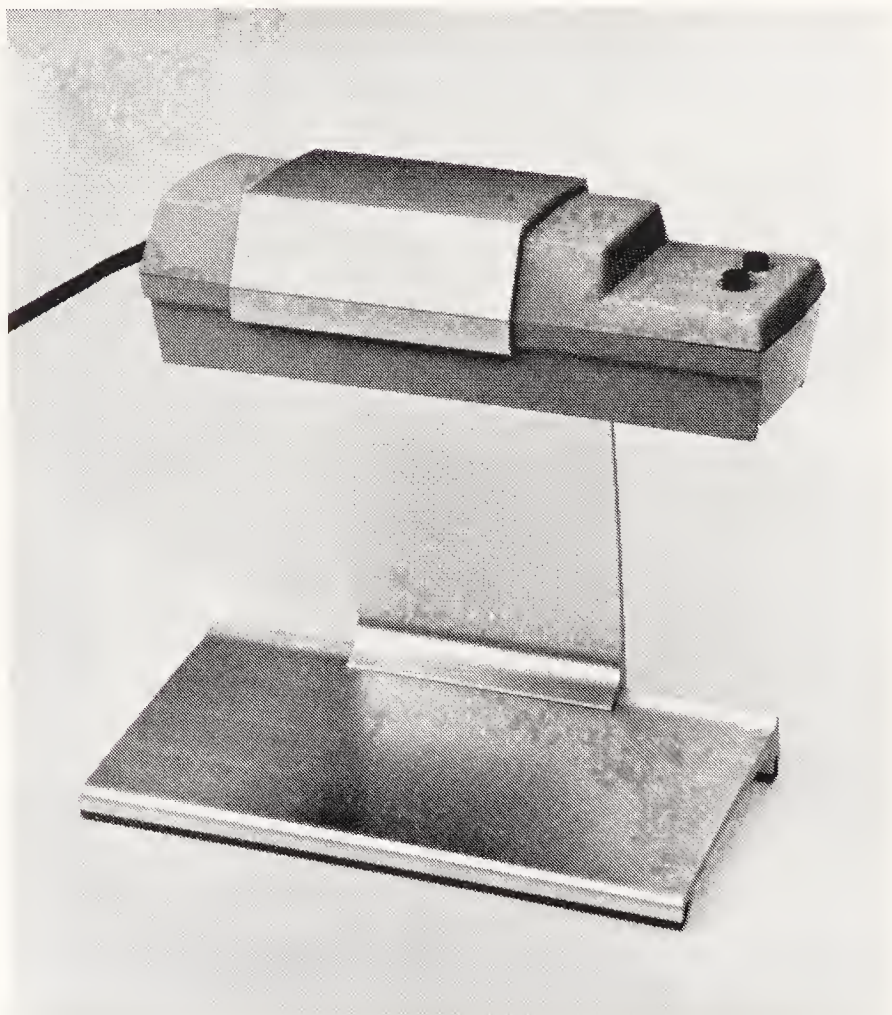

Figure 83
The Emerald Filter.

How to Use the Emerald Filter. To use the emerald filter, hold the gem over or beneath a strong white-light source and examine it with the filter held close to the eye. The value of the emerald filter in testing green stones is limited not only by the exceptions

to the expected behavior, as indicated earlier, but also by the fact that the appearance of the Chatham synthetic is substantially identical to that of the fine natural stone. Moreover, certain mines, notably Indian and African, produce stones that remain green under the filter.



*Figure 84
Mineralight with stand*

Synthetic blue spinel also appears red through the emerald filter in contrast to most genuine spinel and other blue gems that spinel imitates. However, natural spinel sometimes shows red through the filter. It is unwise to decide upon the natural or synthetic character of spinel on the basis of such a test, when more effective means of detection of the synthetic are available.

Fluorescence and Phosphorescence. When radiation shorter in wavelength than visible light (ultraviolet or X-rays) falls upon

Color Filters and Fluorescence

certain materials, they have the property of transforming the invisible radiation to wavelengths of visible spectrum range. This property is called *fluorescence*. If the light emission continues after the object has been removed from the source of excitation, the material is said to be *phosphorescent*. Since the color of the fluorescence is often distinctive for certain gemstones, it is sometimes a certain test, but more often merely an indication of a gem's identity.

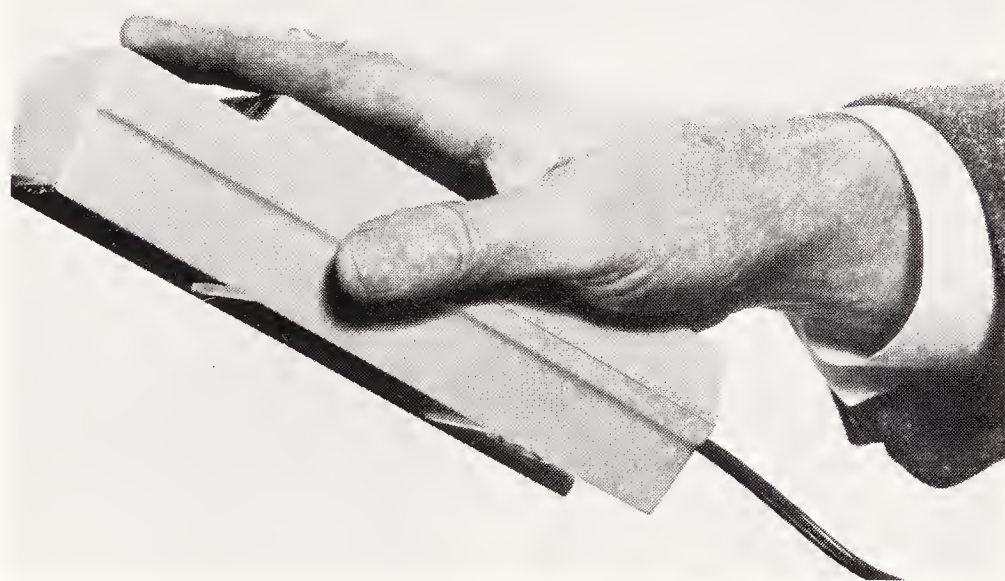

Figure 85

The Mineralight

Ultraviolet-light sources of two wavelengths are most commonly used; certain materials will fluoresce under a radiation with a wavelength of 2537\AA , while others are more strongly affected by radiation of 3660\AA . One Mineralight model furnishes the short-wave radiation and another the longer wave 3660\AA radiation. The filter on the short-wave ultraviolet lamp is critical. After about 400 hours of use, or not more than one year of elapsed time, the filter should be replaced, for it loses its effectiveness in filtering out long-wave ultraviolet. When this happens, its value in several tests is reduced or lost. The filter should be kept free of surface film of dirt or tarnish.

About 15% of gem diamonds fluoresce strongly under the 3660\AA light, but usually show less fluorescence under the shorter wave-

length radiation. Diamond fluorescence is usually a light blue, but can be almost any color of the spectrum. The type of diamond known as Premier always fluoresces very strongly, usually in a light-blue color. Under short-wave ultraviolet, blue synthetic sapphire fluoresces slightly, giving an appearance of a yellowish smudge. It is best observed in a dark room. Natural blue sapphires show no such effect.

Natural yellow sapphires from Ceylon fluoresce in a very distinctive apricot color. Synthetic yellow sapphires either fail to fluoresce, as do other natural sapphires, or the synthetics fluoresce in a dull red color under long-wave ultraviolet. Chatham synthetic emeralds always fluoresce and natural emeralds almost always fail to fluoresce under long wave. The fluorescence is best seen if the test is performed in a dark room with the stone placed on a dull-black background. One type of Gilson synthetic emerald fails to fluoresce and some very fine natural emeralds show weak to moderate red fluorescence, so this is not an infallible test. There are many other separations in which reaction to ultraviolet light is useful in identification.

Many triplets and garnet-and-glass doublets can be detected at one time by the use of the fluorescence test. Glass bases on garnet-and-glass doublets usually fluoresce a greenish yellow under 2537Å. The nonfluorescent garnet stands out as a dark spot on the fluorescent background. The cement layers of some triplets fluoresce strongly, thus standing out clearly from the top and base of the imitation. Natural lapis-lazuli fluoresces green under short-wave ultraviolet. Another characteristic appearance to short-wave is the red fluorescence of feldspar. Often, carvings that are difficult to identify are shown to be largely feldspar by short-wave ultraviolet when the characteristic red fluorescence appears. It is very helpful in the identification of saussurite, a combination of feldspar (usually albite) and zoisite.

Transparency to Ultraviolet. Another property sometimes employed in testing is transparency to ultraviolet radiation. Using a quartz spectrograph, B. W. Anderson noted that whereas natural emerald failed to transmit wavelengths below about 3000Å, the

Color Filters and Fluorescence

Chatham synthetic transmitted down to about 2300Å. Another British gemologist, Norman Day, proposed a test to utilize this difference in testing; however, it requires darkroom facilities and supplies, plus exacting exposures. Unknowns are placed on photo print paper in a dish of water (use nonfluorescent glass) and given a short exposure (usually a fraction of a second) to a short-wave ultraviolet lamp. Both synthetic ruby and Chatham synthetic emerald transmit the light and expose the paper, whereas the natural stones appear to be opaque to the lamp. A generally more satisfactory test to detect this difference in transparency to ultraviolet is described under Chatham synthetic emerald in the next chapter.

The Crossed-Filter Technique. For years, the British gemologists have used an interesting technique they refer to as “crossed filters.” A white light is directed through a flask containing a blue solution of copper sulphate onto a ruby, synthetic ruby or red spinel and then viewed through a red gelatin filter. Both the natural Burma and the Verneuil synthetic ruby, plus red spinel, appear bright red under these conditions; but spinel appears distinctly different when viewed through a spectroscope. Spinel shows a series of bright lines, the “organ-pipe” lines in the red, whereas ruby and synthetic ruby show bright lines in a doublet at 6928 and 6942 Å.

Chapter X

Synthetic Gemstones

A synthetic gemstone is one that has the same chemical composition, crystal structure, and, consequently, the same physical and optical properties as those of the natural gem it represents. Since its properties are the same as those of its natural counterpart, the usual property determinations are often valueless in the detection of the synthetic. The rise of the laser industry, with its proliferation of experimental crystal growing in an unending search for new materials with different lasing properties, has been responsible for a growing expertise in synthetic crystal growth. Yttrium aluminum garnet was just one result. Doping by different rare earths created a variety of colors. Other materials encountered include yttrium oxide, an unnamed orthorhombic yttrium aluminate, Y.I.G. (yttrium iron garnet), and GGG (gadolinium gallium garnet), now used as a diamond substitute. Other scientific efforts brought forth synthetic equivalents of greenockite, scheelite, powellite, periclase, bromellite and many other minerals, plus materials unknown in nature such as lithium niobate (Linobate) and KTN (niobium doped potassium tantalate).

The long available synthetic gem materials were flame-fusion corundum, spinel, and rutile. Then came the flux melt emerald variety of beryl, followed by ruby, and then alexandrite. Hydrothermal emerald and ruby (or pink sapphire) followed, with a number of varieties of quartz following the rock crystal that had been made for years. Pierre Gilson developed processes for making both synthetic opal and synthetic turquoise.

Synthetic Corundum (Flame Fusion)

Manufacture. Synthetic corundum is produced by the Verneuil process. It is now manufactured in the United States in large quantities,

Synthetic Gemstones



Figure 86

A Verneuil Oven with half-formed boule in position.

mostly by the Linde Company. Powdered aluminum oxide is dropped through an oxy-hydrogen flame in which it melts before falling upon a slowly revolving ceramic rod. As the molten alumina solidifies, it assumes the crystal structure of natural corundum. The boule resulting from the accumulation of molten drops of aluminum oxide may weigh hundreds of carats. Because of the internal strain that is always present, the pear-shaped rough boule must be split lengthwise before cutting, unless subject to an annealing process to relieve strain. If the aluminum oxide that comprises corundum or synthetic corundum is pure, the crystalline material is colorless. The addition of small percentages of certain metallic oxides lends color to the synthetic product. Synthetic corundum is produced in most of the colors in which corundum is found in nature as well as many not occurring naturally.



Figure 87
Stages of boule growth.

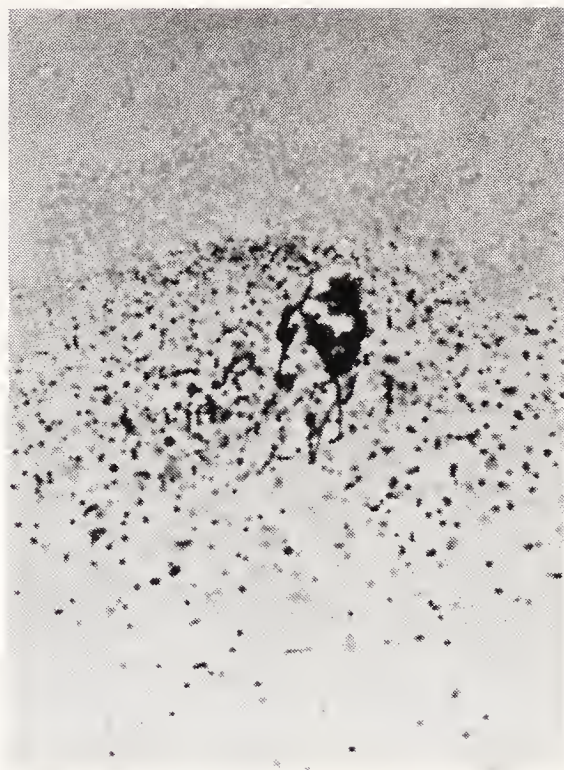

Figure 88
A patch of tiny spherical gas bubbles with a few irregular gas inclusions. The bubbles show as bright points in dark-field illumination.

Although man must add slightly higher percentages of the metallic-oxide coloring agents to produce colors comparable to those of natural corundum, no significant changes in physical and optical properties result. The specific gravity of the synthetic is within .03 of 4.00, the average figure for natural corundum; the principal refractive indices are 1.762 and 1.770, and the birefringence is .008 — exactly the figures for nature's product.

Flux-Grown Synthetic Rubies. Kashan Laboratories and Chatham Laboratories also make synthetic rubies by flux techniques. Presently, Chatham is making only crystal groups and crystals large enough to cut up to 1- or 2-carat sizes, whereas Kashan is making dark-red synthetic rubies in sizes large enough to cut 10-carat or even larger pieces.

In addition to the flame-fusion, flux, and hydrothermal methods, synthetics are grown by the Czochralski pulling technique.

Synthetic Gemstones

Synthetic Star Corundum. In 1947, the Linde Company introduced synthetic star corundum in red and blue colors. The asterism is caused by needlelike rutile inclusions so minute that magnification of at least 50x is required to resolve them.

Linde produces the synthetic star corundum by heating boules containing .1% to .3% titanium oxide to from 1100°C. to 1500°C. Heating for from two hours at 1500°C. to 72 hours at 1100°C. brings about precipitation of the titanium oxide along the three directions parallel to the normal prism faces of corundum in the basal plane. If more than .3% titanium oxide is used to make the original boule, it is very difficult to grow it. After the boule is heated to bring about precipitation of the titania (as rutile, apparently), it is fashioned with the base perpendicular to the optic axis (c axis) and reheated. Although the early products had tiny rutile needles only in a surface layer, later synthetic star rubies and sapphires have the needles distributed throughout the stone. Brown and white varieties have been added to the original red and blue colors. Synthetic star corundum is now also made in Western Germany and Japan.

Later Linde developed a method for enhancing both color and asterism in natural sapphires. However, Linde has ceased all production.

Transparent synthetic corundum, cut in a cabochon form with a flat back, is engraved with sets of fine parallel lines at 60° on the flat surface. Usually the back is covered by a foil or mirror and a flatly curved piece of synthetic corundum. Such foilbacks have been offered as “synthetic star rubies” or “sapphires.”

A bright light directed into the cabochon from the side usually reveals many spherical gas bubbles in synthetic star corundum.

Conclusive Methods of Distinguishing Between Corundum and Synthetic Corundum

1. *The shape of inclusions* can be used to determine positively whether corundum is natural or flame-fusion synthetic.

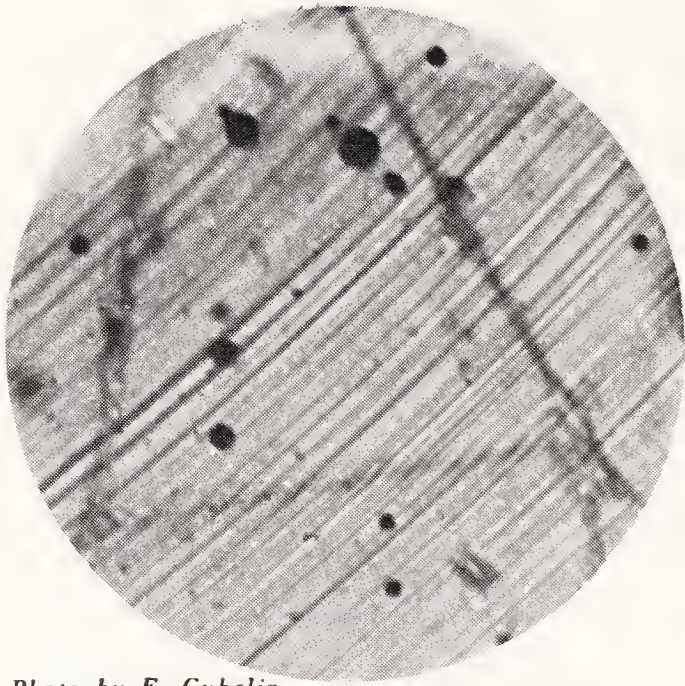

Photo by E. Gubelin

Figure 89
Curved striae and spherical bubbles
in synthetic corundum.

Inclusions in Flame-Fusion Synthetic Corundum. Synthetic corundum is characterized by the presence of spherical gas bubbles. The bubbles are normally small, appearing as bright pin-points of light when the gem is examined under magnification in dark-field illumination. The tiny spheres usually occur in groups or patches distributed unevenly throughout the gem, or confined to a single area. Occasionally, a large spherical gas inclusion is found within a patch of tiny spheres. Bubbles are often arranged roughly in curves corresponding to the growth lines of the boule. It is not uncommon to find elongated gas bubbles resulting from movement in the viscous material during cooling. Such inclusions are circular in cross-section in one direction, but elongated in the other. Some European synthetics contain irregular inclusions in addition to spherical bubbles, but, since spherical inclusions are not found in natural gemstones, little difficulty is encountered in their identification. However, the detection of an irregular inclusion in a gemstone is no longer a proof of natural origin. Synthetic star ruby and sapphire seems to have more spherical gas bubbles than are common in faceted synthetics of recent manufacture. Transparent synthetic corundum entirely without bubbles is becoming increasingly common.

Synthetic Gemstones

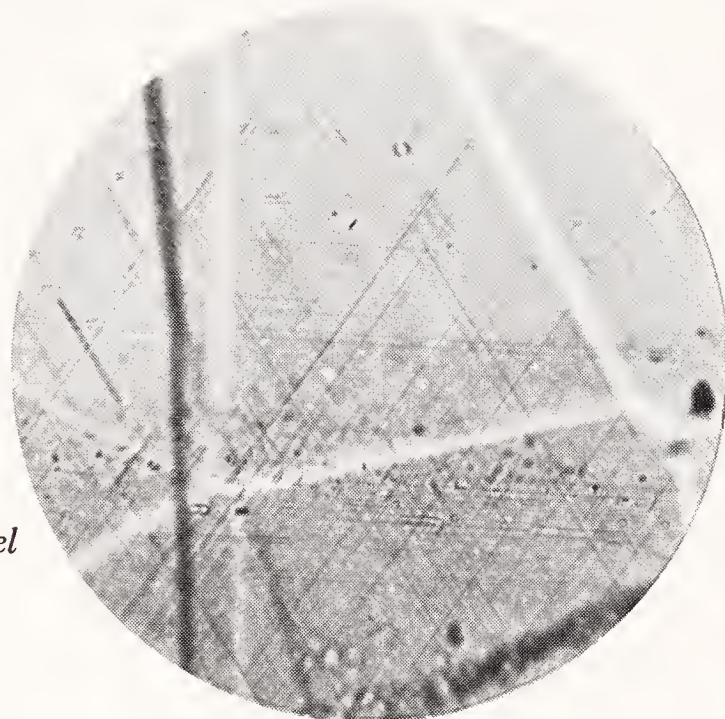

Figure 90
"Silk" in three groups of parallel
needles of 60 degrees.

Photo by E. Gubelin

Inclusions that Characterize Natural Corundum. Natural corundum may be positively distinguished from the synthetic equivalent by its inclusions. However, some inclusions in flux grown synthetics have a deceptively natural look. Natural corundum has angular inclusions, in contrast to the spherical bubbles found in the flame-fusion synthetic. Characteristic of the genuine stone is the prevalence of silk. Silk is a loosely defined term applied in the gem trade to long, thin, needlelike inclusions found in genuine corundum. It is usually formed by the growth of long, thin, rutile crystals, but it may consist of very long, negative crystals (hollow cavities with a crystal shape). Silk is arranged in corundum in three sets of parallel lines at 60° to each other. (See photomicrograph on this page.) The presence of coarse silk (visible under 30x magnification) is indisputable evidence of the natural origin of corundum; however, natural corundum sometimes contains no needlelike inclusions. Synthetic star corundum also contains silk, but the individual needlelike inclusions are tiny both in length and cross-section, at least 50 magnifications being required to resolve them.

Other characteristic inclusions of natural corundum are tiny crystals of zircon that stand out in bold relief, because of the great difference in refractive index between corundum and zircon. The zircon usually appears as a point of bright light, surrounded

HANDBOOK OF GEM IDENTIFICATION



← *Figure 91*
Zircon inclusions surrounded by a "halo" of tiny black fractures in sapphire.

Photo by E. Gubelin



Figure 92 →
Rounded corundum grains included in sapphire.

Photo by E. Gubelin

by a "halo" of tiny black fractures. (See illustration.) Small octahedral crystals (eight-sided solids resembling two pyramids base to base) of spinel are included in corundum, but small included crystals and rounded grains of corundum are more common. (See photomicrograph.) Because inclusions of corundum

Synthetic Gemstones

have the same index as that of the parent material, they exhibit almost no relief.

Planes of liquid inclusions that have an angular pattern are also common in genuine material. The fairly regular patterns of liquid inclusions in ruby and sapphire have an appearance best likened to “fingerprints.” (See illustration.) Angular crystal and liquid inclusions are characteristic of material of a natural origin.

2. *Growth Lines.* The classification of growth lines is a reliable means of establishing the synthetic or natural origin of corundum.

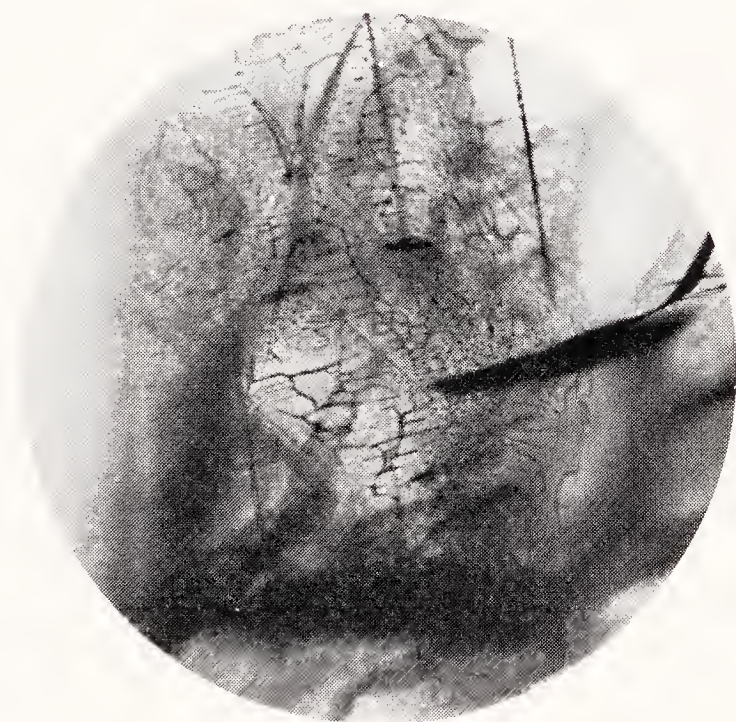

Figure 93
“Fingerprint” patterns of
liquid inclusions in natural
sapphire

Photo by E. Gubelin

Synthetic Corundum* is characterized by the presence of curved growth lines, or striae. As the synthetic boule is formed, the molten alumina flows outward from the center of the boule top. It is believed that a slight distortion of the crystal lattice of the doubly refractive material is the cause of the striae. The striae are visible when the finished gem is viewed perpendicular to the long axis of the original boule. They are most easily seen when the light source is reduced to pinpoint size, with the gem placed

*Flame Fusion

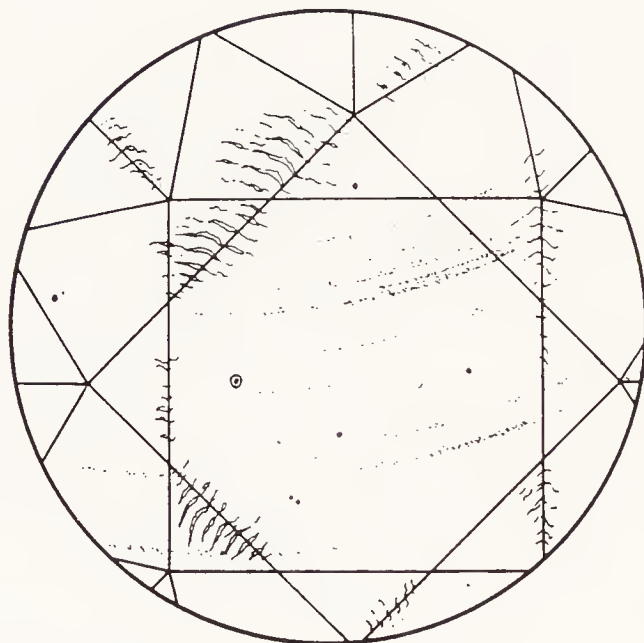

Figure 94

Typical cracks at facet edges, caused by rapid polishing; with spherical bubbles and curved striae in synthetic corundum.

between it and the objective of the microscope. (See illustration of striae.) Color zones with the same curvature are also commonly encountered in the older synthetic corundum. As in transparent synthetic corundum, curved striae serve to distinguish the synthetic from natural star corundum. The artificial gem material does not always exhibit curved striae, but the gemologist should develop a technique for magnification that will resolve curved striae whenever possible. The production of synthetic corundum free of inclusions is increasing; hence, it is becoming more important to detect striae with optimum efficiency.

Another method of detecting striae or color banding is to immerse the stone, preferably in methylene iodide or bromoform (or another liquid in its index range). If a clear-bottomed cell is used, a sheet of white paper inserted beneath the cell to a point half-way across the light opening often brings out hard-to-see striae. Immersion in an opal-glass or milky-polyethylene cell may also be helpful. Curved striae are usually obvious in synthetic alexandritelike sapphire; easily detected in synthetic ruby; color banding is usually to be seen in synthetic blue sapphire. Striae are detectable (if at all) only with diffi-

Synthetic Gemstones

culty in orange and green varieties; and rarely, if ever, seen in colorless synthetics.

Natural corundum exhibits color zoning, inclusions arranged parallel to straight growth planes, and striae due to repeated twinning. Both color zones and inclusions parallel straight growth planes and intersect at angles of 60° , but the striae resulting from repeated twinning continue as straight lines entirely across the cut gem. A second set of twinning striae may occur at right angles to the first. Synthetic corundum also may show straight twinning planes. However, they are rather rarely encountered. Corundum often has irregular color distribution, with one growth layer strongly colored and the next almost colorless. This effect is rarely apparent, unless the gem is observed parallel to the long axis of the original crystal (parallel to the planes growth lines). Although the zoning or the striae of natural corundum is usually more distinct than that of its synthetic counterpart, it is often necessary to subject natural corundum to the same careful scrutiny before arriving at a definite decision as to its identity.

Burma rubies often show an irregular color distribution that seemingly bears no relation to the growth of the crystal. This patchy color distribution is characteristic of Burma ruby.

Absorption Spectra. There are a few colors for which spectroscopy furnishes reliable means of distinguishing between natural and synthetic corundum. The presence of iron in natural green, blue and yellow sapphire is made evident by absorption in the blue region of the spectrum. Green sapphire shows general absorption from about 4500\AA to over 4600 , with a separate band near 4700 . In yellow and blue sapphires the absorption varies with locality, from that described for green to three distinct lines near 4500 , 4600 and 4700\AA ; or, sometimes, only a single vague band near 4500\AA may be seen. Australian, Thai and Montana stones contain enough iron to show usually the three zones of absorption, whereas stones from Ceylon, low in iron, show only a weak band at 4500\AA or none at all. Fortunately, natural yellows from Ceylon fluoresce, in contrast to synthetic yellow sapphire.

HANDBOOK OF GEM IDENTIFICATION

Orangy-yellow synthetics may show a fluorescent chromium line in the red.

Fluorescence. Differences in reaction to ultraviolet radiation make it possible to distinguish some corundum varieties from synthetic counterparts, but the differences are usually so small that tests should be carried out in a completely dark room on a dull-black surface with knowns for comparison.

Both natural stones from Burma and Ceylon and flame-fusion synthetic rubies fluoresce strongly under long- and short-wave ultraviolet, but the synthetic is perceptibly brighter when natural and synthetic are examined under short wave side by side. Flux-fusion synthetic rubies react more like the natural material than like flame-fusion synthetic rubies, but do tend to fluoresce somewhat more strongly and the Kashan synthetic ruby seems to have a whitish surface glow somewhat akin to the appearance of synthetic blue sapphires under short-wave ultraviolet. All synthetics and naturals glow under X-rays, but most synthetics phosphoresce whereas natural rubies do not. Siam rubies and garnet-red synthetics show little or no fluorescence under ultraviolet, but the synthetics usually show more than a Siam, or Thai, ruby.

Under short-wave ultraviolet, synthetic blue sapphires usually show a yellowish fluorescence that appears to smudge the surface, but it is very easy to overlook. The natural is inert. In a group of synthetics there is a wide variation in the strength of the reaction.

Synthetic yellow sapphires are either inert to both long- and short-wave ultraviolet or they fluoresce weakly. With the exception of those from Ceylon natural yellow stones are inert. Some synthetic yellow sapphires — particularly deeper-colored orangy-yellow synthetics — show a reddish fluorescence under long wave especially, but sometimes under short wave as well. Natural yellow sapphires from Ceylon show a beautiful orangy-yellow color under long-wave ultraviolet that is usually referred to as apricot.

Some synthetic colorless sapphire has a faint pale-blue glow under short-wave ultraviolet. Some synthetic colorless material is inert.

The Plato Method. An effective method for the detection of synthetic corundum without flaw and without detectable curved

Synthetic Gemstones



Figure 95

The identifying Plato lines seen under crossed Polaroids in synthetic corundum parallel to the optic axis

striae is one developed by a German professor, W. Plato¹. The optic-axis direction is first located by use of the polariscope, and then the unknown is examined between crossed Polaroids under about 20-30x while immersed in methylene iodide. When a synthetic corundum is examined parallel to the optic-axis direction under these conditions, two sets of lines at 60° to one another resembling repeated twinning lines identify it. The natural material shows no similar effect. Thus, this provides an excellent means of distinguishing flawless synthetic corundum without visible striae from flawless natural stones. (See illustration.) It has been reported that a similar effect has been seen in natural rubies from Tanzania. We have yet to encounter this effect in anything other than a synthetic corundum.

Inconclusive Evidence of the Synthetic or Natural Origin of Corundum

There are many other characteristics that could not be consid-

1. Plato, Dr. W., *Gems & Gemology*, Fall, 1952.

HANDBOOK OF GEM IDENTIFICATION

ered definite proof, but are indications of origin.

1. Because synthetic corundum has a negligible intrinsic value, little care goes into its fashioning. The heat generated by polishing synthetics too rapidly frequently causes cracks to appear at facet junctions. (See drawing.) Polishing or wheel marks on the surface of the facets are commonly seen in the synthetic. Cracks along the facet junctions and other evidence of poor polishing can be considered an indication of synthetic origin, except in calibre sizes.

2. Splitting the boule lengthwise to ease internal strain produces rough from which large gems are most advantageously cut when the table of the gem is placed parallel to the length of the boule. In this position, the optic axis is more or less parallel to the table, a condition which allows dichroism to be observed through the table. Natural rough, on the other hand, yields the most attractive color, and often the greatest weight retention when the table is perpendicular to the optic axis. Thus, in most cases, no dichroism can be seen through the table of a natural stone.

3. Corundum cut with the scissors style of facet arrangement is almost always synthetic.

4. Early synthetic star corundum exhibited a transparency unknown in the natural star when viewed from the side perpendicular to the long axis of the cabochon-cut gemstone. Most synthetic stars produced after the first year of manufacture are nearly opaque and are marked by stars so pronounced that they are visible even under diffused-light sources.

5. If corundum remains equally light in all positions upon rotation in the dark position of the polariscope or polarizing microscope, natural corundum is suggested, since such an effect is caused by repeated twinning. Repeated twinning of this type is rare in the synthetic.

These five indications should *never* be considered proof of natural or artificial origin.

Hydrothermal and Flux-Fusion Synthetic Corundum. In 1957 Bell Laboratories announced success in overgrowing synthetic

Synthetic Gemstones

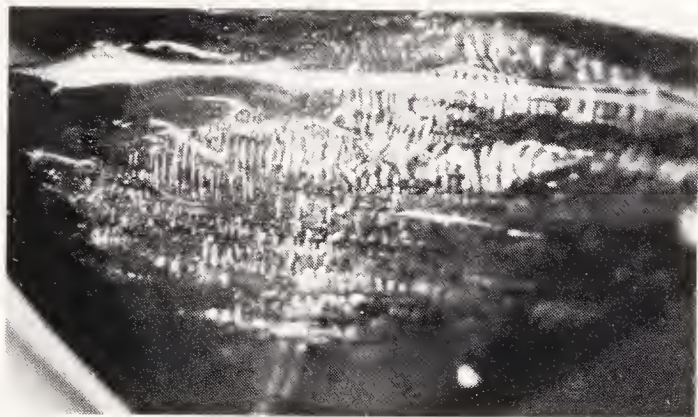

Figure 96
Typical flux inclusions
in a Kashan ruby.

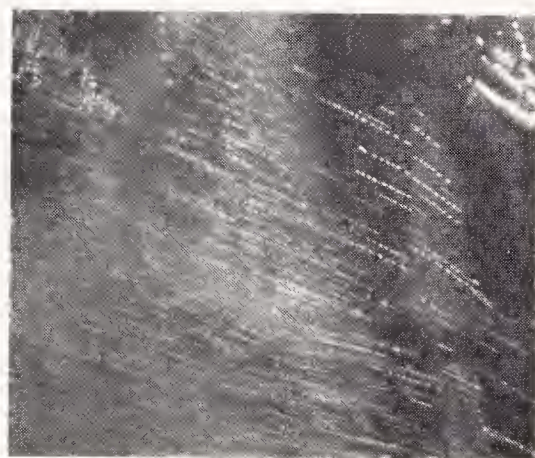

Figure 96 a
"Raindrop" inclusions
in a Kashan synthetic ruby.

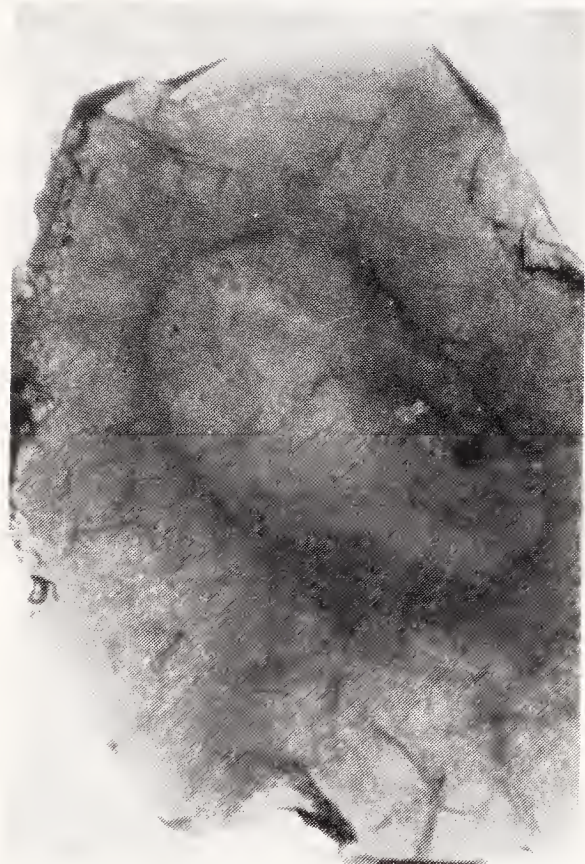

Figure 97
Flux-grown synthetic ruby
grown on a natural seed.

ruby on prepared wafers of synthetic corundum by a hydrothermal process. In 1960, Carroll Chatham announced success in the production of synthetic ruby by a process similar to that used in his production of synthetic emerald. General Electric has announced the growth of thick, tabular synthetic ruby crystals from solution in molten lead fluoride. In mid-1965, these materials were not on the market nor available for study — and none has been announced as being introduced to the gem market. In spite of this, the Gem Trade Laboratories have encountered such material in parcels of natural rubies. The most recent showed an unmistakable characteristic of the flux-fusion, or flux-melt type — wisplike inclusions. These were found in a parcel of oriental rubies. (See illustrations.)



Figure A

Photograph of synthetic and natural rubies under short-wave ultraviolet. The top three rows are Kashan flux-fusion rubies. The two large white rings are set with Kashan's. Lower center is a Chatham, bottom center is a Verneuil synthetic to the left, with a natural ruby, and bottom left and right are natural rubies.

The Kashan flux-fusion synthetic rubies announced in 1968 are described more fully in the next paragraph.

Recognizing Flux-Fusion Synthetic Corundum. There are usually inclusions in flux synthetic rubies that resemble those of synthetic emeralds made by the same method, but there is more variety in the new product. Unlike the Chatham, in which a large natural seed is seen, the Kashan faceted product shows no seed.

The inclusions are mostly fairly coarse tubes of the flux. Although they are unlike the common inclusions in either flame-fusion synthetics or natural rubies, they have a natural appearance at first glance. Rarely, a single silklike line may be seen, but most of the inclusions are much coarser and may be regarded as quite characteristic of the flux-fusion product. (See illustrations in Chapter VIII.)

The R.I.'s and S.G. are identical to the natural. The only detectable difference is a whitish quality to their bright-red fluorescence under ultraviolet, and a slight difference in the transmission of short-wave ultraviolet (*Figure A*).

Synthetic Gemstones

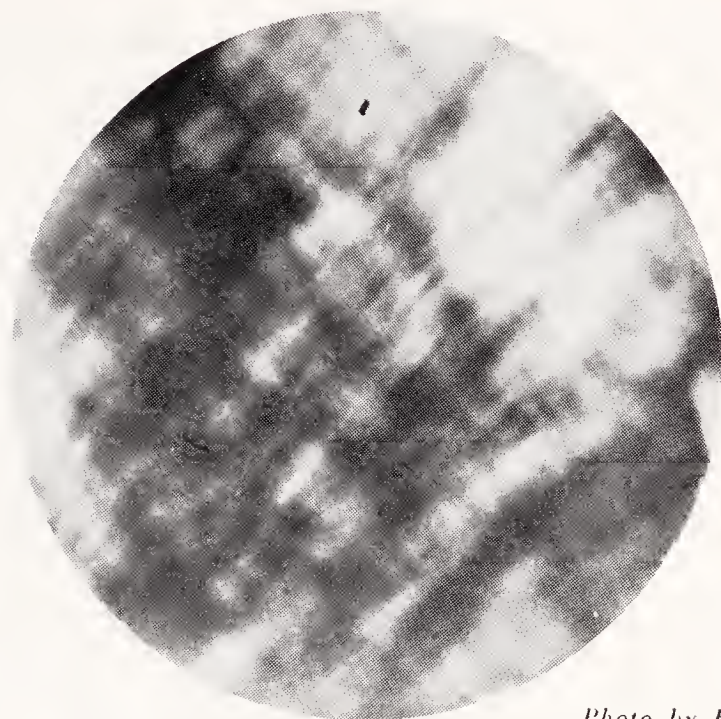

Photo by E. Gabelin

Figure 98

"Cross-hatched" appearance caused by anomalous double refraction in synthetic spinel 20X, under crossed Polaroids.

Synthetic Spinel

The chemical composition of both natural and synthetic spinel is magnesium aluminum oxide. There is a difference between synthetic spinel and the other synthetic gems, in that the basic formula of the natural mineral is not adhered to closely in its synthesis. In natural spinel, the ratio of magnesium oxide to aluminum oxide is one to one. This is not true of the synthetic, which is usually made at 3.5-to-1 ratio of alumina to magnesia. This ratio was determined largely by trial and error after the first spinel boules were formed accidentally when magnesium was added to the alumina in an effort to obtain an even distribution of the coloring agent to make more realistic synthetic blue sapphires. It was found that boules formed best at about the 3.5-to-1 ratio. The excess of alumina accounts for the slightly higher refractive index (about .01 higher than the usual 1.718 of the natural) and specific gravity of the synthetic. The specific gravity of the synthetic is about 3.64, compared to about 3.60 for natural spinel. The excess of alumina also accounts for the always-evident strong anomalous double refraction in synthetic spinel. The differ-

ent patterns in the crossed Polaroid position, as seen in the polariscope under about 5x, are characteristic. Typical patterns are shown under 20x in the illustrations.

Most of the production of synthetic spinel is in boules of transparent material. However, it is made in other forms as well. One is made by heating magnesium and aluminum oxides, plus a liberal amount of the cobalt-oxide coloring agent, to a temperature slightly below spinel's melting point. The result is a coarsely crystalline sintered product resembling fine lapis-lazuli. It has a rich, violetish-blue color. In a remarkable reversal, real gold may be added to imitate the pyrite ("fool's gold") of the natural lapis-lazuli. The refractive index and hardness of synthetic spinel make it easy to identify. Specific gravity is lower than that of the transparent material at 3.52.

A second form is made by reheating colorless material long enough for some of the alumina to separate, probably in the form of small corundum crystals. This imparts a cloudiness that gives rise to a realistic adularescent effect, making an excellent moonstone imitation.

In practice, synthetic spinel is much more likely to be confused with other gemstones in appearance than with natural spinel, for it is made in colors not encountered in the natural. Its rich, deep-blue color is a better imitation of fine sapphire than of blue spinel; in light blue and greenish blue it imitates aquamarine and zircon, respectively; and in light and dark green, peridot and tourmaline, respectively. By ordinary Verneuil methods, it was not made in red, except for very light tones resembling pink topaz or kunzite. However, about 1960, red synthetic-spinel calibre began to appear; this is Verneuil material. These small red stones have a refractive index of 1.725 and a specific gravity of 3.60. On one occasion, a large manmade red-spinel crystal grown on a platinum plate was examined in the Gemological Institute Laboratory in New York City; it varied from about 1.73 to over 1.75 in index.

Synthetic Gemstones



Figure 99
Thready or tubular inclusions
in synthetic spinel

Conclusive Identification of Synthetic and Natural Spinel

Proof of synthetic origin is found in the presence of spherical gas bubbles. Gas-filled spheres in synthetic spinel are usually smaller and much less numerous than in synthetic corundum. Curved striae are not found in synthetic spinel, except in the newly reported red varieties, but curved color bands may be seen rarely. Another type of inclusion characteristic of synthetic spinel is a “bread crumb” inclusion. Under dark-field illumination this type of inclusion appears as a bright porous spot that seems to have been caused by the coalescence of several small bubbles in close proximity. Short, irregular, wormlike gas inclusions and faint wispy clouds are both characteristic.

The presence of very strong anomalous double refraction is invariable in synthetic spinel. Its appearance in the polariscope, when the instrument is in its dark position, has been called “cross-hatched,” i.e., alternately dark and light patches form a lattice-work pattern under 5x to 10x. (See photomicrographs for more highly magnified examples.) Natural spinel is rarely strained, and when it is, it does not show the lattice pattern. Strain double

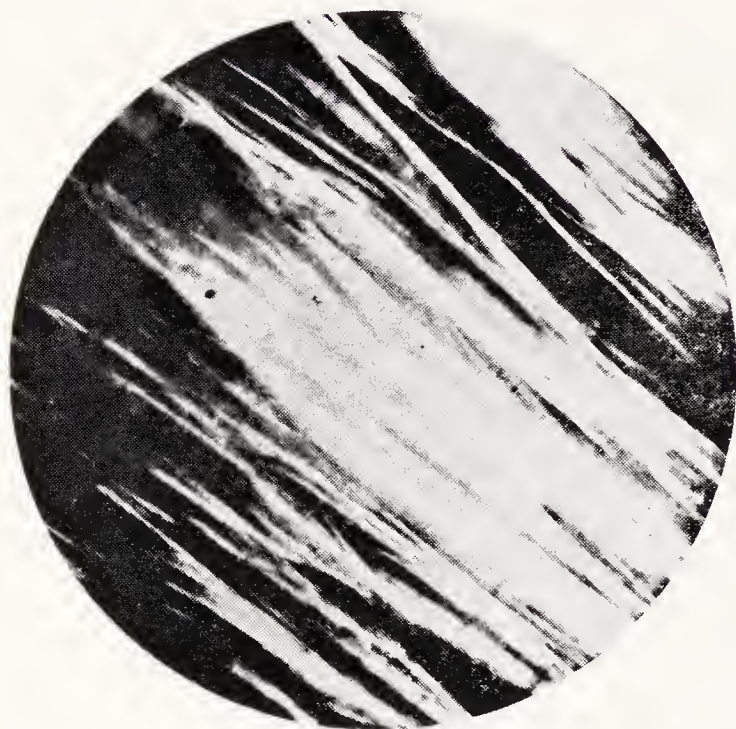

Photo by E. Gubelin

Figure 100

Tourmaline-colored synthetic spinel with "fibrous" anomalous double refraction. 20X under crossed Polaroids.

refraction in a natural spinel when visible in the polariscope is usually localized around an inclusion or group of inclusions.

Synthetic spinel is often flawless. A combination of the high 1.73 refractive index and the cross-hatched appearance in the polariscope constitutes proof of synthesis. An index of less than 1.72 and no more than weak strain double refraction is typical of natural spinel.

The spectrum of synthetic blue spinel differs materially from the natural, as shown in the table of absorption spectra. This provides a sure means of distinguishing the synthetic from the natural.

Colorless synthetic spinel, a variety unknown in the natural, is a commonly used diamond imitation. It is readily distinguished from diamond by its 1.73 refractive index and very low relief when immersed in methylene iodide. Even in water, its relief is very low, compared to that of diamond. It fluoresces a bright greenish white under short-wave ultraviolet.

Both the moonstone and lapis-lazuli imitations are easily distinguished from their natural counterparts by the higher index and specific gravity of synthetic spinel.

Synthetic Gemstones

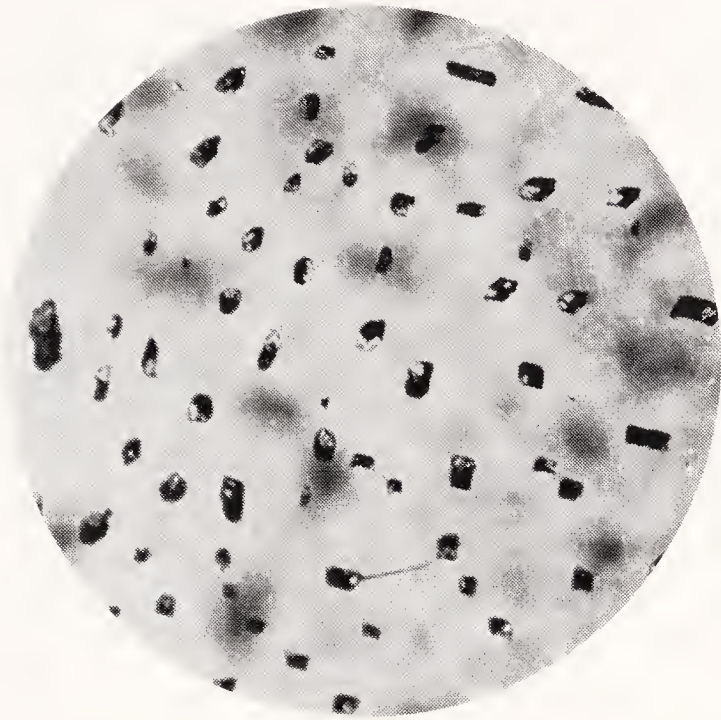

Figure 101
Numerous octahedral spinel
crystals, which typify
natural spinel.

Photo by E. Gubelin

Spinel can be proved to have a natural origin by the presence of angular inclusions in the total absence of spherical gas bubbles. Synthetics may have angular inclusions (the bread-crumbs type or the wormlike, gas-filled inclusions mentioned earlier) but when these are present, spherical gas bubbles are virtually certain to be present as well. The common inclusions in natural spinel are small octahedra of spinel, which may be scattered throughout the stone or arranged in groups resembling the fingerprint inclusions in corundum.

Indications Suggesting Synthetic or Natural Spinel

1. Signs of rapid polishing, such as striations on facets left by the lap and irregular cracks along facet edges, indicate synthetic material. Careful fashioning suggests natural spinel.
2. Dark-blue synthetic spinel exhibits flashes of red as the stone is turned.
3. The color of synthetic spinel seldom bears any close resemblance to the colors found in natural spinel, since the natural gem is usually darker in color.

Figure 102
Slightly angular gas bubbles
in synthetic spinel.



Photo by E. Gubelin

4. In many cases, ultraviolet radiation will actuate in synthetic spinel a fluorescence of a color never observed in similar colors of natural spinel. This is especially true of blue or green synthetic spinel that shows very strong red fluorescence under ultraviolet radiation, while blue or green natural spinel rarely exhibits such fluorescence.

Indications alone are insufficient to make an identification. No identification of synthetic or natural spinel should be made, unless based on observation of characteristic inclusions or a cross-hatched appearance in the dark position of a polariscope.

Synthetic Emerald

Beryl had been synthesized in the laboratory several times by earlier scientists, but the first commercial synthetic-emerald production was accomplished by Carroll Chatham about 1940. I.G. Farben announced success in the synthesis of emerald in 1935, about the time Chatham claims to have produced his first crystals, but the German material was not marketed. Chatham's process, about which he maintains utmost secrecy, is obviously a flux-fusion process, not a Verneuil type. Chatham's synthetic emeralds resemble natural

Synthetic Gemstones



Figure 103
Wisp-like pattern of flux in-
clusions in synthetic emerald
under 15X.



Figure 104
Synthetic emerald inclusions
under 63X.

Photos by G.I.A.

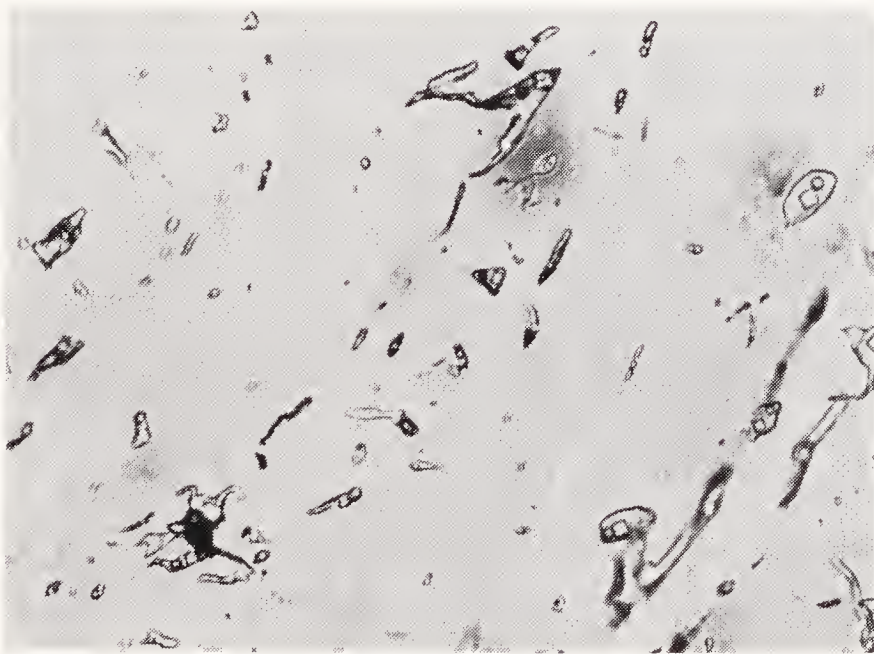

Figure 105
Tiny tabular square crystals in Colombian Emerald.

stones in that they have irregular solid flux inclusions, plus other angular inclusions such as colorless crystals, probably of phenakite, another beryllium silicate. This suggests the use of platinum as the liner of the autoclaves or other growth vessels. Although the early product was very limited in size, large crystals of over 1000 carats

have been grown, and transparent faceted stones of over five carats are available. Chatham synthetic emeralds have a distinctly bluish-green color not common in the natural emerald.

In 1961, the synthetic emerald-coated prefaceted natural beryl, made by Johann Lechleitner of Austria, was introduced by the Linde Company as "Linde Synthetic Emerald." More recently the Lechleitner product has been marketed by Sturmlechner of Vienna. Since the overgrowth is thin and the natural core colorless or nearly so, the coating is easily detected, although the properties of the overgrowth approximate average natural emerald figures, in contrast to the Chatham product.

The Linde process for enhancing color in natural sapphires is being used particularly in Bangkok to heat sapphires close to the melting point while embedded in powdered oxides. At high enough temperature, some of the material migrates into the structure and occupies the site that give rise to color in sapphires. In 1965 the Linde Company, who also had produced synthetic star ruby and sapphire, introduced a hydro-thermal synthetic emerald. The product was not successful commercially and later Linde sold its rights to its various patents to other companies. The synthetic emerald product is now produced by Regency Emeralds. The present product has properties close to those of natural emeralds. The early product was excessively fluorescent, but the recent synthetic emeralds are less so, an indication of their similarity to the Chatham synthetic in this property. They have refractive indices near 1.571-1.577 or 1.578, with an S.G. of about 2.685. Minute two-phase inclusions give a cottony appearance especially near the seed—new growth interface, and roughly conical spaces extend from small phenakite crystal inclusions. The numerous tiny two-phase inclusions are arranged in parallel lines. (See illustrations.) At right angles, a layered effect is visible with concentrations of color highlighting growth stages from the seed plate outward.

The arrangement and nature of inclusions differ markedly from flux-melt products.

The Gilson flux-melt synthetic emerald came much later than the Chatham, but today it is seen in a wider variety of properties. Early types were closely comparable to the Chatham, but of poorer quality.

Synthetic Gemstones

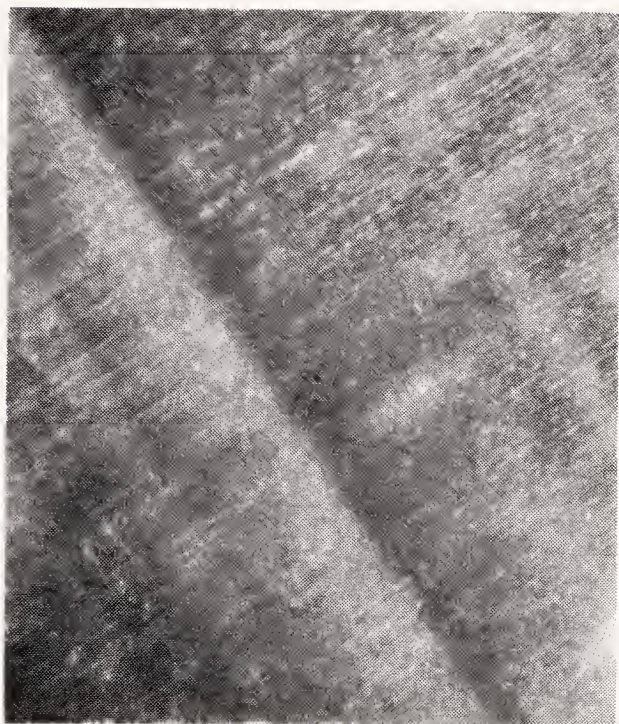

Figure 106

Minute two-phase inclusions in Linde hydrothermal emerald giving a cottony appearance, especially near the seed

Photo by G.I.A.

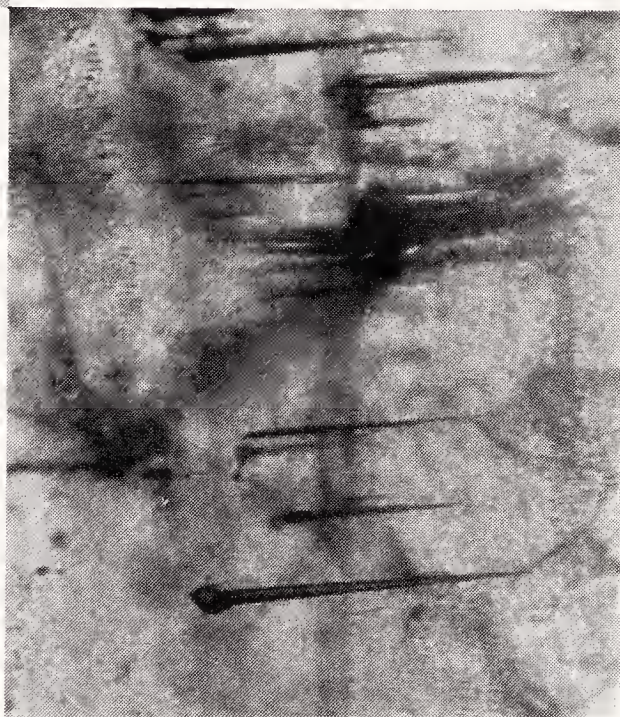

Figure 107

Roughly conical spaces extending from small phenakite-crystal inclusions in hydrothermal emerald

Recently, they have been very similar to fine natural emerald in appearance. The major testing differences between them and Chatham's was a marked tendency to an orangy fluorescence under long-wave ultraviolet. At one point, Gilson introduced a new line—still a small fraction of his output, and reportedly discontinued—that has properties well into the natural range. The refractive indices are 1.571-1.579, the S.G. about 2.685, with no long-wave ultraviolet fluorescence. This is accomplished by adding iron oxide, which results in an absorption line at 4270 \AA . This line is absent in natural emerald.

How to Distinguish Synthetic from Natural Emeralds. Most flux-melt synthetic emeralds are readily distinguished from natural stones. Despite the presence of natural-appearing inclusions, distinct differences in physical properties and other characteristics simplify the testing problems. The refractive indices of the flux-melt product are 1.561-1.564 or 1.565, close to .01 below the lowest figure encountered in natural Colombian emerald. The specific gravity is only about 2.65 to 2.66, in contrast to the approximate 2.71 of natural Colombian material and the higher figures for other sources. A heavy liquid adjusted to the density of 2.67 serves to separate the flux-melt synthetic from the natural, although a rare, heavily flawed natural stone may float with the synthetics, or a flux-melt synthetic with an unusual number or size of platinum crystals may sink. Remember that some Gilsos have higher properties.

Synthetic emeralds fluoresce dull red under ultra-violet. The long-wave (3660Å) radiation is recommended. The fluorescence could best be described as weak to distinct in some cases, so it is important to make the test in a dark room, with the stone placed on a dull-black background. Very rarely, intense-green natural emeralds exhibit a weak fluorescence, but it is a purplish red and does not seem to remove the stone's transparency, as does the fluorescent effect in flux-melt synthetics. For a time, Gilson made a synthetic emerald to which he added enough iron to quench the fluorescence. This raised the R.I. to 1.571 to 1.579. It did not change the characteristic wisplike inclusions and added a telltale 4270 Å absorption line in the spectrum.

Another difference between flux-melt synthetic and natural emeralds is in transparency to short-wave ultra-violet. Natural emeralds are opaque to wave lengths below about 3000Å. If a short-wave ultra-violet lamp is placed over a stone covering a hole in an opaque shield, it is possible to determine whether radiation is transmitted or absorbed by the unknown by placing the mineral scheelite below the opening. If the specimen is transparent, the scheelite fluoresces a bright blue; if it absorbs the 2537Å radiation, there is no radiation to fluoresce the scheelite, so it remains dark. Flux-melt syn-

Synthetic Gemstones

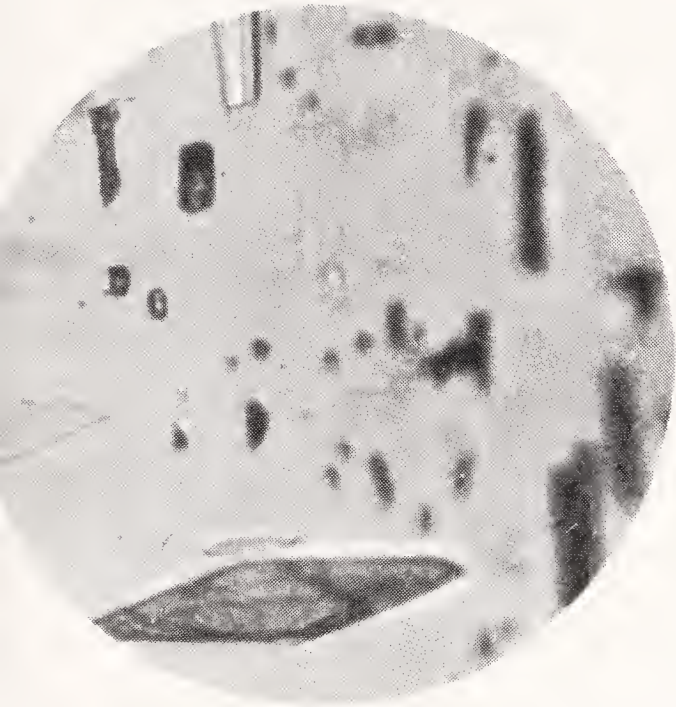

Figure 108

Idiomorphous biotite flakes belong to the inclusion symbiose of Indian emeralds.

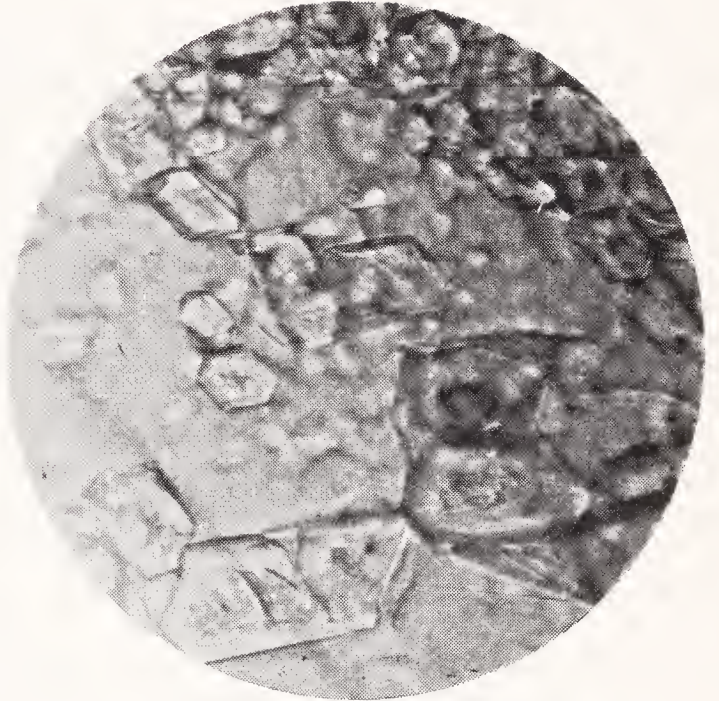

Photo by E. Gubelin

Figure 109

Plane of calcite inclusions in Colombian emerald.

thetics permit the scheelite to fluoresce, but the natural does not. This is best performed in a dark room.

If a doubly refractive emerald-green stone has three-phase inclusions; an index of 1.57 or higher and it sinks in 2.67 liquid; if it fails to fluoresce under long-wave ultra-violet; or if it is opaque to short-wave ultra-violet, it may be assumed to be natural. If it fluoresces under long-wave ultra-violet; is transparent to short wave, has wisp-like inclusions of flux, has an index of 1.561-1.565 and floats in 2.67 liquid, it is one of the flux-melt synthetic emeralds. Any test but fluorescence and specific gravity is conclusive, and these two together may be so regarded.

The Lechleitner Synthetic Emerald is characterized by the fact that the synthetic-emerald overgrowth is not polished on most

facets. so the distinctive growth patterns are to be seen under magnification. If thicker coatings become the rule in the future, facets may be polished, but this product will still be easy to identify. Usually, the thin, intense-green coating is noted under magnification, but, if not, it is obvious when the stone is immersed in water or bromoform. Property values are those of natural emerald. Inclusions are of types expected in other varieties of beryl, except for the thin synthetic layer. Here, the most prominent features are numerous thin, elongated cracks. (See Figures 78 and 79.)

The R.I. and S.G. range of the Linde hydrothermal synthetic is about at the lower limits of natural emerald. However, its inclusions are characteristic and its red fluorescence approaching that of synthetic ruby serve to distinguish it from natural.

Synthetic Garnet. The garnet structure has been synthesized using a number of different elements. Most of those resembling gemstones duplicate the garnet structure, but not composition. Garnet composition is shown by the generalized formula $R_3R_2(SiO_4)_3$, where R represents a metallic ion with a valence of $2+$ and R, a metallic ion with a valence of $3+$. In the so-called synthetic garnets, not only the R ions are replaced, but the Si as well. The interesting YAG (for yttrium-aluminum garnet) has a formula $Y_3Al_5O_{12}$. This is a colorless material with a refractive index of 1.833. The addition of cobalt or other oxides will introduce strong color. Chromium makes the product green (red by transmitted light); manganese makes it red; cobalt, blue (a garnet color unknown in nature); titanium, yellow; and rare-earth elements, other colors. When iron is substituted for aluminum, the product is known to the scientists as YIG, for yttrium-iron garnet. This product is black, but the structural relationship to the garnet family persists.

All of the synthetic garnets we have encountered or have heard about are over the refractometer's 1.81 limit. Colorless YAG is near 4.55 in specific gravity. The greens we have tested had an S.G. of 4.55 to 4.57. Some of the inclusions tend to be reminiscent of the threadlike inclusions sometimes seen in synthetic spinel. In addi-

Synthetic Gemstones

tion, there are other irregular inclusions that suggest natural origin. Fortunately, small rounded inclusions with high relief, apparently gas bubbles, are common.

Synthetic Rutile. Titanium oxide in the tetragonal structure of the mineral rutile has been produced since 1947 in boule form using the Verneuil process by the Titanium Division of the National Lead Co. In nature, rutile is opaque or nearly so, but the synthetic is made in a transparent form in very light yellow, light and dark blue, golden brown, brownish-red and green colors. For jewelry purposes, the nearly colorless light-yellow variety is by far the most commonly used.

The properties of rutile are unusual; its enormous dispersion and birefringence, together with its high refractivity, make for a spectacular appearance. The fire is unparalleled, but despite its higher indices, it is less brilliant than the singly refractive, highly transparent diamond. The refractive indices of synthetic rutile are 2.616-2.903, giving a birefringence of .287. Dispersion is approximately .330, B to G, compared to diamond's .044. The specific gravity is 4.26 and hardness about 6-6½. Synthetic rutile in the light-yellow or blue color cuts off the lower end of the visible spectrum from about 4300 to 4000 Å, the limit of the visible spectrum.

Synthetic rutile is easily recognized by its tremendous fire and birefringence, its hazy transparency, and slightly yellowish color. Under magnification, the great doubling is apparent and spherical gas bubbles are often seen. This material has been sold under many names, such as "Titania," "Miridis," "Kenya Gem," "Titangem" and many others.

Strontium Titanate ("Fabulite"). Another Verneuil-process product, an oxide of strontium and titanium, is unique among synthetic gem materials, in that there is no natural counterpart. Sold under the trademarked name "Fabulite," it is perhaps the best imitation of diamond in appearance. It is singly refractive, has a refractive index of 2.409 and is transparent and colorless. Except for a much higher dispersion, the resemblance to diamond is close. However, hardness is only about 5-6. Specific gravity

is 5.13. The high dispersion distinguishes it from diamond. Spherical gas bubbles are usually evident. Scratches caused by larger grains of abrasive are almost never entirely removed and odd rounded indentations and ridges are common.

Synthetic Diamond. The synthesis of diamond, first authenticated by General Electric in 1955, has since been duplicated in many other laboratories. General Electric is producing several million carats of synthetic-diamond grit annually and DeBeers is also in production. In 1970 General Electric announced crystals up to over a carat in weight in cuttable qualities, but the cost of production exceeded by many times the price of comparable natural diamonds. Production of gem-quality synthetic diamonds may be achieved at any time, but commercial production seems at this writing to be some time away.

Synthetic Opal. First announced for introduction in 1972, Pierre Gilson's synthetic opal reached the market in 1974. Between the first announcement and the appearance of material for sale, several problems were encountered and apparently solved. In addition, a very beautiful black was developed. The early product showed a strong tendency to crack, and it had an especially low hardness — approximately $4\frac{1}{2}$.

Working with the early white material, Robert Earnest of GIA noticed that the synthetic material phosphoresced for a much shorter period of time, after the long-wave ultraviolet light source was turned off, than did the natural opals to which he was comparing the synthetics.

To determine whether an opal is natural or synthetic, first check to see if it transmits light. Close the diaphragm of a Gemolite down to just permit the opal to cover it, and remove the dark-field baffle. If light is transmitted, a synthetic may show one of several characteristic patterns, one of which is shown in the illustration. Those black synthetic opals that do not transmit light, when viewed with an overhead light source, show within each patch of color a tiny mosaic pattern unlike anything encountered in natural opal.

There is also a difference in transparency to ultraviolet in specimens checked to date which is evident in photos in which opal is

Synthetic Gemstones

laid on photographic paper. A rim of white appears in the synthetic that is not evident in the natural when exposed to long wave for about 2 seconds. Photographic print paper in the bottom of a container of water with the unknown plus the known synthetic and natural opals, preferably of comparable thickness, are exposed for two or three seconds to long-wave ultraviolet. Synthetic opal tested so far is much more transparent to ultraviolet than natural black opals.

Synthetic Turquoise. In 1972 Pierre Gilson introduced a purported synthetic turquoise. The material has an intense light blue color, comparable to that of fine natural turquoise. There has been some question raised as to whether this is a synthetic turquoise that is actually held together by a binder that is not turquoise. If this is the case, the finished product becomes an imitation rather than a true synthetic.

Early material showed a tendency to crack and for much darker blue patches to appear. No turquoise spectrum was visible. All specimens show a refractive index of about 1.60, and the S.G. varies from about 2.62 for lighter material to about 2.67 for darker colors. Synthetic turquoise does not scratch apatite; its hardness is 5 to 6.

Currently the most effective means of identification, developed by GIA, is the unique appearance of synthetic turquoise under



*Gilson Synthetic Black Opal
Magnification 63X*

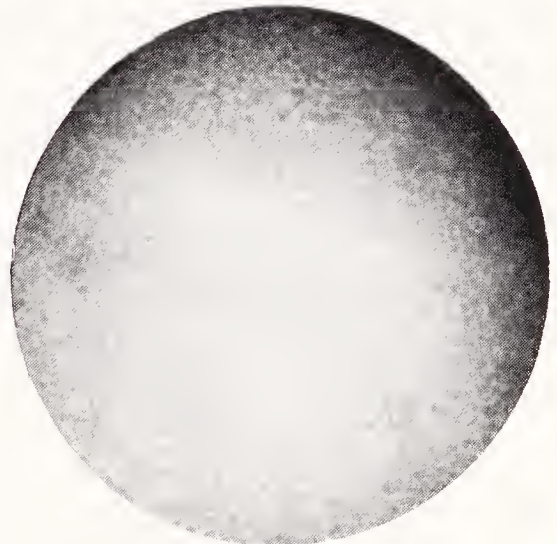

*Gilson Synthetic Turquoise
Magnification 75X*

about 50x. There are a multitude of tiny dark spheres visible in a lighter background. (*See illustration.*)

Synthetic Quartz. Synthetic rock crystal quartz has been made for many years. To our knowledge it has never appeared in the trade, because it is at least as expensive and probably more so than natural rock crystal quartz. Recently, however, the Russians have made synthetic quartz and offered it in the hobby field in blue, green and yellow or brown colors. An American manufacturer has shipped millions of carats of a synthetic citrine to Japan for cutting and this surely will appear within the jewelry industry frequently. It is characterized by rather strong banding parallel to long flat seed plates and by a large number of breadcrumblike inclusions that are most common fairly close to the seed plate. The seed plate is colorless synthetic quartz or synthetic rock crystal. This too has no appreciable cost differential from natural or heat-treated quartz of a citrine color. For that reason, it poses a less serious identification problem than the situation in the case of synthetic vs. natural ruby or synthetic vs. natural emerald where the value of the synthetic is a tiny fraction of that of the natural material.



*Bread crumb inclusions
and two-phase spicules
found in synthetic
quartz.*

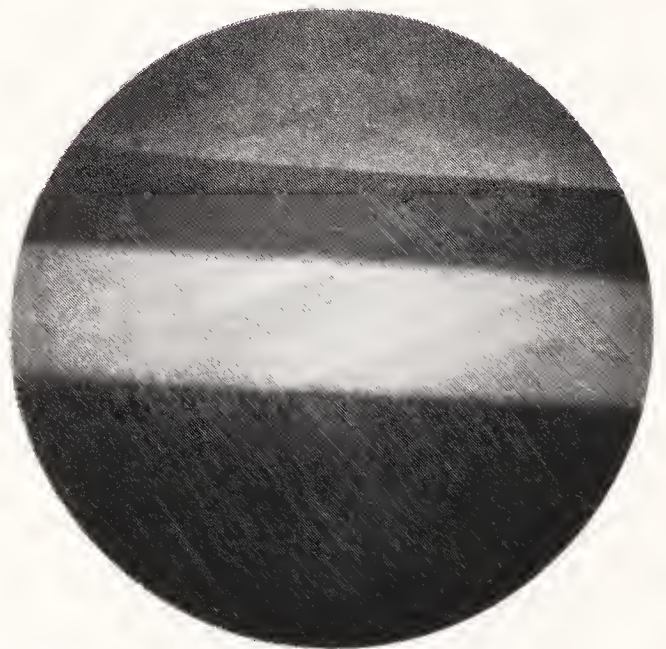

*Seed crystal and
color zoning in
synthetic quartz.*

Synthetic Gemstones

Synthetic Alexandrite. Synthetic chrysoberyl in the form of synthetic alexandrite is made by two manufacturers; Creative Crystals of California and the Kyocera Corporation of Japan. That made by Creative Crystals is a flux-grown type and that made by Kyocera is a pulled synthetic, i.e., it is made by the Czochralski method. Those made by Kyocera show curved growth lines and are very similar in appearance to synthetics made by the flame-fusion process. Those made by Creative Crystals usually show typical flux inclusions, plus very strong growth bands that are visible in dark field illumination. They very often have small triangular or hexagonal platelets. In each case, the color change is more reminiscent of Russian than Sri Lankan alexandrites. The change is from a bluish green to violetish red rather than the yellowish green of the Sri Lankan material. Other properties such as refractive index, specific gravity, and hardness are close to those of natural stones.

“Synthetic” Lapis-lazuli. Pierre Gilson made a material that was supposedly synthetic lapis-lazuli, but the properties are decidedly different from that of lapis. For example, the refractive index is on the order of 1.55. It is attacked badly by hydrochloric acid.

“Synthetic” Coral. Manifestly it is impossible to synthesize coral. Coral could be cultured, but not made synthetically. A material made up largely of calcium carbonate, as is true coral, has been made by Pierre Gilson. It is made in a variety of colors, but of course, does not have the structure of true coral. It appears to be a compacted material.

“Synthetic” Ivory. Gilson also for a time made a material that was called “Synthetic” Ivory. It does not have the structure of elephant ivory and it too was calcareous. We believe that the ivory project was abandoned by Gilson.

Synthetic Cubic Zirconia. In nature zirconium oxide is usually found as the mineral baddeleyite, crystalizing in the monoclinic system. Only as inclusions has it been found in nature in a cubic form. In order to make it, the Russians developed a method that attained exceedingly high temperatures in a skull-shaped container. Through the use of stabilizers, they were able to crystallize zirconia in gem qualities in a cubic form. There is little doubt that of whole materials there is no more realistic imitation than cubic zirconia. It

HANDBOOK OF GEM IDENTIFICATION

has a hardness of $8\frac{1}{2}$, a refractive index between 2.15 and 2.2 (depending on whether it is stabilized with yttrium oxide or calcium oxide. The specific gravity varies between 5.6 and almost 6.0. It is colorless in its pure form and has a dispersion of .060 which is not greatly higher than that of diamond. All in all, it makes a very deceiving imitation. Synthetic cubic zirconia is made in a wide variety of colors.

Chapter XI

Doublets, Triplets, Foil Backs, and Imitations

Assembled Stones

Description. Doublets, triplets and foilbacks are commonly used substitutes for many valuable gems. The term *assembled stones*, used by Robert M. Shipley to include all three, will be used to designate these substitutes.

Doublets are made by joining two pieces of material by a method that adds no color. In a garnet-and-glass doublet, the glass is usually fused to the garnet crown.

Triplets are constructed by joining two pieces of material with a cement that gives the stone its color. (See illustration.)

Foilbacks are made by attaching a mirrorlike back to the stone to enhance a star, or to give either brilliancy or color, or both.

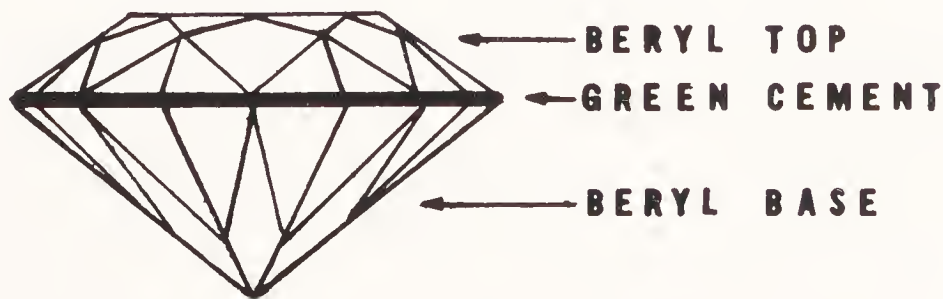

Figure 110

Genuine triplet.

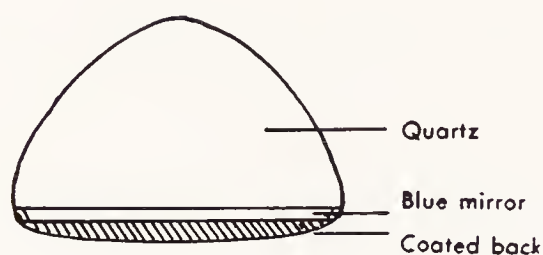

Figure 111

Star quartz foil back.

Types of Assembled Stones commonly Encountered. Since the appearance in the market of synthetic corundum and synthetic spinel, many of the assembled stones formerly used in quantity to represent the more valuable gems are no longer manufactured. Three varieties of assembled stones — the opal doublet, emerald triplet and quartz backed by a mirror to represent star sapphire — are now the most commonly encountered types of assembled stones. Garnet-and-glass doublets in all colors, representing emerald, ruby, sapphire, aquamarine and topaz, once produced in such large numbers, are still commonly seen. The garnet top is almost always almandite, but since the final product takes on the color of the glass back, the color range of this imitation is almost unlimited.

Natural star sapphire with a good star but a gray color may be made into a triplet with a blue cement, or a doublet with a blue sapphire or synthetic sapphire back. There are many other combinations and types of assembled stone. There are a variety of star imitations employing synthetic corundum with either an engraved flat base or with a lined mirror, to give the effect of the rutile inclusions of natural ruby and sapphire. Often, the back is cement or porcelain, but sometimes a second piece of synthetic corundum or, more rarely, low-quality natural corundum is applied to the back. A common type of triplet is made with two pieces of colorless synthetic spinel or quartz joined by cement, permitting good color imitations of amethyst, topaz, emerald, sapphire, ruby and other gemstones. A patent has been applied

Doublets, Triplets, Foil Backs and Imitations

for on a diamond imitation consisting of a “Fabulite” pavilion and a synthetic-sapphire crown. The sapphire serves both to decrease dispersion and to increase durability. Doublets of synthetic sapphire and synthetic rutile have also been made. Jadeite of a translucent white color has been fashioned into three pieces, allowing a gap to be filled with a green jellylike substance. The result is an excellent copy of fine green jadeite. A practice common in the past but rarely seen today, except in old jewelry, was that of mounting pale stones in a completely enclosed setting with a color applied to the pavilion facets to improve the apparent quality greatly. Sapphire and ruby doublets are now being made with natural sapphire tops and synthetic sapphire or ruby bases. When bezel-set they may be difficult to detect.

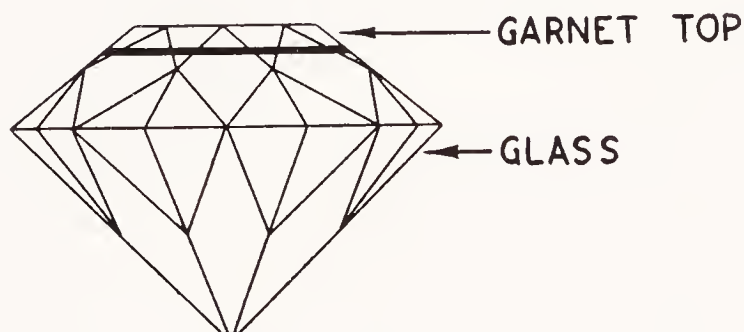

Figure 112
Garnet-and-glass doublet.

Detection of Doublets and Triplets. There are many tests that may be used for the detection of doublets and triplets. Probably the most effective is one that reduces the reflections from the facets, and enables the observer to examine the interior of the gem clearly.

Immersion is the best means of reducing facet reflections. The two pieces of a doublet, the plane or planes of separation between the stone portions, or the colored cement of a triplet are usually evident when the stone is immersed.

The Red-Ring Test is a very simple means of detecting a garnet-and-glass doublet, if the stone is of a color other than red. If the stone is placed table down on a piece of white paper, a red ring close to the girdle, produced by the garnet crown, appears.

HANDBOOK OF GEM IDENTIFICATION

Under careful observation in reflected light, even a novice may notice a distinct difference in luster between the portions of a garnet-and-glass doublet, with garnet revealing much higher luster than glass. In addition, since garnet caps on garnet-and-glass doublets seldom cover the whole crown, a division line is usually evident on the bezel facets. (See illustration.)

Refractive-index readings, taken on the crown of the stone and on a back facet, may reveal a doublet or triplet by a large difference in the readings.

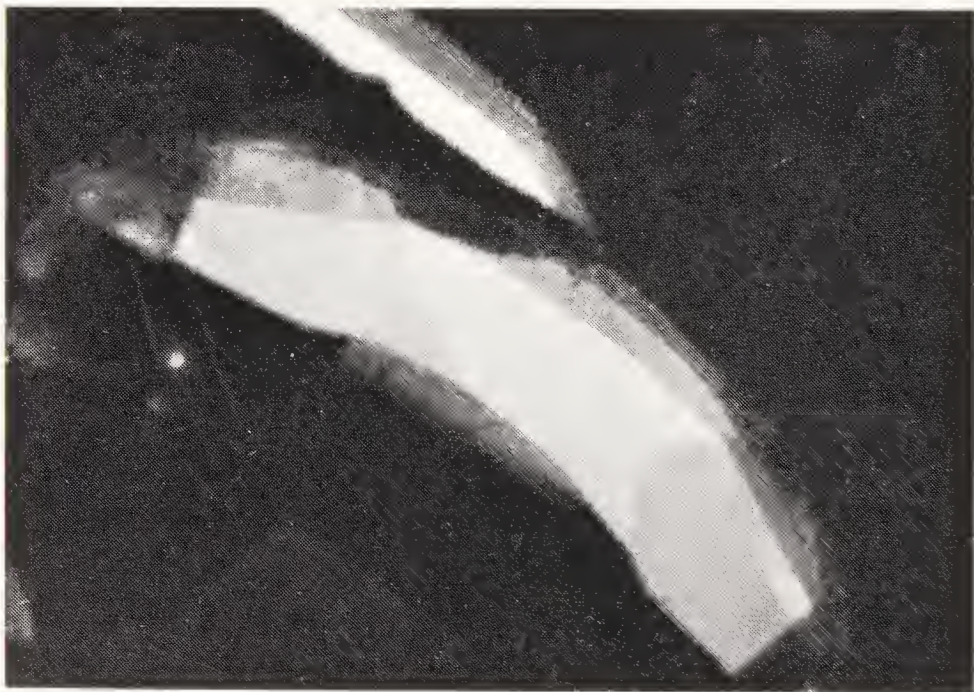

Figure 113
Garnet-and-glass doublet under 30X. Note the sharp luster change on bezel facets.

Fluorescence. When stones are placed under a radiation of 2537\AA , the cement used in the colored layers of triplets often fluoresces very strongly, while the tops and backs do not. Thus the cement layer stands out very clearly, establishing the nature of the assembled stone. The test is also effective for garnet-and-glass doublet detection. Because the glass back of a garnet-and-glass doublet usually fluoresces a greenish yellow and the garnet top fails to fluoresce, the doublet's back surfaces appear to be covered with greenish-yellow powder, while only a dark spot is visible in the position of the garnet crown.

Doublets, Triplets, Foil Backs and Imitations

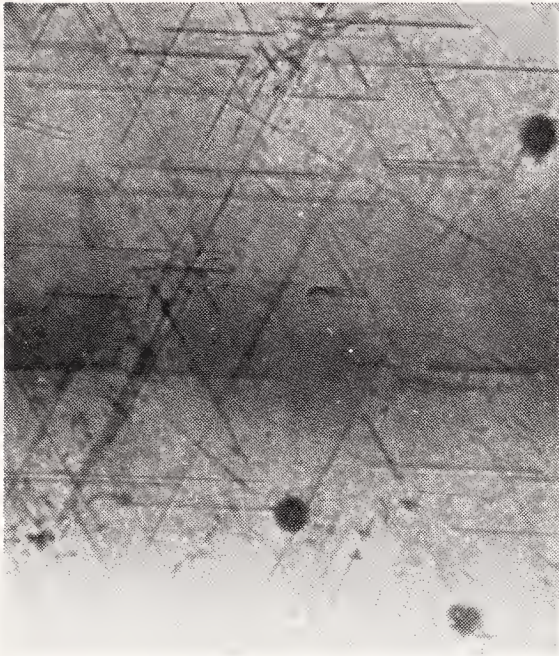

Figure 114

Garnet-and-glass doublet showing both "silk" and spherical gas bubbles.

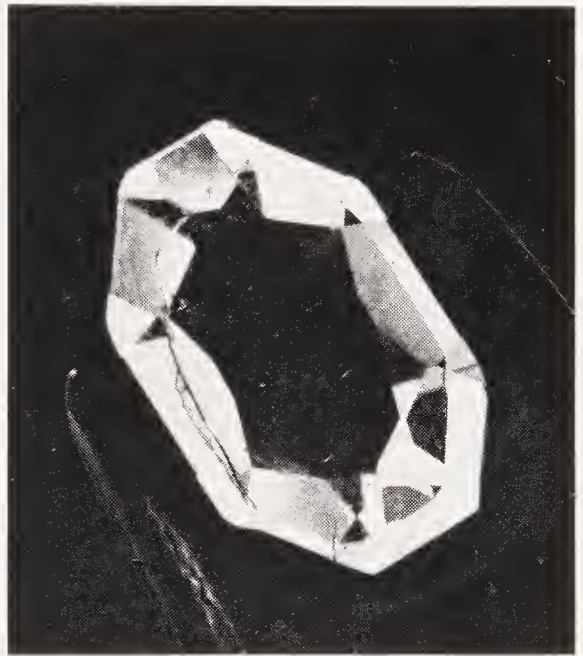

Figure 115

Garnet-and-glass doublet showing the separation plane distinctly.

Magnification may resolve the separation plane of a doublet or triplet. Often simple observation directed parallel to the girdle of the stone shows a difference in color between the two portions.



Triplet in ordinary light.

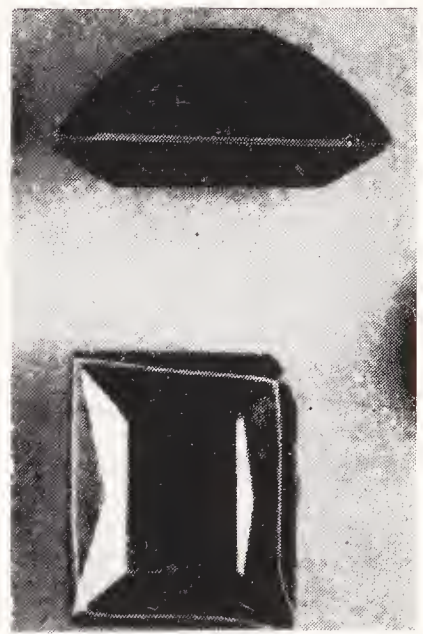

Triplet under 2537 Å radiation.

Detection of Foilbacks. Foilbacks are detected more easily than other imitations. The presence of the foil is difficult to conceal. Faceted gems that have foil covering the back facets are unmistakable. Star quartz is backed by a foil mirror to enhance the star and to lend a color similar to star sapphire or ruby. Most star imitations using mirror backs are apparent immediately from the unnatural appearance of the back. Imitations tend to be much too transparent to have been able to produce a star. The star appears to reflect from the back to a point opposite the light source, in contrast to the seeming appearance of a natural star at the surface. Sometimes rough synthetic or natural corundum is used as a backing, giving the imitation a deceptively natural look. If the stone is mounted, the joining plane may be concealed, adding to the difficulty of detection. In rare instances, it may be necessary to remove such a stone from its mounting to identify it; however, it is usually detected from above.

Color-coated pale rubies, sapphires and emeralds show too little dichroism for their depth of color. They also have weaker spectra than their depth of color suggests. This condition is seldom encountered except on gemstones mounted with their pavilions concealed.

One form of deception that is easily misjudged is that in which what appears to be a large diamond is only a thin crown—without pavilion. The portion below the girdle is entirely concealed by a closed-back gypsy-style mounting. (See Chapter XXIV.)

Imitations. Strictly speaking, an imitation is any substance used as a substitute for a natural gem that fails to duplicate its structure, composition and properties. Synthetic corundum is a synthetic when substituted for natural ruby, but it would be an imitation garnet. Usually, imitation and simulated are used interchangeably and apply principally to glass, plastics, and pearl substitutes in which any type of bead is coated by man.

Glass. Glass imitations vary from molded stones used in the cheapest costume jewelry to types that, through skillful manufacturing methods, very closely imitate the gems they represent.

Doublets, Triplets, Foil Backs and Imitations

The natural gems that glass best imitate are chalcedony quartz, beryl (emerald and aquamarine), jade, turquoise and topaz. It is less effective in imitations of corundum, diamond and zircon.

Glass used in imitation of gemstones is composed of silicon oxide (the composition of quartz) combined principally with an alkali, such as calcium, sodium or potassium, or with lead, boron, thallium, aluminum, or barium oxides, depending upon the properties desired. Imitations vary from silica glass, which is almost entirely silica, to strass glass, which contains less than forty percent silica and more than fifty percent lead oxide. The addition of lead oxide considerably increases the refractive index, specific gravity and fire of the glass.

The range of colors that can be produced in glass is almost unlimited, and the colors achieved often very closely approach the colors of the natural gems the glass represents. Gold chloride is used in glass that most nearly reproduces the color of ruby. Yellow glass is produced by the addition of silver oxide or chloride and antimony. Impure carbon is sometimes added to glass with manganese to produce a golden yellow, while cobalt oxide is used to produce blue. Glass backed by a lined foil is used as an imitation star.

Detection of Glass. The variation in quality of glass used to imitate gemstones is such that some types may be identified at a glance while others may be detected only after a series of careful tests.

A distinctive *vitreous* or *glassy luster* on fracture surfaces is sometimes sufficient proof of a glass imitation of an opaque gemstone. Glass imitations of turquoise and chalcedony are easily detected by the glassy luster of fracture surfaces.

A *feeling of warmth* in the stone as it is held in the hand is an indication of glass. In contrast, a natural or synthetic crystalline material (a better conductor of heat than glass because of its crystal structure) is cool to the touch.

A *molded appearance* of the back facets is easily detected in the cheaper varieties of glass imitations that are polished only on the

crown. Facet junctions in molded glass are not as sharp as they would be in polished materials. The facet surfaces are not flat, but usually have a slight depression at the center. (See illustration, Chapter XVIII.)

Too much fire for the natural gem may be noted in glass imitations of corundum, emerald and topaz, as well as other gems of low dispersion.



Figure 117
Greatly elongated gas bubbles
in molded glass.

Too little dispersion marks a glass imitation of diamond or zircon.

The *action of a drop of water* may distinguish glass. Place a small drop of water on the stone's surface with a toothpick or a match stick. On glass or any amorphous gem material the drop will spread, while on crystalline material the drop will retain its shape. The surface of the stone must be scrupulously clean.

The usual glass imitation has either *spherical bubbles* or *elongated bubbles* similar to those of viscous liquid that is being stirred.

Glass often shows characteristic *flow lines*, so named because they resemble light effects on viscous flowing liquids, such as molasses. These may have been caused by improper mixture of the materials that comprised the glass melt, or by disturbance of

Doublets, Triplets, Foil Backs and Imitations

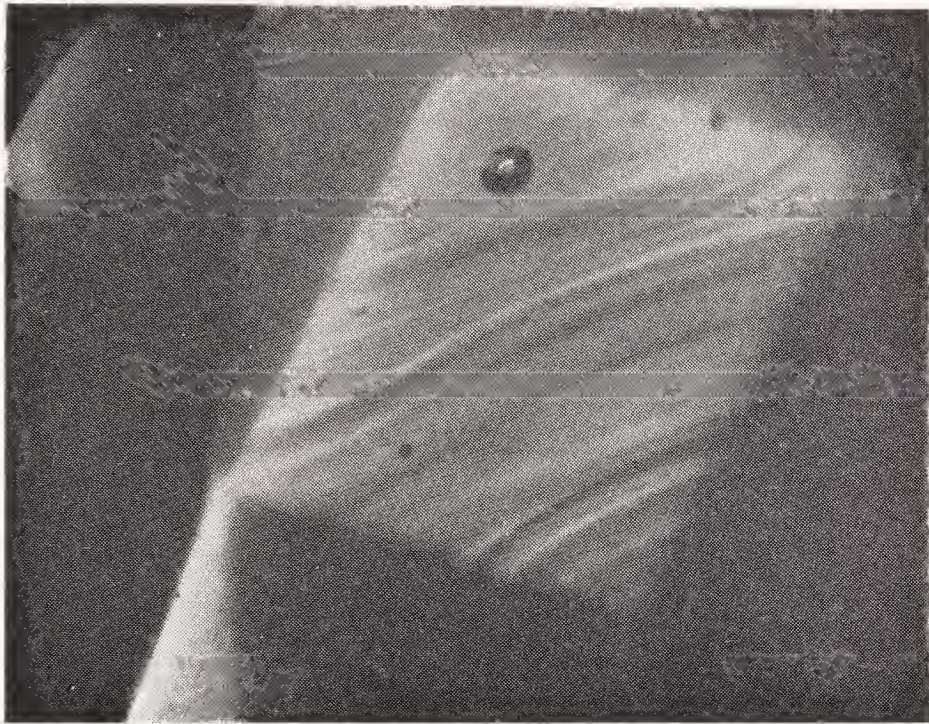

Figure 118

Photo by G.I.A.

Swirl-marks or flow lines with spherical bubbles in glass.

the melt as it cooled. In some instances, insoluble material of an angular nature is added to the melt to simulate inclusions characteristic of genuine gems. Such inclusions are invariably accompanied by numerous spherical and elongated gas bubbles.

Irregular curved color lines often serve to distinguish glass imitations of nontransparent gemstones such as turquoise and jade.

Occasionally, glass appears to be free of inclusions, even under magnifications of 100 power or more.

The refractive index and specific gravity of a glass imitation are rarely close to the readings of the gem imitated in color.

Glass, an amorphous substance, is singly refractive. It may occasionally be strained enough to show an anomalous double refraction, but rarely as strong as that of synthetic spinel. A glass imitation of a natural, singly refractive gemstone will never have both the same refractive index and the same specific gravity as that of the genuine, though it may have one or the other.

A glass imitation of a natural doubly refractive gemstone may have approximately the same refractive index and the same specific gravity as the gemstone it imitates (quartz, beryl or topaz), in

which case the singly refracting character of the glass will identify it. Especially if the back is rough, a nontransparent glass imitation through which some light passes at the edges, may give a reaction in the polariscope similar to that characteristic of doubly refractive crystalline aggregates. Vitreous luster on tiny fractures on the rough surface, or bubbles visible near the surface, identify such imitations.

Glass used for gem imitations has a normal refractive-index range from 1.48 to 1.70, and its specific gravity may be as low as 2.2 and as high as 4.2. Opal glass may have an index as low as 1.44, and an S.G. of 2.07. Since refractometer hemispheres with indices near 1.95 are made of glass, 1.70 obviously is not the extreme limit. However, glass above 1.70 is too soft to wear well and tends to develop a surface film quickly. Although two glass imitations of topaz have been reported with an index of 1.77, glass imitations above 1.70 in refractive index are rare indeed. If the refractive index is above 1.70, the specific gravity is above 4.2, with refractometer glass over 6.0.

The hardness test can be used whenever tests have proceeded to the point at which the only remaining possibilities are glass and some other singly refractive gem other than opal.

The hardness of glass is usually $5\frac{1}{2}$ or less. Some types of glass, usually blue or green, may be 6 in hardness, though most of the lead glasses used in gem imitations are softer than window glass. A steel file will scratch even the harder glasses.

Plastics. Plastic gem imitations long used to imitate amber, ivory and opaque gem materials are finding increasing use in a transparent form for costume jewelry. Plastics are also used to impregnate chalky turquoise to deepen color and improve durability. Colored plastics are used to lend color to turquoise, emerald and other gemstones by coating the surface. (See Chapter XIV.)

A plastic amber substitute called Amberdan has a refractive index near 1.56 and an S.G. of 1.23. The hot point discloses an odor reminiscent of plastics. This, plus the high R.I., distinguishes the imitation readily.

Doublets, Triplets, Foil Backs and Imitations

Plastic Opal Imitation. In Japan in 1978, a new imitation opal appeared that was made of plastic. It has an index on the order of that of opal; 1.45. The manufacturer devised a means of making tiny plastic spheres that when compacted give the same kind of diffraction grating effect that creates the play of color in opal. This is a very effective opal imitation. It is available only mounted by the manufacturer in 18 Karat mountings. It is an imitation that is very easily overlooked.

“Slocum Stones”. An ingenious man in the mid-west developed the best looking opal imitation that had been available to the gem industry until the plastic imitation was developed in Japan. This is a glass with very opal-like appearance. The properties of the Slocum imitation are considerably different from those of natural opal. The specific gravity is on the order of 2.4 to 2.5 and the refractive index is on the order of 1.49 to 1.515. They are made in a variety of body colors from white through yellow-orange to black.

Detection. Plastic imitations are easily identified by their low specific gravity and hardness. All of the common plastics used in gem imitations have specific gravities below 1.58, the density of pure carbon tetrachloride. Heat, preferably in the form of an electrically heated needle, causes plastics to give off characteristic acrid odors. A properties table for plastics follows:

	R.I.	S.G.
Plexiglass and lucite	1.50	1.18 (± .01)
Bakelite	1.61 (± .09)	1.25-1.55
Polystyrene	1.63 (± .04)	1.05

NOTE: In the event fillers are used in opaque plastic gem imitations, much higher specific gravities are possible.

Pearl Imitations are described in Chapter XII.

Hemetine* is a substitute manufactured to resemble hematite. It is a sintered product in which various materials have been used from time to time. Galena, lead sulphide, was an early raw material, lending the product a heavy (near 7.0) specific gravity and a black streak. Recent material is said to contain mainly iron and titanium

HANDBOOK OF GEM IDENTIFICATION

oxides, giving a red-brown streak, and nearly the same specific gravity and hardness as hematite. For identification see hematite, Chapter XVI.

Hematite is so inexpensive that there is only one reason for a substitute—to avoid the expense of carving. It is a fair assumption that if the image is stamped in, the intaglio is an imitation, and if it has been carved in, it is hematite.

The specific gravity varies from about 4.0 to 7.0 and the hardness from 2.5 to 6.

*The use of the term Hemetine was prohibited in advertising as misleading many years ago. It is used here only to mean any imitation of hematite.

Chapter XII

Pearls, Cultured Pearls, and Imitations

The pearl, so unlike other gemstones in appearance and origin, requires special methods of determination. Since the cultured pearl was first introduced into the jewelry trade, the most difficult determination facing the jeweler has been the distinction between natural and cultured pearls. Although natural and cultured pearls are easily distinguished from imitations, their separation from one another is exceedingly difficult.

The difficulty encountered in the distinction between the pearl and its reproduction is due to the similarity of the nature of cultured pearl to natural pearl.

Natural Pearl. Pearl is formed within a mollusc that deposits a substance called *nacre* around an irritant that has found its way into the organism. The irritant may be a microscopic grain of foreign matter such as sand, or possibly a disease or parasitic growth suffered by the mollusc. Often no identifiable source of irritation is found when a natural pearl is sectioned. When the irritant finds its way into the mantle of the animal, nacre is added layer by layer. Nacre is formed by a weblike deposit of conchiolin (a hornlike material), the spaces between which are filled with tiny crystals of aragonite (the orthorhombic form of calcium carbonate) that are oriented with the long direction perpendicular to the layer. In other words, the tiny crystals are arranged radially about the pearl. (This structure is shown in

HANDBOOK OF GEM IDENTIFICATION

a drawing.) Salt-water pearls of gem quality are produced almost entirely by species of the mollusc *Pinctada* (also known as *Meleagrina* and *Margaritifera*). Fresh-water pearls are produced by various clam and mussel genuses.

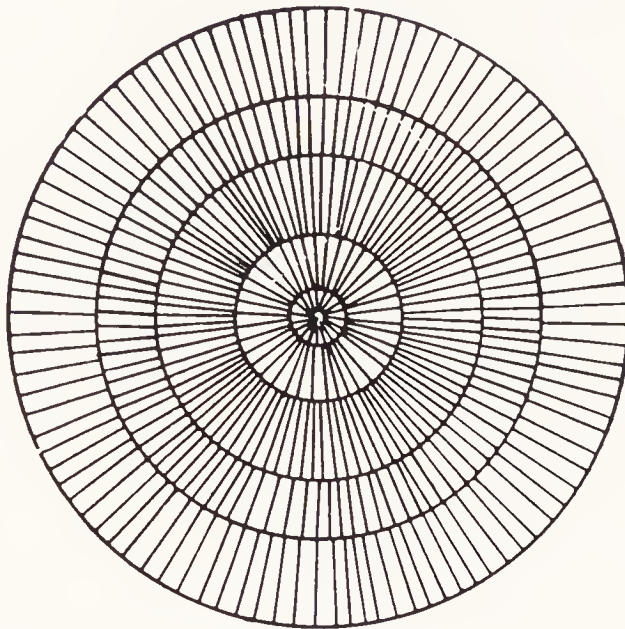

Figure 119
Schematic cross section diagram of a natural pearl.

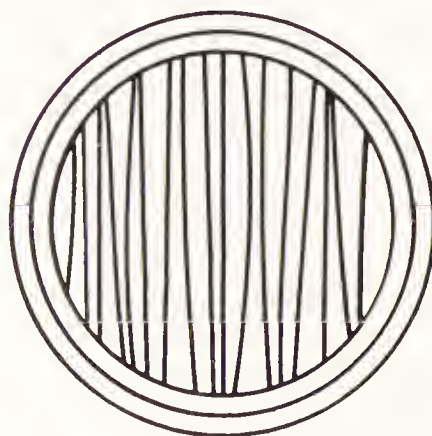

Figure 120
Cross section diagram of a typical cultured pearl.

Pearls, Cultured Pearls, and Imitations

Cultured Pearl. Salt-water pearls are cultured by introducing a mother-of-pearl bead and a piece of mantle tissue into a channel cut most often into the foot of the mollusc, *Pinctada martensii*. Sometimes, a second incision is made and another bead is inserted; when this is done, the channel is cut in another portion of the visceral mass. In Japanese water, the rate of nacre accumulation is slow; the cultured pearl removed from the mollusc, usually three and one-half years later, is only about one millimeter larger in diameter than the mother-of-pearl bead. Australian and other tropical pearling stations produce much larger cultured pearls, because of a much more rapid nacre accumulation. Whereas the largest cultured pearls produced in Japanese waters are only about ten millimeters in diameter, sizes in excess of fifteen millimeters are produced in Australia and elsewhere.

Lake Biwa, a large reservoir on the main island of Japan (Honshu) is the site of several pearl-culturing farms employing the fresh-water clam, *Hyriopsis schlegeli*. The major difference between the fresh-water and salt-water methods is the production of many pearls per mollusc and the absence of solid nuclei in the fresh-water production. The mantle is notched in a number of places and a small piece of mantle tissue inserted into each incision. In each, a pearl sac forms and a baroque pearl grows. After about three years, the mollusc is brought to the surface and the pearls are carefully removed. The product is typically white, of good luster, and about 6 x 3 millimeters in size. The mollusc is then returned to the lake and a second crop grows in the same sacs. The second harvest, two or three years later, is more baroque. Fresh water pearls from the rivers of mainland China have become very popular. Many are dyed. By x-radiography their characteristics are similar to those of Lake Biwa.

On several occasions, salt-water pearls with characteristics under x-radiography similar to those of Biwa have been encountered in G.I.A. laboratories. Apparently, they are byproducts of the Australian cultured-pearl farming.

Nacreless Concretions. Spherical and button concretions without nacre are formed in many bivalved molluscs. Frequently seen are those

from the cherrystone clam. These concretions, without nacre, are usually dark purplish brown. Nacreless pearls have little or no value.

Figure 121
Peculiar flame structure seen
on a conch pearl

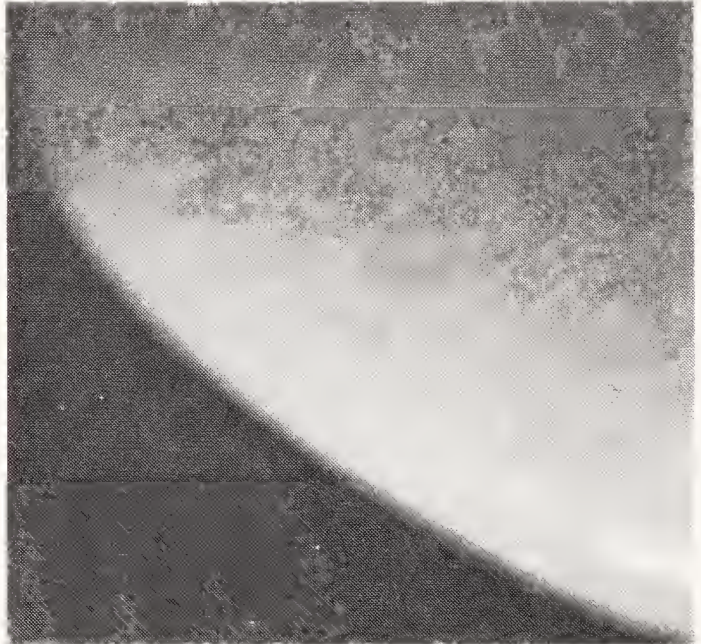

Conch "Pearls". Light orangy-red or pink concretions formed within the conch are often called "pink pearls," although they are not nacreous. They are characterized by a mottled surface appearance that gives the impression of a regular pattern of tiny reflecting surfaces somewhat similar to the appearance of amazonite. (See illustration.)

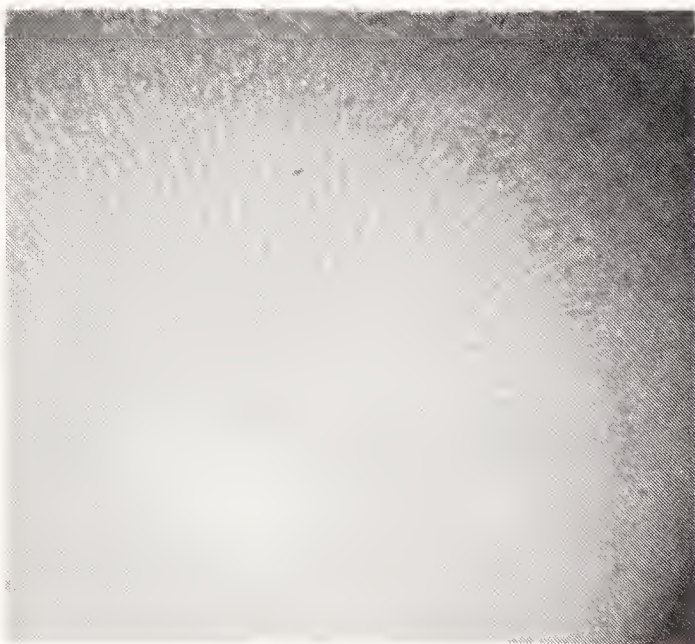

Figure 122
Interesting light reflection
pattern on a Tridacna "pearl".

Pearls, Cultured Pearls, and Imitations

***Tridacna* “Pearls.”** White concretions of pearllike shape are found in the shells of the *Tridacna gigas* species of bivalved molluscs. They are characterized by a lack of orient and a luster reminiscent of the conch pearl—a flame effect represented in the illustration.

The Distinction Between Natural and Cultured Pearls. Since the surface material of natural and cultured pearl is the same, having been deposited by a pearl-bearing mollusc, it is difficult to arrive at a positive identification of an undrilled pearl. There are many jewelers who claim the ability to distinguish between cultured and natural pearls on sight. Their methods are usually based on the difference in appearance between pearls from Japanese molluscs and those from the molluscs from other sources. It is true that Japanese pearls are more likely to have a greenish body color than other pearls. However, of the men who have dealt with pearls for a lifetime, few are willing to depend upon visual examination in a decision that will make a difference of thousands of dollars in the valuation of a necklace. Too often, mistakes result from any other test than a scientific one. Of the several tests described in the following pages, only three are to be considered conclusive under most circumstances. The two once regarded by some as the only conclusive tests, the double-mirror endoscope test and X-ray diffraction, are conclusive in certain cases but useless in others. The combination of X-radiography and X-ray fluorescence provides the most universally reliable test today.

Simple Pearl Tests

Specific Gravity. The large mother-of-pearl bead that forms the core of a cultured pearl is usually fashioned from the shell of a fresh-water bivalve. The fresh-water shell commonly used has a greater specific gravity than natural pearl. If a solution of the correct density is prepared, by far the larger proportion of natural and cultured pearls may be accurately separated. To

prepare such a solution, dilute pure bromoform (obtainable in an alcohol solution at almost any chemical supply house) with grain alcohol or acetylene tetrabromide until Iceland spar (calcite) is suspended. A few more drops of bromoform are added to just bring the calcite to the surface.

Caution: Bromoform is usually sold in an alcohol solution that has a density of about 2.5, instead of 2.9, the density of the pure material. To wash out the alcohol, pour the bromoform into water (alcohol and water are miscible, but bromoform and water are not) and decant the water carefully several times to bring the bromoform to its pure state.

In the solution prepared by the dilution of pure bromoform in the manner described, natural pearls will usually float and cultured pearls normally sink. Eighty percent of natural salt-water pearls will float in a solution with a density of 2.713, and ninety percent of cultured pearls will sink.¹

Candling. A second simple test that often gives indefinite results, but which is helpful in the identification of a complete pearl strand, is candling. Candling requires the intense illumination of the pearl, preferably in a darkened room.

In the cultured pearl, the parallel layers of a prominent mother-of-pearl core can be seen as lines across the pearl. The test is not reliable, since some cultured pearls fail to show stripes, and cracks in a natural pearl can cause a striped appearance in intense illumination. Candling of the normal natural pearl shows only a decrease of light transmission from periphery to center.

To candle a pearl effectively, an intense but well-shielded light source is essential. An opaque shield should completely cover the light except for an opening about one millimeter over which the pearl is placed. It is necessary to turn the pearl slowly in the light beam to find the stripes in a cultured pearl or to be certain that such a structure is not visible. While candling is unreliable in the testing of a single pearl, it furnishes an indication as to the identity of a strand.

1. Anderson, B. W., Payne, C., *Gemmologist*, May, 1939.

Pearls, Cultured Pearls, and Imitations

Magnification. A test often used by jewelers because of its ease of application is magnification of the walls of the drill hole of a pearl with a loupe or microscope. The brown conchiolin separation layer is often visible between the mother-of-pearl core and the layers of nacre. Care must be taken to light the drill hole adequately so that the brown layer is visible, if present. Unfortunately, while the presence of such a layer is a good indication of cultured pearl, it is not proof, since similar phenomena occur in natural pearls and are not always present in the cultured pearls. In addition, the concentric layers expected in a natural pearl may be evident when the nacre around the core of a cultured pearl is thick.

Appearance. The gelatinous appearance and the greenish body color is a good indication of Japanese pearl, and, thus of cultured pearl. Before World War II, however, cultured pearls were produced in the East Indies, where the external nacre characteristics were unlike those of the Japanese product. Still, to the experienced pearl man, the Japanese characteristics are good indications of cultured pearl, even though the lack of such characteristics is no longer truly indicative of natural pearls. Black welts, not common in natural pearls, have long been considered suggestive of cultured origin. The insertion of a large mother-of-pearl bead sickens the mollusc, which accelerates conchiolin production, producing the welts.

Strands of beads with very thin layers of nacre are likely to have a number of beads showing brighter reflections caused by the mother-of-pearl effect showing through the thin covering. If such a strand is held taut from end to end, and rotated around the string under a light, many of the beads appear to wink twice in a 360° rotation. Such an effect is almost proof of cultured origin.

More Conclusive Pearl Tests

The Pearl Endoscope was considered for many years the most exact instrument for the determination of the origin of drilled

pearls. It remained highly effective until a variety of substitutes were devised that failed to yield to this testing method. There are several methods of identification that utilize metal needles with mirrors polished at 45° angles to their length, principal ones being the single-mirror method and the double-mirror method described below. All of them may be applied with the endoscope. All endoscopic methods share the serious shortcomings of requiring individual examinations, so necklaces must be cut apart and only fully drilled pearls may be tested.

Single-Mirror Method. There are two single-mirror methods. The first is used to examine the walls of the drill hole by directing an intense light source at the pearl from the side. After passing through the pearl to the mirror, the light is reflected to a microscope focused on the mirror. This allows the microscopist to examine the walls of the drill hole. In a natural pearl the observer can see the concentric rings layer after layer to the center of the pearl, accompanied by a gradual decrease in the light intensity. In the examination of a cultured pearl, the rings end abruptly as the mother-of-pearl core starts, and the light decreases sharply.

The Second Single-Mirror Method, much less conclusive, is essentially the opposite of the first method. In place of being used to examine the walls of the drill hole, the mirror is used to direct intense illumination against the walls, with the observation being directed from the side of the pearl without magnification. If the pearl has a mother-of-pearl core, the intense light is carried by repeated reflection along the parallel layers of the mother-of-pearl up to the nacre rings, where it gives an effect similar to chatoyancy (the cat's-eye effect). This effect is seen only in the cultured pearl, but not all cultured pearls show the phenomenon distinctly. Natural pearl, which retains the light within the inner rings by reflection, has an even illumination in contrast to cultured pearl.

The Double-Mirror Method. The double-mirror method employs a hollow needle that has two mirrors inclined at 45° to the length of the needle and at 90° to each other. When carefully used

Pearls, Cultured Pearls, and Imitations

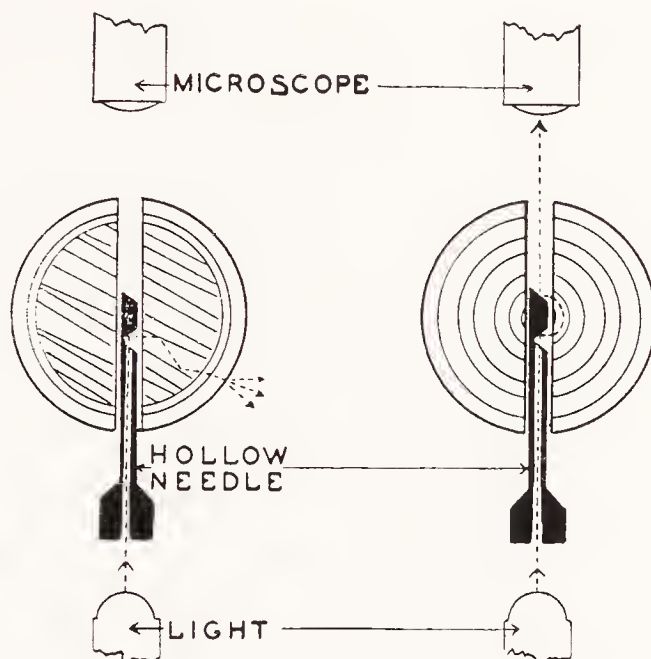

Figure 123

Left. Schematic diagram of the reaction of a cultured pearl in the double mirror testing method of the endoscope or pearloscope. Right. Reaction of a natural pearl.

this test is almost 100 percent effective. One pearl in thousands fails to lend itself to positive identification. The hollow needle is mounted before an intense-light source so that the light is directed through the needle to the first mirror surface from which it reflects to the wall of the drill hole. If the pearl is cultured, the light will be carried along between the parallel layers until it passes through the thin nacre shell. If the pearl is natural, the effect is different. A microscope is directed through the end of the drill hole opposite to the base of the needle and directed upon the second mirror. When the light strikes the walls of the drill hole in a natural pearl, it is carried around the pearl within the ring of nacre it first strikes by total reflection, much in the manner that light is carried from end to end of a curved lucite rod. The light carried within the concentric ring strikes the second mirror and is reflected as a bright flash to the microscope and to the eye of the observer.

This method provides positive proof of the presence of concentric layers extending to the center. Thus, the only possibility

of error would be encountered in a spherical, wholly cultured pearl such as the very rarely spherical second crop from a mollusc at Lake Biwa.

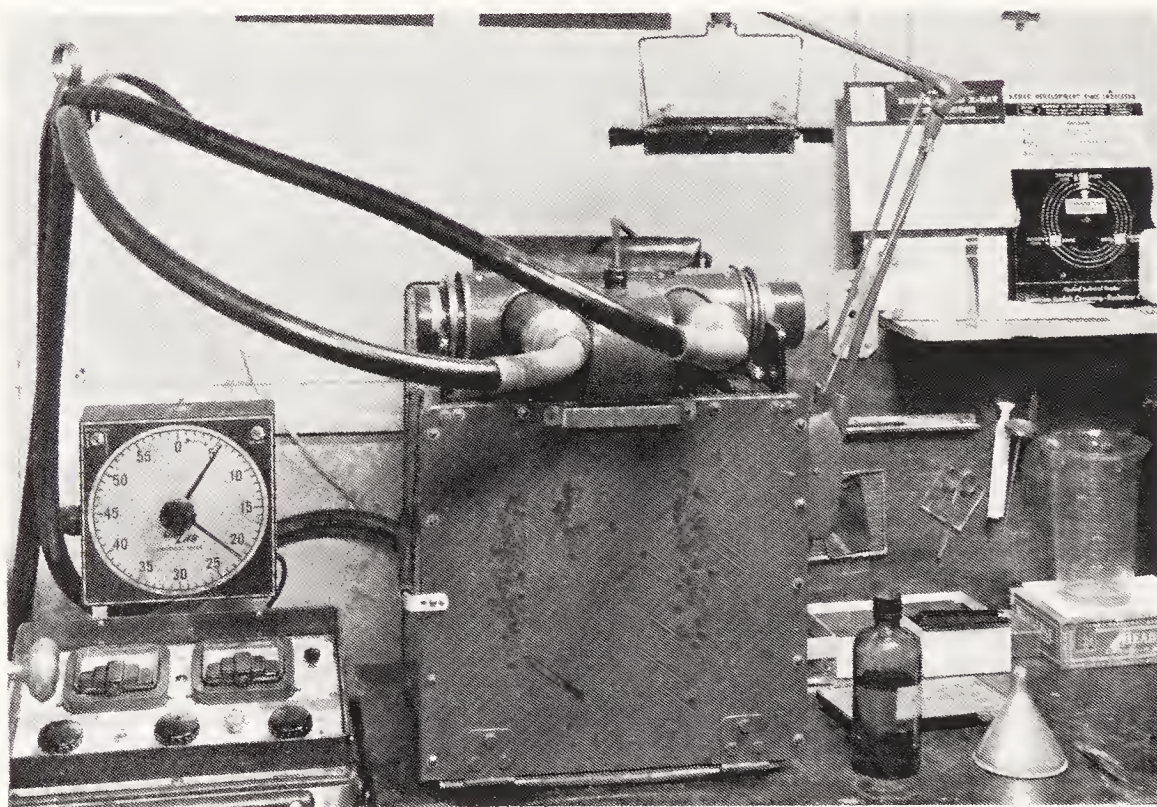

Figure 124
X-ray Pearl Testing Unit.

X-Ray Methods. The various X-ray methods will not be described in detail for such equipment is not easily available and is too expensive for the usual gemological laboratory. However, many jewelers send pearls to laboratories for identification by X-ray, so some mention of the basis for such tests should be included here.

X-Ray Diffraction. Prismatic crystals of aragonite are arranged radially around the center of the pearl with their length at right angles to the surface (see Figure 119). In the cultured pearl, the prismatic crystals are also perpendicular to the layers, but the layers in the core are straight and parallel, not spherical and concentric as in the natural pearl (see Figure 120). Only the thin outer covering of nacre has the same arrangement as natural pearl. When the natural pearl is placed in the path of the X-ray beam, with the beam passing

Pearls, Cultured Pearls, and Imitations

through the center of the pearl, the rays are traveling parallel to the length of the crystals. Because of the atomic arrangement of aragonite, the resulting diffraction pattern will have a six-fold symmetry (what appears to be a hexagonal pattern of spots). (See X-ray patterns.) The only direction in which the cultured pearl can give a similar pattern is in the one position($\pm 37^\circ$),¹ where the parallel crystals of the mother-of-pearl core are parallel to the X-ray beam. To avoid this unlikely chance, it is safest to take a second X-ray photo after rotating the pearl 90° , if the first pattern shows a hexagonal pattern. If the cultured pearl is in any other position, this will give a pattern with four-fold symmetry. (See illustration.) The X-ray diffraction method has important weaknesses. Pearl necklaces to be tested must be cut apart and tested individually or in small

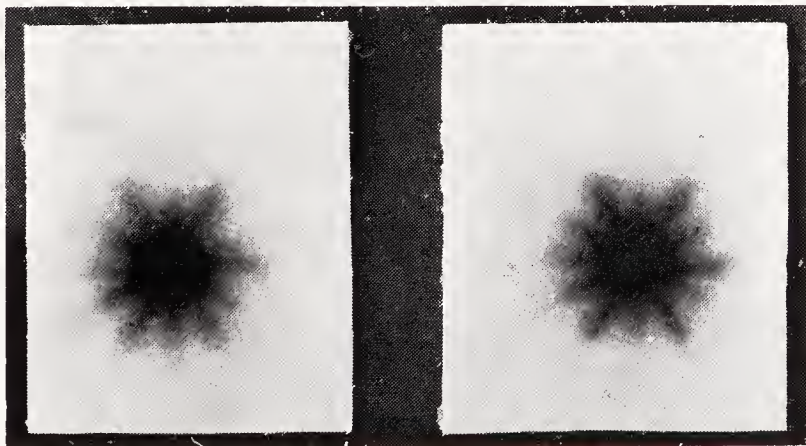

Figure 125

Hexagonal diffraction patterns from natural pearls.

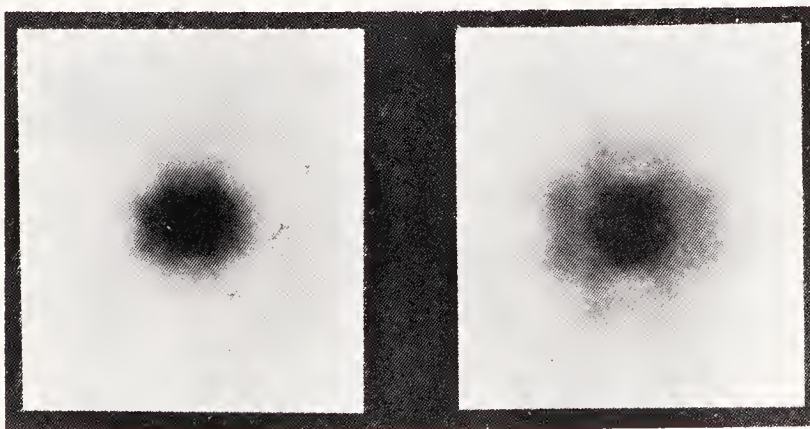

Figure 126

Four-fold symmetry in cultured pearl diffraction pattern.

HANDBOOK OF GEM IDENTIFICATION

groups. It is reliable for the detection of Japanese salt-water cultured pearls with thin nacreous shells, but large cultured pearls with nacre of significant thickness in relation to the mother-of-pearl bead would give hexagonal patterns in most directions. X-ray diffraction likewise is of no value in the detection of fresh-water pearls cultured without nuclei, for there is no structural difference between them and natural pearls. Radiography is more satisfactory and reliable.

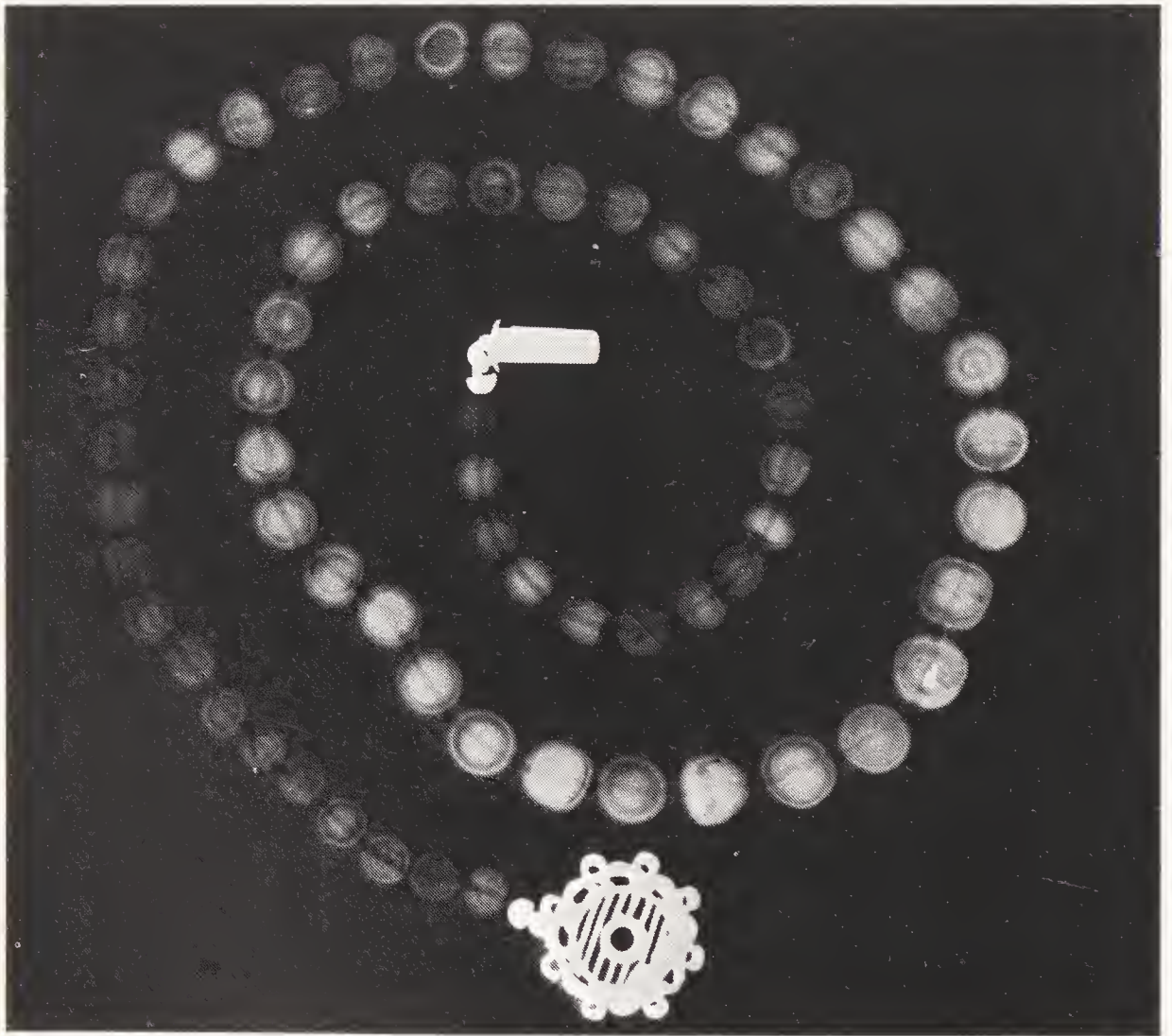

Figure 127

X-radiograph of a strand of natural pearls.

Radiographic Method. The X-radiographic method of pearl identification permits the examination of an entire strand of pearls at one time. In contrast to the narrow pencil of X-radiation

1. See Barnes, William H., "Pearl Identification by X-ray Diffraction." *Gems & Gemology*, Vol. V, 1947, pp. 508-512.

Pearls, Cultured Pearls, and Imitations

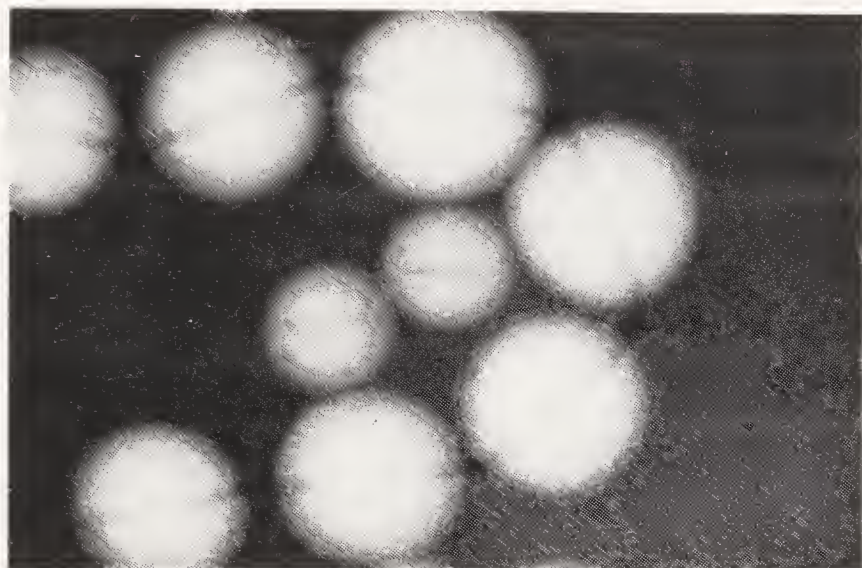

Figure 128
X-radiograph of a strand of cultured pearls.



Figure 129
A radiograph of fresh-water cultured pearls from Lake Biwa, Japan

required for the diffraction photograph, radiography employs a broad X-ray beam. Pearls to be tested rest in a container, transparent to X-rays, placed over suitable film. Radiography, as employed in the pearl-testing laboratory, is comparable to that used by the dentist to study teeth. This method depends upon the difference in transparency to X-rays of the conchiolin layer around the mother-of-pearl core and the nacre coating of the cultured pearl.

In a natural pearl the absorption of X-rays is dependent on thickness, since it is a homogeneous object. The resulting radiograph may exhibit several fine gradations in X-ray transmission in the natural pearl, whereas the cultured pearl usually shows a very definite dividing line at the separation between core and nacre, due to the extreme transparency of the conchiolin layer about the mother-of-pearl core.

The fresh-water cultured pearls started without solid nuclei usually show a dark vermiform spot near the center. In the first growth it is large, and in the second, much smaller. This dark area serves to identify the Lake Biwa product.

Similar appearances have been encountered in salt-water products of unknown source.

Fluorescence. In some cases, radiography alone provides insufficient evidence for positive results. However, with the same equipment employed in pearl radiography, the characteristic reactions of pearls to the exceedingly short-waved X-radiation were determined by A. E. Alexander, Ph.D. All cultured pearls utilizing fresh-water-shell cores glow when exposed to the X-ray beam. Since no salt-water-shell cores have been encountered to date, all cultured pearls (with the exception of the exceedingly rare experimental cultured pearls with glass cores) fluoresce before the X-radiation. Of the natural pearls, only fresh-water pearls and some Australian pearls fluoresce. The information obtained from this test added to that provided by careful study of the radiograph permits reliable determinations on strands and single pearls alike.

Detection of Artificial Color in Black Pearls. Artificial coloration to produce black pearls is a rather common practice, but the methods used are carefully guarded secrets. If a pearl is dipped into black dye, the dye may be detected by rubbing a white swab soaked in a weak solution (1:20) of nitric acid against the pearl; the swab will be slightly discolored. Others are soaked in a solution of a silver salt, such as silver nitrate, and exposed to light to precipitate free silver. These show white streaks on an X-radio-

Pearls, Cultured Pearls, and Imitations

graph, due to silver's opacity to X-rays. Others seem to be treated in a manner that attacks the conchiolin and turns it black. Acid swabs fail to detect such treatment. Black pearls with a natural color usually fluoresce in a pink to red color under long-wave ultraviolet, in contrast to treated blacks, which either fail to fluoresce or have a whitish fluorescence. A few natural blacks fail to fluoresce, but these are distinguished by the presence of green, rod-like inclusions in a near-transparent surface layer. Otherwise, failure to fluoresce in a reddish color is satisfactory evidence of artificial color. Black pearls that fluoresce red also have characteristic absorption spectra. (See the table of spectra in Chapter XIII.)

Pearl Imitations

Much improvement has been made recently in the appearance of pearl imitations marketed extensively in the United States. The imitation pearl is usually based on a sphere of one of three types: wax-filled glass, solid glass or mother-of-pearl. All are given a pearllike luster by dipping the spheres into *essence d'orient*, usually a suspension of guanine (the tiny lustrous crystals that are removed from the membrane coating of fish scales in an aqueous detergent) in cellulose nitrate, but other substances are used, as well. Essence d'orient provides luster but the imitations must be dipped into clear cellulose acetate and then clear cellulose nitrate to achieve an interference effect similar to orient. Such imitations are remarkably similar to natural pearls in appearance.

Wax-filled Imitations. Careful examination of the drill hole will show the character of wax-filled imitations. The edges of the hole have a glassy character, a vitreous luster and a rougher appearance than the natural or cultured pearl. Wax-filled imitation pearls are smooth to the teeth in contrast to the gritty character of genuine nacre. A needle inserted into the drill hole at an angle will reveal the soft wax by feel. A pinpoint pushed against a wax-filled imitation will cause a momentary depression in the surface, in contrast to natural pearl or any other substitute. Caution: Although the vast majority of wax-filled imitation pearls feel smooth

HANDBOOK OF GEM IDENTIFICATION

to the cutting edges of the teeth, recently a few with gritty material added to the essence d'orient have been encountered in the Gem Trade Laboratory in New York City.

Solid Imitations. Solid-glass imitations (so-called "indestructible pearls") are quite common in the trade. The detection of the solid-glass imitation is similar to that of the wax filled. It, too, is smooth to the teeth. The edges of the drill hole are glassy. Under magnification, the surface appears smooth, rather than scaly, as in genuine and cultured pearls. When held to the light, both genuine and cultured pearls show a translucent rim not visible in the imitation. The mother-of-pearl beads used in some of the better imitations show banding very prominently when held before a bright light.

The outer coating on solid-glass, wax-filled and mother-of-pearl imitations fail to react to a droplet of hydrochloric acid, in contrast to the rapid effervescence noted in the droplet on cultured or natural pearls. A drop of acid placed just inside a drill hole will effervesce strongly in the imitation using mother-of-pearl. The quality of imitation pearls depends upon the number of applications of the essence d'orient. Often, as many as forty applications are made in the finer qualities.

Pink Coral. Pink conch pearls are often imitated by the use of coral. They have a higher specific gravity than coral (conch pearl about 2.85, coral 2.65), and their surface appearance is different. Coral shows distinct irregular surface pits. Conch pearls often have a mottled appearance, and show the strong flame structure under reflected light.

Conclusions. One of the most difficult tasks for the practicing gemologist is the distinction between genuine and cultured pearls. Unless the jeweler has an endoscope or X-ray equipment, he can do no more than make simple tests that will give him an indication, but not final proof, of the true nature of the pearl. The gemologist with limited equipment is more often forced to submit pearls to trade laboratories for identification than any other type of gem.

Chapter XIII

The Spectroscope

The value of the spectroscope in gem identification continues to increase as new substitutes are introduced. The beauty of a distinctive absorption spectrum has always made the use of the spectroscope a test of particular interest to gemologists; but, for many years, it could be said that the spectroscope, although a valuable weapon in the gemologist's arsenal, was not one of the absolutely essential instruments. Today, there are separations that cannot be made by gemologists without the spectroscope. For example, diamonds given a yellow or brown color by subatomic-particle radiation in a nuclear reactor, followed by heat treatment, are indistinguishable from naturally colored yellow and brown diamonds, except by spectroscope. It also serves to separate naturally colored green jadeite from dyed jadeite and jadeite triplets, as well as some colors of natural from synthetic corundum, which may be difficult to identify beyond argument by other means. It is useful for identifying gem rough quickly and often for testing either mounted or loose goods more quickly than would be possible otherwise. Just as the utility of the refractometer is reduced by its inability to give readings for highly refractive gems or from rough surfaces, so is the utility of the spectroscope less than universal. However, it is often of greatest value where the refractometer is useless.

The industrial scientist who utilizes spectroscopy usually heats the unknown material to white heat or renders it incandescent between carbon electrodes in an arc. However, since such tests are obviously impractical in the spectroscopic analysis of gemstones,

HANDBOOK OF GEM IDENTIFICATION

neither method is useful for the gemologist, who must rely on absorption spectroscopy when testing gemstones. He analyzes light which passes through or is reflected from the gemstone. Thus, absorption spectroscopy offers a practical test in gem identification, in that the stone is not harmed in any way. Since the color of a transparent gemstone is the result of selective absorption, it is reasonable to expect that white light transmitted through a colored material may show bands or lines of absorption when examined by an instrument constructed to show a spectrum of the light transmitted through or reflected from the stone.

Types of Spectroscopes. For the purpose of the gemologist, simple, inexpensive instruments are satisfactory. The two major types are prism spectroscopes and diffraction spectroscopes. The diffraction type has the advantage of being inexpensive and showing an even spectrum in contrast to the prism type, but it passes much less light. Although the prism type widens the violet end of the spectrum and shortens the red, its greater light transmission makes it a much more useful spectroscope, since sufficient light is more important than the relative spreading of the spectrum. The simplest instruments show a single spectrum for the gem



Figure 130
Beck Hand Spectroscope

The Spectroscope

being examined. However, there are fairly inexpensive spectroscopes available which utilize light from another source to illuminate a graduated and numbered scale for comparison purposes. Perhaps the simplest and least expensive type of the prism instruments is the Beck Hand Spectroscope, model number 2458, which is made in England. Beck makes a number of other spectroscopes and spectrometers. Perhaps the most practical is their model 2522, with a built-in wave-length scale. Although parallax makes it all but impossible to achieve great accuracy with it, it does assist the user to gain a close approximation of the position of a line. Other manufacturers, such as Rayner and Zeiss, also make hand spectroscopes. Some hand spectroscopes do not allow absorption lines in the deep blue to be analyzed.

Testing a Stone. The key to the successful use of a spectroscope is effective lighting. It is essential to have the stone intensely illuminated in a manner that will permit only the light transmitted or reflected from the stone to be analyzed. One very simple means is to use the illuminator of a Diamondscope or Gemolite with the baffle removed and the iris diaphragm closed down so that the stone rests over the small opening which is left. The spectroscope is then placed so that the slit end is about one inch from the stone and in a beam of light transmitted through the stone. There are many other ways to illuminate the stone. Often a powerful source is required to provide enough light transmission through a dark stone. For this purpose, a slide or movie projector of 250 to 1000 watts is useful. If no projector is available, a projection lamp may be shielded and its light concentrated on the stone by a lens or a water-filled, flat- or round-bottomed, essentially spherical chemical flask. Light passing through a faceted stone is concentrated in small brilliant beams making the use of a hand spectroscope more difficult; therefore, magnification of such a beam into an even glow is advantageous. This may be accomplished by a hollow cylinder with a low-power magnifier at the end near the stone or, more conveniently, by using an ordinary microscope with the eyepiece removed. Most novice spectroscopists are plagued by the same problems. The light source used is too weak, the slit through

which light enters the instrument is left too wide, and the instrument is not held with a steadiness that permits results to be studied. There is also a tendency to permit too much extraneous light to flood the slit, and, finally, the initial results are expected to resemble India-ink lines on white paper, instead of the often faint differences in absorption that occur.

For best results, the slit should first be closed and then opened only enough to make the full spectrum visible and to eliminate the strong horizontal lines across the spectrum. If the lines persist, a sharpened wooden match or toothpick may be used to clean the slit. If reflected light is used, the stone should be placed on a small pedestal over a dull-black background. The light beam should be focused on the stone or passed through a small opening near the stone, so that the only light falling on the slit is that which has passed through or, in case of opaque stones like turquoise, been reflected from the stone. The spectroscope should be mounted so that it may be moved freely until a satisfactory position is reached, when it should be possible to set it in that position. It is difficult to use a hand spectroscope, unless it can be held in a steady position. There are stands made to hold the Beck instruments, or a chemical supply house can furnish a post and a test-tube clamp to mount on it to hold the spectroscope.

Most hand spectroscopes are focused by extending or shortening the drawtube to sharpen the portion of the spectrum being studied.

Spectroscope Unit. To achieve fully satisfactory results, spectroscopic equipment needs both a high intensity, cool illumination, and flexibility for transmitted or reflected light. The late Lester B. Benson, Jr., designed a very practical unit meeting these requirements. This instrument, shown in Figure 131, employs a Beck wave length spectroscope with a variable-intensity concentrated light source. A right angle prism cools the beam, so that the specimen is not raised in temperature unduly during a prolonged examination. The spectroscope is mounted on a movable arm and the lamp on a folding mount. This combination permits a wide range of light intensities, using either transmitted light or light reflected at any angle from the surface or internally.

The Spectroscope

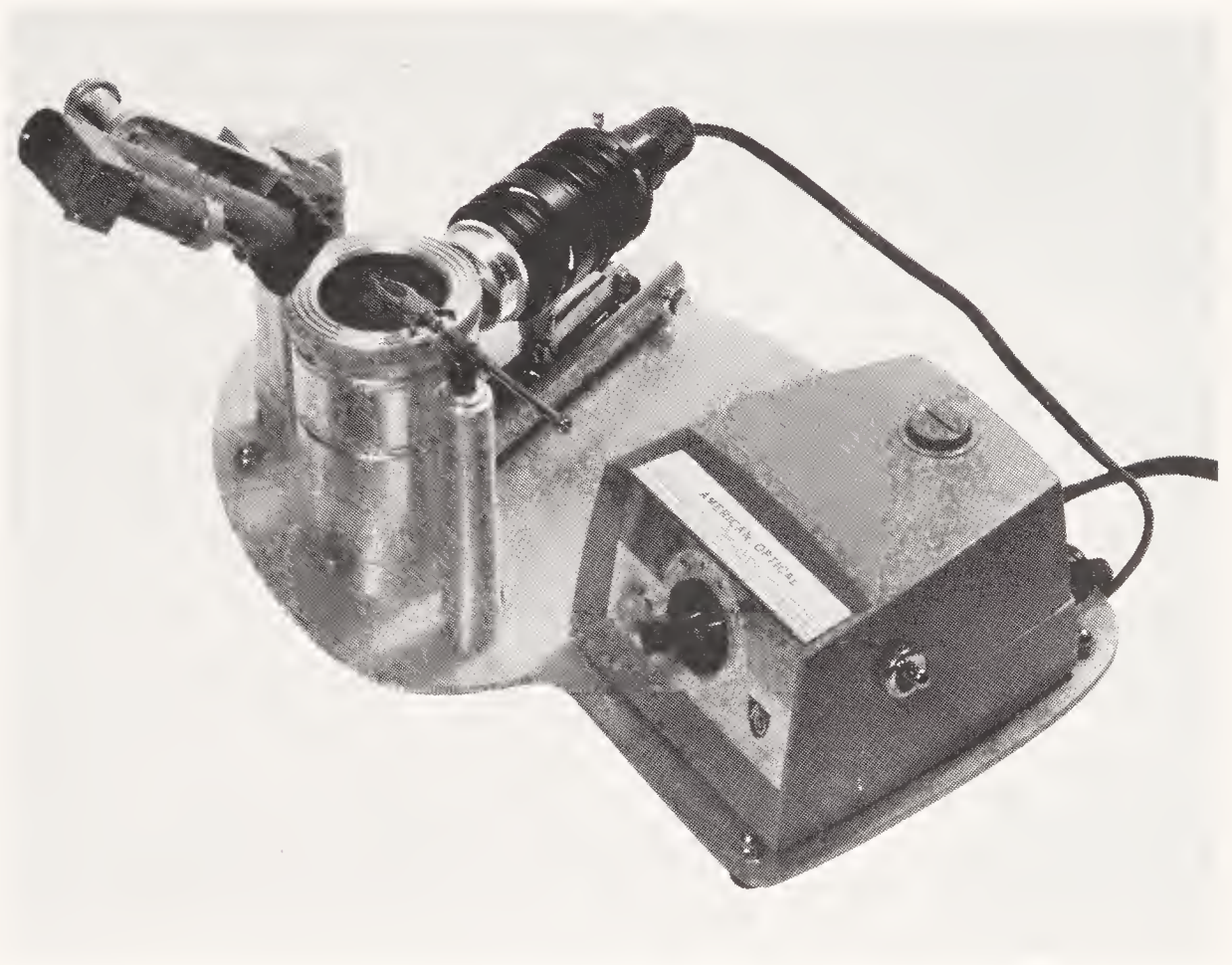

Figure 131

The GIA Spectroscope Unit.

Agents Causing Absorption. Absorption of a portion of the white light entering a transparent gemstone, or reflected from an opaque one, is responsible for the color perceived. Unfortunately, the absorption is not sufficiently confined in wave-length to be characteristic for each color of each colored stone. Some metallic-oxide coloring agents are much more likely to impart a characteristic pattern in any substance in which they appear than are others. Among the coloring agents, chromium is a particularly prolific producer of characteristic spectra. It is responsible for the color of ruby, synthetic ruby, red spinel, emerald, alexandrite, pink topaz, green jadeite and demantoid, among other stones. A glance at this list shows that chromium oxide causes both the richest reds and the richest green colors. The reason for this is apparent in the spectroscope, since, in contrast to iron, which also produces red and green colors in gemstones, the chromium absorption is sharply defined;

and in the wave-lengths between absorption lines or bands, absorption is minimal. Chromium causes slightly different spectra in each gem in which it appears, but, in general, it is responsible for broad absorption in the violet and in the center (green or yellow), and for narrow lines in the red portion of the spectrum. Some of the red absorption lines in transmitted light are often fluorescent lines in scattered light. Sometimes, there are sharp lines in the blue, as in ruby and synthetic ruby.

Iron, a strong coloring agent, both in ferrous and ferric forms, is responsible, or partially responsible, for the color in blue, green and yellow sapphire; almandite; yellow and green chrysoberyl; yellow orthoclase; peridot; green tourmaline; aquamarine; blue spinel; and other gems. Usually, iron is responsible for broad absorption bands in the blue and green portions of the spectrum. The absorption in yellow diamond is caused by nitrogen, rather than by one of the usual color-causing transition elements.

One element that causes sharp spectral lines without being a prominent cause of color is uranium. Its most common appearance is in the type of zircon with the many sharp absorption lines. Such lines may even be seen in colorless zircon, showing that the uranium may permit such a high degree of transmission of such a well-distributed portion of the spectrum that the eye still perceives the stone as colorless.

Manganese is responsible for the flesh-red colors of rhodochrosite, rhodonite and some pink tourmaline; its usual characteristic in a spectrum is broad absorption in the violet and the blue. The rare earths, neodymium and praseodymium, usually present together, are responsible for several sharp bands in the yellow portion of the yellow apatite spectrum; they may be present also in other colors of apatite. Cobalt, which is used to impart a sapphire-blue color to synthetic spinel and glass, has a characteristic spectrum consisting of three strong lines in the blue-green, yellow, and orange.

Evaluating Results. The spectra reproduced herein are reasonably self-explanatory and need little, if any, further comment. The

The Spectroscope

stars show rather well their dependability. Unless a distinct spectrum is seen, it is better for the novice to more or less disregard his findings. In other words, although some gems, such as ruby and synthetic ruby, always show a clear-cut spectrum (and failure to see that characteristic spectrum makes a ruby identification immediately suspect), there are many more cases when it is difficult for a novice to be sure that the vague absorption he detects is dependable.

The usual tendency for the beginner is to expect too much at first glance. Practice first on synthetic ruby, dark-blue synthetic spinel and almandite. Later, zircon, emerald and yellow diamond should be attempted. Lighting that will permit resolution of the lines in a natural yellow diamond should be adequate for most purposes. Caution: some yellow diamonds, especially richly colored so-called canary diamonds show no absorption lines.

In general, where a spectrum is marked with three stars, failure to find it in the gemstone makes an identification highly questionable. On the other hand, in two-starred and one-starred spectra, the failure to resolve a satisfactory spectrum is not of too great concern. In some cases, it will be necessary to examine a stone carefully in several directions under different conditions before it can be assumed that there is no characteristic spectrum to be seen. Treated diamond is an excellent example. There are times when the characteristic lines are very difficult to find; this is particularly likely when the stone being examined is permitted to take the full heat of an intense light beam. The treated diamond may not show the 5920Å line after the beam has heated it to a high temperature; therefore, the light should be passed through a water flask or prism or the stone held on an ice- or dry-ice-filled container.

The Visible Spectrum.

Red	7000 to 6400Å
Orange	6400 to 5950Å
Yellow	5950 to 5750Å
Green	5750 to 5000Å
Blue	5000 to 4400Å
Violet	4400 to 4000Å

Some of the characteristic spectra of the important gemstones are described in the following paragraphs. These and others are portrayed in the tables that follow.

Almandite Garnet. Ferrous iron causes a highly diagnostic spectrum in almandite. This is true despite a wide variation in appearance between the spectra of groups of almandites because of the variable iron content. Dark almandites show a very strong band in the blue-green (centered at 5050) and weaker bands in the green (5270) and yellow (5760Å). Weaker absorption lines may be visible in the orange and one to several in the blue. In most almandites the blue-green absorption is strongest, but the other two major lines more nearly approach it in strength.

Beryl. Emerald shows a chromium spectrum with twin lines at 6835 and 6805Å, plus lines at 6620 and 6460Å. There may be lines at 6370Å and in deep-green stones at 4770Å. A rather vague absorption is seen in the yellow and yellow-green, centered near 6050Å. Synthetic emerald shows the same lines.

Chrysoberyl. The yellow variety shows a broad band centered at about 4450Å in the blue-violet. The alexandrite variety shows a chromium spectrum. There is a strong doublet at 6805 and 6785Å. A line usually is seen at 6450 and others at 6550 and 6650Å. There is a broad, fairly weak band in the yellow and lines in the blue at about 4750 and 4680Å.

Demantoid Garnet. Usually, demantoid shows a very strong absorption band in the violet, below about 4500Å. This usually seems to foreshorten the visible spectrum. Exceptionally rich, deep green stones show a doublet at the extreme red end near 7000Å and sometimes two weak bands in the red-orange and orange.

Diamond. In yellow diamonds usually a number of lines are visible in the blue and violet. The strongest of these is at 4155Å in the deep violet. Others are usually visible at 4530Å, a weak one at 4660 and a stronger one at 4780Å. Natural brown stones with a green fluorescence have a very weak 4980, a slightly stronger 5040,

The Spectroscope

and a thin faint line at 5330Å. Based on a small number of observations it appears that natural green stones (for which no spectrum is shown) have a strong 5040 and a very faint 4980. The characteristics of irradiated diamonds are shown in the table in this chapter and discussed under diamond in Chapter XVI.

Jadeite. Rich-green jadeite always shows three step-like lines in the red at 6300, between 6500 and 6600, and near 6900Å. They seem successively darker in steps to the upper limits of visibility. If the green color is intense, the strong, sharp 4370Å line, so valuable in the identification of most jadeite, may be masked by general absorption in the blue. For the characteristics of dyed jadeite, see table in this chapter and the section on jadeite in Chapter XVI.

Peridot. The peridot spectrum, caused by ferrous iron, gives three fairly broad bands in the blue area, centered at about 4960, 4740, and 4530Å.

Pyrope Garnet. The spectroscope provides an excellent means of separating the rare, nearly pure pyrope from dark-red spinel with a comparable refractive index. Each has a broad absorption band in midspectrum but that of pyrope is centered in the yellow-green at about 5750Å, whereas spinel's band is centered in the green near 5400Å. The band centered at 5050Å, characteristic of almandite, is often seen in pyrope also. Narrow chromium lines in the red may be seen on occasion.

Ruby and Synthetic Ruby. Ruby has a distinctive and dependable spectrum, caused by chromium. The synthetic has the same spectrum. There is a broad absorption band from about 6200 to 5400Å, which, with three clear lines in the blue at 4765, 4750, and 4685Å, and two lines close together at 6942 and 6928Å in the red, distinguish ruby. The lines in the red often appear as fluorescent lines; they are so close together that they usually appear as a single band with a hand instrument.

Sapphire and Synthetic Sapphire. (See Chapter X.)

Spinel. Red spinel, colored by chromium, has a wide band from about 5950 to 4900Å. There may be five or more thin fluorescent lines in the red, which are seen best by scattered light.

Blue spinel is colored by ferrous iron. The spectrum includes a band at 6320Å in the orange, bands at 5920Å in the yellow, 5550Å in the green, one at 4800Å, and a broad one centered near 4600Å in the blue. These bands and lines may be difficult to resolve.

Synthetic Spinel. The dark blue synthetic spinel shows a cobalt spectrum with three strong absorption bands. The two heaviest are in the orange, and yellow, with a slightly narrower band at about 5400Å in the green. Typical spectra for other colors of synthetic spinel are shown in the tables.

Tourmaline. Green tourmaline absorbs the red to 6400Å and shows a narrow band near 4975Å, a ferrous iron spectrum.

Red tourmaline shows an absorption line at 4500Å that varies with depth of color and the direction of light transmission. In deeply colored stones another slightly weaker line is seen at 4580Å. General absorption in the green is accompanied by a narrow line toward the yellow near 5300Å.

Zircon. The many representations of zircon spectra published in articles and texts are likely to be misleading because zircons showing the many lined, uranium-caused spectrum are exceptional. Most zircons show a line at 6535Å and a weaker one at 6590Å. If weak, they are best seen by reflected rather than transmitted light. Green zircons always show a number of lines, usually more diffused than those of high property zircons. Yellow and brown Ceylon types and green zircons from Burma are most likely to show the many lined spectra that are shown in the tables. Red zircon often shows no lines at all.

Table of Typical Absorption Spectra. The following reproductions were prepared by Robert Crowningshield, Director of the Institute's New York Gem Trade Laboratory, to duplicate as nearly as possible the appearance of the spectra of these materials.

The Spectroscope

Crowningshield's technique produces particularly realistic reproductions of the appearances encountered by the gemologist using a prism spectroscope.

Most of the spectra are evaluated by one, two or three stars, in a system adapted from that used by B. W. Anderson. In this system, the following meanings are indicated:

- *** Always present and diagnostic in this color.
- ** Diagnostic when present, but not always present or clearly defined.
- * Sometimes useful as a confirmatory test, if present.

If no star is used, the spectrum represents one that has been recorded in either of the GIA's laboratories, but either it is rarely seen or too few stones have been examined to be able to indicate value in testing. Some two- and three-star spectra represent very few stones examined in rare species or colors, but the presence of certain essential coloring agents that cause characteristic absorption makes for a safe assumption of diagnostic value.

(Note: The order of the typical spectra illustrated on the following pages are sometimes listed by species and other times by varietal name.)

HANDBOOK OF GEM IDENTIFICATION

Absorption Spectra of Important Gemstones



Andalusite — ordinary brown-green type ★

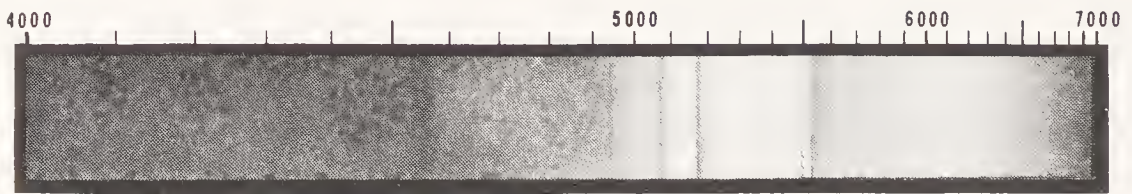

Andalusite — green (rare-earth spectrum) ★



Almandite — dark color ★ ★ ★



Almandite-Rhodolite — light color ★



Beryl — dark-blue aquamarine ★ ★



Beryl — common yellow-green ★ ★



The Spectroscope

Absorption Spectra of Important Gemstones

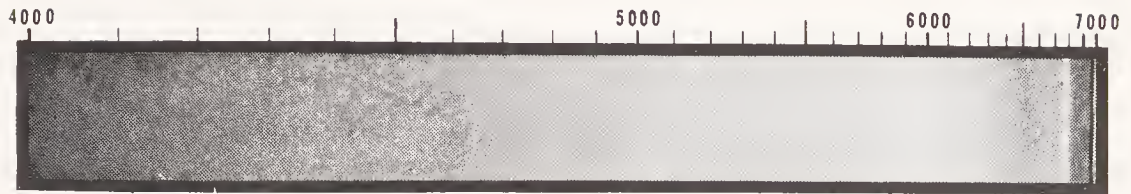

Beryl — pale Brazilian pegmatite emerald (random orientation, scattered light) ★



Chalcedony — dyed green ★ ★ ★



Chrysoberyl — alexandrite (red, or fast, ray) ★ ★ ★



Chrysoberyl — alexandrite (green, or slow, ray) ★ ★ ★



Chrysoberyl — alexandrite (weak color change) ★



Chrysoberyl — pale yellow ★ ★ ★



HANDBOOK OF GEM IDENTIFICATION

Absorption Spectra of Important Gemstones



Chrysoberyl — intense yellow-green ★ ★ ★

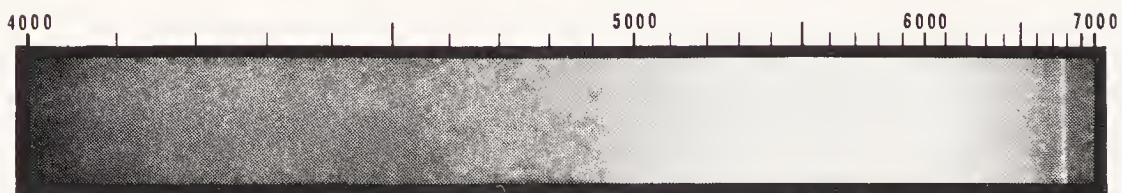

Chrysoberyl — rare, very light-green stone



Chrysoberyl — rich brown ★ ★



Corundum — Ruby and synthetic ruby, purple sapphire and dark padparadscha (direct transmitted light) ★ ★ ★



Corundum — ruby and synthetic ruby, purple sapphire and dark padparadscha (scattered light) ★ ★ ★



Demantoid — ordinary yellowish green ★ ★ ★



The Spectroscope

Absorption Spectra of Important Gemstones



Demantoid — very rich green ★ ★ ★

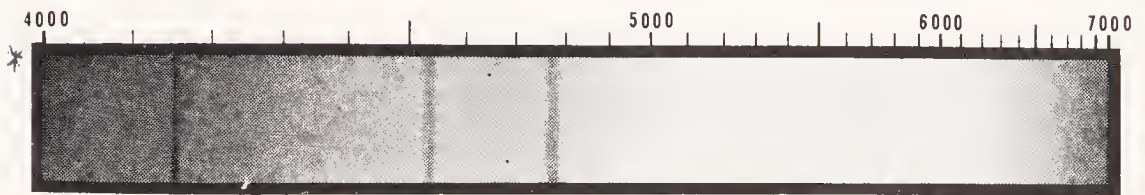

Diamond — pale yellow (cape spectrum) ★ ★



Diamond — brown (shows green in transmitted light) ★

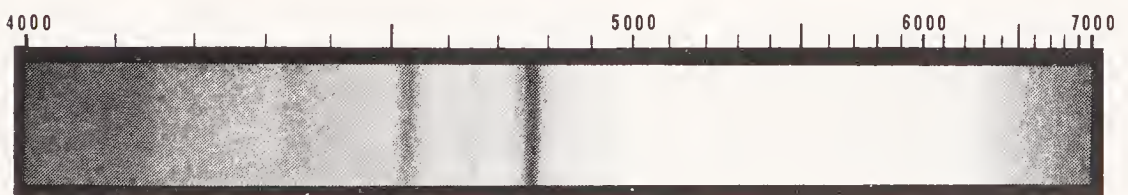

Diamond — intense yellow (rich cope) ★ ★

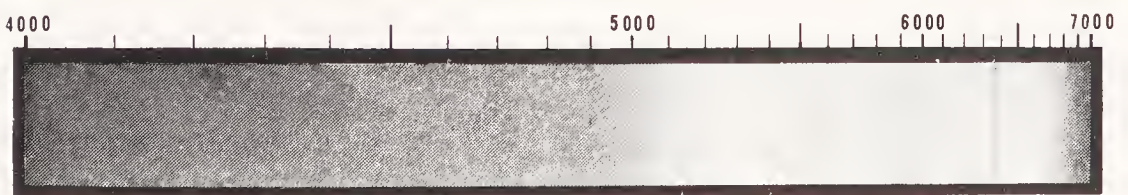

Diamond — treated pink (orange fluorescence). Line of 5700 Å is a fluorescent line ★ ★ ★

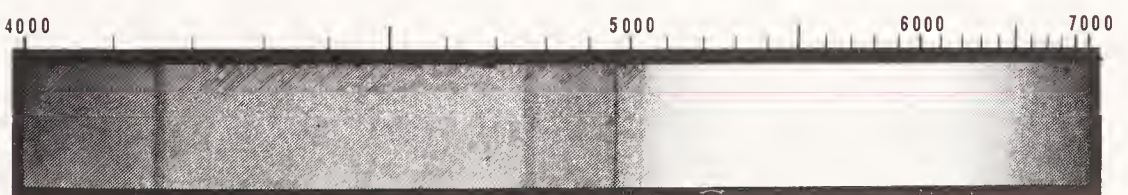

Diamond — treated yellow, yellow-green, light brown and some blue (maximum transmitted light) ★ ★ ★



HANDBOOK OF GEM IDENTIFICATION

Absorption Spectra of Important Gemstones



Diamond — treated yellow-brown, yellow, black, if any light can be transmitted (diffused transmitted light) ★ ★ ★



Emerald — medium green (random orientation) ★ ★ ★



Emerald — synthetic and natural (optic-axis direction) ★ ★ ★



Emerald — synthetic and natural (ordinary ray) ★ ★ ★



Emerald — synthetic and natural (extraordinary ray) ★ ★ ★



Grossularite — green, R.I. 1.72 or higher ★ ★



The Spectroscope

Absorption Spectra of Important Gemstones



Hessonite — (rarely this pronounced; often not visible) ★



Jadeite — intense emerald green ★ ★



Jadeite — very dark green ★ ★



Jadeite — very dark green "Yunnon" jade. Thin edge, strong transmitted light



Jadeite — any translucent color except green ★ ★



Jadeite — medium chrome green ★ ★ ★



HANDBOOK OF GEM IDENTIFICATION

Absorption Spectra of Important Gemstones



Jadeite and serpentine — intense dyed green ★ ★



Jadeite — dyed green (faded to light green to greenish blue) ★ ★



Nephrite — intense green (thin pieces, transmitted light only) ★



Orthoclase — yellow ★ ★



Pearl — red-brown to black conchiolin from shell edge of *Pinctodo Mortensii*



Pearl — red-brown to black conchiolin from shell edge of block pearl-bearing mollusc (species undetermined)

— VIOLET — | V B | — BLUE — | B G | — GREEN | Y G | Y | O | — RED —

The Spectroscope

Absorption Spectra of Important Gemstones

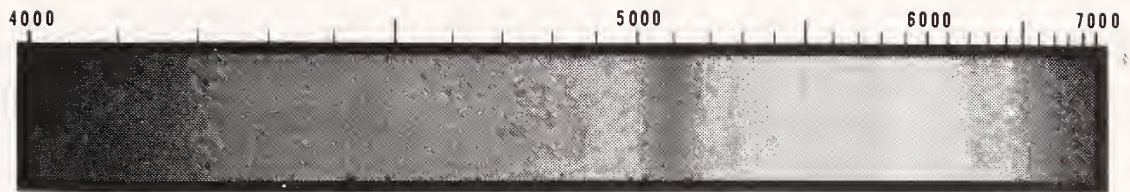

Pearl — light-gray to black pearls showing pink fluorescence (through which powerful beam is visible) ★ ★



Pearl — red-fluorescent black pearls (specimens that transmit only a small amount of brownish-red light at the edges) ★ ★

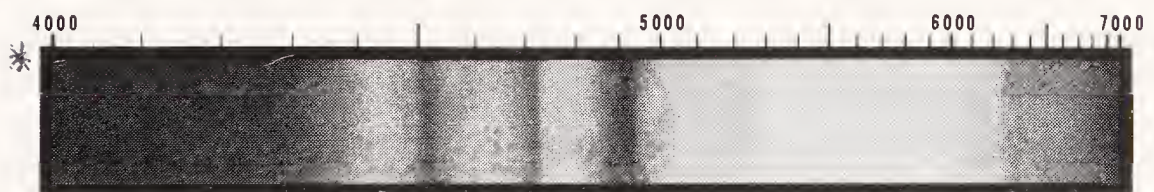

Peridot — large or very dark-colored stones ★ ★ ★



Peridot — small or light-colored stones ★ ★

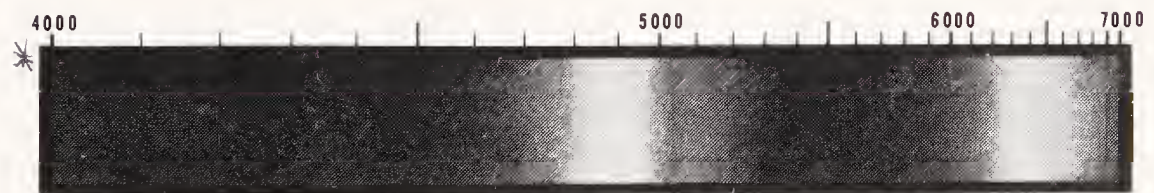

Pyrope — chrome type ★ ★



Quartz — green aventurine ★ ★

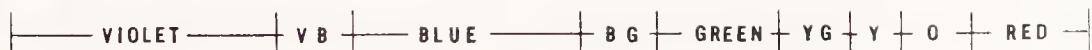

HANDBOOK OF GEM IDENTIFICATION

Absorption Spectra of Important Gemstones



Rutile — synthetic yellow and blue ★ ★



Sapphire — blue ★ ★



Sapphire — dark blue, green, Australian yellow ★ ★ ★



Sapphire — natural and synthetic orange, purple, darkest tone of pink ★ ★



Sapphire — pale pink, orange, lavender, violet-blue; and pale synthetic or natural chrome-bearing carundum ★ ★



Sapphire — synthetic green "imitation-emerald" color (5300 Å missing in same) ★



The Spectroscope

Absorption Spectra of Important Gemstones



Sapphire — synthetic alexandrite-like type ★

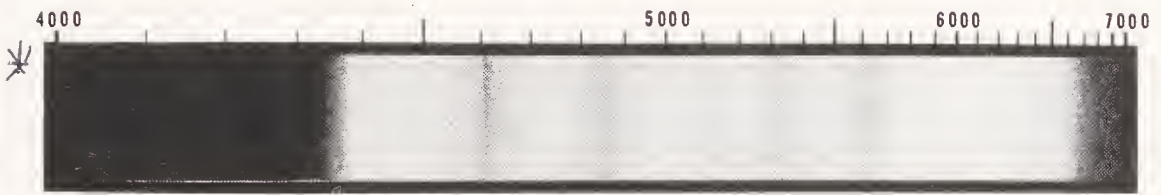

Spessartite — light orange, Amelia Court House type ★ ★ ★

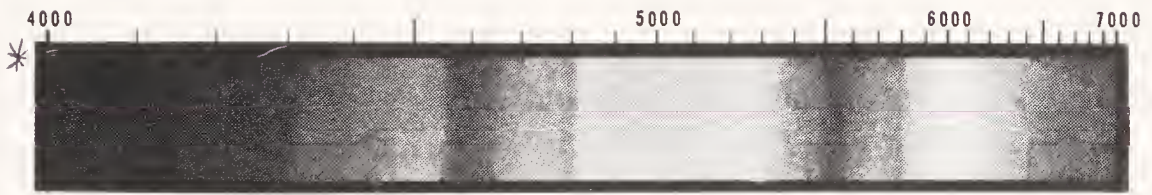

Spinel — dark blue stones, including gahnospinel ★ ★ ★



Spinel — highly fluorescent red, pink and orange stones ★ ★



Spinel — light blue and violet ★ ★

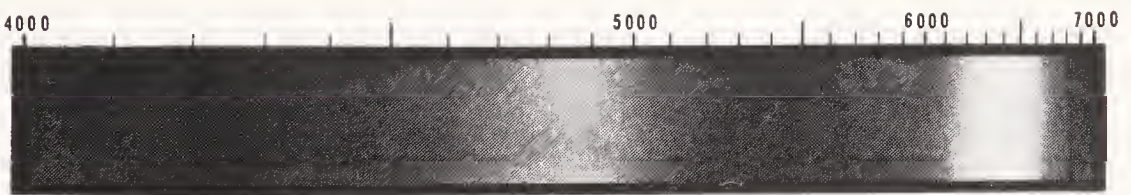

Spinel — nonfluorescent garnet-red stones ★ ★



HANDBOOK OF GEM IDENTIFICATION

Absorption Spectra of Important Gemstones

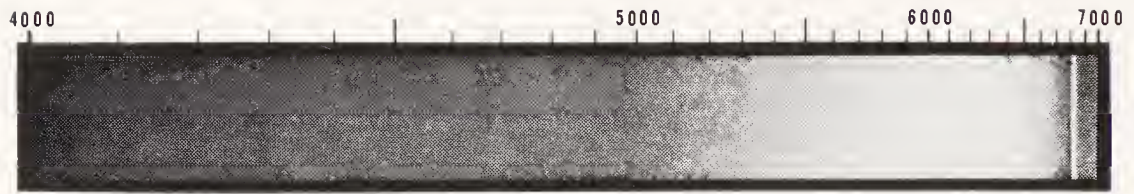

Spinel — synthetic red (.10-carat Verneuil stone) ✱ ✱

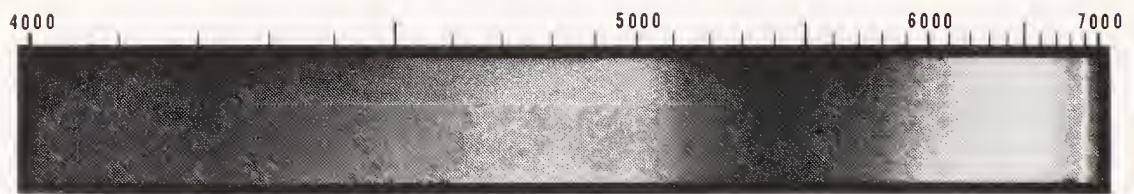

Spinel — synthetic red (.50-carat Verneuil stone) ✱ ✱

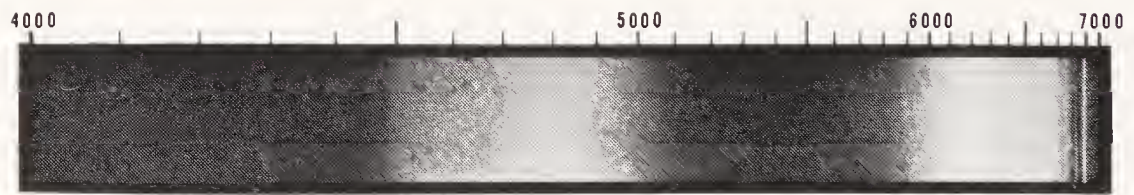

Spinel — synthetic red (hydrathermal)



Spinel — synthetic alexandrite-like



Spinel — synthetic lapis-lazuli imitation (reflected light) ✱ ✱



Spinel — synthetic pale blue (no manganese) ✱



The Spectroscope

Absorption Spectra of Important Gemstones



Spinel — synthetic pink ★



Spinel — synthetic dark blue ★ ★ ★



Spinel — synthetic green; yellow fluorescence ★ ★



Spinel — synthetic greenish blue (aquamarine color) ★ ★



Spodumene — yellow-green ★ ★



Topaz — darkest tone of pink to light purplish red



HANDBOOK OF GEM IDENTIFICATION

Absorption Spectra of Important Gemstones



Tourmaline — Ceylan brown and ordinary ray of dark green and dark blue ★



Tourmaline — dark green and blue (extraordinary ray) ★ ★

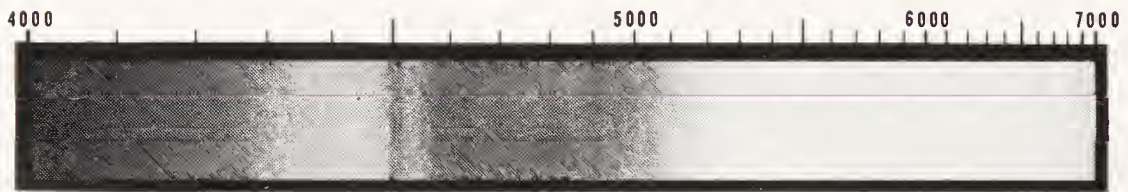

Tourmaline — dark purple-red (orange ray) ★ ★



Tourmaline — dark purple-red (purple ray) ★ ★



Tourmaline — red, brownish red, and darkest tone of pink ★ ★

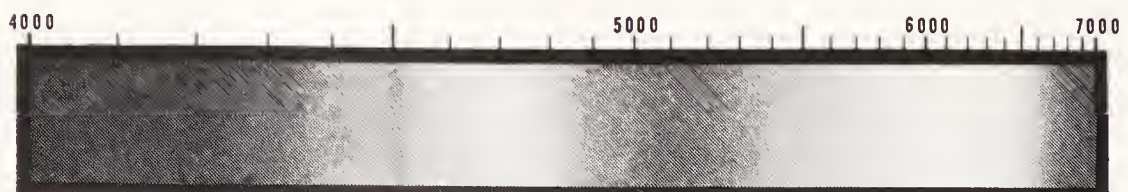

Tourmaline — lighter pink ★



The Spectroscope

Absorption Spectra of Important Gemstones



Turquoise — good color (reflected light) ★ ★

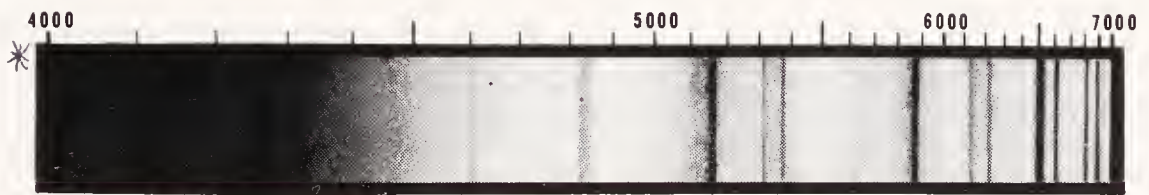

Zircon — Burma (extraordinary ray) ★ ★

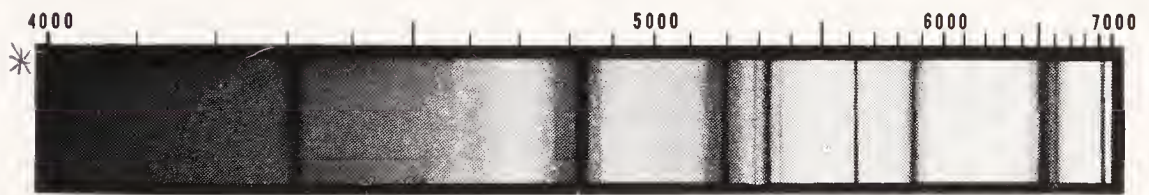

Zircon — Burma (ordinary ray) ★ ★



Zircon — heat-treated blue and white (some have fewer, some more of the typical bands seen in Ceylan stones) ★



Zircon — normal Ceylon type (random orientation) ★ ★

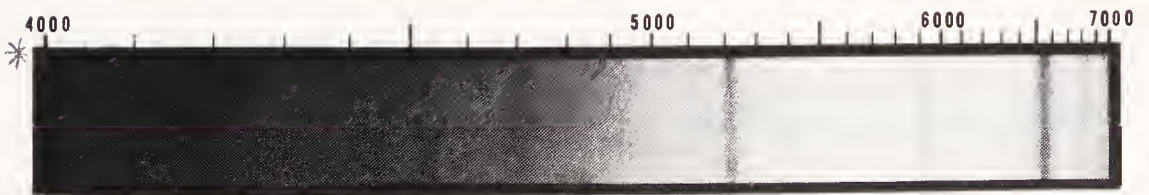

Zircon — normal gamma type ★ ★



HANDBOOK OF GEM IDENTIFICATION

Absorption Spectra of Less Important Gemstones

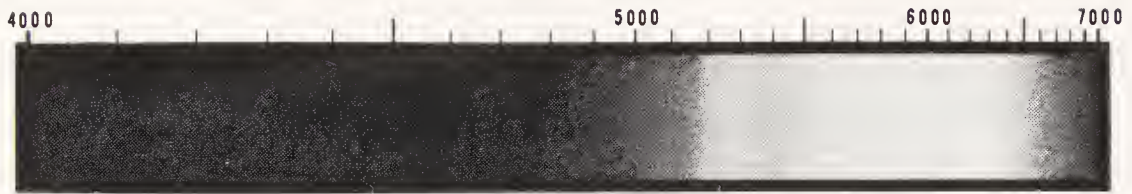

Actinolite — transparent crystal



Apatite — yellow, green and colorless ★ ★ ★
★ ★ ★



Axinite — transparent ★ ★



Diopase ★



Diopside — ordinary green and brown ★



Diopside — chrome type ★ ★



The Spectroscope

Absorption Spectra of Less Important Gemstones

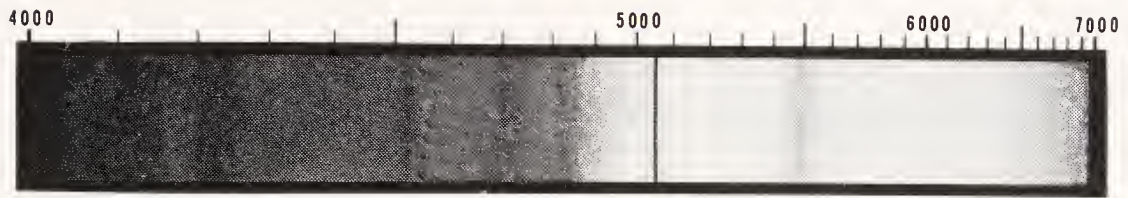

Enstatite — brown ★ ★ ★



Enstatite — green ★ ★ ★

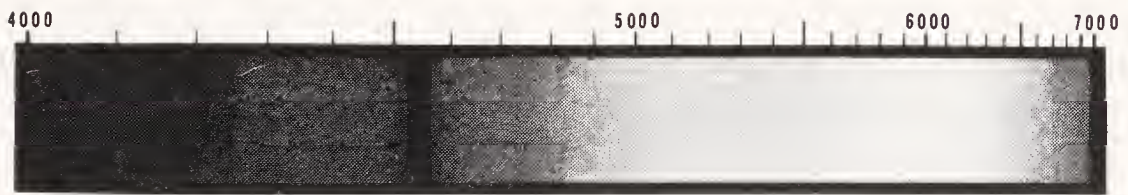

Epidote ★ ★

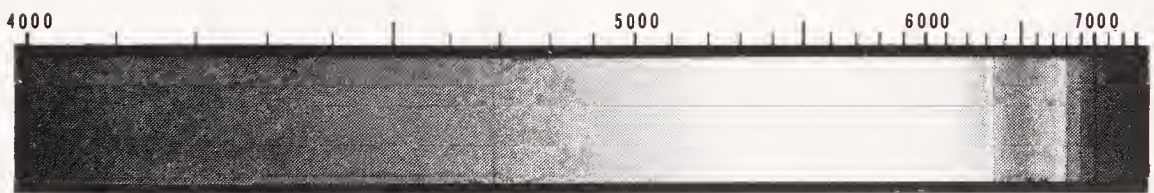

Euclase — greenish blue ★ ★



Fluorite — green (large or very dark pieces only) ★



Gahnite ★ ★ ★



HANDBOOK OF GEM IDENTIFICATION

Absorption Spectra of Less Important Gemstones



Grossularite — pink (xalactacite) ★



Idocrase — variety californite ★ ★ ★

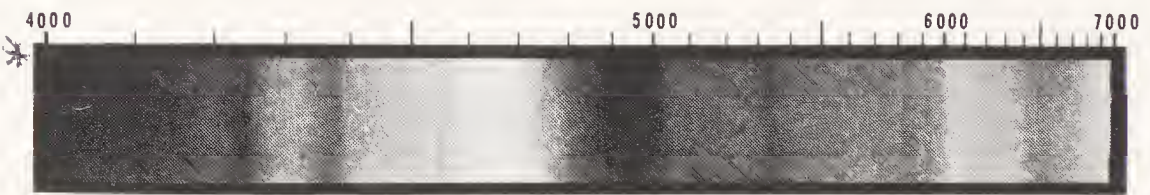

Iolite — large crystal (violet ray) ★

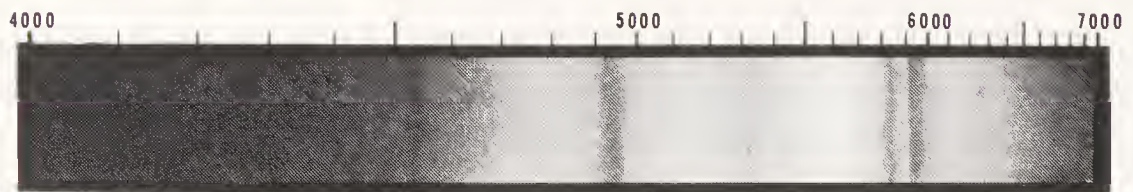

Iolite — large crystal (yellow ray) ★



Iolite — small faceted stone ★



Kornerupine — brown Burma stone (gamma ray) ★ ★



The Spectroscope

Absorption Spectra of Less Important Gemstones



Komerupine — brawn Burma stane (beta ray) ★ ★



Kyanite — green and same blue; others shaw nathing ★ ★



Rhodochrosite — translucent stane

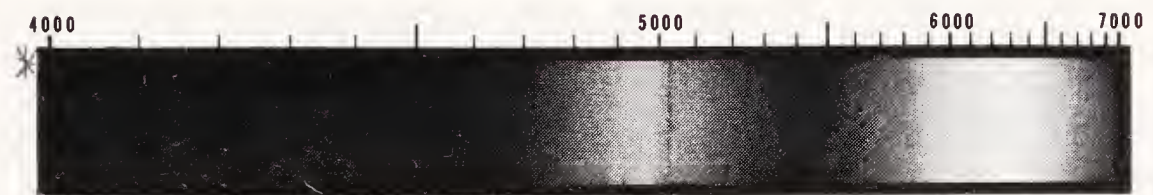

Rhodonite — semitranslucent stane



Serpentine — (bawenite) chrame bearing, bright green ★



Serpentine — translucent dark green (cantains black chramite actahedra) ★



HANDBOOK OF GEM IDENTIFICATION

Absorption Spectra of Less Important Gemstones



Sihalite ✱ ✱



Sodalite — (strong transmitted light only) ✱



Sphalerite — (specimens with a greenish cast show this best) ✱ ✱



Thulite — bright, light red (transmitted light) ✱



Variscite — translucent green (strong transmitted light)

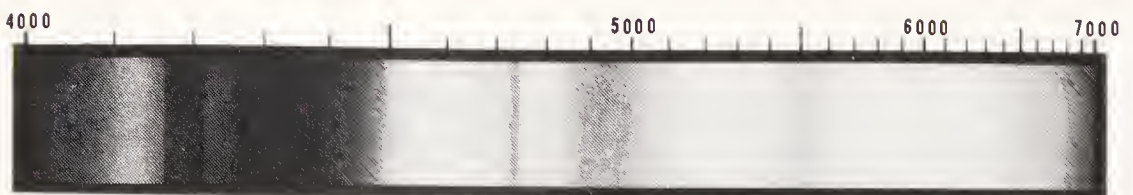

Willemite ✱ ✱ ✱



The Spectroscope

Absorption Spectra of Less Important Gemstones

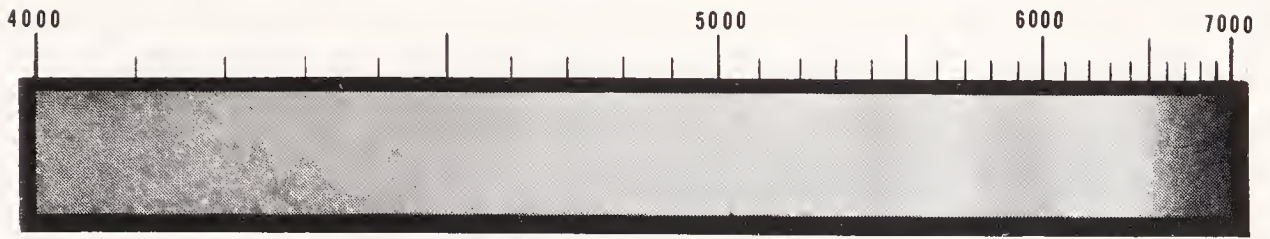

Zoisite — transparent blue (blue direction) ★ ★

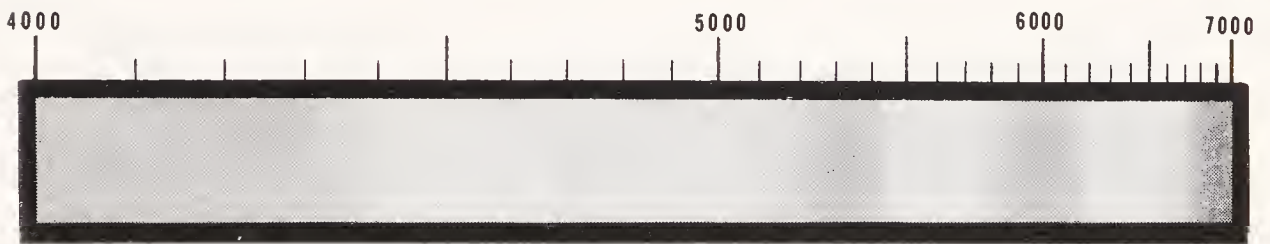

Zoisite — transparent blue (nondirectional) ★ ★

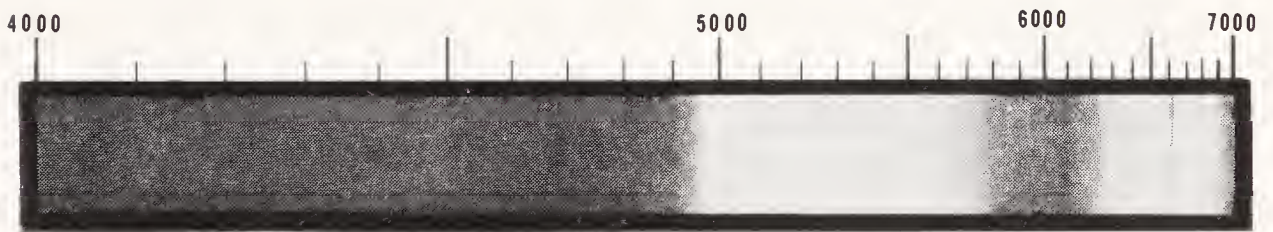

Synthetic garnet — intense green ★ ★ ★



Synthetic garnet — light bluish green ★ ★ ★



Chrome chalcedony — intense green ★ ★



HANDBOOK OF GEM IDENTIFICATION

Additional Absorption Spectra

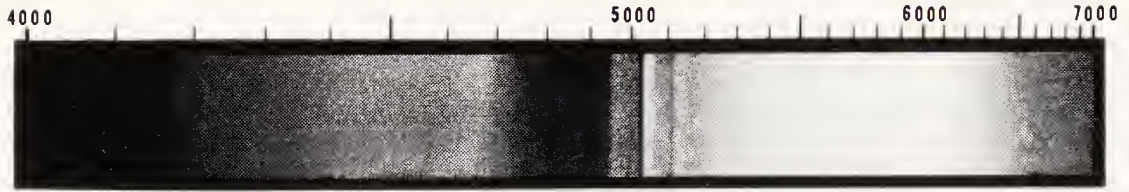

Diamond — bright yellow, natural color — fluoresces intense yellow-green ★ ★

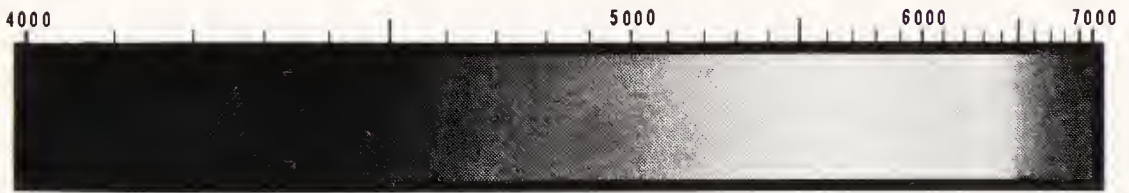

Diamond — dark greenish brown; orange fluorescence under short wave U.V. ★ ★



Grossularite — pink (hydrogrossular) (with some idocrase) ★ ★



Grossularite — green, R.I. below 1.72 (hydrogrossular) (with some idocrase) ★ ★



Jadeite — some dyed lavender; fluoresces pink ★ ★

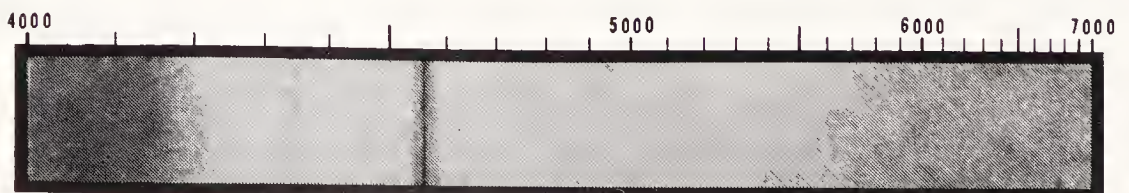

Zoisite — yellow ★ ★ ★



Chapter XIV

Altered Stones and Ancillary Tests

Often just identifying a gemstone is not enough. Frequently natural stones are altered in a manner that may have an important bearing on their value. Consumers may be defrauded when a natural stone is treated in some fashion to improve its appearance and apparent quality without disclosure.

There are many different methods by which the appearance of gemstones could be changed so as to have an obvious effect on their value. Opal may be impregnated with plastic of a dark color that suggests black opal, and white opal may be subjected to smoke treatment or sugar treatment to make it appear black. Each process adds materially to apparent value. There are many other means of enhancing the apparent value of gem materials that should be detected by an appraiser or one identifying gemstones.

For millenia, people have treated stones to improve their color. Amethyst has been changed to citrine by heating—almost as long as amethyst has been known to mankind. Likewise, green beryls owing their color to iron are heated to improve color, a change from green to aquamarine blue.

Heat treatment which is not reversible by any ordinary means has long been disregarded, because nothing has been done to the stone except to heat it. There are, however, a number of treatments which greatly improve appearance, but which are regarded in the industry as fraudulent (unless revealed to the buyer). Among those commonly

HANDBOOK OF GEM IDENTIFICATION

seen are dyeing, coating, impregnation with plastic or wax, oiling, irradiation by ultraviolet, irradiation by radioactive isotopes, irradiation by cyclotron, irradiation by Van de Graff accelerator and irradiation by fast neutrons in a nuclear reactor. Another means of deception is the use of foil to back stones to create the illusion of a stone of greater size or reflectivity or to provide color.

One of the earliest means of improving appearance was the use of dye. Chalcedony has been dyed black for generations and, in addition, has been dyed to a variety of different colors. The so-called "black onyx" or dyed black chalcedony, is made by immersing a relatively porous chalcedony in a sugar solution for a prolonged period and then carbonizing the sugar with sulfuric acid. This same method is used to blacken opal. Usually only certain relatively low grades of opal are subjected to this sugar treatment. Aniline dyes are used to create other colors in opal or chalcedony such as blue, green, red and others. Quartz, particularly quartzite, is dyed red or green to imitate low grade ruby or green jadeite. Low-grade sapphire is dyed to make it appear like ruby. Sometimes a sapphire-blue dye is used in cracks in the material to make the stone appear of higher quality. Other materials that are dyed frequently include lapis-lazuli, onyx marble, jadeite, nephrite, serpentine, cultured pearls and mother-of-pearl. Usually the dye is used on whitish spots in lapis-lazuli to make the color more even; and the onyx marble form of calcite is dyed to resemble jade and other materials as well.

Jadeite, nephrite and serpentine are dyed to give colors comparable to Imperial quality jadeite. Cultured and natural pearls are dyed black by various means. Cultured pearls are also dyed blue and some are given a rose appearance by the use of dyes. Fresh water cultured pearls are dyed to a variety of colors.

Diamonds are also occasionally made to appear much more valuable than their intrinsic nature would suggest, by coating the pavilion of the stone with a substance that masks its body color. This tends to make the diamond appear nearly colorless, when actually it is what would be regarded by a diamond man as an off color of little value. This process, which is called coating, is detected by an examination of the near-girdle pavilion surface of the stone, using a combination of

overhead and diffused dark-field illumination, plus high magnification. Under such lighting, it is possible to detect the coating, which is almost always applied to the surface of the pavilion and usually at or near the girdle. Such a coating usually appears to be bluish in transmitted light, and yellowish with a semimetallic appearance when examined with the overhead light source. Often, it is visible only under high magnification of 30x or more. Those who are familiar with this form of fraud are schooled to detect it less by the appearance of the stone under high magnification, than by the fact that when it is placed in a neutral color-grading environment it takes on a hue unlike that of a naturally colored diamond. The stone tends to take on a greenish cast and to appear gray, unlike the color a grader expects from any naturally colored diamond. Whenever this appearance is encountered in color grading, the grader should immediately become suspicious of artificial coloration. See illustrations for examples of the appearance of coated diamonds under high magnification.

Another frequently encountered form of fraudulent color improvement is that in which jadeite is dyed to impart a rich green color to the material. In this process, jadeite that has a porosity sufficient to accept a dyestuff is color-enhanced, usually in the Orient. Such material takes on a color that makes it seem to be considerably more valuable than its actual body color would merit. Unfortunately, this type of treatment is rather difficult to detect by ordinary means. Perhaps the most dependable means available to one using careful inspection only is a “sugary” appearance that the treated jade assumes to the experienced observer. The dyestuffs are usually concentrated in minute hairline joints between adjacent grains of jadeite, and this may appear suspiciously different from naturally colored jadeite to the gemologist. However, the one safe and sure means of distinguishing between the two is furnished by the use of the spectroscope. Dyed jadeite shows a strong absorption band from approximately 6300 to 6700Å, in contrast to the natural, which demonstrates the typical three stair-step absorption bands at 6300, 6600 and 6900Å. Although deeply colored natural jadeite may show a general absorption in the area of the dye absorption band, the three stair-step lines may always be resolved by rotating the stone and allowing sufficient

Figure 132
Color-enhanced jadeite. The coloring agent appears as an arc of gray at the left side of the opening.



light to pass through it to make it possible to analyze the transmitted light effectively.

Another form of jadeite treatment that is less frequently encountered is that in which a very transparent piece of near-white jadeite is backed with a green substance. Because of the transparency of the light-colored jade used in this type of fraud, the green backing imparts a green color that seems to be evenly distributed in the stone. This can usually be detected by a very careful inspection of the mounted piece to detect the coloring agent, which is coated either directly on the back of the piece or on the metal behind it. Usually, the gemologist tends to suspect a situation of this type because of the nature of the mounting, and the fact that there is a space between metal and stone in which a coloring agent could be hidden. This is sometimes made less obvious by having an opening at the back of the mounting, which would make an unwary tester assume that no coloration could have been attempted. It is well to inspect the sides of the opening behind the stone to see if any coloring agent has been concealed around the periphery of the opening. Removing the stone to permit inspection of the mounting eliminates any remaining doubt. (See illustration.)

A three-piece assembled jadeite, employing a rich-green coloring agent, is described in Chapter XI.

Very dense white opal, and opal matrix almost entirely lacking in transparency is blackened and given a striking play of color artificially. Such material is subjected to the same type of treatment as that given to agate in the production of black onyx. The material is “cooked” in a sugar solution for a prolonged period—often several days—and then given an acid treatment that carbonizes the sugar. The dark background shows off the near-surface play of color much better than a white background, and leaves an appearance deceptively like that of regular black opal. However, there is a characteristic appearance to the very fragmented play of color and under magnification, many tiny black spots never seen in untreated opal give away the deception. This treatment tends to mask the normally strong fluorescence of opal under long wave ultra-violet light. This, too, may be regarded as a characteristic of treated opal.

Colorless to pale-green or blue beryl is often backed by a vivid green substance to simulate emerald. Bright light reflected from a gypsy-set emerald will show an emerald absorption spectrum. It should also show dichroism. A coated back will fail to show either. Sometimes the coloring agent becomes detached from the pavilion and is seen as a white spot in an otherwise green reflection, when viewed from above. (See illustration.)

In recent years, rubies and sapphires have been heated to very high temperatures to remove silk and, in the case of sapphires, thereby to enhance color. Thai dealers first bought dark Australian rough sapphires and improved the color by heating to a very high temperature and more recently have been buying cloudy material from Sri Lanka, much of it gray or white in body color. Since the needles that have caused the cloudiness are rutile, the titanium is taken back into the lattice through heating and causes the color to turn to blue. It is also possible that the heating is done in the presence of both iron and titanium oxide in powder form, which at high enough temperatures could migrate into the lattice and cause a blue color.

In Burma, rubies that are cloudy because of excessive silk have been made much more transparent and more attractive by heating to

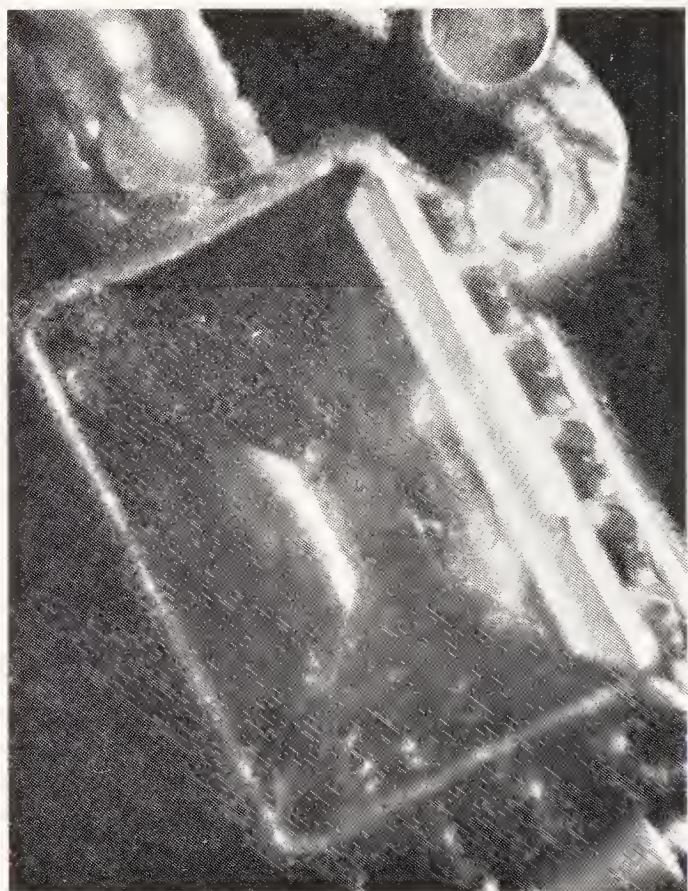

Figure 133

A pale area at the culet and pale spots at the upper left corner show where green dye is no longer evident in a dye-backed emerald.

the point where the rutile needles are absorbed and then cooling quickly enough to prevent their re-crystallizing as rutile needles.

Synthetic Coatings on Sapphires. Recently, our laboratories have encountered sapphires, the first of a brilliant orange, and later other colors, that have a surface coating that fluoresces, whereas the body of the stone does not. Apparently this is the result of heating natural sapphires close to the melting point in powdered oxides chosen to impart color by migration of atoms of the surrounding powder into the corundum lattice.

Plastic Impregnated Opal. In 1978 a new alteration of natural opal appeared on the market in the form of opal impregnated by plastic. Very porous, non-transparent white Brazilian opal of very poor quality was used for the plastic impregnation.

The product usually resembles black opal of excellent quality. It is often more transparent than Australian black opal, but not always; some is nearly opaque. It tends to have what appears to be black fingerprints or wisps throughout the stone. The refractive index tends to be just slightly low, but the specific gravity is usually much

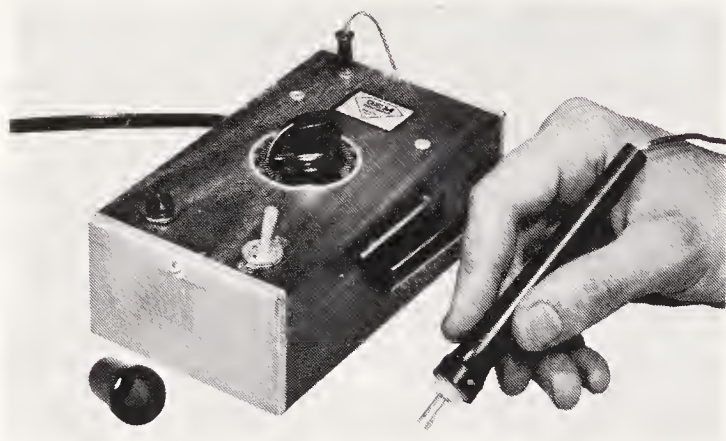

GIA Thermal Reaction Tester.

below that of comparable black opal. The impregnated material is usually well below 2.0; most tested in GIA laboratories have a specific gravity of near 1.89.

The Value of the Hot Point. Perhaps the most frequently adulterated gemstone encountered by the gemologist is turquoise. Although fine, dense gem turquoise is almost unknown today, the great demand for this lovely gem has led to the increasingly frequent use of chalklike material that is actually turquoise, but that is far from gem quality. Pale-blue, chalky material may be made to resemble fine turquoise in several ways. If it is heated in a bath of paraffin, pale-blue, porous turquoise absorbs the waxy fluid, assuming a much deeper and richer blue color that one associates with very fine gem turquoise.

There are two methods of detecting natural material that has been paraffin treated. If an electrically heated hot point, such as that used on a wax modelling device, is brought within approximately one-half to one millimeter of the surface of the treated material while the surface is being examined under high magnification, a noticeable sweating may be seen. The heat causes the paraffin to melt at the surface of the turquoise. This test can be applied without damaging the stone in any way, yet the treatment is quickly detected. The possibility of treatment is suggested by a speckled, slightly sugary appearance of the surface when viewed under low magnification. Rich-blue turquoise that is untreated has a specific gravity in excess of 2.65. Most of the powdery material that is used for either paraffin

HANDBOOK OF GEM IDENTIFICATION

or plastic treatment is considerably lower in specific gravity (2.3 to 2.5). If a specific-gravity test shows that a turquoise has a specific gravity below 2.60 and has a rich-blue color, some form of treatment is almost a certainty.

Plastic impregnation under high pressure of the chalky form of turquoise yields a permanently improved color that is also detectable with the use of a hot point. If one becomes familiar with the odors of various plastics, a hot point touched against the surface of the plastic-impregnated turquoise reveals the acrid odor emitted from it. Unfortunately, this test is of little value to one who does not have an excellent sense of smell. In contrast to the use of a hot point against pure plastic, plastic-impregnated turquoise does not emit a strong odor. Nevertheless, to one who becomes accustomed to the use of the hot point and the detection of odors resulting from a light touch of the red-hot point against the impregnated material, this is a very revealing test. For best results, it is suggested that turquoise known to

Figure A
Plastic-coated turquoise
showing tiny threads from
the applicator

Photo by G.I.A.

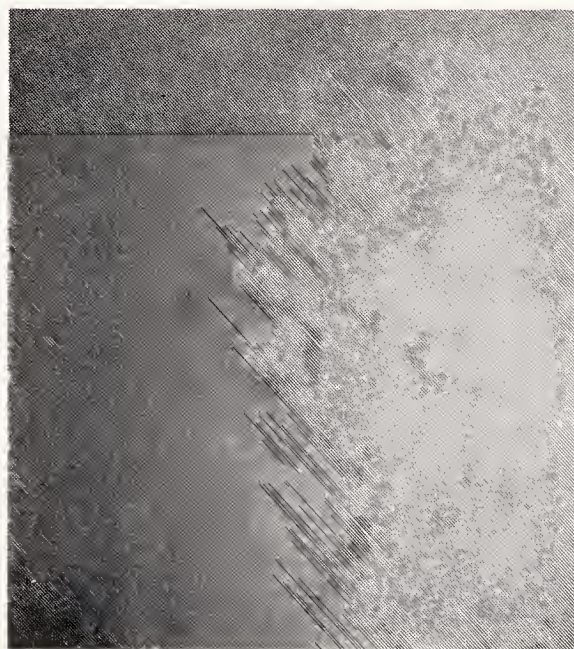

Photo by G.I.A.

Figure B
Cracks in the coating of a
plastic-coated turquoise

have been plastic impregnated be kept on hand for comparison purposes, to facilitate the comparison with unknown material encountered in this test.

The most common substitute for turquoise is the very pale-blue chalky kind that has been covered with a thin, blue plastic coating. The coating usually shows tiny threads from the applicator (*Figure A*), and cracks in the coating are common (*Figure B*). The S.G. is likely to be well below 2.62, the level of the quartz-chalcedony liquid.

An electrically heated hot point serves several other purposes. Frequently, one encounters imitations of amber, particularly in carvings probably originating in China. Imitations of amber from that area are principally of two forms: (1) the so-called Chinese amber and (2) a commercial plastic of the Bakelite variety. Chinese amber apparently is made up of a variety of shellacs and perhaps even some natural resins. In any event, it is an imitation material, and its properties differ distinctly from those of amber. It would be possible to distinguish large carvings of this material from similar carvings of amber by specific gravity. Although it may be impractical to use a specific-gravity test when the carving is many inches tall, a saturated salt solution is easy to prepare and it separates amber from plastic.

It is always possible to find some unexposed portion of such a carving to which the application of a hot point can be made without in any way deforming or harming the carving. When this is done, the typical odor of amber, as against that of a plastic or Chinese amber, is very revealing and immediately identifies the material. The hot point applied to amber yields a puff of smoke and a very distinct resinous odor, whereas, when applied to an imitation, the result is a distinctly acrid odor with no hint of the resinous amber odor. Both Chinese amber and Bakelite give refractive-index readings in the 1.60-1.66 range—far above the 1.54 of natural amber.

Tortoise shell gives off an odor of burnt hair to the hot point, as do some other natural organic materials—in contrast to the acrid odors of plastics. Jet has a coallike odor, but some substitutes have a hairlike odor similar to that of tortoise shell.

Acids and Solvents. Acids, particularly a dilute hydrochloric acid, is of great value in testing. It serves a variety of purposes. For

HANDBOOK OF GEM IDENTIFICATION

example, any of the carbonates, such as calcite, which when dyed is used as an imitation jade (the so-called Mexican jade), coral, shell, pearl, smithsonite, malachite and rhodochrosite, are revealed by pronounced effervescence when a drop of dilute hydrochloric acid is placed on the surface. On malachite and azurite, copper carbonates, the spot turns yellow-green. Caution: Since the hydrochloric acid attacks the surface of any carbonate quickly and strongly, it should be wiped off after the slightest touch and the spot quickly washed with water.

Hydrochloric acid also serves as an excellent test for lazurite, or lapis-lazuli, because it yields a distinct rotten-eggs odor when applied to the natural material. This test, developed in the G.I.A. laboratories, is a sure test for lapis-lazuli.

Lapis is often dyed to deepen or even the color. If fingernail-polish remover is used to soak a swab, and the swab rubbed against dyed material, a faint bluish stain indicates dye.

Howlite, a hydrous calcium borosilicate, is dyed blue to resemble turquoise. A drop of hydrochloric acid attacks howlite, and leaves a dull spot that distinguishes the substitute from turquoise.

Cultured and natural pearls are dyed black by various methods, some of which leave a surface stain that is detectable with an acid-dipped swab. For this test nitric acid is diluted to a solution of one part acid to twenty of water. A swab dipped in the solution and then rubbed against the pearl shows a faint dark stain, if the pearl has been dyed by a surface treatment. (See Chapter XII.)

Magnetism. A few gemstones containing significant amounts of iron are measurably magnetic, even though the strength is considerably less than the amount required to permit the usual hand magnet to pick up a stone. If a thread is used to suspend a stone, a one-inch Alnico magnet will cause iron-rich gems to turn or pull off plumb toward the magnet. Almandite, spessartite, hematite, rhodonite and rhodochrosite all show this reaction strongly. Hemetine is often picked up by the magnet—but never hematite.

B. W. Anderson of the London Laboratory suggested a specific means of measuring magnetic strength by the use of a diamond

balance.* He suggests the placement of the gem on a light-weight, nonmagnetic pedestal, such as cork, to raise it appreciably from the pan. The pedestal is weighed and the combination of stone and pedestal. Then using the small magnet just above the stone, the loss in apparent weight is determined to arrive at a magnetism factor. Anderson used the formula

$$\frac{\text{Weight loss} \times 100}{\sqrt{\text{weight}}}$$

His figures varied from a 290-410 for almandite to 10-20 for green tourmaline. Each of these is attracted toward a magnet when suspended by a thread. Any gem containing iron as an essential constituent is so attracted.

Differential Thermal Conductivity. Diamond is used in electronic equipment as a heat-sink because of its phenomenal thermal conductivity. The Ceres Diamond Probe was designed to take advantage of this difference and forms an effective instrument to distinguish diamond from its substitutes. None of the diamond substitutes has a thermal conductivity even approaching that of diamond. Since the Ceres Probe was announced, there have been several other instruments using the same principle with slightly different approaches; these include one made by Kashan, the synthetic ruby producer; another by a firm in New Zealand and another that is offered by Gem Instruments, the GIA subsidiary.

*Gem Testing, by B. W. Anderson, 9th Edition, pages 336-338.

Chapter XV

Instruments Essential to Gem Testing

Success in gem testing is dependent on two factors: (1) experience and skill in instrument use, and (2) adequacy of equipment. It is possible to make an occasional identification by eye alone, but only in exceptional circumstances such as the detection of a garnet-and-glass doublet by the large difference in luster between its two portions. For the vast majority of gem identifications made by the jeweler, several gem testing instruments are essential. The ideal laboratory would contain every instrument that can aid in identification, no matter how seldom certain specialized equipment might be used. However, the expense of outfitting such a laboratory is prohibitive. In planning a gem testing laboratory, the average jeweler must weigh effectiveness against cost before deciding what instruments are essential for his purposes.

Three determinations are necessary in almost every identification: (1) refractive index, (2) single or double refraction, and (3) the shape of inclusions (to decide between synthetic and natural origin). The instruments discussed below are those which are most practical for use in making the three essential determinations. Since two other tests, specific gravity and an analysis of the absorption spectrum, are often necessary, the most practical instrumentation for these is also discussed.

The Refractometer. *Refractive index* is most easily determined by use of the gem refractometer. The refractometer also may be used to determine birefringence, optic character, and occasionally optic sign. Although the refractometer is by far the most practical method of determining refractive index, others may be substituted

Instruments Essential to Gem Testing



Figure 134

The Duplex II Refractometer.

if the necessary equipment is available. Other methods were discussed in Chapter V.

Since the determination of refractive index is required in the large majority of identifications, the practical and relatively inexpensive refractometer is essential to the gemologist.

The Polariscope. The most practical instrument available for use in distinguishing between single and double refraction is the polariscope.¹ The polariscope is also used to detect pleochroism and optic character.

Although its accuracy is questionable, the reflection test (Chapter VI) is often used in distinguishing between single and double refraction.

1. Gem Instrument Corporation, Santa Monica.



Figure 135

The Gem polariscope in use.

Magnifiers. Probably the most important instrument in gem identification is a good magnifier, combined with a light source designed for effective illumination of the interior of transparent gemstones. There are four such instruments currently available. The first of its type in this field, the Diamondscope, is an American Gem Society product. The Gemolite, Diamond Grader and Gem Detector are binocular microscopes with built-in illuminators available from the Gem Instruments Corporation.

The Spectroscope. Prism spectrosopes are available from small hand units up to large models. Hand models without scales usually are inexpensive and table spectrometers are in the price range of gem binocular microscopes. A complete unit employing a high-intensity lamp on a flexible arm that permits either transmission or reflection, a prism to reduce the heat on the specimen, an iris diaphragm to act as a light shield of variable size, and a Beck wave-length model hand spectroscope mounted on a moveable arm, is available.

Instruments Essential to Gem Testing

Specific Gravity Determination. A fifth test upon which the gemologist must often depend is the determination of specific gravity. The most practical of the many means of specific gravity determination is the use of the diamond balance with attachments that permit the weighing of the gem in a liquid. Since the diamond balance is standard equipment in the average jewelry store, and the attachments necessary for specific gravity determination are inexpensive or easily constructed, this method is the most practical for the jeweler. Liquids of high density are excellent for rapid determination. Their value is not limited by the fact that few satisfactory liquids are readily available, since it is possible to prepare liquids of intermediate value by mixing two such liquids, providing the two are miscible in all proportions. Heavy liquids permit determinations on tiny stones on which reliable results are not possible on the standard diamond balance.

LESS FREQUENTLY USED GEM TESTING INSTRUMENTS.

The *dichroscope* is a small instrument used for the determination of pleochroism. The value of the dichroscope is limited since its use is confined to the determination of pleochroism. The presence of pleochroism is proof of double refraction, but its absence is NOT proof of single refraction—especially in the light colored stones.

The Gemological Microscope. The polarizing microscope with the changes necessary for the examination of gemstones is an instrument that may be used for a number of tests, but it is cumbersome and not as well adapted to the testing of gemstones as are the binocular Gemolite, polariscope, and refractometer, the individual instruments which perform tests it may be used to duplicate. The gemological microscope, an expensive instrument, requires training and practice to be used effectively and its use for most tests is more time-consuming than that of the instruments designed especially for gem identification. It may be used for the determination of refractive index, optic character, and pleochroism, as well as for magnification.

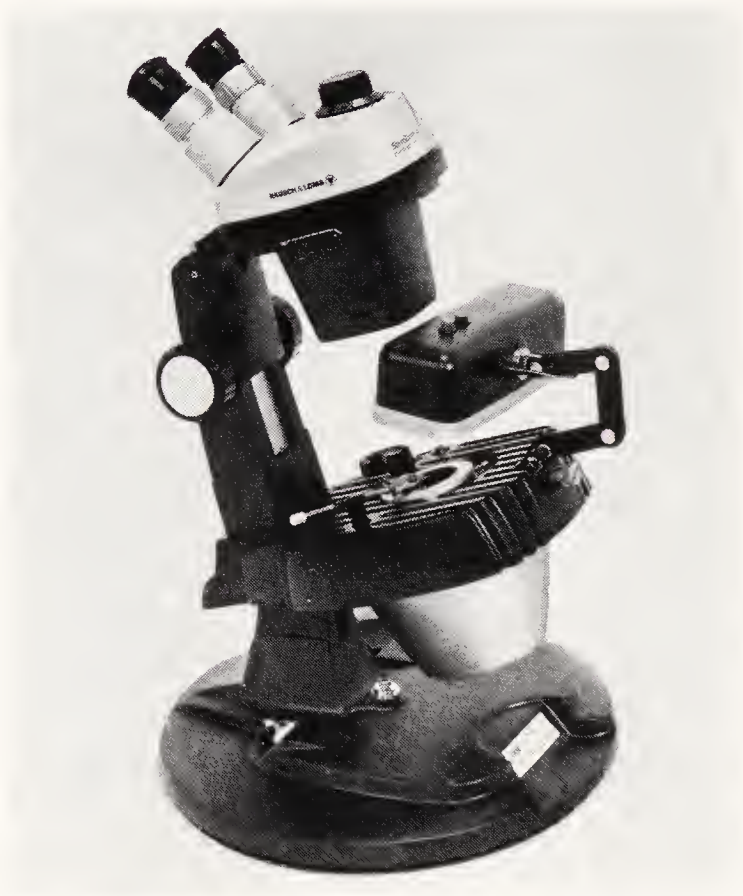

Figure 136
The Deluxe Gemolite.

vidual instruments which perform tests it may be used to duplicate. The gemological microscope, an expensive instrument, requires training and practice to be used effectively and its use for most tests is more time-consuming than that of the instruments designed especially for gem identification. It may be used for the determination of refractive index, optic character, and pleochroism, as well as for magnification.

Ultra-violet Lamps. Ultra-violet radiation of certain wave lengths excites fluorescence in many materials. The nature of the fluorescence may be of value in identifying the gem which exhibits the property. The most effective wavelengths are 2537\AA and 3660\AA . Different models of the Mineralight provide long-, short-, or both wavelengths.

Hardness Points and Plates. Hardness points and plates, the traditional means of gem testing, are used by the present-day gemologist only as a last resort when all other tests fail to produce a positive identification. They are almost never needed in the testing

Instruments Essential to Gem Testing

of transparent gemstones, but become important to the gemologist in the identification of opaque gems. They are inexpensive and easily used, but careless handling may easily result in irreparable damage to a fragile gem. While scratches on the back of an opaque gem do not detract from its beauty, similar marks on the pavilion facets of a transparent gem may be visible from the crown. Since they are often necessary to the correct classification of opaque gemstones, hardness points or plates are essential to the gemological laboratory.

A Monochromatic Light Source. The increased clarity and sharpness of refractive index readings in monochromatic light makes such a lamp an important instrument in the complete laboratory. The use of a monochromatic light source in conjunction with the refractometer enables the gemologist to determine birefringence and, occasionally, optic character, in addition to obtaining accurate index readings.

Reflectivity Meter. This instrument for measuring refractive index is discussed in Chapter V.

Diamond Pen. This instrument applies an even flow of a liquid to a clean polished surface. It forms a line on diamond and beads on substitutes.

Thermal Conductometer. The heat conductivity of diamond is unique. A number of instruments have been marketed to utilize this property to distinguish the diamond substitutes. The Ceres Probe was first, followed by several others including the GEM Diamond Master.

Chapter XVI

Descriptions and Property Variations of Gemstones

Amber varies in diaphaneity from transparent to semitranslucent and from light yellow to dark brown in color, although reddish and greenish-browns are not unknown. In addition, amber is dyed all colors. It is characterized by its very low specific gravity—near 1.08. Baltic amber is usually lighter in color than Sicilian, Rumanian, or that from Burma. Amber, an amorphous gem material, has a refractive index near 1.54. It is easily distinguished from plastic imitations by the fact that it floats in a saturated salt solution, while plastics sink. Amber may contain spherical bubbles, as well as irregular foreign fragments and insects.

Plastics are probably the most common amber imitations. Their properties are much higher than those of amber. R.I. usually 1.60 to 1.66 and S.G. 1.25 to 1.55. In contrast to the resinous odor of amber under the hotpoint, plastics have an acrid odor.

Reconstructed or pressed amber, made by application of heat and pressure to fragments of amber is best distinguished by magnification, which discloses a grainy, roily texture similar to a saturated sugar solution. (See illustration.) Copal, a natural resin of more recent age which, like amber and pressed amber, floats in a saturated salt solution, softens under a drop of ether. Amber is not affected. The hardness of amber is 2 to 2.5. It is sectile. Amber fluoresces strongly in a yellowish color to long-wave ultraviolet. It is less strong to short-wave.

One amber imitation called Amberdan has a refractive index of 1.56 and an S.G. of 1.23.

Amblygonite, a triclinic lithium-aluminum fluophosphate, has been found in a colorless, yellow, or light-brown transparent form.

Descriptions and Property Variations of Gemstones



Figure 138
Pressed amber.

Indices for gem quality crystals are usually near 1.612 and 1.636 and the optic sign is positive. The hardness is 6, the specific gravity is near 3.02, and it has perfect cleavage in a basal plane. Repeated twinning is common in two directions at 90° .

Anatase, rutile and brookite are all different crystalline forms of titania. Rutile and anatase both occur in the tetragonal system and brookite is orthorhombic. Anatase occurs in a brown color when in transparent, gem quality. It is characterized by indices of 2.493 and 2.554, a specific gravity of 3.9, and a hardness of 5.5 to 6.

Andalusite occurs in yellow-green to brownish-green colors, with an overtone of a brownish-red color caused by pleochroism often evident in one direction. It is also found in a yellow-brown and a green color. The strong pleochroism may lend andalusite a bicolored effect similar to that associated with alexandrite, but without the color changes under different lights. The refractive indices are near 1.634 ($\pm .006$) to 1.643 ($\pm .004$) and the specific gravity 3.17 ($\pm .04$). The birefringence varies from .008 to .013, with the highest birefringence when indices are lowest. It is distinguished from tourmaline by its lower birefringence and biaxial optic character. Andalusite crystallizes in the orthorhombic system and is optically negative in sign. The pleochroism of the green variety is brownish-red and brownish-green. Andalusite has a hard-

ness of 7 to 7.5, and has distinct to perfect cleavage with an angle between the two directions of nearly 90° .

Apatite is very rarely encountered as a gem material, but occurs in transparent form in blue, violet, purple, yellowish-green to bluish-green, colorless, and yellow colors. Only in the blue apatite is the dichroism strong, blue and yellow being the typical dichroic colors of blue apatite from Burma. Apatite is characterized by very low birefringence .002 to .006. The indices are 1.642 ($-.012$, $+.003$) to 1.646 ($-.014$, $+.005$). The specific gravity is 3.18 ($\pm .02$). Apatite has a hardness of 5, no cleavage, weak dispersion, and is uniaxial negative. See Chapter XIII for typical absorption spectrum. Brownish-green cat's-eye apatite is common.

Apophyllite is a mineral in the zeolite family, which is very rarely cut and then only for collectors. It is only 4.5 to 5 in hardness, has a specific gravity of 2.3 to 2.5, and indices of 1.535 and 1.537. In its gem quality, it is usually pink in color and semitransparent. A hydrated potassium-calcium fluosilicate, apophyllite crystallizes in the tetragonal system.

Augelite is an aluminum phosphate that sometimes occurs in colorless, or nearly colorless, and slightly brownish crystals. Properties: hardness, 4; specific gravity, 2.70; monoclinic; indices, 1.574 and 1.588; sign, positive.

Axinite, a hydrous calcium aluminum borosilicate is sometimes faceted for collectors. It is strongly trichroic, but its flat, wedge-shaped crystals are usually too thin to make it possible to utilize the more attractive reddish-brown and violet colors visible in directions parallel to the flat direction. A find of thicker crystals in Baja California made it possible to cut stones that face up a rich reddish-brown. It may be confused with chrysoberyl, hessonite garnet, topaz or tourmaline in the yellow variety, but the other colors are distinctive. Axinite occurs in the triclinic system (thus it is biaxial) and has a negative optical sign. Although it has only distinct, not easy, cleavage it fractures easily. It is 6.5 to 7 in hardness. The refractive indices are 1.678 ($\pm .005$)

Descriptions and Property Variations of Gemstones

and 1.688 ($\pm .005$), the birefringence near .010, and the specific gravity 3.29 ($\pm .02$). See Chapter XIII for typical absorption spectra.

Azurite is employed more for ornamental objects than as a gemstone, but is used especially in American Indian jewelry. It is a semitranslucent to opaque, dark violetish-blue mineral frequently found and cut with lighter green malachite, thus appearing as a mottled green and blue stone. Azurite has a large birefringence sometimes apparent by the "spot method" of index determination. Indices are 1.73 to 1.84. The specific gravity is about 3.80 if compact, but occasionally porous azurite floats in methylene iodide (3.32). Azurite has a hardness of 3.5 to 4, and a pale blue streak. It effervesces under a drop of hydrochloric acid.

Benitoite is a rarely encountered gemstone resembling blue sapphire. It occurs in colorless and light to dark blue transparent stones, with violetish tints caused by strong dispersion often apparent as the stone is turned. It is easily identified by its high birefringence (.047), indices 1.757 to 1.804, and specific gravity 3.64 ($\pm .03$). High birefringence distinguishes benitoite from sapphire. The dichroic colors of blue benitoite are deep blue and nearly colorless and of violet benitoite, reddish-gray and purple-violet. The dispersion of benitoite is about equal to that of diamond but it is seldom cut to display it. It is uniaxial, with a positive sign and its hardness is 6 to 6.5. It does not possess easy cleavage. The largest fine stone known is of seven carats. Today a good stone of two carats or above is a rarity. It fluoresces light-blue under short-wave ultraviolet light. A pink variety was identified recently by GIA.

Beryl. The color range of beryl is among the widest of the important gemstones, although most varieties occur in light tones. In addition to the familiar emerald and aquamarine colors, beryl produces lovely light purplish-red to light red-violet, yellow, greenish-yellow, brownish-yellow, and colorless stones. Rarely, aquamarines from Madagascar and some violetish-red stones are fairly deep in color. Attractive orange beryl is found in Brazil.

HANDBOOK OF GEM IDENTIFICATION

Dark-brown material may show asterism, and chatoyancy is possible in most colors.

The properties of the varieties of beryl vary somewhat, so they will be listed individually. (See Chapter XX.)

	Refractive Indices	S.G.
Aquamarine	1.575 ($\pm .005$) and 1.580 ($\pm .005$)	2.71 ($\pm .03$)
Emerald	1.577 ($\pm .008$) and 1.583 ($\pm .009$)	2.72 ($\pm .02$)
Yellow	1.570 ($\pm .003$) and 1.575 ($\pm .004$)	2.70 ($\pm .02$)
Red to violet	1.585 ($\pm .006$) and 1.594 ($\pm .006$)	2.82 ($\pm .05$)

The birefringence of beryl increases with increasing refractive index from .005 for yellow beryl and most emerald to .007 for African emerald and .009 for the red to violet variety. Beryl crystallizes in the hexagonal system, has no perceptible cleavage, and is uniaxial negative. Dispersion is very low. See Chapter XIII for typical absorption spectra.

Since beryl occurs in such a wide color range, it may be confused in one or more of its varieties with one or more varieties of many other gemstones. Aquamarine may be confused with topaz, synthetic spinel, tourmaline, zircon, apatite, fluorite, sapphire, synthetic sapphire, doublets, triplets, and glass. The standard tests permit easy separation.

Emerald in one or more qualities may resemble the following: synthetic emerald, tourmaline, peridot, demantoid garnet, grossular garnet, chrome diopside, sphene, diopside, fluorite, apatite, chrysoberyl, zircon, semitransparent jadeite, doublets, triplets, and glass. With the exception of synthetic emerald (described in Chapter X), separation is simple by the standard procedure. Morganite may be confused in appearance with spodumene (kunzite), tourmaline, topaz, corundum, synthetic corundum, synthetic spinel, rhodolite garnet, phenakite, scapolite, doublets, and glass. The only natural gemstone with similar property values, scapolite, is easily identified by its greater birefringence. Other varieties of beryl, such as colorless, yellow, and brown may resemble topaz, hessonite garnet, quartz, tourmaline, chrysoberyl, sapphire, scapolite, synthetics,

Descriptions and Property Variations of Gemstones

doublets, and glass. Easy separation is accomplished by standard tests, except for scapolite described above.

Most beryl varieties of deeper colors exhibit fairly distinct dichroism. Emerald—green and blue-green. Aquamarine—colorless to light blue and darker blue (very weak if heat-treated). Morganite—light red and violetish-red (weak). Other varieties are very weakly dichroic.

Beryllonite is a very rare mineral sometimes fashioned as a gemstone. It is transparent colorless to light yellow. The refractive indices of 1.552 to 1.562 are between those of beryl and quartz which it resembles, but its biaxial optic character and specific gravity 2.85 ($\pm .02$) separates beryllonite. Beryllonite has a perfect cleavage plus a direction of good cleavage at right angles to this. Its hardness is 5.5 to 6. It is orthorhombic.

Brazilianite is a transparent yellowish-green mineral discovered in a Brazilian pegmatite dike during World War II and later described by F. H. Pough, Ph.D. It is more a collector's piece than a true gemstone. Brazilianite has an easy two-directional cleavage and may be sufficiently shattered to appear translucent. The refractive indices are near 1.602 and 1.621, birefringence .019, with a specific gravity near 2.94. It is biaxial, with a positive optic sign; has a hardness of 5.5; and weak pleochroism. It is also bleached to colorless form.

Brazilianite may be confused with topaz, tourmaline, chrysoberyl, and especially apatite. The refractive index test separates it from chrysoberyl and birefringence from topaz or apatite.

Calcite is a very common mineral (calcium carbonate) which occurs in transparent to semitranslucent forms in a wide variety of colors. The only extensive jewelry use it finds is in the onyx marble variety which is used for lamp bases and other ornamental objects and in carved onyx- or agate-like forms dyed green and other jade colors. The latter form is sold incorrectly as "Mexican Jade." It is distinguished from jade by its strong banding.

Massive calcite in the form of either limestone or marble is used

for carvings in a white color or dyed to imitate coral and other ornamental materials.

Calcite has refractive indices of 1.486 and 1.658, and is uniaxial negative. The indices and birefringence of .172 are nearly constant. The specific gravity is near 2.71.

Single crystal calcite possesses very easy three-directional cleavage, not apparent in the crystalline aggregate forms used for ornamental purposes. Calcite has a hardness of 3 and effervesces strongly to hydrochloric (muriatic) acid. The excessive birefringence is apparent on crystalline aggregates of calcite if the "spot method" of refractive index determination is employed. It may be necessary to try different orientations of the stone and to rotate a Polaroid plate before the refractometer eyepiece to obtain results.

Cassiterite is well known as a mineral but very rarely fashioned as a gemstone. In a transparent form, pale yellow to dark red-brown stones are sometimes faceted. Translucent to opaque dark brown cassiterite is seen in cabochon form. The refractive indices are near 1.996 to 2.09, so the birefringence is great. The high (6.95) specific gravity serves to identify cassiterite. Its hardness is 6 to 7.

Chlorastrolite is a dark green semitranslucent material characterized by a radial fibrous structure. It is employed infrequently in cabochon form for jewelry. Each cabochon contains a number of roughly spherical areas of tiny radial groups. Chlorastrolite often has patches or veins of white to pink thomsonite. The structure is such that chlorastrolite cabochons sometimes exhibit a chatoyant effect in each of the small areas, or a broad sheen. It is a darker, less intense green than malachite. The usual refractive index is 1.65 or 1.66, specific gravity about 3.2, and hardness 5 to 6.

Chrysoberyl. Although chrysoberyl is best known for the finest cat's-eye, transparent faceted chrysoberyl is a fairly common gemstone. As in the cat's-eye variety, light to medium tones of greenish to brownish-yellow are most common, but yellow-green and green-

Descriptions and Property Variations of Gemstones

ish-brown to almost red stones are known. When a chrysoberyl shows a pronounced color change from purplish-red under incandescent artificial light to green in daylight it is called alexandrite.

The gemstones with which chrysoberyl is most often confused include synthetic alexandrite, sapphire, zircon, peridot, synthetic corundum and spinel, beryl, tourmaline, yellow diamond, quartz, doublets, and glass.

Chrysoberyl crystallizes in the orthorhombic system and is optically positive. The refractive indices are near 1.746 ($\pm .004$) and 1.755 ($\pm .005$). The specific gravity is very near 3.73 ($\pm .02$). On the refractometer, chrysoberyl behaves much as if it were uniaxial, for the intermediate index is seldom more than .001 higher than the lowest index numerically. The two directions of distinct cleavage are 60° apart, but rarely in evidence. Chrysoberyl has weak dispersion. It is fairly tough and has a hardness of 8.5. See Chapter XIII for typical absorption spectra.

The alexandrite variety exhibits strong trichroism with slight color differences between artificial and daylight. The colors are green, orange, and red, with the latter tending toward violetish-red in daylight. Yellow, yellow-brown, and yellow-green chrysoberyls exhibit from weak to distinct dichroism corresponding to lighter and darker tones of the stone's color. Synthetic corundum and synthetic spinel which display a pronounced color change from incandescent artificial light to daylight are called incorrectly "synthetic alexandrite" in the trade. The synthetic corundum changes from a purple resembling amethyst under artificial light to a grayish-blue in daylight, bearing little resemblance to alexandrite. Synthetic spinel changes from red to green in colors similar to the genuine, but, of course, it is not pleochroic. Its refractive index of near 1.73 may be confused with that of chrysoberyl on hasty determination. Flux-grown synthetic alexandrite shows typical inclusions, and the pulled synthetic may show curved striae.

Copal, Kauri Gum, and Dammar Resin are natural resins of recent age. While resembling amber in appearance and properties, they become sticky rather quickly under a drop of ether. The refractive index is near 1.54, and specific gravity near 1.06. See Chapter XXI for separation from amber.

Figure 139
Black coral.

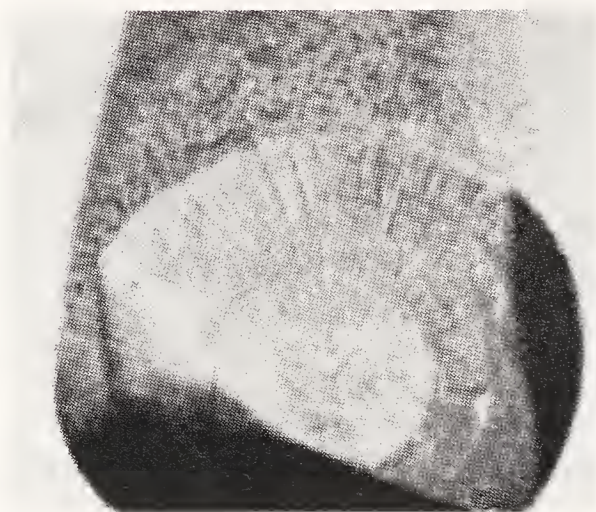

Coral is a semitranslucent to opaque material occurring as the branchlike framework of a colony of marine invertebrates. Gem coral occurs in white, pink, orange, red, blue, violet, golden and black colors. The black and golden type differs from the white to red in that it is not largely calcium carbonate, but a horny substance. Calcareous coral has properties near those of calcite. Calcite fibers radiate from the center of each branch in the plane normal to the length. Each branch shows a striped appearance under magnification parallel to the length of the branch. The luster on fractures is dull.

Refractometer readings are usually vague, but if a spot reading is used, the huge birefringence of calcite (refractive indices 1.486 and 1.658) is usually evident with a Polaroid plate. The high index is constant. Specific gravity is usually within .05 of 2.65. Hardness is 3.5 to 4. Black and golden coral have indices of about 1.56 and 1.57, birefringence near .01, specific gravity about 1.37, and a hardness under 3. Unlike coral, the black and golden, horny type fails to effervesce under hydrochloric acid. It shows a coarse interrupted tree-ring structure in cross section of the branches. This is emphasized by small crescent-shaped sections of white color. A burnt-hair odor to the hot point is characteristic of black coral. Black material may be bleached to a golden color by hydrogen peroxide.

Coral is easily distinguished from conch pearl by the latter's odd mosaic pattern, produced by shiny reflections seen in certain directions. The 2.85 specific gravity of conch pearl also distinguishes it. White coral is often imitated by conch shell worked into various shapes. The curved layered structure of the shell identifies it.

Descriptions and Property Variations of Gemstones

Corundum is, in many respects, the most important of the colored stones. Ruby and sapphire are more familiar to and cherished by the layman than any other gem varieties with the possible exception of emerald. Ruby includes only the medium to dark tones of red to violetish-red. All other colors including purple, violet, and light red are properly called sapphire. Slightly reddish-orange natural sapphires are called padparadsha properly, but the term is not used frequently today. Other colors include very light to very dark blue to violetish-blue, bluish-green, yellowish-green, yellow, brown, nearly opaque black, and colorless. One variety shows a color change of the type familiar in alexandrite, but the change is weaker and the daylight color is basically blue and the artificial light color is violetish-red to purple. Semi-transparent to semitranslucent stones of almost all colors found in the transparent varieties have been fashioned to display asterism when the essential silk-like inclusions are present. Both 6 and 12 rayed stars have been found. In addition to the colors mentioned above, many asteriated stones are light gray to white. Yellow and green star sapphires are very rare as is chatoyant corundum.

There are many gemstones which may resemble one or more varieties of corundum. These include spinel (blue, red, violet), zircon (colorless, yellow, blue, green), chrysoberyl (yellow, brown, and vaguely, alexandrite), pyrope, almandite, and rhodolite garnet (red, purple, and violet), topaz (colorless, yellow and brown, light blue), tourmaline (light to dark red, blue, green), benitoite (blue), spodumene (light red to violet), beryl (light blue, yellow, light red to red-violet), hessonite garnet (yellow to brown), quartz (pale stars, colorless, yellow), synthetic corundum (stars, all colors of transparent), synthetic spinel (blue, and light colors), glass (all colors), doublets (most colors).

Of the gemstones and substitutes named, only synthetic corundum, rhodolite and almandite garnet, benitoite, and chrysoberyl have similar property values. The identification of synthetics is discussed in Chapter X. Rhodolite and almandite are singly refractive, so they are not dichroic and exhibit no doubling of facet edges. Great care in the use of the polariscope is necessary to

distinguish the anomalous double refraction of some garnet from true double refraction. Benitoite has a birefringence over five times as great as sapphire plus a lower specific gravity, and a positive optic sign. Chrysoberyl has perceptibly lower refractive indices and specific gravity.

Ruby, plus green, yellow, and blue sapphire show distinctive absorption spectra, permitting easy separation of ruby from garnet and these colors of sapphire from synthetic counterparts. Ruby and synthetic ruby show no appreciable difference in spectra.

Corundum crystallizes in the hexagonal system and possesses four directions of parting or false cleavage which may be well developed. The repeated twinning which causes parting may cause a gemstone to remain light in all positions in the polariscope as well as imparting a broad-banded appearance under magnification. The refractive indices of corundum are usually near 1.762 and 1.770, but rare stones (especially dark red and green) may give readings as high as 1.778 without significant change in the normal birefringence of .008. Corundum is uniaxial and negative in optic sign, so the numerically higher reading is the constant one. The specific gravity of gem materials is 4.00 ($\pm .03$), and the hardness 9. The dispersion of corundum is very low. Many of the corundum varieties are strongly dichroic. Ruby generally exhibits light orangy-red and dark violetish-red as dichroic colors, but in dark stones and those tending toward violet, orange and violet is a more accurate description. Blue sapphire—light greenish-blue and dark violetish-blue dichroic colors, with very dark stones showing green and dark violet. Orange to yellow-brown corundum exhibits orange to yellow-brown with the depth depending on the color of the stone, and the other color nearly colorless. As in the yellow variety, dichroism is weak. Green sapphire—green to blue-green and yellow-green.

Danburite is a rare mineral most often found in transparent colorless to yellow crystals which may be faceted for collectors. It may be confused with any of the colorless or yellow gemstones of the medium index range. The refractive indices are close to those of topaz 1.630 ($\pm .003$) and 1.636 ($\pm .003$) but the specific gravity is

Descriptions and Property Variations of Gemstones

much lower 3.00 ($\pm .01$). The birefringence remains constant at .006. Danburite is biaxial, with the intermediate index just half-way between the extremes. It has no distinct cleavage, and its hardness is 7. Most danburite fluoresces in a light blue color under ultra-violet radiation.

Datolite is a hydrated calcium borosilicate that occurs both in transparent greenish crystals and in semitranslucent white, red, yellow or amethystine form resembling porcelain. It is a secondary mineral usually found in veins and cavities in basic igneous rocks. It occurs in the monoclinic system; shows no cleavage; has a hardness of 5 to 5.5; specific gravity, 2.9 to 3.0; and refractive indices of 1.626 and 1.670. It is optically negative.

Diamond, the most important gemstone, is usually transparent and nearly colorless, but yellow to brown stones are not rare and light tones of violet, green, blue, and red are known. Nontransparent black diamonds are sometimes faceted. With the exception of strontium titanate, gemstones which approach diamond in refractive index, unlike diamond, are doubly refractive, usually with strong birefringence. The high luster, single refraction, 3.52 specific gravity, and extreme hardness, all distinguish diamond.

Usually, a 4155 Å line in the deep violet is visible. A bluish-white fluorescence under X-ray is characteristic.

Although brilliant-cut nearly colorless diamonds are usually recognized by jewelers at a glance, the usual colors in other cuts, and deep colors in any cut sometimes are not so readily recognized. Cubic zirconia, GGG, YAG, strontium titanate, zircon, synthetic rutile, synthetic spinel, synthetic sapphire, doublets and other substitutes are often mounted to pass off as diamonds. Careful examination of these under magnification will reveal doubling in zircon, synthetic rutile and synthetic sapphire. Calibre diamonds in mountings stand out in relief when immersed in bromoform, or methylene iodide, in contrast to stones of lower refraction which are sometimes substituted for some of the diamonds. Under magnification, characteristics are also likely to be revealed that are unique in diamond among colorless, transparent stones of high luster. Cleavage, "naturals," the



Figure 140
Growth markings on a
“natural” on a diamond.

unusual appearance of the lathe-turned girdle surface on a brilliant, and the sharpness of facet edges all suggest diamond. The separation of diamonds from substitutes is aided by the Diamond Pen, reflectivity meter or probe.

TREATED DIAMONDS. For many years diamonds occasionally were subjected to the radiation of radium salts for the purpose of imparting a green color. Stones so treated retained a dangerously high degree of radioactivity. Radium treatment is easily detected by the residual radioactivity by Geiger counter or by placing the stone in contact with unexposed film (or film in a light-tight paper holder) for twenty-four hours. Radioactivity causes exposure, leaving a photographic impression of the area of the diamond in contact with, or adjacent to, the film. Another characteristic of radium-treated green diamonds may be detected under magnification: flat, disclike brown spots slightly beneath the surface. The advent of the methods that produce stones safe to wear, using the cyclotron and the nuclear reactor, made the radium method obsolete.

If a diamond is placed in the path of highly accelerated subatomic particles in the beam of a cyclotron or exposed to bombard-

Descriptions and Property Variations of Gemstones

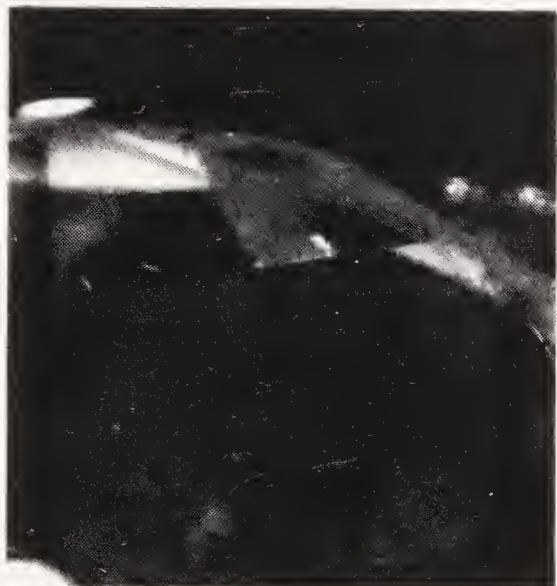

Figure 141

Color concentration appearing near the girdle of a diamond bombarded in a cyclotron.



Figure 142

Cloverleaf, or umbrella, effect.

ment by neutrons in a nuclear reactor, short exposure causes a change to a green color, which deepens to black as exposure continues. Apparently, the color is caused by electrons knocked from their regular positions in the structure and which then occupy vacant spaces between their normal positions, forming so-called color centers. Heat treatment causes partial healing of the lattice damage, but not all. The result of heat treatment is a change from green to a yellow or brown color.

Stones colored by certain types of particles in the cyclotron are characterized by a shallow penetration and a strongly zonal color distribution. This is evident under magnification in the form of a pattern around the culet that has been likened to either a "cloverleaf" or an "umbrella." Zones of color, giving a pattern similar to the facets, may also be seen.

Green stones subjected to neutron bombardment in the cyclotron or a radioactive pile have color throughout and are not detectable by color zoning. However, either radioactive pile- or cyclotron-irradiated diamonds colored yellow or brown by subsequent heat treatment are distinguishable by the presence of a narrow absorption band, at 5920\AA . Robert Crowningshield, GIA's Gem Trade

HANDBOOK OF GEM IDENTIFICATION

Laboratory Director in New York City, who developed this test, has been able to detect the line in all but less than ten of over 10,000 stones examined that were known to have been treated. Narrow absorption lines are also to be seen at 4980 and 5040Å.

In 1978 Collins in England found that the 5920Å line that is produced in the annealing of treated green diamonds could be removed as far as normal spectroscopy is concerned. Only by cooling a stone that had been annealed to a thousand degrees to a temperature within one hundred degrees of absolute zero would it be possible to detect the 5920Å line. Thus, for normal spectroscopy, the telltale 5920Å can be removed.

Large treated stones may show no 5920Å line, but the presence of the 4980Å and 5040Å lines should be considered proof of treatment.

Natural green diamonds seen in GIA Laboratories have been characterized by the presence of green naturals. We have not seen known green diamonds with natural coloration without such naturals left to impart color. Thus, any deep-green diamond is suspect.

Until recently, we expected to see a 4980-5040Å pair, with the former stronger in treated stones. However, we have encountered green diamonds without strong lines of any sort.

Diamonds that are treated by radioactive isotopes are somewhat different from those treated in the nuclear reactor. Green stones often show no detectable lines, although some show a prominent 5040Å line.

For many years the GIA laboratories considered that only green diamonds that had green naturals were colored by nature. Apparently, there is no green coloring agent for diamond other than that caused by irradiation and displacement of atoms in the lattice. In view of the fact that diamonds can be colored green by irradiation and there is no means by which the difference between natural and artificial irradiation can be distinguished, the GIA Gem Trade Laboratories do not state that a diamond that is green in color has a naturally caused color. The only natural greenish diamonds that GIA has encountered have been stones with a chartreuse color.

Diamonds are often coated to improve their color. A fluoride

Descriptions and Property Variations of Gemstones

coating of the type applied to lenses (or other chemicals resistant to the ordinary solvents) which masks the diamond's yellow body color, is used. It may be removed by boiling the diamonds in concentrated sulphuric acid. Usually, it is applied to the pavilion in sufficient depth to impart an iridescent sheen when light is reflected from the pavilion facets. Occasionally, it is applied thinly only at or near the girdle. This type is apparent only when the gemologist is attempting to compare the color with that of uncoated diamonds. A dark grayish cast is cause for suspicion. Unless the coating can be seen under magnification, removing it by boiling out is the only way to prove its presence.

Diopside is a common mineral, rare in gem quality, that is fashioned occasionally for collectors. It is usually yellow to green in a transparent to translucent form, but may be colorless or blue.

Recently, a very dark green pyroxene with properties fitting those of diopside has been offered as enstatite cat's-eye. Black stones with a four-rayed star have been sold correctly as star diopside. Green material usually shows both the absorption characteristics of chrome diopside and enstatite. In appearance diopside may be confused with peridot, demantoid garnet, zircon, enstatite, tourmaline, chrysoberyl, emerald and spidote. The refractive indices are 1.675 (— .010, + .027) to 1.701 (— .007, + .029). In the usual hue of green, the darker the color, the higher the indices and gravity. The specific gravity is 3.29 ($\pm .03$). The birefringence of diopside (.024 to .028) is much less than that peridot and the reaction that may be obtained on a refractometer using monochromatic light is biaxial positive. The pleochroism is weak. Diopside has perfect cleavage, characteristic of the pyroxene group of minerals and also parting. Diopside may be chatoyant. The violetish-blue variety is called violane. A chrome green is rare.

Diopside is a rarely encountered intense green transparent mineral which, in its best quality, resembles fine emerald in appearance. It is easily identified by its high birefringence (.053). Refractive indices are 1.655 ($\pm .011$) to 1.708 ($\pm .012$) and specific gravity (3.30, $\pm .05$). It is uniaxial with a positive sign. Diopside when faceted is usually in very small stones. It has perfect cleavage in three directions and its hardness is 5. Its pleochroism is weak.

Descriptions and Property Variations of Gemstones

Dumortierite when used for gem purposes is a compact, massive, semitranslucent dark-blue basic aluminum borosilicate mineral that resembles sodalite more closely than lapis-lazuli. It has refractive indices of 1.678 and 1.689; specific gravity, 3.30; and a hardness of 7. It is optically negative (beta, 1.686). It is easily distinguished from lapis-lazuli and other nontransparent blue minerals by its high refractive index and specific gravity. The major occurrence of dumortierite in gem material is as a coloring agent in quartz.

Ekanite. F. L. D. Ekanayaki, Ceylonese gem dealer and gemologist, bought two dark-green faceted stones on the market in Colombo, because they looked unlike any gem that he knew. Tests he performed indicated glass, but inclusions belied that identification. One specimen examined by British scientists proved to contain calcium, lead, thorium and silicon. The samples tested are all highly radioactive. It is apparent that this is a metamict mineral similar to green, low-property zircon, but one in which structural breakdown has been more complete; it is now amorphous but inclusions show that it was once tetragonal. The refractive index is 1.597 and the specific gravity is 3.28.

Enstatite is a transparent to translucent yellowish-green to brownish-green to reddish-brown mineral rarely fashioned as a gemstone. It may be confused with chrysoberyl, tourmaline, peridot, zircon, and diopside. It has refractive indices of 1.658 ($\pm .005$) to 1.668 ($\pm .005$) and a specific gravity of 3.25 ($\pm .02$). The low birefringence (.010) distinguishes enstatite from peridot and diopside. Enstatite, which may be chatoyant, is biaxial positive. It has easy cleavage, with about 88° between the two directions; hardness of 5.5; and weak pleochroism in the green type, but strong in the brown. It may be recognized immediately by a very strong, sharp absorption line at 5060\AA (See Hypersthene.)

Epidote is a common mineral infrequently fashioned as a gemstone. While usually yellowish to brownish-green, it is known in reddish, yellow, and gray colors—from transparent to semitranslucent in diaphaneity. The refractive indices are 1.729 ($-.015, +.006$) to 1.768 ($-.035, +.012$), specific gravity 3.25 to 3.50. Most epidote is green with strong pleochroism (green, dark

Descriptions and Property Variations of Gemstones

brown, and yellow). The birefringence (.019 to .045, usually .030 to .040) at this point on the refractive index scale identifies epidote. Epidote has excellent cleavage. Although epidote of gem quality is usually biaxial negative, material with higher indices may be positive.

Euclase is a mineral which, but for its extreme rarity, probably would be an important gem mineral. It has the requisite beauty and hardness (7.5). Euclase occurs in transparent colorless, light blue, or light green colors. It may be confused with beryl, topaz, and the many colorless gemstones in the middle refractive index range. The refractive indices are 1.654 ($\pm .004$) to 1.673 ($\pm .004$) with a birefringence nearly constant at .019, and specific gravity very near 3.10. It is biaxial positive, with the optic sign easily determined in most cases with monochromatic light on a refractometer. Euclase has one very easy direction of cleavage.

Faustite is a gem mineral in the turquoise family in which zinc is responsible for the color instead of copper. The result is a material reminiscent of turquoise, but yellow-green in color. The refractive indices and specific gravity are the same as those of turquoise.

Feldspar Group. The important rock-forming feldspar minerals furnish a number of gem materials of which the most frequently encountered are moonstone, amazonite, and labradorite. The feldspars all cleave very easily in one direction, and nearly as easily in another at or near 90° to the first. If any tiny breaks are present, the cleavage will be apparent.

The feldspars are divided into the potassium members, principally orthoclase and microcline, and the plagioclases. The plagioclase group ranges from albite, a sodium-aluminum silicate, to anorthite, a calcium-aluminum silicate. These are the end members. Other members of the group, including oligoclase, andesine, labradorite and bytownite, contain both sodium and calcium. Feldspars fluoresce red to short wave.

Albite-Oligoclase. For convenience albite and oligoclase of the plagioclase series of feldspars are grouped as one gem species. Although most fine moonstone is a variety of orthoclase (*adularia*), some moonstone has higher properties corresponding

to those of albite and oligoclase. Since both types of moonstone are feldspar, no differentiation is made between them, but the gemologist must be prepared to find a moonstone occasionally which has property values higher than those of orthoclase. Moonstone is the name applied to a semitransparent colorless stone with a white to pale blue floating light. The variety sunstone is a translucent to semitranslucent white, light gray, or yellowish, with red-brown to orange spangles of hematite. If green spangles are present it is called aventurine. A form of translucent albite colored to an intense light green by chrome-rich jadeite inclusions is probably least confusingly called chrome-albite. Edward Gübelin reports refractive index readings in the 1.52 to 1.54 range and an S.G. averaging 2.77. Refractive indices of ordinary albite-oligoclase are 1.532 ($\pm .007$) to 1.542 ($\pm .006$), and specific gravity 2.62 ($\pm .02$). The cleavage is easy, and a second direction at about 85° to the first is slightly less easy.

Labradorite is found usually as a semitranslucent gray material exhibiting broad iridescent color effects. It has been cut in a transparent yellow form, without the familiar color effect. The gray material is usually seen in cabochon or scarab form. The refractive indices are 1.559 ($\pm .005$) to 1.568 ($\pm .005$), and the specific gravity 2.70 ($\pm .05$). The angle between the two cleavages is about 86° .

Microcline, although known in a variety of colors, is used as a gem material almost only in the light blue-green amazonite variety. It is semitranslucent in gem quality and is characterized by a grid-like surface appearance. Microcline has refractive indices of 1.522 ($\pm .002$) to 1.530 ($\pm .002$). The specific gravity is 2.56 ($\pm .01$). The angle between the two cleavage directions is just less than 90° .

Orthoclase feldspar is best known for the moonstone variety, which is semitransparent and colorless with a floating blue light. It also occurs in a light yellow transparent form without the floating light. Feldspar with chatoyant and four-rayed star effects has been found in green, orange, brown and black colors, as well as the familiar white. Moonstone is not closely imitated by any other natural gemstone, although milky chalcedony is sometimes

Descriptions and Property Variations of Gemstones

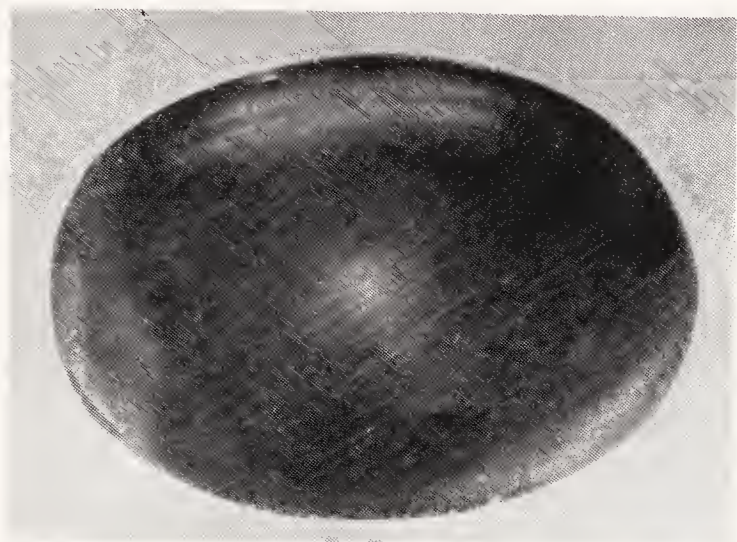

Figure 143

A microcline cabochon illuminated from the side.

confused with it. Glass, synthetic spinel and plastic imitations may bear a closer resemblance. The transparent orthoclase may be confused with citrine, yellow beryl, pale yellow topaz or glass.

Refractive indices are close to 1.518 and 1.526. Specific gravity is 2.56 ($\pm .01$). Bear in mind that moonstone varieties of the plagioclase feldspars (especially albite and oligoclase) will exhibit higher property values. Orthoclase has perfect and near perfect cleavage in two directions at 90° . This cleavage can be detected if even tiny breaks are present. This provides one of the methods of distinguishing between any of the feldspars and chalcidony, with which they are often confused.

Fluorite or fluorspar is a soft mineral occurring in a number of lovely colors. Ornaments such as vases, snuff bottles, and statuettes are carved from fluorite. Although used extensively for this purpose, it is faceted as a gemstone but rarely. While commonly green, blue, or violet, it is known in other colors. Fluorite occurs in the cubic system and has easy, perfect cleavage. The refractive index is very close to 1.434 and the specific gravity is 3.18 ($\pm .01$). It has a hardness of 4. It rarely keeps a good polish and, as the low index indicates, it has rather poor luster.

Garnet Group. The gem species of the garnet group all occur in the cubic crystal system, have no apparent cleavage, and tend to fracture fairly easily. Many garnets, although singly refractive, exhibit a strain or anomalous double refraction in the polariscope. All garnets have a high luster.

Almandite occurs in colors from medium red-violet to dark brownish-red. Contrary to popular use, the dark brownish-red color is as common in almandite as in pyrope or Bohemian garnet. Some almandite when cut *en cabochon* exhibits asterism either by reflected or transmitted light. Usually the star has four rays.

Almandite is most often confused with ruby, especially the dark Siam grade, but it may also be confused with glass, doublets, synthetic corundum, and spinel. Almandite frequently exhibits very strong anomalous double refraction. However, this will not produce the doubling of facet edges and strong dichroism always found in ruby. In addition, "silk" in almandite will be in only two directions in any one plane, while it is in three directions in the same plane in ruby. Their absorption spectra differ markedly. Almandite has a refractive index of 1.79 ($\pm .03$) and specific gravity of 4.05 ($\pm .12$).

See Chapter XIII for characteristic absorption spectra.

Andradite garnet occurs in green, black, and yellow varieties, of which the green demantoid variety is used most frequently as a gemstone. The color of demantoid varies from light yellowish-green to medium to dark green. It is characterized by its brilliancy and high dispersion (.057, which is greater than diamond). Demantoid is one of the few gemstones containing inclusions so characteristic as to permit positive identification—the so-called horse-tail inclusions described earlier. Demantoid is still incorrectly called "olivine" by many dealers. Demantoids are usually of small size, stones over four carats are extremely rare. Demantoid may be confused with emerald, peridot, tourmaline, sapphire, spinel, sphene, glass, and doublets. The refractive index is 1.875 ($\pm .020$). The specific gravity 3.84 ($\pm .03$). See Chapter XIII for typical absorption spectra.

Stanley Buttes, Arizona, is the source for the yellowish or greenish brown translucent variety characterized by a sheen that is distinctive.

Grossularite garnet is known in nature in a variety of colors including yellow, brown, white, colorless, green, light violetish red,

Descriptions and Property Variations of Gemstones

and orangy red. Recently a colorless to rich green transparent type has become popular. Transparent orangy yellow to orangy brown grossularite, known as hessonite or essonite among stone dealers, is an attractive richly colored gemstone. An excellent jadelike form often misnamed "South African Jade" or "Transvaal Jade" occurs in a translucent to semitranslucent slightly yellowish-green color and is characterized by the presence of small black inclusions visible to the naked eye. It fluoresces in an orange color under X-ray. It often shows an absorption band near 4630 Å, attributable to the presence of idocrase. Translucent grossularite (actually hydrogrossular) also occurs in light violetish-red and yellow. Hessonite may be confused with topaz, spessartite, doublets, beryl, citrine quartz, sapphire and chrysoberyl. Translucent grossularite may be confused with jadeite, nephrite, idocrase, serpentine, rhodonite and others. The refractive index of grossularite is 1.735 (+.015, —.035), but some translucent material is only about 1.70. The specific gravity is 3.61 (+.12, —.27).

The low-property hydrogrossular and idocrase are closely related and grade into one another. When the refractive index drops below 1.72 and the specific gravity below 3.35, they are virtually indistinguishable by gemological methods; it is a mixture of the two.

Grossularite garnet has been found in Africa in a hitherto unknown transparent rich chrome green, but also in a transparent very pale green to colorless form. Transparent light green material is also found in Pakistan. The refractive index is near but usually slightly above 1.73 in the colorless form and closer to 1.74 in the rich green. The specific gravity of the colorless material is about 3.60. Fortunately, much of it shows rod or needlelike inclusions. Some inclusions, however, may resemble those of synthetic spinel, so it is fortunate that their reactions to short- and long-wave ultraviolet differ from synthetic spinel. It shows a weak green fluorescence to short wave and weak orange to long wave. Transparent green may fluoresce a weak to moderate red under long- or short-wave. The strong orangy-yellow fluorescence to X-ray that characterizes grossularite is present.

Pyrope garnet occurs in transparent to semitransparent dark brownish-red to red colors. Since the property values of pyrope are rarely close to the gemstones which resemble it in appearance, it usually offers less difficulty in identification than almandite. The gemstones with which it is confused on sight alone are ruby, synthetic ruby, glass, doublets, tourmaline, and spinel. Although the refractive index of pure pyrope is 1.705, such material is rarely if ever encountered in nature. Pyrope below 1.735 is very rare, although 1.72 to 1.73 has been reported. Readings between 1.74 and 1.75 are most common. The specific gravity is 3.78 ($-.16, +.09$). When pyrope has a low index, it could be confused with spinel. Separation is best effected by a study of inclusions or by spectroscopy. Pyrope contains stubby rounded prisms of very low relief, and often needle-like crystals in two directions in the same plane. Spinel is characterized by the presence of octahedra either individual or in planes. For spectra, see Chapter XIII.

Rhodolite garnet is the name applied to a mixture of pyrope and almandite. Rhodolite tends to be lighter in color than either pyrope or almandite and it is usually violetish-red or a slightly brownish-red-violet. Rhodolite may be confused with ruby, "plum" sapphire, spinel, tourmaline, synthetic corundum, doublets, beryl, and glass. The properties of rhodolite are intermediate between those of pyrope and almandite. The refractive index is usually 1.76 ($\pm .01$) and the specific gravity 3.84 ($\pm .10$). Rhodolite shows an absorption spectrum similar to that of almandite.

Spessartite garnet is but rarely used as a gemstone. As a gemstone it is usually transparent yellow to yellow-brown, but dark orangy-brown stones have been reported. It resembles closely the hessonite variety of grossularite, and may be confused with brown zircon, sphene, topaz, tourmaline, citrine, glass, doublets, and beryl. The refractive index is 1.80 ($\pm .01$) and the specific gravity 4.15 ($\pm .03$). The hardness is 7 to 7.5.

Hambergite is a rare beryllium borate that is occasionally cut as a gemstone when it is encountered in transparent crystals. Its principal recommendation is its hardness of 7.5. In a gem form, it is a colorless, transparent material marked by a high birefringence: indices are near 1.555 and 1.626. It is positive in sign, with the beta index at 1.586. It crystallizes in the orthorhombic system and has

Descriptions and Property Variations of Gemstones

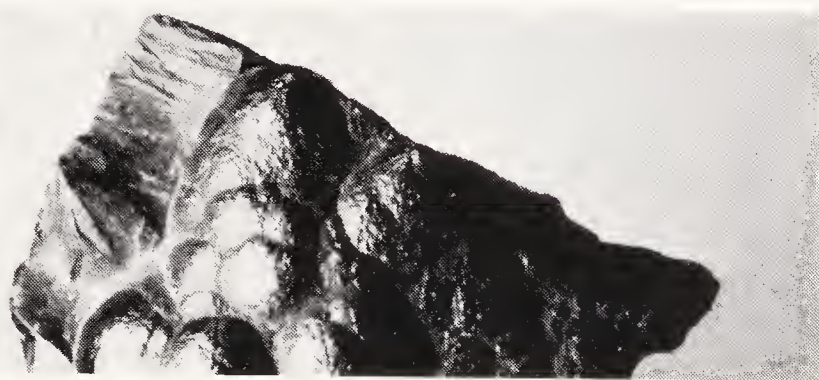

Figure 144

Botryoidal hematite. Note splintery fracture (left).

perfect prismatic cleavage; it also has good pinacoidal cleavage, so it is quite fragile. The specific gravity is 2.35.

Hematite is an opaque dark gray to black mineral with a metallic luster. It is carved for cameos and intaglios. It is characterized by a red-brown streak and a splintery fracture. Only the substitute first marketed as “hemetine” resembles hematite. It is distinguished from hematite by its rough to nearly waxy fracture. Much of the early material also had a black streak and a high specific gravity (up to 7.0). The best of these hematite substitutes has the same gravity and streak, requiring either examination of a fracture surface or X-ray diffraction for detection. A stamped impression of a carving would of course eliminate hematite. Stamped impressions are found in steel which is also used as a hematite imitation. Steel has a metallic streak and a specific gravity of 7.7 or more. Spherical beads of hematite have been offered as “black pearls” while faceted hematite has been called “black diamond.” Hematite has a specific gravity of $5.20 (\pm .08)$, and a hardness of 5.5 to 6.5. Hematite is so inexpensive that the only reason for a substitute is that impressions can be stamped in, rather than carved. This is the easiest method for separating an imitation from the natural. See Chapter XXVIII for identification details.

Hypersthene is another pyroxene that is closely related to enstatite. Additional iron raises the properties and makes the pyroxene hypersthene rather than enstatite. Bronzite, a brown chatoyant pyroxene found in diamond pipes, is hypersthene. R.I. $1.69 \pm .02$ to $1.705 \pm .022$; S.G. $3.4 \pm .1$.

Idocrase or vesuvianite is best known as a gem material in its translucent californite variety, an aggregate which resembles jade. Rarely, transparent greenish-brown to green single crystal material is faceted for collectors. The californite variety occurs in a translucent somewhat mottled yellowish-green with white to light gray. It resembles poor quality jade and substitutes.

Idocrase is doubly refractive, crystallizing in the tetragonal system. No cleavage direction is easy or perfect in the material. The refractive indices 1.713 ($\pm .012$) to 1.718 ($\pm .014$), the birefringence near .005 and it is uniaxial negative. The specific gravity of idocrase is about 3.30 to near 3.5, but the jade-like material is nearer the lower figure (it just floats in pure methylene iodide, or sinks slowly). The hardness is 6.5. See Chapter XIII for typical absorption spectra. See Grossularite Garnet.

Iolite, also known as cordierite and dichroite, is considered a gem material when transparent. It occurs in blue to purple colors of low intensity and is characterized by very strong trichroism. The trichroic colors are usually colorless to light yellow, blue, and dark blue-violet to violet. Distinct cleavage in one direction is sometimes noted. Iolite crystallizes in the orthorhombic system, and is biaxial negative. The gemstones that may be confused with iolite include sapphire, spinel, quartz, and tourmaline. The close property value approximation of quartz causes no difficulty in identification because of iolite's strong pleochroism. The refractive indices are 1.542 ($-.010, +.002$) to 1.551 ($-.011, +.045$) and the specific gravity 2.61 ($\pm .05$). The hardness is 7 to 7.5.

Jade includes both jadeite and nephrite. The former is known also as "Chinese or Burmese Jade" and the latter as "Siberian, New Zealand, or Spinach Jade."

Jadeite is a semitransparent to nearly opaque mineral which furnishes the finest jade. It occurs in green of high intensity, mottled green and white, white, violet, brown, orangy-red, and yellow colors. In its finest green color nothing but emerald and glass bear a close resemblance in appearance. In poorer qualities and other colors jadeite may be confused with nephrite, idocrase, grossularite, soapstone (talc), glass, serpentine, sillimanite, prehnite, and chalcedonic quartz. Jadeite, a mineral of the pyroxene group, crystallizes in the monoclinic system, and is optically biaxial

Descriptions and Property Variations of Gemstones

positive. Although jadeite has two directions of easy, perfect cleavage (at angles of 93° and 87° as in spodumene), the aggregate structure conceals it except in the rare case that the grain size is large, when it imparts a bladed appearance. The refractive indices are 1.66 ($\pm .007$) to 1.68 ($\pm .009$) but a single hazy reading near 1.66 is most common. The specific gravity 3.34 ($\pm .04$) and the hardness is 6.5 to 7.

There are several other materials bearing a superficial resemblance to jade that are sometimes carved as inexpensive substitutes for it. Pseudophite (better known by the misnomer, "Styrian jade," from its source, Styria, Austria), resembles serpentine but is a variety of a chlorite-group mineral; refractive index near 1.57, specific gravity 2.7, hardness 2.5. Agalmatolite, or pagoda stone, a compact, massive alteration product related to muscovite mica and pyrophyllite, is also frequently carved by the Chinese; refractive index between 1.55 and 1.60, specific gravity 2.75-2.80, hardness 2.5 to 3.5. Saussurite is an alteration product of feldspar that is usually in good part zoisite. Thus it often shows R.I.'s near 1.70 or 1.71 and in the low 1.50's. Often, it is a mottled green and white, with the white usually unaltered feldspar. Portions of the white may have altered to zoisite, however. The feldspar portions fluoresce red to short wave. It is seen often in carvings as a substitute for jadeite. S.G. usually slightly under 3.3 and hardness near 6.5. Verdite is a combination of the green chrome-mica, fuchsite, in a clay; refractive index near 1.58, specific gravity about 2.9, hardness 3.

Translucent, light-colored jadeite may be identified conclusively by a strong sharp line at the edge of the violet at 4370\AA in the spectroscope. This line is often concealed by general absorption in that region in deep-green stones or in dyed stones. It is difficult to see in opaque or nearly opaque stones. Distinguishing between dyed and natural green jadeite may be accomplished by the spectroscope. The distinct differences between dyed and undyed material are shown in the table of spectra in Chapter XIII. In dyed jadeite that has faded somewhat, the dye band is often visible only when light is passed through a long section of the piece.

Hong Kong is now offering lavender jadeite in a form they have

labeled as treated. This is difficult to detect except that the color seems to be concentrated in cracks, and naturally colored material seems to fluoresce to long-wave ultraviolet whereas treated material tested to date is inert.

Nephrite, a tough, compact variety of actinolite or tremolite, minerals in the amphibole group, is an important jade mineral. It is translucent to opaque and is found in dark green, gray, white, blue-green, yellow, black, and red colors. The most important type is that known as "Spinach or Chinese Jade" which is a fairly dark green of lower intensity than the green of jadeite. Gem materials confused with nephrite include amazonite, serpentine, jadeite, soapstone (talc or steatite), sillimanite, idocrase, prehnite, grossularite, chalcedonic quartz, and glass.

Like jadeite, nephrite would exhibit perfect cleavage (two directions at 56° and 124°) except for its finely crystalline aggregate structure. A splintery fracture is ascribed to nephrite, but it is seldom evident. More common is a rough fracture with a dull luster. The refractive indices are 1.61 ($\pm .005$) to 1.63 ($\pm .008$), with the usual appearance on the refractometer, a broad reading near 1.61. The specific gravity is 2.95 ($\pm .05$) and hardness 6 to 6.5. Usually, a razor blade will not scratch nephrite, except with great difficulty. If green material is treated to a richer green, a dye line is seen in the spectroscope.

Sometimes the felted structure of nephrite grades into zones of actinolite with a parallel orientation of crystals. This may give an excellent chatoyant effect in a cabochon, but it has the fragility of actinolite instead of the toughness that the matted structure gives to nephrite. This material is properly called actinolite cat's-eye.

Jet is a fine-grained, compact, opaque black variety of coal which has long been used as a gem material because it takes an excellent polish and is easily carved. It is imitated by glass, plastics, and a vulcanized rubber product.

Jet is amorphous, has a hardness of 2.5 to 4, a specific gravity of 1.32 ($\pm .02$), and a refractive index of 1.66 ($\pm .02$). The fracture is rough and has a dull luster. When touched by a red-hot point, the odor is similar to that of coal.

Descriptions and Property Variations of Gemstones

Kornerupine is a rare mineral occasionally used as a gemstone. It appears most frequently in parcels of gemstones from Ceylon, usually labeled tourmaline. As a gemstone it is transparent in colorless, yellow, brown, and green. It may be confused with tourmaline of the dark greenish-brown type common in Ceylon, peridot, beryl, topaz, and quartz. Kornerupine crystallizes in the orthorhombic crystal system, and is biaxial negative with the high and intermediate indices close together. The refractive indices are close to 1.657 ($\pm .002$) and 1.680 ($\pm .003$); the birefringence near .013; the specific gravity, 3.30 ($\pm .05$); and the hardness 6.5. Easy, perfect (two-directional) cleavage often is evident. The pleochroism is strong, especially in the Ceylon material, with very dark reddish-brown and yellow-green as the predominant colors. In light green kornerupine, green and yellow to red-brown are observed.

Kyanite is a mineral infrequently cut as a gemstone. It occurs in light to dark blue, green, colorless, and brown colors in a transparent form with the blue color most used in gemstones. The blue color usually exhibits fairly strong zoning. Kyanite is of interest because of the extreme variability of hardness with direction, with a 4 to 5 hardness encountered in one and 7 in another. Very easy cleavage is encountered in one direction and a less perfect cleavage at 74° to the first. Kyanite crystallizes in the triclinic system and is biaxial negative. The refractive indices are near 1.716 and 1.731 and the specific gravity 3.62 ($\pm .06$). In dark blue kyanite, the pleochroism is nearly colorless, dark blue-violet, and blue. Finest gem quality kyanite is most likely to be confused with sapphire and spinel, and lighter material with aquamarine, topaz, synthetic spinel, and light sapphire.

Lazulite is a blue mineral usually encountered as a gem material when in a translucent to semitranslucent form with a blue color resembling lapis lazuli in appearance. It has been faceted on rare occasions when found in small intense blue transparent crystals. In most cases the lapis-like material is mottled with white.

Lazulite may be confused with lapis lazuli (it is often called "False Lapis"), sodalite, azurite, dyed chalcedonic quartz, and,

Descriptions and Property Variations of Gemstones

perhaps, fluorite. Lazulite crystallizes in the monoclinic system and is biaxial negative. The refractive indices are near 1.61 and 1.64. The specific gravity is 3.09 ($\pm .05$) and the hardness 5 to 6. Cleavage is indistinct. The transparent material shows dark violetish-blue and colorless to light blue as dichroic colors.

Lazurite or hauynite (lapis lazuli) is an intense blue to violetish-blue semitranslucent to opaque material long used as a gemstone because of its beauty of color. Lapis lazuli is characterized by the presence of small metallic yellow inclusions of pyrite.

The gem materials substituted for lapis lazuli and which may be confused with it include lazulite, sodalite, azurite, dyed chalcidonic quartz, glass, sintered synthetic spinel and plastics. A drop of hydrochloric acid on lapis reacts to the extent that a distinct hydrogen sulphide (rotten eggs) odor is detectable, in contrast to substitutes. Lapis fluoresces green to short wave.

The mineral of which lapis lazuli is a variety crystallizes in the cubic system. No cleavage is evident. The refractive index is near 1.50 and the hardness is 5 to 6. Although the specific gravity is usually near 2.75, it varies considerably, depending on the amount of pyrite and other impurities. Material with 2.60 readings are uncommon, but it is not rare for material rich in pyrite to reach 3.00.

Dyed lapis-lazuli is detected by rubbing the surface with a white cotton swab dipped in fingernail polish remover. Blue dye comes off on the swab.

Leucite is a colorless potassium-aluminum silicate, with a hardness of 6, and a specific gravity of 2.5. Some of the rare transparent colorless crystals have been cut for collectors. It is a pseudocubic material that shows approximately a .001 birefringence. Its refractive indices may be as low as 1.504-1.505 to 1.508-1.509. It appears to have a high degree of dispersion, but the color is caused by interference in thin repeated twinning lamellae.

Malachite is a semitranslucent to opaque light to dark yellowish-green mineral used principally for ornamental purposes but it is also cut *en cabochon*. Malachite frequently is banded with light and dark green colors alternating in a pattern similar to agate. In addition, a radial fibrous structure with a high luster on

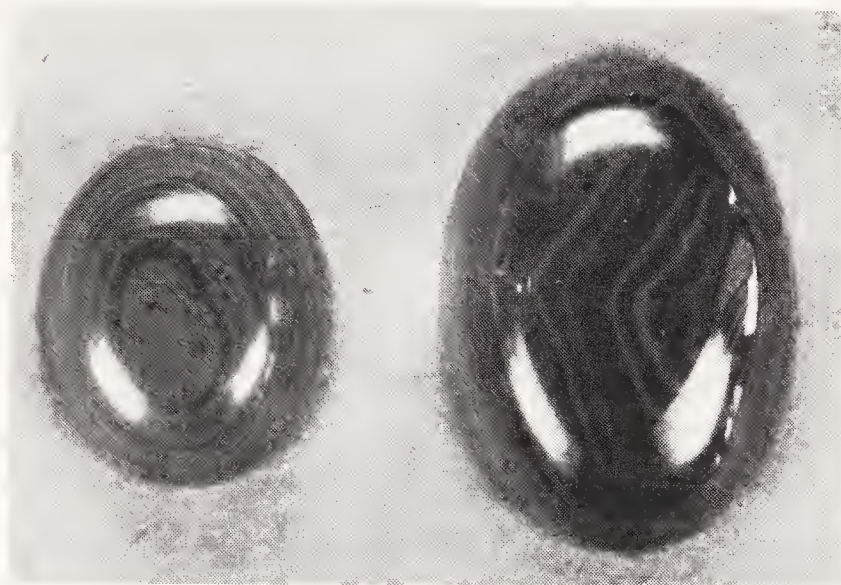

Figure 145
Typical agatelike banding in malachite.

the individual needles lends some malachite an attractive sheen. Since malachite occurs with azurite, a deep violetish-blue mineral, cut malachite may exhibit blue patches of azurite. The only gem materials which conceivably could be confused with malachite are very poor quality green turquoise, variscite, dyed calcite, faustite, glass, and plastics.

Malachite crystallizes in the monoclinic system and has a hardness of 3.5 to 4 if compact. Porous material may be softer. The refractive indices are near 1.66 and 1.91. The high birefringence may be evident upon rotation of a Polaroid plate before a "spot" reading on the refractometer. The specific gravity for compact material is near 3.95, but some malachite is so porous that it floats in methylene iodide (3.32), but gem material is near 3.95.

Marcasite is described not because it is used in jewelry, but because the name marcasite is applied to pyrite which is employed extensively in "marcasite" jewelry. Hematite is used less often for the same purpose. Marcasite is an opaque pale metallic yellow, lighter and more gray than pyrite. Upon exposure, the color deepens markedly on the surface of this unstable material.

Marcasite is orthorhombic; has a hardness of 6 to 6.5; a grayish to brownish-black streak; and breaks down rapidly, turning an unattractive brown. Marcasite has a specific gravity of 4.85 ($\pm .05$).

Moldavite, probably a natural glass, was discovered over 150 years ago in Bohemia and Moravia. Other glasses of the same apparently meteoric origin have been discovered, but only the transparent yellowish-green material from that area has been used to any extent as a gemstone.

Moldavite may be confused with beryl, peridot, artificial glass, doublets, triplets, tourmaline, topaz, and chrysoberyl. The refractive index of moldavite is usually near 1.48, but may be as high as 1.52. The specific gravity is 2.40 ($\pm .04$), and the hardness about 5.5. The internal appearance is similar to that of artificial glass in that flow lines and bubbles are encountered.

Obsidian is a volcanic glass sometimes fashioned as a gemstone. Although most obsidian is black and nearly opaque, rather transparent green, brown, and yellow material is known. Semitransparent dark brown to black obsidian is seen most frequently in cut stones and a black material with attractive white patches is known as flowered obsidian. It is rarely confused except with varieties of quartz, from which it is easily separated by its single refraction and low property values. Flame obsidian is dark brown to black with white to golden reflections seen in certain orientations in an effect similar to the aventurescence of sunstone. Obsidian has a refractive index of 1.50 ($\pm .02$), specific gravity of 2.40 ($-.07$ to $+.10$), and a hardness of 5 to 5.5. Flawed obsidian may give a polariscope reaction similar to that of chalcedony, but the vitreous luster on fracture surfaces of obsidian distinguishes it from chalcedony. Tiny black inclusions are distributed generally, but may be concentrated in rough layers. Some of the inclusions may be elongated prisms of the dark minerals that crystallize early in the cooling of a granite magma.

Odontolite, otherwise known as "bone turquoise" or "fossil turquoise," is composed of fossilized bones and teeth of extinct vertebrates colored blue by the iron phosphate mineral vivianite. It was mined for a number of years from deposits in southern France. In color and general appearance, it provided an effective turquoise substitute. Compact material has a hardness of about 5; specific gravity, 3.1; and a refractive index that varies somewhat

Descriptions and Property Variations of Gemstones

with phosphate-carbonate compositional variation. Usually a vague reading near 1.60 is obtained. The birefringence becomes obvious (if the calcite content is large) when a Polaroid plate is used in front of the spot. Since there is always some calcite present, hydrochloric acid causes effervescence. A structure characteristic of an organic material is visible under magnification. The acid test provides the fastest means of separation from turquoise.

Opal is an amorphous hydrous silica in some varieties of which vivid colors are produced by light interference. The varieties which display this color effect include white opal (colorless to white body colors), black opal (gray to nearly black body colors), and some opal with an orange body color also exhibits the play of color. Other varieties without the play of color include orange to orangy-red transparent material called fire opal, and nontransparent opal in a number of colors, resembling chrysoprase, jasper, and other chalcedonic quartz.

Glass imitations of fine black and white opal bear little resemblance to the natural material, nor do other gemstones. Opal doublets, employing a thin natural opal top are common. Fire opal may be confused with glass and the nontransparent varieties, with chalcedonic quartz.

Opal has a hardness of 5 to 6.5 and a specific gravity of 2.15 (— .90, + .07). The refractive index is very low. Most white and black opal is near 1.45, but a range of 1.40 to 1.50 has been noted. Fire opal may give readings as low as 1.37. In general, fire opal has a refractive index below that of glass employed as gem imitations. In contrast to chalcedony which may resemble some varieties of opal, the luster on opal fracture surfaces is vitreous.

Dense white opal that shows a play of color masked by the translucency of the material is often treated in the same manner as is used to make black onyx from gray agate. It is cooked for an extended period in a sugar solution and then the sugar is turned to black in an acid bath. The product shows a fragmented but vivid play of color that seems to be confined to a very thin surface layer. It is detected by the presence of many black spots under magnification. (See illustration.)

Another type of treatment of white opal that imparts a black color is one referred to as "smoked" opal. For this treatment very low property white opal from Mexico is surrounded with brown wrapping paper and heated in a crucible until the wrapping paper is charred and finally consumed. The result is a very black opal, opaque to transmitted light and one with very low properties. The refractive index is about 1.37 and it is so porous that the tongue tends to adhere to it. It is difficult to obtain a hydrostatic specific gravity because the weight in water keeps increasing as water is absorbed. Fast readings as low as 1.26 have been obtained.

There is a variety of opal that resembles a replacement of a rock composed of about 1/8 inch pellets. It is called oölitic opal. Even the natural material has a superficial resemblance to sugar-treated black opal, so it must be examined carefully. Synthetic opal is now common. See Chapter X. Plastic impregnated opal is discussed in Chapter XIV.

Painite, a dark-red gem mineral, was discovered in the gem gravels in Mogok, Burma, by the well-known gemologist and gem collector, A.C.D. Pain. After the first discovery, no new finds were made until 1979 when Roger Kuchek found a crystal in some long held gem gravels at GIA in Santa Monica, California. It is uniaxial with a negative sign, has refractive indices of 1.787 and 1.816, the pleochroism is pale brownish-orange to ruby red, the specific gravity is 4.01, and the hardness is 8.

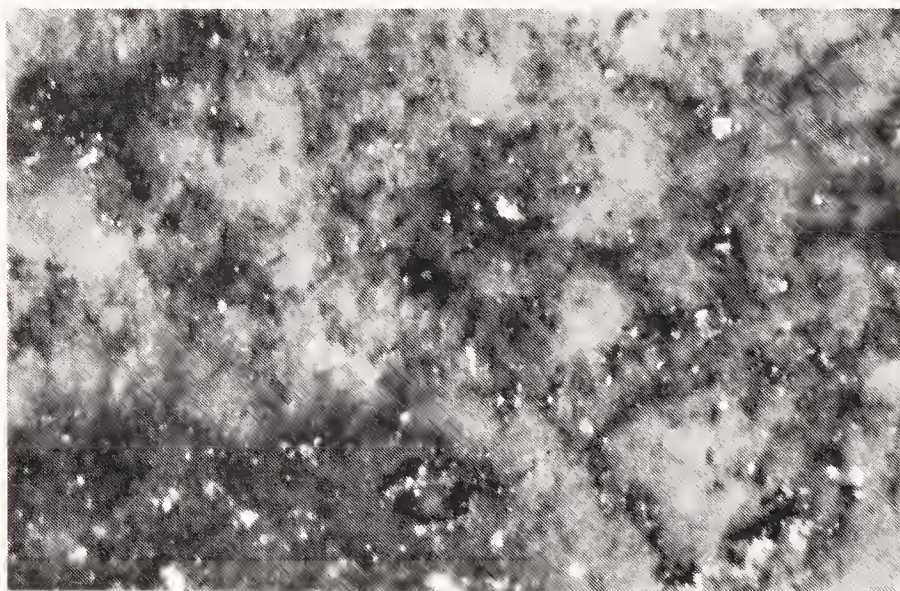

Figure 146
Sugar-treated black opal showing the characteristic peppering of black spots.

Descriptions and Property Variations of Gemstones

Peridot is the name applied by jewelers to the mineral known to mineralogists as olivine. The term chrysolite has also been applied to the material, especially to that which is pale in color. Gem quality peridot is transparent and occurs in yellowish-green, green, greenish-yellow, brownish-green, and brown colors. It may be confused with demantoid garnet (often called "olivine" by jewelers), emerald, tourmaline, chrysoberyl, zircon, sapphire, synthetic sapphire, synthetic spinel, doublets, natural and artificial glass.

Peridot is a magnesium-iron silicate, which in fine quality contains much more magnesium than iron. Since the proportions vary in different deposits, some property variation is to be expected. However, gem peridot in the usual green color or the rare brown color is usually near 1.654 and 1.690 in refractive indices, with a birefringence near .036. The specific gravity is usually near 3.32 to 3.35, but slightly higher readings are encountered occasionally. Peridot is lower in index than sinhalite and may be distinguished by both lower indices and by the fact that the beta index is always near the midpoint between alpha and gamma. Sinhalite has a beta index only about .010 below the high gamma index. The absorption spectra differ materially. (See Chapter XIII.)

Petalite is a lithium-aluminum silicate that sometimes occurs in transparent colorless crystals. It crystallizes in the monoclinic system and has perfect basal cleavage and good prismatic cleavage as well; therefore, it is rather fragile. The hardness is 6; the refractive indices about 1.502 and 1.518, with a positive sign; and the specific gravity is near 2.40. It is nonfluorescent under long- and short-wave ultraviolet, but fluoresces yellowish-orange under X-rays, phosphorescing for several seconds.

Pollucite is a mineral occurring in colorless cubic crystals. It is sometimes cut for collectors, because of its hardness of approximately 6.5. It is a caesium-aluminum silicate with a refractive index within .005 of 1.52. Its specific gravity is within .02 of 2.92. The only gem quality material is found in Maine.

Phenakite is a rare mineral which is cut almost entirely for collectors. It occurs in transparent crystals usually colorless, but sometimes is light yellow or light red. It may be confused in appearance with any of the colorless or pale gemstones in the medium refractive index range, such as topaz, quartz, beryllonite, tourmaline, spodumene, and others.

Phenakite crystallizes in the hexagonal system. It is uniaxial positive. The refractive indices are 1.654 ($-.003$, $+.017$) to 1.670 ($-.004$, $+.026$), the specific gravity 2.95 ($\pm .01$), and the dispersion .015. Phenakite has a hardness of 7.5 to 8. It has no obvious cleavage, although mineralogists refer to one direction of cleavage. Specific gravity and optic character permit effective separation from spodumene which has nearly the same indices.

Prehnite is a fairly common mineral but seldom used as a gemstone. It is usually a light yellowish-green in color and semitransparent to translucent. Transparent material has been faceted. The lighter color and greater transparency distinguish it in appearance in most cases from nephrite which it approximates in properties. Other light-colored jade substitutes such as chrysoprase, serpentine, and idocrase may be confused with prehnite.

Prehnite is usually found in crystalline aggregates of tiny orthorhombic crystals. The refractive indices are near 1.616 and 1.649. In contrast to nephrite, which seems to give a fairly strong reading only near 1.61, prehnite usually gives an indistinct reading nearer the middle of its range at 1.625 to 1.635. The specific gravity is 2.88 ($\pm .06$), either barely floating or sinking very slowly in pure bromoform (2.89). Distinct cleavage may be evident. Prehnite has a hardness of 6 to 6.5, and is biaxial positive. Prehnite is characterized by an absorption band centered at 4380 Å.

Pyrite is included as a gem material because of its wide use under the name marcasite. It is an opaque, pale metallic yellow mineral, which has no important imitations in the jewelry field because of its low price. However, to avoid the yellow color, hematite is used in place of pyrite in some "marcasite" jewelry. The hardness of pyrite is 6 to 6.5; its specific gravity near 5.0; its streak black; and it crystallizes in the cubic system. No cleavage is apparent.

Descriptions and Property Variations of Gemstones

Quartz, the most common single mineral, includes so many varieties and sub-varieties that have been fashioned as gemstones that a number of books have been written on this species alone.

There are two prominent subspecies of quartz, crystalline and cryptocrystalline. Gemstones from transparent crystalline quartz are cut usually from single crystals, while other stones cut from crystalline quartz may include in the fashioned stone a number of crystal grains. The grain size is large compared to that in cryptocrystalline material. Mineral collectors and amateur lapidaries have applied variety names to thousands of types of chalcedonic quartz. In this descriptive section, only the most important gem categories will be mentioned.

Crystalline Varieties. Colorless, transparent quartz is called rock crystal. In appearance it may be confused with any of the colorless gemstones and substitutes in the medium and low refractive index ranges. Transparent light to dark purple to violet quartz is called amethyst. There are many gemstones which exhibit colors somewhat similar to those of various grades of amethyst. These include among others tourmaline, kunzite, synthetic and natural sapphire and spinel, some garnet, zircon, apatite, and fluorite. The dichroism of amethyst is weak, with purple and reddish-purple the dichroic colors in fairly dark material. In fine qualities, dichroism may be medium.

Semitransparent to translucent light red to violetish-red quartz is called rose quartz. Not infrequently rose quartz is asteriated, in which case it is frequently improved by backing the cabochon with a colored mirror. In appearance only tourmaline and fluorite are likely to resemble rose quartz.

Smoky Quartz and *cairnngorm* are names applied to dark brown grayish-yellow to almost black, transparent to semitransparent quartz. Obsidian, tourmaline, and glass are most likely to produce gemstones similar in appearance.

Transparent light to dark yellow, yellow-brown, orange-brown, reddish-orange, and brown quartz is called citrine by mineralogists and topaz quartz by jewelers. Some colored stone dealers incorrectly call finer qualities topaz alone, while others misrepresent all citrine as topaz. Citrine or topaz quartz may be confused in appearance with topaz, hessonite, beryl, sphene, tourmaline, zircon, synthetic or

Descriptions and Property Variations of Gemstones

natural sapphire, doublets, glass, chrysoberyl, and transparent orthoclase.

Transparent to semitransparent, single crystal quartz also occurs in a light to dark yellowish-green color produced by heat-treatment of certain amethyst. This material, to which no variety name has been applied, is somewhat similar in appearance to some colors of chrysoberyl, zircon, demantoid, peridot, tourmaline, and glass.

Aventurine Quartz is the name applied to translucent quartz which contains many tiny highly reflective or intensively colored inclusions. The inclusions are hematite, mica, or one of a number of colored minerals. Depending on the nature of the inclusions, aventurine may resemble aventurine feldspar, glass (“goldstone”), jade, or jade substitutes.

Tiger-Eye is the name applied to a pseudomorph of quartz after crocidolite asbestos which retains the fibrous structural appearance of the asbestos. Tiger-eye is usually yellowish-brown in color and translucent, but it is dyed or bleached to a number of other colors. Its appearance is fibrous with the fibers somewhat wavy. The result is similar to a wavy chatoyancy. Tiger-eye has a fracture that is splintery.

Cat’s-Eye quartz has a straight fibrous appearance in contrast to the wavy fibrous structure of tiger-eye. It occurs in gray-brown, green, and greenish-yellow translucent pieces. In finer quality, i.e., with finer fibers, it may resemble very closely the chrysoberyl variety. The cat’s-eye variety of tourmaline may be confused with the quartz variety. Tiger-eye is fashioned into stones giving a coarse single cat’s-eye effect, and may be dyed or bleached to a variety of colors.

Properties of Crystalline Quartz. Crystalline quartz is notable for the constancy of its major properties. The refractive indices are 1.544 and 1.553 and the birefringence .009, almost without variation. Quartz crystallizes in the hexagonal system and is uniaxial positive. The specific gravity is between 2.65 and 2.66 – and constant for crystalline (but not cryptocrystalline) material. Quartz has no distinct cleavage. The fracture is conchoidal, with a vitreous luster on fracture surfaces.

Cryptocrystalline Varieties. There are many gem varieties of the

Descriptions and Property Variations of Gemstones

very fine grained or cryptocrystalline subspecies of quartz. The term chalcedony, which refers specifically to white, gray, blue-gray, and black cryptocrystalline quartz, is applied also to all varieties of the subspecies.



Figure 148
Moss agate.

Figure 147
Typical fracture surface on
amethyst or other crystalline
quartz.



Chalcedony includes semitransparent to translucent white, gray, blue-gray, and black fine-grained quartz. Some of the white material resembles moonstone, but lacks the floating blue light that characterizes the feldspar variety and possesses a conchoidal waxy fracture in contrast to the vitreous cleavage or fracture surfaces of feldspar. Glass may resemble chalcedony in both appearance and properties but possesses a conchoidal vitreous fracture.

Carnelian is a low intensity red to orange and is semitransparent to translucent. It resembles jade and fire opal of similar color and is imitated by glass.

Sard is the term applied to brownish-red to red-brown translucent chalcedony. It is darker and less intense in color than carnelian. Jade, glass, and common opal may resemble sard.

Chrysoprase is a semitransparent to translucent light to medium yellowish-green chalcedony. It may be confused with jadeite, jade

substitutes, prase, opal, poor qualities of emerald, bowenite serpentine, and glass. The S.G. of chrysoprase is usually over 2.62.

Bloodstone or heliotrope is a semitranslucent dark green chalcedony with brownish-red spots. There are no gem materials or imitations that resemble bloodstone closely.

Moss Agate is a semitransparent to translucent white to light gray chalcedony with dendritic black or green inclusions.

Agate is a translucent chalcedony with curved or irregular bands of different colors or different depths or transparencies of the same hue. The colors are usually red, brown, white, gray, and blue-gray. The bands follow the contours of the cavity in which the agate was deposited. Although such minerals as malachite, smithsonite, and calcite may have a similar structure, only calcite (onyx marble) resembles agate.

Onyx is applied to agate-like chalcedony in which the bands are straight and parallel. The term has been used by colored stone dealers to apply to any dyed chalcedony. The colors and translucency of true onyx are similar to those of agate. Onyx marble (calcite) resembles onyx in appearance.

“Black onyx” is the term used throughout the jewelry trade for chalcedony dyed to an opaque black.

Sardonyx is onyx with alternate bands of sard or carnelian colors with white or black layers.

Chrome Chalcedony. A variety of rich-green chalcedony colored by chromium oxide is a recent addition to the gem firmament. It resembles fine jadeite and has often been sold as jade. It is easily distinguished by its much lower R.I. and S.G.

Jasper is an impure semitranslucent to opaque chalcedony which occurs in combinations or single colors of red, yellow, brown, dark green, or grayish-blue. Only pottery or glass imitations are likely to be confused with jasper.

Properties of Cryptocrystalline Quartz. Unlike crystalline quartz, chalcedony does not have constant properties. The specific gravity is 2.60 (± 0.05). It is usually 2.60 to 2.62, but less compact material may be even lower than 2.55. The refractive indices are near 1.535 to 1.539. In monochromatic light, two readings at those points are encountered frequently, but in white light one reading is encounter-

Descriptions and Property Variations of Gemstones

ed in that vicinity. Chalcedony shows no cleavage. The fracture is conchoidal and the luster on fractures is dull to waxy. The luster on fracture surfaces furnishes a simple means of distinguishing from glass. The hardness is just under 7.

Rhodizite is a very rare mineral which has been fashioned as a gemstone for collectors. In gem quality it is a transparent colorless, light yellow, and light yellowish-green material. It is also known in a light red translucent variety.

Rhodizite crystallizes in the cubic system. Its refractive index is 1.69 and specific gravity 3.40. The hardness is 8. It is identified by its isotropic character and 1.69 refractive index. While glass may have the same properties otherwise, the hardness and inclusions of rhodizite distinguish it.

Rhodochrosite, the manganese-carbonate member of the calcite mineral group, occurs both in light red transparent crystals and in a red and almost white agatelike structure. Its major use is for carvings and other ornamental objects in the nontransparent form, but some transparent material is faceted for collectors. It has rhombohedral cleavage; indices of 1.597 and 1.817; a hardness of 3.5 to 4.5; the specific gravity is about 3.7 for crystals, and slightly lower for massive, agatelike material. It is negative in sign. Rhodochrosite effervesces slightly to hydrochloric acid.

Rhodonite is a light to medium violetish-red (flesh-red) manganese silicate used mostly for ornamental objects. The semi-translucent to semitransparent stone usually contains black inclusions. Rhodonite is resembled only by coral among gemstones.

Rhodonite crystallizes in the triclinic system and has two perfect cleavages inclined at $92\frac{1}{2}^{\circ}$ to each other. In massive form, however, it is exceedingly tough. Depending upon the manganese content, the refractive indices vary from 1.72 to 1.733 for the low index and 1.73 to 1.744 for the high. The specific gravity varies from about 3.30 to 3.68. The optic character may be either positive or negative. For rhodonite spectrum, see Chapter XIII.

Descriptions and Property Variations of Gemstones

Rutile. Natural rutile is usually a metallic black, but sometimes red transparent material is encountered. This type has been cut occasionally for collectors. Its refractive indices are 2.616 and 2.903, the specific gravity is approximately 4.25, and the hardness is 6 to 6.5. It is usually not fully transparent. Synthetic rutile is common.

Scapolite is the name given to a group of minerals used infrequently as gemstones. The gem qualities include transparent colorless, yellow, light red, greenish to bluish-gray, and violetish-blue. Semitransparent scapolite may be chatoyant. The light red (pink) and whitish stones are most frequently chatoyant.

Scapolite is most frequently confused with beryl or quartz in appearance, but may resemble in appearance tourmaline, topaz, apatite, and other gemstones light in color and low in index. Although the scapolite group in nature contains minerals with refractive index and specific gravity values near quartz, the usual gem quality material is more likely to be confused with beryl in testing. However, the birefringence is much greater. The usual indices are 1.550 (± 0.002) to 1.572 (± 0.002), and the specific gravity 2.68 (± 0.06), with a birefringence of .022. In the unlikely event that material in the lower 1.544 to 1.556 index class is encountered, the negative optical sign of the uniaxial material serves to distinguish it from quartz. In addition, scapolite shows perfect cleavage in two directions at 90° to one another. Light yellow fluorescence is common in scapolite. Pink and yellow are usually high in index, and blue low.

Scheelite, the most important ore of tungsten, sometimes occurs in colorless, yellow or brown transparent crystals, which may be cut for collectors. The hardness is 5 and the specific gravity is approximately 6.12. Refractive indices are 1.918 and 1.934. It occurs in the tetragonal system and has a positive sign. Scheelite fluoresces strongly in a light-blue color under short-wave ultraviolet light. A yellow Czochralski synthetic is available.

Serpentine is an alteration mineral often used as jade substitute, especially in ornamental objects. It occurs in light to dark

Descriptions and Property Variations of Gemstones

yellowish-green to greenish-yellow colors and is translucent to semitranslucent. The verd antique variety is used for decorative wall facing and for table and counter surfaces. While common serpentine has a hardness of 2.5 to 4, williamsite, one attractive green variety (often with small black inclusions) is usually 4, and the most attractive variety, bowenite, has a hardness of 5 to 5.5. Serpentine crystallizes in the monoclinic system and it is very finely crystalline in the common massive form. The usual refractive index is 1.55 to 1.56, but indices as low as 1.49 and as high as 1.57 have been reported. The specific gravity is 2.57 (± 0.06) for common serpentine and williamsite and 2.6 to 2.8 for bowenite. Both bowenite and williamsite may closely resemble chrysoprase, jadeite, or nephrite. The greenish-yellow variety shows a broad absorption band in the blue at about 4600 to 4700 Å. Common serpentine is sometimes dyed a jade-like color. Natural colors include black, white and brown.

Sillimanite or fibrolite is a mineral which occurs commonly in a massive semitranslucent to opaque form sometimes used for ornamental purposes and as a substitute for jade. Rarely in a transparent to translucent form it is fashioned as a gemstone for collectors. The latter form may be chatoyant. The massive material is usually grayish-white, grayish-green, brown, or brownish-green. The transparent material is usually a grayish-blue. This variety resembles spinel, sapphire, iolite, and euclase. Sillimanite crystallizes in the orthorhombic system and has one easy cleavage. It is positive in optic sign. The refractive indices are near 1.659 and 1.680 for transparent material, but may be as low as 1.64 and 1.66, with the birefringence nearer .015 which is lower than the usual .02 for transparent material. The specific gravity is 3.24 (± 0.02), but may be somewhat less if massive material is not compact. The hardness is 6 to 7, and its dispersion low.

Sinhalite is a brownish-green to brown gemstone long thought to be brown peridot. Its refractive indices are 1.668 and 1.707 and the specific gravity, 3.48. It is biaxial, negative. Even in a brownish-green color, peridot has a specific gravity very close to that of pure methylene iodide. Although it usually sinks, it does so much more

slowly than sinhalite. In addition, sinhalite is strongly negative in sign (beta is usually 1.697, whereas the beta reading for peridot is almost exactly at the half-way point). Sinhalite has a distinctive absorption spectrum, by which it may be distinguished from peridot readily.

Smithsonite is a zinc carbonate which occurs in a translucent to semitranslucent form in white, yellow, light green, and light blue colors. In certain colors it may resemble chrysoprase, jade, or common opal, but the blue is quite distinctive.

Smithsonite is distinctive for its agate-like structure in lovely pastel colors. The refractive indices are 1.62 to 1.85, showing the large birefringence characteristic of the carbonates. Use of a Polaroid plate with the refractometer will reveal this if the stone is correctly oriented. It has a high specific gravity — 4.30, and a hardness of 5. It is uniaxial with a negative sign.

Sodalite is a dark blue semitransparent to semitranslucent mineral used frequently as a substitute for lapis lazuli. Sodalite rarely contains the pyrite that characterizes lapis-lazuli. Sodalite is frequently veined with a white mineral giving an appearance similar to that of the lapis lazuli mined in Chile. Sodalite may be confused also with lazulite and quartz of either the natural form colored by dumortierite or the dyed chalcedonic variety.

Sodalite crystallizes in the cubic system and has no easy cleavage. It has a refractive index near 1.48. The specific gravity is usually 2.24 (± 0.05), but may go to 2.35, and the hardness is 5 to 6.

Sphalerite, the principal ore of zinc, is considered a gem material by collectors in the rare transparent form because of its high refractive index and tremendous dispersion. In the form in which it is cut it is usually green, greenish-brown, yellow-brown, or reddish-brown. Synthetic rutile (titania), sphene, hessonite garnet, zircon, and fancy diamonds may resemble sphalerite.

Sphalerite crystallizes in the cubic system and has a perfect dodecahedral cleavage. The refractive index is near 2.37, the specific gravity 4.05 (± 0.02), and the hardness 3.5 to 4. The dispersion far

Descriptions and Property Variations of Gemstones

exceeds that of any common natural gemstone, being over .15 compared to diamonds .044 and the .051 of sphene. Because of its extreme fragility it requires careful handling. The hardness test should never be used on a stone suspected of being sphalerite.

Sphene (titanite) is a fairly common mineral which is rarely found in a transparent gem quality form. In the opaque form, sphene is dark brown to black. In transparent gem quality it is yellow, brown, or very rarely a fine intense green. It is characterized by a high dispersion and luster. In appearance it may be confused with sphalerite, synthetic rutile, diamond, zircon, grossularite or spessartite garnet, and possibly with other gemstones of similar color such as citrine, beryl, chrysoberyl, and topaz.

Sphene crystallizes in the monoclinic system and may show a two-directional cleavage, with a $66\frac{1}{2}^{\circ}$ angle between cleavages. In addition a parting may be evident. The refractive indices are near 1.90 and 2.03, but a considerable variation has been recorded. The birefringence varies from .1 to .135 or more or roughly double that of zircon. Specific gravity is 3.52 ($\pm .02$), hardness 5 to 5.5, and it is biaxial positive.

Spinel is a well known transparent gemstone known, unfortunately, more for resemblance to ruby and sapphire than for its own beauty. The colors of spinel, especially in blue and red always seem less intense than their counterparts in the corundum family. The common colors of spinel include red-orange (flame spinel), light to dark orangy-red, light to dark slightly grayish-blue, greenish-blue, grayish-green, and light to dark purple to violet. Spinel is known also in yellow, and black — the latter being opaque. In its various colors, spinel may be confused with ruby, sapphire, zircon (the hyacinth or flame variety especially), amethyst, garnet, synthetic corundum and spinel, glass, and doublets.

Spinel crystallizes in the cubic system and possesses no ready cleavage. Its refractive index is usually near 1.718, but readings as low as 1.71 and as high as 1.76 have been recorded. Among gem varieties, refractive indices between 1.71 and 1.72 are considered normal. However dark blue-green material may read to 1.76 or even

higher. The specific gravity is usually near 3.60, with 3.57 to 3.72 as the gem range. The high-index dark blue-green material may reach 4.0 or higher. The hardness is 8. Since synthetic spinel almost always reads 1.73 or higher in index, the refractometer reading furnishes a valuable indication as to identity. Separation of spinel from pyrope is discussed under garnet (pyrope). When part or all of the magnesium in spinel's composition is replaced by zinc, the property values increase as shown above. In a partial replacement, the result is called gahnospinel, and in the full replacement — zinc aluminum oxide — it is called gahnite. See Chapter XIII for typical absorption spectra.

Spodumene is a species occurring in the pyroxene group. Fine transparent spodumene in light red to purple colors is used most frequently as a gemstone and is known as kunzite after the late George Frederick Kunz. It occurs also in very light to medium green to yellowish-green (known as hiddenite, after the man who discovered it in North Carolina), and in a colorless to yellow color. Spodumene may be confused with topaz, tourmaline, spinel, beryl, synthetic corundum, synthetic spinel, doublets, glass, corundum, and also with emerald, peridot, chrysoberyl, and demantoid garnet.

Spodumene is biaxial with a positive sign and has refractive indices of 1.660 (± 0.005) to 1.676 (± 0.005). The specific gravity is 3.18 (± 0.03) and its hardness is 6 to 7. Spodumene is biaxial and optically positive. Cleavage is perfect in two directions with a 93° angle between the two directions. In addition, a platy structure in a third direction may cause easy separation. The pleochroism of kunzite is strong with near colorless and red to violet colors evident both in the dichroscope and to the naked eye as the stone is turned. Hiddenite shows bluish-green and yellow-green. The yellow variety shows definite differences in depth of yellow. Today, hiddenite is extremely rare. The largest fine stone on record is under three carats.

Staurolite is a hydrated iron-aluminum silicate, best known for its brown twin crystals in the form of crosses. Usually, it is semitranslucent to opaque, but rarely transparent brown crystals occur. Some have been cut for collectors. The key properties are its

Descriptions and Property Variations of Gemstones

orthorhombic crystal forms, refractive indices of 1.736 and 1.746, a specific gravity of 3.65 to 3.77, and a hardness of 7 to 7.5.

Stibiotantalite is a rare pegmatite mineral, an oxide of antimony, tantalum and columbium. One locality has produced transparent yellow crystals of cuttable quality. Small numbers have been cut for collectors. Properties vary, depending on the variable ratio of tantalum to columbium. It is orthorhombic, with indices of about 2.37 and 2.45; the specific gravity is about 7.5. It is biaxial with a positive sign. Hardness is 5.

Stichtite, a semitranslucent to opaque hydrated carbonate of magnesium and chromium, occurs in an attractive light violetish-red color. It is sometimes cut in cabochon forms or carved; however, its hardness is 1.5 to 2. Refractive indices are 1.516 and 1.542, the specific gravity is 2.15 to 2.2, and it effervesces in hydrochloric acid.

Strontium Titanate. See Chapter X (Synthetic Gemstones).

Taaffeite is a newly described gemstone which has been found only in a pale red-violet transparent form. Taaffeite crystallizes in the hexagonal system. Its refractive indices are 1.719 and 1.723, and the specific gravity is about 3.61. It is negative in optic sign. Its hardness is 8.

Talc, also known as steatite or soapstone, is used principally for carved ornamental objects which are substituted for jade. For ornamental purposes semitranslucent to opaque gray, grayish to brownish-green, brown, and yellow-brown talc is used. It may be substituted for jade, but the very low hardness makes its identification very simple.

Talc occurs in the monoclinic system, but in the massive form is usually cryptocrystalline. The refractive indices are 1.54 to 1.59, but in the massive ornamental form, a single dim reading is encountered between these figures; and the specific gravity near 2.75. Since the massive varieties used for ornamental objects are usually impure, variation of gravity may be as much as 2.55 to 2.80. Talc is biaxial

negative. The hardness is 1 to 2.5, so the fingernail will scratch it usually.

Thomsonite, a member of the zeolite group, is used for cabochons when it occurs in white, yellow, pink and green radial fibrous groups. It has a hardness of 5 to 5.5, a specific gravity of 2.3 to 2.4, and variable refractive indices in the 1.515 to 1.54 range, but with a birefringence range from about .006 to .012. It is a hydrated calcium-sodium-aluminum silicate.

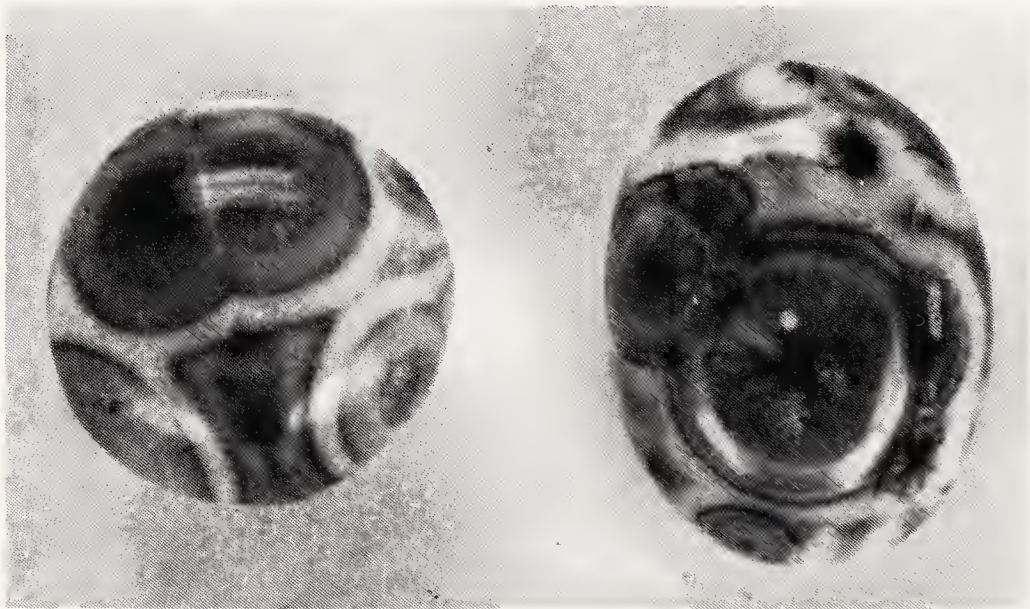

Figure 149
Thomsonite cabochons showing the typical radial fibrous groups.

Topaz is well known to the jeweler and layman alike, but usually the stone known to them as topaz is a substitute such as quartz (citrine), or a synthetic or glass. In the past, any yellow stone was called topaz with a prefix to denote to the initiated the actual nature of the stone. Today, many stone dealers offer citrine as topaz incorrectly and reserve the term “precious topaz” for the true topaz.

Topaz occurs in a variety of colors in addition to the transparent yellow, yellow-brown, and orangy-brown colors most popular in the topaz range. The other colors include very light to almost medium red (usually but not always the result of heat-treatment), very light

Descriptions and Property Variations of Gemstones

to light blue, very light green and violet, light greenish-yellow, and colorless.

Irradiation by gamma rays may change lightly colored topaz to deep brown or deep blue colors, some of which do not fade. The blue colors induced are often deeper than any heretofore known in nature.

The gemstones which may resemble topaz include quartz (citrine and rock crystal), chrysoberyl, hessonite garnet, tourmaline (especially pink, but also colorless, and yellow-brown), corundum (pink, yellow, and light blue sapphire), beryl (golden beryl, aquamarine, and morganite), spodumene (kunzite), synthetic corundum, synthetic spinel, doublets, and glass. Of the unusual materials sometimes used as gemstones, topaz may be confused with danburite, apatite, scapolite, phenakite, euclase, transparent orthoclase or labradorite, beryllonite, and brazilianite.

Topaz crystallizes in the orthorhombic system and has perfect cleavage. The refractive indices for yellow to brown, and light red stones are near 1.629 and 1.637, and for colorless, light blue, and light green stones near 1.609 and 1.617. The birefringence is nearly constant at .008. Topaz is biaxial positive, has low dispersion, and is 8 in hardness. The specific gravity is 3.52 (± 0.02) for yellow to brown, and light red stones, and slightly higher — 3.56 (± 0.03) — for other colors. Tourmaline and glass are the stones which closely resemble topaz in appearance and refractive index. Glass is singly refractive and tourmaline has a much lower specific gravity and much higher birefringence. The unusual stones of similar index, namely andalusite, apatite, brazilianite, and danburite, are not close to topaz in specific gravity. Topaz is rather more pleochroic than might be anticipated in a gemstone usually so light in tone. Yellow topaz exhibits distinct trichroism — brownish-yellow, yellow, and orange-yellow. Blue topaz exhibits weak to distinct dichroism, depending on the depth of blue — colorless and light blue. Red topaz shows distinct to strong dichroism — light red and yellow.

Tourmaline is a gemstone noted for the large number of colors in which it occurs. These include light to dark red to purple and brownish variations of these hues, also light to dark green,

HANDBOOK OF GEM IDENTIFICATION

yellowish-green, greenish-yellow, brown, greenish-brown, colorless, black, light to dark blue, yellow-brown, and brownish-orange. In addition, tourmaline with two colors in the same stone (usually red and green) is not uncommon. In gem quality it is usually transparent, but opaque black tourmaline is used occasionally for jewelry purposes. Chatoyant tourmaline is encountered occasionally. Since tourmaline occurs in such a wide range of tones and intensities of so many hues, there are many transparent gemstones likely to be confused in appearance with one or more varieties of tourmaline. Fortunately, tourmaline offers little difficulty in identification by the basic instruments.

Tourmaline crystallizes in the hexagonal system and possesses no perceptible cleavage. The refractive indices are 1.624 (± 0.005) and 1.644 (± 0.006), with the birefringence usually near .020. Very dark stones (especially black) may give higher readings and higher birefringence. Since tourmaline is uniaxial and negative in sign, the high reading (numerically) is constant, and the lower variable. The specific gravity may be stated generally as 3.06 (± 0.05), with the light red stones on the low side of this range, the blue on the high side, and black tourmaline above the upper limit of transparent gem tourmaline. Tourmaline is noted for its strong dichroism. Dark green stones show very dark brownish-green and lighter yellow-green colors. Lighter green stones, heat-treated to remove the murky greenish-brown, show weaker dichroism of blue-green to yellow-green colors. Blue tourmaline (usually greenish-blue) shows dark and light blue dichroism, with the dark blue tending toward the greenish. Brown tourmaline shows very dark brown and light greenish-brown as dichroic colors. The two colors seen in red tourmaline are dark red and light red. All dichroic colors may vary somewhat from those described, depending on the depth of color of the gemstone. See Chapter XIII, for typical absorption spectra.

Tourmaline has low dispersion and a hardness of 7 to 7.5. It is easily identified by its strong birefringence and uniaxial negative character on the refractometer. Topaz, andalusite, danburite, and apatite all have much lower birefringence.

Turquoise is a semitranslucent to opaque intense light blue in

Descriptions and Property Variations of Gemstones

finest gem quality, tending toward yellowish-green in poor quality. In many cases, as fine blue turquoise is worn it tends to assume a greenish-blue color. Glass imitations in excellent simulation of turquoise both in appearance and physical properties often cause difficulty in identification. Of natural substitutes, variscite resembles poor quality green turquoise and chrysocolla, a copper silicate resembles blue turquoise. The latter is too soft (2 to 4) and fragile to become an important substitute. Both powdered turquoise and various mixtures of chemicals giving the same color have been bonded in plastic to imitate turquoise. That bonded in plastic has a molded appearance on the back and is cut rather than powdered by a knife blade. The hardness is much lower than that of turquoise.

The refractive indices of turquoise are near 1.61 and 1.65. Only one reading is seen on the refractometer, usually near 1.61. The specific gravity is 2.76 (−.45,+08). Turquoise has a hardness of 5 to 6. On conchoidal fracture surfaces it has a dull to nearly waxy luster, in contrast to the vitreous luster of its glass imitation.

Plastic, paraffin, wax, oil, and most other treatments of turquoise are detected by the use of a hot point, such as an electric needle. When the red-hot point is brought near the paraffin- or wax-impregnated turquoise, the paraffin or wax melts and runs ahead of the needle. Plastic impregnation is detected by the acrid odor of the plastic when the point is touched against the stone. Impregnated material is usually below 2.50 in specific gravity.

Imitation turquoises usually contain copper compounds; therefore, a drop of hydrochloric acid quickly turns yellow when placed on the back.

To a competent spectroscopist, the absorption spectrum of turquoise in reflected light is characteristic. The common plastic-coated substitutes do not show this spectrum. (See Chapter XIII.)

Variscite or Utahlite is a semitranslucent to opaque mineral of a slightly yellowish-green color. When fashioned, it may contain yellow to greenish-yellow matrix. Variscite bears a striking resemblance to turquoise in texture and opacity, but not in color except for the poorer turquoise qualities.

Variscite crystallizes in the orthorhombic system, but is encoun-

HANDBOOK OF GEM IDENTIFICATION

tered in nodular masses. The refractive indices are near 1.56 and 1.59 and the specific gravity 2.50 (± 0.08). The luster on the rough fracture surface is dull. Variscite has a hardness of about 4 to 5.

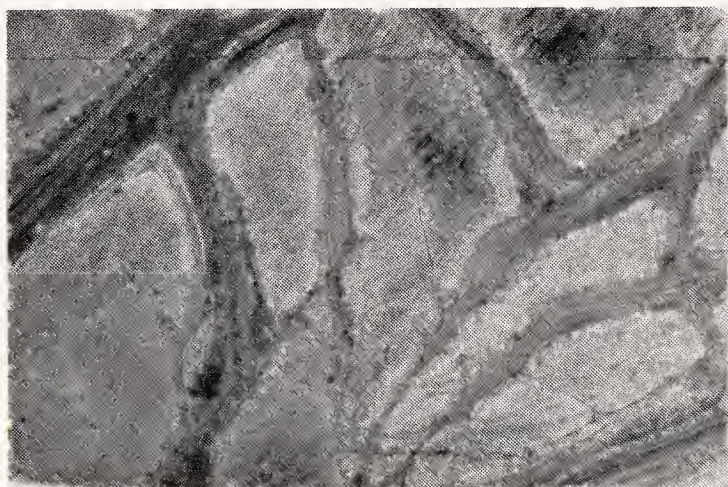

*Figure 150
Variscite and other
phosphates as seen
in a section of a
typical nodule.*

Willemite, a zinc ore, has been fashioned as a gemstone when found in a transparent form. While cut stones are almost all of a greenish-yellow hue, it is found in green, red, and brown colors as well. In appearance it is most likely to be confused with beryl, peridot, or greenish-yellow varieties of other gemstones such as chrysoberyl.

Willemite crystallizes in the hexagonal system and has a perfect cleavage. The refractive indices are near 1.69 and 1.72 and the specific gravity near 4.00 (± 0.10). Willemite is uniaxial positive. Its hardness is 5.5. The willemite likely to be fashioned as a gemstone has a notably strong yellow-green fluorescence under ultraviolet radiation.

Zincite, the red oxide of zinc, in its rare occurrence in transparent crystals or grains makes a lovely gem material. It has a direction of perfect cleavage parallel to the base of the hexagonal crystal, and its hardness is only 4 to 4.5, so it is of interest primarily to collectors. It is deep red or rarely orange-yellow. The specific gravity of gem material is nearly 5.7 and the refractive indices are 2.013 and 2.029.

Descriptions and Property Variations of Gemstones

Zircon is notable for its distinctive beauty in a variety of colors. Best known for the colorless variety used widely as a diamond substitute, zircon is important also in the light blue color achieved by heat-treatment. Other beautiful varieties include brownish-orange, yellow, yellowish-green, brownish-green, dark red, and light red-violet. Gem quality zircon is transparent. Zircon may be confused in appearance with a number of other gemstones, including diamond, corundum, spinel, chrysoberyl, beryl, topaz, tourmaline, most of the garnet family, peridot, sphene, quartz, synthetic spinel, synthetic corundum, doublets, synthetic rutile, and glass.

Because of a tendency for zircon to break down from its tetragonal zirconium silicate structure to what is apparently monoclinic zirconia and amorphous silica, the mineral is divided into three types. Although the three types have been called alpha, beta, and gamma, and a, b, and c, it seems less confusing to refer to the types as high, medium, and low property zircons.

High property zircon includes the colorless, blue, and brownish-orange zircons largely. The refractive indices are near 1.925 and 1.984. Zircon, which occurs in the tetragonal system, is uniaxial, and positive in sign. The birefringence is so strong that it may be detected by the naked eye or a low power loupe. The specific gravity is 4.70 (± 0.03). No easy cleavage is evident. The fracture is conchoidal, but heat-treated zircon shows a strong tendency to pit along facet edges. Since most zircon is heat-treated, this tendency to pit or crumble at the surface is common to most gem zircons. Zircon has a high dispersion, .038, or just less than diamond. The dichroism of blue zircon is strong, the colors being blue and colorless. In other varieties, dichroism is weak.

Low property zircon occurs usually in shades of green, but brown and orange stones are known. The refractive indices are much lower than those of high property zircon, namely 1.810 (± 0.030) and 1.815 (± 0.030). The birefringence is very low, as shown by the figures above. The specific gravity is near 4.00 (± 0.07). In addition, the

hardness is lower, being 6. Both low and medium property zircon are likely to exhibit a strong zonal structure similar to that caused by repeated twinning in corundum. Green zircon may be confused in appearance with demantoid, green sapphire, peridot, and chrysoberyl.

Medium property zircon is that which has properties perceptibly above those of low zircon and below those of high zircon. Thus, the range between about 1.83 and 1.91 for the low or constant index and 1.84 to 1.95 or 1.96 for the high is considered medium zircon. The birefringence range for medium zircon is considered to be about .006 to .008 at the low end to about .050 near high zircon. Since the indices are above the range of the refractometer except for zircon very low in index, the gemologist seldom attempts to classify zircon carefully as to property type, although an accurate specific gravity determination permits such classification. Medium zircon is that between about 4.08 and 4.10 to about 4.55. The colors include dark red and particularly brownish-green. Medium zircon is optically positive and may show a weakly biaxial interference figure (small angle between optic axes).

Zircon presents perhaps the most widely varied group of absorption spectra among the gemstones. Almost all zircons, including colorless stones, show a strong narrow line at about 6535Å in the red and a fainter companion at 6590Å. In green, low property zircon, the main lines may be broad and smudged. Occasional red zircons show no line. Zircons from Burma and Ceylon of brown, yellow and yellow-green color often show many sharp lines (caused by uranium). See the table of typical spectra in Chapter XIII.

Zoisite. Until late in 1967, zoisite had been known to gemologists more as a source of ornamental materials than as a gem mineral. The discovery of a rich-blue, transparent, strongly trichroic variety in Tanzania changed the situation almost overnight. If oriented correctly in cutting (and usually after heat treatment), the new variety is a rich sapphire blue. Its strong trichroism is characteristic: deep blue, violetish red and greenish yellow.

Descriptions and Property Variations of Gemstones

Zoisite, a mineral in the epidote group, also has two varieties that have occasional use as gem materials, especially for ornamental objects. The light-red to rose-red variety is known to mineralogists as thulite. It is semitransparent to semitranslucent. If sufficiently transparent, strong trichroism may be detected in single-crystal material in yellow, light and dark violetish red. A massive form known as saussurite is used as a substitute for jade and for ornamental objects when found in a greenish-gray to green color. It is a feldspar that has been partially altered to zoisite. Mottled green and white translucent and semitransparent material used as a jade substitute is detected by the 1.70 index of the zoisite portions and the red fluorescence of the feldspar areas to short-wave ultraviolet.

Zoisite crystallizes in the orthorhombic system. The blue transparent variety has indices of 1.691-1.704. It is optically positive, with beta near 1.695. The hardness is 6½ to 7 and of the other varieties, 6 to 6½. The specific gravity of thulite is 3.30 to 3.25. An R.I. reading separates thulite from rhodonite and saussurite from jadeite. The blue variety is unlikely to be confused with other gem materials.

Chapter XVII

A Procedure for the Identification of Gemstones and Their Substitutes

Most gemstones of unknown identity may be assumed to be one of only a few possibilities by one familiar with the appearance of the important species. If the unknown is set in a ring or other jewelry setting, the species that are cut almost exclusively for collectors are unlikely choices; as a result, the total number of likely possibilities is only about twenty-five. When the tester has classified the hue, tone and intensity of the color, he has reduced the number of species into which the stone could be fitted still further.

If the gem tester is particularly observant, he can reduce the list of possibilities to a very small number. First, he notes the color and transparency of the unknown. If it is transparent and colorless, there are many possibilities; but any hue present, whether dark or light, reduces the number either slightly or materially, depending on the hue and tone. A nontransparent stone in some colors can only be one of just a few; for example, a banded stone in two shades of green is almost surely malachite, dyed agate, dyed onyx marble, glass or plastic. Thus, the first glance noting color and transparency only has a distinct value to the gem tester.

In this first view, many other characteristics are important. The luster should give a fair idea of the refractive index range. Since luster is determined by the refractive index plus the flatness of the polished surface, the higher the luster, the higher the refractive index of the unknown. Is the luster metallic, submetallic, adaman-

Identification of Gemstones

tine, subadamantine, vitreous, subvitreous, waxy, greasy, silky, or dull? The first three categories surely reflect the presence of indices over the refractometer scale. Subadamantine suggests an index range high on the scale, vitreous midscale, and subvitreous low on the refractometer scale. Comparison with gems of known identity helps one to classify indices readily. Waxy and a greasy luster is usually associated with a poorly polished surface, and silky is applied to a gemstone with many needlelike inclusions.

Another characteristic is the nature of the color. Is it light, medium or dark — is its intensity vivid or dull? Spodumene is never dark in tone — only a few gem materials occur in a vivid chrome-green color; e.g., emerald, jadeite, demantoid garnet, diop-tase and dyed or backed stones.

The degree to which dispersion is evident in a transparent faceted stone provides an important clue to the identity of the unknown. Only a few gemstones and substitutes have a degree of dispersion sufficient to be obvious and noteworthy to the unaided eye; the presence or absence of fire is a significant feature. The stones that are strong in this property include synthetic rutile, strontium titanate (Fabulite), demantoid, sphene, diamond, zircon and some glass.

Is any cleavage evident? Only a few gem species, such as dia-mond, topaz, spodumene and the feldspars, are likely to display obvious cleavage.

Is doubling of opposite facet junctions obvious to the unaided eye or under low magnification? Stones showing strong doubling include synthetic rutile, sphene, zircon, peridot and tourmaline, among the important gem materials.

How well is the stone polished; this may suggest its hardness range. Stones with rounded facet edges and poor polish in general are probably soft; however, synthetic corundum and other inex-pensive materials are sometimes polished so rapidly that the quality

of polish is inferior. The irregular fractures at the surface of synthetic corundum caused by the heat generated in too-rapid polishing are typical of that material.

In colored stones, is there an obvious pleochroism as the stone is turned? Common gemstones with sufficient pleochroism to be noted by the unaided eye include kunzite, andalusite, tourmaline, zircon, ruby, sapphire and alexandrite. Among the rarer stones, it is likely to be obvious in kornerupine, benitoite, iolite, epidote and others.

Is there a luster difference between crown and pavilion or between different portions of the crown? This is usually obvious in garnet-and-glass and other doublets or triplets with wide differences in index between parts.

What is the luster on fracture surfaces? This is particularly important in translucent and opaque materials. Most transparent stones in the middle to low index range have a vitreous luster on conchoidal fracture surfaces, as do glass imitations; however, many natural, translucent and opaque stones have granular or other types of fracture. Those with conchoidal fractures seldom have a vitreous luster. Chalcedony usually has a waxy luster on fractures and turquoise a dull luster. This provides a ready means of separating natural stones from glass with its vitreous fracture luster.

If any of the various optical phenomena are present, the number of possibilities is reduced materially. This is true of play of color, change of color under different lights, and adularescence. Weak asterism and chatoyancy are found in a number of species. In addition to the gems in which asterism is frequently seen, ruby, sapphire and quartz, there are many others in which a star is very rarely encountered. These include beryl, peridot, chrysoberyl, topaz, spinel, garnet, diopside and orthoclase. Beryl, demantoid, nephrite, enstatite, diopside, scapolite, kornerupine, feldspars, apatite, zircon, sillimanite and others may show a cat's-eye effect,

Identification of Gemstones

in addition to the more familiar chrysoberyl, quartz and tourmaline.

A red ring seen near the girdle in a transparent faceted stone when it is turned table down on a white surface suggests a garnet-top doublet. Flashes of red color from a deep, vivid-blue stone suggests synthetic spinel, or the tanzanite variety of zoisite.

There are many more characteristics that assist the tester in narrowing the number of possibilities an unknown stone could be.

Having noted the characteristics that are obvious to the unaided eye or by using a low power loupe, the next step in this elimination system, is to determine the refractive index or indices of the unknown. This determination, if done in monochromatic light or with a red Wratten A filter, often eliminates all but one gemstone. At other times, only two or three possibilities remain on the basis of the refractive index determination.

The procedure from this point on depends on the findings made with the refractometer. The next step is chosen to most effectively separate the remaining possibilities left after the refractive index test. This is indicated for each group of possibilities determined on the basis first of color, and then refractive index range, in the next eleven chapters.

For example, suppose a transparent yellow gem proves to be above the limits of the refractometer in refractive index. There are several possibilities that the unknown could be. The most likely, perhaps, are diamond, zircon and synthetic rutile. However, the diamond could be naturally colored or colored by irradiation and heat treatment. In addition, a diamond doublet is a possibility and, although exceedingly unlikely, glass could have an index above the refractometer limits as well as the garnet top of a garnet-and-glass doublet.

There are several things to determine, each successive step indicated by the results of the previous one. Perhaps the first information needed is whether it is singly or doubly refractive. This could

be determined by polariscope, but, since we also need to know some of the characteristics to be seen under magnification, and both zircon and synthetic rutile have exceedingly high birefringence, a condition easily recognized in transparent materials under magnification, the use of a magnifier seems to be the next logical step. If strong doubling of opposite facet edges is seen and the stone has natural inclusions, zircon would be identified because synthetic rutile is eliminated. As another possible advantage, a doublet could be detected under magnification or, if bubbles were seen in a stone with no doubling, glass would be identified. If the stone proved to be a diamond, only the spectroscope would be satisfactory for distinguishing between naturally and artificially colored material.

If the stone were doubly refractive and no inclusions were visible, specific gravity, strength of doubling, or strength of dispersion could distinguish between high property zircon and synthetic rutile, or immersion in methylene iodide would show up the great difference in index by the great difference in relief. Thus, the number of tests depends on the findings of each of the tests as taken. Therefore, with an unknown yellow transparent stone, one or two tests may suffice or it may be necessary to take half a dozen.

In each of the succeeding chapters, the identification of the gemstones occurring in one or two colors is discussed, and the means by which accurate determinations may be made following the refractive index determination. Seven chapters on transparent gem materials are presented first, and then four on nontransparent stones.

Chapter XVIII

The Identification of Transparent Purple and Violet Gemstones and Their Substitutes

Although several other stones have been listed, the indisputably deep-colored purple or violet gems include amethyst, almandite or rhodolite garnet, amethystine sapphire, spinel and tourmaline; and in light colors, kunzite, morganite beryl, topaz and their substitutes. The others listed are borderline in color or rarely encountered in gem use.

First Test. Clean the stone and examine it with the unaided eye or a low power loupe, to detect any identifying characteristics. In addition, note its luster, degree of dispersion, whether doubling of opposite facet edges is visible, if there is any obvious dichroism or cleavage, and whether any of the several optical phenomena are present. Observations made initially may enable the gemologist to confirm a probable identity with just a test or two. If, in this preliminary examination, any of the following properties or conditions are noted, the probabilities include the following:

Molded back facets prove the unknown to be a glass or plastic imitation. (See Chapter XI.)

A luster difference between crown and pavilion or between table and the lower crown facets suggests a doublet.

Distinct color change from daylight to artificial light indicates chrysoberyl (alexandrite), synthetic alexandrite, sapphire, and synthetic alexandritelike sapphire or synthetic spinel. Since garnets with a distinct color change are not unknown, garnet is another possibility.

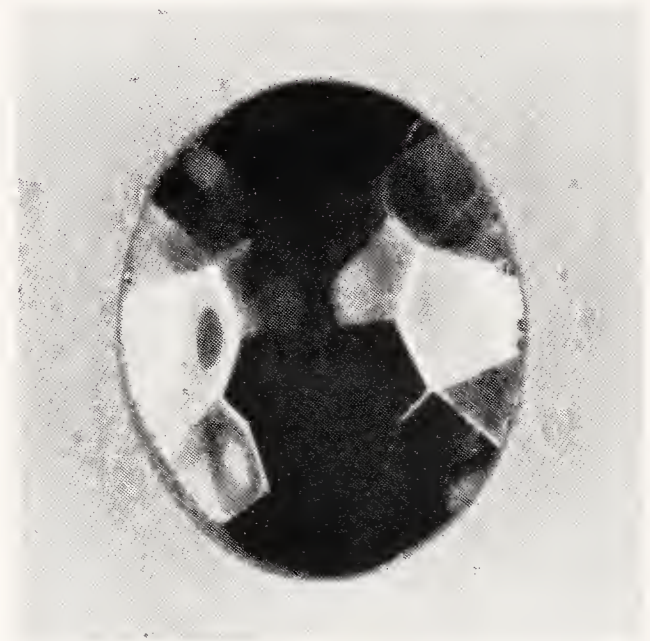

Figure 151

Unpolished concave pavilion facets, proving molding.

Warmth to the touch (compared to the cold feel of crystalline materials) is a property of amorphous materials such as glass and plastic imitations.

Adamantine luster suggests diamond.

A visible separation plane indicates a doublet or triplet.

Second Test. After an initial inspection and classification of the unknown's color and its obvious characteristics, take a refractive



Figure 152

Difference in luster between garnet cap and glass lower crown and pavilion of a garnet-and-glass doublet.

Identification of Transparent Purple, Violet Gemstones

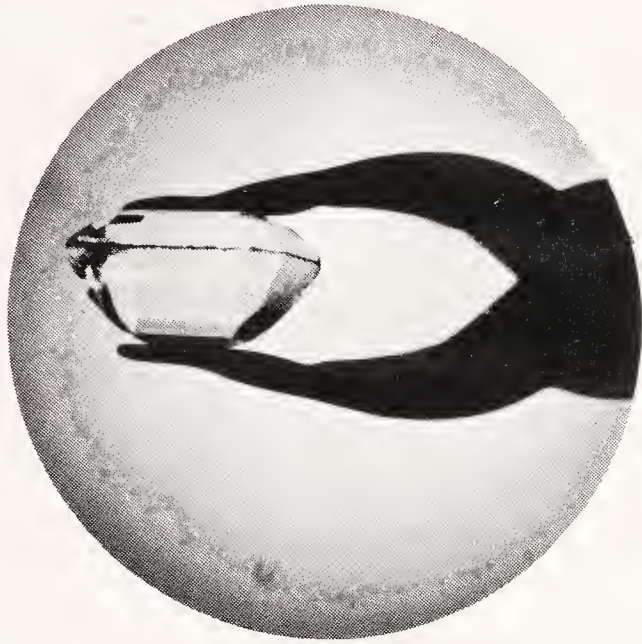

Figure 153
Cement layer on a triplet immersed in water.

index reading. If the stone has a well-polished flat facet, use the normal refractometer method. If no reading is seen and the shadow area fails to extend to the liquid line, at 1.81 (which would show that the index is over the instrument's upper limit), try the spot method.

It should be possible either to obtain a reading or to determine that the index is over the limits of the refractometer on any flat or convex polished surface, unless it is mounted in a manner that makes contact with the hemisphere impossible or unless a surface film prevents optical contact. If refractometer findings are unsatisfactory, immersion in liquids of known index should yield an approximation of the index. (See Chapter V.) If no approximation of index seems possible, magnification, polariscope, dichroscope and spectroscope findings may serve to identify the material without a refractive index determination. In rare instances, removal of the gemstone from the mounting for better magnification or for a specific gravity test may be needed. Refractive indices are given in the following table and other properties in a second table near the end of this section.

HANDBOOK OF GEM IDENTIFICATION

REFRACTIVE INDICES*

Diamond		2.417	
Zircon (high, med.)	1.925		1.984
Almandite		1.79	
Corundum	1.762		1.770
Syn. corundum	1.762		1.770
Rhodolite		1.76	
Chrysoberyl	1.746	1.747	1.755
Syn. alexandrite	1.742	1.743	1.751
Syn. spinel		1.73	
Spinel		1.718	
Spodumene	1.660	1.666	1.676
Tourmaline	1.624		1.644
Topaz	1.629	1.631	1.637
Beryl	1.585		1.594
Quartz	1.544		1.553
Plastics			
Celluloid		1.49 to 1.52	
Plexiglas and lucite		1.50	
Bakelite		1.55 to 1.67	
Polystyrene		1.59 to 1.67	
Glass (normal range)		1.48 to 1.70	
Glass (extreme range of gem imitation types)		1.44 to 1.77	

*A single figure is given for isotropic, two for uniaxial, and three for biaxial materials. Variations are shown in the refractive index tables in the Appendix.

If the scale is shadowed all the way to the liquid line, at 1.81, showing the index of the stone to be above the limits of the refractometer, there are only four possibilities: diamond, zircon, almandite garnet or a garnet-and-glass doublet. Of these, only zircon is doubly refractive, so that doubling of opposite facet edges seen under magnification in a stone with an index greater than 1.81 would prove it to be zircon. With the exception of X-ray treated stones, zircon is never violet and rarely purple. A garnet red is usually more descriptive of reddish zircon than is purple, but some zircon is likely to be classified in this color category.

A violet diamond is unusual but not exceedingly rare; it is likely to be very lightly tinted. The brilliancy, fire, sharp facet edges, high luster and characteristic girdle surface produced by

Identification of Transparent Purple, Violet Gemstones

lathe-turning identify diamond. Naturals on or near the girdle, cleavage, and crystal inclusions also are typical.

On the other hand, almandite garnet or garnet-and-glass doublets in a purple color are usually deeply colored. Almandite rarely has a refractive index above 1.80; usually, a figure in the vicinity of 1.78 or 1.79 is obtained. Since the garnet in a garnet-and-glass doublet is almandite, this applies to doublets as well. It is relatively simple to distinguish between almandite and a garnet-and-glass doublet on the basis of the appearance under magnification. The doublet shows a difference in luster on the crown between the thin cap of almandite and the lower portion of glass, in most cases, or between crown and pavilion, if the plane of separation is at the girdle. This difference can be obvious to the unaided eye after it has been observed several times. The almandite cap usually contains needlelike or other angular inclusions, and there are bubbles in the plane of contact between the garnet and the glass.

In the next lower range of refractive indices are found sapphire, synthetic sapphire, rhodolite garnet, chrysoberyl, also almandite garnets or garnet-and-glass doublets, as indicated earlier. If seen in artificial light, alexandrite may have a slightly purplish cast, but rarely the amethystine color of synthetic alexandrite-like sapphire. Usually, the artificial light color of a good alexandrite is comparable to the color of almandite garnet. Some natural sapphires show a color change from blue in daylight to violet under incandescent light. Synthetic alexandrite is violetish red to purple under incandescent light.

Under magnification the curved striae and bubbles of synthetic corundum should be visible and should identify or eliminate it as a possibility immediately. Curved striae are more prominent in synthetic alexandrite-like sapphire than in any other variety of synthetic corundum. They are usually visible directly through the table. On the other hand, angular inclusions or straight striae identify the unknown as natural. Examination under magnification of 30X, or more, also should enable a tester to determine if the doubling of opposite facet edges associated with double refraction is evident or whether it is absent. Both sapphire and the alexandrite variety of chrysoberyl have a birefringence of approximately .009,

so the doubling is slight. A strong color change from green to red (or perhaps purple-red) from daylight to artificial light in alexandrite may serve to distinguish it from corundum, or synthetic corundum. Synthetic alexandrite changes from blue-green to violetish red or purple. If the stones are loose, specific gravity would permit a quick separation between chrysoberyl and corundum; however, this should not be necessary. Chrysoberyl is biaxial positive, with the alpha and beta indices only about .001 apart. Thus, on the refractometer it acts as if it were uniaxial with a positive sign, so one index is always evident at 1.746 or 1.747. (Such information may be gained by using monochromatic light or a filter such as a Wratten red gelatin filter.) In contrast, corundum is negative in sign with a constant index at the high figure of almost 1.77. Thus, if the white-light index appears to be at 1.75 or below, chrysoberyl is indicated, and if the index is above 1.76, corundum is suggested. Distinguish between natural and synthetic alexandrite by inclusions or transparency to ultraviolet.

Rhodolite, almandite, and garnet-and-glass doublets are all singly refractive. Although all may show anomalous double refraction in the polariscope, they show neither doubling nor pleochroism. Alexandrite and amethystine, or "plum," sapphire are strongly pleochroic. Should rhodolite or almandite show strong anomalous double refraction in the polariscope and also have an index near that of corundum or chrysoberyl, the dichroscope should solve the problem. The absorption spectra for these stones are distinctive, furnishing another means of ready separation.

The next lower index group includes pyrope garnet, synthetic spinel and spinel. Pyrope with any traces of purplish or violet color usually has an index near 1.75, the borderline for rhodolite. Since rhodolite is a combination of the almandite and pyrope molecules, where to draw the line between rhodolite and pyrope is more a matter of color than index. Pyrope garnet was not listed for this section, because a purple color suggests excess almandite and higher properties. At 1.728 to 1.73, synthetic spinel is consistently .01 higher in index than natural spinel, which is usually 1.718 ($\pm .002$). Synthetic spinel differs from both pyrope and spinel, in that it is characterized by a very strong anomalous double refraction, which has a cross-hatched pattern when seen

Identification of Transparent Purple, Violet Gemstones

under 5 or 10X between crossed Polaroids. (Shown in Chapter X.) Of course, the synthetic may have gas bubbles with high relief, in contrast to the inclusions of pyrope, which show low relief and are often of irregular, rounded outlines. Natural spinel may be flawless, contain fingerprints made up of tiny octahedra, or it may have octahedral crystal inclusions of good size. These eight-sided crystals (shown in Figure 101) occur individually, in groups, and in sheets resembling the fingerprint inclusions of corundum. In this pattern, the octahedra may be so tiny that high magnification is needed to disclose their shape.

The next group of possibilities includes the kunzite variety of spodumene, topaz, tourmaline, glass and plastics. Spodumene has distinctly higher indices than any of the others in this group, with the exception of some glass and plastics. Its indices are 1.660 and 1.676. Spodumene has a positive sign (beta is near 1.666). In addition, it usually shows rather strong fluorescence under long-wave ultra-violet light. Its purple and colorless dichroic colors are apparent as the stone is turned.

Purple-red tourmaline has refractive indices of approximately 1.624 and 1.644, with a birefringence of approximately .020 and a specific gravity of about 3.04. It is easily separated from topaz, its fairly close companion in refractive index, by its great difference in birefringence, optic character, and specific gravity. Tourmaline floats and topaz sinks in methylene iodide, 3.32. The .008 birefringence of topaz is less than one-half that of tourmaline. Doubling of opposite facet junctions should be obvious in tourmaline under 20X. Tourmaline is usually deep in color, whereas topaz is inclined to be rather pale. Tourmaline is negative in sign, which on the refractometer means that the 1.644 index is constant and the 1.624 variable. On the other hand, topaz is biaxial and positive in sign; therefore, the lower reading varies less than does the high upon rotation of most facets on the refractometer.

The morganite variety of beryl is usually rather high in refractive index for the beryl species, with readings about 1.585 to 1.594 and, for beryl, a rather high birefringence of .009. There is really no other gemstone very likely to be confused with beryl

HANDBOOK OF GEM IDENTIFICATION

in this color. Quartz of the amethyst variety is typified by its 1.544 and 1.553 refractive indices. Usually, the finer the quality of amethyst, the stronger the dichroism. Strong color zoning is common in amethyst, and the so-called washboard fracture that is typical of amethyst and heat-treated citrine is another identifying characteristic.

Glasses and plastics are all singly refractive. The specific gravity of any plastic is so low that it is obvious in the form of a feather-weight heft in the hand of a gemologist.

PROPERTY TABLE FOR PURPLE AND VIOLET GEM MATERIALS
IN ORDER OF DESCENDING INDICES

Name	Polar.	Pleo.	S.G.	Hard.	Additional
Diamond	S(anom.)		3.52	10	naturals, cleavage
Zircon (high)	D	W	4.70	7.5	doubling
Zircon (med.)	D	W	4.40	7.5	doubling
Almandite	S(anom.)		4.05	7.5	spectrum
Sapphire	D	S	4.00	9	inclusions
Syn. sapphire	D	S	4.00	9	striae, bubbles
Rhodolite	S(anom.)		3.84	7-7.5	spectrum
Chrysoberyl	D	S	3.73	8.5	color change, spectrum
Syn. alexandrite..	D	S	3.71	8.5	color change, inclusions
Syn. spinel	S(anom.)		3.64	8	bubbles
Spinel	S		3.60	8	inclusions
Spodumene	D	S	3.18	6-7	fluorescence
Tourmaline	D	S	3.04	7-7.5	spectrum, doubling
Topaz	D	D	3.53	8	pleochroic
Beryl	D	D	2.82	7.5-8	uniaxial —
Quartz	D	W-D	2.66	7	interference figure
Glass	S		2.3-4.5	5	molded?
Plastics	S(anom.)		<2.00	<3	

Among the rare gem materials sometimes cut for collectors and that may occur in a purple or violet color are apatite, axinite, fluorite, iolite, scapolite and taaffeite. The identification and description of these rarely encountered gemstones is discussed in Chapter XVI, together with the means by which they are most readily separated from the stone closely resembling them. Their refrac-

Identification of Transparent Purple, Violet Gemstones

tive indices and specific gravity are given in the following table:

	Refractive Indices		Specific Gravity
Taaffeite	1.719		3.61
Axinite	1.678	1.685	3.29
Apatite	1.642		3.18
Scapolite	1.550		2.68
Iolite	1.542	1.547	2.63
Fluorite		1.434	3.18

When doped with rare earths, glass and some of the synthetics such as YAG and yttrium aluminate assume a violet color under incandescent light. They turn to grayish blue in daylight.

Chapter XIX

The Identification of Transparent Blue Gemstones and Their Substitutes

The prominent transparent blue stones include sapphire, aquamarine and zircon. This section is concerned primarily with the characteristics used to identify this trio and the means by which they may be distinguished from the gems and substitutes that may resemble them. The materials that may be confused with sapphire include synthetic sapphire, synthetic spinel, spinel, tourmaline and iolite (“water sapphire”). In light colors, both zircon and aquamarine resemble sapphire. Zircon could be confused with synthetic rutile (not commonly available in this color), diamond, pale-blue sapphire and both synthetic spinel and sapphire. Aquamarine could easily be confused with blue topaz, light-blue tourmaline, the rare stones, apatite and euclase, as well as light-colored synthetic spinel and synthetic corundum. Glass, plus doublets, triplets and foil-backs, could be confused with any of these stones. Transparent blue zoisite, first discovered in 1967, in its fine quality strongly resembles a very attractive Ceylon sapphire.

First Test. Clean the stone and examine it with the unaided eye or a low power loupe, to observe its characteristics. In addition, note the luster, degree of dispersion, whether doubling of opposite facet edges is visible, if there is any obvious dichroism or cleavage, and whether any of the several optical phenomena are present. Observations made initially may enable the gemologist to confirm a probable identity with only a test or two. If, in this preliminary examination, any of the following properties or conditions are noted, the probabilities include the following:

Strong dispersion suggests diamonds, zircon, or synthetic rutile.
Adamantine luster suggests diamond or synthetic rutile.

Identification of Transparent Blue Gemstones

Doubling of opposite facet edges is often visible to the unaided eye in a large zircon or synthetic rutile.

A visible separation plane indicates a doublet or triplet.

A molded appearance on back facets proves the unknown to be a glass or plastic imitation. (See Chapter XI.)

A coated back on a star stone suggests a star quartz or synthetic foil back.

An exceedingly low specific gravity is often noticeable in plastic imitations, when a large stone is hefted.

Warmth to the touch (compared to the cold feel of crystalline materials) is a property of amorphous materials such as glass and plastic imitations.

A luster difference between crown and pavilion or between table and the lower crown facets suggests a doublet.

Flashes of red from a dark sapphire-blue gem suggest synthetic spinel, or zoisite.

A six-rayed star in reflected light indicates star sapphire, synthetic star sapphire, or a foil back.

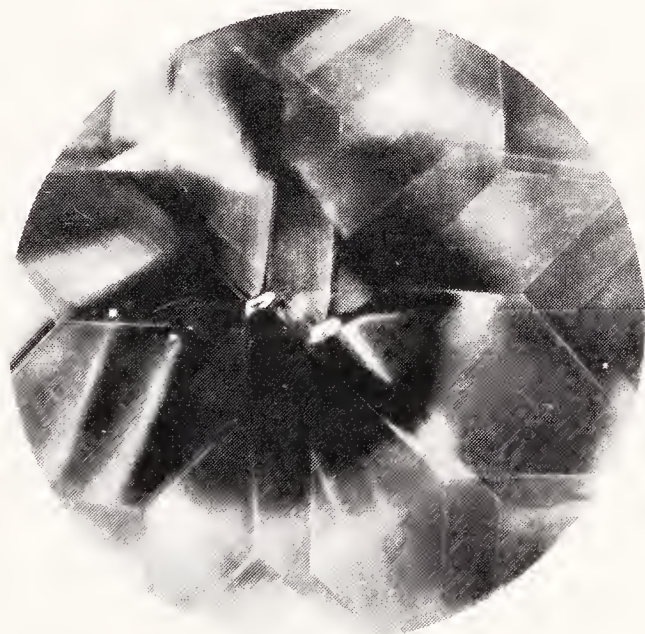

Figure 154

Doubling of opposite facet edges in a synthetic rutile.

Second Test. The possibilities may be narrowed to a few at most, if the stone is well enough polished to give a reading on the refractometer. If no regular reading is obtained on a flat facet, or on a

HANDBOOK OF GEM IDENTIFICATION

curved surface by the spot method, determine whether the scale remains dark up to the refractive index of the contact liquid, at 1.81. If the stone has a flat facet, yet the spot does not stay dark all of the way up the scale, it is possible that a film is obscuring the reading. If the manner of setting does not permit a surface to be brought into contact with the refractometer, the unknown probably can be identified by some of the other tests described. If necessary to gain a closer approximation of refractive index than that provided by an estimate of luster, try one of the other methods discussed in Chapter V.

REFRACTIVE INDICES*

Synthetic rutile	2.616		2.903
Diamond		2.417	
Zircon (high)	1.925		1.984
Corundum	1.762		1.770
Syn. corundum	1.762		1.770
Syn. spinel		1.728	
Spinel		1.718	
Zoisite	1.691	1.695	1.704
Tourmaline	1.624		1.644
Topaz	1.609	1.611	1.617
Beryl	1.575		1.58
Quartz (dyed)	1.544		1.553
Iolite	1.542	1.547	1.551
Plastics			
Celluloid		1.49 to 1.52	
Plexiglas and lucite		1.50	
Bakelite		1.55 to 1.67	
Polystyrene		1.59 to 1.67	
Glass (normal range)		1.48 to 1.70	
Glass (extreme range of gem imitation types)		1.44 to 1.77	
Opal		1.45	

*A single figure is given for isotropic, two for uniaxial, and three for biaxial materials. Variations are shown in the refractive index tables in the Appendix.

If the reading is above the scale, the only possibilities are zircon, diamond, synthetic rutile and garnet-and-glass doublets. Although glass of the type used in refractometer hemispheres could be higher, it is not used commercially for a gem substitute, since it is much too soft.

Identification of Transparent Blue Gemstones

Zircon and synthetic rutile both have very strong birefringence, but that of synthetic rutile is five times that of zircon. The dispersion of synthetic rutile is even greater relative to zircon — almost nine times as great, but in dark blue synthetics it is subdued somewhat. Zircon often shows a distinct absorption line at 6535Å and a weaker companion at 6590, whereas synthetic rutile shows no absorption line in the red. Blue zircon has a specific gravity of 4.70(\pm .03), in contrast to the approximately 4.26 of synthetic rutile. Blue zircon is strongly dichroic, with one direction a rich blue and the other colorless or yellowish. Zircon's color is sometimes intensified greatly by coating the pavilion apparently with a fluoride layer. It is recognized by the obvious iridescent sheen imparted. It may be removed by boiling in concentrated sulphuric acid. Rutile's dichroism is weak. The blue synthetic rutile is apparently not always available from the usual commercial sources.

Diamond is singly refractive and may be distinguished by this means from both synthetic rutile and zircon, the only other blue stones with which it is at all likely to be confused in appearance. Diamond with a natural blue color may be distinguished from that which has been subjected to electron irradiation by use of a conductometer; natural blue diamond (type IIb) conducts current, in contrast to an irradiated blue stone that does not. General Electric has been successful in fusing boron into diamonds, giving the stones a blue color and making them electrically conductive. This has not been done commercially at this writing.

Diamonds colored blue by electron irradiation have their color confined to within about one-half millimeter of the surface. Thus strong zonal coloring, with the color zones only slightly beneath the surface and parallel to the facets, as in early cyclotron irradiated stones, plus its lack of conductivity, identify irradiated blue diamonds.

In the unusual case that the almandite garnet cap on a garnet-and-glass doublet has an index over 1.81, it would give no reading on the refractometer; it would be easily detected by magnification by examination with the unknown immersed in a suitable liquid, by the luster difference between parts, or by the red-ring test.

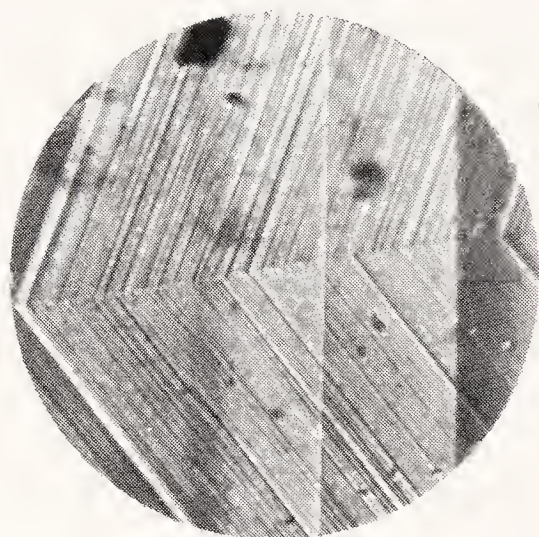
*Figure 155**Straight banding at 60° in natural sapphire*

In the 1.75 to 1.77 range, the only important possibilities are sapphire, synthetic sapphire, and doublets. Dark violetish-blue and light greenish-blue are the expected dichroic colors for sapphire and synthetic sapphire. They have a specific gravity of approximately 4.0. Under short-wave ultra-violet light, synthetic blue sapphire appears to be smudged faintly with greenish-yellow. Only the very dark blue sapphire from Thailand is likely to show a similar effect. Some natural blue sapphires show a color change from blue in daylight to violet under incandescent light.

Synthetic sapphire may be distinguished from the natural by magnification. If the stone is entirely without flaws and no color banding is discovered (an unlikely eventuality, except in Montana stones), the stones may be separated either by short-wave ultra-violet in a dark room or by the spectroscope. Natural blue sapphires from most sources show a distinct to strong absorption zone in the spectroscope, in contrast to the synthetic, in which there is none. Natural blue sapphires from Australia usually show strong bands at 4500 and 4600Å that almost merge, and a separate narrower line at about 4700Å. All three lines are usually seen in Montana and Thailand sapphires, but they are not as strong as in Australian stones. In Burma and Kashmir sapphires, often only the 4500 line is visible. In some Ceylon stones it is only very faintly seen (it may be necessary to locate the optic axis direction in the polariscope, since the line is best seen when observed by transmitted light in that direction).

Identification of Transparent Blue Gemstones

Synthetic and natural blue sapphire offer more means of separation than almost any other color variety in which natural corundum is reasonably well duplicated in appearance by the synthetic. Color banding is likely to be prominent in both and to be quickly revealed when viewed against a light background. The straight, parallel hexagonal banding of the natural distinguishes it from either the curved color banding or curved striae of the synthetic. The curved banding of the synthetic is often obvious to the unaided eye when a synthetic is placed over a white background. If the stone is immersed in a translucent white jar, placed over a light and examined under magnification from several directions, curved banding should be found in synthetic sapphire. Spherical gas bubbles are usually but not always present in the synthetic, and “silk” and “fingerprint” inclusions are characteristic of the natural. The synthetic fluoresces so weakly under short-wave ultra-violet that it must be examined in a completely dark room over a black background. Since it is often very difficult to see and some naturals show it very, very weakly, it is unwise for an inexperienced tester to call a sapphire natural without corroborating evidence. Star sapphires, plus synthetic and imitation stars are discussed in Chapters X, XXV and XXVII.

Doublets with natural sapphire crowns and synthetic sapphire pavilions are very difficult to detect when bezel set. The crown gives a typical spectrum for natural sapphire and usually shows obvious straight color banding or silk. Careful examination of the pavilion is a must.

Synthetic spinel and spinel, with refractive indices in the low 1.70 range, should be easily distinguished from any other blue stones by the fact that they are singly refractive. (We have never encountered a glass imitation in a blue color over 1.69 in index. However, if one were made, it would have a very high specific gravity — well over the 3.64 of synthetic spinel.) In addition to these two possibilities, are triplets made of two parts of synthetic spinel and blue cement, giving the stone either an appearance of sapphire or aquamarine; they are easily distinguished by immersion or under magnification. Synthetic and natural spinel are distinguished by the fact that the index of the natural is usually just under 1.72 and the synthetic is approximately .01 higher. Occa-

HANDBOOK OF GEM IDENTIFICATION

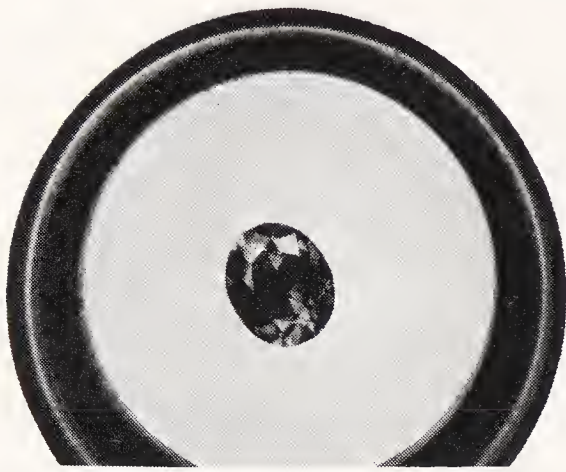

Figure 156a

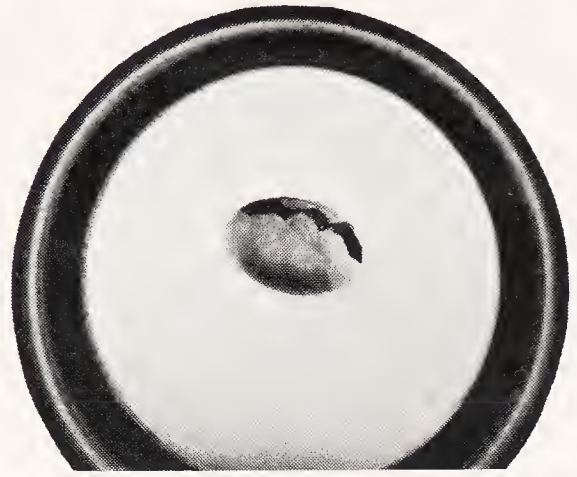

Figure 156b

A synthetic sapphire photographed in air (a) and immersed (b).

sionally, gahnospinel in a blue color may reach 1.76 in index, but this is an exceedingly rare stone. Usually, dark-blue natural spinel is a grayish-blue, in contrast to a more intense violetish-blue of the synthetic. The rich blue of the cobalt colored synthetic is more reminiscent of sapphire than it is either of natural blue spinel or synthetic sapphire. The cobalt oxide coloring agent gives rise to red flashes reflected from this otherwise excellent imitation of fine sapphire. Both this substitute for sapphire and the lighter blue that so closely resembles aquamarine is characterized by a strong red color through the emerald filter; natural spinel does not assume a comparable appearance through the filter. Natural blue spinel may appear red, but other methods, such as refractometer, spectroscope and polariscope, suffice to detect the synthetic.

Although blue zoisite resembles sapphire, it is easily identified because no other gem material resembling it is close in properties. Its strong trichroism in blue, red and greenish yellow is unique.

There should be no difficulty in distinguishing topaz from tourmaline, since topaz has a birefringence of .008, compared to approximately .020 of tourmaline; it is positive in sign, whereas tourmaline is negative. If the stone is unmounted, dropping it in methylene iodide will distinguish between topaz and tourmaline immediately, since topaz (3.56) sinks and tourmaline (3.08) floats. Glass may have an index in the topaz-tourmaline range, but the polariscope permits an easy separation from either because of the single refraction of glass. Blue topaz is low in index (1.609 to

Identification of Transparent Blue Gemstones

1.617), so there should be no difficulty in distinguishing it from tourmaline on the refractometer. Blue tourmaline is usually, but not always, dark and tends toward a greenish color, whereas topaz is more reminiscent of aquamarine. Although rarely necessary for this separation, the difference in optic character may be determined by polariscope.

Aquamarine is easily distinguished from other gemstones by a refractive index reading and from substitutes by magnification and polariscope. Synthetic spinel and sapphire, triplets, doublets, glass and plastics are the substitutes made to imitate aquamarine. All of these, with the exception of synthetic sapphire and a rare triplet made of two parts of beryl or quartz with an aquamarine-colored cement, are singly refractive.

Very rarely, quartz is dyed blue. Dye is usually readily detectable on the back of the stone, most often in the pits or cracks of a very rough back surface, or throughout if the stone has been crackled by quenching in blue dye.

Iolite is distinguished without difficulty from dyed quartz or glass by its very strong trichroism (colorless to light yellow, blue, and dark blue-violet). The indices, birefringence and specific gravity of iolite are very close to those of quartz. Plastics are sepa-

PROPERTY TABLE FOR BLUE GEM MATERIALS
IN ORDER OF DESCENDING INDICES

Name	Polar.	Pleo.	S.G.	Hard.	Additional
Syn. rutile	D	W	4.26	6-6.5	doubling, fire
Diamond	S(anom.)		3.52	10	girdle, cleavage
Zircon (high) ..	D	S	4.70	7.5	doubling, pleochroic
Corundum	D	S	4.00	9	inclusions, spectrum
Syn. corundum	D	S	4.00	9	inclusions, fluorescence
Syn. spinel	S(anom.)		3.64	8	strain pattern
Spinel	S		3.60	8	spectrum
Zoisite	D	S	3.30	6-7	strong trichroism
Tourmaline	D	S	3.08	7-7.5	pleochroic, doubling
Topaz	D	D	3.56	8	cleavage
Beryl	D	D	2.71	7.5-8	inclusions
Quartz (dyed)	D		2.66	7	dye obvious
Iolite	D	S	2.61	7	strong pleochroism
Glass	S(anom.)		2.3 to 4.5	5	molded?
Plastic	S(anom.)		<2	<3	light, soft

HANDBOOK OF GEM IDENTIFICATION

rated easily by their very low specific gravity, both to heft in the hand and in a heavy liquid.

There are a number of gem materials that are either too rare as minerals or too rarely found in a cuttable quality to be important gemstones from a jeweler's viewpoint.

Benitoite, a mineral found only in one locality, has properties that make it an excellent gemstone, since it is 6 to 6½ in hardness and has a deep blue color reminiscent of sapphire. Kyanite is a relatively common mineral, but it seldom occurs in the exceedingly attractive sapphire blue in which it is valued as a gemstone. Korerupine is a rare mineral that is better known in a brown or green color than in blue. However, so-called sea-green color is on the borderline of blue and some stones have almost an aquamarine color. Sillimanite or fibrolite, occurs in grayish-blue crystals that are sometimes faceted or cut *en cabochon* to display a cat's-eye effect. Light blue euclase resembles aquamarine as does some apatite, although blue apatite often has a slightly darker blue color than euclase. Transparent dark blue sodalite is now being faceted.

Lazulite is better known in a form resembling lapis than in a transparent form. However, very rarely, transparent lazulite crystals are found which yield magnificent blue stones with a color quite unlike that of any other gem material. It is a very intense blue with a slight greenish tint. Fluorite, otherwise known as "bluejohn," is rarely faceted because of its excellent cleavage and low hardness, but it is often carved. A brief table of the principle properties of these rarer stones is given below. All are described more fully in Chapter XVI.

	Refractive Indices			Specific Gravity
Benitoite	1.757		1.804	3.64
Kyanite	1.716	1.724	1.731	3.62
Korerupine	1.667	1.679	1.680	3.30
Sillimanite	1.659	1.660	1.680	3.24
Euclase	1.654	1.657	1.673	3.10
Apatite	1.642		1.646	3.18
Lazulite	1.612	1.634	1.643	3.09
Sodalite		1.482		2.24
Fluorite		1.434		3.18

Chapter XX

The Identification of Transparent Green Gemstones and Their Substitutes

Of the transparent green stones used in jewelry, emerald, demantoid garnet, peridot and tourmaline are important in their own right, and the others are either used mostly as substitutes or are relatively rare. In its finest quality, there is really no gemstone with a comparable color to that of emerald, with the possible exception of the Imperial grade of jadeite, the only quality that could reasonably be included in transparent category, for the finest is as transparent as a Kashmir sapphire. Of the other natural stones, a top quality demantoid or grossularite approach a fine emerald in color. Synthetic emerald, triplets, garnet-and-glass doublets and glass may all approach the color of fine emerald. Very rarely, heat-treated tourmaline from Africa is fairly close, as is the rare hiddenite variety of spodumene. The usual green tourmaline, green zircon, treated diamond and spinel are darker and less intense in color than most emeralds. Most of the others are lighter or more yellowish-green. Green YAG shows unnatural red flashes.

A newly discovered source of chrome tourmaline bears a close resemblance to emerald, and a chrome chalcedony resembles translucent to semitransparent jadeite. Synthetic alexandritelike sapphire is not green but grayish blue in daylight, so it is not discussed, even though alexandrite and synthetic alexandritelike spinel are, because their color is green in daylight.

First Test. Clean the stone and examine it with the unaided eye or low power loupe to detect any identifying characteristics. In addition, note its luster, degree of dispersion, whether doubling of opposite facet edges is visible, if there is any obvious dichroism or cleavage, and whether any of the several optical phenomena are present. Observations made initially may enable the gemologist to confirm a probable identity with a single test. If, in this preliminary examination, any of the following properties or conditions are noted, the probabilities include the following:

An exceedingly low specific gravity is often noticeable in plastic imitations, when a large stone is hefted.

HANDBOOK OF GEM IDENTIFICATION

Warmth to the touch (compared to the cold feel of crystalline materials) suggests glass or plastic.

A lustre difference between crown and pavilion or between table and the lower crown facets suggests a doublet or triplet.

Strong dispersion suggests andradite garnet (demantoid), sphene, synthetic rutile, or diamond.

Adamantine luster suggests diamond or synthetic rutile.

A visible separation plane indicates a doublet or triplet.

Molded back facets prove the unknown to be a glass or plastic imitation. (See Chapter XI.)

A red ring around the girdle when the gem is placed table down on a white background suggests a garnet-and-glass doublet.

A distinct color change from daylight to artificial light indicates alexandrite, synthetic alexandrite, or synthetic alexandritelike spinel.

Chatoyancy suggests chrysoberyl, quartz, tourmaline, or glass.

Double images of opposite facet edges may be visible to the unaided eye in sphene, zircon, peridot, or synthetic rutile.

A noticeable red color by transmitted light suggests YAG or hydrothermal synthetic emerald.

Second Test. Use the refractometer to take a refractive index reading. If the unknown has a flat polished facet, make a normal reading. If it has only curved polished surfaces, use the spot method. (Remember that the spot should not be more than 2 to 3 scale dimensions in diameter.) If it is not possible to use a refractometer because of the position of the stone in a mounting, or if no refractometer is available, it may be necessary to use one of the other methods for the determination of refractive index described in Chapter V. If no reading is seen on the refractometer, determine whether the shadow edge extends all of the way to the liquid reading, at 1.81. Any stone with a polished surface should either give a reading or be demonstrably above the limits of the instrument in index. Glass and some emeralds occasionally have a surface film that masks a reading. Rubbing the unknown by hand for a moment with rouge or cerium-oxide powder against a piece of paper or cloth on a flat surface should remove the film well enough to permit a reading. If no index is obtained by any method, proceed to other tests.

Identification of Transparent Green Gemstones

If the index is determined to be above the limits of the refractometer (i.e., greater than 1.81), there are several possibilities that occur in a green hue. Included are synthetic rutile, diamond (either treated or natural) and zircon of both the low and medium property type, plus YAG. Of these stones synthetic rutile and sphene, the former uncommon in a green color, are characterized by enormous birefringence. Synthetic rutile has unparalleled dispersion (.330 B to G) but sphene (.051 B to G), too, is a more dispersive gem

REFRACTIVE INDICES*

Syn. rutile	2.616		2.903
Diamond		2.417	
Sphene	1.900	1.907	2.034
Andradite garnet		1.885	
YAG		1.833	
Zircon (med.)	1.925		1.984
Zircon (low)	1.810		1.815
Corundum	1.762		1.770
Syn. corundum	1.762		1.770
Chrysoberyl	1.746	1.747	1.755
Syn. alexandrite	1.742	1.743	1.751
Grossularite		1.735	
Syn. spinel		1.730	
Spinel		1.718	
Peridot	1.654	1.672	1.690
Spodumene	1.660	1.666	1.676
Jadeite	1.66	1.665	1.68
Andalusite	1.634	1.639	1.643
Tourmaline	1.624		1.644
Topaz	1.609	1.611	1.617
Beryl	1.577		1.583
Syn. emerald (New Gilson)	1.571		1.579
Syn. emerald (Linde)	1.568		1.573
Syn. emerald (flux-fusion)	1.561		1.565
Quartz	1.544		1.553
Chalcedony	1.535		1.539
Plastics			
Celluloid		1.49 to 1.52	
Plexiglas and lucite		1.50	
Bakelite		1.55 to 1.67	
Polystyrene		1.59 to 1.67	
Glass (normal range)		1.48 to 1.70	
Glass (extreme range of gem imitation types)		1.44 to 1.77	

* A single figure is given for isotropic, two for uniaxial, and three for biaxial materials. Variations are shown in the refractive index tables in the Appendix.

HANDBOOK OF GEM IDENTIFICATION

material than diamond. If an interference figure can be obtained in the polariscope, it is simple to distinguish between the two, because sphene is biaxial and synthetic rutile is uniaxial. Synthetic rutile has a 4.26 specific gravity, compared to the 3.52 figure for sphene.

In 1914, Sir William Bragg, the eminent British scientist, subjected a diamond to the radioactive emanations of a radium salt. The result was a green color and a high degree of residual radioactivity in the treated stone. Since that time, two other means of green coloration of diamonds, the cyclotron and a nuclear reactor, have been used.

No great number of diamonds were colored by radium, probably because of the danger that its continuing radioactivity would pose to wearer. Those so treated are readily identified in two ways. Placed on a covered photographic film and left for 24 hours or more, the radioactivity exposes the film through the opaque paper shielding the film from visible light. Unique inclusions provide a more rapid means of detection. The radium-treated diamond contains round, disclike brown inclusions; usually, they are numerous.

Diamonds colored by bombardment of subatomic particles in a cyclotron, or in a nuclear reactor are usually more difficult to detect.

Diamonds with a natural green color are very rare. The De Beers Collection has no green diamond comparable to the green seen in treated stones. The only natural green diamonds encountered in either laboratory of the Gemological Institute have had large green naturals. Evidently, these were cut from naturally irradiated stones which developed a green layer that was retained in the naturals.

Usually stones colored by neutron bombardment show a pair of absorption lines at 4980 \AA and 5040 \AA . Other subatomic particles may induce no lines. Two natural green-coated crystals owned by GIA show a much stronger 5040 \AA line than that at 4980 \AA . The reverse is often, but not always, true in neutron-bombarded treated diamonds.

Neither stone has a color close to emerald green, but each is usually a low-intensity yellowish-green to blue-green. The treated stone may show the "cloverleaf" or "umbrella" effect near the culet or strong color zoning that is parallel to the facets, although this is less and less common, since most are neutron bombarded. Like synthetic

Identification of Transparent Green Gemstones

rutile and sphene, diamond is strongly dispersive (.044 B to G), but unlike the other pair it is singly refractive and its excellent polish is evident in the form of very sharp edges, compared to any colored stone. The nature of the girdle on a round diamond brilliant with its lathe-turned surface is different from that of colored stones. Naturals are frequently evident, and on them trigons or parallel grooves that, if present, distinguish the diamond from any other gemstone.

The demantoid variety of andradite garnet, which ranges from intense rich green to dull yellowish-green in color is characterized by the so-called horse-tail inclusions pictured on the frontispiece and in the chapter on inclusions. It, too, is a highly dispersive gemstone; in fact, the dispersion of demantoid (.057 B to G) is higher than that of either sphene or diamond. Demantoid may be identified also by its characteristic absorption spectrum. (See Chapter XIII.) It has a specific gravity of about 3.84, compared to the 3.52 of diamond and sphene.

YAG of a medium green color has been used in jewelry. A pencil beam of light appears red as it is transmitted through the synthetic.

Zircon of the low property type often does not show birefringence under magnification; however, a uniaxial figure may be obtained and the characteristic strong zonal structure of green zircon is apparent under magnification. Very strong parallel banding, similar to that caused by twinning in corundum, is always seen in low property green zircon. In addition, the low property type has a characteristic absorption spectrum, which is shown in the table of spectra in Chapter XIII. Occasionally, green zircon has refractive indices low enough to be seen just lower numerically than the liquid line, at 1.81. The minimum figure recorded has been about 1.78. On the other hand some green zircon has properties in the medium zircon range.

In the 1.72 to 1.77 range, the possibilities among important species include corundum, synthetic corundum, chrysoberyl, grossularite garnet, synthetic spinel, spinel, plus doublets and triplets. In the green synthetic sapphire, curved striae are rarely seen. Thus, if no bubbles are visible under magnification, it may be necessary to turn to the spectroscope to distinguish between synthetic and

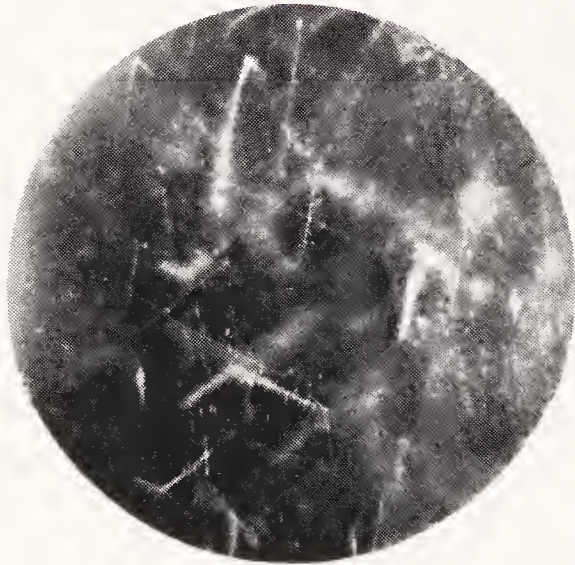

Figure 157
Metamict zircon showing
diagnostic angular markings.

natural corundum. This test provides a certain means of separation, in that synthetic corundum shows no absorption and natural green corundum always shows iron lines at 4500 and 4600Å that almost join one another plus a separate line at 4700Å. For other methods, see Chapter X.

Green chrysoberyl varies from pale yellowish to deep brownish or bluish-green. The daylight color for alexandrite varies from a brownish or yellowish-green to a bluish-green. Chrysoberyl may be transparent and faceted, or the semitransparent to translucent cat's-eye in a cabochon form. If the green color is the daylight color of alexandrite, there should be a color change to the red of alexandrite under artificial incandescent light. In this event, strong trichroism should be present and serves to identify the stone. In addition, alexandrite has a characteristic absorption spectrum, which is shown in the table in Chapter XIII. Green material without color change shows absorption between 4400 and 4500Å, the strength of which varies with the depth of the green color.

Transparent green grossularite is a new gemstone. It has been found in Africa in a hitherto unknown transparent rich chrome green, but also in a transparent very pale green to colorless form. Transparent light green material is also found in Pakistan. The refractive index is near but usually slightly above 1.73 in the colorless form and closer to 1.74 in the rich green. The specific gravity of the colorless material is about 3.60. Fortunately, much of it shows rod or needlelike inclusions. Some inclusions, however, may resemble those of synthetic spinel, so it is fortunate that their reactions to short- and long-wave ultraviolet differ from synthetic

Identification of Transparent Green Gemstones

spinel. It shows a weak green fluorescence to short wave and weak orange to long wave. The transparent green material may show a weak to moderate red fluorescence under both short- and long-wave ultraviolet. The strong orangy-yellow fluorescence to X-ray that characterizes grossularite is present.

Spinel and synthetic spinel are separated effectively by characteristic inclusions, or by the difference in refractive index, coupled with the difference in the appearance of the two materials in the polariscope. A natural gem usually shows almost no anomalous double refraction, whereas synthetic spinel always shows the so-called cross-hatched double refraction, somewhat akin, at least, to that pictured in Figures 89 and 90. Synthetic spinel is characterized by gas bubbles and natural spinel by the presence of octahedra. Natural green spinel is rarely seen. When it is, it is sometimes another member of the spinel group such as gahnospinel, in which some of the magnesium is replaced by zinc; or gahnite, with all magnesium replaced by zinc. Gahnite has an index of 1.80 and a 4.55 specific gravity; and gahnospinel is between normal spinel figures and those of gahnite.

Triplets, made of an emerald-green cement joining a crown of synthetic spinel and a pavilion of the same material, are easily detected by immersion in any clear liquid. It is wise to try water or a bland oil as an immersion medium, to avoid damaging the cement.

The 1.60 range of refractive indices includes the following important gems and substitutes: peridot, spodumene, andalusite, tourmaline, topaz, glass and plastics. Peridot is readily distinguished from the others by its great birefringence, with a usual separation between the high and low indices of .036; the usual high index is about 1.690 and the low, 1.654. Peridot is unusual in that the intermediate, or beta, index (1.672) is usually exactly halfway between the high and low indices. Spodumene has indices of 1.660 to 1.676, or a birefringence of less than half of that of peridot. The beta index is 1.666, so spodumene is positive in optic sign. They are easily distinguished, in addition, by the fact that peridot either sinks very slowly or just floats in methylene iodide, whereas

spodumene floats buoyantly. Spodumene in an intense green color, the hiddenite variety, is exceedingly rare; light green material is seen more often. A dark green cat's-eye from India has become increasingly popular in recent years. It has a sharp eye and makes a pleasing stone. Although often called enstatite, it has the properties of diopside, a closely related member of the same family — the pyroxenes. Chrome diopside in a transparent faceted form is a material that is popular with collectors.

The so-called Imperial quality of jadeite is at least semi-transparent. It is characterized by three absorption lines in the red area of the spectrum, a doubly refractive aggregate reaction in the polariscope, and a spot refractive index reading of 1.66.

Andalusite in a greenish color usually shows strong dichroism that is visible even in a table-up position, with the colors a brownish-green and a dark brownish-red. A green type, colored by rare earth elements, has a brighter-green color and lacks the red dichroic color. It has a characteristic spectrum illustrated in Chapter XIII.

Green tourmaline, of course, is a common gemstone in a dark brownish-green color, but very rare in a rich medium-green resembling emerald. It is characterized by constant indices of approximately 1.624 and 1.644, with a birefringence of .018 to .020 and the high index constant. The dark green is also characterized by very strong dichroism, with one of the two windows of the dichroscope showing almost completely black and the other a yellowish-green. Rarely, green tourmaline is found in Maine and Brazil that is clear and not dark brown to almost black in the optic axis direction. Therefore, such stones do not have the blackish or brownish ends so common in the emerald-cut green tourmalines. Such stones show a dichroism of a light and a darker green.

Topaz in a light yellow-green color is rarely cut, although bluish-green to greenish-blue, resembling aquamarine, is fairly common. It has indices usually in the range of 1.609 to 1.617. It is easily distinguished from tourmaline both by its positive sign, in contrast to the negative sign of tourmaline, and by its lower indices. In addition, topaz sinks in methylene iodide, whereas tourmaline floats.

Both glass and plastic imitations with an index in the 1.60's are

Identification of Transparent Green Gemstones

common. However, they are easily distinguished by the fact that they are singly refractive, in contrast to the double refraction of the other stones in the 1.60 range. Usually, their color is emerald-green, rather than a color that imitates gems with indices in the 1.60's.

In the next lower refractive index group are emerald, synthetic emeralds of both flux-melt type (Chatham, Gilson and Zeffass) and hydrothermal (Regency), and Lechleitner (actually beryl with an overgrowth of synthetic emerald), heat-treated quartz, dyed chalcidony (which approaches transparency), doublets, triplets and glass. Emerald of natural origin usually has indices in a range from 1.570 to 1.595, with a .005 birefringence at the lower end and .007 at the upper. The most important substitute for natural emerald is the synthetic emerald. Flux-melt types are characterized by the wisp- or veil-like inclusions and by very low refractive indices (1.561-1.564), as well as by low S.G. (2.67). Chatham

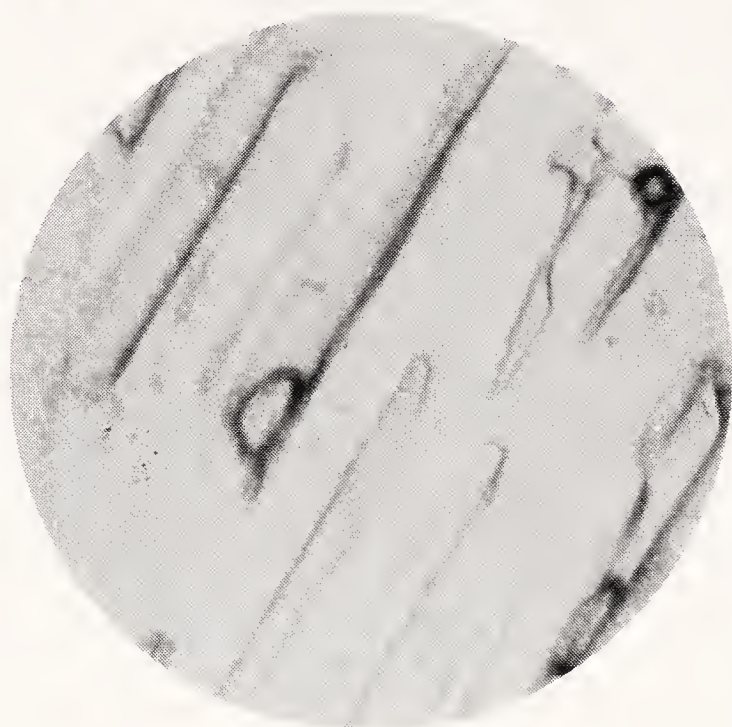

Figure 158
Veillike inclusions in a
flux-grown synthetic emerald.

Photo by G.I.A.

and Zeffass products also fluoresce a distinct red under long-wave ultra-violet, and Gilson does too, usually, but the latter may fluoresce with an overtone of yellow or orange. Lechleitner has produced both a hydrothermal overgrowth of synthetic emerald on prefaceted natural beryl, and a sandwich of synthetic emerald and

Figure 159
Parallel tubelike cavities
containing two-phase in-
clusions in hydrothermal
emerald. Courtesy Linde
Co.



colorless beryl. Both have the low refractive indices ascribed to flux-melt products. The Regency indices are slightly higher. The Lechleitner overgrowth shows parallel cracks in the synthetic layer, indices in the natural range, and a fluorescence proportionate to the thickness of the overgrowth. Indices are near 1.565-1.571.

The new hydrothermal by Regency has higher indices than flux-fusion synthetics with varying from 1.566-1.572 and from 1.571-1.578; its S.G. is 2.67-2.69. Fortunately it is so strongly fluorescent as to be unmistakable. A reddish overtone is usually obvious under dark-field illumination with an incandescent bulb. It seems likely that the trend will be toward less chromium, thus the R.I. should be near the lower figures quoted.

Cuneiform inclusions may be present, plus minute two-phase inclusions concentrated near the interface between seed and new growth. (See illustrations.)

From time to time Gilson had made at least three types of flux-grown synthetic emeralds. The first was a cloudy yellowish green with the usual low properties. A second is the clear to slightly bluish green that is today's usual product (R.I. 1.562-1.567, S.G. about 2.65 or 2.66) and a third that is also transparent, without fluorescence and with an R.I. of 1.571-1.579 and S.G. 2.68 to 2.69. This shows an iron line at 4270\AA .

Identification of Transparent Green Gemstones

Apparently both the first and the third types have been phased out—only the second type is being manufactured in quantity.

	Refractive Indices for Emerald		Specific Gravity
Colombian			
Borbur	1.569	1.576	2.70
Chivor	1.571 ($\pm .003$)	1.577 ($\pm .003$)	2.70 ($\pm .01$)
Muzo	1.577 ($\pm .003$)	1.583 ($\pm .003$)	2.71 ($\pm .01$)
Brazilian	1.568 ($\pm .002$)	1.573 ($\pm .002$)	2.69 ($\pm .01$)
Russian	1.579 ($\pm .003$)	1.588 ($\pm .003$)	2.73 ($\pm .02$)
Indian, African	1.585 ($\pm .003$)	1.592 ($\pm .003$)	2.74 ($\pm .02$)
Sandawana	1.586	1.593	2.75 ($\pm .02$)
Flux-melt Syn	1.561 ($\pm .001$)	1.564 ($\pm .001$)	2.66
Lechleitner Syn.	1.575	1.581	2.71 ($\pm .02$)
Regency Syn.	1.569 ($\pm .003$)	1.574 ($\pm .004$)	2.68 ($\pm .01$)
Gilson Type III	1.571	1.579	2.68 ($\pm .01$)

Most of the important emerald sources produce stones with approximately the range of the Lechleitner synthetic emerald (1.575 to 1.581), but the flux melt synthetic emerald is considerably lower, with indices of 1.561 to 1.564 (or 1.565). There are several other means by which flux-melt synthetic emerald may be detected. Its specific gravity is almost exactly equal to that of quartz, in the 2.65 to 2.66 range. A liquid adjusted to this specific gravity, and using a Chatham synthetic and a natural emerald as indicators, provides an excellent means for quick separation, because the natural almost always sinks and the synthetic almost always floats. This is a test to be used in conjunction with other means of testing, in that the amount of platinum in a Chatham synthetic is sometimes sufficient to cause it to sink, and sometimes badly flawed natural emeralds are reduced in specific gravity by the presence of voids. Magnification would disclose whether either situation prevails.

There are many essential factors that are important when distinguishing synthetic from natural emeralds. At first glance both flux-melt and hydrothermal synthetic emeralds resemble natural stones in that they contain what appear to be two-phase inclusions.

In hydrothermal synthetics, spike-shaped cavities are filled with liquid and gas and capped at the broad end by phenakite crystals. In flux-melt synthetics, inclusions that resemble liquid and gas fingerprints are actually mostly flux filled, but may contain gas as well. They are very characteristic because they resemble facial tissue in water — referred to as veillike or wispy — and they appear to be gently waving.

The early production of synthetic emeralds, and even most of today's product, are easily distinguished from natural emeralds by such things as low refractive indices, strong fluorescence and low specific gravity; but, increasingly, recognition of the inclusions is the key to successful separation. Even today, the Chatham flux-melt synthetic emerald has indices on the order of 1.561 to 1.564, which is well below the lowest figure encountered in natural emeralds. The specific gravity for both the Chatham and the Gilson products usually is on the order of 2.65 to 2.66. This is in contrast to the approximate 2.71 of most natural Colombian emeralds and even higher figures for emeralds from other sources. Thus, a heavy liquid — adjusted to the density of 2.67 — serves to separate the flux-melt synthetic from the natural in most cases.

At the present time, a small portion of the Gilson line shows no fluorescence whatsoever to long-wave ultraviolet and has indices of 1.571 to 1.579 with a specific gravity of about 2.685. This type of Gilson synthetic emerald is still identified by veillike inclusions and by the fact that the addition of iron to quell the fluorescence creates an absorption band in the spectroscope at about 4270 Å.

With the exception of the type just mentioned, synthetic emeralds fluoresce a dull red under ultraviolet. Some natural emeralds fluoresce, but usually they do not make the stone appear opaque, as does the fluorescence in most synthetic emeralds. Long-wave ultraviolet is recommended for this test. The fluorescence could best be described as weak to distinct in some cases. Thus, it is important to make the tests in a dark room with the stone placed on a dull black background.

If an emerald has three-phase inclusions, it must be natural. By three-phase inclusions we refer to cavities filled with liquid, gas bubbles, and a crystal for the solid third phase.

Identification of Transparent Green Gemstones

The Chatham product contains numerous solid flux feathers, usually veillike formations which may be likened to waving curtains (three different magnifications are shown below).

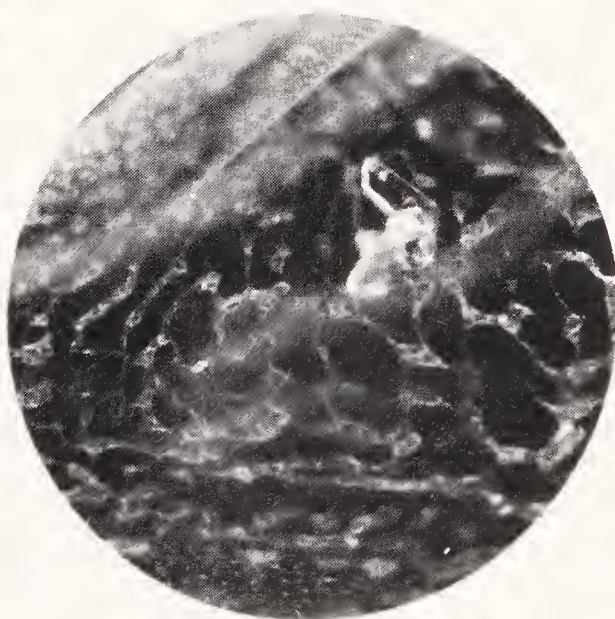
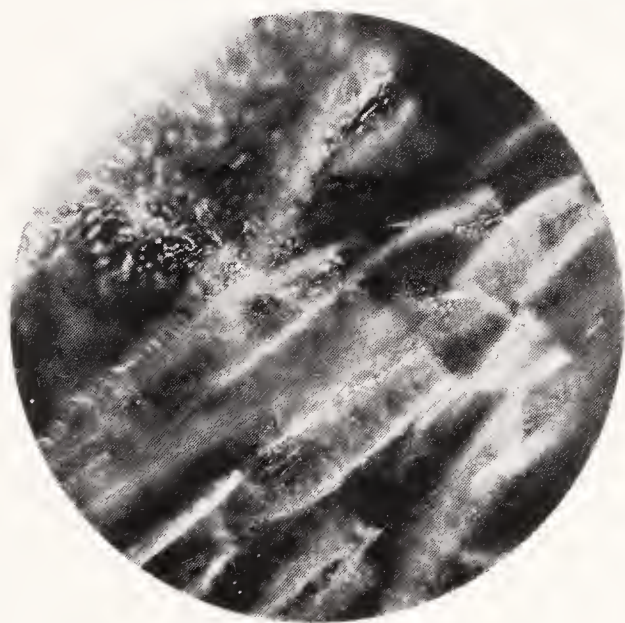
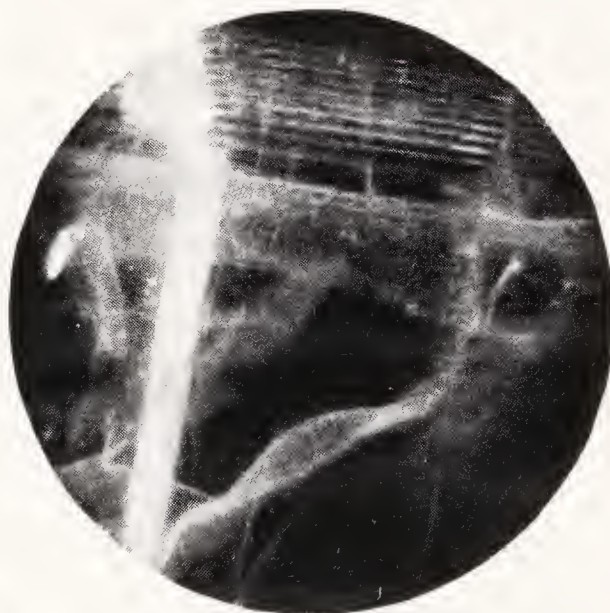

HANDBOOK OF GEM IDENTIFICATION

The Lechleitner synthetic-emerald-coated beryl is easily distinguished by the fact that the overgrowth appears under magnification as an intense green layer over almost colorless material; immersion makes this even more prominent. In addition, under magnification, it will be seen that the overgrowth has not been polished on all facets; it shows a rough appearance caused by small crystal faces.

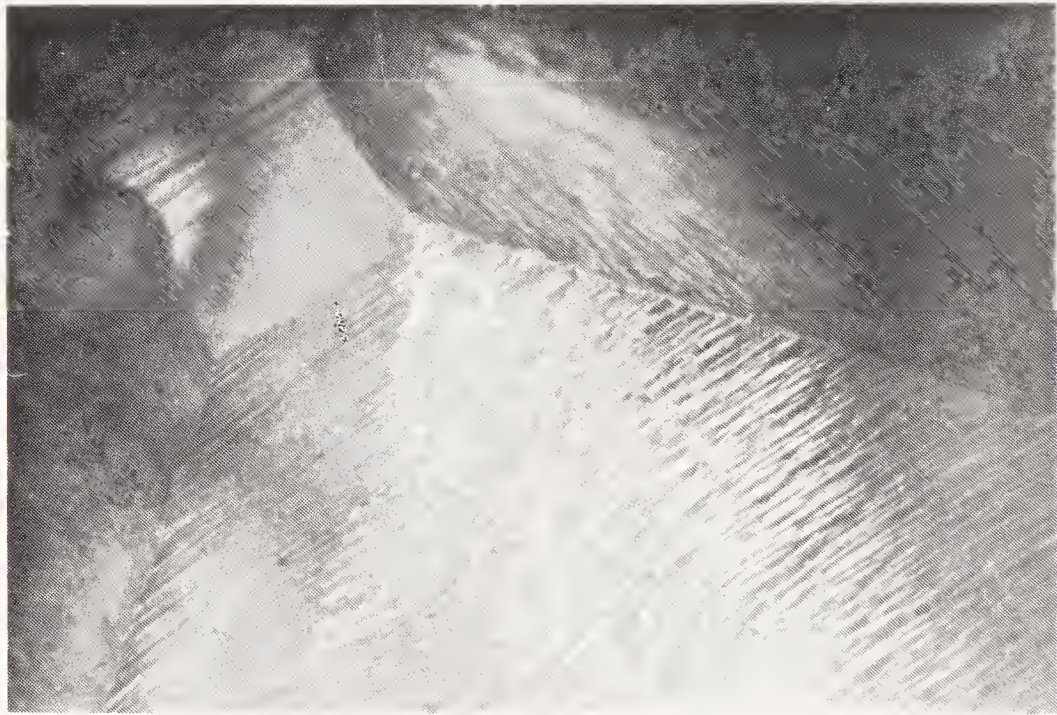

Figure 160

Magnified surface of a Lechleitner synthetic-emerald-coated beryl showing the incipient crystal-face development as the synthetic emerald is deposited on the pre-faceted beryl.

The strong grid of parallel cracks is particularly diagnostic. (see illustration.)

A color filter designed by Anderson and Payne before the advent of synthetic emerald was a useful, inexpensive instrument for separating emerald from most imitations. The advent of the various types of synthetics and some new sources of natural emeralds has reduced its value in emerald use greatly. Natural emeralds from most sources, as well as Chatham and Regency synthetics, appear pink to red under the filter, depending on depth of color; however, Indian and some African emeralds appear green, as do most imita-

Identification of Transparent Green Gemstones

tions. Green zircon and demantoid are usually pink under the filter. There are some imitations, however, that employ a cement that imparts a red color to the whole as seen under the filter, and some green plastic-coated beryl also appears red. Thus, the value of the filter in emerald identification today is very limited.

Low quality beryl beads are sometimes coated with an emerald-green plastic to give a rich-green appearance; they are easily detected by bubbles in the plastic coating under magnification. In addition, of course, they are very soft and often show a flow structure in the coating. It is obvious under magnification that they have not been polished. To the unwary, natural inclusions in the beryl inner bead could cause some difficulty.

Since emeralds are often fractured and the fractures may be visible to the unaided eye, thus seriously reducing the value of the stone, it has been a long-standing practice in the Orient and elsewhere to "oil" stones of this kind. The reason for this is that the oil, which has an index not too far from that of beryl, replaces the air in the fractures; therefore, the fractures either become invisible or much less apparent to the unaided eye. Thus, it is very important for the gem tester to be aware of this practice and to be able to detect it. Usually, the oil is colorless; sometimes, however, if a stone is pale, an emerald-green dye is added to the oil. Detection of oiling is difficult. If a stone has been treated recently, very gentle heating usually brings some of the oil to the surface where it may show up if rubbed on a fine-grain paper. It may be detectable as a liquid under magnification or as an iridescent film on the polished surface. Of course, if it dries out, its value in concealing the fractures is lost, or at least seriously reduced. Usually long-wave ultraviolet light shows up oiled emeralds by showing a yellow fluorescence in fractures that have been reduced in visibility by oiling.

Efforts to deepen the color of pale emeralds usually consist of introducing color into the back of a wholly enclosed gypsy setting in the form of green foil, or just a green dye on or behind the pavilion facets. Such additional color may be detected by directing light through the stone to reflect from the pavilion and examining

HANDBOOK OF GEM IDENTIFICATION

the reflected beam with a dichroscope. A tester should be able to determine by the strength of dichroism in relation to the apparent color of the stone whether an emerald has a deep natural color or whether color has been imparted by some artificial means. Coated stones are much too weakly dichroic for their depth of color.

Glass simulating emeralds tends to be given particular attention by those making imitations. It is possible to duplicate the refractive index and specific gravity of emerald very closely and to mix into the glass melt irregular fragments of a substance that will not melt at the temperature at which the glass is formed. The result is many inclusions that, to the casual observer, give the imitation a typical

PROPERTY TABLE FOR GREEN GEM MATERIALS IN ORDER OF DESCENDING INDICES

Name	Polar.	Pleo.	S.G.	Hard.	Additional
Syn. rutile	D	W	4.26	6-6.5	rarely seen, doubling
Diamond	S (anom.)		3.52	10	girdle, cleavage
Sphene	D	D	3.52	5-5.5	doubling
Andradite	S (anom.)		3.84	6.5-7	inclusions
Zircon (med.)	D	W	4.40	7.5	doubling
YAG	S		4.55	8+	red to transmitted light
Zircon (low)	D	W	4-4.2	6	spectrum
Corundum	D	S	4.00	9	inclusions, spectrum
Syn. sapphire	D	S	4.00	9	inclusions
Chrusoberyl	D	S	3.73	8.5	pleochroic, spectrum
Grossularite	S		3.61	7	inclusions
Syn. spinel	S (anom.)		3.64	8	strain pattern (polar.)
Spinel	S		3.60	8	spectrum
Peridot	D	W	3.34	6-7	doubling
Jadeite	D		3.34	6.5-7	rarely trans., spectrum
Diopside	D	W	3.29	5-6	spectrum
Spodumene	D	S	3.18	6-7	pleochroism
Andalusite	D	S	3.18	7-7.5	pleochroic
Tourmaline	D	S	3.08	7-7.5	pleochroic
Topaz	D	D	3.56	8	cleavage
Emerald	D	S	2.71	7.5-8	inclusions, U.V.
Syn. Emerald					
Lechleitner	D	D	2.71	7.5-8	thin overgrowth
Flux-fusion	D	d	2.66	7.5-8	fluorescent, inclusions
Regency	D	D	2.68	7.5-8	fluorescent, inclusions
New Gilson	D	D	2.68	7.5-8	4270Å ^o , inclusions

Identification of Transparent Green Gemstones

Quartz	D	VW	2.66	7	dull color
Chalcedony	D (light)		2.60	6.5-7	spectrum
Glass	S(anom.)		2.3-4.5	5	molded?
Plastic	S(anom.)		<2	<3	Soft

emerald “garden.” It is inevitable that when glass is made with many fragments of foreign material, the number of bubbles is large, so the stone is easily detected under magnification.

A triplet consisting of two parts of beryl or two of quartz joined by an emerald-colored cement is a common substitute. Immersion discloses its nature.

Transparent green quartz is the result of heating transparent amethyst from one or two mines. This material turns green rather than to the usual citrine color resulting from the heating of amethyst. It is usually yellowish-green reminiscent of peridot. It is not an intense green color.

In addition to the gems mentioned, there are a variety of rare materials that occur in a green color and that are rarely seen as gemstones but are sometimes cut by, or for, collectors. Fluorite is often used for carvings, particularly by the Chinese; apatite is sometimes cut when found in a green color; brazilianite is greenish-yellow to yellowish-green; datolite occurs in very light green transparent crystals that furnish excellent material for faceted stones; diopside is a pyroxene with a dull green color, except when chromium is present to perform its magic in the form of a rich, almost emerald green; diopside, the only gem material that almost always resembles the color of emerald; ekanite is a recently described metamict thorium mineral found in Ceylon in a dark green color; enstatite is usually a brownish-green; epidote is sometimes referred to as pistachio green, a distinctly yellowish-green; euclase is not infrequently a very pale bluish-green; kornepine is usually dark brown, but it has been found in Madagascar in a bluish-green color described as sea green; kyanite may be a light bluish-green; moldavite is a natural glass that occurs in a green color more reminiscent of peridot than of emerald; sphalerite is usually a brownish-green; willemite, when transparent, is usually yellow

HANDBOOK OF GEM IDENTIFICATION

but may be yellow-green. The identification and description of these rarely encountered gemstones is given in Chapter XVI, together with the means by which they are most readily separated from the stones most strongly resembling them. However, the table gives their refractive indices and specific gravities.

	Refractive Indices			Specific Gravity
Sphalerite		2.37		4.05
Gahnite		1.80		4.55
Gahnospinel		1.75		3.6 to 4.0
Epidote	1.729	1.757	1.768	3.40
Kyanite	1.716	1.724	1.731	3.62
Willemite	1.690		1.720	4.00
Diopside	1.675	1.685	1.701	3.29
Kornerupine	1.667	1.679	1.680	3.30
Diopase	1.655		1.708	3.30
Enstatite	1.658	1.662	1.668	3.25
Euclase	1.654	1.657	1.673	3.10
Apatite	1.642		1.646	3.18
Datolite	1.626	1.654	1.670	2.95
Brazilianite	1.602	1.609	1.621	2.99
Ekanite		1.597		3.28
Moldavite		1.48		2.40
Fluorite		1.434		3.18

Chapter XXI

The Identification of Transparent Yellow Gemstones and Their Substitutes

The number of transparent yellow gem species and their substitutes for the jewelry market is large. In addition, there are many more minerals cut almost exclusively for collectors that occur in various tones and intensities of yellow. A certain overlapping between this color range and the green, brown and orange categories is inevitable.

First Test. Clean the stone and examine it with the unaided eye or a low power loupe, to observe its key characteristics. Note its luster, degree of dispersion, whether doubling of opposite facet edges is visible, if there is any obvious dichroism or cleavage, and whether any of the several optical phenomena are present. Observations made initially may enable the gemologist to confirm a probable identity with a single test. If, in this preliminary examination, any of the following properties or conditions are noted, the probabilities include the following:

Double images of opposite facet edges suggest zircon, peridot, sphene or synthetic rutile.

An exceedingly low specific gravity apparent upon lifting the gem suggests amber, copal, pressed amber, amberdan or another plastic imitation.

Warmth to the touch (compared to the cold feel of crystalline materials) is a property of amorphous materials such as opal, amber, copal, pressed amber, amberdan, and glass or plastic imitations.

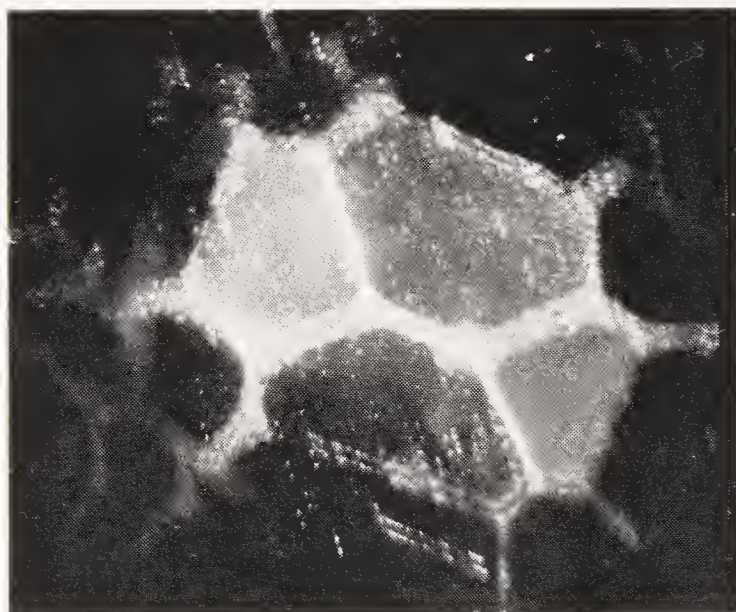

Figure 161

Doubling of opposite facet edges in a zircon.

Chatoyancy suggests chrysoberyl, quartz, or glass.

Strong dispersion suggests sphene, zircon, diamond, or synthetic rutile.

Molded pavilion facets prove the unknown to be a glass or plastic imitation. (See Chapter XI.)

A play of color is characteristic of opal.

A luster difference between crown and pavilion or between the table and lower crown facets suggests a doublet.

A red ring around the girdle when the gem is placed table down on a white background suggests a garnet-and-glass doublet.

A visible separation plane indicates a doublet or triplet.

Second Test. After an initial inspection and classification of the unknown's color and its obvious characteristics, take a refractive index reading. If the stone has a well-polished flat facet, use the normal refractometer method. If no reading is seen and the shadow area fails to extend to the liquid line, at 1.81 (which would show that the index is over the instrument's upper limit), try the spot method.

It should be possible either to obtain a reading or to determine that the index is over the limits of the refractometer on any flat or convex polished surface, unless it is mounted in a manner that makes contact with the hemisphere impossible or unless a surface

Identification of Transparent Yellow Gemstones

film prevents optical contact. If the refractometer findings are unsatisfactory, immersion in liquids of known index should yield an approximation of the index. (See Chapter V.) If no approximation of index seems possible, magnification, polariscope, dichroscope and spectroscope findings may serve to identify the material without a refractive index determination. In rare instances, removal

REFRACTIVE INDICES*

Syn. rutile	2.616		2.903
Diamond		2.417	
Zircon (high, med.)	1.925		1.984
Sphene	1.900	1.907	2.034
Spessartite garnet		1.81	
Corundum	1.762		1.770
Syn. corundum	1.762		1.770
Chrysoberyl	1.746	1.747	1.755
Grossularite garnet		1.745	
Syn. spinel		1.73	
Spinel		1.718	
Sinhalite	1.668	1.698	1.707
Peridot	1.654	1.672	1.690
Spodumene	1.660	1.666	1.676
Topaz	1.629	1.631	1.637
Tourmaline	1.624		1.644
Beryl	1.570		1.575
Quartz & synthetic	1.544		1.553
Amber		1.54	
Copal		1.54	
Pressed Amber		1.54	
Plastics			
Polystyrene		1.59 to 1.67	
Amberdan		1.56	
Plexiglas and lucite		1.50	
Celluloid		1.49 to 1.52	
Bakelite		1.55 to 1.67	
Glass (normal range)		1.48 to 1.70	
Glass (extreme range of gem imitation types)		1.44 to 1.77	
Opal		1.45	

* A single figure is given for isotropic, two for uniaxial, and three for biaxial materials. Variations are shown in the refractive index tables in the Appendix.

of the gemstone from the mounting for better magnification or for a specific gravity test may be needed. Refractive indices are given in the following table and other properties in a second table near the end of this section.

If the refractive index of the stone proves to be over 1.81, the possibilities in a yellow color include synthetic rutile, natural canary diamond, treated diamond, zircon, sphene, andradite garnet, spessartite garnet, or a garnet-and-glass doublet with a yellow color. Synthetic rutile, zircon and sphene are all characterized by a very high birefringence; however, the birefringence of synthetic rutile is more than double that of sphene, and sphene's more than double that of zircon. Synthetic rutile, which is usually a pale-yellow color, is characterized by enormous dispersion. Sphene and zircon also have rather strong dispersion but their fire is weak, compared to the excessive dispersion of synthetic rutile. Yellow zircon is usually close to 4.70 in specific gravity, but it may be as low as 4.50. On the other hand, synthetic rutile is within .02 of 4.26 and sphene has specific gravity equal to that of diamond's 3.52.

Diamond is easily distinguished from the other stones above the refractometer scale by its single refraction; typical cleavage; very fine-grained, shiny to slightly frosted texture on a lathe-turned girdle of a round brilliant; trigons or grooves on naturals (if any); and by the other characteristics described in Chapter XVI. In addition, most yellow diamonds are characterized by a strong absorption line at 4155\AA , deep in the violet end of the spectrum; a stone must be intensely lighted for this to be apparent. If the diamond has a natural color, only the several lines in the blue and violet, described in Chapter XIII, will be evident, although some naturally yellow diamonds show no absorption. If the stone has been subjected to cyclotron or nuclear-reactor bombardment and subsequent heat treatment, a line should be visible at 5920\AA in the yellow portion of the spectrum (also at 4980 and 5040\AA). The 5920\AA is a very narrow line that is easily lost, unless the stone remains cool during its examination. It is often difficult to find without careful examination from several directions and under excellent lighting conditions.

Identification of Transparent Yellow Gemstones

The spectroscope is useful not only for diamond, but synthetic rutile and zircon as well. Synthetic rutile is characterized not by absorption lines, as such, but by an abrupt cutoff at about 4250\AA . All light below that point is absorbed. Zircon almost always shows a distinct absorption line at 6535\AA , and a fainter one at 6590\AA in the red. Additional lines of the classic zircon spectrum may also be present.



Figure 162
Diamond and synthetic spinel
immersed in methylene iodide.

Upon immersion in a liquid of high index, such as methylene iodide, a diamond remains in high relief. This is true also of synthetic rutile, whereas spheue and zircon lose most of their relief and become more difficult to see in the liquid.

Spessartite garnet, which also has a characteristic absorption spectrum and is usually on the brownish side of yellow, tends almost to disappear in methylene iodide. Its refractive index is slightly above the upper limits of the refractometer.

The yellow variety of andradite garnet (sometimes called topazolite by mineralogists) is also above the limits of the refractometer in index. Spessartite tends toward a brownish-yellow and topazolite toward a greenish-yellow color. Although some andradite of a yellow-green color is known among hobbyists as topazolite, an andradite of a yellow color that would justify comparison to topaz, as the name suggests, is seldom, if ever, found in a size large enough for practical gem use. If some appears, its index above the scale (yet far below diamond, as shown by immersion), strong

HANDBOOK OF GEM IDENTIFICATION

dispersion, single refraction, and a 3.8 specific gravity could identify it.

Garnet-and-glass doublets occasionally have a garnet top with an index above the scale, but immersion or examination under magnification quickly reveals the difference between the garnet and the glass portions.

In the next range of indices, the 1.70's, are corundum, synthetic corundum, chrysoberyl, hessonite garnet, synthetic spinel and spinel. In a yellow color, synthetic and natural sapphire are more likely to be difficult to separate by magnification than in almost any other color. Under magnification, both are sometimes free from the imperfections that would permit easy separation. In addition, the synthetic does not show visible curved striae by any method so far discovered. However, fortunately, there are means by which they may be separated beyond question. Synthetic yellow sapphire may show a weak red fluorescence to both long- and short-wave ultraviolet, and a fluorescent line in the spectrum, but no line at 4500. Weak red fluorescence is also possible in a natural yellow sapphire which shows a fluorescent line in its spectrum. This is very rare in the natural.

Natural sapphire, on the other hand, either shows lines in the spectroscope or is fluorescent, depending on its source. Yellow sapphires from Thailand and Australia usually show absorption lines in the spectroscope at 4500, 4600, and 4700Å; in those with a good deal of iron, the 4500 and 4600 lines almost merge. On the other hand, yellow stones from Ceylon contain very little iron and may show no line at the 4600 and 4700Å positions; in fact, sometimes the line at 4500 is not visible. However, such yellow sapphires fluoresce strongly in a rich, orangy-yellow color, sometimes referred to as "apricot." A yellow sapphire that has neither absorption lines in the spectroscope nor fluorescence may be assumed to be synthetic.

It is possible to deepen the yellow color of sapphires by heavy dosages of X-radiation, and apparently by other forms of sub-atomic-particle bombardment. X-ray-produced color fades quickly in sunlight. A yellow color apparently may be driven off at only

Identification of Transparent Yellow Gemstones

250 to 300°C, whether naturally developed or produced by irradiation.

The form in which yellow chrysoberyl is seen most often in the jewelry trade is the honey-colored cat's-eye; the silkiness and sharp eye rather readily distinguish it from any other yellow gemstone. On rare occasions, exceptional quartz cat's-eyes are seen with a silkiness and consequent sharpness of eye closely resembling fine chrysoberyl cat's-eye; they are easily distinguished by a spot reading or specific gravity. However, if there is any difficulty in establishing the identity of a chrysoberyl by refractometer, there are other methods. Chrysoberyl is the only important yellow stone in the 1.70 range that is biaxial. It should be rather easy to establish this fact by finding an interference figure in the polariscope, if the stone is sufficiently transparent; if not, other characteristics are useful. It has a dependable absorption pattern in the spectroscope and a distinct line at approximately 4450Å (see table of characteristic absorption spectra in Chapter XIII). In the unlikely event there is any doubt as to its identity, it should be simple enough to distinguish between corundum and synthetic corundum on the one hand and chrysoberyl on the other by a specific gravity determination or a careful refractive index reading. The constant (and high) index of corundum is at 1.77 and the alpha and beta indices of chrysoberyl are both below 1.75.

At almost the same refractive index as chrysoberyl is grossularite garnet. The hessonite variety of grossularite is usually a brownish-yellow to yellowish-brown and is characterized under magnification by a very distinctive appearance; this appearance is very well shown in Chapter VIII on inclusions. Grossularite, in contrast to the other stones above it in index in the 1.70 range, is singly refractive. The combination of its single refraction at a 1.745 refractive index and its characteristic appearance under magnification — the appearance of a saturated sugar solution with light passing through it — is sufficient to identify it beyond question.

For practical purposes pure yellow spinel is unknown, but some may regard occasional flame spinels as more yellow than orange. Yellow synthetic spinel is encountered frequently; it is separated

HANDBOOK OF GEM IDENTIFICATION

from the natural readily on the basis of its strong, strain-patterned double refraction and approximately .01 difference in refractive index. The synthetic is usually 1.73 or just slightly lower, and spinel between 1.715 and 1.72.

In the 1.60's the relatively common gem species are peridot, spodumene, topaz and tourmaline. Peridot is rarely a true yellow, but often may be described as greenish-yellow. Its birefringence is distinctly greater than any other gemstone likely to be encountered in a yellow color in the 1.60 refractive index range, with the exception of sinhalite, a gem mineral long thought to be iron-rich peridot. Sinhalite is usually yellow or brown in color. Its refractive indices are distinctly higher than those of gem peridot (1.668 and 1.707 compared to the 1.654 and 1.690 of peridot); however, iron-rich peridot has indices higher than the figures quoted. It is rarely, if ever, encountered on the gem market; even if it were, the refractometer could be used to separate the two, for there is a key difference between the two. Peridot is characterized by the fact that the middle index, the point from which the high and low indices vary as the stone is rotated on various facets, is 1.672; this is exactly halfway between the high and low readings. This means that it is neither really positive nor negative in sign but halfway between. In contrast, sinhalite is distinctly negative in sign; the beta reading is 1.698, only .009 from the highest index. Sinhalite has a specific gravity near 3.46, so it sinks rapidly in methylene iodide, in contrast to peridot at 3.32 to 3.35, which usually sinks very slowly. The two differ materially in absorption spectra. (See the table in Chapter XIII.) Almost the only other relatively common stone with which peridot is likely to be confused in index is spodumene, with indices of 1.660 and 1.676. However, spodumene at the highest index does not approach the 1.69 of peridot, nor does its birefringence even reach half of that of peridot. In addition, peridot has a specific gravity almost equal to the 3.32 liquid, methylene iodide, whereas spodumene floats buoyantly in this liquid.

In its yellow to yellow-brown color, topaz is characterized by a slightly higher index than it shows in either a colorless or blue

Identification of Transparent Yellow Gemstones

form; the usual indices for yellow material are 1.629 and 1.637. It is distinctly positive in sign, with the beta index about .002 above the lower figure. Tourmaline is in the same general index range, with indices of 1.624 and 1.644, but it is optically negative in sign; the 1.644 reading is the constant figure. The birefringence of .018 to .020 is at least double that of topaz (.008). It should not be necessary to resort to a specific gravity test to distinguish between topaz and tourmaline; if this is necessary, however, a test with the 3.32 liquid quickly distinguishes between the two, since tourmaline floats and topaz sinks rapidly in methylene iodide. Both yellow and pink topaz fluoresce a dull greenish under short-wave ultra-violet. Peridot, spodumene and topaz are all biaxial and tourmaline is uniaxial.

Glass is sometimes confused with stones in this range; particularly is it likely to be confused with topaz, both in refractive index and in appearance. However, it is readily distinguished from topaz by the polariscope because, of course, glass is singly refractive.

Gemstones and substitutes with refractive indices between 1.5 and 1.6 include golden beryl, citrine quartz, synthetic quartz, irradiated greenish yellow quartz, amber and its substitutes, several different plastics and glass.

Most golden beryl has refractive indices of approximately 1.57 to 1.575. The only gem material in this color range that may have closely comparable indices is the rare transparent form of labradorite feldspar. Labradorite is distinguished from beryl on the basis of its biaxial character. In beryl, the high 1.575 index is constant and the 1.570 is variable. In labradorite, the two readings both vary, with the intermediate, or beta, almost at the midpoint between the extremes. The birefringence is approximately .009, or about double that of beryl. Resolution of an interference figure would be conclusive.

Bakelite is unlikely to be confused with any gemstone with the exception of amber. It is the plastic that is usually used as an amber substitute. Most often it is not yellow, as is amber, but a deeper reddish-brown, although it can be made in a yellow color. Usually, its refractive index is about 1.60, considerably higher than that of amber. It sinks rapidly in a saturated salt solution, in

HANDBOOK OF GEM IDENTIFICATION

which amber and recent resins, such as copal or kauri gum, float. Amber is readily distinguished from plastics by the odor given off by gentle heating or by bringing a hot point against the amber. Amber gives off a strongly resinous odor, whereas various plastics have different odors, but all are characterized by an acridness. Amber is rather readily distinguished from more recent resins by the fact that if it is dipped into ether and left for a few minutes amber is unaffected, whereas the recent resins soften quickly. Pressed amber, which is made by mixing bits of amber with linseed oil and forcing the whole mass through small openings, is characterized by being softened by ether in minutes, in contrast to the natural. It also has elongated bubbles and a distinct flow structure, in contrast to the spherical nature of bubbles in amber. It is characterized by a roiled appearance under magnification (see photomicrograph), and an evenly light appearance when rotated in the polariscope's dark position.



Figure 163
Pressed Amber

There is an amber imitation called amberdan (sometimes offered as “cultured amber”) that has properties fairly near natural amber. Refractive index is about 1.56 in contrast to the 1.54 of amber and the S.G. of 1.23 is also well over that of amber. The hot point gives an odor that is at once reminiscent of plastic and amber — suggesting a natural resin, with a plastic binder.

Identification of Transparent Yellow Gemstones

Citrine quartz is characterized by its 1.544 and 1.553 refractive indices and .009 birefringence. Although the color never seems as rich as the finest topaz, citrine, or topaz-quartz, is often very attractively colored. To distinguish synthetic quartz, see Chapter X. Gamma irradiation produces a greenish-yellow color unknown in nature. It fluoresces a yellowish green to short-wave ultraviolet. Transparent yellow labradorite has higher indices and is biaxial, so it is easily distinguished from pale citrine.

PROPERTY TABLE FOR YELLOW GEM MATERIALS
IN ORDER OF DESCENDING INDICES

Name	Polar.	Pleo.	S.G.	Hard.	Additional
Syn. rutile	D	W	4.26	6-6.5	strong doubling, fire
Diamond	S(anom.)		3.52	10	naturals, cleavage, spectrum
Zircon (high) ..	D	W	4.70	7-7.5	doubling, spectrum
Zircon (med.)	D	W	4.40	7-7.5	doubling, spectrum
Sphene	D	W	3.52	5-5.5	doubling
Spessartite	S(anom.)		4.15	7-7.5	spectrum
Corundum	D	D	4.00	9	inclusions, spectrum
Syn. corundum	D	D	4.00	9	inclusions
Chrysoberyl	D	D	3.73	8.5	spectrum
Grossularite	S(anom.)		3.61	7	inclusions
Syn. spinel	S(anom.)		3.64	8	inclusions
Spinel	S		3.60	8	inclusions
Sinhalite	D	W	3.48	6-7	spectrum, biaxial-, S.G.
Spodumene	D	D	3.18	6-7	doubling
Peridot	D	W	3.34	6-7	spectrum, S.G.
Topaz	D	D	3.53	8	S.G.
Tourmaline	D	S	3.07	7-7.5	doubling
Beryl	D	D	2.70	7.5-8	uniaxial—
Quartz & syn..	D	W-D	2.66	7	interference figure
Amber	S(anom.)		1.08	2-2.5	
Pressed amber	S(anom.)		1.08	2-2.5	inclusions
Copal	S(anom.)		1.06	2	ether softens
Glass	S(anom.)		2.3 to 4.5	5	molded?
Plastics	S(anom.)		< 2.0	< 3	acid odor
Amberdan	S(anom.)		1.23	< 3	roiled
Opal	S		2.0	5-6.5	

HANDBOOK OF GEM IDENTIFICATION

Opal of the type that has no play of color and is transparent (usually referred to as fire opal or Mexican opal) is especially low in refractive index. For fire opal, the usual refractive index is from .01 to .08, lower than the usual 1.45 figure for black or white opal. Initially, a gem tester is likely to confuse transparent opal with glass. However, it is usually distinctly lower in refractive index than the usual 1.48 low figure for glass (or even the unusual 1.44 minimum) and also much lower in specific gravity (about 2.0).

Gem materials occurring in a transparent yellow form that are so rare or that possess some fault precluding regular jewelry use and, therefore, are cut almost exclusively for collectors include the following: amblygonite, apatite, axinite, beryllonite, kornerupine, brazilianite, cassiterite, danburite, euclase, fluorite, labradorite, orthoclase, phenakite, scapolite, smithsonite, sphalerite, stibiotantalite and willemite. A brief table of the principal properties of these rarer stones is given below. All are described more fully in Chapter XVI.

	Refractive Indices		Specific Gravity
Stibiotantalite	2.370	2.450	7.50
Sphalerite	2.370		4.00-4.10
Cassiterite	1.997	2.093	6.95
Willemite	1.690	1.720	4.00
Axinite	1.678	1.685 1.688	3.29
Kornerupine	1.667	1.679 1.680	3.30
Euclase	1.654	1.657 1.673	3.10
Phenakite	1.654	1.670	2.95
Apatite	1.642	1.646	3.18
Danburite	1.630	1.633 1.636	3.00
Smithsonite	1.621	1.849	4.30
Amblygonite	1.612	1.623 1.636	3.02
Brazilianite	1.602	1.609 1.621	2.99
Labradorite	1.559	1.563 1.568	2.70
Beryllonite	1.552	1.558 1.562	2.85
Scapolite	1.550	1.572	2.68
Orthoclase	1.518	1.524 1.526	2.56
Fluorite		1.434	3.18

Chapter XXII

The Identification of Transparent Brown and Orange Gemstones and Their Substitutes

The gemstones that occur frequently in a brown color are not numerous. They are: vivid yellow-brown zircon and spinel, diamond, topaz, citrine, brown or orange sapphire and beryl, hessonite garnet, sphene, sinhalite, andalusite and amber and its substitutes. Several of these may be orangy-brown. Only the rare padparadscha variety of sapphire, fire opal, some Brazilian beryl and perhaps spessartite of the natural stones could be regarded as possessing a true orange color. Orange synthetic sapphire is common.

First Test. Clean the stone and examine it with the unaided eye or a low power loupe, to detect any identifying characteristics. In addition, note the luster, the degree of dispersion, whether doubling of opposite facet edges is visible, if there is any obvious dichroism or cleavage, and whether any of the several optical phenomena are present. Observations made initially may enable the gemologist to confirm a probable identity with a single test. If, in this preliminary examination, any of the following properties or conditions are noted, the probabilities include the following:

A red ring around the girdle when the gem is placed face down on white paper, or *a difference in luster along the crown facets*, indicates a garnet-and-glass doublet.

High luster suggests diamond, sphene, zircon, or synthetic rutile.

Strong dispersion (fire) suggests diamond, sphene, zircon, or synthetic rutile.

HANDBOOK OF GEM IDENTIFICATION

Warmth to the touch (compared to the cold feel of crystalline materials) suggests amber or substitutes, glass, opal or plastics.

Double images of opposite facet edges are often visible in a large sphene, zircon, or synthetic rutile without the aid of magnification.

A visible separation plane indicates a doublet or a triplet.

An exceedingly low specific gravity is often noticeable in amber and substitutes such as bakelite and copal.

Second Test. After an initial inspection and classification of the unknown's color and its obvious characteristics, take a refractive index reading. If the stone has a well-polished flat facet, use the normal refractometer method. If no reading is seen and the shadow area fails to extend to the liquid line, at 1.81 (which would show that the index is over the instrument's upper limit), try the spot method.

It should be possible either to obtain a reading or to determine that the index is over the limits of the refractometer on any flat or convex polished surface, unless it is mounted in a manner that makes contact with the hemisphere impossible or unless a surface film prevents optical contact. If no refractometer is available or the mounting prevents its use, immersion in liquids of known index should yield an approximation of the index. (See Chapter V.) If no approximation of index seems possible, magnification, polariscope, dichroscope and spectroscope findings should serve to identify the material without a refractive index determination. In rare instances, removal of the gemstone from the mounting for better magnification or for a specific gravity test may be needed. Refractive indices are given in the following table and other properties in a second table near the end of this chapter.

The brown or orange gemstones with indices above the refractometer's upper limit that are likely to be encountered by a jeweler include synthetic rutile, diamond, high property zircon, sphene and spessartite garnet. Garnet-and-glass doublets resembling topaz may also be over the scale in refractive index on the garnet crown.

Dark orangy-brown synthetic rutile, although not common, is

Identification of Transparent Brown, Orange Gemstones

REFRACTIVE INDICES*			
Syn. rutile	2.616		2.903
Diamond		2.417	
Zircon (high)	1.925		1.984
Sphene	1.900	1.907	2.034
Spessartite garnet		1.810	
Corundum	1.762		1.770
Syn. corundum	1.762		1.770
Chrysoberyl	1.746	1.747	1.755
Grossularite garnet		1.745	
Spinel		1.718	
Sinhalite	1.668	1.698	1.707
Peridot	1.654	1.672	1.690
Topaz	1.629	1.631	1.637
Andalusite	1.634	1.639	1.643
Tourmaline	1.624		1.644
Beryl	1.577		1.583
Quartz	1.544		1.553
Amber		1.54	
Pressed amber		1.54	
Copal		1.54	
Orthoclase	1.518	1.524	1.526
Plastics			
Polystyrene		1.59 to 1.67	
Bakelite		1.55 to 1.67	
Plexiglas and lucite		1.50	
Celluloid		1.49 to 1.52	
Glass (normal range)		1.48 to 1.70	
Glass (extreme range of gem imitation types)		1.44 to 1.77	
Opal		1.45	

* A single figure is given for isotropic, two for uniaxial, and three for biaxial materials. Variations are shown in the refractive index tables in the Appendix.

second only to the pale yellow in point of use as a gem material. Its brilliancy and richness of color make a very attractive gemstone. It is easily distinguished from diamond of comparable color by its enormous birefringence, which gives it a fuzzy appearance. Even through the table at a slight angle, the culet appears doubled with a significant separation between the two images. In this deep color, absorption of wave lengths at both ends of the visible spectrum reduces the apparent dispersion so much that synthetic rutile

may be confused with zircon or spessartite. However, the high luster and the enormous birefringence identify synthetic rutile. If necessary, the 4.26 specific gravity distinguishes it from zircon.

Zircon may be a dull brown or the vivid orangy-brown of the type sometimes called flame zircon. Fairly strong doubling is sure to be seen under magnification if the gem is viewed in several directions, but the two images are not separated to a degree approaching that of either sphene or synthetic rutile. Zircon often shows pits along facet edges, especially the heat-treated bright red to orange and brown types. Angular inclusions and a specific gravity near 4.7 distinguish it from synthetic rutile. Zircon in a brown to orange color is likely to show the typical many-lined absorption spectrum for which the Burma and Ceylon zircons are famous; this is the spectrum attributable to uranium. (See Chapter XIII.) However, failure to see a spectrum of this type should not be interpreted as proof that the stone is not zircon, since many brown or vivid red-orange zircons fail to show it. Usually, however, zircon in a brown or red-brown color is characterized at least by a 6535Å line, usually accompanied by a 6590 line. Additional lines may or may not be present.

Sphene has a birefringence that is approximately double that of zircon and distinctly greater fire. It is easily distinguished from zircon by its low specific gravity (3.52) for such a high index. In addition, it is biaxial, in contrast to both synthetic rutile and zircon. A biaxial interference figure may be located in the polariscope, using the technique explained in Chapter VI.

Brown diamond, the so-called "coffee" or other similar colors, may either be of natural color or be colored by irradiation in a cyclotron or nuclear reactor, followed by heat treatment. Diamond, of course, is characterized by its single refraction, high luster, sharp facet edges, and its characteristic lathe-turned surface on unpolished girdles, which is unlike that of any other gemstone. In addition, cleavages are frequently seen at or near the girdle, a condition not to be seen in any of the other important stones above the refractometer in index. The cause of color is best ascertained with a spectroscope, where the presence of a 5920 line in the

Identification of Transparent Brown, Orange Gemstones

yellow portion is proof of artificial origin of color. (See Chapters XIII and XVI.)

Spessartite garnet, like diamond, is singly refractive, but it is distinctly lower in luster. It is readily distinguished from diamond by immersion in a high refractive index liquid, such as methylene iodide (1.74), in which it almost disappears. The spectroscope provides a positive means of separating the two. This same immersion test serves to distinguish spessartite from a garnet-and-glass doublet with an almandite top. Usually, it has a refractive index near the upper limit of the refractometer, rather than above it.

In the 1.70's range, there are corundum, synthetic corundum, the rarely seen brown chrysoberyl, the hessonite variety of grossularite garnet, and spinel. Truly orange or brown synthetic spinel is not available, commercially, at present. Distinguishing between natural and synthetic padparadscha (orange sapphire) is one of the separations most likely to give difficulty. Synthetic padparadscha is quite common, so it is inevitable that occasionally one will be seen that has no inclusions and in this color curved striae may be almost impossible to resolve. Better success in resolving striae may be gained if the immersion liquid is not methylene iodide but a liquid with a much lower index. Bromoform, at 1.59, is about right in index but the fumes are so unpleasant that some other liquid is suggested. The spectrum and fluorescence could be identical for synthetic and natural. Thus, it is sometimes particularly difficult to distinguish the synthetic from the natural. Natural orange sapphire is very rare, but when it does occur the orange color frequently is accounted for by a combination of iron and chromium as coloring agents. If the iron appears in the spectrum in the form of lines from 4500 to 4700Å, one can be satisfied that the stone is natural. However, if only chromium lines are noted and it is flawless, the probability is that it is synthetic. The synthetic identification may be confirmed by using the method first described by Dr. Plato, a German mineralogist. The unknown stone is examined in the polariscope to find the optic axis direction. Examination in this direction under about 20 to 30X, with the unknown between crossed Polaroids, discloses two or three sets of parallel lines resembling those caused by repeated twinning at 60° to one another.

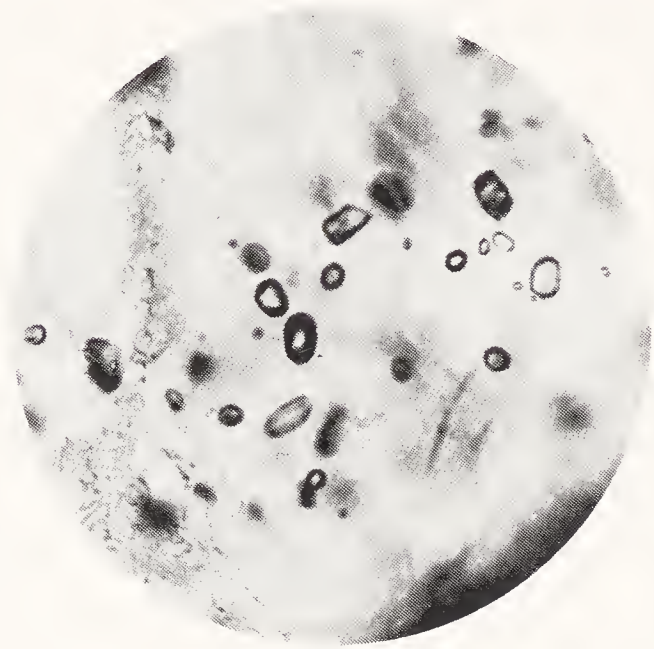

Figure 164
Diopside crystals and roiled effect in hessonite.

(See Chapter X for precise directions.) This condition is seen in the synthetic, but not in natural corundum.

Chrysoberyl in a brown color is not common, but it is encountered on occasion. Its positive optic sign and refractive index in the 1.75 range should identify it. However, if necessary, securing an optic interference figure will distinguish it easily from corundum. In addition, chrysoberyl has a distinctly lower specific gravity (3.73) compared to that of corundum (4.0). Brown chrysoberyl has an absorption spectrum made distinctive by the presence of a strong band from about 4400Å to 4520Å and a narrower band near 4290Å. The absorption in brown stones is so strong that the spectrum is almost cut off at 4500Å. (See Chapter XIII.)

At about the same index, 1.745, is hessonite garnet. It is characterized by the inclusions described and pictured in Chapter VIII. The odd granular effect that is often seen in grossularite is comparable to the roiled appearance of a saturated solution of sugar and water; it has been referred to as the appearance of heat waves over hot pavement. Diopside prisms of very low relief are found throughout the material. Thus, the distinctive appearance of grossularite under magnification and the double refraction of chrysoberyl should serve to distinguish the two readily. Hessonite is an orangy-brown and chrysoberyl a purer brown.

Identification of Transparent Brown, Orange Gemstones

Synthetic spinel is all but unknown in an orange to brown color, but natural spinel in a vivid red-orange type is common. The latter has an index of about 1.715 to 1.720; i.e., a single refractive index somewhere between these figures. Colorless synthetic spinel is used often in the manufacture of triplets composed of two parts of the synthetic and a color-imparting cement. Such triplets are easily detected by immersion.

In the 1.60 to 1.70 index range there are several possibilities. Topaz and tourmaline head the list, but sinhalite (long thought to be brown peridot), the very rarely encountered brown peridot, andalusite, and the usual substitutes are all possibilities. Orangy-brown colored topaz has indices of 1.629 and 1.637, or very close to these values. It takes an excellent polish, so it seems often to have a higher luster than its index range suggests; also, it has a slippery feel. Tourmaline, with an .02 birefringence, has refractive indices (1.624 and 1.644) both above and below topaz. Since tourmaline is uniaxial negative, the constant reading is the higher figure. Occasionally, it may be necessary to obtain an interference figure or to use heavy liquids to separate the two. Topaz is biaxial and sinks in 3.32. Tourmaline is uniaxial and floats in 3.32.

Sinhalite may be distinguished from brown peridot on the refractometer, since it has a strongly negative sign (beta is much closer to the high index), and peridot has its intermediate index almost exactly halfway between the high and the low indices. (See Chapter VI.) The indices of sinhalite are higher than peridot, even when the latter is brown. Although the series of which peridot is a member has brown members with higher properties, they are not transparent. There are distinct differences in absorption spectra. (See table in Chapter XIII.)

Andalusite is easily distinguished from topaz by specific gravity and from tourmaline by the latter's greater birefringence on the refractometer. Brown tourmaline is very strongly dichroic, since one of the vibration directions is almost totally absorbed.

The single reading for glass may be anywhere in the 1.60's, but it often resembles topaz in properties; therefore, 1.62 or 1.63 is a common reading for topaz-colored glass. It is easily distinguished

by the polariscope, or under magnification. In the polariscope, of course, glass is singly refractive, and under magnification, bubbles or swirl lines are often seen. On the other hand glass is often flawless, but it is not uncommon for either topaz or tourmaline to be flawless also. Molded facets often reveal the identity of glass to the unaided eye. Topaz may show incipient cleavage cracks under magnification. Among brown gems and substitutes in this refractive index range, plastic is a possibility, but it is easily eliminated by heft, warmth to the touch and its very low hardness. Usually, it is possible to scratch or dent plastic with a fingernail.

In the 1.50's there are a number of possibilities, including beryl, plastics of various types and indices, quartz, amber and pressed amber, plus recent resins such as copal or kauri gum. Glass, too, is a possibility in this refractive index range. Beryl may be near 1.58 in index, but 1.57 to 1.575 is a more common pair of readings for brown or orangy beryl. Quartz is always near 1.544 to 1.553, with the constant .009 birefringence. In a yellow-brown color, the pleochroism of citrine is usually very weak. Sometimes a very dark brown variety of quartz known as morion or smoky quartz, is encountered with distinct pleochroism. The yellow to yellow-brown or reddish-brown variety of quartz is usually the result of heat treating either smoky quartz or amethyst.

There are two or three problems connected with the identification of amber, because it is sometimes tampered with and substitutes may resemble it closely. Pressed amber, formed by consolidating amber chips by heat and pressure (forcing softened material through a mesh to form a homogeneous mass), could be considered reconstructed amber. It is distinguished from block amber by the means explained in detail in the preceding chapter. Copal, or kauri gum, recent resins, are softened quickly by drops of ether. Ether evaporates so quickly that several drops may be needed to be sure. If practical, a corner of the piece may be dipped into ether. One reason for tampering with amber is to hide effects of ageing and damage caused by careless use of cleaning solutions. Amberdan is an imitation sometimes offered as "cultured amber." The higher R.I. and S.G. distinguish it readily.

Identification of Transparent Brown, Orange Gemstones

Amber, copal and pressed amber are all distinguished from plastic substitutes by the reaction to a hot point, either an electrically heated needle or even a needle heated by the flame of a match. The difference lies in the resinous odor of amber, copal or pressed amber, compared to the acrid odors of plastics. Obviously, heat or a hot point must be used with great caution to avoid damage. A simpler method for distinguishing these materials from plastics is to use a saturated salt solution. Common salt in a saturated solution in water has a density of about 1.13. In this solution, bakelite, the most common amber substitute, sinks and the natural resins float. Of the plastics, only polystyrene floats, and its refractive index of 1.63 distinguishes it from amber (1.54).

PROPERTY TABLES FOR BROWN AND ORANGE MATERIALS
IN ORDER OF DESCENDING INDICES

Name	Polar.	Pleo.	S.G.	Hard.	Additional
Syn. rutile	D	W	4.26	6-6.5	doubling
Diamond.....	S(anom.)		3.52	10	girdle, cleavage
Zircon (high).....	D	W	4.70	7-7.5	doubling
Sphene.....	D	W	3.52	5-5.5	doubling
Spessartite.....	S(anom.)		4.15	7-7.5	spectrum
Corundum.....	D	S	4.00	9	inclusions, spectrum
Syn. corundum.....	D	S	4.00	9	inclusions, spectrum
Chrysoberyl.....	D	S	3.73	8.5	spectrum
Grossularite.....	S(anom.)		3.61	7	inclusions
Spinel.....	S		3.60	8	inclusions
Sinhalite.....	D	S	3.45	6-7	biaxial-
Peridot.....	D	W	3.34	6-7	birefringence
Andalusite.....	D	D	3.18	7-7.5	pleochroic
Topaz.....	D	D	3.53	8	cleavage
Tourmaline.....	D	S	3.07	7-7.5	doubling
Beryl.....	D	D	2.70	7.5-8	uniaxial-
Quartz.....	D	W-D	2.66	7	interference figure
Amber.....	S(anom.)		1.08	2-2.5	
Pressed amber.....	S(anom.)		1.08	2-2.5	
Copal.....	S(anom.)		1.06	2	
Glass.....	S(anom.)		2.3 to 4.5	5	molded?
Opal.....	S		2.00	5-6.5	
Plastics.....	S(anom.)		<2	<3	
Amberdan	S(anom.)		1.23	<3	roiled

HANDBOOK OF GEM IDENTIFICATION

One other possibility in the brown and orange category is fire opal (the type without play of color), which may have an index well below 1.45. The usual index for transparent opal is near 1.45, but indices as low as 1.37 have been encountered. Usually, it is at or below the minimum figure for glass in refractive index and the specific gravity is always lower than that of glass.

There are a number of brown and orange transparent materials that are cut for collectors but almost never for jewelry purposes. Many could be named, but the line is drawn at those actually tested at the GIA Laboratories and those with a durability that makes their use for ornamental purposes feasible. Their refractive indices and specific gravities are listed below. They are described more fully in Chapter XVI.

	Refractive Indices		Specific Gravity
Stibiotantalite.....	2.370	2.450	7.50
Anatase.....	2.493	2.554	3.90
Sphalerite.....	2.370		4.05
Cassiterite.....	1.997	2.093	6.95
Scheelite.....	1.918	1.934	6.12
Staurolite.....	1.736	1.741	3.75
Idocrase.....	1.713	1.718	3.40
Willemite.....	1.690	1.720	4.00
Axinite.....	1.678	1.685	3.29
Diopside.....	1.675	1.685	3.29
Kornerupine.....	1.667	1.679	3.30
Enstatite.....	1.658	1.662	3.25
Apatite.....	1.642	1.646	3.18
Labradorite.....	1.559	1.563	2.70
Obsidian.....		1.50	2.45
Fluorite.....		1.434	3.18

Chapter XXIII

The Identification of Transparent Pink and Red Gemstones and Their Substitutes

There are so many gemstones that occur in various tones of red, from dark red to very light red, that particular care is needed in their identification. Some, such as corundum and synthetic corundum, occur from light pink to very intense medium and even dark red, and others occur only in one or two tones. Diamond, synthetic spinel, spodumene, topaz, beryl and quartz occur almost exclusively in light or very light tones of red.

First Test. Clean the stone and examine it with the unaided eye or a low power loupe, to detect any identifying characteristics. In addition, note its luster, degree of dispersion, whether doubling of opposite facet edges is visible, if there is any obvious dichroism or cleavage, and whether any of the several optical phenomena are present. Observations made initially may enable the gemologist to confirm a probable identity with a single test or two. If, in this preliminary examination, any of the following properties or conditions are noted, the probabilities include the following:

Distinct color change from daylight to artificial light may indicate chrysoberyl (alexandrite), or synthetic alexandritelike corundum or spinel.

Adamantine luster suggests diamond or synthetic rutile.

Strong dispersion suggests diamond, zircon, or synthetic rutile.

Dichroism obvious to the unaided eye suggests kunzite, andalusite or alexandrite.

HANDBOOK OF GEM IDENTIFICATION

Warmth to the touch (compared to the cold feel of crystalline materials) is a property of amorphous materials such as opal and glass and plastic imitations.

An exceedingly low specific gravity is often noticeable in plastic imitations, when a large stone is hefted.

Double images of opposite facet edges are often visible in synthetic rutile or a large zircon, without aid of magnification.

A luster or color difference between portions of the stone or a visible joining plane suggests a doublet or triplet.

A coated back on a star stone proves a star foil back.

Molded back facets prove the unknown to be a glass or plastic imitation. (See Chapter XI.)

Second Test. After an initial inspection and classification of the unknown's color and its obvious characteristics, take a refractive index reading. If the stone has a well-polished flat facet, use the normal refractometer method. If no reading is seen and the shadow area fails to extend to the liquid line, at 1.81 (which would show that the index is over the instrument's upper limit), try the spot method.

It should be possible either to obtain a reading or to determine that the index is over the limits of the refractometer on any flat or convex polished surface, unless it is mounted in a manner that makes contact with the hemisphere impossible or unless a surface film prevents optical contact. If refractometer findings are unsatisfactory, immersion in liquids of known index should yield an approximation of the index. (See Chapter V.) If no approximation of index seems possible, magnification, polariscope, dichroscope and spectroscope findings may serve to identify the material without a refractive index determination. In rare instances, removal of the gemstone from the mounting for better magnification or for a specific gravity test may be needed. Refractive indices are given in the following table and other properties in a second table near the end of this section.

There are several gemstones above the upper limit of the refractometer in this color range, as well as in most other colors.

Identification of Transparent Pink, Red Gemstones

These include an unusual color of synthetic rutile, diamond, high and medium zircon, almandite garnet and garnet-and-glass doublets.

Synthetic rutile is characterized by an enormous birefringence of .287 and unparalleled dispersion. Diamond, almost unknown in a bright red color, is unusual but sometimes available in pink. Garnet-red stones are less rare. Treated pink diamonds seen to date have been under one-fourth carat. Natural pinks are usually

REFRACTIVE INDICES*

Synthetic rutile	2.616		2.903
Diamond		2.417	
Zircon (high, med.)	1.925		1.984
Almandite garnet		1.79	
Spessartite garnet		1.80	
Corundum	1.762		1.770
Synthetic corundum	1.762		1.770
Rhodolite garnet		1.76	
Chrysoberyl	1.746	1.747	1.755
Syn. alexandrite	1.742	1.743	1.751
Pyrope garnet		1.746	
Synthetic spinel		1.73	
Spinel		1.718	
Spodumene	1.660	1.666	1.676
Andalusite	1.634	1.639	1.643
Topaz	1.629	1.631	1.637
Tourmaline	1.624		1.644
Beryl	1.585		1.594
Quartz	1.544		1.553
Amber		1.54	
Plastics			
Polystyrene		1.59 to 1.67	
Bakelite		1.55 to 1.67	
Plexiglas and lucite		1.50	
Celluloid		1.49 to 1.52	
Glass (normal range)		1.48 to 1.70	
Glass (extreme range of gem imitation types)		1.44 to 1.77	
Opal		1.45	

*A single figure is given for isotropic, two for uniaxial, and three for biaxial materials. Variations are shown in the refractive index tables in the Appendix.

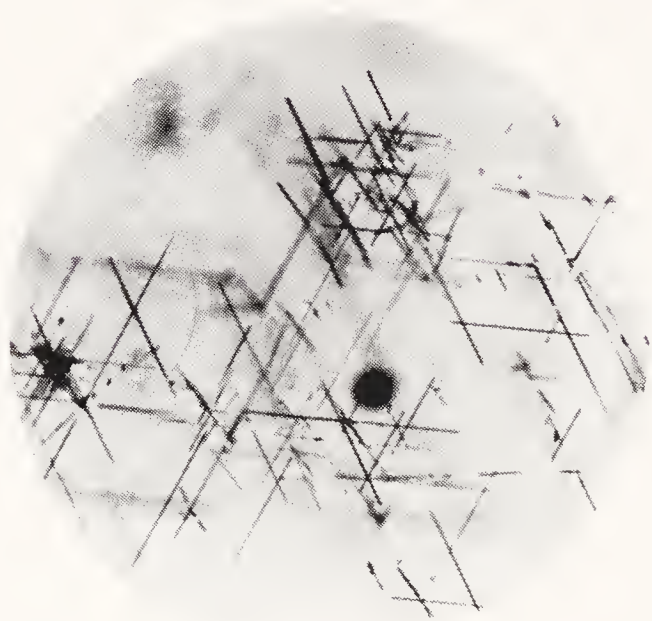

Figure 165

Photo by E. Gubelin

Needlelike inclusions in almandite. Only two sets are in the same plane.

very pale in color, whereas the treated pink is usually a strongly colored brownish-pink. The brownish-pink treated stones show the 5920Å absorption line in the yellow portion of the spectrum, in contrast to natural pink or garnet-red diamonds. Failure to show such a line, plus the pale pink color, characterizes the natural stone.

Zircon in a reddish color is usually that with properties in the medium range, but it may be the high property type. Almost all zircons are characterized by the 6535 line in the red portion of the spectrum, with another accompanying line at 6590Å. However, in a red color zircon quite frequently is without any visible line in the spectrum. Occasionally, zircon in this color resembles almandite garnet, but it is easily distinguished from garnet by its high birefringence seen under magnification. Although it is unlikely to be confused with synthetic rutile, zircon could be distinguished from it when necessary by the great difference in birefringence and fire. Furthermore, the specific gravity of zircon, even in the medium property range, is usually 4.50 or above, in contrast to the 4.26 of synthetic rutile. Almandite garnet is encountered with refractive indices all the way from corundum, at about 1.77, up to slightly above the scale. When the index is below 1.78, it is easily confused with the dark red grade often called Siam ruby. Although

Identification of Transparent Pink, Red Gemstones

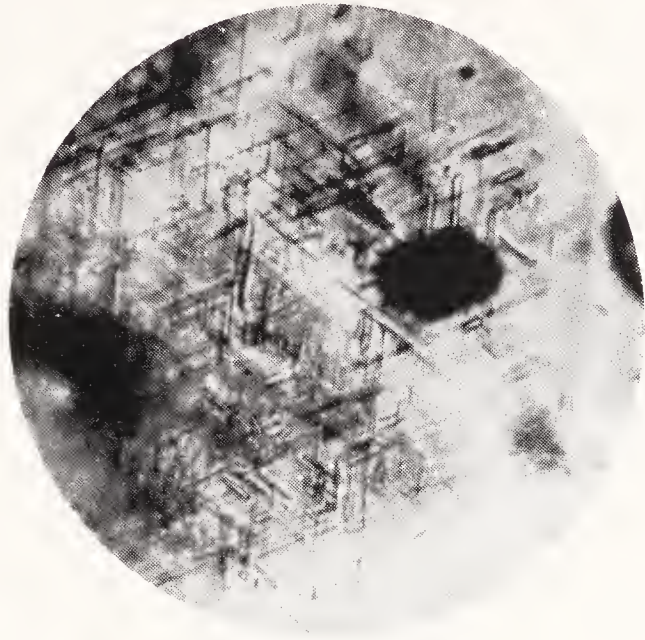

Figure 166

Three sets of needlelike inclusions in the same plane in ruby.

garnet is singly refractive and ruby doubly refractive, the polariscope reaction is often unsatisfactory in the case of single refractive almandite garnet because of its frequently strong anomalous double refraction. The method for using the polariscope to distinguish between singly refractive stones showing anomalous double refraction and truly doubly refractive stones is explained in Chapter VI. In addition, ruby is strongly dichroic, whereas garnet shows no dichroism whatever. More important, there are also distinct differences in the absorption spectra of the two stones, as shown in the tables accompanying Chapter XIII. Furthermore, the doubling in ruby should be visible under magnification, whereas none is evident in singly refractive almandite. Under ultra-violet light the garnet is inert, whereas the ruby almost always fluoresces, especially noted in a darkened room.

All that has been said with respect to almandite may be said in regard to rhodolite garnet, with the exception of the refractive index range. Rhodolite is actually a mixture of pyrope and almandite that is usually lighter in color than either in a violetish-red or a light brownish-red color. In its violetish-red form, rhodolite bears a very close resemblance to ruby. Like almandite, rhodolite may be separated from ruby by magnification, which should disclose doubling in corundum but not in garnet; by the dichroism



Figure 167

Repeated twinning laminations in corundum.

of corundum; by the difference in the absorption spectra of the two stones or by the difference in their ultra-violet fluorescence.

The methods by which natural and synthetic ruby may be identified are explained in detail in Chapter X. A short discussion seems necessary at this point, however.

Natural ruby is rarely without inclusions that are obvious under 10X. Although freedom from obvious inclusions should make the tester suspicious, it is only an indication. A very fine ruby may be flawless or nearly flawless. The major basis for separation is provided by magnification, to determine whether inclusions are spherical or elongated gas bubbles and curved striae, characteristics of a synthetic, or the angular inclusions and straight banding associated with a natural ruby. A hexagonal pattern of inclusions or banding in a natural stone is oriented so that the hexagonal arrangement is seen when viewed parallel to the optic axis, the direction of no dichroism (in a natural ruby, this is usually through the table). In a synthetic, curved striae are seen in a direction of strong dichroism, also usually through the table. Parallel glide planes or parting planes are very rarely seen in synthetic corundum. They could be confused with repeated twinning lines in the natural.

Synthetic ruby that has been heated to a high temperature and

Identification of Transparent Pink, Red Gemstones

then quenched in a liquid has many fractures and may have what appears to be dendritic inclusions in the breaks. Bubbles and curved striae should be detectable however.

There should be no difficulty in distinguishing alexandrite chrysoberyl from corundum or garnet, because of the fact that it changes from garnet red under artificial incandescent light to green in daylight. In addition, it is strongly trichroic. The usual imitation of alexandrite, synthetic sapphire, changes from an amethystine color in artificial light to a grayish-blue in daylight. Natural sapphire with a color change usually changes from violetish color to blue. Synthetic spinel with an alexandrite-like color change has been encountered only a few times, but it is by far the best imitation of alexandrite in appearance. The colors are very similar to those of alexandrite (chrysoberyl). Since it is singly refractive, synthetic spinel shows no pleochroism. Its approximately 1.728 refractive index is sufficiently separated from that of chrysoberyl to permit ready identification by a careful tester. Their absorption spectra differ also. (See Chapter XIII.) The usual reading for chrysoberyl is less likely to be confused with that of corundum than the figures in refractive index tables might suggest. Because chrysoberyl is positive in sign and the beta index is only .001 higher than the 1.746 of the alpha, the usual white light reading is seen on the low side of 1.75. Since ruby is uniaxial and negative in sign, the high reading at 1.77 is constant and always in evidence; therefore, the two stones are not likely to be confused on the refractometer.

Pyrope garnet is usually between 1.74 and 1.75 in refractive index, but it may be as low as 1.73 and very rarely down to 1.725. Red spinel is almost always just below 1.72, but figures as high as 1.744 have been reported. Distinguishing between chromium pyrope and natural red spinel is accomplished by a spectroscope. The difference between the two is evident by a comparison of the two spectra illustrated in the table in Chapter XIII. In addition, the usual inclusions in the two materials differ considerably. Spinel is characterized by the presence of octahedra. They may be large or so small that they are very difficult to resolve well enough

to make out their shape. Sometimes individual crystals are scattered throughout, but more often they are grouped in irregular sheets that resemble the "fingerprints" in corundum. Pyrope usually has needlelike inclusions, plus crystals or rounded grains of low relief.

Synthetic spinel in this color category may have several different forms. For years, it was not made in a rich red color by the Verneuil process. Most of the synthetic spinel is a very light red that resembles pink topaz or kunzite, rather than ruby. However, red synthetic spinel has been produced by the Verneuil process recently, but only in sizes yielding cut stones of well under one carat. There are some absorption spectra shown for it in the table in Chapter XIII. Another type of synthetic spinel that is very rare is that described earlier as an excellent substitute for alexandrite. Spinel and synthetic spinel are easily distinguished by the difference in refractive index and the fact that the synthetic shows the strong so-called "cross-hatched" anomalous double refraction under 5X to 10X in the polariscope. Hydrothermal synthetic spinel crystals have been described on one or two occasions, but apparently have never reached commercial gem markets.

Garnet-and-glass doublets have long been used as imitation rubies. They are made in colors very similar to those of natural rubies. In a red color, they are slightly harder to detect than in other colors, for the "red-ring" test described in Chapter XI is not useful in this separation. However, the luster difference between garnet and glass, usually visible on the crown, is sufficient to give them away. Magnification also discloses the difference in transparency between parts. Glass in a red color is rarely made with an index over 1.70. When the index is this high, the lead content makes the hardness too low for the imitation to be practical as a gem imitation, but high index glass imitations are seen more often in a red color than in other colors. It may be detected by its single refraction, high specific gravity, warmth to the touch, plus gas bubble inclusions and swirl lines seen under magnification.

In the 1.60's range, there are a number of gemstones in a red or light red color. Among these is spodumene, the most important variety of which is kunzite. Kunzite has a dichroism so strong that it is usually visible to the unaided eye when examining the stone

Identification of Transparent Pink, Red Gemstones

in different directions. The two colors are (1) almost colorless and (2) a rich purplish-red to violet. The refractive indices of kunzite, 1.660 to 1.676, are distinctly different from those of any of the other usually encountered gems in the pink and red color categories. Spodumene is usually nearly free from flaws (except for long silk-like solution cavities), but the strong two-directional cleavage is sometimes evident in cut stones.

A relatively uncommon gemstone that is being cut more frequently today than in the past is andalusite. In its gem variety, it is usually very strongly dichroic with a brownish-red color in one direction and a green in another; however, weakly dichroic pink stones are known. The bicolored nature of this stone, with both green and reddish-brown reflections evident to the unaided eye, gives andalusite a superficial resemblance to alexandrite. However, the color does not change from one light source to another. Its birefringence of approximately .009 is distinctly below that of spodumene, but close to that of another stone in the pink to red category, topaz, which in this color has indices of 1.629 and 1.637.

Topaz has a positive sign, with the intermediate index at about 1.631, only approximately .002 from the low reading. There is no likelihood of confusion with andalusite, because of the obviousness of the green dichroic color of that gem. Topaz is rarely dark red in color, but is usually a light violetish-red to reddish-violet. The chromium that causes the pink color is evident in the distinctive absorption spectrum of heat-treated pink topaz. The strong basal cleavage in topaz is also sometimes evident in a cut stone. Flat liquid-and-gas inclusions are not uncommon, and often there are two immiscible liquids within such cavities. This is very unusual in any other gemstones. Pink topaz fluoresces a dull green under short-wave ultra-violet.

Tourmaline varies from pink to deep red. Usually, it is much more strongly colored than either spodumene or topaz and is very strongly dichroic. Red tourmaline has a distinctive absorption spectrum, shown in the tables in Chapter XIII, and it is readily distinguished from other gemstones in its refractive index range by its very strong birefringence, .020. This is considerably greater

than topaz or andalusite and somewhat greater than spodumene. It is easily distinguished from spodumene by the fact that it has distinctly lower refractive indices and is negative in sign, so that the constant index is the high one, in contrast to the wide variability of the high index in spodumene.

The substitutes that may resemble the gemstones with indices in the 1.60's are synthetic spinel (1.73), synthetic corundum (1.76-1.77) glass and plastic. Glass, plastic and synthetic spinel are easily distinguished from spodumene, topaz and tourmaline by their singly refractive character; and both synthetic spinel and synthetic corundum, by the difference in refractive indices from the gemstones in the 1.60's.

The morganite variety of beryl is another gemstone that may resemble topaz and kunzite, in that it occurs in a light violetish-red color. Morganite is usually higher in both refractive index and birefringence than most of the other beryl varieties. Its usual indices are 1.585 and 1.594, and its birefringence is approximately .009. Beryl occurs naturally in a light pink color, but much of the morganite on the market is the result of heat treatment of a yellow to reddish-yellow colored beryl from a district in Brazil. Since beryl is negative in sign and uniaxial, the 1.594 index is constant and the lower index variable. As it is the only doubly refractive pink or red gemstone near 1.58 or 1.59, there should be little difficulty in identifying this variety of beryl.

Rose quartz is very rarely transparent, but on occasion it is sufficiently transparent to be faceted. More often, it is seen in cabochon form and in carvings. It is usually semitransparent to translucent, rather than transparent. It is enough lower in refractive index (approximately .04) below pink beryl that it is easily distinguished from morganite. Rose quartz may be composed of small enough grains so that it remains light rather than changing from light to dark in the polariscope, but this is rare. It sinks in a 2.62 specific gravity liquid, in contrast to chalcedony, which floats. Citrine quartz of the heat-treated type may be almost garnet-red in color, so it is still another possibility in this broad color category. Rose quartz is usually strongly dichroic in relation to the depth of color, but citrine is weak to very weak.

Identification of Transparent Pink, Red Gemstones

Glass with an index comparable to beryl, quartz or chalcedony is often encountered, but it is easily distinguished from these other gemstones by its single refraction. Glass may be molded, rather than polished. Concave facets disclose its molded origin. The same may be said of plastics, which are usually distinguished very readily simply by their light "heft," caused by their very low specific gravity. Bakelite may have an index anywhere from approximately 1.55 to 1.67, with the usual figure in the 1.60's. Again, its single refraction and light heft make it very readily identifiable.

Below the 1.44 lower limit likely to be encountered in glass is another natural gemstone, a transparent orangy-red opal, at approximately 1.43 (even down to 1.37). The specific gravity of fire opal is about 2.00, a figure below glass and above plastic.

PROPERTY TABLES FOR RED AND PINK GEM MATERIALS IN ORDER OF DESCENDING INDICES

Name	Polar.	Pleo.	S.G.	Hard.	Additional
Syn. rutile	D	W	4.26	6-6.5	doubling
Diamond	S (anom.)		3.52	10	girdle, cleavage
Zircon (high) ..	D	W	4.70	7.5	doubling
Zircon (med.) ..	D	W	4.40	7.5	doubling
Almandite	S (anom.)		4.05	7.5	spectrum
Corundum	D	S	4.00	9	inclusions
Syn. corundum	D	S	4.00	9	inclusions
Rhodolite	S (anom.)		3.84	7-7.5	spectrum
Chrysoberyl	D	S	3.73	8.5	color change
Pyrope	S (anom.)		3.78	7-7.5	spectrum
Syn. spinel	S (anom.)		3.64	8	strain pattern
Spinel	S		3.60	8	spectrum
Spodumene	D	S	3.18	6-7	fluorescent, pleochroic
Andalusite	D	S	3.18	7-7.5	pleochroic
Topaz	D	S	3.53	8	
Tourmaline	D	S	3.04	7-7.5	pleochroic
Beryl	D	D	2.82	7.5-8	uniaxial-
Quartz	D	W-S	2.66	7	rarely transparent
Amber	S (anom.)		1.08	2-2.5	rare
Plastics	S (anom.)		< 2.00	< 3	
Glass	S		2.3-4.5	5	molded?
Opal	S		2.00	5-6.5	

HANDBOOK OF GEM IDENTIFICATION

There are a number of red or pink transparent materials cut for collectors but that almost never are cut for jewelry purposes. Many could be named, but the line is drawn at those actually tested at the GIA Laboratories and those with a durability that makes their use for ornamental purposes feasible. These include the minerals listed in the following table. They are described more fully in Chapter XVI.

	Refractive Indices		Specific Gravity
Rutile.....	2.616	2.903	4.26
Sphalerite.....	2.37		4.05
Zincite.....	2.013	2.029	5.70
Cassiterite.....	1.996	2.090	6.95
Painite.....	1.787	1.816	4.01
Epidote.....	1.740	1.760	1.790
Willemite.....	1.690	1.720	4.00
Phenakite.....	1.654	1.670	2.95
Danburite.....	1.630	1.633	1.636
Apatite.....	1.642	1.646	3.18
Rhodochrosite.....	1.597	1.817	3.70
Scapolite.....	1.550	1.572	2.68
Apophyllite.....	1.535	1.537	2.40
Pollucite.....	1.520		2.92
Fluorite.....	1.434		3.18

Chapter XXIV

The Identification of Transparent Colorless Gemstones and Their Substitutes

The most important colorless or nearly colorless transparent gemstone is diamond. However, there are many other colorless natural gemstones and substitutes cut for jewelry use. Most of them have been mistaken for diamond or used to imitate diamond at one time or another. Certainly, synthetic rutile, strontium titanate (or Fabulite), gadolinium gallium garnet (GGG), yttrium aluminum garnet (YAG), zircon, both synthetic and natural colorless sapphire, synthetic spinel, topaz, beryl, rock crystal quartz, glass foil backs, diamond doublets, doublets composed of synthetic rutile and synthetic sapphire, doublets of Fabulite and synthetic sapphire, and garnet-and-glass doublets all have been confused with diamond or used to imitate diamond. The advent of synthetic cubic zirconia (usually called cubic zirconia or CZ) brought about a renewal of the diamond substitute market. The high refractive index, good color and hardness makes it diamond-like in appearance. The variety of orthoclase known as precious moonstone, and its substitutes (synthetic spinel, white chalcedony, milky quartz, glass and plastic), also are considered in this category because moonstone itself is nearly transparent. Although chalcedony is semi-transparent at best, it is considered here as well as under the non-transparent white classification. The other stones considered under the transparent colorless category include rare or seldom cut varieties of some of the other gemstones, such as spinel, spodumene and beryl. Finally, a list of rare species of interest to collectors is given at the end of the section.

First Test. Clean the stone and examine it with the unaided eye or a low power loupe to detect any identifying characteristics. Observe particularly its luster, strength of its dispersion, and whether doubling is noticeable when looking toward opposite facet edges. As a last step, look for any optical phenomenon that may be present. Among color-

less stones, play of color, a weak star or cat's-eye, or the blue sheen of adularescence are about the only likely possible phenomena. In this preliminary examination, observation of any of the following properties may facilitate identifications:

Strong dispersion suggests diamond, zircon, cubic zirconia, strontium titanate, or synthetic rutile.

Doubling of opposite facet edges suggests zircon, tourmaline, or synthetic rutile.

Play of color suggests opal.

Blue sheen in reflected light suggests precious moonstone (orthoclase feldspar).

Adamantine luster suggests diamond, zircon, cubic zirconia, synthetic rutile, or strontium titanate.

A luster difference or a plane of separation between crown and pavilion or between the upper and lower portions of the crown suggests a doublet.

A foilback, if present, should be apparent by inspection.

Second Test. After an initial inspection and classification of the unknown's obvious characteristics, take a refractive index reading. If the stone has a well-polished flat facet, use the normal refractometer method. If no reading is seen and the shadow area fails to extend to the liquid line, at 1.81 (which would show that the index is over the instrument's upper limit), try the spot method.

It should be possible either to obtain a reading or to determine that the index is over the limits of the refractometer on any flat or convex polished surface, unless it is mounted in a manner that makes contact with the hemisphere impossible or unless a surface film prevents optical contact. If the refractometer findings are unsatisfactory, immersion in liquids of known index should yield an approximation of the index. (See Chapter V.) If no approximation of index seems possible, magnification, polariscope, dichroscope and spectroscope findings should serve to identify the material without a refractive index determination. In rare instances, removal of the gemstone from the mounting for a better magnification or for a specific gravity test may be needed. Refractive indices are given in the following table

Identification of Transparent Colorless Gemstones

REFRACTIVE INDICES*

Syn. rutile	2.616		2.903
Diamond		2.417	
Stron. titanate		2.409	
Cubic zirconia		2.17	
GGG		2.02	
Zircon	1.925		1.984
YAG		1.833	
Corundum	1.762		1.770
Syn. corundum	1.762		1.770
Grossularite		1.73	
Syn. spinel		1.730	
Spinel		1.718	
Spodumene	1.660	1.666	1.676
Tourmaline	1.624		1.644
Topaz	1.609	1.611	1.617
Beryl	1.577		1.583
Quartz	1.544		1.553
Chalcedony	1.535		1.539
(moonstone substitute)			
Orthoclase	1.518	1.524	1.526
(moonstone)			
Plastics			
Plexiglas and lucite		1.50	
Glass (normal range)		1.48 to 1.70	
Glass (extreme range of gem imitation types)		1.44 to 1.77	
Opal		1.45	

*A single figure is given for isotropic, two for uniaxial, and three for biaxial materials. Variations are shown in the refractive index tables in the Appendix.

and other properties in a second table near the end of this chapter.

The colorless gemstones and substitutes with indices over the scale of the refractometer include diamond, zircon, synthetic rutile, Fabulite, cubic zirconia, doublets employing one or more parts of diamond or other materials with indices above the 1.81 maximum reading for the refractometer.

Frequently, jewelers feel that they can identify diamond on sight simply because of its luster. When examining well-cut clean stones under good lighting, many are seldom wrong. However, it is true also

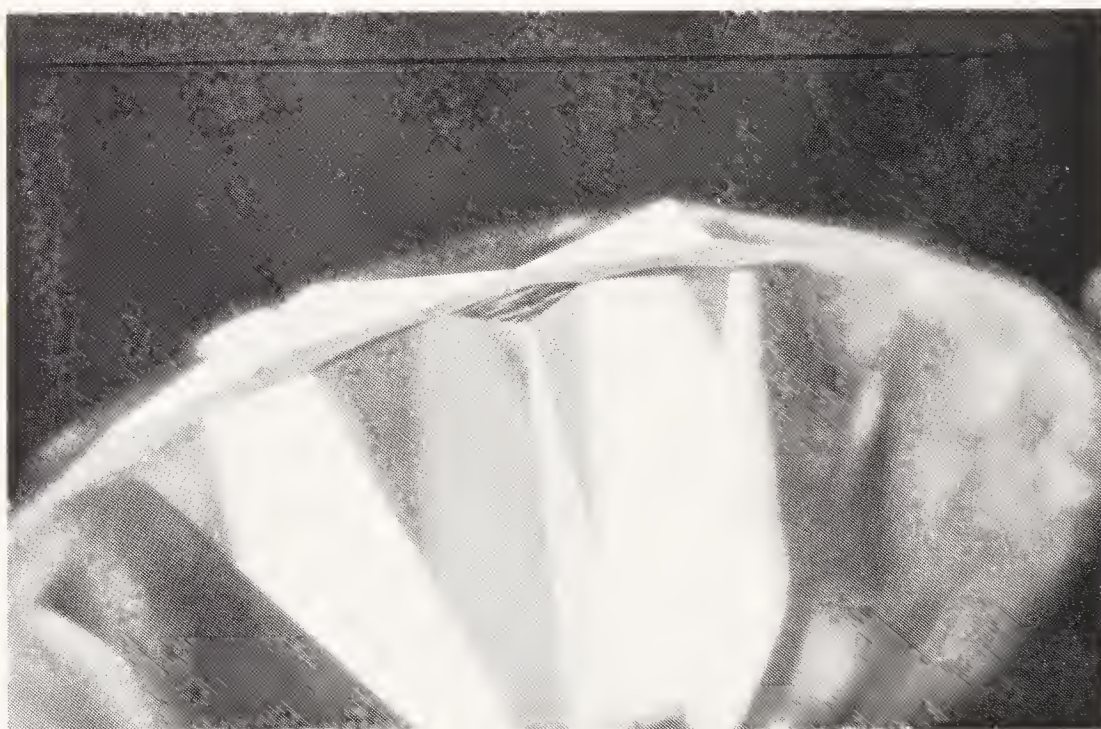

Figure 168

A shiny natural below a typically smooth, frosted, diamond girdle.

that many jewelers have been fooled by stones that, upon more careful examination, were quite obviously imitations. How may diamonds be recognized? Perhaps the most characteristic feature is the unique texture of the girdle surface on round brilliants or rounded “fancy” shapes, where the girdle has not been polished. The lathe-turning used in rounding up a diamond imparts an appearance that is not duplicated on any of its imitations. This very fine-grained surface on a finely turned girdle varies from a finely frosted to a slightly shiny reflective surface that should not be confused with any other stone. A poorer, coarser texture, caused by too-rapid bruting, is equally characteristic. The so-called bearded girdle resulting from numerous hairline fractures is never encountered in other gems; this is often still apparent on polished diamond girdles. In addition, a diamond frequently has “naturals,” portions of the original skin of the diamond, either on the girdle or near it. On such naturals, the grooved appearance expected on the rhombic dodecahedral diamond crystal faces, or the trigons usually found on octahedral faces, are unique and not seen on diamond imitations. In addition, crystal inclusions, so-called twinning or grain lines, and evidence of cleavage are all characteristics not likely

Identification of Transparent Colorless Gemstones



Figure 169
Trigons on a diamond crystal surface.

to be encountered in any of the stones often confused with diamond. Following General Electric's lead, many organizations have produced synthetic diamond grit, and General Electric has produced cuttable diamond crystals of over one carat. The costs were so great that the experimental efforts along this line have been discontinued, so it still seems some time before synthetic diamond will be a problem for the gem tester.

Other properties of diamond that are useful in its identification are luster and hardness, especially as they affect the appearance of the cut stone. In other words, no gemstone has sharper facet edges or better polish than is usually encountered on gem diamonds.

Historically, the major test for diamond by jewelers has been hardness. A hardness test very carefully applied by using a diamond to scratch corundum is not too likely to harm a diamond with a wide girdle. However, if the diamond has a bearded girdle or if the girdle is knife edged, it is very easy to cause serious damage, even though it is much harder than the stone being scratched. As a result, using a diamond for a hardness test should be avoided, except when there is no other choice. If a hardness test is performed with a diamond, apply

HANDBOOK OF GEM IDENTIFICATION

the girdle very gently to a synthetic sapphire or ruby. Diamond is so much harder that it “bites” with ease and almost no pressure is needed.

A refractive index determination is important in diamond detection, in spite of the fact that its refractive index is well above the scale of the refractometer. Thus, refractive index is utilized not by reading diamond’s index on a refractometer, but by immersing stones in a medium of very high refractive index, such as methylene iodide (1.74), to determine relative relief; this is the degree to which a stone stands out from the liquid, in contrast to other materials of lower index. In this way, it is very simple to distinguish diamond from any material other than synthetic rutile and Fabulite; these may be distinguished readily by other means. Even immersing stones in water is helpful, since diamond appears almost the same as in air, whereas such substitutes as synthetic sapphire and synthetic spinel lose much of their brilliancy.

Of the stones mentioned, those with indices in the neighborhood of diamond are synthetic rutile and strontium titanate, or Fabulite. Fabulite has an index almost exactly that of diamond, but it has considerably greater fire. Synthetic rutile has an enormous dispersion of approximately .330 between the B to G Fraunhofer lines, as compared to the .044 figure for diamond. Fabulite is approximately .200. Synthetic rutile and strontium titanate both display prismatic colors to a degree well beyond that of any natural gemstone. Both of these materials are relatively soft, strontium titanate significantly softer than synthetic rutile, but each is softer than quartz or zircon. Synthetic rutile is usually listed as 6 to 6½; polished surfaces seem to resist the #6 point, but 6 scratches a fracture surface. Strontium titanate is usually listed as 6, but a knife-blade (5½ to 6) will scratch it. Neither stone is likely to exhibit a very fine polish. There is a tendency for grooved facets and for rounded facet edges that are never encountered in diamond. Even if a diamond is poorly polished, it does not have the irregularly grooved appearance to the unaided eye or the greasiness often seen in both of the other stones. However, there is no need to use a hardness test to identify either, since both are readily identified by other means, such as high dispersion and high density.

Identification of Transparent Colorless Gemstones

Strontium titanate, like diamond, is singly refractive, in contrast to the doubly refractive synthetic rutile. The latter has an enormous birefringence of .287; this is about 69% greater than that exhibited by that familiar example of high birefringence, the Iceland spar variety of calcite. With so high a birefringence, even with a correct orientation of the optic axis (perpendicular to the table), the stone fails to avoid an appearance of fuzziness. Doubling becomes significant at even an angle of only a degree or two to the optic axis. Synthetic rutile always has a yellowish cast in its diamond-imitating form.

Synthetic cubic zirconia, 2.17 ($\pm .03$) is not as close to diamond, 2.42, in refractive index as strontium titanate, but it is closer in dispersion (.060 for C.Z.) and hard enough ($8\frac{1}{2}$) to take a more diamond-like polish. As with other substitutes, the reflectivity meter, diamond pen, or thermal probe distinguish it from diamond.

Zircon, another gemstone commonly used as an imitation diamond, is also strongly birefringent. It has slightly weaker fire than diamond, and, unlike synthetic rutile, it is usually entirely without body color when used as a diamond imitation. The birefringence of zircon is much less than that of synthetic rutile, actually less than one-fifth as great. However, doubling of opposite facet junctions is usually visible under very low magnification, if a faceted zircon is observed through the bezel facets.

An unusual feature in a colorless material is zircon's characteristic absorption spectrum. Colorless material usually shows two fairly sharp lines in the red; the stronger is at 6536 and a companion usually may be seen at 6590Å. Diamond with even a slight tint of yellow usually shows the typical absorption line in the deep violet, at 4155Å. It is so near the limit of visibility that it is often missed in a casual examination, but it is a strong line in most yellowish diamonds. Synthetic rutile has a powerful and characteristic absorption extending from 4250Å to beyond the lower limit of visibility in the violet. Zircon and synthetic rutile are readily distinguished also by the 4.70 specific gravity of colorless zircon, compared to the 4.26 of the latter. Strontium titanate is considerably higher in specific gravity than any other colorless diamond substitute, with a 5.13 specific gravity.

Two synthetics unknown in nature that have a garnet structure are

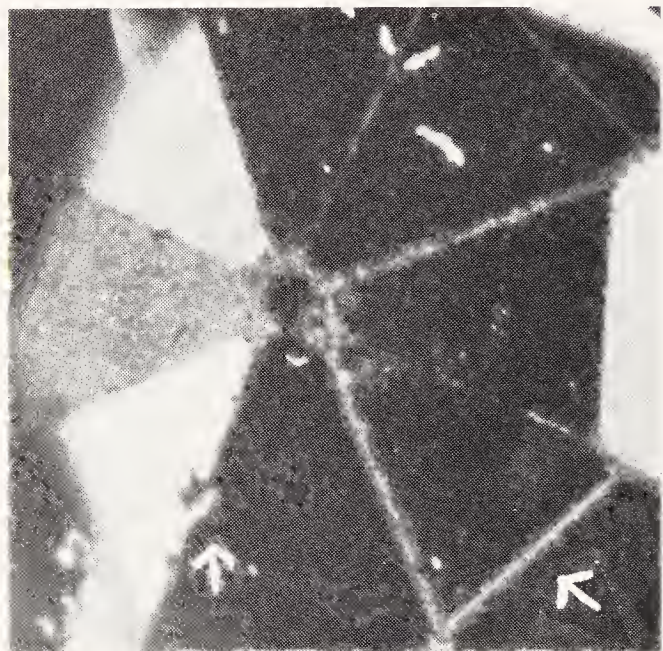

Figure 170
Doubling of opposite facet junctions in corundum.

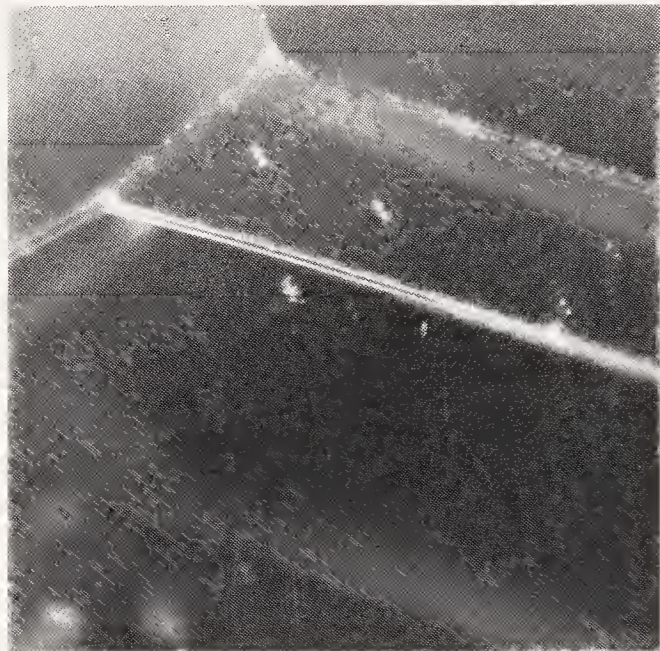

Figure 171
Doubling in tourmaline.

yttrium aluminum garnet (better known as YAG) and a more recently used, slightly better substitute, gadolinium gallium garnet (better known as GGG). YAG has a refractive index of 1.833 and a specific gravity of 4.55. GGG has a specific gravity of 7.05 (².07), which is obvious in its heft, and a refractive index of 2.02 or 2.03. YAG has a dispersion of .028, whereas GGG is .038, close to diamond. Usually GGG has a very light brown body color.

Although refractive index readings should be obtained on diamond substitutes other than strontium titanate, zircon, synthetic rutile, CL, YAG, GGG and diamond doublets (and these should show a dark shadow up to the liquid line, at 1.81) there is one precaution: diamond substitutes are frequently mounted so that a prong or side stone extending above the table of the center stone makes it impossible to use the refractometer. If such stones are diamonds, they are usually readily identified under magnification by the means explained earlier. The same is true of many of the substitutes. For example, synthetic and natural colorless sapphire, topaz and quartz should show doubling under fairly high magnification; synthetic spinel and synthetic sapphire may show bubbles. Immersion of a piece of jewelry with stones suspected of being other than diamond should make it obvious whether the relief in water or some other immersion liquid is sufficient

Identification of Transparent Colorless Gemstones

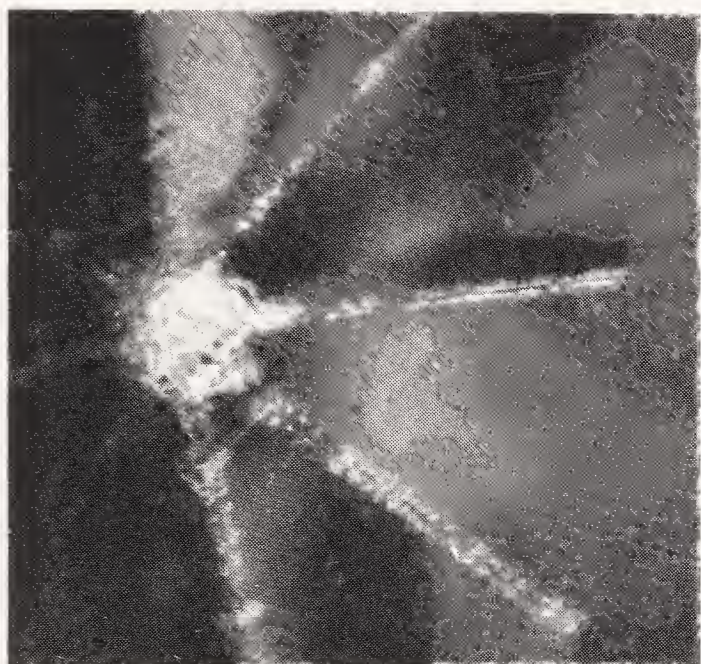

Figure 172
Doubling in zircon.

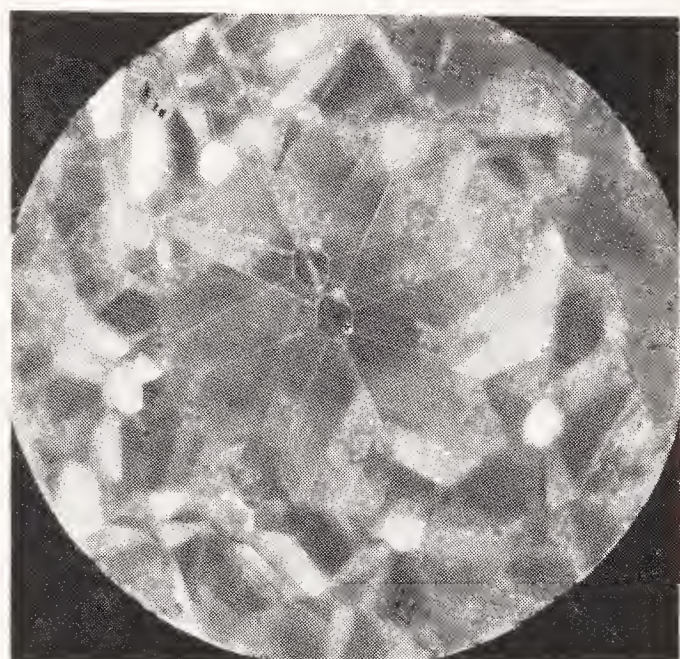

Figure 173
Doubling in synthetic rutile.

for diamond. If it is low, it is possible to estimate its relative index by comparison with known stones such as sapphire, topaz and synthetic spinel. Although it may be difficult in some rare instances to identify the stones beyond question, it is usually a simple matter to determine whether or not they are diamonds; for the jeweler, this is often sufficient.

The most use a gem tester can get from a reflectivity meter is with the diamond substitutes. Even here he must be cautious to consider the variability in results inherent in testing with this type of instrument. If the refractometer shows that an unknown is over an R.I. of 1.81, a check by a reflective meter might indicate whether the unknown is closer to the upper limits of the conventional refractometer or far above.

If the light energy source on the reflectivity meter is in the infrared, dispersion will play an important role in the position of its reading on the scale. Whereas in sodium light, strontium titanate is very close to diamond in index at about 2.409, in the infrared its index is only about 2.3. Still, there should be an appreciable difference between YAG at 1.833, white zircon at 1.925-1.98, and GGG at 2.02, whereas strontium titanate should be about 2.3 and diamond about 2.4, with synthetic rutile somewhat higher. This is all assuming that the surfaces

HANDBOOK OF GEM IDENTIFICATION

are clean, flat and well polished. Variations with a reflectivity meter are very much greater than with a refractometer.

Often, the gemologist is called upon to identify colorless stones that are obviously too low in luster to be diamonds. Usually, they are identified beyond question by refractometer, plus one other test. This is true of colorless topaz, tourmaline, quartz, beryl and spodumene. An accurate index reading plus proof of double refraction will identify any of them, although additional tests such as specific gravity or optic character could be used to separate topaz from tourmaline, if necessary.

If the reading is 1.76-1.77 the situation is not as simple, for it is necessary to determine whether the colorless sapphire is natural or synthetic. Usually, magnification will disclose either the angular inclusions associated with natural sapphire or the spherical bubbles of the synthetic. In colorless sapphire the chance of flawless material is greatest. Synthetic colorless sapphire usually fluoresces white or bluish white under short wave. The natural is usually inert, but pale-blue stones may show weak red under long wave. The presence of white fluorescence may be regarded as proof of synthetic; no fluorescence is not proof of natural. The gemologist does not have the benefit of absorption-spectrum differences, fluorescence differences (except as just noted) or curved striae as he has in some other colors; therefore, it may be necessary to utilize the technique described by Dr. Plato to detect synthetic corundum. (See Chapter X.)

Stones most commonly substituted for diamond melee are zircon, synthetic or natural colorless sapphire, or synthetic colorless spinel. Usually, it makes little or no difference whether melee is synthetic or natural colorless sapphire, since the value difference is negligible. Seldom is it worth the gemologist's time to distinguish between them, for if the melee are not diamond they have little value. If necessary, careful examination under magnification should disclose either bubbles or angular inclusions, to permit satisfactory separation. It is almost inevitable that the tester will have to assume all melee to be natural or synthetic, on the basis of clear evidence seen in a portion of the total number showing visible inclusions. If there are many synthetic sapphire melee, some are almost certain to be without visible inclusions.

Identification of Transparent Colorless Gemstones

The problem does not occur with synthetic vs natural colorless spinel, since the latter is virtually unknown. Rutile, strontium titanate and synthetic spinel are much more likely to be used for substitutes for fancy cut, larger diamonds. (To a diamond man, fancy cut used in this sense means any cut other than the 58-facet round brilliant or the single cut.) At a glance, a well-polished, emerald-cut synthetic spinel is often mistaken for diamond. In the usual spread emerald cut, the diamond's fire is subdued and is therefore less noticeably different from the weakly dispersive synthetic spinel. The low relief of synthetic spinel in any immersion liquid separates it from diamond. The anomalous double refraction in the pattern that is characteristic of synthetic spinel plus its distinctly higher index serves to distinguish the synthetic from near colorless natural spinel.

Palpable efforts to defraud are perhaps more commonly encountered with diamond substitutes than with most of the other gemstones. One that clearly took into account the gemtester's methods was that in which synthetic colorless spinel solitaires were mounted so that one or more prongs extended above the table, to prevent it from being placed on the refractometer. This occasionally led unwary testers to the conclusion that the stone had an index above that of the scale of the refractometer, since no reading was seen.

Diamond doublets appear rarely. Perhaps the main reason they are uncommon is the lack of suitable adhesive prior to the introduction of epoxy resins. Now that this extremely strong adhesive is available, a flood of diamond doublets would not be too surprising. Apparently, the main problem involved in preparing such substitutes has been the expense in comparison with the yield. Careful examination under magnification discloses the plane at which the two portions are joined.

Sometimes, the appearance of a very large diamond is gained by inference, when a flat diamond is cut in the form of the crown of a brilliant or a very flat rose cut and mounted in a gypsy setting with the portion where the pavilion would be expected to lie completely concealed by the setting. In other words, a flat diamond crystal is faceted so that its depth is perhaps 15 or 20 percent of the diameter, instead of about 60 percent for a stone with a pavilion.



Figure 174

A thin diamond cap over a space lined with metal formed to imitate pavilion facets.

It is mounted in a way that gives the impression of being a huge stone; in some instances, the metal seen through the stone has been cast over a mold to give the impression of facets. This deception is sometimes carried so far that an opening is left on the finger side of the ring from which protrudes a tiny portion of what appears to be the diamond's pavilion, but which is actually only a very small single-cut diamond. This same practice is sometimes employed in rings containing glass foil backs imitating diamonds. Flat rose-cut crowns with angular foil backs are still being made and offered for sale in the Middle East.

Although it seems difficult to conceive, doublets consisting of red garnet crowns and colorless glass pavilions have been used as diamond substitutes. The garnet crown imparts a fairly high luster to the top of the stone and does not absorb enough light to make a red tint apparent. It is only by turning the stone table down on white paper that the red table becomes evident. The garnet cap is invariably very thin, occupying only a small portion of the crown below the table. These are easily identified under magnification, by immersion, or by the red-ring test.

Grossularite garnet has been found in Tanzania in a hitherto unknown transparent rich chrome green, but also in a transparent

Identification of Transparent Colorless Gemstones



Figure 175

A diamond coated just below the girdle to improve color.

very pale green to colorless form. Transparent light green material is found also in Pakistan. The refractive index is near but usually slightly above 1.73 in the colorless form and closer to 1.74 in the rich green. The specific gravity of the colorless material is about 3.60. Fortunately, much of it shows rod or needlelike inclusions. Some inclusions, however, may resemble those of synthetic spinel, so it is fortunate that their reactions to short- and long-wave ultraviolet differ from synthetic spinel. It shows a weak green fluorescence to short wave and weak orange to long wave. The strong orangy-yellow fluorescence to X-ray that characterizes grossularite is present.

Despite the fact that rough colorless topaz and rock crystal quartz are often assumed by rock collectors to be diamonds when they are found to scratch glass, it would be almost difficult to confuse cut stones of these materials with diamonds. The rock crystal variety of quartz is much more often mistaken for diamond in the rough than is any other stone. However, it is easily identified by its hexagonal crystal form, specific gravity (2.65-2.66), and its double refraction. In addition, rock crystal shows a unique uniaxial interference figure in that the dark brushes of the figure do not cross in the center, but reach only to the edge of the innermost colored ring.

Colorless beryl and tourmaline are not common in jewelry; however, each is cut occasionally. Tourmaline's .020 birefringence, 1.624 and 1.644 refractive indices, and 3.04 specific gravity identify

HANDBOOK OF GEM IDENTIFICATION

it readily. Doubling of opposite facet junctions should be visible under magnification, and the 1.644 reading is the constant reading.

Colorless beryl is more likely to have properties near the high end of the beryl range. Indices are often over 1.58, unless the beryl has a faint bluish tinge, then indices in the 1.57 to 1.575 range are usual. It is unlikely to be confused with other colorless stones after a careful refractometer reading is obtained.

Glass has long been employed as a diamond substitute. Although it frequently bears no more than the most superficial resemblance to its valuable counterpart, the addition of enough lead and thallium can add enough dispersion to bring the fire of glass close to that of diamond. However, the highest index for colorless glass is very low compared to diamond, since the former is rarely above 1.69.

Distinguishing between moonstone and its substitutes, synthetic spinel, plastic, the more transparent forms of chalcedony, moss agate, banded agate and a form of relatively transparent white opal, should not be difficult. Orthoclase moonstone is easily distinguished from milky chalcedony by its behavior in the polariscope. Orthoclase extinguishes every 90° , and usually its biaxial interference figure may be resolved in this cabochon material. Moonstone has a cleavage that is usually evident somewhere around the girdle, in contrast to the waxy, conchoidal fracture of chalcedony. In addition, the property values for the two stones are different in that the refractive index for chalcedony is between 1.535 and 1.54, whereas that of moonstone is about 1.518 to 1.526. With care, the distinctly lower readings are easily noted on the refractometer. Doubling of inclusions based on a .008 birefringence and higher transparency distinguish feldspar moonstone under magnification. Moonstone is not always orthoclase feldspar; sometimes it has a higher percentage of albite plagioclase feldspar than orthoclase. In this case the property values are slightly higher and more nearly those of chalcedony; however, the mere presence of doubling is sufficient to distinguish between them. The quality of the floating blue light or adularescence in moonstone is never encountered in chalcedony. The synthetic spinel that imitates moonstone has been heat treated to cause some of the excess aluminum oxide to separate out and crystallize as hexagonal alumina, giving

Identification of Transparent Colorless Gemstones

the stone a milky appearance and an oriented reflectivity. The refractive index and specific gravity of synthetic spinel are so much higher than those of moonstone that there is no difficulty in separating the two. Plastic with the same type of floating light is easily identified by its very low specific gravity. Comparable opal lacks a floating light effect; however, the type that is sometimes referred to as water opal or Mexican opal is sometimes colorless and is marked by a vague play of color throughout the stone. The very low refractive index of about 1.45, but which may be even lower than 1.40, and the low specific gravity (about 2.00) serve to identify opal readily.

Mention must be made in a section on colorless, transparent stones of a large variety of materials, which occur naturally in a transparent form, that are cut principally by amateur lapidaries, and are sought by those who collect stones of any species in a faceted form. It is very difficult to keep abreast with all of the

PROPERTY TABLES FOR COLORLESS MATERIALS
IN ORDER OF DESCENDING INDICES

Name	Polar.	S.G.	Hard	Additional
Syn. rutile	D	4.26	6-6.5	doubling, fire
Diamond	S	3.52	10	girdle, cleavage
Stron. titanate . . .	S	5.13	5.5	fire, rounded facet edges
CZ	S	5.7	8.5	inclusions
GGG	S	7.02 ($\pm .07$)	6.5	brownish color
Zircon	D	4.70	7.5	spectrum, doubling
YAG	S	4.55	8+	inclusions
Corundum	D	4.00	9	inclusions
Syn. corundum . . .	D	4.00	9	inclusions
Grossularite	S	3.60	7	inclusions
Syn. spinel	S(anom.)	3.64	8	strain pattern
Spinel	S	3.60	8	very rare
Spodumene	D	3.18	6-7	cleavage, biaxial +
Tourmaline	D	3.04	7-7.5	bire.
Topaz	D	3.53	8	cleavage
Beryl	D	2.70	7.5-8	uniaxial -
Quartz	D	2.66	7	interference figure
Chalcedony	D(light)	2.60	6.5-7	waxy fracture
(moonstone)				(semitransparent)
Moonstone	D	2.56	6-6.5	cleavage, adularescence
Plastics	S(anom.)	—2	—3	heft light
Glass	S	2.3-4.5	5	molded?
Opal	S	2.00	6	play of color?

HANDBOOK OF GEM IDENTIFICATION

possibilities, since, whenever any stone with a hardness of 2 or more is found in a colorless or transparent form, it is sure to be cut by someone. In addition to spodumene, beryl, tourmaline, and topaz, there are such unusual materials as spinel, benitoite, beryllonite, augelite, hambergite, petalite, rhodizite, danburite, apatite, orthoclase (faceted), jadeite, euclase, fluorite, phenakite, pollucite, amblygonite, labradorite, bleached brazilianite, leucite, scapolite, scheelite, and numerous others that have been cut by, or for, collectors to amaze friends and confound many gemologists. A synthetic that has been used as a diamond substitute is "Linobate," a trade name for lithium metaniobate. It has a high dispersion (near .130) and a hardness of between 5 and 6. A brief table of the principal properties of these stones is given below. All are described more fully in Chapter XVI.

All of those stones listed in the following table have either been encountered in one or both of the GIA Laboratories or are sufficiently durable to qualify as gem materials.

	Refractive Indices			Specific Gravity
"Linobate"	2.21		2.30	4.64
Scheelite.....	1.918		1.934	6.12
Benitoite.....	1.757		1.804	3.64
Rhodizite.....		1.69		3.40
Jadeite.....	1.654	1.659	1.667	3.34
Phenakite.....	1.654		1.670	2.95
Euclase.....	1.654	1.657	1.673	3.10
Apatite.....	1.642		1.646	3.18
Danburite.....	1.630	1.633	1.636	3.00
Amblygonite.....	1.612	1.623	1.636	3.02
Brazilianite.....	1.602	1.609	1.623	2.99
Augelite.....	1.574	1.576	1.588	2.70
Labradorite.....	1.559	1.563	1.568	2.70
Hambergite.....	1.555	1.586	1.625	2.35
Beryllonite.....	1.552	1.558	1.562	2.85
Scapolite.....	1.550		1.572	2.68
Pollucite.....		1.525		2.92
Orthoclase.....	1.518	1.524	1.526	2.56
Leucite.....		1.508		2.50
Petalite.....	1.502	1.510	1.518	2.40
Fluorite.....		1.434		3.18

Chapter XXV

The Identification of Nontransparent Violet and Blue Gemstones and Their Substitutes

The important gem materials occurring in a nontransparent violet and blue form include natural and synthetic star sapphires and other star substitutes, turquoise and its substitutes, and lapis-lazuli and its substitutes. Violet and grayish-blue jadeite, dyed and natural blue chalcedony, and opal with an all-blue play of color are also included.

First Test. The nontransparent unknown is examined by unaided eye or a low power loupe, to detect any unique or unusual identifying characteristics or to eliminate many of the possibilities. Examine luster; nature of cleavage or fracture; luster on breaks, if any; optical phenomena, such as chatoyancy or asterism; quality of polish; and any other features. Any of the following characteristics may be of use in reducing the number of possibilities:

Intense dark blue gem with flecks of metallic yellow suggests lazurite (lapis-lazuli), or synthetic spinel.

Intense light blue color suggests turquoise or a substitute.

Dull or waxy luster on a fracture surface of a translucent blue gem suggests chalcedony quartz.

A six-rayed star suggests corundum (star sapphire), synthetic star sapphire or an imitation.

A coated back on a star stone indicates a foil back.

A play of color suggests opal.

Warmth to the touch (compared to the cold feel of crystalline materials) suggests a plastic, glass, or opal.

HANDBOOK OF GEM IDENTIFICATION

Second Test. If the unknown has a flat polished face, take a normal refractive index reading. In the more likely case that it is cut *en cabochon* and has only curved surfaces, take a spot reading. Be sure that the spot is reduced to no greater than two or three scale divisions in diameter, for greatest accuracy in reading. Although the refractive index taken by this method is not readable to quite the accuracy of the flat-facet method, it should reduce the number of possibilities materially. If no index reading is possible, the other properties of these gemstones will prove of value in identifying the stone.

Natural blue star sapphire is usually almost unmistakable. The essential inclusions usually impart a silkiness that often is concentrated in an obvious pattern of hexagonal zoning. "Fingerprints" and other natural inclusions are usually visible under low magnification. Linde and German (Gemma) star sapphires are characterized by their near opacity and by such a concentration of minute inclusions that a star is visible even in very diffused light. The needle-like inclusions in synthetic stars are not resolvable individually at

Name	R.I.	S.G.	Hard.	Additional
Corundum	1.762-1.770	4.0	9	inclusions
Syn. corundum	1.762-1.770	4.0	9	inclusions
Azurite	1.730-1.840	3.80	3.5-4	acid, effervescent
Syn. spinel	1.728	3.52	8	vivid color
Dumortierite	1.678-1.689	3.30	7	blue or violet
Diopside	1.675-1.701	3.29	5-6	dark blue
Jadeite	1.66-1.68	3.34	6.5-7	spectrum
Smithsonite	1.620-1.850	4.30	5	acid, effervescent
Turquoise	1.610-1.650	2.75	5-6	light blue
Lazulite	1.610-1.640	3.09	5-6	dark blue
Odontolite	1.600-1.610	3.10	5	acid, effervescent
Synthetic turquoise	1.59-1.60	2.66	5	no spectrum
Quartz	1.544-1.553	2.66	7	foil back
Chalcedony	1.535-1.539	2.60	6.5-7	waxy fracture
Stichtite	1.516-1.542	2.16	1.5-2	acid, effervescent
Lapis-lazuli	1.50	2.75	5-6	pyrite
Sodalite	1.48	2.24	5-6	
Plastic	1.49 to 1.67	<2.0	<3	soft
Glass (normal)	1.48 to 1.70	2.3-4.5	5	bubbles
Opal (black opal)	1.45	2.15	5-6.5	play of color

Nontransparent Violet and Blue

Figure 176
A synthetic sapphire backed
by lined metal to simulate a
natural star.



less than about 50X. Bubbles are visible in great numbers, if a strong beam is directed at the cabochon from the side and the point of examination (under 10X to 30X) is outside the direct path of the beam. Curved lines are usually visible too. German synthetic stars have a tight circular bull's-eye pattern on the flat base. Circular banding is seldom visible on the base of Linde stars. The use of short-wave ultra-violet light and spectroscopy, to distinguish between natural and synthetic blue star sapphires, is explained in Chapter X. German stars are usually more transparent and show the Plato effect readily.

Foil backed star quartz and foil backed synthetic corundum star imitations are included in the nontransparent section because no light is transmitted directly through them from top to bottom. They are easily detected by inspection. The quartz is almost colorless from the side, and the transparent synthetic is given a star effect by engraved lines on its flat base or on a metal mirror. It bears little resemblance to a natural star because of the absence of the luster or sheen caused by needlelike inclusions.

There are several forms of natural star sapphire doublets that have been encountered from time to time. They are particularly likely to trap the unwary because of the obviously natural appearance of the portion in view above the setting. Usually, the top is a

white to blue-gray star sapphire with sharp star but enough transparency for the blue color from beneath to impart its color to the whole. The color may come from a blue cement, a blue lower piece of dyed or naturally colored corundum, or of synthetic corundum with appropriate color. Careful use of magnification and examination of the base serves to detect the deception. In blue doublets, cobalt coloring in the cement or in a dyed back may show red through a color filter, or an arborescent pattern or bubbles may appear in the cement layer. The back may be too transparent, show bubbles, or show dye introduced into cracks by quenching a heated stone in the dye.

There are many processes by which inferior turquoise is treated to improve appearance and durability. For many years, chalky turquoise with a very low specific gravity and high porosity has been treated with paraffin, or various oils or other substances to deepen the color materially and to fill the pores. This substitute for fine-quality turquoise is very inferior, since it soon loses its attractive color and takes on a greenish cast. Paraffin impregnated material often becomes mottled with whitish spots. Detergents may remove the wax and reduce it nearly to its original chalk-like consistency. Turquoise that has been treated with wax, plastic, or sodium silicate is distinguished by a considerably lower specific gravity than the usual figure of 2.75 to 2.80 for fine, compact turquoise. Impregnated material may be as low as 2.30, but 2.4 to 2.7 is more common. Impregnation of porous material with plastic or sodium silicate make a much more satisfactory substitute, because it is not only durable but the color-retention properties are infinitely superior to those of oil- or paraffin-impregnated turquoise.

Sometimes, blue powdered material, either turquoise, various salts of copper or other metals, are compacted under heat and pressure to form a tabletlike substitute. It has been sold under such incorrect names as "reconstituted turquoise," and "synthetic turquoise." This imitation is different in structure under magnification from natural turquoise. It has a granular, porcelainlike appearance, in contrast to turquoise's very fine-grained structure. Under magnification, grains of a blue material darker than turquoise are

Nontransparent Violet and Blue

visible in a lighter groundmass of distinct grains. Some has a spiderweb pattern of brown to black, simulating matrix. Three different types tested in the GIA Laboratories had specific gravities of 2.75, 2.58, and 2.06. This kind of imitation usually contains a copper compound to produce the blue color. The copper salts used are soluble in hydrochloric acid, so a tiny drop of acid (one part concentrated acid to two parts of water is a satisfactory concentra-

Figure 177

Polished cabochon of natural spider-web turquoise.

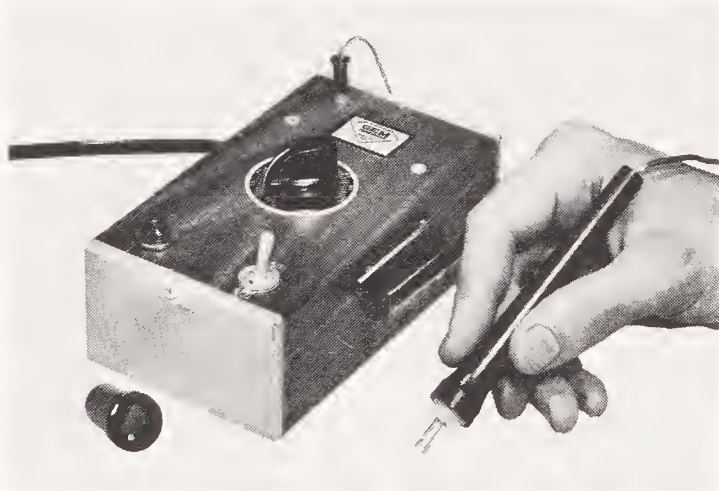
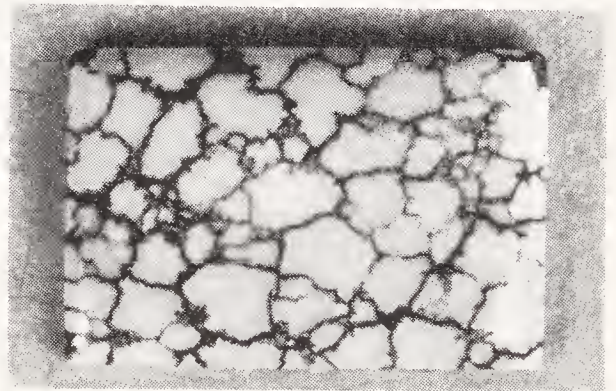

Figure 178
GIA Thermal
Reaction Tester.

tion) quickly turns greenish-yellow. This is obvious on white tissue used to wipe off the spot, if not obvious immediately on contact. In 1972 Pierre Gilson of France introduced a material he described as synthetic turquoise. The material gives a turquoise pattern of X-ray diffraction, but some doubt has been cast on its description as synthetic turquoise by the claim that a binder is used to hold the turquoise particles together. It is readily identifiable under about 50x when a multitude of tiny spherical blue particles are seen in a whitish ground mass. Early material was low in hardness and had a tendency to crack. A darker blue, scum-like material often would appear on the surface after a few months. No

*Figure A*

Imitation turquoise made of plastic with a sand filler. The R.I. of those tested was near 1.56 and the S.G. below 2.0.

Photo by GIA

turquoise spectrum was evident in the material. Currently, the appearance under high magnification provides an excellent means of identification.

Wax, paraffin or plastic impregnation can be detected readily by the use of an electrically heated point, such as a wax modeling tool, the point of a soldering tool or even a red-hot needle. If a red-hot point is brought close to wax-impregnated turquoise, the wax runs ahead of the needle and is readily visible under magnification. Material mottled with white or uniformly whitened at the surface regains its blue color under the hot point when the paraffin or wax resets. The point does not usually need to be touched against the surface to cause the wax or paraffin to liquefy. To detect plastic impregnation, it is necessary to bring the point in contact with the stone at some inconspicuous spot and to note the odor given off by the scorched material. The acrid odor of plastic is distinctive and should be easily recognized. Sodium-silicate-treated material gives no detectable odor, so the low density is the only proof of treatment.

By the spot method, the turquoise reading is characteristically just over 1.60; figures above 1.61 are not usually encountered. Gem turquoise is very compact and has an almost vitreous appearance when well polished. The glass substitute for it can be an excellent imitation, particularly in a well-polished cabochon; however, it is possible to detect the vitreous luster on small conchoidal fracture surfaces, in contrast to the dull luster of small fractures

Nontransparent Violet and Blue

on turquoise. In addition, it is usually possible to see bubbles just beneath the surface of the glass or hemispherical holes in the surface. Synthetic turquoise shows a single index reading near 1.60. It is 5 to 6 in hardness.

A gemstone that may be confused with turquoise is chrysocolla quartz (chalcedony). It is an attractive gemstone when it contains enough chrysocolla to assume the beautiful blue color of that mineral but not enough to have the characteristics of pure chrysocolla, such as a hardness of 2 to 4 and a specific gravity near 2.20. Although some fine chrysocolla quartz resembles turquoise closely, it has the properties of chalcedony (refractive index approximately 1.535 to 1.54 and specific gravity at or below 2.6). Chalcedony, apparently, has not been dyed successfully to a color closely resembling turquoise. Chrysocolla quartz is usually more transparent than turquoise.

Odontolite, once well known in Europe as "bone" or "fossil turquoise," is almost unknown in America. It is a fossilized form of vertebrate bones or teeth colored blue by the mineral vivianite. Odontolite was once mined extensively from sedimentary beds in southern France for use as a turquoise substitute. It is easily distinguished from turquoise, for it effervesces with a drop of hydrochloric acid, whereas turquoise is inert. Its specific gravity is slightly over 3.0, and it has a structure under magnification characteristic of either tooth or bone.

There are only a few stones that are likely to be confused with lapis-lazuli. The one bearing the closest resemblance in appearance is the most recently introduced substitute, sintered synthetic spinel. This type is made by heating magnesium and aluminum oxides with cobalt oxide to a high temperature for a protracted period (but a temperature well below the melting point of spinel). The resulting crystalline mass has the properties of synthetic spinel, except that pore spaces caused by failure of the powder to melt reduces specific gravity to 3.52. Unless the stone is well polished, the 1.725 index may be difficult to see by the normal method, but a good idea of its position should be obtained from the spot method. The cobalt coloring imparts a bright-red color to the stone under the emerald filter; in contrast to the low intensity of brownish-red for lapis. The pyrite of lapis is sometimes imitated by gold added to this synthetic.

The absorption spectrum of the sintered material differs somewhat from the transparent blue synthetic spinel. The usual cobalt lines appear in a weaker, more diffused form as a broad smudge in the 5300 to 6000Å area. Two stronger bands are centered near 6500 and 4800Å, with a weaker band near 4500Å.

Lapis-lazuli is actually a rock composed of lazurite and hauynite, plus sodalite as its blue constituents, with a number of other minerals providing constituents of other colors. One of the others that is almost always present is pyrite, the metallic yellow specks one associates with lapis-lazuli. Another common constituent is diopside.

Sodalite in a relatively pure form is, in a sense, regarded as a substitute for lapis. It is more translucent than lapis-lazuli and seems to lack the vividness of color that is associated with fine-quality lapis.

The specific gravity of lapis is about 2.75, but it varies from less than 2.7 to slightly over 3.0, depending on the abundance of the appreciably denser pyrite included; fine-quality material is usually about 2.8. On the other hand, pure sodalite has a specific gravity of about 2.25. The refractive index for lapis is approximately 1.50, but often the presence of diopside accounts for a second reading also visible near 1.68. Sodalite is usually about 1.48.

The dyed jasper once widely sold incorrectly as "Swiss lapis" often bears no more than the vaguest resemblance to lapis, but occasionally it is very similar in appearance. The color is seldom vivid and the dyed jasper lacks the pyrite that usually is seen in lapis-lazuli. The approximately 1.54 index of jasper easily distinguishes it from lapis.

Lazulite is sometimes quite similar to lapis-lazuli in appearance but actually more often resembles sodalite. Better qualities of lazulite are easily distinguished from lapis by the lack of pyrite in a material that has a specific gravity near 3.1; in other words, if lapis is 3.0 or over in specific gravity, pyrite would have to be abundant. In addition, the refractive indices are much higher, at 1.61 and 1.64. Usually, sodalite and lazulite contain an abundance of white material that is characteristic only of inferior lapis.

Dumortierite is a dark-blue to blue-violet mineral that resembles

Nontransparent Violet and Blue

lazulite and sodalite more than it does lapis-lazuli; it is easily distinguished by its index (near 1.68-1.69) and by its specific gravity (3.30) near the 3.32 liquid.

Violane, a rich violetish-blue variety of diopside, is sometimes cut in cabochon form. Its refractive indices are 1.675 and 1.701, and the specific gravity is about 3.29. The birefringence is approximately .026, about twice that of dumortierite. This should be evident by rotating a Polaroid plate in front of the scale while viewing the spot at the approximate point of the reading. Violane is 5-6 in hardness, compared to 7 for dumortierite.

Light grayish-blue or bluish-gray jadeite is used for jewelry and for carvings. The characteristic 1.65 refractive index, specific gravity near that of methylene iodide, and the strong 4370Å absorption line in the violet serve to identify it conclusively.

Smithsonite, which resembles translucent chrysocolla quartz or a light blue agate, is cut primarily for ornamental objects. Its effervescence to hydrochloric acid and its great birefringence indicated by refractive indices of 1.62 and 1.81 + identify it readily.

Blue aventurine glass with tetrahedral copper crystals is similar to goldstone. It is unmistakable in appearance; a very poor imitation of lapis-lazuli. It has a refractive index near 1.55 and a specific gravity near 2.65.

Amethystine quartz in a nontransparent form is often used in carvings and less often in a cabochon form for jewelry. Usually, it has an attractive violet-and-white banded pattern.

Stichtite occurs in semitranslucent light violetish-red; it is used for carvings and it is also fashioned into cabochons. It is readily identified by its low hardness of 1.5 to 2 and it is effervescent to hydrochloric acid. The refractive index may be difficult to obtain because of poor polish (1.516 to 1.542); specific gravity is near 2.16.

Opal with a play of color limited to blue is included here, because it gives the impression of being a blue stone from any direction. It is easily identified by its 1.45 refractive index and specific gravity of 2.15.

Chapter XXVI

The Identification of Nontransparent Green Gemstones and Their Substitutes

This chapter could be subtitled "The Identification of Jade and Jade Substitutes," because the majority of the nontransparent green stones have been used as jade substitutes.

Two distinct minerals are correctly called jade; jadeite, a member of the pyroxene group of minerals, and nephrite, a mineral variety related to actinolite and tremolite, both members of the amphibole group of minerals. Both jadeite and nephrite have two different uses and there are two groups of jade substances depending on those uses. The jade used for strictly jewelry purposes is substituted for by a number of other green minerals, including grossularite garnet, idocrase (or californite), nontransparent emerald, synthetic emerald, aventurine quartz, glass, serpentine, fluorite, dyed onyx marble (dyed calcite in the form of onyx), prehnite and plastic. In the other category is the type of jade used for carvings. The substitutes for jadeite or nephrite in this classification include the soapstone or steatite varieties of talc; sillimanite, or fibrolite; pseudophite; agalmatolite (better known as pagoda stone); saussurite and verdite as well as many of the materials used in jewelry. In addition to jade and the jade substitutes there are a number of nontransparent green gem materials such as green star sapphire, opaquish green chrysoberyl cat's-eye, malachite and others.

First Test. The nontransparent unknown is examined by unaided eye or a low power loupe, to detect any unique or unusual identifying characteristics or to eliminate many of the possibilities. Examine luster; nature of cleavage or fracture; luster on the breaks; optical phenomena, such as chatoyancy or asterism; quality of polish; and any other features. Any of the following characteristics may be of use in reducing the number of possibilities:

Nontransparent Green

- A six-rayed star* suggests corundum (star sapphire).
- A single sharp band of reflected light across the crest of a gem with a silky luster* suggests chrysoberyl (cat's-eye), quartz, diopside, tourmaline, or glass.
- A light and dark yellowish-green agatelike banding in an opaque green stone* suggests malachite.
- A play of color* suggests opal.
- Warmth to the touch* (compared to the cold feel of crystalline materials) suggests a plastic, glass, or opal.
- A "shredded" or gridlike appearance in a light blue-green semi-translucent gem* suggests amazonite (microcline feldspar).
- Dull or waxy luster on a fracture surface of a translucent green gem* suggests chalcedony quartz.
- A radial fibrous structure* in a dark green material suggests malachite or chlorastrolite.

Second Test. If the unknown has a flat polished facet, take a normal refractive index reading. In the more likely case that it is cut *en cabochon* and has only curved surfaces, take a spot reading. Be sure that the spot is reduced to no greater than two or three scale divisions in diameter, for greatest accuracy in reading. Although the refractive index taken by this method is not readable to quite the accuracy of the flat-facet method, it should suffice to reduce the number of possibilities materially. If no index reading is possible, the other properties of these gemstones will prove of value in identifying the stone.

By far the most valuable and coveted of the two jades is furnished by jadeite. When colored an intense green by chromium, jadeite brings the highest prices and is greatly desired by collectors. It occurs from fairly dark bluish-green to a very intense, almost emerald-green, which is usually slightly more yellowish-green than emerald. In the finest quality, so-called Imperial jade is almost transparent. Often, the green color occurs as patches in a white background. The refractive index of jadeite is usually given as 1.654 to 1.667; however, on readings obtained by the spot method, a 1.66 figure is the one usually expected. The specific gravity is almost exactly that of methylene iodide, the 3.32 liquid. The spectroscope is an exceedingly valuable tool when employed in the

HANDBOOK OF GEM IDENTIFICATION

Name	R.I.	S.G.	Hard.	Additional
Corundum	1.762-1.770	4.00	9	silk, spectrum
Chrysoberyl	1.746-1.755	3.73	8.5	silk, spectrum
Grossularite	1.725	3.50	7	black inclusions
Idocrase	1.713-1.718	3.40	6.5	greasy
Saussurite	1.700-1.710	3.20	6.5-7	
Malachite	1.660-1.910	3.3-3.9	3.5-4	banded
Jadeite	1.66-1.68	3.34	6.5-7	spectrum
Sillimanite	1.659-1.680	3.21	6-7	
Chlorastrolite	1.650-1.660	3.20	5-6	fibrous
Smithsonite	1.620-1.850	4.30	5	acid effervescent
Tourmaline	1.624-1.644	3.08	7-7.5	cat's-eye?
Prehnite	1.615-1.646	2.88	6	near transparent
Turquoise	1.610-1.650	2.8	6-6.5	dull fracture
Faustite	1.610-1.650	2.8	6-6.5	dull fracture
Nephrite	1.606-1.632	2.95	6-6.5	
Verdite	1.580	2.90	3	dark green
Beryl	1.570-1.580	2.71	8	inclusions
Pseudophite	1.570-1.580	2.70	2.5	R.I. vague
Syn. emerald	1.561-1.565	2.66	8	fluorescent
Variscite	1.560-1.590	2.50	4-5	
Serpentine	1.560-1.570	2.57	2.5-5.5	greasy
Agalmatolite	1.550-1.600	2.80	2.5	R.I. vague
Quartz	1.544-1.553	2.66	7	inclusions
Steatite	1.540-1.590	2.75	1-2.5	very soft
Chalcedony	1.535-1.539	2.60	6.5-7	waxy fracture
Albite	1.530-1.540	2.77	6	light green
Microcline	1.522-1.530	2.56	6-6.5	cleavage
Plastic	1.49 to 1.67	<2	<3	
Glass (normal)	1.48 to 1.70	2.3 to 4.5	5	molded?
Opal	1.450	2.15	5-6.5	
Fluorite	1.434	3.18	4	cleavage

identification of jadeite: not only does it serve to detect green dye in stones cut for jewelry, but it is useful in distinguishing between jadeite and substitutes in large carvings as well as small cabochons. Stones that are light enough in color so that the blue and violet end of the spectrum is not entirely absorbed show a strong, sharp line at 4370Å. This is frequently but not always present.

In the spectroscope naturally green jadeite shows the three chromium lines in the red that are shown in the spectroscope chapter. The three lines resembling steps are at approximately 6300, 6600 and 6900 Å. In contrast, a freshly dyed green jadeite

Nontransparent Green

shows one broad band that may extend from 6300 to over 6700. One that has faded somewhat may be lighter and less broad.

Very dark green jadeite may seem to show this intense single, broad band, but if strong light is used and the stone is rotated, the three lines may be seen.

When nephrite powder is tested for refractive indices under the polarizing microscope, the exact determinations are usually 1.606 to 1.632, but the spot method gives a result that is usually 1.61. The specific gravity is often near the bromoform reading, but slightly above it. Bromoform has a specific gravity of 2.89, and nephrite is usually approximately 2.95, although readings slightly above 3.00 have been recorded. The only variety that is likely to be confused with fine jadeite is the apple-green material found in Wyoming. This type of Wyoming jade has a rich-green color, but it is slightly lower in intensity than the emerald-green of fine jadeite. Other green nephrite is usually a dull blackish (spinach-colored) green.

Of the gemstones likely to be confused with jade, a prominent one is that misnamed "Transvaal," or "South African jade," the green translucent variety of grossularite garnet; it is easily separated from jade by its 1.725 refractive index. Jadelike grossularite usually contains small black specks visible to the unaided eye. Although it is singly refractive, in contrast to the doubly refractive nature of jadeite, this is often impossible to determine in the polariscope. Grossularite fluoresces orange under X-rays. In appearance, "South African" or "Transvaal jade" is much more nearly comparable to the Wyoming nephrite than to jadeite. Occasionally, an index as low as 1.70 is encountered.

Low-property green grossularite (actually hydrogrossular) may be very difficult to separate from translucent green idocrase, because the R.I. and S.G. may be very close and grossularite may show a 4640Å line such as that always seen in idocrase. Often, the grossularite is higher in index and the 4640 line weak or absent, but it seems to be strongest when the index is lowest. It has a strong fluorescence to X-rays that idocrase lacks.

Green hydrogrossular, the jade substitute from South Africa, grades into idocrase, so there is a point where the gemologist has to decide whether a specimen should be called idocrase or hydrogrossular, since both are calcium-aluminum silicates.

The bowenite variety of serpentine, both harder and denser than the usual serpentine, is also richer in color and much more reminiscent of jade. In addition, the williamsite variety has an attractive green color, and common serpentine is sometimes dyed to a richer color that resembles fine jadeite. Whether dyed or naturally green, serpentine has a greasy appearance that is characteristic. It is more transparent than most jadeite. The californite variety of idocrase has a somewhat similar appearance, but its luster is much higher. Serpentine is yellow, greenish-yellow or yellowish-green. In a yellow to greenish-yellow form, it is often carved in the form of ash trays and figurines. Serpentine is identified by its refractive indices (in the vicinity of 1.56), and specific gravity (2.2 to 2.4 for normal serpentine and 2.5 to 2.6 for bowenite). The greenish-yellow variety is usually nearer 1.54 in index. It shows a fairly strong absorption band at about 4600-4700Å. Normal serpentine is distinctly less hard (2.5-4) than bowenite (5.5-6).

Much more important than any other materials used as a substitute for fine jadeite are low quality jadeite dyed to a fine green, and jadeite triplets. Pale jadeite may be dyed a rich emerald-green, making it appear many times as valuable. This substitute is prepared by subjecting light colored inexpensive jadeite to an organic dye. It is detected either by causing the color to fade through the use of an oxidizing agent, such as nitric acid, or, without harm to the stone, by the spectroscope. Three absorption lines in the red portion of the spectrum of naturally colored green jadeite distinguish it from the dyed type that shows a smudged band. They are illustrated in the spectra table in Chapter XIII. To date, the dye used has faded rapidly; often, it becomes undetectable after a year or less. A partially faded piece shows the dye band in the spectrum, if light is passed through as thick a section of the stone as possible. There are several typical spectra of natural and dyed jadeite in Chapter XIII.

Sometimes translucent white or pale green jadeite is set in a mounting with a green coloring agent hardened into place behind the stone, so it is concealed by the metal. Unless there is an opening through which the colorant is visible, a spectroscope test is called for. The green will not have a jadeite absorption pattern.

The other type of imitation is made by cutting a cabochon of

Nontransparent Green

translucent white jadeite and a thin hollow cabochon of the same shape to fit as a slightly larger cap over the first cabochon, plus a flat disc of the same material for the back. The jadeite shell is filled with an intense, emerald-green, jellylike substance and the cabochon is forced into the shell, so that the green coloring is evident. Then the flat disc is applied to the back with an adhesive. The result is a beautiful, translucent green triplet that closely resembles fine jadeite in appearance. It is easily identified by bubbles in the jellylike layer, and the contact zone between the hollow cabochon and the flat back is also visible, if unmounted. If the assembly is mounted, the back disc is often covered to hide the deception. Mountings with covered backs are suspect. Such triplets show the dyed jadeite spectrum.

Neither emerald nor the many synthetic emeralds are considered as jade substitutes, but in translucent form they are widely used in jewelry. Both are usually more transparent than jadeite, but this is not a dependable test, since the finest Imperial jade is sometimes highly transparent, and heavily flawed synthetic and natural emerald may be nearly opaque. In appearance, natural emerald may bear a marked resemblance to fine jadeite. The synthetic material however, has a distinctly bluish cast. Both are easily distinguished from jadeite by refractive index, specific gravity, or by the dichroism of both synthetic and natural emerald.

Natural emerald usually has an index in the vicinity of 1.58, distinctly above the approximately 1.565 of the synthetic product. They are readily separated by a 2.67 liquid, in which the synthetic floats and the natural sinks, unless the latter contains many voids. Inclusions are distinctly different, with the natural usually showing three-phase inclusions and the synthetic, wisp-like or veil-like inclusions. (See Chapter X.) The fluorescence of the translucent synthetic emerald under long-wave ultra-violet in a dark room is particularly evident, in contrast to the natural.

Aventurine quartz with green fuchsite mica inclusions is another rich-green material that is easily mistaken for nephrite in appearance. It has been sold as "Regal jade" and by many other names, such as "Indian jade," implying that it is a natural jade material. However, its lower refractive indices (1.544 and 1.553) and spe-

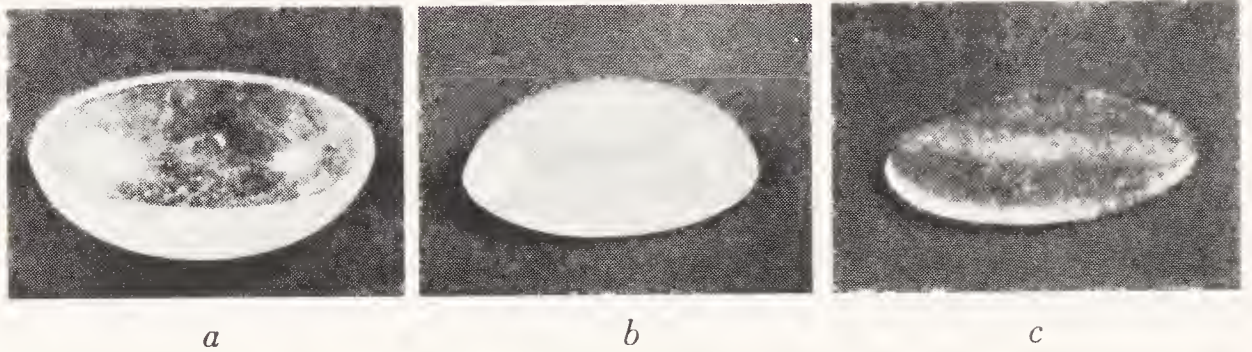

Figure 179

A three-part substitute for Imperial jade made by sandwiching an emerald-green material between parts a and b. C seals the combination.

cific gravity (between 2.65 and 2.66) distinguish it immediately from either jadeite or nephrite. Another variety of quartz is a more evenly colored yellowish-green semitranslucent type sometimes called buddstone. It has the usual crystalline quartz properties. Chrysoprase, a yellowish-green chalcedony, has even lower properties than aventurine, as does dyed green chalcedony; the latter has a characteristic absorption spectrum, which is shown in Chapter XIII.

Idocrase, or californite, resembles nephrite more nearly than it does jadeite, but it is easily distinguished from either by the fact that it has a higher refractive index and specific gravity. The specific gravity is too close to that of jadeite to be used as a distinguishing test, however. The refractive index is in the 1.70 to 1.71 range and the specific gravity is 3.40; it usually sinks slowly in methylene iodide (3.32). Idocrase has a greasy, dull-green color and it is usually fairly translucent — much more so than most nephrite. Idocrase shows a distinct line in the blue portion of the spectrum, at about 4630\AA ; this is often helpful in identifying unpolished material.

Prehnite, which has properties very close to those of nephrite, is an exceedingly pale-green stone that is usually much more transparent than nephrite.

Chrome albite is a bright, light yellowish-green variety, often with black or darker-green markings. It has a lower refractive index than gem serpentine, and, at 6, it is slightly harder. The 2.77 S.G. is higher than that of serpentine. It has been called Maw-sit-sit and jade albite. Chrome albite is more descriptive.

Microcline feldspar (amazonite) has a distinctive appearance; at a glance it may be confused with jadeite or Wyoming nephrite.

Nontransparent Green

Amazonite has a bluish-green color distributed in a pattern that resembles that of coarse loosely woven linen fabric. The color seems to be interrupted by parallel sets of whitish streaks. Its very low specific gravity (2.56) and refractive indices (1.522 and 1.530) distinguish it easily from either type of jade. In addition, it is characterized by a strong two-way cleavage pattern, with one direction almost at right angles to the other. Shiny reflections are seen as a sheen in certain directions.

Glass sometimes is fashioned to make very excellent imitations of jadeite and nephrite. Such imitations are detected by the vitreous luster on tiny fracture surfaces and by the highly dependable presence of gas bubbles when examined under fairly high magnification.

The low specific gravity of plastic easily distinguishes it from jade or other jadelike minerals. They yield easily to a razor blade or pin.

Chlorastrolite, a dark-green semitranslucent mineral is rarely used as a gemstone. It shows a radial fibrous structure in semi-spherical grains. Its color is darker and less vivid than that of malachite, which it resembles somewhat. Chlorastrolite is distinguished by an index 1.65-1.66 and specific gravity near 3.2.

Of the other materials used as jade substitutes, mostly for carvings, few are of particular interest to the gemologist; however, a brief consideration is in order in a discussion of the identification of jade and jadelike materials.

The greenish variety of smithsonite is easily identified by its enormous birefringence (1.62 to 1.81+), which is evident on a spot reading when a Polaroid plate is rotated before the eyepiece of the refractometer. It also has a very high specific gravity (approximately 4.3 to 4.35). Smithsonite is attacked readily by hydrochloric acid, effervescing strongly.

Pseudophite is better known as "Styrian jade," because of its original locality of Styria, Austria. It has properties very closely akin to those of serpentine, with a specific gravity of about 2.7 and a refractive index near 1.57. It is distinguished from serpentine by its even lower hardness (approximately 2); the fingernail will scratch it.

Agalmatolite, or pagoda stone, has a specific gravity of about 2.8 and a hardness of 2.5; it is more a rock than a mineral. It is

HANDBOOK OF GEM IDENTIFICATION

more likely to be confused with soapstone than with any other material, and unlikely to be confused with jade.

Saussurite is really a rock that is a partially altered feldspar changing to zoisite. The zoisite portion has a refractive index of about 1.70-1.71, which is distinctly higher than indices for jadeite or nephrite, but a second index somewhere in the feldspar range is often evident. This might be anywhere from approximately 1.52 to 1.57. Under short-wave ultraviolet light the feldspar portion of the saussurite shows a dark red color which is distinctive. It is used frequently in carvings to imitate jadeite. The specific gravity might vary depending on the relative amounts of feldspar and zoisite in the material. The zoisite has a specific gravity of about 3.4 and the feldspar from 2.6-2.75. Usually, saussurite is closer in specific gravity to the zoisite than to feldspar. The amount of red fluorescence should give some key to the proportion of feldspar in the material. The whiter the jade substitute, the more feldspar present is usually the case.

Fluorite is used fairly frequently as a material for carving by the Chinese; it has a very low refractive index (1.43), a hardness of 4, and the excellent cleavage is usually evident, even in a carved stone.

Steatite, or soapstone, is usually gray or white, but often has a greenish cast. It is used almost exclusively for inexpensive carved objects. Soapstone is characterized by a soapy feel and very low hardness. Although it is a massive variety of talc, the softest mineral on the Mohs scale, impurities often raise its hardness to 2 or 2.5. However, a fingernail usually will scratch it. Any refractive index reading is sure to be vague. It usually appears nearer the high end of the 1.54-1.59 refractive index spread. Specific gravity is near 2.75.

Sillimanite, or fibrolite, in a jadelike form is not commonly employed for either gem or ornamental use. It is a grayish-green in color and shares with jade a fibrous structure. In its compact form this mineral has properties close to those of jadeite. Its refractive indices are just slightly higher (1.659-1.680 to jadeite's 1.654-1.667) and its specific gravity is lower (single crystal is 3.23-3.24, whereas the jadelike type is usually slightly below 3.2; jadeite is near 3.34, although it may barely float in the 3.32 liquid). Fibro-

Nontransparent Green

lite lacks the 4370Å line that characterizes jadeite's absorption spectrum.

Verdite is really a clay with an impregnation of fuchsite, the green chrome mica that also colors aventurine quartz. The refractive index is slightly above that of serpentine, at about 1.58, and its density is approximately 2.8 to 2.9.

There are a number of translucent to opaque green gemstones that are neither jade nor jade substitutes.

Star sapphire is exceedingly rare in a green color. If encountered, its star, and 1.76-1.77 refractive indices, serve to identify it. Green chatoyant chrysoberyl is less rare and often nontransparent. A refractive index reading at about 1.75 and its silky luster are characteristic. Some other green chatoyant stones may be translucent but of the other natural green cat's-eyes, only tourmaline, diopside, and dyed tiger's-eye or quartz cat's-eye, are likely to contain such an abundance of needlelike inclusions that they approach opacity. Indices of 1.624 and 1.644 identify tourmaline, and the 1.54 refractive index plus 2.65 to 2.66 specific gravity in a natural stone identify quartz. Diopside is 1.675-1.701 and has an unusual spectrum. A major find of cat's-eye apatite in a brownish-green color has changed a very rare gem material into a relatively common one. It is fairly transparent, but with a very sharp eye. The refractive indices are 1.642-1.646, the specific gravity 3.18.

Faustite is a gem mineral in the turquoise family in which zinc is responsible for the color instead of copper. The result is a material reminiscent of turquoise, but yellow-green in color. The refractive indices and S.G. are the same as those of turquoise.

Glass or plastics are warm to the touch. Glass cat's-eye imitations contain bubbles in abundance and plastics are both soft and very light to the "heft."

There is a material which is marketed as "metajade" which is a glass that appears to be devitrified because there are many dendritic crystallites visible under magnification. Usually some bubbles are visible in the material. Dark green specimens have a refractive index of approximately 1.50 to 1.51, and a specific gravity near 2.68. (*See illustration.*)

Some turquoise is likely to be bluish-green in color. Often this is formerly blue porous material that was once oiled or waxed, and has since accumulated dirt, soap or skin oils in pore spaces,

HANDBOOK OF GEM IDENTIFICATION

causing discoloration. Dull luster on fracture surfaces, plus a 1.60 or 1.61 refractive index identifies turquoise. Variscite resembles turquoise in appearance, except that it is a light yellow-green to a medium-green color. It is usually accompanied by a variety of other phosphates such as the yellow crandallite, greenish wardite, and colorless gordonite. Indices are 1.56 and 1.59, which serve to distinguish it from turquoise. When compact, the specific gravity is near 2.5, and may be as much as 2.55, but like turquoise, porous material may be significantly below 2.5. The hardness may be nearly 5 in compact material, but below 4 in porous variscite. The usual refractive index is near 1.59.

Malachite is usually banded in an agatelike structure in light and dark green. It may show a radial fibrous structure, with a chatoyant sheen from the lustrous fibers. Malachite has a green streak. It effervesces under hydrochloric acid. The wide birefringence (indices 1.66 and 1.91) is evident if a Polaroid plate is rotated in front of the scale during a spot reading. As the plate is rotated, the shadowed area's maximum extension moves back and forth from 1.66 to the limit of the scale at 1.81. Specific gravity varies from 3.95 to less than 3.30 depending on porosity. Gem material is usually near the former. The only materials with which it might be confused are chlorastrolite, glass and plastic. Chlorastrolite is a blackish-green, totally lacking the vivid green of malachite. Glass and plastic imitations are poor. They are readily detected by their vitreous luster and usually molded appearance.

Black opal with a predominantly green play of color and an opal resembling chrysoprase could be described as nontransparent green gemstones. They are readily identified by opal's low index (1.45) and specific gravity (2.15).

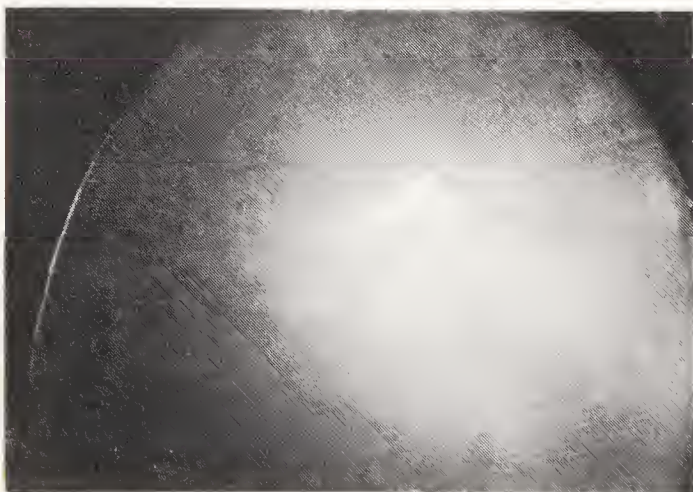

*Characteristic structure
of "metajade."*

Chapter XXVII

The Identification of Nontransparent Red, Orange, Yellow, and Brown Gemstones and Their Substitutes

Nontransparent gemstones and substitutes that occur in this broad range of colors include pyrite, marcasite, synthetic and natural star ruby, synthetic brown and natural black star sapphire, chrysoberyl cat's-eye, pink grossularite garnet, smithsonite, rhodonite, rhodochrosite, coral and its substitutes, amber and its substitutes, the sunstone variety of feldspar, brown tiger's-eye, yellow and brown cat's-eye quartz (both dyed other colors, as well), carnelian, sard, jasper, scapolite, thomsonite, the thulite variety of zoisite, obsidian, opal, glass and plastic. Yellow and orange jadeite may be found in rather intense colors; yellow to orangy-brown is also seen, but truly red jade is unknown.

First Test. The unknown is examined by unaided eye or a low power loupe to note characteristics and to detect any unusual or even unique properties that may be of value in eliminating some of the possibilities. Examine color nuances; luster; the presence of cleavage; luster on fracture surfaces; optical phenomena, such as asterism, chatoyancy and aventurescence; quality of polish; and inclusions. Any of the following observations may be of value:

If a star is visible, the possibilities include corundum, synthetic corundum, corundum doublets, synthetic corundum or quartz foil backs, garnet, or beryl.

Chatoyancy suggests chrysoberyl, quartz, or moonstone.

HANDBOOK OF GEM IDENTIFICATION

A flesh-red color suggests rhodonite, rhodochrosite, coral, conch pearl or shell.

A striped pink-and-white effect in transmitted light suggests coral or conch shell.

An agatelike banding suggests smithsonite, rhodochrosite, or chalcedony.

A light "heft" to the hand suggests plastic, amber or an amber substitute.

Warmth to the touch suggests glass, plastic, opal, amber, or an amber substitute.

A waxy luster on a fracture surface suggests chalcedony quartz.

A light to dark yellow-brown cabochon with a surface sheen suggests golden coral.

Second Test. If the unknown has a flat polished facet, take a normal refractive index reading. In the more likely case that it is cut *en cabochon* and has only curved surfaces, take a spot reading. Be sure that the spot is reduced to no greater than two or three scale divisions in diameter, for greatest accuracy in reading. Although the refractive index by this method is not readable to quite the accuracy of the flat-facet method, it should suffice to reduce the number of possibilities materially. If no index reading is possible, the other properties of these gemstones will prove of value in identifying the stone.

Upon completion of the refractive index determination, either by the usual method or the spot method, the only gemstones in this color grouping that may have an index above the scale are metallic pyrite and marcasite and almandite garnet. Pyrite and marcasite are both listed but, because of marcasite's tendency to decompose, only pyrite is used in "marcasite" jewelry; this terminology dates back at least two centuries. Since neither has a significant value, the use of the term marcasite is to be regarded more as custom than as an effort to misrepresent. In polished form, pyrite seems slightly whiter than the brass-yellow color of its crystals. The specific gravity is near 4.95 (4.85-5.05), the streak is greenish black, and the hardness is about 6.5.

Star garnet is nontransparent; otherwise, it fits the usual description of almandite. As a star stone, it is always cut *en cabochon*; and, since the back is usually rough, it is usually impossible to get a flat-facet refractive index reading. However, with some garnets

Nontransparent Red, Orange, Yellow and Brown

the spot stays dark all the way to the liquid reading, whereas others give a reading close to the upper limit of the scale. The four-rayed star effect suggests garnet, because it is one of the few gemstones that exhibits a star of this kind.

Name	R.I.	S.G.	Hard.	Additional
Pyrite	opaque	5.00	6-6.5	brassy, streak
Marcasite	opaque	4.85	6-6.5	grayish
Almandite	1.79	4.05	7.5	4-ray star
Corundum	1.762-1.770	4.00	9	hexagonal zoning
Syn. corundum	1.762-1.770	4.00	9	bubbles
Chrysoberyl	1.746-1.755	3.73	8.5	silk
Grossularite	1.71	3.4	7	
Rhodonite	1.73-1.74	3.5	5.5-6.5	flesh red
Zoisite (thulite)	1.700-1.706	3.3	6-6.5	
Jadeite	1.66-1.68	3.34	6.5-7	spectrum
Smithsonite	1.62-1.85	4.30	5	acid, effervescence
Rhodochrosite	1.60-1.82	3.72	3.5-4.5	acid, effervescence
Beryl	1.57-1.58	2.70	8	
Golden Coral	1.55-1.59	2.12 (\pm .1)	3	sheen
Serpentine	1.560-1.570	2.2 to 2.4	2.5-4	
Scapolite	1.550-1.572	2.68	5.5-6	
Coral	1.486-1.658	2.65	3.5	striped
Conch pearl	1.486-1.658	2.85	3.5	sheen
Shell	1.486-1.658	2.80	3.5	acid, effervescence
Quartz	1.544-1.553	2.66	7	
Amber	1.54	1.08	2-2.5	
Pressed amber	1.54	1.08	2-2.5	structure
Copal	1.54	1.06	2	
Chalcedony	1.535-1.539	2.60	6.5-7	waxy fracture
Feldspar	1.532-1.542	2.62	6-6.5	cleavage
Thomsonite	1.515-1.540	2.35	5-5.5	radial fibers
Obsidian	1.50	2.45	5-5.5	
Plastic	1.49 to 1.67	<2	<3	
Glass (normal)	1.48 to 1.70	2.3 to 4.5	5	molded?
Opal	1.45	2.15	5-6.5	

Synthetic and natural star rubies, synthetic sapphires and natural black sapphires all give spot readings in the 1.76-1.77 region. Imitation star rubies, made either by engraving lines on the back of transparent synthetic ruby and affixing a mirror or by using a lined metal mirror, appear opaque from the top but are obviously

transparent from the side. Such imitations are easily distinguished from natural or synthetic stars by inspection. Since the introduction of the earliest Linde synthetic stars, which had only a thin layer of rutile needles making them semitransparent to translucent, both Linde and German stars have been nontransparent. The German made "Star of Freyung" is characterized by a bull's-eye effect on the flat base that is missing on most Linde stones; the circles plus a greater transparency serve to identify it as German. In addition, the German stars show the Plato effect in contrast to the Linde stones. Both the Linde and German products show curved striae or color banding and numerous bubbles near the surface. The bubbles are seen best with a strong beam of light directed toward the side of the cabochon and the magnifier directed at a point outside of the direct surface glare of the light. Flat, ground bases such as are seen on both of the synthetics are rarely seen in natural stones, nor are natural stars often so opaque. The star in synthetics is usually much more obvious than in the natural. Synthetic brown Linde stones of early manufacture had a light color that is never seen in natural stones, which are usually black to a very dark brown. However, they are being made more nearly in the natural colors at this time. Natural stars of all colors are usually very readily identified by numerous inclusions that are larger than the minute rutile needles of the synthetics; moreover, hexagonal zoning is usually very apparent, both in color bands and inclusion patterns. Natural black stars are usually flat-topped cabochons, in contrast to the high-domed synthetic stones.

Rhodonite, which occurs in a flesh-red color with black markings, is identified by its 1.74 refractive index. The two stones of roughly comparable color, rhodochrosite and zoisite, have distinctly different refractive indices. Rhodochrosite is a carbonate and shares with most carbonates a tremendous birefringence. It is readily attacked by hydrochloric acid, with the inevitable effervescence. Its low index is approximately 1.60 and the high is just over the scale, at 1.817. Zoisite of the pink thulite variety has indices of 1.70 to 1.71. Rhodochrosite has a specific gravity of 3.6, approximately the same figure as that of rhodonite, whereas zoisite has a value of 3.30.

Nontransparent Red, Orange, Yellow and Brown

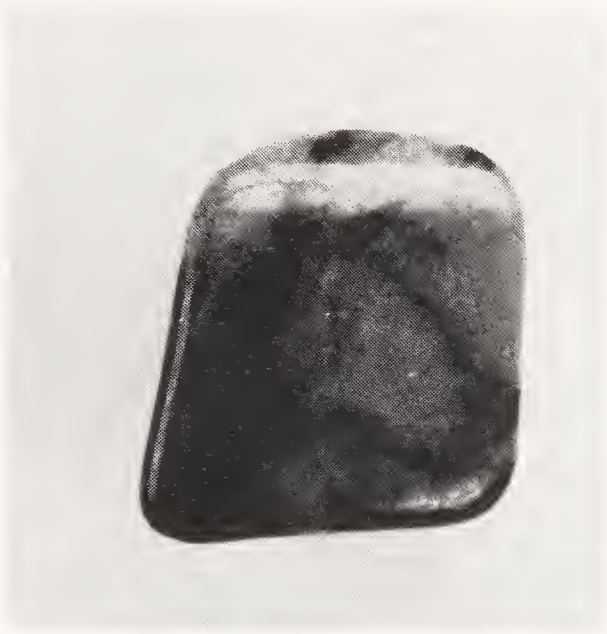

Figure 180

Tumbled rhodonite showing characteristic black inclusions.

Translucent violetish-red grossularite usually transmits much more light than rhodonite — it may be almost semitransparent. It is recognized by its R.I. somewhere between 1.70 and 1.73 and S.G. about 3.25 to 3.5.

Smithsonite either in an agatelike structure in yellow and white or in a solid, vivid yellow is sometimes used as a gem material. Its characteristic identification features are its very high specific gravity, at 4.30, and its effervescence to hydrochloric acid. Its high birefringence should be obvious on the refractometer. If a Polaroid plate is rotated in front of the scale while viewing the spot at a point where a reading is seen.

Jadeite is characterized by its 1.66 refractive index and by the fact that its specific gravity is almost exactly equivalent to the density of the 3.32 liquid. In addition, it has a sharp absorption line at 4370\AA in the spectroscope, which is evident either by transmitted or reflected light except with dark orange and brown stones in which the portion of the spectrum below 5000\AA is absorbed.

Black star beryl is actually a dark brown with a light-brown star. The refractive index is about 1.57-1.58 and its specific gravity is near 2.70. Star beryl is strongly laminated perpendicular to the *c* axis (optic axis). Skeletal crystals of ilmenite lie in these planes and show elongations parallel to the prism faces of hexagonal beryl, giving rise to a weak asterism.

Coral is sometimes identified by its unusual structure. So-called

HANDBOOK OF GEM IDENTIFICATION

Figure 181

Branchlike coral forms. That on the right shows the typical stripes seen under low magnification.



precious coral grows in treelike forms, each branch of which has a radial fibrous structure in cross-section. However, the key characteristic is a striped pattern seen along the length of each branch. This is often very faint and visible only under magnification, using overhead light. This structure is duplicated in no substitute. Coral is one of several gems and substitutes in this color range to effervesce strongly to hydrochloric acid, but it is easily separated from rhodochrosite by refractive index range and from conch pearl by specific gravity. Dyed calcite, which also effervesces, may be similar in color, but it is usually mottled and appears coarser. It lacks coral's structure and translucency. Occasionally, coral is partially coated with a coral-colored gluelike material to cover white spots. This is visible under magnification. It chips off readily.

The refractive index of golden coral seems to vary from about 1.55-1.57 with the lighter golden material near that lower figure and the dark yellow-brown material near the higher. Its specific gravity is approximately 2.12 ($\pm .10$).

Perhaps the closest resemblance to coral is seen in conch pearl. In certain directions, it exhibits shiny reflections reminiscent of the sheen of amazonite, but in a pattern resembling sheets of flame. No such effect is seen in coral. Conch pearl has a specific gravity of 2.85, in contrast to the usual 2.65 of coral. Conch shell is sometimes cut as a coral substitute; its structure is obvious in a layered pink-and-white pattern. The layers corresponding to the growth of the shell are not likely to be confused with the stripes on coral.

Wood is sometimes dyed a coral color. Its low density identifies it. Glass imitations of coral contain gas bubbles, have a vitreous fracture surface, and are inert to hydrochloric acid. Plastic is easily recognized by its light "heft."

Scapolite with a purplish red color in a translucency similar

Nontransparent Red, Orange, Yellow and Brown

to that of average jadeite is sometimes used in jewelry. The 1.55-1.57 refractive indices and .02 birefringence at this point on the scale serve to identify it.

Greenish-yellow serpentine is used for carvings and occasionally in jewelry. In this color, the refractive index is usually 1.54 or 1.55, rather than the usual 1.56. In the spectroscope, a fairly strong absorption band is seen in the blue from about 4600 to 4700Å. A knife blade scratches it easily.

Thomsonite is unique in appearance among gems in this color range, because of its radial fibrous structure and light red, orange, and sometimes green circles at various distances outward from the center of each spherule. The refractive index is usually near 1.52 and specific gravity is 2.3 to 2.4.

Quartz and chalcedony occur in nontransparent forms in all four of the colors discussed in this section. In the crystalline-quartz type, cat's-eye is found in a natural yellow to brownish-yellow color. Tiger's-eye occurs in reddish and yellowish-brown colors. Aventurine is less common in these colors, but all three varieties are dyed various colors. Although most quartz cat's-eye is coarse, some specimens are all but indistinguishable to the eye from fine chrysoberyl. Crystalline cat's-eye or tiger's-eye quartz is certain to have the constant refractive indices of this mineral (1.544 and 1.553), whereas chrysoberyl is approximately 1.746 and 1.755. Chalcedony, in the carnelian, agate, sard, petrified wood, or other forms, is approximately 1.535 to 1.539.

Amber, another nontransparent yellow or brown stone, was described in detail in both the yellow and orange-to-brown sections of transparent stones; therefore, its identification will not be discussed further at this point. One variety not mentioned earlier, however, is the semiopaque type that resembles wood but has layers or sections of transparent amber; it is identified by its strong resinous odor when touched with the hot point. Plastics and other amber substitutes, such as the recent resins, copal, kauri gum and pressed amber, were also discussed under transparent gemstones.

The sunstone variety of feldspar is a semitransparent to semi-translucent stone that usually occurs in a colorless to white ground-mass with minute inclusions of reddish flakes of hematite. In fine

Figure 182
Copper tetrahedra and modified tetrahedra in "goldstone".

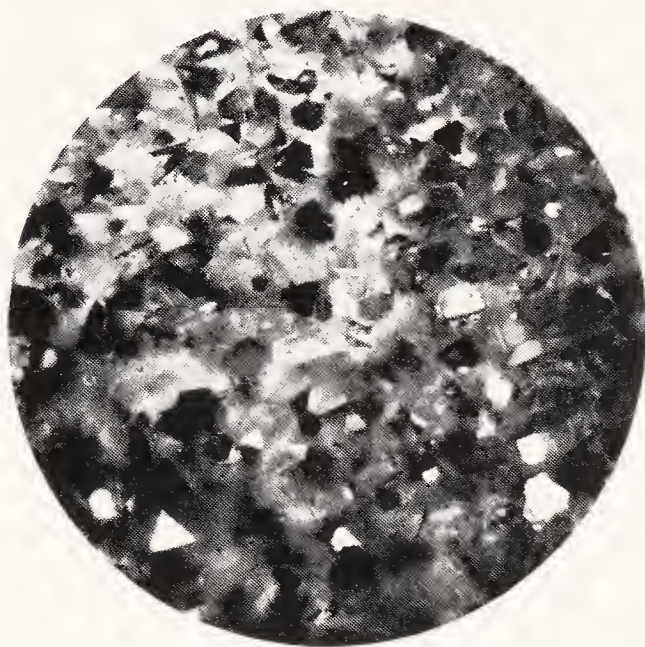

quality, it has a moonstonelike appearance, but with a reddish-yellow rather than a bluish floating light. Commonly, it appears orangy-brown with golden reflections. It has a refractive index corresponding to either albite, of the plagioclase feldspars (1.532 to 1.54 or 1.542), or to orthoclase (1.518 to 1.526).

Obsidian in both a dull-red color and in the so-called golden sheen type is seen in this color range. The latter is nearly black, but reflections from numerous inclusions impart a golden sheen. Both types are readily identified by the 1.50 refractive index, 2.45 specific gravity, warmth to the touch, and vitreous luster on fracture surfaces.

Nontransparent opal in this color range is seldom used for jewelry; however, black opal with one of these colors predominating in the play of color is cut *en cabochon* for jewelry use. Its 1.45 refractive index and 2.15 specific gravity are characteristic. The latter figure is too low for glass and too high for plastic.

The "goldstone" type of glass imitation is usually a brownish-red color. It has a multitude of tiny metallic copper tetrahedra that act as reflectors for a spectacular display of aventurescence. Gas bubbles and copper tetrahedra identify this imitation. It has a refractive index near 1.55 and specific gravity near 2.65, so just these findings could lead a novice to an aventurine quartz determination. In addition, the luster on fractures is more accurately described as greasy than as vitreous.

Chapter XXVIII

The Identification of Nontransparent White, Gray, and Black Gemstones and Their Substitutes

The white, gray and black nontransparent gem materials include hematite and its substitutes (metallic); pearl (black, gray and white); cultured pearls (black, gray and white); imitation pearls; black diamond (both natural and treated); the rare melanite variety of andradite garnet (black); star sapphires (black, white and gray); synthetic star sapphire (black and white); the rare black star spinel; white grossularite garnet; jadeite (white, gray and black); jet (black); tourmaline (black); nephrite (white, "mutton fat" and black); star beryl (black); coral (black and white); moonstone and its imitations; labradorite; metallic psilomelane in chalcedony; chalcedony (black, white and gray); alabaster; the onyx marble variety of calcite; both natural and artificial glass; and plastic. Black diopside four-rayed stars and gray star and cat's-eye moonstones are now well known. White quartz may show a six-rayed star.

First Test. The nontransparent unknown is examined by unaided eye or a low power loupe, to detect any unique or unusual identifying characteristics or to eliminate many of the possibilities. Examine luster, nature of cleavage or fracture; luster on the breaks; optical phenomena, such as chatoyancy or asterism; quality of polish; and any other features. Any of the following characteristics may be of use in reducing the number of possibilities:

HANDBOOK OF GEM IDENTIFICATION

- A blue sheen in reflected light* suggests precious moonstone (orthoclase feldspar).
- A play of color* suggests opal. Since opal doublets are common, check every opal for that possibility by an examination of the girdle and back.
- A blue or green iridescence in a gray gemstone* suggests labradorite feldspar.
- A six-rayed star* suggests star sapphire, synthetic star sapphire or quartz.
- A four-rayed star* suggest diopside, spinel or moonstone.
- Warmth to the touch* (compared to the cold feel of crystalline materials) suggests a plastic, glass, or opal.
- A metallic luster* suggests hematite, or one of its substitutes.
- A molded surface appearance* suggests glass or a plastic.
- A vitreous luster on a fracture surface* suggests glass.
- A waxy luster on a fracture surface* suggests chalcedony quartz.
- Crescents of white in a black stone* suggests black coral.
- Agatelike banding of material with alternate metallic and vitreous layers* suggests psilomelane quartz.

Second Test. If the unknown has a flat polished facet, take a normal refractive index reading. In the more likely case that it is cut *en cabochon* and has only curved surfaces, take a spot reading. Be sure that the spot is reduced to no greater than two or three divisions in diameter, for greater accuracy in reading. Although the refractive index taken by this method is not readable to quite the accuracy of the flat-facet method, it should reduce the number of possibilities materially. If no index reading is possible, the other properties of these gemstones will suffice to identify the stone.

It is hard to imagine that a gemstone with such a relatively low value as that of hematite would need to have substitutes. However, there have been many substitutes for this mineral, the best known of which was sold for a number of years under the trade name of Hemetine. The apparent purpose was to avoid the cost of carving by stamping or molding the figures. The similarity of the name to hematite resulted in the ultimate abolition of the term by legal action. Hematite and its substitutes are distinguished from other

Nontransparent White, Gray, and Black

Name	R.I.	S.G.	Hard.	Additional
Hematite	opaque	5.20	5.5-6.5	red-brown streak, fracture
Hemetine	opaque	4.0-7.0	2.5-6	stamped impression
Diamond	2.417	3.52	10	girdle, cleavage
Andradite	1.885	3.84	6.5-7	black
Corundum	1.762-1.770	4.0	9	black star
Syn. corundum	1.762-1.770	4.0	9	white star
Grossularite	1.735	3.61	7	white
Syn. spinel	1.728	3.64	8	moonstone imitation
Spinel	1.718	3.55	8	black star
Diopside	1.675-1.701	3.29	5-6	4-ray star
Jadeite	1.66-1.68	3.34	6.5-7	
Jet	1.66	1.32	2.5-4	black
Tourmaline	1.624-1.644	3.20	7-7.5	black
Nephrite	1.606-1.632	2.95	6-6.5	
Coral (black)	1.56-1.57	1.37	3	white crescents
Beryl	1.57-1.58	2.70	8	black star
Labradorite	1.559-1.568	2.7	6-6.5	labradorescence
Quartz	1.544-1.553	2.66	7	
Chalcedony	1.535-1.539	2.60	6.5-7	
Psilomelane	1.535-1.539	3.0	6.5-7	banded, metallic luster
Alabaster	1.52-1.53	2.3	2	
Orthoclase	1.518-1.526	2.56	6-6.5	moonstone
Imitation pearl	1.51 ±			magnification
Pearl	1.50-1.65	2.70	2.5-4	acid, effervescence
Cultured pearl	1.50-1.65	2.75	2.5-4	acid, effervescence
Mother-of-pearl	1.50-1.65	2.75	2.5-4	acid, effervescence
Coral (white).....	1.486-1.658	2.65	3.5	acid, effervescence
Calcite	1.486-1.658	2.70	3	acid, effervescence
Obsidian	1.50	2.45	5-5.5	
Plastic	1.49 to 1.67	< 2	< 3	
Glass (normal)	1.48 to 1.70	2.3 to 4.5	5	molded?
Opal	1.450	2.15	5-6.5	play of color

opaque materials by their metallic luster. Hematite has a refractive index of approximately 3.0, a specific gravity of 5.08 to 5.2, a splintery fracture, a reddish-brown streak, and a hardness of 5.5 to 6.5. The various substances used as Hemetine ranged in hardness



Figure 183a
A carved intaglio in hematite.
Note the grooved
appearance.



Figure 183b
A stamped impression in a
substitute. Note the smooth
texture of the surface.

from about 2.5 to 6 and in specific gravity from about 4.0 to 7.0. In its early days, powdered galena (PbS) was used as the principle ingredient; at that time the specific gravity was approximately 7.0, the hardness about 2.5, and the streak black. Later, apparently, a sintered iron oxide was used; it closely duplicated the properties of hematite, except that it lacked the splintery fracture. The streak for this type is a slightly darker brown than that of hematite.

Nontransparent White, Gray, and Black

Other substitutes, such as steel and monel metal, both have metallic streaks, in contrast to hematite's reddish-brown streak. The sintered product is usually picked up by a magnet, in contrast to hematite. A simple means of detection is to examine the figure under magnification with overhead light. The grooved nature of carving contrasts sharply with the surface of a stamped or molded impression.

Black diamond, as in other colors, is distinguished by the sharpness of facet edges, the unique lathe-turned girdle surface, and often by naturals. Cleavage is often evident. Usually when a thin section is examined, the color passing through the thin portion is usually grayish. Diamond colored black by intense radiation in a cyclotron or a nuclear reactor is virtually indistinguishable from the natural; however, thin sections are usually greenish. The only clue is that it is a dense impenetrable black whereas the natural usually shows clear areas of variation in blackness. It is possible to be sure of its artificial coloring only when light can be passed through a thin edge and the 5920 Å line becomes visible in the spectroscope.

The black form of andradite garnet is very rarely used as a gemstone. Its 3.84 specific gravity, as opposed to diamond's 3.52, and its somewhat lower luster distinguish it from diamond.

Natural star sapphire may be white, gray or black (although dark brown is more common). The only synthetic star in this color range is a nearly opaque white one with an exceedingly strong star. Linde is attempting to produce a black, but efforts to date have only resulted in brown ones. The growth lines in the natural stone are usually strongly evident so there is rarely any difficulty separating it from the synthetic. A nearly opaque nonasteriated white to gray material that has typical property values for corundum suggests that sintered synthetic corundum is now being made and that it may reach the gem market at any time. It has a refractive index near 1.77, a specific gravity just slightly lower than the 4.0 range of natural corundum, a dull fracture luster, and a granular appearance similar to porcelain.

Black star spinel is found on rare occasions. If the material were cut into a sphere, both four- and six-rayed stars would be seen,

because the inclusions parallel octahedral face edges. Its index is a typical 1.715, but the specific gravity is lower than transparent spinel at 3.55. Black synthetic spinel triplets are made occasionally from colorless material, using a black cement. Immersion detects them.

Grossularite garnet in a white color is distinguished by its 1.725 refractive index, the only stone in that index vicinity in this color range.



Figure 184
Star diopside. Note difference in width
of rays.

For several years, diopside, one of the pyroxene group of minerals has been fashioned into four-rayed black stars. One combination of two rays is usually considerably broader than the other. The almost opaque material is not likely to be confused with any other gemstone, because there is no other black star in its property range. (See illustration.) It is characterized by metallic inclusions.

White jadeite is relatively common, particularly with spots of green; in a black color, it is much more rare. White jadeite shows the 4370 Å line in the spectroscope, and, whether white or black,

Nontransparent White, Gray, and Black

its specific gravity (near 3.32) is characteristic. The only other black gemstone with a comparable refractive index is jet (1.66), and it is easily distinguished from jadeite by its very low specific gravity (1.35). A black plastic could imitate jet effectively, but the acrid plastic odor emitted when touched by a hot point would detect it. Jet has a coallike odor.

Nephrite jade occurs both in white to off-white (so-called mutton fat) and black form. The only materials in its refractive index range are tourmaline, glass and plastic. Schorl, the black variety of tourmaline, has a full .03 birefringence, in contrast to a single vague reading for nephrite (near 1.61). Nephrite is usually less than 3.0 in specific gravity, compared to 3.2 for schorl. Black nephrite takes a high polish, and its high luster and extreme toughness make it perhaps the best of the opaque black stones for gem use. Black tourmaline is more brittle, so it is seldom used. Black nephrite lacks any serious drawback but black onyx is far better known, perhaps because it is both harder and more common.

Dark-brown to nearly black star beryl is seen rarely. It has a poorly developed yellow-brown star reminiscent of black star sapphire. The low refractive index and specific gravity identify it readily. Star beryl is strongly laminated in appearance perpendicular to the optic axis.

White coral at times is a popular gem material, particularly for inexpensive summer jewelry. Its properties are comparable to those of the pink variety — approximately those of calcite: refractive indices of 1.486 and 1.658; specific gravity, about 2.65; and a typical coral structure. Conch shell, used to imitate white coral, has the usual shell-layered structure.

Black coral differs materially, in that the material secreted by the tiny animal colonies is not calcium carbonate but a horny material; as a result, it does not effervesce under a drop of hydrochloric acid. It has indices of 1.56 and 1.57 (birefringence .01) and its specific gravity is 1.37. It is characterized by white crescents in the cross sections of the branchlike forms.

White or black calcite in the form of limestone, marble or onyx marble is often used for carvings and other ornamental objects.



Figure 185
Typical inclusions in
moonstone.

Alabaster, too, has similar uses. Calcite is identified by its strong effervescence to hydrochloric acid and its strong birefringence by the spot method (refractive indices, 1.486 and 1.658). Alabaster is notable for its low hardness of 2- and its low index (1.52-1.53).

Quartz in a milky form is quite common, having the usual 1.544 and 1.553 refractive indices to set it apart. It resembles moonstone, but without the “floating” light effect. Chalcedony quartz occurs in white, gray and black colors. Most so-called “black onyx” is actually gray agate that has been dyed black. Gray agate is seldom used except to be dyed various colors. The 1.535 to 1.539 refractive index, plus a specific gravity near 2.60, are characteristic. A gem material popular in tumbled stone jewelry and in cabochons is that frequently sold as psilomelane. It is actually mainly chalcedony, with alternate thin agatelike layers of psilomelane, a manganese mineral with a metallic luster. Refractive indices are those for chalcedony but the specific gravity is usually near 3.0 to 3.1. Fire agate usually has a brown body color and a strong iridescence from hematite or goethite coatings on mammillary chalcedony formations that have been covered by more chalcedony.

Orthoclase moonstone is also a relatively common gem material. No other natural stone has a comparable adularescence, although

Nontransparent White, Gray, and Black

there are imitations with similar effects. Synthetic white spinel is an excellent imitation of moonstone, as are some plastics and glass. Refractive index or heft to the hand is sufficient to distinguish synthetic spinel from moonstone. The very low specific gravity and molded nature of plastic gives its identity away. The polariscope proves both synthetic spinel and plastic to be singly refractive, in contrast to moonstone. Some moonstone has properties corresponding to those of albite of the plagioclase group of feldspars. This means indices up to almost 1.54 and specific gravities to about 2.6. Labradorite, a gray feldspar with a broad color effect caused by light interference, is occasionally used for carvings and cabochons. It is identified by the strong parallel banding caused by repeated twinning, the numerous black rodlike inclusions that cause the gray color, evidence of cleavage, and its 1.559 and 1.568 indices.

Black obsidian is a plentiful substance, but it is not an important gem material. The type of dark-brown or black obsidian with inclusions that give rise to shiny reflections is often called golden-sheen obsidian; it is used for carvings and cabochons. Its single refraction and refractive index of about 1.50 identify it. "Snowflake" obsidian is black with white areas of the cristobolite form of quartz.

White and black opal are perhaps the most important gemstones in the white, gray and black nontransparent category. Black opal with a vivid play of color in red, violet, yellow and other hues is particularly prized. About the only imitation of either stone is the opal doublet. Glass with inclusions or backing of metal foil to create an iridescent effect is easily recognized as such by eye. The opal doublet is easily detected by careful inspection of the girdle area. However, if the stone is mounted, a bezel observed under magnification may show a chip in one layer, or a separation in the joining area of the two layers. Opal triplets are easily detected from the side by the transparency of the quartz cap. Treated opals are detected by the oddly fragmented patches of color and the tiny black spots seen under magnification. Today the greatest concern in testing is synthetic opal, either white or black. The appearance of synthetic opals under magnification is unlike that encountered in natural opals. The Gilson synthetic opal usually shows a "mar-



Figure 186
An opal-quartz triplet.

celled” or “wavy” structure to transmitted light under medium magnification, and often a tiny mosaic structure is evident in reflected light. (See Chapter X.) A treated black opal known as “smoked” opal is an opal with very low properties to which the tongue tends to adhere. It is described in Chapter XVI.

The identification of pearls, cultured pearls and imitations is discussed in Chapter XII. Methods for distinguishing between dyed and naturally colored black pearls are included in that chapter.

Mother-of-pearl is recognized by the fact that the pearly luster is confined to two opposite areas on any polished piece; polish marks are visible in the areas not having the pearly luster. Some white to rosé mother-of-pearl is dyed black, giving it a superficial resemblance to cat’s-eye or black star sapphire. The refractive indices of mother-of-pearl are in the aragonite range (1.53 and 1.685), and the material effervesces strongly under a drop of hydrochloric acid. Both natural and cultured pearls give spot readings showing strong birefringence when a Polaroid plate is rotated before the eyepiece; the high and low limits seem to correspond closely to the expected results for aragonite. Imitations show no birefringence. The relatively thick transparent overcoat on imitations is seen easily under magnification and it often reveals bubbles. The imitation usually is smooth to the cutting edge of the tooth, and often peeling is in evidence at the drill hole. Often, glassy fractures may be seen at the drill holes.

Appendix

HANDBOOK OF GEM IDENTIFICATION

COLOR TABLE

Purple and Violet Gemstones and Their Substitutes

Transparent

Almandite garnet	Spinel
Beryl (morganite)	Spodumene (kunzite)
Chrysoberyl (alexandrite)	Synthetic alexandrite
Corundum (sapphire)	Synthetic corundum
Diamond	Synthetic quartz
Glass	Synthetic spinel
Plastics	Topaz
Pyrope garnet	Tourmaline
Quartz (amethyst)	Zircon
Rhodolite garnet	Zoisite
	Doublets

Gems infrequently encountered in the jewelry trade:

Andalusite	Iolite
Apatite	Scapolite
Axinite	Taaffeite
Fluorite	

Nontransparent

Almandite garnet	Quartz (chalcedonic)
Corundum (star sapphire)	Stichtite
Jadeite	Thomsonite

Blue Gemstones and Their Substitutes

Transparent

Beryl (aquamarine)	Synthetic quartz
Corundum (sapphire)	Synthetic rutile
Diamond	Synthetic spinel
Glass	Topaz
Iolite	Tourmaline
Plastics	YAG
Quartz (dyed)	Zircon
Chalcedony (dyed and natural)	Zoisite
Opal	Doublets
Spinel	Triplets
Synthetic corundum	Foil backs

Gems infrequently encountered in the jewelry trade:

Apatite	Kyanite
Benitoite	Lazulite
Euclase	Sillimanite
Fluorite	Sodalite

Nontransparent

Azurite	Opal (black opal)
Chalcedony (chrysocolla and dyed chalcedony)	Plastics
Corundum (star sapphire)	Quartz (cat's-eye quartz)
Glass	Sintered synthetic spinel
Jadeite	Synthetic corundum
Labradorite feldspar	Synthetic turquoise
Lazurite (lapis lazuli)	Turquoise
	Doublets
	Foil backs

Property Tables

Gems infrequently encountered in the jewelry trade:

Diopside	Odontolite
Dumortierite	Smithsonite
Lazulite	Sodalite

Green Gemstones and Their Substitutes

Transparent

Andradite garnet (demantoid)	Quartz
Beryl (emerald)	Spinel
Chrysoberyl (including cat's-eye and alexandrite)	Synthetic corundum
Corundum (green sapphire)	Synthetic garnet (YAG)
Diamond	Synthetic emerald
Glass	Synthetic quartz
Grossularite garnet	Synthetic rutile
Peridot	Synthetic spinel
Plastics	Topaz
Chalcedony (chrysoprase)	Tourmaline
	Zircon
	Doublets
	Triplets

Gems infrequently encountered in the jewelry trade:

Andalusite	Gahnite
Apatite	Gahnospinel
Brazilianite	Jadeite
Datolite	Kornerupine
Diopside	Kyanite
Diopase	Moldavite
Ekanite	Obsidian
Enstatite	Sphalerite
Epidote	Sphene
Euclase	Spodumene
Fluorite	Willemite

Nontransparent

Agalmatolite	Nephrite jade
Beryl	Opal (black opal)
Calcite (dyed onyx marble)	Prehnite
Chalcedony (chrysoprase, bloodstone and dyed chalcedony)	Pseudophite
Chlorastrolite	Quartz (aventurine)
Chrysoberyl (cat's-eye)	Saussurite
Corundum	Serpentine
Faustite	Sillimanite
Glass	Smithsonite
Grossularite garnet	Steatite
Idocrase	Synthetic emerald
Jadeite jade	Tourmaline
Labradorite feldspar	Turquoise
Malachite	Variscite
Microcline feldspar (amazonite)	Verdite

HANDBOOK OF GEM IDENTIFICATION

Yellow Gemstones and Their Substitutes
Transparent

Amber	Spessartite garnet
Beryl	Spodumene
Chrysoberyl	Synthetic corundum
Corundum	Synthetic rutile
Diamond	Synthetic spinel
Glass	Topaz
Grossularite garnet (hessonite)	Tourmaline
Opal	Zircon
Peridot	Doublets
Plastics	Triplets
Quartz (citrine)	Foil backs

Gems infrequently encountered in the jewelry trade:

Apatite	Labradorite feldspar
Axinite	Orthoclase feldspar
Beryllonite	Phenakite
Brazilianite	Scapolite
Cassiterite	Smithsonite
Copal	Sphene
Danburite	Spinel
Fluorite	Stibiotantalite

Nontransparent

Amber	
Chalcedony	Jadeite jade
Chrysoberyl	Plastics
Coral (golden)	Smithsonite

Brown and Orange Gemstones and Their Substitutes
Transparent

Amber and pressed amber	Quartz
Beryl	Chalcedony
Chrysoberyl	Sinhalite
Copal (and other natural resins)	Spinel
Corundum	Synthetic corundum
Diamond	Synthetic rutile
Doublets	Synthetic spinel
Glass	Topaz
Grossularite garnet (hessonite)	Tourmaline
Opal (fire opal)	Triplets
Plastics	Zircon

Gems infrequently encountered in the jewelry trade:

Anatase	Obsidian
Andalusite	Peridot
Axinite	Scheelite
Cassiterite	Spessartite garnet
Copal	Sphalerite
Enstatite	Sphene
Idocrase	Staurolite
Kornerupine	Willemite

Property Tables

Nontransparent

Amber	Plastics
Chalcedony	Quartz (tiger's-eye)
Chrysoberyl (cat's-eye)	Smithsonite
Coral (golden)	Feldspar (sunstone)
Jadeite jade	Synthetic corundum
Opal	

Red and Pink Gemstones and Their Substitutes

Transparent

Almandite garnet	Rhodolite garnet
Beryl (morganite)	Spinel
Chrysoberyl (alexandrite)	Spodumene (kunzite)
Corundum (ruby and pink sapphire)	Synthetic corundum
Diamond	Synthetic rutile
Glass	Synthetic spinel
Opal (fire opal)	Topaz
Plastics	Tourmaline
Pyrope garnet	Zircon
Quartz (rose quartz)	Doublets
Chalcedony (carnelian and sard)	Triplets
	Foil backs

Gems infrequently encountered in the jewelry trade:

Amber	Phenakite
Andalusite	Pollucite
Apatite	Rhodochrosite
Apophyllite	Rutile
Cassiterite	Scapolite
Danburite	Spessartite
Epidote	Sphalerite
Fluorite	Zincite
Painite	

Nontransparent

Almandite garnet (star garnet)	Plastics
Chalcedony (sard, sardonyx, and carnelian)	Quartz (cat's-eye quartz)
Conch pearl	Rhodochrosite
Coral	Rhodonite
Corundum (star ruby)	Scapolite
Glass	Stichtite
Grossularite	Synthetic corundum
Jadeite	Thomsonite
	Zoisite (thulite)
	Foil backs

HANDBOOK OF GEM IDENTIFICATION

Colorless Gemstones and Their Substitutes Transparent

Beryl	Spinel
Corundum (white sapphire)	Strontium titanate
Diamond	Synthetic corundum
GGG	Synthetic rutile
Glass	Synthetic spinel
Grossularite garnet	Topaz
Opal	Tourmaline
Feldspar (moonstone)	YAG
Plastics	Zircon (jargoon)
Quartz (rock crystal)	

Gems and their substitutes infrequently encountered in the jewelry trade:

Amblygonite	Labradorite
Apatite	Leucite
Augelite	Linobate
Benitoite	Petalite
Beryllonite	Phenakite
Brazilianite	Pollucite
Danburite	Rhodizite
Euclase	Scapolite
Fluorite	Scheelite
Hambergite	Spodumene
Jadeite	Doublets
KTN	

White Gemstones and Their Substitutes Nontransparent

Alabaster	Nephrite jade
Chalcedony (chalcedony moonstone)	Onyx marble
Coral	Opal
Corundum	Opal doublets
Glass	Feldspar (moonstone)
Grossularite	Plastics
Jadeite jade	Synthetic corundum
	Synthetic opal
	Synthetic spinel

Black Gemstones and Their Substitutes Nontransparent

Andradite garnet (melanite)	Jadeite jade
Black coral	Jet
Chalcedony (black onyx)	Nephrite jade
Corundum (star sapphire)	Obsidian
Diopside (star)	Opal
Diamond	Opal doublets
Glass	Plastics
Hematite	Psilomelane
Hemetine	Synthetic opal
	Tourmaline

Property Tables

Gray Gemstones and Their Substitutes

Nontransparent

Chalcedony (agate)	Jadeite jade
Corundum (star sapphire)	Labradorite feldspar
Hematite	Nephrite jade
Hemetine	Sintered synthetic corundum

TABLE OF PERFECT AND DISTINCT CLEAVAGE AND PARTING

One Direction

EUCLASE	Perfect	SILLIMANITE	Perfect
EPIDOTE	Perfect	TOPAZ	Perfect
IOLITE	Distinct		

Two Directions

BERYLLONITE	One perfect, one nearly perfect—90° between directions.
BRAZILIANITE	Perfect.
DIOPSIDE	Perfect—92½° between directions.
ENSTATITE	Perfect—88° between directions.
FELDSPAR	One perfect, one nearly so — 90° to 86° between directions. (Orthoclase, microcline, albite-oligoclase, labradorite.)
JADEITE	Perfect—93° between directions, but usually concealed by fine aggregate structure.
KORNERUPINE	Perfect.
KYANITE	One perfect, one less so—74° between directions.
NEPHRITE	Perfect—56° and 124° between directions, but concealed by aggregate structure.
RHODONITE	Perfect—92½° between directions—tough when massive.
SCAPOLITE	Perfect—90° between directions.
SPHENE	Distinct—66½° between directions.
SPODUMENE	Perfect—93° between directions—one direction of easy parting sometimes prominent.

Three Directions

CALCITE	Perfect, rhombohedral — concealed in onyx marble by fine grain.
DIOPTASE	Perfect, rhombohedral.
SMITHSONITE	Perfect, rhombohedral — concealed by fine grain.

Four Directions

CORUNDUM	Distinct parting
DIAMOND	Perfect, octahedral
FLUORITE	Perfect, octahedral

Six Directions

SODALITE	Fairly distinct
SPHALERITE	Perfect, dodecahedral

PLEOCHROISM TABLE

The symbols S, D, W, and VW signify strong, distinct, weak, and very weak pleochroism. Only two colors are given for biaxial gemstones when little color difference is detectable between two of the three directions. Colors may vary from those described, depending on hue and depth of color.

Purple or violet gemstones

Corundum (sapphire) (S)	Violet and orange
Tourmaline (S)	Purple and light purple
Quartz (amethyst) (W-D)	Purple and reddish-purple
Andalusite (S)	Brownish-green and dark red to purple
Spodumene (kunzite) (S)	Violet to purple and colorless to pink
Beryl (D-S)	Violet and colorless
Chrysoberyl (alexandrite) (S)....	Dark red-purple, orange, and dark green (trichroic)
Topaz (D-S)	Light to very light purple

Blue gemstones

Beryl (W-D)	Light blue and darker blue
Corundum (S)	Dark violetish-blue and light greenish-blue
Topaz (W-D)	Colorless and light blue
Tourmaline (S)	Dark blue and light blue
Zircon (S)	Medium blue and colorless to gray
Apatite (S)	Blue and yellow
Benitoite (S)	Colorless and dark blue
Iolite (S)	Colorless to yellow, blue, and dark blue-violet (trichroic)
Zoisite (S)	Blue, violetish red and greenish yellow

Green gemstones

Beryl (emerald) (S)	Green and blue-green
Corundum (sapphire) (S)	Green and yellow-green
Tourmaline (S)	Blue-green to dark brownish-green and yellow-green
Zircon (W)	Brownish-green and green
Topaz (D)	Blue-green and light green
Sphene (D)	Brownish-green and blue-green
Andalusite (S)	Brownish-green and dark red
Chrysoberyl (alexandrite) (S)	Dark red, orange, and green (trichroic)
Peridot (W)	Yellow-green and green

Yellow gemstones

Beryl (W)	Light greenish-yellow and light blue-green
Chrysoberyl (D)	Colorless, very light yellow, and greenish-yellow (trichroic)
Corundum (W)	Yellow and light yellow
Danburite (W)	Very light yellow and light yellow

Property Tables

Phenakite (D)	Colorless and orange-yellow
Quartz (citrine) (VW)	Light yellow and very light yellow
Spodumene (D)	Light yellow and very light yellow
Topaz (D)	Brownish-yellow, yellow, and orange-yellow (trichroic)
Tourmaline (D)	Light yellow and dark yellow
Zircon (W)	Yellow-brown and yellow

Brown and orange gemstones

Axinite (S)	Violet, yellow-brown, and green (trichroic)
Corundum (S)	Yellow-brown to orange and colorless
Quartz (W)	Brown and reddish-brown
Topaz (D)	Yellow-brown and brown
Tourmaline (S)	Yellowish-brown—dark greenish-brown
Zircon (W-D)	Brownish-yellow and purplish-brown

Pink and red gemstones

Andalusite (S)	Dark red and brownish-green
Beryl (morganite) (D)	Light red and red-violet
Chrysoberyl (alexandrite) (S)	Dark red, orange, and green (trichroic)
Corundum (ruby) (S)	Violetish-red and orangy-red
Quartz (rose quartz) (S)	Brownish red to light pink
Synthetic corundum (S)	Violetish-red and orangy-red
Spodumene (kunzite) (S)	Light red to purple and colorless
Topaz (D to S)	Light red and yellow
Tourmaline (S)	Dark red and light red
Zircon (D)	Reddish-purple and reddish-brown

Refractive Index Table

Rutile & Syn.	2.616		2.903
Anatase	2.493		2.554
Diamond		2.417	
Strontium titanate		2.409	
Stibiotantalite	2.37		2.45
Sphalerite		2.37	
Syn. Cubic Zirconia		2.17(±.03)	
GGG		2.02	
Zincite	2.013		2.029
Cassiterite	1.997		2.093
Zircon (high)	1.925		1.984
Scheelite	1.918		1.934
Sphene	1.900(±.018)		2.034(±.020)
Zircon (medium)	1.875(±.045)		1.905(±.075)
Andradite garnet		1.875(±.020)	
YAG		1.833	
Zircon (low)	1.810(±.030)		1.815(±.030)
Spessartite garnet		1.81(±.010)	
Gahnite		1.80	
Almandite garnet		1.79(±.030)	
Painite	1.787		1.816
Corundum	1.762(−.003, +.007)		1.770(−.003, +.008)
Synthetic corundum	1.762		1.770
Rhodolite garnet		1.76(±.010)	
Gahnospinel		1.76(±.02)	
Benitoite	1.757		1.804
Pyrope garnet		1.746(−.026, +.010)	
Chrysoberyl	1.746(±.004)		1.755(±.005)
Synthetic alexandrite	1.742(±.004)		1.751(±.005)
Staurolite	1.736		1.746
Grossularite garnet		1.735(+.015, −.035)	
Azurite	1.73(±.010)		1.84(±.010)
Synthetic Spinel		1.73(±.01)	
Rhodonite	1.73		1.74
Epidote	1.729(−.015, +.006)		1.768(−.035, +.012)
Taaffeite	1.719		1.723
Spinel		1.718(−.006, +.044)	
Kyanite	1.716(±.004)		1.731(±.004)
Idocrase	1.713(±.012)		1.718(±.014)
Zoisite	1.691(±.002)		1.704(±.003)
Willemite	1.69		1.72
Rhodizite		1.69	
Dumortierite	1.678		1.689
Axinite	1.678		1.688
Diopside	1.675(−.010, +.027)		1.701(−.007, +.029)
Sinhalite	1.668(±.003)		1.707(±.003)
Kornerupine	1.667(±.002)		1.680(±.003)
Jadeite	1.66(±.007)		1.68(±.009)
Malachite	1.66		1.91
Spodumene	1.660(±.005)		1.676(±.005)
Jet		1.66(±.020)	
Sillimanite	1.659		1.68
Chlorastrolite	1.65		1.66
Enstatite	1.658(±.005)		1.668(±.005)
Dioptase	1.655(±.011)		1.708(±.012)
Peridot	1.654(±.020)		1.690(±.020)
Euclase	1.654(±.004)		1.673(±.004)
Phenakite	1.654(−.003, +.017)		1.670(−.004, +.026)
Apatite	1.642(−.012, +.003)		1.646(−.014, +.005)
Andalusite	1.634(±.006)		1.643(±.004)

Refractive Index Table

Danburite	1.630(±.003)	1.636(±.003)
Datolite	1.626	1.670
Tourmaline	1.624(±.005)	1.644(±.006)
Smithsonite	1.621	1.849
Topaz	1.619(±.010)	1.627(±.010)
Prehnite	1.615	1.646
Turquoise & Syn.	1.61	1.65
Lazulite	1.612	1.643
Amblygonite	1.612	1.636
Bakelite	1.61(±.06)	
Nephrite	1.606	1.632
Brazilianite	1.602	1.621
Odontolite	1.60(±.03)	1.61(±.03)
Ekanite	1.597	
Rhodochrosite	1.597	1.817
Verdite	1.580	
Beryl	1.577(±.016)	1.583(±.017)
Augelite	1.574	1.588
Synthetic emerald (New Gilson)	1.571	1.579
Pseudophite	1.57	1.58
Synthetic emerald (hydrothermal)	1.568(±.02)	1.573(±.02)
Synthetic emerald (flux) ..	1.561	1.564
Variscite	1.56	1.59
Serpentine	1.56(-.07)	1.570(-.07)
Coral (black & golden) ...	1.56(±.01)	1.57(±.01)
Ladradorite feldspar	1.559	1.568
Hambergite	1.555	1.625
Beryllonite	1.552	1.562
Agalmatolite	1.55	1.60
Scapolite	1.55	1.572
Quartz & Syn.	1.544(±.000)	1.553(±.000)
Iolite	1.542(-.010, +.002)	1.551(-.011, +.045)
Steatite	1.54	1.590
Amber	1.540	
Chalcedony	1.535	1.539
Apophyllite	1.535	1.537
Albite-oligoclase	1.532(±.007)	1.542(±.006)
Pollucite	1.525	
Microcline	1.522	1.530
Orthoclase	1.518	1.526
Stichtite	1.516	1.542
Thomsonite	1.515	1.540
Leucite	1.508	
Petalite	1.502	1.518
Lazurite (lapis-lazuli)	1.500	
Obsidian	1.500	
Lucite	1.495(±.005)	
Calcite	1.486	1.658
Coral	1.486	1.658
Sodalite	1.483(±.003)	
Glass (normal)	1.48-1.70	
Glass (extreme)	1.44-1.77	
Moldavite	1.48	
Opal	1.45(-.080, +.020)	
Synthetic opal	1.44	
Fluorite	1.434	

TABLE OF DISPERSION

The following figures represent the difference in the gem's refractive index for red light and blue-violet light.

Fluorite007	Idocrase019
Silica glass010	PERIDOT020
Beryllonite010	SPINEL020
Kyanite011	Dioptase022
ORTHOCLASE FELDSPAR	.012	ALMANDITE GARNET	.024
QUARTZ013	Rhodolite Garnet026
BERYL014	PYROPE GARNET027
TOPAZ014	Spessartite Garnet027
Phenakite015	GROSSULARITE GARNET	.028
CHRYSOBERYL015	Epidote030
Sillimanite015	ZIRCON038
Euclase016	Benitoite044
Danburite016	DIAMOND044
Datolite016	Sphene051
Scapolite017	ANDRADITE GARNET	.057
TOURMALINE017	Cassiterite071
SPODUMENE017	Strontium titanate190
CORUNDUM018	Sphalerite156
Kornerupine019	Synthetic rutile330

TABLE OF BIREFRINGENCE OF GEMSTONES

Apatite002-.006	Spodumene016
Syn. Emerald (flux melt)003	Tourmaline018-.020+
Zircon (low)	about .005	Euclase019
Beryl005-.009	Brazilianite019
Danburite006	Diopside026
Andalusite008-.013	Peridot036
Corundum008	Epidote039
Topaz008	Sinhalite039
Chrysoberyl009	Datolite044
Quartz009	Benitoite047
Beryllonite010	Dioptase053
Enstatite010	Zircon	up to .059
Rhodonite010	Cassiterite096
Jadeite013	Azurite110
Kornerupine013	Sphene134
Sillimanite015-.021	Calcite172
Kyanite015	Smithsonite228
Phenakite016	Malachite250
Scheelite016	Syn. Rutile287

Specific Gravity Table

Stibiotantalite	7.50(±.30)	Enstatite	3.25(±.02)
GGG	7.02(±.07)	Sillimanite	3.25(±.02)
Cassiterite	6.95(±.08)	Chlorastrolite	3.20
Scheelite	6.12	Fluorite	3.18(±.01)
Syn. Cubic Zirconia	5.80(±.20)	Apatite	3.18(±.02)
Zincite	5.70	Spodumene	3.18(±.03)
Hematite	5.20(±.08)	Andalusite	3.17(±.04)
Strontium titanate	5.13(±.02)	Euclase	3.10(±.01)
Pyrite	5.00(±.10)	Odontolite	3.10
Marcasite	4.85(±.05)	Lazulite	3.09(±.05)
Zircon		Tourmaline	3.06(-.05, +.15)
(high)	4.70(±.03)	Amblygonite	3.02
(medium)	4.32(±.25)	Danburite	3.00(±.01)
Gahnite	4.55	Psilomelane	3.0
YAG	4.55	Nephrite	2.95(±.05)
Smithsonite	4.30(±.10)	Phenakite	2.95(±.01)
Rutile & Syn.	4.26(±.02)	Datolite	2.95
Spessartite	4.15(±.03)	Brazilianite	2.94
Almandite	4.05(±.12)	Pollucite	2.92
Sphalerite	4.05(±.02)	Verdite	2.90
Painite	4.01	Prehnite	2.88(±.06)
Gahnospinel	4.01(±.40)	Beryllonite	2.85(±.02)
Zircon (low)	4.00(±.07)	Conch Pearl	2.85
Corundum		Agalmatolite	2.80
& Syn.	4.00(±.03)	Turquoise	2.76(-.45, +.08)
Malachite	3.95(-.70, +.15)	Steatite	2.75
Anatase	3.90	Lazurite	
Andradite	3.84(±.03)	(lapis-lazuli)	2.75(±.25)
Rhodolite	3.84(±.10)	Beryl	2.72((- .05, +.12)
Azurite	3.80(-.50, +.07)	Pearl	2.70(-.02, +.15)
Pyrope	3.78(-.16, +.09)	Labradorite	2.70(±.05)
Chrysoberyl	3.73(±.02)	Augelite	2.70
Syn. alexandrite	3.71(±.02)	Pseudophite	2.70
Staurolite	3.71(±.06)	Calcite	2.70
Rhodochrosite	3.70	Scapolite	2.68(±.06)
Syn. spinel	3.64(-.12, +.02)	Syn. emerald	
Benitoite	3.64(±.03)	(hydroth.)	2.68(±.02)
Kyanite	3.62(±.06)	(Gilson)	2.67(±.02)
Grossularite	3.61(-.27, +.12)	(flux)	2.66
Taaffeite	3.61	Quartz & Syn.	2.66(±.01)
Spinel	3.60(-.03, +.30)	Syn. Turquoise	2.66
Topaz	3.53(±.04)	Albite-	
Diamond	3.52(±.01)	Oligoclase	2.65(±.02)
Sphene	3.52(±.02)	Coral	2.65(±.05)
Rhodonite	3.50(±.20)	Iolite	2.61(±.05)
Sinhalite	3.48	Chalcedony	2.60(±.05)
Idocrase	3.40(±.10)	Serpentine	2.57(±.06)
Epidote	3.40(±.08)	Orthoclase	2.56(±.01)
Rhodizite	3.40	Microcline	2.56(±.01)
Peridot	3.34(-.03, +.14)	Variscite	2.50(±.08)
Jadeite	3.34(±.04)	Leucite	2.50
Zoisite	3.30(±.10)	Obsidian	2.40(-.07, +.10)
Diopside	3.30(±.05)	Moldavite	2.40(±.04)
Kornerupine	3.30(±.05)	Petalite	2.40
Saussurite	3.30	Apophyllite	2.40(±.10)
Dumortierite	3.30(±.10)	Thomsonite	2.35(±.05)
Diopside	3.29(±.03)	Hambergite	2.35
Axinite	3.29(-.02)	Alabaster	2.30
Ekanite	3.28	Glass	2.3 to 4.5

HANDBOOK OF GEM IDENTIFICATION

Sodalite	2.24(± .05)	Coral (black)	1.35(± .05)
Chrysocolla	2.20(± .10)	Jet	1.32(± .02)
Stichtite	2.18(± .02)	Plastics	1.30(± .25)
Opal	2.15(− .09, + .07)	Amber	1.08(± .02)
Coral (golden)	2.12(± .1)		
Syn. Opal	2.05(± .03)		

Mohs Hardness Table

Diamond	10	Leucite	6
Silicon carbide	9¼	Petalite	6
Corundum & Syn.	9	Hematite	5½-6½
Chrysoberyl	8½	Rhodonite	5½-6½
Syn. cubic zirconia	8½	Beryllonite	5½-6
YAG	8¼	Anatase	5½-6
Spinel & Syn.	8	Brazilianite	5½
Painite	8	Enstatite	5½
Topaz	8	Willemite	5½
Taaffeite	8	Moldavite	5½
Rhodizite	8	Thomsonite	5½
Beryl & syn. emerald	7½-8	Opal	5-6½
Phenakite	7½-8	Diopside	5-6
Zircon (high, medium)	7½	Glass	5-6
Almandite garnet	7½	Strontium titanate	5-6
Hambergite	7½	Lazulite	5-6
Euclase	7½	Lazurite (lapis-lazuli)	5-6
Gahnite	7½	Turquoise	5-6
Gahnospinel	7½	Sodalite	5-6
Rhodolite garnet	7-7½	Chlorastrolite	5-6
Pyrope garnet	7-7½	Sphene	5-5½
Spessartite garnet	7-7½	Obsidian	5-5½
Tourmaline	7-7½	Datolite	5-5½
Andalusite	7-7½	Bowenite (serpentine)	5-5½
Iolite	7-7½	Apatite	5
Staurolite	7-7½	Scheelite	5
Grossularite garnet	7	Dioptase	5
Quartz & Syn.	7	Smithsonite	5
Danburite	7	Odontolite	5
Dumortierite	7	Stibiotantalite	5
Chalcedony	6½-7	Syn. Turquoise	5-
Peridot	6½-7	Apophyllite	4½-5
Jadeite	6½-7	Syn. opal	4½
Andradite garnet	6½-7	Zincite	4½
Axinite	6½-7	Kyanite	4-7
Saussurite	6½-7	Variscite	4-5
Idocrase	6½	Augelite	4
Scapolite	6½	Fluorite	4
Kornerupine	6½	Rhodochrosite	3½-4½
Zircon (low)	6½	Malachite	3½-4
Pollucite	6½	Azurite	3½-4
GGG	6½	Sphalerite	3½-4
Spodumene	6-7	Coral	3½-4
Sinhalite	6-7	Conch pearl	3½
Epidote	6-7	Calcite	3
Sillimanite	6-7	Verdite	3
Cassiterite	6-7	Black coral	3
Zoisite	6-7	Hemetine	2½-6
Rutile & Syn.	6-6½	Pearl	2½-4½
Microcline	6-6½	Jet	2½-4
Albite-Oligoclase	6-6½	Pseudophite	2½
Orthoclase	6-6½	Agalmatolite	2½
Nephrite	6-6½	Serpentine	2-4
Pyrite	6-6½	Amber	2-2½
Benitoite	6-6½	Copal	2
Marcasite	6-6½	Alabaster	2
Prehnite	6-6½	Stichtite	1½-2
Ekanite	6-6½	Steatite (soapstone)	1-1½
Labradorite	6		
Amblygonite	6		

HANDBOOK OF GEM IDENTIFICATION

Significant Fluorescence in Gemstones. There are many gem materials that fluoresce in some specimens and not in others. There are many others in which the fluorescence has no particular significance in gem identification. The following table makes an effort to list those cases of fluorescence where the fluorescence may be of use in identification or where it is almost always present. This fluorescence is limited to ultra-violet fluorescence, long (3660 Angstroms) and short-wave (2537). There are rare instances in which x-ray fluorescence is of value in testing, but so few have access to x-ray equipment that it is mentioned only under the identification of the specific materials, such as diamond and massive translucent grossularite.

TABLE OF SIGNIFICANT FLUORESCENCE

O = Inert M = Moderate VS = Very Strong
W = Weak S = Strong Color = refers to the fluorescence

Color	Gemstone	Long Wave	Short Wave
White	Diamond	O-VS (bluish)	Same as Long Wave
	Opal (white)	S	S
	Ivory	W-S (bluish)	W-S (bluish)
	Amber	M-VS (bluish)	M-S (yellowish-green)
	Coral (white)	W-S (bluish)	W-S (bluish)
	Some Plastic	S	W-S
	Tortoise Shell	O-S (bluish)	O-S (bluish)
	Syn. Spinel (colorless)	O	S (greenish or bluish)
	Glass	O-S	O-S
	Pearl and Cultured	O-S (bluish)	O-M (bluish)
	Red	Syn. Ruby (verneuil)	VS
Flux		VS	W-M
Ruby, Natural-Burma		S	W
Ruby, Natural-Siam		W	O
Ruby, Natural-Africa		M-S	W-S
Syn. Spinel (blue)		S	S (blue to bluish white)
Spinel, Natural (red to orange)		W-S (to orange)	O-W
Glass		O	O-S
Feldspar (white)		O	M (dark)
Diamond		O-S	O-M
Green Grossularite (Tp)		O-M	O-M

Table of Significant Fluorescence

O = Inert M = Moderate VS = Very Strong
W = Weak S = Strong Color = refers to the fluorescence

Color	Gemstone	Long Wave	Short Wave
Orange	Coral (orange-light red)	O-M (to pinkish)	O-M (to pinkish)
	Sapphire (light blue)	M-S (pinkish)	W-M
	Sapphire (colorless)	O-S (reddish)	O-M
	Diamond	O-S	O-S
	Jadeite (dyed lavender)		
	(some)	O-W-M	O-W
	Syn. Spinel (light blue)	W-M	M-S (chalky)
	YAG (colorless)	O-M	O-W
	Zircon (orangy-red)	O	O-S (to yellow)
	Syn. Emerald (early Gilson)	W-S	W-M
	Syn. Sapphire (Alexandritelike)	M	M
	Yellow	Amber	W-S
Apatite (green)		M (dark greenish)	Same W
Apatite (violet)		M (greenish)	W-M (violet)
Diamond		O-S	O-S
Opal (white)		M-S (may phos)	M-S
Oiled Emerald		M (oiled fracta)	W
Glass		O-S	O-S
Syn. Spinel (lt. green)		S	O-M
YAG (yellowish-green)		VS	VS
Syn. Cubic Zirconia		O-M (orangy)	O-M (orangy)
Zircon (flame)		O-W	O-S
Zircon (yellow-orange)		O-M	O-M
Topaz (colorless)		O-W	O
Topaz (red, yellow, blue, brown)		O-W	O
Lapis		O	W-M (greenish)
Syn. Sapphire		O	M-S (greenish)
Green		Amber	S (white)
	Apatite	M (yellowish)	W (yellowish)
	Opal (common)	O-S	O-S
	Pearl and Cultured	O-S	O-S
	Syn. Spinel (yel-green)	S (yellowish)	S (yellowish)
	Diamond	O-S	O-S
	Glass	O-S	O-S
	Willemite	S (phos)	S (phos)
	Emerald	O-W	O-W

HANDBOOK OF GEM IDENTIFICATION

TABLE OF SIGNIFICANT FLUORESCENCE

O = Inert M = Moderate VS = Very Strong
W = Weak S = Strong Color = refers to the fluorescence

Color	Gemstone	Long Wave	Short Wave
Blue	Diamond	O-S	O-S
	Ivory	W-S (light)	W-S (light)
	Pearl and Cultured	N-S (light)	N-S (light)
	Syn. Spinel (colorless)	O	S
	Syn. Spinel (dark blue)	S (red)	S (mottled)
	Fluorite	O-VS (phos)	O-S
	Danburite	W-S	W-M
	Glass	O-S	O-S
	Benitoite	O	S
	Plastic	O-S	O-S
	Syn. Sapphire (blue)	O	W-M (chalky greenish)
Violet	Diamond	O-S	O-S
	Sapphire (alex-like)	O-S (red violet)	O-M (reddish)
	Morganite	O-W (reddish)	O-W (reddish)
	Fluorite	O-S (bluish)	O-S (bluish)
	Apatite (yellow)	O-M (light pinkish)	O-M (light pinkish)
	Apatite (violet)	O-M (yellow)	O-M (light)
	Syn. Sapphire (pink)	M-S (red)	W-M

Short Glossary of Gemological Terms

- Absorption spectrum.** The dark lines or gaps produced in a continuous spectrum by absorption of certain wave lengths by certain materials.
- Amorphous.** Without form. Material that has no regular arrangement of atoms, hence no crystal structure.
- Anisotropic.** Possessing the property of double refraction. See Chapter VI.
- Asterism.** A term applied to the display of a rayed figure (star) by a gemstone when cut en cabochon.
- Atom.** The smallest portion of an element which retains the properties of that element.
- Atomic weight.** The weight of an atom of an element compared to the arbitrary figure, 16 assigned to an atom of oxygen.
- Biaxial.** Possessing two optic axes—two axes of single refraction in a doubly refractive substance. Gems in the orthorhombic, monoclinic and triclinic crystal systems are biaxial. See Chapter VI.
- Birefringence.** The strength of double refraction measured by taking the difference between the high and low indices of a doubly refractive stone. See Chapter VI.
- Boule.** The rough form of synthetic corundum and spinel. Pear or carrot shaped.
- Brilliant.** A gem cut in the brilliant form (the common round diamond cut), with the table and 32 facets on the crown, and 24 facets plus the culet on the pavilion.
- Cabochon.** A facetless cutting style that produces convex surfaces.
- Carat.** Unit of weight equal to 200 milligrams.
- Chatoyancy.** Optical phenomenon, displayed by certain gems, that produces a thin bright line across a stone cut en cabochon. Cat's-eye effect.
- Conchoidal.** Type of fracture commonly seen in gems and glass. Break resembles a clam-shell surface. See page 9.
- Critical angle.** Largest angle measured from the normal at which light can escape from an optically dense substance and the smallest angle to the normal at which light is totally reflected within the dense substance. See Chapter V.
- Cryptocrystalline.** Having crystals so small that individual crystals cannot be resolved by an ordinary microscope, but detectable by effect on polarized light.
- Crystal system.** One of the six groups of crystal patterns in which minerals and other crystalline solids occur.
- Crystal.** Material with regular arrangement of atoms bounded by natural plane surfaces.
- Cubic.** See isometric.
- Density.** Mass per unit volume. See Chapter IV.
- Diamondscope.** Trademark name for a binocular microscope mounted on a patented dark-field illuminator base. See Chapter VII.
- Dichroism.** Unequal absorption of the two portions of a doubly refracted beam of light, producing two colors when observed through a dichroscope.
- Dichroscope.** A small instrument for gem testing that is used to detect pleochroism. See page 57.

HANDBOOK OF GEM IDENTIFICATION

- Dispersion.** The separation of white light into its component colors.
- Double refraction.** The property of separating a single light ray into two. See Chapter II.
- Doublet.** An imitation gem composed of two pieces of gem material or one of gem material and a second of glass cemented together.
- Doubling of the opposite facets.** Facet edges, scratches, or other objects seen as double images when viewed through a doubly refractive gem.
- Emerald filter.** A color filter through which imitations appear green, and emerald, synthetic emerald, and some other genuine gems have a reddish color. See Chapter IX.
- Extinction.** Position of darkness in a transparent anisotropic gem when examined in crossed polarized light.
- Fire.** See dispersion.
- Fluorescence.** The emission of visible light by a gem when subjected to ultra-violet or X-radiation.
- Fracture.** A break other than in a cleavage direction. Usually shell-like in gems. See Chapter III.
- Gemolite.** Trade-mark name for a binocular microscope mounted on a patented illuminator base. See Chapter VII.
- Habit.** The crystal form in which a mineral most often occurs; i.e., habit of diamond is the octahedron.
- Hardness.** Resistance a material offers to scratching or abrasion. See Chapter III.
- Hardness points or pencils.** Points made from gem materials for hardness determination. Hardnesses of 9, 8½, 8, 7, 6½, 6 are common, with some sets including 10, 7½, 5. See Chapter III.
- Hexagonal.** A crystal system (three equal axes at 60 degrees, a fourth perpendicular to the other three and unequal in length). Examples: quartz, corundum, beryl, and tourmaline.
- Imperfection.** Any surface or internal flaw or inclusion in a gem.
- Inclusion.** Internal imperfection other than fracture or cleavage in a gem.
- Inorganic.** Any substance not produced through the agency of living organisms.
- Interference.** Effect produced of two or more light waves traveling the same path after traveling different distances. If they are "in phase," they will reinforce each other (intensify the color). If they are out of phase, they will destroy each other. Interference of white light results in destruction of certain wave lengths and reinforcement of others; producing such effects as the play of color in opal.
- Iridescence.** Light interference effect in thin films of gas or liquid causing rainbow effects.
- Isometric.** Crystal system of highest symmetry with three equal crystallographic axes at right angles. Gems which crystallize in the isometric system are diamond, spinel, and the garnet group.
- Liquid inclusion.** Space within a substance filled or partially filled with a liquid. See Chapter VIII.
- Luster.** The appearance of a gem. More specifically, the quality and

Short Glossary of Gemological Terms

quantity of light reflected by a gem. Luster usually refers to the appearance of the surface.

Metamict. A condition resulting from the breakdown of the crystal structure of a mineral caused by radioactivity. In zircon, the radioactivity of uranium or thorium impurities slowly destroys the crystal lattice leaving a nearly amorphous state. In ekanite, destruction of crystal structure is complete.

Methylene iodide. An organic liquid used in gem testing. R. I. 1.74, S.G. 3.32.

Mineral. A natural inorganic material with a characteristic composition and usually possessing a crystal structure.

Mohs Scale. An arbitrary scale of hardness with numbers from one to ten assigned to ten minerals of increasing hardness from talc to diamond. See page 10. See Chapter III.

Monochromatic. Possessing a single color.

Monochromatic Unit. A source of monochromatic light for refractive index determination. See Chapter V.

Monoclinic. A crystal system of low symmetry. Jade, spodumene, and orthoclase feldspar are monoclinic.

Opaque. Transmitting no light, even through thin edges.

Optic axis. A direction of single refraction in a doubly refractive substance. See Chapter VI.

Organic. Formed by a living organism—plant or animal.

Orient. The iridescent luster of a pearl.

Orthorhombic. A crystal system of fairly low symmetry. Described by three crystal axes at right angles, but unequal in length. Gems which crystallize in the orthorhombic system are topaz and peridot.

Paste. A name commonly applied to glass imitations. Used less often for other imitations. See Chapter XI.

Plastic. A manufactured organic product often used to imitate gems (especially amber) in costume jewelry.

Pleochroism. Unequal absorption of the two portions of a doubly refracted beam of light producing two or more colors when observed through a dichroscope.

Polariscope. A gem testing instrument employing two pieces of Polaroid to determine single and double refraction, pleochroism, and interference figures. See Chapter VI.

Polarized light. Light waves vibrating in a single plane. See Chapter VI.

Polaroid. Trade-mark name for a material which effectively polarizes light.

Radiograph. A photoshadowgraph by X-rays or gamma radiation of objects at least partially transparent to such wavelengths but opaque to visible light.

Reconstructed.

A term used early in the history of synthetic rubies when it was claimed

HANDBOOK OF GEM IDENTIFICATION

incorrectly that natural ruby fragments were sintered to form a larger mass which was then cut. This has been proven to be an impossibility.

Reflection. Rebound from a surface. Light which strikes a reflecting surface is reflected at the same angle to the normal as the angle of incidence. See Chapter V.

Reflectivity Meter. An electronic device for measuring the relative ability of a surface to reflect radiant energy. Relative reflectivity depends on R.I., flatness, quality of polish, and the cleanness of the surface.

Refraction. The bending of light rays as they pass from one medium to another of different optical density at angles other than perpendicular to their boundary. See Chapter V.

Refractive index. The ratio of the velocity of light in air to its velocity in a substance. See Chapter V.

Refractometer. An instrument that measures refractive index. See Chapter V.

Silk. Term commonly applied to long needle-like crystal inclusions in natural ruby and sapphire.

Spectroscope. An optical instrument used for forming spectra.

Spectrum. The images formed when a beam of light (visible or otherwise) is dispersed and then brought to focus.

Specific gravity. The ratio of the weight of a substance to that of an equal volume of water at 4 degrees Centigrade. See Chapter IV.

Synthetic. A man-made substitute possessing the same chemical composition, crystal structure, and thus the same properties as the gem it represents. See Chapter X.

Tetragonal. A crystal system to which may be assigned two crystallographic axes equal in length and at right angles with a third at right angles to the first two. Zircon and idocrase are gems which occur in the tetragonal system.

Transparent. Transmitting light with a minimum of distortion.

Translucent. Transmitting light, but diffusely. Example: frosted glass.

Triclinic. The least symmetrical crystal system. Turquoise and most feldspars occur in this system.

Ultra-violet. That portion of the electromagnetic spectrum just shorter in wave length than visible violet light.

Uniaxial. Doubly refractive material with but one optic axis (direction of single refraction). Materials which crystallize in the hexagonal or tetragonal crystal systems.

X-rays. Radiation of .5 to 2.0Å. propagated in a cathode tube by bombarding a copper, tungsten, or other metal target with a stream of electrons. Useful because of their remarkable ability to penetrate almost any material. X-ray diffraction patterns from a given material serve to identify the material.

The Gemological Institute of America

The Gemological Institute of America, known to most jewelers as GIA or the Institute, is the educational, research and testing center of the jewelry industry. The purpose of this endowed, non-profit organization is to provide professional training and other services for jewelers and other gem enthusiasts. GIA was founded in 1931 by Robert M. Shipley. When he retired in 1952, Richard T. Liddicoat, Jr. became Executive Director.

The Gemological Institute of America is a nonprofit, tax-exempt organization. It has two subsidiaries which are tax paying because, theoretically at least, they are in competition with other tax paying businesses. The two subsidiaries are Gem Instruments Corporation, which was formed in 1977, and more recently, the GIA Gem Trade Laboratory.

Educational Activities

The Gemological Institute's training is provided on a home-study, or correspondence basis; by classroom instruction; or partially by correspondence and partially in residence. Courses offered are: Diamonds, Colored Stones, Gem Identification, Jewelry Retailing, Jewelry Design, Jewelry Display, Diamond Setting, Wax Carving & Modeling, Jewelry Repair, Hand Engraving, Jewelry Arts and Jewelry Store Management. Six-month's residence programs in Gemology, Jewelry Arts and Jewelry Store Management are offered in Santa Monica and Gemology only is offered in New York. One-week classes are offered not only in those two cities, but all across the United States, Canada and in several foreign countries (in 1980, classes were given in Japan, Hong Kong and Singapore).

Gem Instruments Corporation

Gem Instruments Corporation (GIC) has its manufacturing facilities in a large building on Colorado Avenue in Santa Monica, California. There are two sales outlets; one at 1180 Sixth Avenue, New York City, and the main office at 1735 Stewart Street in Santa Monica. GIC manufactures many instruments familiar to most American jewelers; such as the Gemolite, the Illuminator Polariscope,

HANDBOOK OF GEM IDENTIFICATION

the Gem Detector, Diamond Grader, Duplex Refractometer, Diamondlite, Spectroscope Unit, Diamondlux, Proportion-Scope and ColorMaster.

Gem Instruments Sales is under the direction of Kenneth M. Moore, Vice President, and Gem Instruments Manufacturing under Gale M. Johnson, also a Vice President of GIC.

GIA Gem Trade Laboratory

The GIA Gem Trade Laboratory, Inc. has facilities in Santa Monica, Los Angeles and New York which provide complete testing and grading for jewelers and the public. In addition to routine testing, grading and determination of extent and cause of damage, they develop identification methods for new gemstone substitutes. Services are performed for many organizations, including the U.S. Customs, the FBI, Better Business Bureaus, the Jewelers' Vigilance Committee, Chamber of Commerce, and insurance companies.

Publishing

In addition to other activities, the Gemological Institute of America is engaged in publishing. It has several books that have attained wide recognition in the jewelry industry, including the Diamond Dictionary, the Jeweler's Manual, and the Dictionary of Gems and Gemology. Soon to be published is a book on diamonds written in South Africa. GIA also publishes a professional quarterly, *Gems & Gemology*, which has been published on gems and related subjects since 1934 and is currently being enlarged. It has also participated in the making of films, such as the acclaimed "Gems of the Americas", on which GIA collaborated with the Los Angeles County Museum of Natural History.

Technical and Teaching Staff

The technical and teaching staff of the Gemological Institute of America is made up mostly of gemologists, but many of them are specialists who are trained and experienced in one or more of a number of other fields. These include jewelry manufacturing, marketing, mineralogy, geology, education, business administration and retailing.

Gemological Institute of America

The policy setting body for the GIA is its Board of Governors, which has a majority of jewelers, but includes also scientists, financial men and other specialists.

The chief executive officer is President Richard T. Liddicoat, Jr. Vice President Robert Crowningshield has a responsibility to operate the Gem Identification Section of the GIA Gem Trade Laboratory and Vice President Bert Krashes has the Diamond Grading activities of the GIA Gem Trade Laboratory. Both are very well known, experienced gemologists. Mr. Crowningshield has contributed much to the advancement of gemological science with his contributions to identification of treated diamonds, dyed jade and many other contributions over the years.

Two other long-time GIA key people, Kenneth M. Moore and Gale M. Johnson are now Vice Presidents of Gem Instruments Corporation.

Jill Fisher serves as Assistant to the President, screens applicants for technical positions, manages the faculty secretarial group, and teaches the pearl course.

The Director of Education for the Gemological Institute of America is Peter Keller, Ph.D. Supervisors in Education include the New York Director of Education, Paul Holt and New York Resident Program Supervisor, Tom Yonelunas. J. Michael Allbritton, who is in charge of the one and two week classes, offered by GIA in Santa Monica, New York and elsewhere in the United States, Canada and overseas. Dennis Foltz is in charge of the Home Study Courses and course writing. The Resident Course Administrator is Robert Earnest. Ray Page is in charge of the Diamond Instruction in the full-time Resident Program, Bill Boyajian of the Colored Stone and Gem Identification portions of that Program. A. Richard Shalberg is in charge of the Jewelry Arts Residence Training and the one-week classes in Repair, Setting and Wax Carving and Jewelry Design.

D. Vincent Manson, Ph.D., is Director of Research and is assisted by a staff of eight. Charles Fryer, who for many years directed the Santa Monica Gem Trade Laboratory, is now in charge of Course Revisions, working with Dennis Foltz. William Bender is Controller for GIA and the two subsidiaries as well.

HANDBOOK OF GEM IDENTIFICATION

Douglas Macdonald is Director of Administration and the Assistant Director is Archie Curtis. They are ably assisted by our long time Supervisor of Educational Administration, T. J. Barrows and Ron Theile, formerly purchasing agent for Gem Instruments Corporation who came over to GIA to supervise Printing, Shipping and Purchasing.

Michael D. Waitzman is in charge of Gem Media, which includes graphics, photography, audio-visual programs and the student newsletter.

Walter Brueggeman is Manager of Operations. Margaret Orozco heads the GIA Bookstore.

Facilities

GIA has a number of locations. The headquarters complex in Santa Monica consists of four buildings; the major one of which is 52,000 square feet, on approximately 3½ acres. The main educational functions and a Gem Trade Laboratory are headquartered at 1660 Stewart Street, Santa Monica. Across the street at 1735 Stewart Street, another approximately 35,000 square feet of floor space is occupied by the service functions which include Gem Instruments Sales, printing, shipping, accounting, the GIA Bookstore, cafeteria, data processing, educational administration, the personnel office and resident course registrar's office.

In another direction at 2912 Colorado is the Gem Instruments Manufacturing, occupying over 25,000 square feet.

A fourth facility in the Santa Monica area is that occupied by Gem Media and our lapidary function at 2980 Nebraska.

In downtown Los Angeles, the Gem Trade Laboratory occupies a large suite on the ninth floor at 606 South Olive. In New York City at 580 Fifth Avenue are two Gem Trade Laboratories and a number of support functions.

The educational function in New York City is at 1180 Avenue of the Americas on the eighth floor, where there are a large number of classrooms, a Gem Instruments salesroom and a bookstore.

Acquiring Further Training in Gem Identification

One who seeks training in gem identification has three major choices: (1) he may gain the information from several gemological

Gemological Institute of America

texts that are related to this subject in some degree, (2) he may take a correspondence course, or (3) he may study in residence.

If the choice is to pursue a course of study through a reading program, the following books are commended: *Gems & Gem Materials*, by Kraus & Slauson; *Gemstones of North America*, by John Sinkankas; *Textbook of Mineralogy* by Edward S. Dana; *The Microscopic Determination of Nonopaque Minerals* (USGS Bulletin #848) Larsen & Berman; *Gem Testing* by B. W. Anderson; *Gemmologists' Compendium* and *Gems: Their Sources, Descriptions & Identification* by Robert Webster.

The techniques of gem identification are covered in considerable detail in this work and in Anderson's *Gem Testing*. Despite the fact that both books deal with the same subject, the approach is somewhat different and the student should profit from both. *Gems: Their Sources, Descriptions & Identification* and *Gems & Gem Materials* provide further information on theory and, together with *Gemstones of North America*, serve to describe the gem materials in considerable detail. Larsen & Berman provides property values, including those of unusual materials rarely encountered by the jeweler, and the Dana textbook is useful for further descriptions of such gem materials. This "do-it-yourself" approach to gemological education has the advantages of lower cost and that it can be used anywhere. It has the disadvantages of lack of assistance, when needed, and an absence of supervised identification, grading, and appraisal practice.

A second choice is a guided home-study program, such as a correspondence course that provides identification instruction supplemented with practice in instrument use and testing techniques on a large number of stones selected for that purpose. Training by this method is less expensive than resident training, but slightly more expensive than merely reading books on the subject. The correspondence method permits a student to maintain his own pace and to follow a guided program that fits his needs. If a major portion of the program involves testing and identification of stones sent to him, there is no reason that the training received should not produce results equivalent to classroom instruction.

A third method is training in residence. Both correspondence and

classroom instruction is offered by the Gemological Institute of America.

How to have Identifications Substantiated

Gemstones may be submitted for identification either to the Gemological Institute of America, 1660 Stewart Street, Santa Monica, California 90404 or to the Institute's Gem Trade Laboratory at 580 Fifth Avenue, New York, New York 10036. A moderate fee is charged for this service, plus return postage.

Index

A

- Aberration, chromatic and spherical 67
- Absorption, 56; selective 112, 180; spectrum 429
- Absorption Spectra, additional spectra listed under species, 186-210
- actinolite, 204
- almandite garnet, dark color 190
- andalusite, 190
- apatite, 204
- axinite, 204
- beryl, aquamarine 190; yellow-green 190; Brazilian emerald 191; emerald, natural and synthetic 194
- chalcedony, dyed-green 191; natural green 209
- chrysoberyl, alexandrite 191; pale-yellow 191; intense-yellow 192; green 192; brown 192
- corundum, natural and synthetic, ruby 127, 192; sapphire 198-199
- demantoid garnet, yellow-green 192; rich-green 193
- diamond, 193-194, 210
- dipside, 204
- diopase, 204
- enstatite, 205
- epidote, 205
- euclase, 205
- fluorite, 205
- gahnite, 205
- grossularite garnet, green 194, 210; hessonite 195; pink 206, 210
- hessonite garnet, 195
- idocrase, californite, 206
- iolite, 206
- jadeite jade, 195; dyed 196, 210
- kornerupine, 206-207
- kyanite, 207
- nephrite jade, 196
- orthoclase feldspar, yellow 196
- pearl, 196-197
- peridot, 197
- prehnite, 262
- pyrope garnet, 197
- quartz, green aventurine 197
- rhodochrosite, 207
- serpentine, dyed 196; green 207; greenish-yellow 269
- sinhalite, 208
- sodalite, 208
- spessartite garnet, 199
- sphalerite, 208
- spinel, natural and synthetic, 199-201
- spodumene, yellow-green 201
- synthetic garnet, 209
- synthetic rutile, 198
- thulite, 208
- topaz, 201
- tourmaline, 202
- turquoise, 203
- variscite, 208
- willemite, 208
- zircon, 203
- zoisite, blue 209; yellow 210
- Acids and solvents, 219-220
- Actinolite, 254; cat's-eye 254; spectrum 204
- Agalmatolite, 421, 423, 425
- Agate, see chalcedony
- Agatized wood, see chalcedony
- Aggregates, crystalline, 4, 55, 56
- Albite-oligoclase, 245-246
- Alexander, Dr. A. E., 176
- Almandite garnet, see garnet group
- Alexandrite, see chrysoberyl
- Alpha index, 60
- Altered Stones and Ancillary tests, 211-221
- Alton, Noel, 62
- Amazonite feldspar, see microcline feldspar
- Amber, 3, 14, 54, 228; ancillary test 214; cultured 342-343
- Amberdan, 160, 228, 342
- Amblygonite, 228-229
- American Gem Society, Foreword, 70, 224
- American Optical Company, 72
- Amethyst quartz, 263-264
- Amorphous, 3, 4, 46, 158, 159, 429
- Anatase, 229
- Ancillary tests and Altered Stones, 211-221; acids and solvents 219-220; hot-point 217-219; magnetism 220-221

HANDBOOK OF GEM IDENTIFICATION

- Andalusite, 229-230; spectrum 190
Anderson, B. W., 27, 44, 112, 116, 168, 189, 221, 318
Andradite garnet, see garnet group
Angle of incidence, 23
Angle of reflection, 23
Anisotropic, see double refraction
Anomalous double refraction, 53, 54, 55, 133, 135, 136, 159
Antimony, see color agents
Apatite, 230; spectrum 204
Apophyllite, 230
Aquamarine, see beryl variety
Aragonite, 163, 164, 172
Assembled stones, 151-156; description 151; detection 153-156; types 152-153
Asteriated corundum, 237; synthetic corundum 121
Asteriated quartz, 263
Asterism, 284, 429
Atom, 429
Atomic weight, 13, 429
Augelite, 230
Aventurine feldspar, see albite-oligoclase
Aventurine quartz, 264; spectra 197
Axinite, 230-231, spectrum 204
Axis, optic 47 48, 49
Azurite, 231
emerald, see also synthetic emerald, 4, 112, 113, 114, 116, 232; inclusions 94-96, 106-108; natural vs. synthetic 142-144; spectra 186, 191, 194
Beryllonite, 233
Beta (intermediate) index, 60, 61
Biaxial, 48, 60, 429
Birefringence, definition 46, 429; determination by magnification 49, 50; refractometer determination 60; table 47, 422
Biwa pearls, see cultured pearls
Black, nontransparent gemstones, identification of 401-411, 416
Black coral, 236, 402
Black pearls, also see pearls, 176-177
Bloodstone, see chalcedony
Blue gemstones, identification of, nontransparent, 373-391, 412-413
transparent, 296-304, 412
Boule, 119-120, 121, 130, 429
Bragg, Sir William, 308
Brazilianite, 233
Brilliant, 422
Bromoform, 20, 21, 126
Brown gemstones, identification of, nontransparent, 393-400, 415
transparent, 335-344, 414
Bubbles (spherical), see also inclusions, 104-111, 122, 135, 137, 138, 145, 146, 158-160
- ### B
- Bakelite, 219; see plastic
Balance
Berman 17, 19
Diamond, 14-17
Jolly, 19
Penfield, 19
Westphal, 19
Barnes, W. H., 173
Bausch and Lomb, 68, 72
Beck Hand Spectroscope, 180, 181
Becke line, 44, 45
Benitoite, 231
Benson, Lester B., Jr., Preface, 27, 30, 35, 182
Berman balance, 17, 19
Beryl, 4, 231-233; Ancillary test 216; characteristic inclusions 94-96; emerald filter 112, 113; spectra 186, 190, 191, 194
aquamarine, 4; inclusions 96; spectra 190
- ### C
- Cabochon, 429; cut 35, 64, 65
Calcite, 3, 233-234
Candling test, also see pearls, 168
Carbon tetrachloride, 16, 17, 161
Carat, 429
"Carbon," 95
Carnelian, see chalcedony
Cassiterite, 234
Cat's-eye chrysoberyl, see chrysoberyl
Cat's-eye quartz, 264
Chalcedony (chalcedonic quartz), 113, 264-267; fracture 8, 84; inclusions 101; spectra 191, 209, varieties 264-267
Characteristic inclusions, see imperfections

Index

- Chatham, Carroll, 104, 106, 107, 117, 120, 131, 132, 138, 140, 316
- Chatham synthetic emerald, 138-140, 142, 313, 315-318
- Chatoyancy, 284-285, 429
- Chelsea filter, see filter
- Cherrystone clam, 166
- Chinese amber, 219
- Chlorastrolite, 234
- Chromatic aberration, 67
- Chrome diopside, 102
- Chromium oxide, see color agents
- Chrysoberyl, 4, 229-230; spectra 186, 191, 192
- Chrysocolla, 277
- Chrysocolla chalcedony, see chalcedony
- Chrysoprase, see chalcedony
- Cinnamon oil, R.I. 41
- Citrine quartz, 263-264
- Cleaning, gemstones 74; refractometer 40, 41
- Cleavage, 7, 8, 283; false, see parting; in identification 85; table 417
- Clerici's solution, 21, 22
- Cobalt oxide, see color agents
- Color (Allochromatic) agents, 183-184; antimony 157; chromium 144, 183-184; cobalt, 134, 144, 157, 184; gold 157; iron 183, 184; manganese 144, 157, 184; nitrogen 184; rare-earths 144, 184; silver 157; titanium 144; uranium 184
- Color banding, also see inclusions, curved 106; in corundum 89, 126, 127; in low-property zircon 99; in spinel 135
- Color filters, see filters
- Color tables, 412-417
- Colorless, transparent gemstones, identification of, 357-372, 416
- Colombian emeralds, also see beryl (emerald), 94-96, 107, 142, 143
- Conch pearls, also see pearls, 166, 167, 178, 236
- Conchiolin, definition 163
- Conchoidal fracture, 8, 429
- Contact liquid, composition 31
- Copal, 235
- Coral, 3, 178, 236, 394, 397-398; black 236, 407; golden 394, 398
- Corundum, see also synthetic corundum, 50, 237-238; inclusions, characteristic 85-90; natural vs synthetic 82, 121-132; parting, false cleavage 8
- ruby 4; spectra 187, 192
- sapphire, 4, 116; spectra 198-199
- Critical angle, definition 25, 429
- Cross-hatched, see anomalous double refraction 135, 136
- Crossed filter technique, 117
- Crowningshield, Robert, Preface, 35, 188, 242
- Cryptocrystalline, 429
- Crystal, 429; forms and habits 5; function in determinations 4, 5; negative 100; structure 5
- System, 4, 22; optic character 47, 48; see isometric (cubic), hexagonal, monoclinic, orthohombic, tetragonal, triclinic
- Crystalline, aggregates, 55, 56; definition 4
- Cubic crystal system, see isometric
- Cubic zirconiz, 149, 357
- CZ 149, 357
- Cultured pearls, also see pearls, 164, 165, 167
- Curved striae, see striae
- Custom Gemolites, 72, 73
- Cymophane, see chrysoberyl
- Czochralski pulling technique, 111, 120; synthetic scheelite 268

D

- Dammar Resin, 235
- Danburite, 238-239
- Dark-field illumination, 67; definition 66; imperfection resolution 84
- Datolite, 239
- Day, Norman 117
- De Beers, 146
- Demantoid garnet, see garnet group (andradite)
- Density, definition 13, 429
- Dialdex refractometer, 27, 28
- Diamond, see also synthetic gemstones, 4, 5, 13, 14, 54, 115, 136, 145, 146, 239-243; ancillary test 213-214; cleavage 7, 85; inclusions 102; Premier 116; spectra 186-187, 193, 194, 210, 239, 242

HANDBOOK OF GEM IDENTIFICATION

treated, 185, 240-243; spectra 193, 194
Diamond balance, 14-17
Diamond Grader, 72-73
Diamondscope, 69-70, 429
Dichroism, 56, 58, 130, 429
Dichroscope, 56-58, 57, 225, 429
Diffraction (x-ray), see x-ray methods
Diopside, 243; spectra 204
Diopside, 243, spectra 204
Dispersion (fire), 6, 283, 430; table 422
Double-mirror method, also see pearls, 170-172
Double refraction (anisotropic), 5, 34-35, 46-56, 430
Doublets, 81, 113, 116, 151-155, 301, 430
Doubling, 50, 430; in corundum 50; in synthetic rutile 50; 145; in tourmaline 50; in zircon 50; 98, 99
Dumortierite, 244
Duplex refractometer, 26, 29, 30, 33-39

E

Earnest, Robert, 146
Ekanite, 244
Ekanayaki, F. L. D., 244
Emerald, see beryl variety
Emerald filter, see filter
Endoscope test, also see pearls, 167; 169-171
Enstatite, 244; spectra 205
Epidote, 244-245; spectra 205
Erb and Gray Refractometer, 27-29, 34, 35, 39
"Essence d'orient," 177
Euclase, 243; spectra 205
Even fracture, 8
Extinction, 52, 430

F

"Fabulite" (strontium titanate), see synthetic gemstones
False cleavage (parting), 8
"False lapis," 255
Farben, I. G., 138
Faustite, 245, 257, 391

Feldspar group, 240; cleavage, 7, 85
Albite-oligoclase, 240-241
Labrodorite, 4, 241
Microcline, 241
Orthoclase, 4, 246-247; spectrum 196
Fillers in plastic, 161
Filters
Cross-filter technique, 117
Emerald (Chelsea), 112-114
Wratten A, 41
Fingerprint inclusions (also see inclusions), in corundum 89; in garnet 89; in peridot 101; in spinel 137; in YAG 109; in zircon 98-99
Fire, see dispersion
Flame-fusion synthetic corundum, 102-103, 105, 118-120, 121, 122, 125, 126, 128
Flow lines, 158, 159
Fluorescence,
Table, 426-428
Ultraviolet, 114-116, 430; in assembled stones 154; in corundum 127, 128, 132; in emerald 140-144; in pearls 177; in spinel 138
X-ray, in pearls, 167, 176
Fluorite, 247; spectra 205
Flux-fusion process, corundum 130-132; emerald 138
Flux-grown synthetic ruby, 104, 105
Flux inclusions, see inclusions
Flux-melt process, 140, 142-143
Focusing microscopes, 76-77
Foilbacks, 121, 151, 152, 156, 157, 368
Fracture, definition 8, 430; in identification 84, 85; types 8

G

Gadolinium gallium garnet (see GGG)
Gahnite, also see spinel, spectra 205
Gahnspinel, see spinel and gahnite
Gamma index, 60
Gamma ray irradiation, 275, 333
Garnet group, see also synthetic garnet
Garnet group, 4, 54, 247-250; characteristic inclusions 91-94
Almandite, 248; inclusions 91, 92;

Index

- spectra, 186, 190
Andradite, 248; demantoid 113;
inclusions 92, 93; *Frontispiece*,
spectra 186, 192, 193
Grossularite, 248-249; green 310,
311; hessonite spectrum 195; in-
clusions 92; spectra 194, 195,
206, 210
Pyrope, 250; inclusions 94; spec-
tra 187, 197
Rhodolite 250; spectra 190
Spessartite, 250, spectra 199
Gem Detector, 73
Gemeter, 32
Gemolite, 51, 70-72, 226, 430
Gemological Institute of America,
433-438
Gem Refractometer 26, 29, 34-37
Gems & Gemology, 35, 128, 174
Gemstones, Descriptions and Prop-
erty Variations of, 228-281
Gemstones, characteristic inclusions
85-102; classification 3, 4; clean-
ing for testing 74; nature of 3-6;
see also synthetic gemstones
Gem Trade Laboratory, Preface, 178
General Electric, 131, 146, 299, 361
GGG (gadolinium gallium garnet),
118, 357, 364, 365
GIA Dichroscope, 57
GIA Spectroscope Unit, 182, 183,
226
GIA Thermal Reaction Tester, 217,
377
GIA Utility Lamps, 40
Gilson, Pierre, 146, 147, 377
Gilson synthetic emerald, 116, 140-
141, 142; Type III 315
Glass, 4, 54, 109, 113, 156, 160, 400
Glossary, 429-432
Gold, 14, 134
Gold chloride, see color agents
Golden beryl, 331; also see beryl
Golden coral, 394, 398
Goldstone (glass), 400
Graphite, 5
Gray, nontransparent gemstones,
identification of, 401-410, 417
Green gemstones, identification of,
nontransparent, 382-392, 413
transparent, 305-322, 413
Grossularite garnet, see garnet group
Group, definition 3, 4
Growth lines, see also inclusions, in
corundum, 89, 125
Gubelin, Dr. Edward J., Preface,
246
- ## H
- Habit, 430
Hambergite, 250-251
Hardness, definition 8, 430; Mohs
scale 9; points and plates 227,
430; table 12, 425; testing pro-
cedure, 9, 10
Haynes, John, 242
Heat-wave effect, see also inclusions,
92, 93
Heavy liquids, 19-22
Hematite, 161, 220, 251; fracture 8,
84
Hemetine, 161, 220, 251; fracture 8
Hessonite garnet, see garnet group
(grossularite)
Hexagonal crystal system, 4, 47, 430
Hiddenite, 272; also see spodumene
Holmes, Dr. Ralph J., Preface
Horse-tail inclusions, see inclusions
Hot-point test, 217-219
Howlite, 220
Hydrochloric acid, 219-220
Hydrogrossularite garnet, see garnet
group (grossularite)
Hydrostatic, formula 16; principal
14; tolerances 17
Hydrothermal corundum, 130-132
Hydrothermal synthetic emerald, see
Linde synthetic emerald
Hypersthene, 251
Hyriopsis schlegeli, 165
- ## I
- Identification, 5, 6
ancillary tests, 211-221
characteristic imperfections, cleav-
age 85; fracture 84-85
characteristic inclusions, natural
85-102; synthetic 102-111
hardness 8-10
instruments for testing, 222-227
magnification techniques, 66-82
pearl testing, 167-177
primary test, 6
procedures for, 282-286
specific gravity, 13-22
synthetics, see synthetic gemstones

HANDBOOK OF GEM IDENTIFICATION

- testing for spectrum, 181-182
- Identification and separation by color.
- Nontransparent
- green, 382-392, 413
 - red, orange, yellow, and brown, 393-400, 414-415
 - violet and blue, 373-381, 417
 - white, gray and black, 401-410, 416-417
- Transparent
- blue, 296-304, 412-413
 - brown and orange, 335-344, 414-415
 - colorless, 357-367, 416
 - green, 305-322, 413
 - pink and red, 345-356, 415
 - purple and violet, 287-295, 412
 - yellow, 328-334, 414
- Idocrase, 252; spectra 208
- Illumination, dark-field, 67; definition 66; imperfection resolution 84
- Illuminator Polariscopes, 33, 51, 52
- Immersion
- adaptations for magnification and key determinations, 79-82, 126
 - refractive index liquids, 41, 44
 - specific gravity liquids, 19-22
- Immersion Cell, 80-81
- Imitation gemstones, 156-161, 177-178, 217
- Imperfections, characteristic, 83-111, 430
- cleavage, 85
 - fracture, 84-85
 - inclusions in natural gemstones, 85-102
- Inclusions in synthetic gemstones, 102-111
- Incidence, angle of, 23
- Inclusions, 6, 84, 430; distinguishing dust from inclusions 77-79; characteristic in natural stones 85-102; characteristic in synthetic stones 102-111
- Bubbles, spherical, 104-109, 122, 135, 137, 138, 145, 146, 158, 159, 160
 - Color banding, 89, 99, 106, 126, 127, 135
 - Fingerprint, 89, 98-99, 101, 109, 125, 137
 - Flux, 106, 132, 139
 - Growth lines, 89, 125
 - Heat-wave effect, 92
 - Horsetail, 93; *Frontispiece*
 - Phenakite, 139-140, 141
 - Platinum, 139, 142
 - Repeated twinning, 89, 90, 127, 130
 - Rutile crystal, 87, 88, 89, 121, 123
 - Silk (needlelike) 86-88, 91-92, 101, 104, 123, 432
 - Spinel octahedra, 88, 97, 124, 137
 - Striae, curved, 82, 104-106, 108, 125, 126, 127, 135
 - Three-phase 94-95, 107, 142
 - Veillike (wisplike), 104-107; 131, 139, 143
 - Zircon crystal, 88, 89, 123
- “Indestructible” pearls, 178, also see pearls
- Index, alpha, beta (intermediate) and gamma, 60
- Indian emerald, 96, 143, also see beryl (emerald)
- Inorganic, 430
- Instruments Essential for Gem Testing, 222-227
- Interference, 430; colors 64, 65; optic figure 63-65
- Intermediate (beta) index, 60, 61
- Introduction, 1, 2
- Iolite, 252; spectra 208
- Iridescence, 430
- Iris agate, see chalcedony
- Iron oxide, see color agents
- Isometric (cubic) crystal system, 4, 46, 430
- Isotropic, see single refraction

J

- Jade, 4; identification and separation 382-392
- Jadeite jade, 113, 252-253; ancillary test 214-215; spectra 187, 195, 196, 212, 384, 385
 - Nephrite jade, 253-254; spectrum 196
- Jadeite, see Jade
- Jasper, chalcedony, see chalcedony
- Jet, 3, 219, 254
- Jeweler's Eye, 32
- Johnson, G. M., 30
- Jolly balance, 19

Index

K

- Kashan synthetics, 104, 120, 128, 131, 132
- Kauri Gum, 235
- Kornerupine, 255; spectra 208, 209
- Kraus, Edward H., Forword
- KTN (niobium doped potassium tantalate), 118, 416
- Kunz, George Frederick, 272
- Kunzite, 272; also see spodumene
- Kyanite, 255, spectra 209

L

- Labradorite, 4, 246
- Lake Biwa, 165, 172, 175, 178
- Lapis-lazuli, 3, 116, 220, 255-256; imitation 136; Swiss 380
- Lazulite, 255
- Lazurite, see lapis-lazuli
- Lechleitner, Johann, 140
- Lechleitner synthetic emerald, 108, 140, 143-144
- Lenses, triplets, 67
- Leucite, 256
- Light,
 - monochromatic, 26; R.I. readings 40
 - plane polarized, definition, 46
 - sources, 33, 39-41, 227
 - ultraviolet, 114-117, 128
 - white, R.I. readings, 39; visible spectrum 185
- Linde Company, 119, 121, 140
- Linde hydrothermal synthetic emerald, 140, 144
- Linobate (lithium metaniobate), 118, 372, 416
- Liquid inclusion, 430
- Liquids, contact 31; immersion 79-82; refractive index 41, 44; specific gravity 19-22
- Lithium metaniobate ("Linobate"), 118, 367, 416
- Loupes, 67-68, 74, 75
- Lucite, see plastic
- Luster, 282-283, 430

M

- Magnetism, 220-221

- Magnification, 66-82; distinction between dust and inclusions 77-79; double refraction (doubling) 49; examination procedures 74-82; immersion and key determinations 79-82; instrumentation 66-73, 224, 226

- Magnifiers, 224
- Malachite, 256-257
- Manganese oxide, see color agents
- Marcasite, 257
- Margaritifera*, 164
- Maw-sit-sit, 388
- Meleagrina*, 164
- Mercury vapor lamp, 40, 41
- Metajade, 391-392
- Metamict, 98, 431
- Methylene iodide, 20, 21, 31, 41, 126, 431
- "Mexican jade," 233
- Microcline feldspar, 246
- Microscope, 68-73, 225-227; examination techniques 75-79; R.I. 44, 45
- Mineral, 3-5, 431; see amorphous, see crystalline
- Mineralight, 115
- Mineraloid, definition 3
- Mohs scale, 9, 431
- Moldavite, 258
- Monobromobenzene, 44
- Monobromonaphthalene, 44
- Monochromatic light, 26, 431; R.I. 39, 40; source 227, 431
- Monoclinic crystal system, 4, 48, 431
- Monoiodobenzene, 44
- Monoiodonaphthalene, 44
- Moonstone, chalcedony, see chalcedony
- Moonstone, feldspar, see feldspar (orthoclase)
- Moonstone imitation, 134, 136
- Moore, K. M., 30
- Moore Sphere, 64, 65
- Morganite, beryl, 293-294; see also beryl
- Moss agate chalcedony, see chalcedony

N

- Nacre, definition 163
- Nacreless pearls, 165-166; also see

HANDBOOK OF GEM IDENTIFICATION

pearls
Nassau, Kurt, 108
National Lead Company, 145
Natural pearls, 163-164; 167; also
see pearls
Needlelike (silk) inclusions, also see
inclusions; in corundum 85, 86-
88; in garnet 91-92; in quartz
101
Negative crystals, 100
Neodymium (rare earths), see color
agents
Nephrite, see Jade
Nitric acid, 220
Nitrogen, see color agents
Normal, 23, 24

O

Obsidian, 258
Odontolite, 258-259
Oligoclase feldspar, see albite-oligo-
clase
"Olivine," 261
Onyx, chalcedony, see chalcedony
Oolitic opal, 260
Opal, 3, 4, 54; description and vari-
eties 259-260, opal, plastic imi-
tation 161; opal, plastic impreg-
nated 216; treated 215-216, 260;
see also synthetic gemstones
Opaque, 431
Optic,
axis, 47-49, 431
character, 59-65
interference figure, 63-65
sign, 60, 61, 65
Orange gemstones, identification of,
nontransparent, 393-400, 415
transparent, 335-344, 414
Organic, 431
Orient, 431
Orthoclase feldspar, 4, 246-247;
spectrum 196
Orthorhombic crystal system, 4, 48,
431

P

"Pagoda stone," 377
Pain, A. C. D., 260
Painite, 260

Parting (false cleavage), 8
Paste, 431
Payne, C. J., 27, 112, 168, 318
Pearls, 3, 168-178; conch 166; cul-
tured 165; dyed 220; imitations
177-178; nacreless 165-166; nat-
ural 163-164; pearl tests 167-
177; spectra 177, 196, 197; *Tri-
dacna* 167
Penfield balance, 19
Peridot, 261; inclusions 101; spectra
187, 197
Petalite, 261
Phenakite, 262
Phenakite inclusions, see inclusions
Phenomena, adularescence 134; as-
terism 284, 429; chatoyancy
284-285, 429; iridescence 430;
orient 431
Phosphorescence, 114-115, 128
Pinctada, 164; *P. martensii* 165
Pink gemstones, identification of,
nontransparent, 393-400
transparent, 346-356, 415
"Pink pearls," 166
Plane polarized light, definition 46
Plasma chalcedony, see chalcedony
Plastic, 54, 161-162, 431
Plastic impregnated opal, 216
Platinum inclusions, see inclusions
Plato, Dr. W., 128, 129, 339, 366
Plato Method, 82, 128, 129
Pleochroism, 56-59, 284, 431; table
418-419
Plexiglas, see plastic
Polariscope, 51-56, 223, 286, 431;
detecting pleochroism 58, 59;
optic character 62-65
Polarized light, plane, definition 46,
431
Polaroid, 431
Pollucite, 261
Polystyrene, see plastic
Pough, Dr. F. H., 233
Prase chalcedony, see chalcedony
Praseodymium (rare earths), see
color agents
Precious Stone Laboratory, 27
Prehnite, 262
Premier, 116
Procedure for the Identification of
Gemstones and Their Substi-
tutes, 282-286
Property Tables, see tables

Index

Property Variations of Gemstones,
Descriptions and, 228-281
Purple transparent gemstones, identification of, 287-295, 412
Pyrite, 3, 262
Pyrope garnet, see garnet group

Q

Quartz, see also synthetic gemstones
Quartz, 13, 262-267; crystalline varieties 263-264; inclusions 100-101; spectra 197
Quartz wedge, 65

R

Radiograph, 431
Radiographic method, 165, 167, 174-176; see also pearls
Rare-earth elements, see color agents
Rayner Dialdex refractometer, 26, 27, 28
Rayner Refractometer, 26, 27, 28, 39
Reconstructed, ruby, 108, 431; turquoise, 376
Re-dex, 32
Red gemstones, identification of, nontransparent, 393-400, 415 transparent, 345-356, 415
Red-ring test, doublets, 153, 285
Reflection, 432
angle of, 23
law of, 23
test for double refraction, 51
total, 25
Reflectivity meter, 30-31, 432
Refraction, 23-25, 432
angle of incidence, 23
angle of reflection, 23
anomalous double, 53, 54, 55, 133, 135, 136, 159
critical angle, 25
double (anisotropic), 5, 35, 46-56
normal, 23, 24
single (isotropic), 5, 46, 49
total reflection, 25
Refractive index, 23-45
alpha, beta, gama, 60, 61
definition, 23, 24, 25, 432
determination, by immersion 41, 44; by microscope 44, 45; by refractometer 31-41, 222-223

spot method, 35-39
table 42-43, 421
Refractometer, 25-41, 222-223, 285, 432; cleaning 41; contact liquid 31; double refraction 48; light sources 26, 33, 39, 40-41; optic character 60-63; types 27-30
Repeated twinning, 55, 89, 90, 127, 130, see also inclusions
Rhodizite, 267
Rhodochrosite, 267; spectra 209
Rhodolite garnet, see garnet group
Rhodonite, 267; spectra 209
Rock, definition 3
Rock crystal quartz, 263-264
Rose quartz, 263-264
Rubellite, see tourmaline
Ruby, see corundum
Rutile, also see synthetic rutile, 87-89, 268
Rutile crystal inclusions, see inclusions

S

Sandawana emerald, 95, 96; also see beryl (emerald)
Sapphire, see corundum
Sard, chalcedony, see chalcedony
Saussurite, 253, 281, 390
Scapolite, 232, 268
Scheelite, 268
Schorl, tourmaline, see tourmaline
Selective absorption, see absorption
Serpentine, 268-269; spectra 196, 207, 269
Shipley, Robert M., Foreward, Preface, 151, 433
Shipley, Robert M., Jr., Preface, 51, 61
Sign, optic, 60, 61, 65
Silicon carbide, hardness 9; see hardness table, 12, 425
Silk (needlelike) inclusions, see also inclusions; in corundum 86-88; in garnet 91-92; in quartz 101
Sillimanite, 269
Silver nitrate, 176-177
Silver oxide (or chloride), see color agents
Single-mirror methods, 170; also see pearls
Single refraction (isotropic), 5, 46, 49

HANDBOOK OF GEM IDENTIFICATION

- Sinhalite, 269-270; spectra 210
 Smithsonite, 270
 Smoked opal, 280, 409
 Smoky quartz, 263-264
 Sodalite, 270, 304; spectra 210
 South African jade, 249, 385
 Species, definition 4
 Specific gravity, 13-22, 432
 balances, Berman 17, 19; Jolly 19;
 Penfield 19; Westphal 19
 carbon tetrachloride, 16, 17
 diamond balance adaptation, 14-17,
 15
 hydrostatic, formula 16; principal
 14; tolerances 17
 liquids, 19-22
 table, 18-19, 423-424
 value in identification, 13, 225
 Spectra, see absorption spectra
 Spectroscope, 179-210, 224-227, 432;
 agents causing absorption 183-
 184; gem testing 181-182; spec-
 tra 190-210; types 180-181
 Spectrum, 432; see also absorption
 spectrum
 Spessarite garnet, see garnet group
 Sphalerite, 270-271; spectra 210
 Sphene, 271
 Spherical aberration, 67
 Spherical bubbles, see inclusions
 Spinel, see also synthetic spinel, 4,
 5, 34, 114, 271-272; inclusions
 97; natural vs synthetic 82, 133,
 135-138; spectra 188, 199-201
 Spinel octahedra (included), see also
 inclusions; in corundum 88; in
 spinel 97, 137
 Splintery fracture, 8
 Spodumene, 272; cleavage 7, 85;
 spectra 201
 Spot method, 35-39, 36, 38
 Staurolite, 272-273
 Stibiotantalite, 273
 Stichtite, 273
 Striae, curved, see inclusions
 Strain, 53
 Strontium titanate, see synthetic
 gemstones
 "Styrian jade," 253
 Sugar-treated opal, 259, 260
 Sulphur, RI liquid, 31
 Sunstone feldspar, see albite-oligo-
 clase
 Surface tension, 16, 17, 21
 "Swiss lapis," 380
 Switzer, Dr. George, Preface
 "Synthetic alexandrite," 235
 Synthetic gemstones, 6, 118-148, 432;
 characteristic inclusions 102-111
 alexandrite 111, 235, 287, 291,
 292, 306; flux-grown, 111; Czo-
 chralski, 111
 corundum, 82, 102-104, 105, 108,
 116, 118-132, 328; ruby spectra
 187, 192
 cubic zirconia 149, 357
 diamond, 146
 emerald, 21, 106-108, 109, 113,
 116, 138-144; spectra 141, 186,
 194; see also Chatham, Linde,
 Lechleitner, Gilson
 garnet (YAG) (YIG), 108-109, 110,
 144-145; spectrum, 209
 glass, 4, 54, 109
 opal, 146-147, 260, 408-409
 quartz, 110, 148, 331, 333
 rutile, 50, 109-111, 145, 268;
 spectra 145, 198
 sapphire spectra 198, 199; star
 corundum 120-121
 scheelite, 268
 spinel, 54, 105-106, 114, 133-138;
 spectra 136, 188, 199-201
 strontium titanate, 111, 145-146,
 361
 synthetic star corundum, 121
 turquoise, 110-111, 147-148, 377,
 379
- ### T
- Taaffeite, 273
 Tables, property, 412-428
 birefringence 47, 422
 cleavage and parting, 417
 color, 412-417
 dispersion, 422
 fluorescence, 426-428
 hardness, 12, 425
 pleochroism, 418-419
 refractive index, 42-43, 420-421
 specific gravity, 18-19, 423-424
 Talc, 273-274
 Tanzanite, zoisite, see zoisite
 Tetragonal crystal system, 4, 47, 432
 Testing procedures, see identification
 Tetraiodaethylene, 31
 Thermal Reaction Tester, 217
 Thomsonite, 274

Index

Three-phase inclusions, 94-95, 107, 142; see also inclusions
Thulite, 281; spectra 210; see also zoisite
Tiger-eye quartz, 264
"Titangem," see synthetic rutile
"Titania," see synthetic rutile
Titanite, 271
Titanium oxide, see color agents
Tolerance, hydrostatic S.G., 17
Topaz, 4, 274-275; cleavage 7, 85; gamma ray irradiation 270; inclusions 97-98; spectra 201
"Topaz" quartz, 263-264
Tortoise shell, 219
Total reflection, 24, 25
Tourmaline, 34, 50, 113, 275-176; inclusions 91; spectra 188, 202
Translucent, 432
Transparency, 432
 to ultraviolet, 116-117, 142-143
 to x-ray, 174-176
Transvaal jade, 249, 380
Trichroism, 56, 58
Triclinic crystal system, 4, 48, 432
Tridacna gigas, 167½
Tridacna pearls, 166, 167; also see pearls
Trigons, 102, 103
Triplets,
 gemstones, 81, 113, 116, 151-155
 lenses, 67
Tsavorite, 249
Turquoise, see also synthetic gem-
 227; transparency 116-117, 142-
 143
Twinning, repeated, 55, 89, 90, 127,
 130

U

Ultraviolet, 114-117, 128, 432; fluor-
 escence, see fluorescence; lamps
 222; transparency 116-117, 142-
 143
Uneven fracture, 8
Uniaxial, 47, 59, 60, 432
Uralian emerald, 4, also see beryl
 (emerald)
Uranium, see color agents
Utahlite, 277-278
Utility lamp, GIA, 40

V

Variety, definition 4
Variscite, 277-278, spectra 208
Veillike (wisplike) inclusions, see
 inclusions
Verneuil process, 108; corundum
 118, 119; spinel 134; rutile 145;
 strontium titanate 145
Vernier millimeter scale, 45
Violane, 243
Violet gemstones, identification of,
 nontransparent, 373-381, 412
 transparent 287-295, 412
Visible (light) spectrum, 185
Vitreous luster, 157, 160

W

Westphal balance, 19
White, nontransparent gemstones,
 identification of, 401-410, 416
White light, R.I. Readings, 39
Willemite, 278; spectra 210
Wisplike (veillike) inclusions, see in-
 clusions
Wratten A filter, 41, 285

X

X-ray, 128
X-ray methods, also see pearls
 diffraction, 167, 172-174
 fluorescence, 167, 176
 radiography, 165, 167, 174-176

Y

YAG 108-109, 110, 144-145, 295,
 305-307, 309, 357, 364, 369
Yellow gemstones, identification of,
 nontransparent, 393-400, 414
 transparent, 323-331, 414
YIG (synthetic garnet), 108, 144-145

Z

Zincite, 278
Zircon, high, medium, low, 4, 113,
 279-280; doubling 50, 98; frac-

HANDBOOK OF GEM IDENTIFICATION

ture 85; inclusions 98-99; spectra *188-203*; metamict 98

Zircon crystals, included, in corundum 88, 123, *124*; in garnet, 89; also see inclusions

Zoisite, 280-281; spectra *208, 209, 210*

